

Part number scheme S400

Use for product identification only, not for the order process.

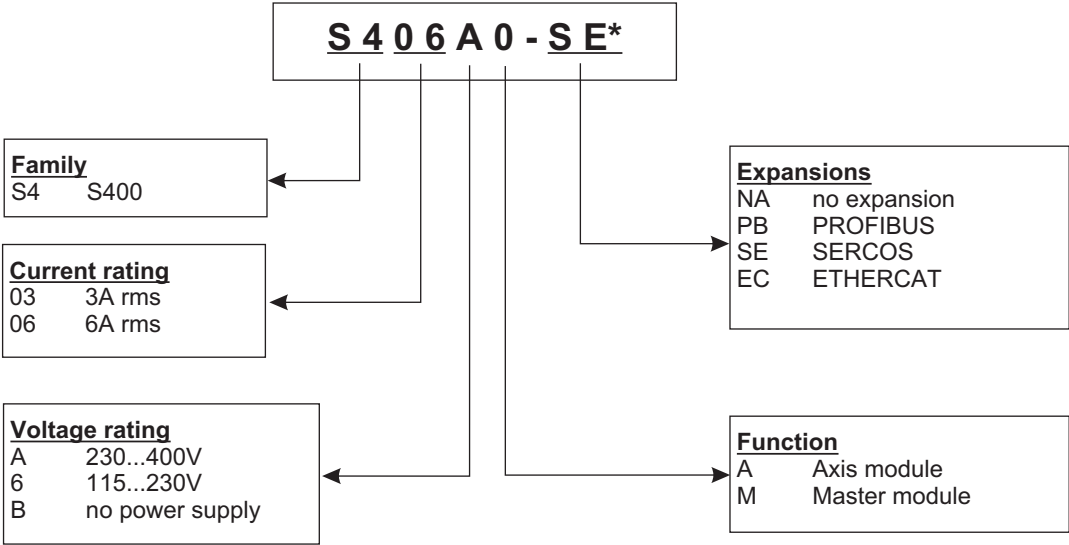

* additional coding defines customer specific specials.