

Kollmorgen Automation Suite

KAS Reference Manual – Motion Library



Document Edition: U, December 2021

Valid for KAS Software Revision 3.07

Part Number: 959716



For safe and proper use, follow these instructions. Keep for future use.

Trademarks and Copyrights

Copyrights

Copyright © 2009-2021 Kollmorgen

Information in this document is subject to change without notice. The software package described in this document is furnished under a license agreement. The software package may be used or copied only in accordance with the terms of the license agreement.

This document is the intellectual property of Kollmorgen and contains proprietary and confidential information. The reproduction, modification, translation or disclosure to third parties of this document (in whole or in part) is strictly prohibited without the prior written permission of Kollmorgen.

Trademarks

- KAS and AKD are registered trademarks of [Kollmorgen](#).
- [Kollmorgen](#) is part of the [Altra Industrial Motion](#) Company.
- EnDat is a registered trademark of Dr. Johannes Heidenhain GmbH
- EtherCAT is a registered trademark and patented technology, licensed by Beckhoff Automation GmbH
- Ethernet/IP is a registered trademark of ODVA, Inc.
- Ethernet/IP Communication Stack: copyright (c) 2009, Rockwell Automation
- HIPERFACE is a registered trademark of Max Stegmann GmbH
- PROFINET is a registered trademark of PROFIBUS and PROFINET International (PI)
- SIMATIC is a registered trademark of SIEMENS AG
- Windows is a registered trademark of Microsoft Corporation
- [PLCopen](#) is an independent association providing efficiency in industrial automation.
- Codemeter is a registered trademark of [WIBU-Systems AG](#).
- SyCon® is a registered trademark of [Hilscher GmbH](#).

Kollmorgen Automation Suite is based on the work of:

- [7-zip](#) (distributed under the terms of the LGPL and the BSD 3-clause licenses - [see terms](#))
- The [C++ Mathematical Expression Library](#) (distributed under [the MIT License](#))
- [curl](#) software library
- [JsonCpp](#) software (distributed under the MIT License - [see terms](#))
- [Mongoose](#) software (distributed under the MIT License - [see terms](#))
- [Qt](#) cross-platform SDK (distributed under the terms of the LGPL3; Qt source is available on KDN)
- [Qwt](#) project (distributed under the terms of the [Qwt License](#))
- [U-Boot](#), a universal boot loader is used by the AKD PDMM and PCMM (distributed under the [terms](#) of the GNU General Public License). The U-Boot source files, copyright notice, and readme are available on the distribution disk that is included with the AKD PDMM and PCMM.
- [Zlib](#) software library

All other product and brand names listed in this document may be trademarks or registered trademarks of their respective owners.

Disclaimer

The information in this document (Version U published on 11/30/2021) is believed to be accurate and reliable at the time of its release. Notwithstanding the foregoing, Kollmorgen assumes no responsibility for any damage or loss resulting from the use of this help, and expressly disclaims any liability or damages for loss of data, loss of use, and property damage of any kind, direct, incidental or consequential, in regard to or arising out of the performance or form of the materials presented herein or in any software programs that accompany this document.

All timing diagrams, whether produced by Kollmorgen or included by courtesy of the PLCopen organization, are provided with accuracy on a best-effort basis with no warranty, explicit or implied, by Kollmorgen. The user releases Kollmorgen from any liability arising out of the use of these timing diagrams.

1 Table of Contents

1 Table of Contents	3
2 Motion Library	20
2.1 Motion Library - Pipe Network	20
2.1.1 Motion Library - Pipe Network	20
2.1.1.1 MLPipeAct	20
2.1.1.2 MLPipeAddBlock	22
2.1.1.3 MLPipeCreate	24
2.1.1.4 MLPipeDeact	25
2.1.2 iMotion Library - Block	26
2.1.2.1 MLBlkCreate	26
2.1.2.2 MLBlkReadOutVal	28
2.1.2.3 MLBlkReadModPos	30
2.1.2.4 MLBlkIsReady	31
2.1.2.5 MLBlkWriteModPos	32
2.1.3 idMotion Library - Adder	34
2.1.3.1 MLAddInit	34
2.1.3.2 MLAddReadOff1	37
2.1.3.3 MLAddReadOff2	38
2.1.3.4 MLAddReadRatio1	39
2.1.3.5 MLAddReadRatio2	41
2.1.3.6 MLAddWriteInput	43
2.1.3.7 MLAddWriteOff1	45
2.1.3.8 MLAddWriteOff2	47
2.1.3.9 MLAddWriteRat1	48
2.1.3.10 MLAddWriteRat2	50
2.1.4 Motion Library - Axis	51
2.1.4.1 MLAxisAbs	53
2.1.4.2 Position with Modulo On	54
2.1.4.3 Forcing the direction of rotation	55
2.1.4.4 Travel Speed Update with MLAxisAbs	55
2.1.4.5 MLAxisAdd	57
2.1.4.6 MLAxisAddress	58
2.1.4.7 MLAxisAddTq	60
2.1.4.8 MLAxisCfgFastIn	61
2.1.4.9 MLAxisCmdPos	62
2.1.4.10 MLAxisDriveNumber	63
2.1.4.11 MLAxisFBackPos	65
2.1.4.12 MLAxisGenEN	66
2.1.4.13 MLAxisGenIsEN	67
2.1.4.14 MLAxisGenIsRdy	68
2.1.4.15 MLAxisGenPos	69
2.1.4.16 MLAxisGenReadAcc	70
2.1.4.17 MLAxisGenReadDec	72
2.1.4.18 MLAxisGenReadSpd	73
2.1.4.19 MLAxisGenWriteAcc	74

2.1.4.20	MLAxisGenWriteDec	75
2.1.4.21	MLAxisGenWriteSpd	76
2.1.4.22	MLAxisInit	77
2.1.4.23	MLAxisIsCnctd	80
2.1.4.24	MLAxisIsTrigged	81
2.1.4.25	MLAxisMoveVel	82
2.1.4.26	MLAxisPipePos	83
2.1.4.27	MLAxisPower	84
2.1.4.28	MLAxisPowerDOff	86
2.1.4.29	MLAxisRatedTq	86
2.1.4.30	MLAxisReadActPos	88
2.1.4.31	MLAxisReadFBUnit	89
2.1.4.32	MLAxisReadFEUU	90
2.1.4.33	MLAxisReadGenStatus	91
2.1.4.34	MLAxisReadModPos	92
2.1.4.35	MLAxisReadTq	93
2.1.4.36	MLAxisReadUUnits	94
2.1.4.37	MLAxisReadVel	95
2.1.4.38	MLAxisReAlgnRdy	96
2.1.4.39	MLAxisReAlign	97
2.1.4.40	MLAxisRel	99
2.1.4.41	MLAxisResetErrors	100
2.1.4.42	MLAxisRstFastIn	101
2.1.4.43	MLAxisStatus	102
2.1.4.44	MLAxisStop	105
2.1.4.45	MLAxisTimeStamp	107
2.1.4.46	MLAxisWriteModPos	109
2.1.4.47	MLAxisWritePipPos	110
2.1.4.48	MLAxisWritePos	111
2.1.4.49	MLAxisWriteUUnits	113
2.1.4.50	MLPNAxisCreate	114
2.1.4.51	Usage Example of Axis Functions	116
2.1.5	Motion Library - Cam Profile	117
2.1.5.1	MLCamInit	118
2.1.5.2	MLCamSwitch	119
2.1.5.3	MLPrfReadIOffset	121
2.1.5.4	MLPrfReadIScale	122
2.1.5.5	MLPrfReadOOffset	123
2.1.5.6	MLPrfReadOScale	125
2.1.5.7	MLPrfWriteIOffset	126
2.1.5.8	MLPrfWriteIScale	127
2.1.5.9	MLPrfWriteOOffset	129
2.1.5.10	MLPrfWriteOScale	130
2.1.6	Motion Library - Comparator	132
2.1.6.1	MLCompCheck	132
2.1.6.2	MLCompInit	134
2.1.6.3	MLCompReadRef	136

2.1.6.4	MLCompReset	137
2.1.6.5	MLCompWriteRef	138
2.1.6.6	Usage example of Comparator Functions	140
2.1.7	Motion Library - Convertor	142
2.1.7.1	MLCNVConECAT	142
2.1.7.2	MLCNVConnect	144
2.1.7.3	MLCNVConnectEx	145
2.1.7.4	MLCNVDisconnect	148
2.1.7.5	MLCNVInit	149
2.1.8	Motion Library - Delay	150
2.1.8.1	MLDelayInit	150
2.1.9	Motion Library - Derivator	151
2.1.9.1	MLDerInit	152
2.1.9.2	MLDerReadInModPos	153
2.1.9.3	MLDerWriteInModPos	155
2.1.10	Motion Library - Gear	157
2.1.10.1	Usage example of Gear Functions	157
2.1.10.2	MLGearInit	159
2.1.10.3	MLGearReadOffset	163
2.1.10.4	MLGearReadOffSlp	164
2.1.10.5	MLGearReadRatio	164
2.1.10.6	MLGearReadRatSlp	165
2.1.10.7	MLGearWriteOff	166
2.1.10.8	MLGearWriteOSlp	168
2.1.10.9	MLGearWriteRatio	169
2.1.10.10	MLGearWriteRatSlp	170
2.1.11	ssMotion Library - Integrator	172
2.1.11.1	MLIntInit	173
2.1.11.2	MLIntWriteOutVal	174
2.1.12	Motion Library - Master	176
2.1.12.1	Usage example of Master Functions	177
2.1.12.2	MLMstAbs	177
2.1.12.3	Position with Modulo On	178
2.1.12.4	Forcing the direction of rotation	178
2.1.12.5	Travel Speed Update with MLAxisAbs	179
2.1.12.6	MLMstAdd	181
2.1.12.7	MLMstForcePos	183
2.1.12.8	MLMstInit	184
2.1.12.9	MLMstReadAccel	187
2.1.12.10	Function Block Diagram	188
2.1.12.11	MLMstReadDecel	188
2.1.12.12	MLMstReadInitPos	189
2.1.12.13	MLMstReadSpeed	191
2.1.12.14	MLMstRel	192
2.1.12.15	MLMstRun	193
2.1.12.16	MLMstStatus	194
2.1.12.17	MLMstWriteAccel	196

2.1.12.18	MLMstWriteDecel	197
2.1.12.19	MLMstWriteInitPos	199
2.1.12.20	MLMstWriteSpeed	200
2.1.13	Motion Library - Phaser	201
2.1.13.1	Usage example of Phaser Functions	202
2.1.13.2	MLPhaInit	202
2.1.13.3	MLPhaReadActPhase	205
2.1.13.4	MLPhaReadPhase	205
2.1.13.5	MLPhaReadSlope	206
2.1.13.6	MLPhaWritePhase	207
2.1.13.7	MLPhaWriteSlope	208
2.1.14	Motion Library - PMP	210
2.1.14.1	MLPmpAbs	210
2.1.14.2	MLPmpForcePos	211
2.1.14.3	MLPmpInit	213
2.1.14.4	MLPmpReadAccel	216
2.1.14.5	MLPmpReadFstSpd	217
2.1.14.6	MLPmpReadInitPos	218
2.1.14.7	MLPmpReadJerk	219
2.1.14.8	MLPmpReadLstSpd	219
2.1.14.9	MLPmpRel	220
2.1.14.10	MLPmpRun	222
2.1.14.11	MLPmpStatus	224
2.1.14.12	MLPmpWriteAccel	225
2.1.14.13	MLPmpWriteFstSpd	226
2.1.14.14	MLPmpWriteJerk	227
2.1.14.15	MLPmpWriteLstSpd	229
2.1.15	Motion Library - Sampler	230
2.1.15.1	MLSmpConECAT	230
2.1.15.2	MLSmpConnect	233
2.1.15.3	MLSmpConPLCAxis	234
2.1.15.4	MLSmpConPNAxis	235
2.1.15.5	MLSmpInit	237
2.1.16	Motion Library - Synchronizer	240
2.1.16.1	Usage Example of Synchronizer Functions	240
2.1.16.2	MLSyncInit	241
2.1.16.3	MLSyncReadDeltaS	243
2.1.16.4	MLSyncStart	245
2.1.16.5	MLSyncStop	246
2.1.16.6	MLSyncWriteDeltaS	247
2.1.17	Motion Library - Trigger	249
2.1.17.1	Usage Example of Trigger Functions	249
2.1.17.2	MLTrigClearFlag	251
2.1.17.3	MLTrigInit	252
2.1.17.4	MLTrigIsTriggered	255
2.1.17.5	MLTrigReadDelay	256
2.1.17.6	MLTrigReadPos	257

2.1.17.7	MLTrigReadTime	259
2.1.17.8	MLTrigSetEdge	261
2.1.17.9	MLTrigWriteDelay	262
2.2	Motion Library - PLCopen	263
2.2.1	Control Functions	265
2.2.1.1	MC_ClearFaults	265
2.2.1.2	MC_CreatePLCAxis	266
2.2.1.3	MC_EStop	270
2.2.1.4	MC_InitAxis	272
2.2.1.5	MC_InitAxisFeedback	274
2.2.1.6	MC_Power	276
2.2.1.7	MC_ErrorDescription	278
2.2.1.8	MC_ResetError	280
2.2.1.9	MC_Stop	281
2.2.2	I/O Functions	284
2.2.2.1	MC_AbortTrigger	284
2.2.2.2	MC_TouchProbe	286
2.2.3	Information Functions	293
2.2.3.1	MC_ReadActPos	293
2.2.3.2	MC_ReadActVel	295
2.2.3.3	MC_ReadAxisErr	297
2.2.3.4	MC_ReadBoolPar	299
2.2.3.5	MC_ReadParam	300
2.2.3.6	MC_ReadStatus	302
2.2.3.7	MC_WriteBoolPar	304
2.2.3.8	MC_WriteParam	306
2.2.4	PLCOpenMotion Functions	308
2.2.4.1	MC_Halt	308
2.2.4.2	MC_MoveAbsolute	311
2.2.4.3	MC_MoveAdditive	316
2.2.4.4	MC_MoveRelative	319
2.2.4.5	MC_MoveSuperimp	324
2.2.4.6	MC_MoveVelocity	328
2.2.4.7	MC_MoveContVel	331
2.2.4.8	MC_SetOverride	335
2.2.5	Profile Functions	337
2.2.5.1	MC_CamIn	337
2.2.5.2	MC_CamOut	345
2.2.5.3	MC_CamResumePos	348
2.2.5.4	MC_CamStartPos	350
2.2.5.5	MC_CamTblSelect	353
2.2.5.6	MC_GearIn	356
2.2.5.7	MC_GearInPos	360
2.2.5.8	MC_GearOut	367
2.2.5.9	MC_Phasing	369
2.2.5.10	MC_SyncSlaves	373
2.2.6	Reference Functions	375

2.2.6.1 MC_Reference	375
2.2.6.2 MC_SetPos	380
2.2.6.3 MC_SetPosition	383
2.2.7 Registration Function Blocks	383
2.2.7.1 MC_MachRegist	383
2.2.7.2 Description	383
2.2.7.3 MC_MarkRegist	390
2.2.7.4 MC_StopRegist	396
2.2.8 Superimposed Axes	398
2.2.8.1 MC_AddSuperAxis	398
2.2.8.2 MC_RemSuperAxis	399
2.3 Motion Library- Common	401
2.3.1 Motion Library - Common - Info	402
2.3.1.1 MC_ErrorDescription	402
2.3.2 Motion Library - Common - Profiles	403
2.3.2.1 MLProfileBuild	403
2.3.2.2 MLProfileCreate	411
2.3.2.3 MLProfileInit	413
2.3.2.4 MLProfileRelease	415
2.3.3 Motion Library	418
2.3.3.1 State Machine	418
2.3.3.2 MLMotionCycleTime	419
2.3.3.3 MLMotionInit	419
2.3.3.4 MLMotionRstErr	421
2.3.3.5 MLMotionStart	422
2.3.3.6 MLMotionStatus	423
2.3.3.7 MLMotionStop	425
2.3.3.8 MLMotionSysTime	426
2.3.4 Coordinated Motion Function Blocks	426
2.3.4.1 Coordinated Motion Group Control Library	429
2.3.5 Related Functions	431
2.3.6 Input	431
2.3.7 Output	432
2.3.8 Structured Text	432
2.3.9 IL	432
2.3.10 FBD	432
2.3.11 Ladder Diagram	432
2.3.12 Related Function Blocks	433
2.3.13 Structured Text	435
2.3.14 Instruction List	435
2.3.15 Function Block Diagram	435
2.3.16 Ladder Diagram	435
2.3.17 Related Functions	436
2.3.18 Input	436
2.3.19 Output	436
2.3.20 ST	437
2.3.21 IL	437

2.3.22 FBD	437
2.3.23 FFLD	437
2.3.24 Related Functions	438
2.3.25 Input	438
2.3.26 Output	438
2.3.27 Structured Text	439
2.3.28 IL	439
2.3.29 FBD	439
2.3.30 FFLD	439
2.3.31 Related Function Blocks	440
2.3.32 Input	440
2.3.33 Output	441
2.3.34 ST	441
2.3.35 IL	441
2.3.36 FBD	441
2.3.37 FFLD	442
2.3.38 Input	442
2.3.39 Output	443
2.3.40 ST	443
2.3.41 FBD	443
2.3.42 FFLD	444
2.3.43 Related Functions	444
2.3.44 Input	444
2.3.45 Output	445
2.3.46 ST	445
2.3.47 FBD	445
2.3.48 IL	445
2.3.49 FFLD	445
2.3.50 Related Functions	446
2.3.51 Input	446
2.3.52 Output	447
2.3.53 Structured Text	448
2.3.54 IL	448
2.3.55 FBD	448
2.3.56 FFLD	448
2.3.57 Related Function Blocks	449
2.3.58 Input	449
2.3.59 Output	450
2.3.60 ST	450
2.3.61 IL	450
2.3.62 FBD	450
2.3.63 FFLD	450
2.3.64 Input	451
2.3.65 Output	452
2.3.66 ST	452
2.3.67 FBD	452
2.3.68 FFLD	453

2.3.69 Related Function Blocks	453
2.3.70 Inputs	453
2.3.71 Outputs	454
2.3.72 Structured Text	455
2.3.73 IL	455
2.3.74 FBD	455
2.3.75 FFLD	455
2.3.76 Related Functions	456
2.3.77 Input	456
2.3.78 Output	457
2.3.79 ST	457
2.3.80 IL	457
2.3.81 FBD	457
2.3.82 FFLD	457
2.3.83 Input	458
2.3.84 Output	459
2.3.85 Structured Text	459
2.3.86 Function Block Diagram	459
2.3.87 Ladder Diagram	460
2.3.88 Related Functions	461
2.3.89 Input	461
2.3.90 Output	461
2.3.91 ST	462
2.3.92 IL	462
2.3.93 FBD	462
2.3.94 FFLD	462
2.3.94.1 Coordinated Motion Info Library	466
2.3.95 Related Functions	467
2.3.96 Input	467
2.3.97 Output	468
2.3.98 Structured Text	468
2.3.99 IL	469
2.3.100 FBD	469
2.3.101 Ladder Diagram	469
2.3.102 Related Functions	470
2.3.103 Input	470
2.3.104 Output	471
2.3.105 Structured Text	471
2.3.106 IL	471
2.3.107 FBD	471
2.3.108 Ladder Diagram	471
2.3.109 Related Functions	472
2.3.110 Input	473
2.3.111 Output	473
2.3.112 Structured Text	474
2.3.113 IL	474
2.3.114 FBD	474

2.3.115 FFLD	474
2.3.116 Related Function Blocks	475
2.3.117 Input	475
2.3.118 Output	476
2.3.119 Structured Text	476
2.3.120 IL	476
2.3.121 FBD	477
2.3.122 FFLD	477
2.3.123 Related Function Blocks	478
2.3.124 Input	478
2.3.125 Output	479
2.3.126 Structured Text	479
2.3.127 IL	479
2.3.128 FBD	479
2.3.129 FFLD	480
2.3.130 Related Functions	480
2.3.131 Input	480
2.3.132 Output	481
2.3.133 Structured Text	481
2.3.134 FBD	481
2.3.135 FFLD	481
2.3.136 Related Functions	482
2.3.137 Structured Text	484
2.3.138 IL	484
2.3.139 FBD	484
2.3.140 FFLD	485
2.3.140.1 Coordinated Motion Motion Library	485
2.3.141 Related Functions	486
2.3.142 Input	486
2.3.143 Output	488
2.3.144 Structured Text	488
2.3.145 Instruction List	488
2.3.146 Function Block Diagram	488
2.3.147 Ladder Diagram	489
2.3.148 Related Functions	489
2.3.149 Input	490
2.3.150 Output	490
2.3.151 Structured Text	491
2.3.152 IL	491
2.3.153 FBD	491
2.3.154 FFLD	491
2.3.155 Related Functions	492
2.3.156 Input	492
2.3.157 Output	492
2.3.158 ST	493
2.3.159 IL	493
2.3.160 FBD	493

2.3.161 FFLD	493
2.3.162 Related Functions	494
2.3.163 Input	494
2.3.164 Output	498
2.3.165 ST	499
2.3.166 IL	499
2.3.167 FBD	499
2.3.168 FFLD	500
2.3.169 Related Functions	501
2.3.170 Input	501
2.3.171 Output	505
2.3.172 ST	505
2.3.173 IL	506
2.3.174 FBD	506
2.3.175 FFLD	506
2.3.176 Related Functions	507
2.3.177 Input	507
2.3.178 Output	508
2.3.179 Structure Text	509
2.3.180 IL	509
2.3.181 Function Block Diagram	509
2.3.182 Ladder Diagram	509
2.3.183 Related Functions	510
2.3.184 Input	510
2.3.185 Output	511
2.3.186 Structure Text	512
2.3.187 IL	512
2.3.188 Function Block Diagram	512
2.3.189 Ladder Diagram	512
2.3.190 Related Functions	513
2.3.191 Input	513
2.3.192 Output	516
2.3.193 Structured Text	517
2.3.194 IL	517
2.3.195 FBD	517
2.3.196 FFLD	517
2.3.197 Related Functions	519
2.3.198 Input	519
2.3.199 Output	522
2.3.200 Structured Text	522
2.3.201 IL	522
2.3.202 FBD	522
2.3.203 FFLD	523
2.3.203.1 Coordinated Motion Reference Library	523
2.3.204 Related Functions	524
2.3.205 Input	524
2.3.206 Output	525

2.3.207 ST	525
2.3.208 FBD	525
2.3.209 IL	526
2.3.210 FFLD	526
3 Fieldbus Library	527
3.1 EtherCAT Library	527
3.1.1 EtherCAT Function Blocks That Work With Drive Parameters	527
3.1.1.1 Execution Time	528
3.1.2 EtherCAT Function Blocks That Work With SDOs	529
3.1.3 DriveParamRead	529
3.1.3.1 Description	529
3.1.3.2 Arguments	530
3.1.3.3 Usage	533
3.1.3.4 Related Functions	533
3.1.3.5 Example	533
3.1.4 DriveParamStrRead	534
3.1.4.1 Description	534
3.1.4.2 Arguments	535
3.1.4.3 Usage	536
3.1.4.4 Related Functions	536
3.1.4.5 Example	536
3.1.5 DriveParamWrite	537
3.1.5.1 Description	537
3.1.5.2 Arguments	537
3.1.5.3 Usage	539
3.1.5.4 Related Functions	539
3.1.5.5 Example	539
3.1.6 ECATCommErrors	539
3.1.6.1 Description	539
3.1.6.2 Arguments	540
3.1.6.3 Related Functions	541
3.1.6.4 Example	541
3.1.7 ECATDeviceAction	542
3.1.7.1 Description	542
3.1.7.2 Arguments	542
3.1.7.3 Usage	544
3.1.7.4 Related Functions	544
3.1.7.5 Examples	544
3.1.8 ECATDeviceStatus	545
3.1.8.1 Description	545
3.1.8.2 Arguments	545
3.1.8.3 Related Functions	547
3.1.8.4 Example	547
3.1.9 ECATDevReadParam	548
3.1.9.1 Description	548
3.1.9.2 Arguments	548
3.1.9.3 Example	550

3.1.10 ECATGetObjVal	551
3.1.11 ECATMasterStatus	552
3.1.11.1 Description	552
3.1.11.2 Arguments	552
3.1.11.3 Related Functions	553
3.1.11.4 Examples	553
3.1.12 ECATReadData	554
3.1.12.1 Description	554
3.1.12.2 Arguments	554
3.1.12.3 Related Functions	555
3.1.12.4 Example	555
3.1.13 ECATReadSDO	556
3.1.13.1 Description	556
3.1.13.2 Arguments	557
3.1.13.3 Related Functions	559
3.1.13.4 Example	559
3.1.14 ECATWCStatus	560
3.1.14.1 Description	560
3.1.14.2 Arguments	560
3.1.14.3 Related Functions	561
3.1.14.4 Example	561
3.1.15 ECATWriteData	561
3.1.15.1 Description	561
3.1.15.2 Arguments	562
3.1.15.3 Related Functions	563
3.1.15.4 Example	563
3.1.16 ECATWriteSDO	563
3.1.16.1 Description	563
3.1.16.2 Arguments	564
3.1.16.3 Related Functions	566
3.1.16.4 Example	567
3.1.17 FSoEParamsInit	567
3.1.17.1 Description	567
3.1.17.2 Arguments	568
3.1.17.3 Examples	570
3.2 EtherNet/IP (ODVA)	571
3.2.1 eipAdapter	571
3.2.1.1 Inputs	571
3.2.1.2 Outputs	571
3.2.1.3 Remarks	571
3.2.1.4 Example	571
3.2.1.5 Related Function Blocks	571
3.2.2 eipReadAttr	572
3.2.2.1 Inputs	572
3.2.2.2 Outputs	572
3.2.2.3 Remarks	572
3.2.2.4 Example	573

3.2.2.5	Related Function Blocks	573
3.2.3	eipWriteAttr	573
3.2.3.1	Inputs	573
3.2.3.2	Outputs	574
3.2.3.3	Remarks	574
3.2.3.4	Example	574
3.2.3.5	Related Function Blocks	575
4	System Library	576
4.1	Controller Functions	576
4.1.1	ClearCtrlErrors	576
4.1.1.1	Arguments	576
4.1.1.2	Input	576
4.1.1.3	Output	576
4.1.1.4	Examples	576
4.1.2	GetCtrlErrors	577
4.1.2.1	Arguments	577
4.1.2.2	Examples	577
4.1.3	GetCtrlInfo	578
4.1.3.1	Arguments	578
4.1.3.2	Examples	580
4.1.4	GetCtrlPerf	580
4.1.4.1	Description	580
4.1.4.2	Arguments	581
4.1.4.3	Example	583
4.2	File Tools Function Blocks	585
4.2.1	FileClose	585
4.2.1.1	Description	585
4.2.1.2	Arguments	585
4.2.1.3	Example	586
4.2.2	FileCopy	586
4.2.2.1	Description	586
4.2.2.2	Arguments	587
4.2.2.3	Example	588
4.2.3	FileDelete	588
4.2.3.1	Description	588
4.2.3.2	Arguments	588
4.2.3.3	Example	589
4.2.4	FileEOF	589
4.2.4.1	Description	589
4.2.4.2	Arguments	590
4.2.4.3	Example	590
4.2.5	FileExists	591
4.2.5.1	Description	591
4.2.5.2	Arguments	591
4.2.5.3	Example	592
4.2.6	FileOpenA	592
4.2.6.1	Description	592

4.2.6.2 Arguments	593
4.2.6.3 Example	593
4.2.7 FileOpenR	594
4.2.7.1 Description	594
4.2.7.2 Arguments	594
4.2.7.3 Example	595
4.2.8 FileOpenW	595
4.2.8.1 Description	595
4.2.8.2 Arguments	596
4.2.8.3 Example	596
4.2.9 FileReadBinData	597
4.2.9.1 Description	597
4.2.9.2 Arguments	597
4.2.9.3 Example	598
4.2.10 FileReadLine	598
4.2.10.1 Description	598
4.2.10.2 Arguments	599
4.2.10.3 Example	600
4.2.11 FileRename	600
4.2.11.1 Description	600
4.2.11.2 Arguments	600
4.2.11.3 Example	601
4.2.12 FileSeek	601
4.2.12.1 Description	601
4.2.12.2 Arguments	602
4.2.12.3 Example	603
4.2.13 FileSize	603
4.2.13.1 Description	603
4.2.13.2 Arguments	604
4.2.13.3 Example	605
4.2.14 FileWriteBinData	605
4.2.14.1 Description	605
4.2.14.2 Arguments	605
4.2.14.3 Example	606
4.2.15 FileWriteLine	607
4.2.15.1 Description	607
4.2.15.2 Arguments	607
4.2.15.3 Example	608
4.3 TCP/IP Function Blocks	609
4.3.1 TcpAccept	609
4.3.1.1 Description	609
4.3.1.2 Arguments	609
4.3.1.3 Example	610
4.3.2 TcpBinReceive	610
4.3.2.1 Description	610
4.3.2.2 Arguments	611
4.3.2.3 Example	612

4.3.3 TcpBinSend	612
4.3.3.1 Description	612
4.3.3.2 Arguments	613
4.3.3.3 Example	614
4.3.4 TcpClose	614
4.3.4.1 Description	614
4.3.4.2 Arguments	615
4.3.4.3 Example	615
4.3.5 TcpConnect	616
4.3.5.1 Description	616
4.3.5.2 Arguments	616
4.3.5.3 Example	617
4.3.6 TcpIsConnected	618
4.3.6.1 Description	618
4.3.6.2 Arguments	618
4.3.6.3 Example	619
4.3.7 TcpIsValid	619
4.3.7.1 Description	619
4.3.7.2 Arguments	619
4.3.7.3 Example	620
4.3.8 TcpListen	620
4.3.8.1 Description	621
4.3.8.2 Arguments	621
4.3.8.3 Example	622
4.3.9 TcpSend	622
4.3.9.1 Description	622
4.3.9.2 Arguments	623
4.3.9.3 Example	624
4.4 UDP Functions for PxMM & Simulator	624
4.4.1 udpAddrMake	625
4.4.1.1 Description	625
4.4.1.2 Arguments	625
4.4.1.3 Examples	627
4.4.2 udpClose	627
4.4.2.1 Description	627
4.4.2.2 Arguments	627
4.4.2.3 Examples	629
4.4.3 udpCreate	629
4.4.3.1 Description	629
4.4.3.2 Arguments	629
4.4.3.3 Examples	631
4.4.4 udpIsValid	631
4.4.4.1 Description	631
4.4.4.2 Arguments	631
4.4.4.3 Examples	632
4.4.5 udpRcvFrom	632
4.4.5.1 Description	632

4.4.5.2 Arguments	632
4.4.5.3 Examples	633
4.4.6 udpRcvFromArray	634
4.4.6.1 Description	634
4.4.6.2 Arguments	634
4.4.6.3 Examples	635
4.4.7 udpRcvFromVar	635
4.4.7.1 Description	635
4.4.7.2 Arguments	636
4.4.7.3 Examples	637
4.4.8 udpSendTo	637
4.4.8.1 Description	637
4.4.8.2 Arguments	637
4.4.8.3 Examples	638
4.4.9 udpSendToArray	639
4.4.9.1 Description	639
4.4.9.2 Arguments	639
4.4.9.3 Examples	640
4.4.10 udpSendToVar	640
4.4.10.1 Description	641
4.4.10.2 Arguments	641
4.4.10.3 Examples	642
4.5 PrintMessage	642
4.5.1 Description	642
4.5.1.1 About the Source	642
4.5.1.2 About the Level	643
4.5.2 Arguments	643
4.5.2.1 Input	643
4.5.2.2 Output	643
4.5.3 Usage	643
4.5.4 Example	644
4.5.4.1 Structured Text	644
4.5.4.2 Function Block Diagram	644
4.5.4.3 FFLD	644
4.6 File and TCP/IP Function Block ErrorID Output	645
5 Kollmorgen UDFBs	646
5.1 How to create an instance	646
5.2 Working with Kollmorgen UDFBs	647
5.2.0.1 FB_FirstOrderDigitalFilter	647
5.2.0.2 FB_PWDutyOutput	652
5.2.0.3 FB_ScaleInput	656
5.2.0.4 FB_ScaleOutput	658
5.2.0.5 FB_ElapseTime	660
5.2.0.6 PipeNetwork_FFLD	663
5.2.0.7 ProfilesCode_FFLD	664
5.2.0.8 FB_TemperaturePID	666
5.2.0.9 MLFB_DriveFault	669

5.2.0.10	MLFB_ECATRstart	672
5.2.0.11	MLFB_HomeFindHomeInput	674
5.2.0.12	MLFB_HomeFindHomeInputThenZeroAngle	677
5.2.0.13	MLFB_HomeFindLimitInput	679
5.2.0.14	MLFB_HomeFindLimitInputThenZeroAngle	681
5.2.0.15	MLFB_HomeFindZeroAngle	683
5.2.0.16	MLFB_HomeMoveUntilPosErrExceeded	686
5.2.0.17	MLFB_HomeMoveUntilPosErrExceededThenZeroAngle	688
5.2.0.18	MLFB_HomeUsingCurrentPosition	690
5.2.0.19	MLFB_HomeFindHomeFastInput	691
5.2.0.20	MLFB_HomeFindHomeFastInputModulo	697
5.2.0.21	MLFB_HomeFindLimitFastInput	703
5.2.0.22	MLFB_HomeFindLimitFastInputModulo	708
5.2.0.23	MLFB_Jog	713
5.2.0.24	MLFB_PlsPosFw	715
5.2.0.25	MLFB_PlsPosFwBw	716
5.2.0.26	MLFB_PlsTimeFw	718
5.2.0.27	MCFB_AKDFault	720
5.2.0.28	MCFB_AKDFaultLookup	722
5.2.0.29	MCFB_DriveFault	723
5.2.0.30	MCFB_ECATRstart	726
5.2.0.31	MCFB_StepAbsolutes	728
5.2.0.32	MCFB_StepAbsSwitch	731
5.2.0.33	MCFB_StepBlock	738
5.2.0.34	MCFB_StepLimitSwitch	744
5.2.0.35	MCFB_StepRefPulse	750
5.2.0.36	MCFB_StepAbsSwitchFastInput	756
5.2.0.37	MCFB_StepLimitSwitchFastInput	763
5.2.0.38	MCFB_Jog	769
5.2.0.39	MCFB_GearedWebTension	771
5.2.0.40	Example 1	777
5.2.0.41	Example 2	778
5.2.0.42	FB_Cylinder	779
5.2.0.43	FB_AKDFltRpt	781
5.2.0.44	FB_S700FltRpt	785
5.2.0.45	FB_AxisPlsPosModulo	788
5.2.0.46	FB_AxisPlsPosNoModulo	790
6	Index	793

2 Motion Library

This chapter covers the Motion Library (for **Pipe Network** and **PLCopen**) in the function blocks tab of the Library toolbox.

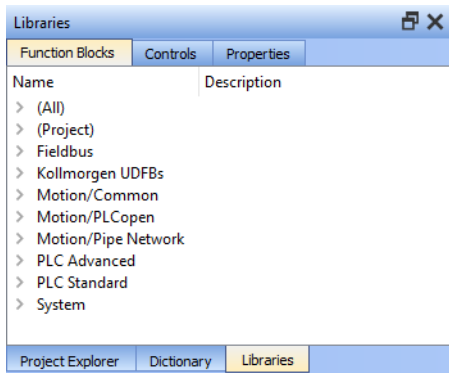

KAS function library contains ML function blocks that are used to integrate motion in a PLC program. ML function blocks can be used in 4 of the IEC 61131-3 languages: ST, FBD, FFLD and IL.

Regarding SFCSFC programs, ML function blocks (like any other function blocks from the library) are used as part of a stepstep or transitiontransition which are defined with ST, FBD, FFLD or IL languages.

2.1 Motion Library - Pipe Network

The KAS IDE function library contains ML function blocks that are used to integrate motion from a Pipe Network in a PLC program. ML Function blocks are of the following types:

Function	Description
Motion	Prepare the physical motion part: init, reset, start, stop
Pipe Network	Manage the Pipe Network: create/activate
Block	Manage the blocks: create/activate
Pipe Block	Manage each specific Pipe Block: read/write parameters

Table 1-1: List of Pipe Network FB

⚠ IMPORTANT

Pipe Network code is generated automatically by the compiler, you should not try to modify it.

2.1.1 Motion Library - Pipe Network

Name	Description	Return type
MLPipeAct	Activates a pipe	BOOL
MLPipeAddBlock	Adds a Pipe Block to a pipe	BOOL
MLPipeCreate	Creates a new pipe object	None
MLPipeDeact	Deactivates a pipe	BOOL

2.1.1.1 MLPipeAct Pipe Network ✓

2.1.1.1.1 Description

Activates a pipe. A Pipe contains an Input Pipe Block (Master, PMP, or Sampler), a Converter Output Pipe Block, and any Transformation Pipe Block that can be in between. The figure below shows two Pipes, both with the same Master Input Pipe Block. The first ends with the first converter, and has a Gear Pipe Block to transform the input values from the Master. The second pipe ends with the second converter, and has a CAM Pipe Block to modify the input values from the Master.

Once a Pipe is activated then history on the values in the Pipe's Blocks are saved and updated each program cycle. A Converter object connected to a destination Axis object cannot send updated position values unless its Pipe is activated.

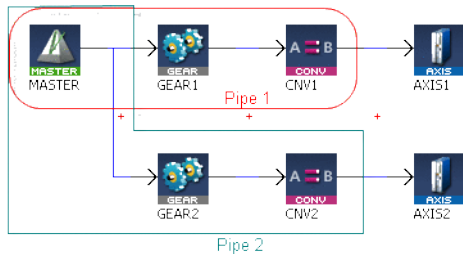

Figure 1-1: MLPipeAct

NOTE

All Pipes in the Pipe Network can be activated at once with the command `PipeNetwork(MLPN_ACTIVATE)`. This calls automatically generated code with `MLPipeAct` commands for each Pipe object. Therefore, in a multi-pipe program only one command can be used to activate Pipes instead of writing code for each Pipe separately.

2.1.1.1.2 Arguments

2.1.1.1.2.1 Input

PipeID	Description	ID number of a created Pipe object
	Data type	DINT
	Range	[-2147483648, 2147483648]
	Unit	N/A
	Default	—

2.1.1.1.2.2 Output

Default (.Q)	Description	Returns TRUE if the Pipe is activated
	Data type	BOOL
	Unit	N/A

2.1.1.1.2.3 Return Type

BOOL

2.1.1.1.3 Related Functions

[MLPipeDeact](#)

[MLCNVConnect](#)

[PipeNetwork\(MLPN_ACTIVATE\)](#)

[MLPipeAddBlock](#)

2.1.1.1.4 Example

2.1.1.1.4.1 Structured Text

```
//Activate a Pipe
MLPipeAct( PipeAXIS1 );
```

2.1.1.1.4.2 Ladder Diagram

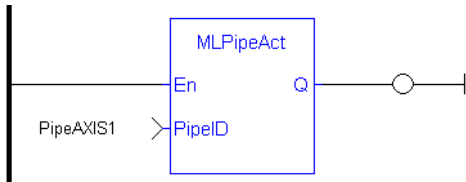

2.1.1.1.4.3 Function Block Diagram

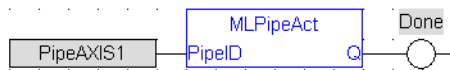

2.1.1.2 MLPipeAddBlock Pipe Network ✓

2.1.1.2.1 Description

Add a Pipe Block to a pipe. A Pipe contains an Input Pipe Block (Master, PMP, or Sampler), a Converter Output Pipe Block, and any Transformation Pipe Block that can be in between.

The figure below shows two Pipes, both with the same Master Input Pipe Block. If a user were to create the Pipe 1 below without using the Graphical Engine, they would use the following commands once a Pipe and the Pipe Blocks have been created.

```
MLPipeAddBlock( PipeAXIS1, MASTER);
```

```
MLPipeAddBlock( PipeAXIS1, MyGear);
```

```
MLPipeAddBlock( PipeAXIS1, CNV1);
```

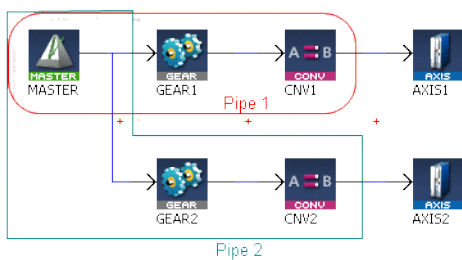

Figure 1-2: MLPipeAddBlock

NOTE

All Blocks in the Pipe Network are added to a Pipe automatically. Code with MLPipeAddBlock commands are automatically generated and called in a program with PipeNetwork(MLPN_CREATE_OBJECTS). Therefore, when using the Pipe Network graphical engine to create Pipe Blocks the user does not have to manually add MLPipeAddBlock commands to the Project.

2.1.1.2.2 Arguments

2.1.1.2.2.1 Input

PipeID	Description	ID number of a created Pipe
	Data type	DINT
	Range	[-2147483648, 2147483648]
	Unit	N/A
	Default	—
BlockID	Description	ID number of a created Pipe object to add to the selected Pipe
	Data type	DINT
	Range	[-2147483648, 2147483648]
	Unit	N/A
	Default	—

2.1.1.2.2.2 Output

Default (.Q)	Description	Returns TRUE if the Pipe Block is added to the Pipe
	Data type	BOOL
	Unit	N/A

2.1.1.2.2.3 Return Type

BOOL

2.1.1.2.3 Related Functions

[PipeNetwork\(MLPN_CREATE_OBJECTS\)](#)

[MLPipeAct](#)

[MLPipeCreate](#)

[MLPipeDeact](#)

2.1.1.2.4 Example

2.1.1.2.4.1 Structured Text

```
//Add a block to a pipe
MLPipeAddBlock( PipeAXIS1, MyGear );
```

2.1.1.2.4.2 Ladder Diagram

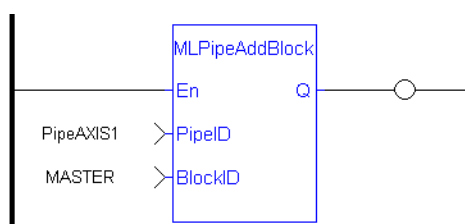

2.1.1.2.4.3 Function Block Diagram



2.1.1.3 MLPipeCreate Pipe Network ✓

2.1.1.3.1 Description

Create a new pipe object. A Pipe contains an Input Pipe Block (Master, PMP, or Sampler), a Converter Output Pipe Block, and any Transformation Pipe Block that can be in between. The figure below shows two Pipes, both with the same Master Input Pipe Block.

NOTE

Pipes are normally created in the Pipe Network using the graphical engine. Then you do not have to add MLPipeCreate function blocks to their programs. Pipes are created graphically, and the code with MLPipeCreate commands are automatically generated and called in a program with PipeNetwork(MLPN_CREATE_OBJECTS).

2.1.1.3.2 Arguments

2.1.1.3.2.1 Input

Name	Description	Desired name for the newly created Pipe
	Data type	String
	Range	—
	Unit	N/A
	Default	—

2.1.1.3.2.2 Output

ID	Description	Assigned ID number of the created Pipe
	Data type	DINT
	Unit	N/A
	Default	—

2.1.1.3.3 Related Functions

[PipeNetwork\(MLPN_CREATE_OBJECTS\)](#)

[MLPipeAddBlock](#)

[MLPipeAct](#)

[MLPipeDeact](#)

2.1.1.3.4 Example

2.1.1.3.4.1 Structured Text

```
//Create a new pipe
PipeAXIS1 := MLPipeCreate( 'PipeAXIS1' );
```

2.1.1.3.4.2 Ladder Diagram

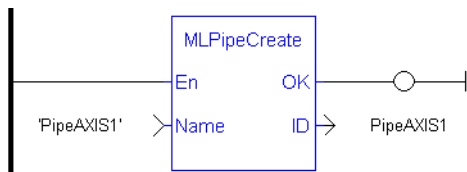

2.1.1.3.4.3 Function Block Diagram



2.1.1.4 MLPipeDeact Pipe Network ✓

2.1.1.4.1 Description

Deactivates a pipe. A Pipe contains an Input Pipe Block (Master, PMP, or Sampler), a Converter Output Pipe Block, and any Transformation Pipe Block that can be in between. The figure below shows two Pipes, both with the same Master Input Pipe Block. The first ends with the first converter, and has a Gear Pipe Block to transform the input values from the Master. The second pipe ends with the second converter, and has a CAM Pipe Block to modify the input values from the Master.

Once a Pipe is activated then history on the values in the Pipe's Blocks are lost and no longer updated. A Converter object connected to a destination Axis object cannot send updated position values once its Pipe is deactivated.

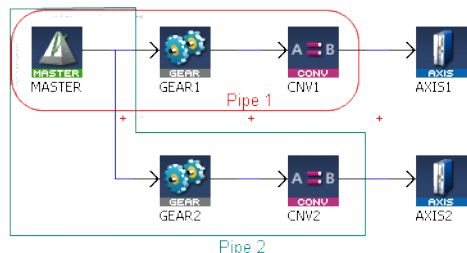

Figure 1-3: MLPipeDeact

NOTE
 All Pipes in the Pipe Network can be deactivated at once with the command PipeNetwork(MLPN_DEACTIVATE). This calls automatically generated code with MLPipeDeact commands for each Pipe object. Therefore, in a multi-pipe program only one command can be used to deactivate Pipes instead of writing code for each Pipe separately.

2.1.1.4.2 Arguments

2.1.1.4.2.1 Input

PipeID	Description	ID number of a created Pipe object
	Data type	DINT
	Range	[-2147483648, 2147483648]
	Unit	N/A
	Default	—

2.1.1.4.2.2 Output

Default (.Q)	Description	Returns TRUE if the Pipe is deactivated
	Data type	BOOL
	Unit	N/A

2.1.1.4.2.3 Return Type

BOOL

2.1.1.4.3 Related Functions

[MLPipeAct](#)

[MLCNVDisconnect](#)

[PipeNetwork\(MLPN_DEACTIVATE\)](#)

[MLPipeAddBlock](#)

2.1.1.4.4 Example

2.1.1.4.4.1 Structured Text

```
//Deactivate a Pipe
MLPipeDeact( PipeAXIS1 );
```

2.1.1.4.4.2 Ladder Diagram

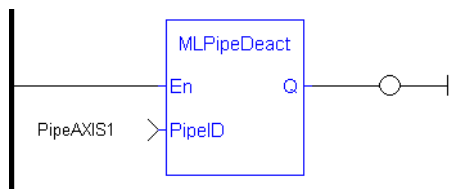

2.1.1.4.4.3 Function Block Diagram



2.1.2 iMotion Library - Block

Name	Description	Return type
MLBlkCreate	Creates a new Pipe Block object	None
MLBlkIsReady	Checks if a Pipe Block currently has a function running	BOOL
MLBlkReadModPos	Gets the value of the period of a block in user units	None
MLBlkReadOutVal	Gets the output value of a selected Pipe Block	None
MLBlkWriteModPos	Sets the value of the period of a block in user units	BOOL

2.1.2.1 MLBlkCreate Pipe Network ✓

2.1.2.1.1 Description

Creates a new Pipe Block object. Before a Pipe Block is Initialized the block needs to be created and assigned an ID number. MLBlkCreate function block is automatically called if a Block is added to the Pipe Network.

NOTE

Pipe Blocks are normally created in the Pipe Network using the graphical engine. Then you do not have to add MLBlkCreate function blocks to their programs. Blocks are created graphically, and the code with MLBlkCreate commands are automatically generated and called in a program with Pipe Network(MLPN_CREATE_OBJECTS).

TIP

This function should be called after [MLMotionInit](#) is called and before [MLMotionStart](#) is called.

2.1.2.1.2 Arguments

2.1.2.1.2.1 Input

Name	Description	Desired name for the newly created Pipe Block
	Data type	String
	Range	—
	Unit	N/A
	Default	—
Type	Description	Type of Pipe Block to create (ex. MASTER, GEAR, PHASER, etc.)
	Data type	String
	Range	—
	Unit	N/A
	Default	—

2.1.2.1.2.2 Output

ID	Description	Assigned ID number of the created Block
	Data type	DINT
	Unit	N/A
	Default	—

2.1.2.1.3 Related Functions

[PipeNetwork\(MLPN_CREATE_OBJECTS\)](#)

[MLAxisInit](#)

2.1.2.1.4 Example

2.1.2.1.4.1 Structured Text

```
//Create a new GEAR Pipe Block named "MyGear"
MyGear := MLBlkCreate( 'MyGear', 'GEAR' );
```

2.1.2.1.4.2 Ladder Diagram

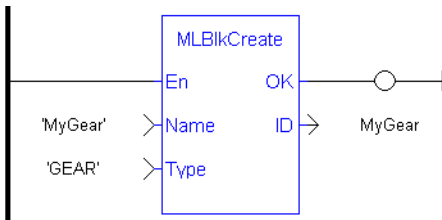

2.1.2.1.4.3 Function Block Diagram



2.1.2.2 MLBlkReadOutVal Pipe Network ✓

2.1.2.2.1 Description

Get the output value a selected Pipe Block.

NOTE

This function or function block returns cached data. See [Programming a Dual Core Controller](#) for more information.

2.1.2.2.2 Arguments

2.1.2.2.2.1 Input

ID	Description	ID number of a created Pipe Block
	Data type	DINT
	Range	[-2147483648, 2147483648]
	Unit	N/A
	Default	—

2.1.2.2.2.2 Output

Value	Description	Current output value of the selected Pipe Block
	Data type	LREAL
	Unit	N/A
	Default	—

2.1.2.2.3 Related Functions

[MLBlkReadModPos](#)

[MLBlkCreate](#)

2.1.2.2.4 Example

2.1.2.2.4.1 Structured Text

```
//Save the output of a Gear Pipe Block  
BlockOutput := MlBlkReadOutVal( PipeNetwork.MyGear );
```

2.1.2.2.4.2 Ladder Diagram

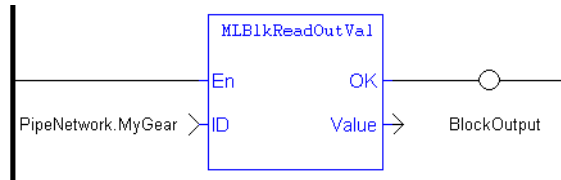

2.1.2.2.4.3 Function Block Diagram

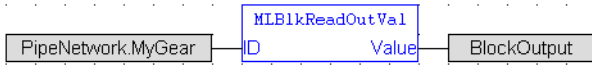

2.1.2.3 MLBlkReadModPos Pipe Network ✓

2.1.2.3.1 Description

Get the value of the period of a block in user units. The output value of a block is reset each time it reaches its period value.

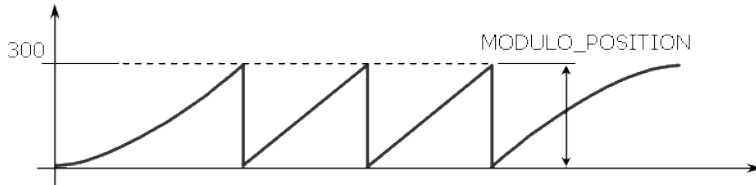

Figure 1-4: MLBlkReadModPos

2.1.2.3.2 Arguments

2.1.2.3.2.1 Input

ID	Description	ID number of a created Pipe Block
	Data type	DINT
	Range	[-2147483648, 2147483648]
	Unit	N/A
	Default	—

2.1.2.3.2.2 Output

ModuloPosition	Description	Current Period Value for selected Pipe Block
	Data type	LREAL
	Unit	User unit
	Default	—

2.1.2.3.3 Related Functions

[MLBlkWriteModPos](#)

[MLBlkCreate](#)

[MLBlkReadOutVal](#)

2.1.2.3.4 Example

2.1.2.3.4.1 Structured Text

```
//Return and save the Period of a Pipe Block
GearPeriod := MLBlkReadModPos ( PipeNetwork.MyGear );
```

2.1.2.3.4.2 Ladder Diagram

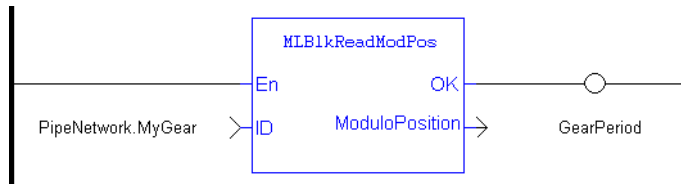

2.1.2.3.4.3 Function Block Diagram

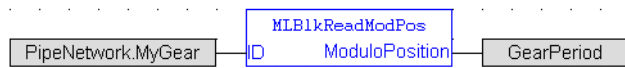

2.1.2.4 MLBlkIsReady

2.1.2.4.1 Description

Check if a block is ready. Returns FALSE if the selected Pipe Block has a function running. Returns TRUE if no function of a specified Pipe Block is running.

NOTE

Same return value as the .Q output of a specific function itself.

NOTE

This function or function block returns cached data. See [Programming a Dual Core Controller](#) for more information.

2.1.2.4.2 Arguments

2.1.2.4.2.1 Input

ID	Description	ID number of a created Pipe Block
	Data type	DINT
	Range	[-2147483648, 2147483648]
	Unit	N/A
	Default	—

2.1.2.4.2.2 Output

Default (.Q)	Description	Returns TRUE if no function of a specified Pipe Block is running.
	Data type	BOOL
	Unit	N/A

2.1.2.4.2.3 Return Type

BOOL

2.1.2.4.3 Related Functions

[MLBlkReadOutVal](#)

[MLBlkReadModPos](#)

2.1.2.4.4 Example

2.1.2.4.4.1 Structured Text

```
//Check if the MST Pipe Block named "MASTER" has a function running
IsReady := MLBlkIsReady( PipeNetwork.MASTER );
```

2.1.2.4.4.2 Ladder Diagram

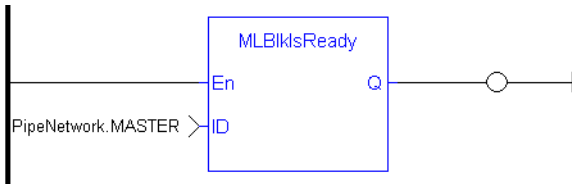

2.1.2.4.4.3 Function Block Diagram

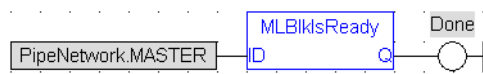

2.1.2.5 MLBlkWriteModPos Pipe Network ✓

2.1.2.5.1 Description

Set the value of the period of a block in user units. The output value of a block is reset each time it reaches its period value.

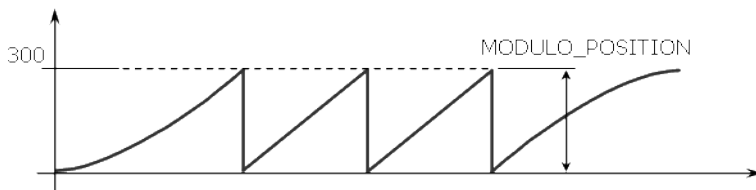

Figure 1-5: MLBlkReadModPos

2.1.2.5.2 Arguments

2.1.2.5.2.1 Input

ID	Description	ID number of a created Pipe Block
	Data type	DINT
	Range	[-2147483648, 2147483648]
	Unit	N/A
	Default	—
ModuloPosition	Description	Desired new Period Value for selected Pipe Block
	Data type	LREAL
	Range	—
	Unit	User unit
	Default	—

2.1.2.5.2.2 Output

Default (.Q)	Description	Returns TRUE if the function block executes
	Data type	BOOL
	Unit	N/A

2.1.2.5.2.3 Return Type

BOOL

2.1.2.5.3 Related Functions

[MLBlkReadModPos](#)

[MLBlkCreate](#)

[MLBlkReadOutVal](#)

2.1.2.5.4 Example

2.1.2.5.4.1 Structured Text

```
//Set the Period of a Pipe Block to 300
MLBlkWriteModPos( PipeNetwork.MyGear, 300 );
```

2.1.2.5.4.2 Ladder Diagram

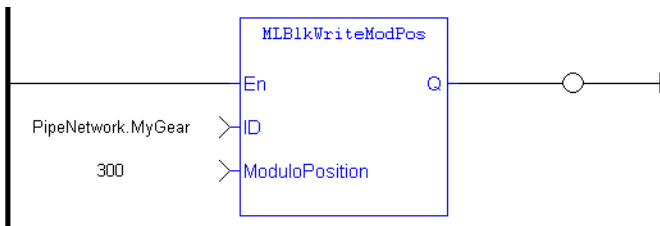

2.1.2.5.4.3 Function Block Diagram

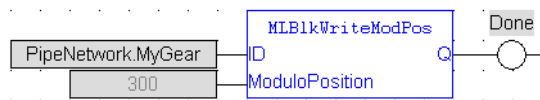

2.1.3 idMotion Library - Adder

Name	Description	Return type
MLAddInit	Initializes an Adder Pipe Block with user-defined settings	BOOL
MLAddReadOff1	Returns the offset value of the first entry of an Adder block	None
MLAddReadOff2	Returns the offset value of the second entry of an Adder block	None
MLAddReadRatio1	Returns the ratio value of the first entry of an Adder block	None
MLAddReadRatio2	Returns the ratio value of the second entry of an Adder block	None
MLAddWriteInput	Sets the source of an input of an adder Pipe Block	BOOL
MLAddWriteOff1	Sets the offset value of the first entry of the Adder block	BOOL
MLAddWriteOff2	Sets the offset value of the second entry of the Adder block	BOOL
MLAddWriteRat1	Sets the ratio value of the first entry of the Adder block	BOOL
MLAddWriteRat2	Sets the ratio value of the second entry of the Adder block	BOOL

2.1.3.1 MLAddInit Pipe Network ✓

2.1.3.1.1 Description

Initializes an Adder Pipe Block for use in a PLC Program. Function block is automatically called if an Adder Block is added to the Pipe Network, with user-defined settings entered in the Pipe Blocks Properties screen.

The Pipe Block is assigned ratios and offsets for both inputs. After an Adder block is initialized, the inputs still need to be selected using the MAddWriteInput function block or graphically using the Pipe Network.

Adder Block Output = Ratio1*Input1 + Offset1 + Ratio2*Input2 + Offset2

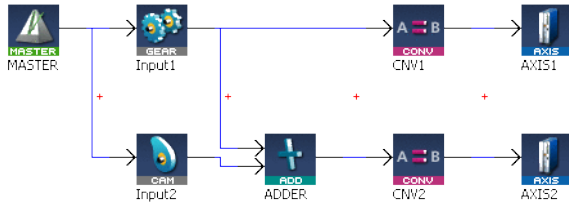

Figure 1-6: MAddInit

NOTE

Adder objects are normally created in the Pipe Network using the graphical engine. Then you do not have to add MAddInit function blocks to their programs. Parameters are entered directly in pop-up windows, and the code is then automatically added to the current project.

2.1.3.1.2 Arguments

2.1.3.1.2.1 Input

BlockID	Description	ID number of a created Pipe Block
	Data type	DINT
	Range	[-2147483648, 2147483648]
	Unit	N/A
	Default	—
Ratio1	Description	Sets the Ratio value of the first entry of an Adder object
	Data type	LREAL
	Range	—
	Unit	N/A
	Default	—
Offset1	Description	Sets the Offset value of the first entry of an Adder object
	Data type	LREAL
	Range	—
	Unit	N/A
	Default	—
Ratio2	Description	Sets the Ratio value of the second entry of an Adder object
	Data type	LREAL

	Range	—
	Unit	N/A
	Default	—
Offset2	Description	Sets the Offset value of the second entry of an Adder object
	Data type	LREAL
	Range	—
	Unit	N/A
	Default	—

2.1.3.1.2.2 Output

Default (.Q)	Description	Returns TRUE if the Adder Pipe Block is initialized.
	Data type	BOOL
	Unit	N/A

2.1.3.1.2.3 Return Type

BOOL

2.1.3.1.3 Related Functions

[MLBlkCreate](#)

[MLAddWriteInput](#)

[MLAddReadOff1](#)

[MLAddReadRatio1](#)

2.1.3.1.4 Example

2.1.3.1.4.1 Structured Text

```
//Create and Initiate a Trigger object
MyAdder := MLBlkCreate( 'MyAdder', 'ADDER' );
MLAddInit( MyAdder, 1.0, 0.0, 1.0, 0.0 );
```

2.1.3.1.4.2 Ladder Diagram

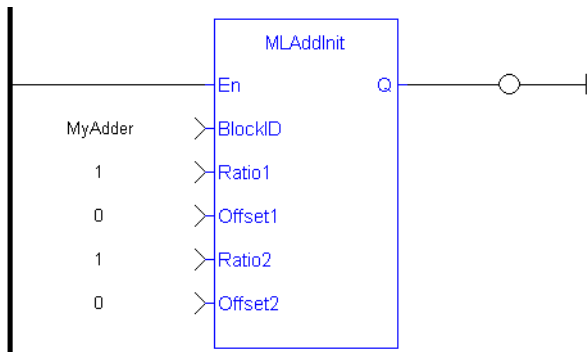

2.1.3.1.4.3 Function Block Diagram

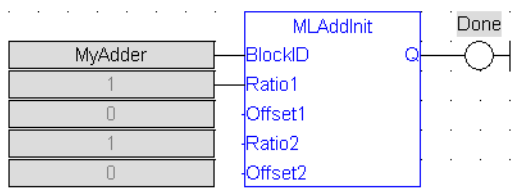

2.1.3.2 MAddReadOff1 Pipe Network ✓

2.1.3.2.1 Description

Returns the offset value of the first entry of an Adder block. Can change the offset value with MAddWriteOff1 function block. Offset1 shifts the value of the first input to the block before its added to the second input.

$$\text{Adder Block Output} = \text{Ratio1} * \text{Input1} + \text{Offset1} + \text{Ratio2} * \text{Input2} + \text{Offset2}$$

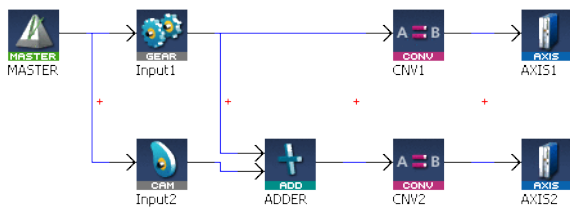

Figure 1-7: MAddReadOff1

2.1.3.2.2 Arguments

2.1.3.2.2.1 Input

BlockID	Description	ID number of an initiated Adder object
	Data type	DINT
	Range	[-2147483648, 2147483648]
	Unit	N/A
	Default	—

2.1.3.2.2.2 Output

Offset	Description	Returns the offset value of the first entry of an Adder object
---------------	--------------------	--

Data type	LREAL
Unit	N/A

2.1.3.2.3 Related Functions

- [MLAddWriteOff1](#)
- [MLAddReadOff2](#)
- [MLAddReadRatio1](#)
- [MLAddWriteRat1](#)

2.1.3.2.4 Example

2.1.3.2.4.1 Structured Text

```
//Save the offset value of first entry to the Adder block
AdderOffset := MLAddReadOff1( PipeNetwork.MyAdder );
```

2.1.3.2.4.2 Ladder Diagram

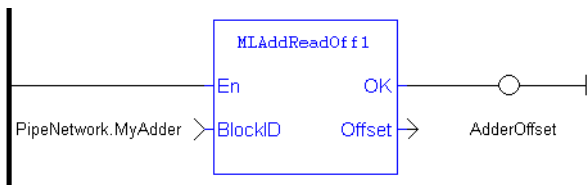

2.1.3.2.4.3 Function Block Diagram



2.1.3.3 MLAddReadOff2 Pipe Network ✓

2.1.3.3.1 Description

Returns the offset value of the second entry of an Adder block. Can change the offset value with MLAddWriteOff2 function block. Offset2 shifts the value of the second input to the block before its added to the first input.

$$\text{Adder Block Output} = \text{Ratio1} * \text{Input1} + \text{Offset1} + \text{Ratio2} * \text{Input2} + \text{Offset2}$$

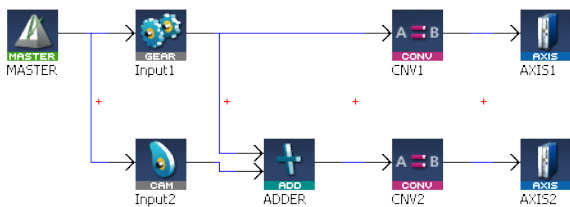

Figure 1-8: MLAddReadOff2

2.1.3.3.2 Arguments

2.1.3.3.2.1 Input

BlockID	Description	ID number of an initiated Adder object
	Data type	DINT
	Range	[-2147483648, 2147483648]
	Unit	N/A
	Default	—

2.1.3.3.2 Output

Offset	Description	Returns the offset value of the second entry of an Adder object
	Data type	LREAL
	Unit	N/A

2.1.3.3.3 Related Functions

[MLAddWriteOff2](#)

[MLAddReadOff1](#)

[MLAddReadRatio2](#)

[MLAddWriteRat2](#)

2.1.3.3.4 Example

2.1.3.3.4.1 Structured Text

```
//Save the offset value of second entry to the Adder block
AdderOffset := MLAddReadOff2 ( PipeNetwork.MyAdder );
```

2.1.3.3.4.2 Ladder Diagram

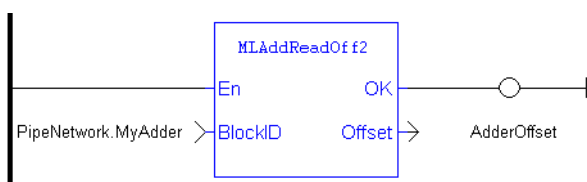

2.1.3.3.4.3 Function Block Diagram



2.1.3.4 MLAddReadRatio1



2.1.3.4.1 Description

Returns the ratio value of the first entry of an Adder block. Can change the ratio value with MLAddWriteRat1 function block. Ratio1 amplifies the value of the first input to the block before its added to the second input.

$$\text{Adder Block Output} = \text{Ratio1} * \text{Input1} + \text{Offset1} + \text{Ratio2} * \text{Input2} + \text{Offset2}$$

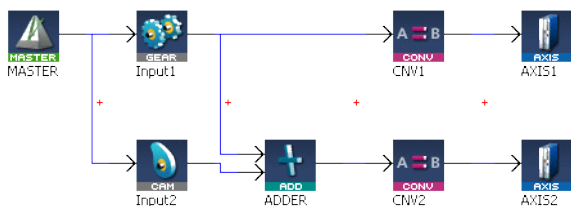

Figure 1-9: MLAddReadRatio1

2.1.3.4.2 Arguments

2.1.3.4.2.1 Input

BlockID	Description	ID number of an initiated Adder object
	Data type	DINT
	Range	[-2147483648, 2147483648]
	Unit	N/A
	Default	—

2.1.3.4.2.2 Output

Ratio	Description	Returns the Ratio value of the first entry of an Adder object
	Data type	LREAL
	Unit	N/A

2.1.3.4.3 Related Functions

[MLAddWriteRat1](#)

[MLAddReadRatio2](#)

[MLAddReadOff1](#)

[MLAddReadOff2](#)

2.1.3.4.4 Example

2.1.3.4.4.1 Structured Text

```
//Save the ratio value of first entry to the Adder block
AdderRatio := MLAddReadRatio1( PipeNetwork.MyAdder );
```

2.1.3.4.2 Ladder Diagram

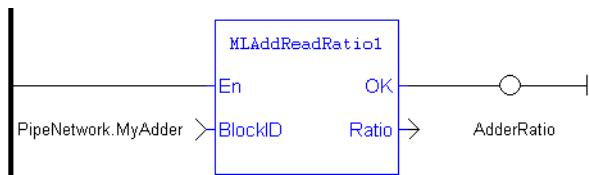

2.1.3.4.3 Function Block Diagram



2.1.3.5 MLAddReadRatio2



2.1.3.5.1 Description

Returns the ratio value of the second entry of an Adder block. Can change the ratio value with MLAddWriteRat2 function block. Ratio2 amplifies the value of the second input to the block before its added to the first input.

Adder Block Output = Ratio1*Input1 + Offset1 + Ratio2*Input2 + Offset2

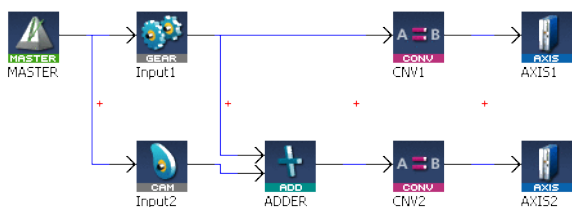

Figure 1-10: MLAddReadRatio2

2.1.3.5.2 Arguments

2.1.3.5.2.1 Input

BlockID	Description	ID number of an initiated Adder object
	Data type	DINT
	Range	[-2147483648, 2147483648]
	Unit	N/A
	Default	—

2.1.3.5.2.2 Output

Ratio	Description	Returns the Ratio value of the second entry of an Adder object
	Data type	LREAL
	Unit	N/A

2.1.3.5.3 Related Functions

[MLAddWriteRat2](#)

[MLAddReadRatio1](#)

[MLAddReadOff1](#)

[MLAddReadOff2](#)

2.1.3.5.4 Example

2.1.3.5.4.1 Structured Text

```
//Save the ratio value of second entry to the Adder block  
AdderRatio := MLAddReadRatio2( PipeNetwork.MyAdder );
```

2.1.3.5.4.2 Ladder Diagram

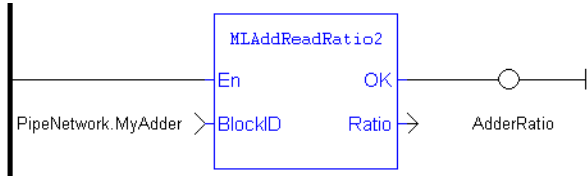

2.1.3.5.4.3 Function Block Diagram



2.1.3.6 MAddWriteInput Pipe Network ✓

2.1.3.6.1 Description

Sets the source of an input of an adder Pipe Block. Function block is automatically called if an Adder Block is connected to other blocks in the Pipe Network.

$$\text{Adder Block Output} = \text{Ratio1} * \text{Input1} + \text{Offset1} + \text{Ratio2} * \text{Input2} + \text{Offset2}$$

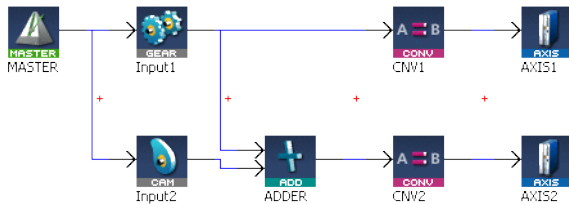

Figure 1-11: MAddWriteInput

NOTE

Adder objects are normally created in the Pipe Network using the graphical engine. Then you do not have to add MAddWriteInput function blocks to their programs. Blocks are connected with lines in the Pipe Network, and the code is then automatically added to the current project.

2.1.3.6.2 Arguments

2.1.3.6.2.1 Input

BlockID	Description	ID number of an initiated Adder object
	Data type	DINT
	Range	[-2147483648, 2147483648]
	Unit	N/A
	Default	—
InputID	Description	Select first or second input to the Adder object
	Data type	DINT
	Range	[1, 2]
	Unit	N/A
	Default	—

InputBlockID	Description	ID number of an initiated Pipe Block which is an input to the Adder object
	Data type	DINT
	Range	[-2147483648, 2147483648]
	Unit	N/A
	Default	—

2.1.3.6.2.2 Output

Default (.Q)	Description	Returns TRUE if the input to the Adder object is set
	Data type	BOOL
	Unit	N/A

2.1.3.6.2.3 Return Type

BOOL

2.1.3.6.3 Related Functions

[MLBlkCreate](#)

[MLAddInit](#)

[MLAddReadOff1](#)

[MLAddReadRatio1](#)

2.1.3.6.4 Example

2.1.3.6.4.1 Structured Text

```
//Set the first input of an Adder pipeblock to be connected to the output
of GEAR1 pipeblock
MLAddWriteInput( PipeNetwork.ADDER, 1, PipeNetwork.GEAR1 );
```

2.1.3.6.4.2 Ladder Diagram

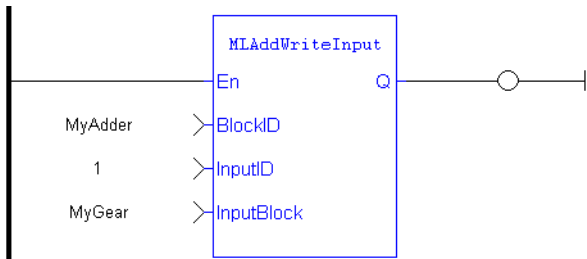

2.1.3.6.4.3 Function Block Diagram

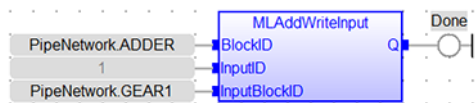

2.1.3.7 MLAddWriteOff1 Pipe Network ✓

2.1.3.7.1 Description

Set the offset value of the first entry of the Adder block. Offset1 shifts the value of the first input to the block before its added to the second input.

$$\text{Adder Block Output} = \text{Ratio1} * \text{Input1} + \text{Offset1} + \text{Ratio2} * \text{Input2} + \text{Offset2}$$

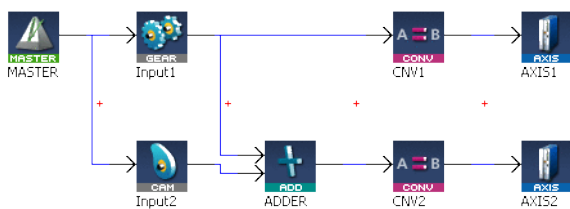

Figure 1-12: MLAddWriteOff1

⚠ IMPORTANT

Changes made to the Offset of an Adder block are executed immediately and can cause an axis position to jump.

2.1.3.7.2 Arguments**2.1.3.7.2.1 Input**

BlockID	Description	ID number of an initiated Adder object
	Data type	DINT
	Range	[-2147483648, 2147483648]
	Unit	N/A
	Default	—
Offset	Description	Desired new value for the Adder Object's Offset1
	Data type	LREAL
	Range	—
	Unit	N/A
	Default	—

2.1.3.7.2.2 Output

Default (.Q)	Description	Returns TRUE if the Offset value for input one is set
	Data type	BOOL
	Unit	N/A

2.1.3.7.2.3 Return Type

BOOL

2.1.3.7.3 Related Functions

[MLAddReadOff1](#)

[MLAddWriteOff2](#)

[MLAddReadRatio1](#)

[MLAddWriteRat1](#)

2.1.3.7.4 Example**2.1.3.7.4.1 Structured Text**

```
//Change the offset value of first entry to the Adder block to
10
MLAddWriteOff1( PipeNetwork.MyAdder, 10 );
```

2.1.3.7.4.2 Ladder Diagram

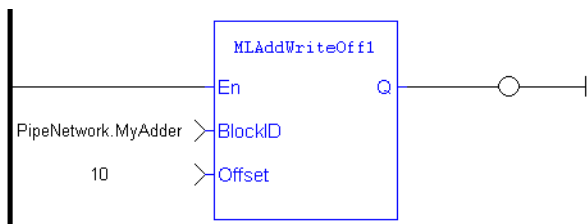

2.1.3.7.4.3 Function Block Diagram

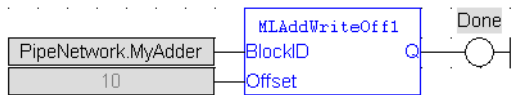

2.1.3.8 MAddWriteOff2 Pipe Network

2.1.3.8.1 Description

Set the offset value of the second entry of the Adder block. Offset2 shifts the value of the second input to the block before its added to the first input.

$$\text{Adder Block Output} = \text{Ratio1} * \text{Input1} + \text{Offset1} + \text{Ratio2} * \text{Input2} + \text{Offset2}$$

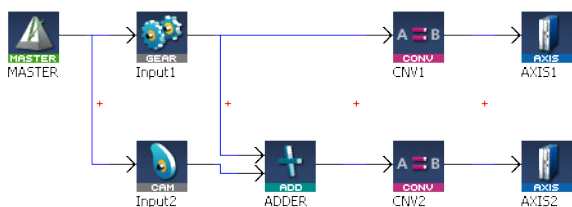

Figure 1-13: MAddWriteOff2

! IMPORTANT

Changes made to the Offset of an Adder block are executed immediately and can cause an axis position to jump.

2.1.3.8.2 Arguments

2.1.3.8.2.1 Input

BlockID	Description	ID number of an initiated Adder object
	Data type	DINT
	Range	[-2147483648, 2147483648]
	Unit	N/A
	Default	—
Offset	Description	Desired new value for the Adder Object's Offset2
	Data type	LREAL
	Range	—
	Unit	N/A
	Default	—

2.1.3.8.2.2 Output

Default (.Q)	Description	Returns TRUE if the Offset value for input two is set
	Data type	BOOL
	Unit	N/A

2.1.3.8.2.3 Return Type

BOOL

2.1.3.8.3 Related Functions

[MLAddReadOff2](#)

[MLAddWriteOff1](#)

[MLAddReadRatio2](#)

[MLAddWriteRat2](#)

2.1.3.8.4 Example

2.1.3.8.4.1 Structured Text

```
//Change the offset value of second entry to the Adder block to 10
MLAddWriteOff2( PipeNetwork.MyAdder, 10 );
```

2.1.3.8.4.2 Ladder Diagram

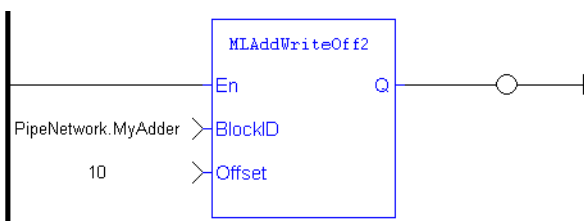

2.1.3.8.4.3 Function Block Diagram

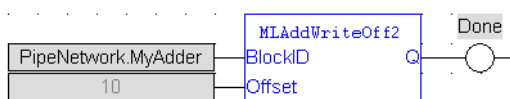

2.1.3.9 MLAddWriteRat1 Pipe Network ✓

2.1.3.9.1 Description

Set the ratio value of the first entry of the Adder block. Ratio1 amplifies the value of the first input to the block before its added to the second input.

$$\text{Adder Block Output} = \text{Ratio1} * \text{Input1} + \text{Offset1} + \text{Ratio2} * \text{Input2} + \text{Offset2}$$

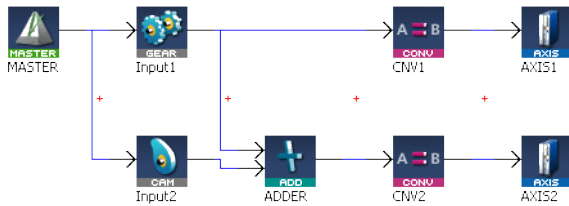

Figure 1-14: MlAddWriteRat1

! IMPORTANT

Changes made to the Ratio of an Adder block are executed immediately and can cause an axis position to jump.

2.1.3.9.2 Arguments**2.1.3.9.2.1 Input**

BlockID	Description	ID number of an initiated Adder object
	Data type	DINT
	Range	[-2147483648, 2147483648]
	Unit	N/A
	Default	—
Ratio	Description	Desired new value for the Adder Object's Ratio1
	Data type	LREAL
	Range	—
	Unit	N/A
	Default	—

2.1.3.9.2.2 Output

Default (.Q)	Description	Returns TRUE if the Ratio value for input one is set
	Data type	BOOL
	Unit	N/A

2.1.3.9.2.3 Return Type

BOOL

2.1.3.9.3 Related Functions

[MlAddReadRatio1](#)

[MlAddWriteRat2](#)

[MlAddReadOff1](#)

[MlAddWriteOff1](#)

2.1.3.9.4 Example**2.1.3.9.4.1 Structured Text**

```
//Change the ratio value of first entry to the Adder block to 2
MLAddWriteRat1( PipeNetwork.MyAdder, 2 );
```

2.1.3.9.4.2 Ladder Diagram

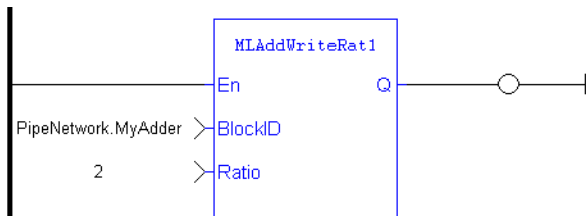

2.1.3.9.4.3 Function Block Diagram

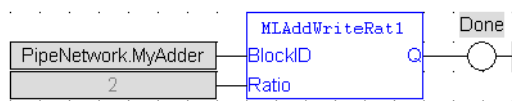

2.1.3.10 MLAddWriteRat2 Pipe Network ✓

2.1.3.10.1 Description

Set the ratio value of the second entry of the Adder block. Ratio2 amplifies the value of the second input to the block before its added to the first input.

$$\text{Adder Block Output} = \text{Ratio1} * \text{Input1} + \text{Offset1} + \text{Ratio2} * \text{Input2} + \text{Offset2}$$

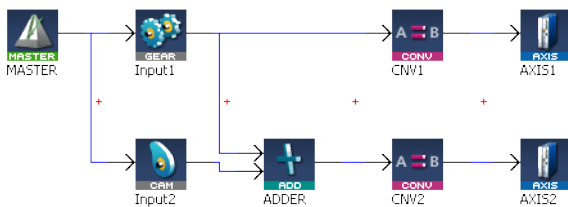

Figure 1-15: MLAddWriteRat2\

IMPORTANT

Changes made to the Ratio of an Adder block are executed immediately and can cause an axis position to jump.

2.1.3.10.2 Arguments

2.1.3.10.2.1 Input

BlockID	Description	ID number of an initiated Adder object
	Data type	DINT
	Range	[-2147483648, 2147483648]
	Unit	N/A
	Default	—
Ratio	Description	Desired new value for the Adder Object's Ratio2

Data type	LREAL
Range	—
Unit	N/A
Default	—

2.1.3.10.2.2 Output

Default (.Q)	Description	Returns TRUE if the Ratio value for input two is set
	Data type	BOOL
	Unit	N/A

2.1.3.10.2.3 Return Type

BOOL

2.1.3.10.3 Related Functions

[MLAddReadRatio2](#)

[MLAddWriteRat1](#)

[MLAddReadOff2](#)

[MLAddWriteOff2](#)

2.1.3.10.4 Example

2.1.3.10.4.1 Structured Text

```
//Change the ratio value of second entry to the Adder block to 2
MLAddWriteRat2 ( PipeNetwork.MyAdder, 2 );
```

2.1.3.10.4.2 Ladder Diagram

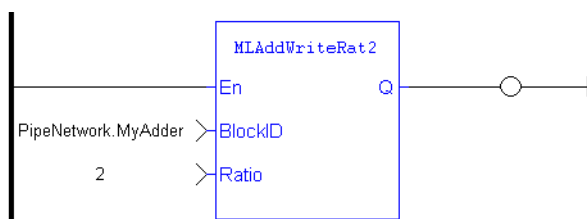

2.1.3.10.4.3 Function Block Diagram

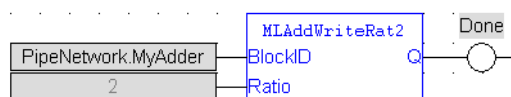

2.1.4 Motion Library - Axis

TIP

For an Axis function example, see ["Usage Example of Axis Functions"](#) on page 116

Function sorted by types:

Power Stage	Motion Control	Inquiry Functions	Position setting
MLAxisPower	MLAxisAbs	MLAxisGenPos	MLAxisWritePos
MLAxisPowerDOff	MLAxisAdd	MLAxisPipePos	MLAxisReAlign
	MLAxisMoveVel	MLAxisCmdPos	
	MLAxisRel	MLAxisReadActPos	
	MLAxisStop	MLAxisFBackPos	
		MLAxisStatus	
		MLAxisReadGenStatus	
		MLAxisGenIsRdy	
		MLAxisTimeStamp	
		MLAxisDriveNumber	

Functions sorted in alphabetical order:

Name	Description	Return type
MLAxisAbs	Performs a move to an absolute position	BOOL
MLAxisAdd	Performs an additive move relative for a specified distance from the endpoint of the previous move	BOOL
MLAxisAddress	Returns the motion bus address of the axis	DINT
MLAxisAddTq	Sets additive torque	BOOL
MLAxisCfgFastIn	Initializes the Fast Input capability for the axis	BOOL
MLAxisCmdPos	Returns the reference position of the axis	None
MLAxisDriveNumber	Read the DriveAxisNumber from a PipeNetwork axis	
MLAxisFBackPos	Returns the feedback position of the axis	None
MLAxisGenEN	Enables or disables the internal TMP generator of the axis	BOOL
MLAxisGenIsEN	Checks if the internal TMP generator of the axis is enabled	BOOL
MLAxisGenIsRdy	Checks if an axis is ready	BOOL
MLAxisGenPos	Returns the generator position of the axis	None
MLAxisGenReadAcc	Gets the acceleration of the internal generator of an axis	None
MLAxisGenReadDec	Gets the deceleration of the internal generator of an axis	None
MLAxisGenReadSpd	Gets the speed of the internal generator of an axis	None
MLAxisGenWriteAcc	Sets the acceleration of the internal generator of an axis	BOOL
MLAxisGenWriteDec	Sets the deceleration of the internal generator of an axis	BOOL
MLAxisGenWriteSpd	Sets the speed of the internal generator of an axis	BOOL
MLAxisInit	Initializes an axis object	BOOL
MLAxisIsCnctd	Checks if a pipe is currently connected to the axis	BOOL

Name	Description	Return type
MLAxisIsTriggered	Checks if the axis got a trigger event	BOOL
MLAxisMoveVel	Jogs at the specified speed	BOOL
MLAxisPipePos	Returns the pipe position of the axis	None
MLAxisPower	Powers up the axis. Enables a Servo drive or Stepper drive mapped to the axis..	BOOL
MLAxisPowerDOff	Returns the adjustment of position done by the last power on to avoid bumps	None
MLAxisRatedTq	Sets rated motor torque	BOOL
MLAxisReadActPos	Returns the actual position of the axis	None
MLAxisReadFBUnit	Gets the feedback units per revolution value of the axis	None
MLAxisReadFEUU	Read following error in user units	None
MLAxisReadGenStatus	Returns the status of the internal generator of the axis	DINT
MLAxisReadModPos	Get the value period of the axis	None
MLAxisReadTq	Read actual torque	None
MLAxisReadUUnits	Get the user units per revolution value of the axis	None
MLAxisReadVel	Read actual velocity	None
MLAxisReAlgnRdy	Checks if an axis is ready. Returns TRUE if the internal realignment axis is ready.	BOOL
MLAxisReAlign	Realigns the actual position with the reference position by moving the axis by the specified delta position	BOOL
MLAxisRel	Performs a relative move for a specified distance from the current position	BOOL
MLAxisResetErrors	Clears errors of the specified axis	BOOL
MLAxisRstFastIn	Resets the Fast Input	BOOL
MLAxisStatus	Returns the status of the axis	DINT
MLAxisStop	Stop with the specified deceleration	None
MLAxisTimeStamp	Returns the timestamp of the triggered axis	DINT
MLAxisWriteModPos	Sets the value period of the axis	BOOL
MLAxisWritePipPos	Forces the pipe position internal value. This function is working only when no pipe is connected.	BOOL
MLAxisWritePos	Sets the logical zero position of an axis	BOOL
MLAxisWriteUUnits	Sets the user units per revolution value of the axis	BOOL
MLPNAxisCreate	Creates a new axis object	None

2.1.4.1 [MLAxisAbs](#) Pipe Network ✓

2.1.4.1.1 Description

Performs a move to an absolute position. Returns TRUE if the function succeeded.

2.1.4.1.2 Arguments

2.1.4.1.2.1 Input

ID	Description	ID name of the Axis Block
	Data type	DINT
	Range	[-2147483648, 2147483648]
	Unit	N/A
	Default	—
Position	Description	Sets the value of the absolute destination position. When the Modulo is turned on, see more explanations below.
	Data type	LREAL
	Range	—
	Unit	User unit
	Default	—
Default (.Q)	Description	Returns true when function successfully executes
	Data type	BOOL
	Unit	N/A

2.1.4.2 Position with Modulo On

NOTE

This information applies to both [MLMstAbs](#) and [MLAxisAbs](#). For simplicity, the term Axis Block also refers to Master Block.

When the Modulo is turned on, the Axis Block moves to the targeted position during the corresponding period, calculated as follows:

- If the Position input is between 0 and the Modulo Position, then the Axis Block moves within the **current** period (no position rollover).
- If the Position input is greater than the Modulo Position, then the Axis Block moves during one of the **next** period (positive position rollover).

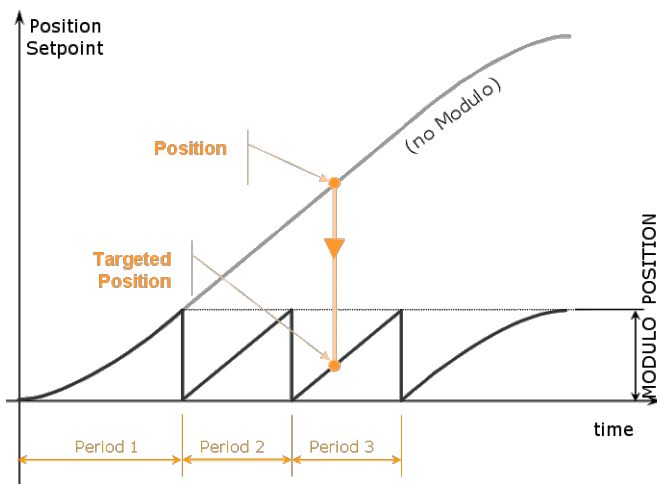

The Axis Block works similarly for negative positions: if the Position input is less than zero, then the Axis Block moves during one of the **previous** period (negative position rollover).

2.1.4.3 Forcing the direction of rotation

In some applications, the direction of rotation for the axis is forced in one direction only. As a consequence, the motor movement goes to the next or previous modulo in the following situations:

- If the **End Position** is less than the **Start Position** and the direction of rotation for the axis is forced to be clockwise (the **red point** shows when the modulo position is reached).

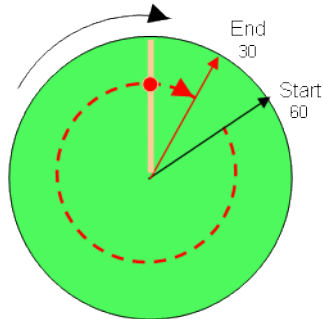

(see an example in row#2 of the table below)

- If the **End Position** is greater than the **Start Position** and the direction of rotation for the axis is forced to be counter clockwise.

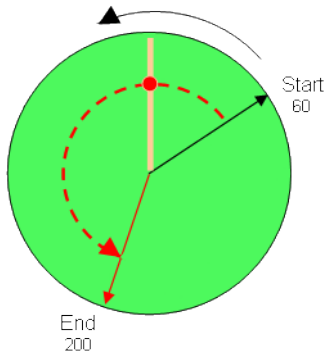

(see an example in row#4 of the table below)

Examples

Start Position	End Position	Direction of rotation	Cross Modulo	Position Input to MLAxisAbs (1)	RelativeDistance Moved (2)
60	200	clockwise	No	200	140 (i.e. 200 - 60 + 0)
60	30	clockwise	Yes	390	330 (i.e. 30 - 60 + 360)
60	30	counter clockwise	No	30	-30 (i.e. 30 - 60 - 0)
60	200	counter clockwise	Yes	-160	-220 (i.e. 200 - 60 - 360)

With:

(1) **Position Input** = End Position (+ Modulo * *Direction of rotation*)

(2) **Relative Distance Moved** = End Position - Start Position (+ Modulo * *Direction of rotation*)

Where:

Direction of rotation = 1 when clockwise and -1 when anti-clockwise

2.1.4.4 Travel Speed Update with MLAxisAbs

The travel speed of the generator can be updated using the function block [MLAxisGenWriteSpd](#). Depending on the state of the generator, this speed is directly reflected on the current move or a future move.

- If MLAxisAbs is not currently being executed, the new travel speed will be applied for the trajectory calculation for a future MLAxisAbs command.
- If MLAxisAbs is currently being executed and a new MLAxisAbs with the same target position is called, the new travel speed will be taken into account only if the current state of the TMP profile is the constant velocity or acceleration. If the axis was decelerating to stop at the goal position the new travel speed will not be taken into account.
- If a MLAxisAbs is currently being executed and a new MLAxisAbs with a different target position is called, the new travel speed is taken into account.

Following are several examples.

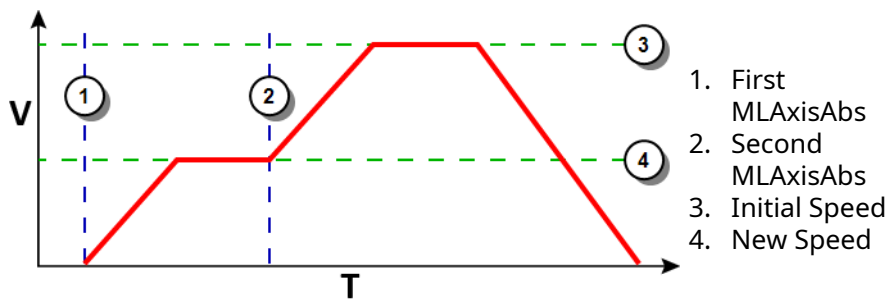

Figure 1-16: Initial speed is smaller than the new speed

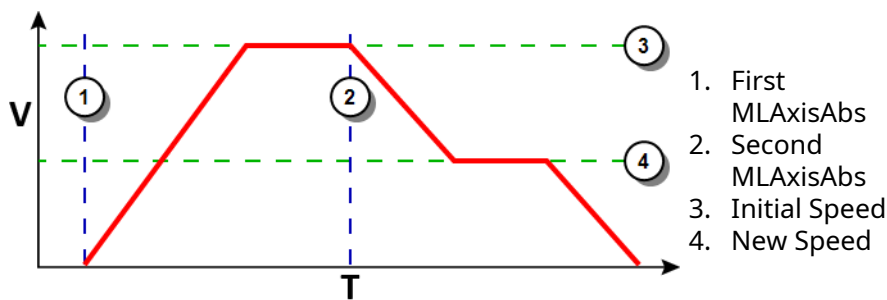

Figure 1-17: Initial speed is bigger than the new speed

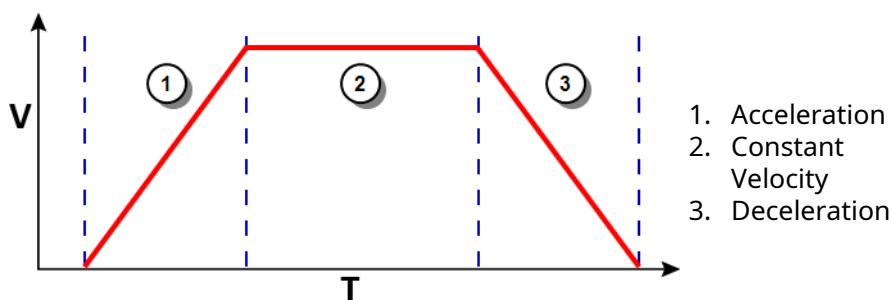

Figure 1-18: The speed update is taken into account only if the second MLAxisAbs is triggered during acceleration or constant velocity

2.1.4.4.1 Related Functions

[MLAxisGenWriteSpd](#)

[MLAxisGenWriteDec](#)

[MLAxisGenWriteAcc](#)

2.1.4.4.2 Example

See [Usage Example of Axis Functions](#) for additional examples.

2.1.4.4.2.1 Structured Text

```
MLAxisAbs ( PipeNetwork.Axis1, 2000 ) ;
```

2.1.4.4.2.2 Ladder Diagram



2.1.4.4.2.3 Function Block Diagram



2.1.4.5 MLAxisAdd Pipe Network ✓

2.1.4.5.1 Description

A selected Axis performs a move for a specified distance relative to the endpoint of the previous move. The DeltaPosition input is signed so that the move can be in the positive or negative direction, and the Axis moves this distance in user units. The travel speed, acceleration, deceleration, and User Units of the move are values inherited from the selected Axis. The default settings are entered when an Axis is created and initiated, and can be changed with other MLAxis commands such as [MLAxisGenWriteSpd](#), [MLAxisGenWriteAcc](#), and [MLAxisWriteUUnits](#).

2.1.4.5.2 Arguments

2.1.4.5.2.1 Input

ID	Description	ID Name of the Axis block
	Data type	DINT
	Range	—
	Unit	N/A
	Default	—
DeltaPosition	Description	Sets the Axis Delta Position to add to the endpoint of the previous move
	Data type	LREAL
	Range	—
	Unit	User unit

Default	—
----------------	---

2.1.4.5.2.2 Output

Default (.Q)	Description	Returns true when function successfully executes, after the motion profile is complete
	Data type	BOOL
	Unit	N/A

2.1.4.5.3 Related Functions

[MLAxisGenWriteAcc](#)

[MLAxisGenWriteDec](#)

[MLAxisGenWriteSpd](#)

2.1.4.5.4 Example

2.1.4.5.4.1 Structured Text

```
MLAxisAdd (PipeNetwork.Axis1, LREAL#750.0 ) ;
```

2.1.4.5.4.2 Ladder Diagram

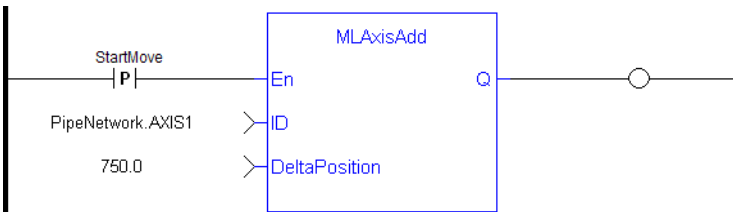

NOTE
You must use a [pulse contact](#) to start the FB

2.1.4.5.4.3 Function Block Diagram



2.1.4.6 MLAxisAddress Pipe Network ✓

2.1.4.6.1 Description

Returns the motion bus address of the axis. It is possible that two or more axes have the same address if the axis is mapped to a multi-axis drive, such as the dual-axis AKD2G drive.

NOTE
Axes will have the same address when they are mapped to the same multi-axis drive. For example if Axis1 is mapped to an AKD2G's Drive Axis Number 1 and Axis2 is mapped to the AKD2G's Drive

Axis Number 2, both axes will return the same address.

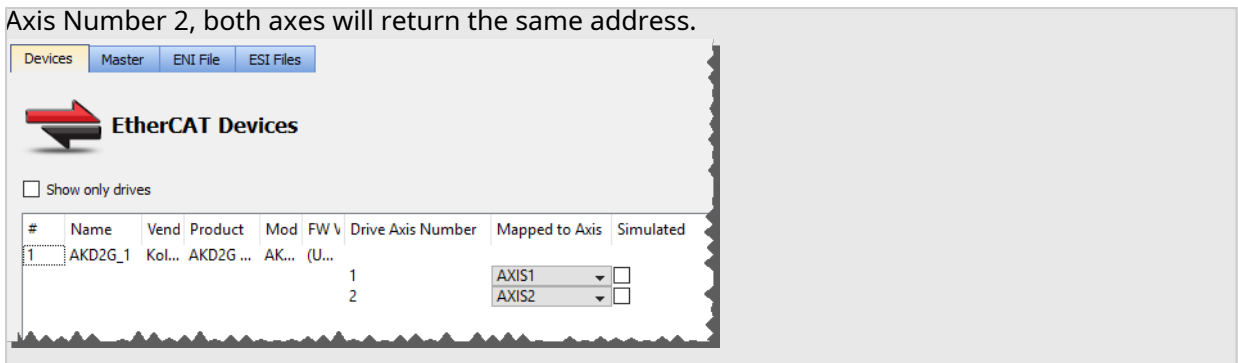

2.1.4.6.2 Arguments

2.1.4.6.2.1 Input

ID	Description	ID name of the Axis Block
	Data type	DINT
	Range	—
	Unit	N/A
	Default	—

2.1.4.6.2.2 Output

OK	Description	Returns true when function successfully executes
	Data type	BOOL
	Unit	N/A
Default (.Q)	Description	Returns the motion bus address of the axis
	Data type	DINT
	Unit	N/A

2.1.4.6.3 Example

2.1.4.6.3.1 Structured Text

```
Axis1_Address := MAxisAddress(PipeNetwork.AXIS1);
```

2.1.4.6.3.2 Ladder Diagram

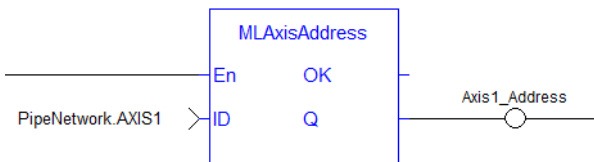

2.1.4.6.3.3 Function Block Diagram



2.1.4.7 MLAxisAddTq Pipe Network ✓

2.1.4.7.1 Description

Allows the application to set the additive torque value to the drive output (Torque feed-forward). This function is only active after the [MLAxisRatedTq](#) function has been invoked. Using the PDO, it also requires IL.KBUSFF value to be set to 1 in the drive.

NOTE

This function or function block returns cached data. See [Programming a Dual Core Controller](#) for more information.

2.1.4.7.2 Arguments

2.1.4.7.2.1 Input

ID	Description	Pipe network identifier of the axis block
	Data type	DINT
	Range	—
	Unit	N/A
	Default	—
Torque	Description	Requested additive torque value in N.m (Newton meter).
	Data type	LREAL
	Unit	Rated torque units as used in the drive (i.e. rated motor continuous torque x the Torque factor).

2.1.4.7.2.2 Output

Default (.Q)	Description	Returns true when function successfully executes
	Data type	BOOL
	Unit	N/A

2.1.4.7.3 Related Functions

[MLAxisRatedTq](#)

2.1.4.7.4 Example

2.1.4.7.4.1 Structured Text

```
MLAxisAddTq(PipeNetwork.Axis1, LREAL#10 ) ;
```

2.1.4.7.4.2 Ladder Diagram

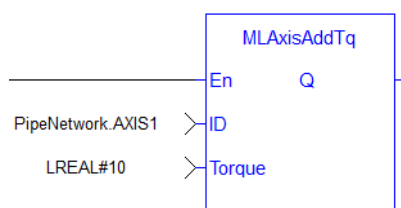

2.1.4.7.4.3 Function Block Diagram

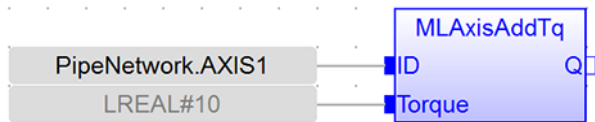

2.1.4.8 MLAxisCfgFastIn Pipe Network

2.1.4.8.1 Description

Configures the Fast Input for the axis by writing the expected settings in the Latch Control Word. Fast input can be armed on falling or rising edge.

2.1.4.8.2 Arguments

2.1.4.8.2.1 Input

En	Description	Enables execution
	Data type	BOOL
	Unit	N/A
	Default	-
AxisID	Description	ID name of the Axis Block
	Data type	DINT
	Range	—
	Unit	N/A
InputID	Description	ID of the FastInput of an axis, (ie IN1 and IN2 on S300) 0 = Touch Probe 1 / Capture Engine 0 1 = Touch Probe 2 / Capture Engine 1 Range is [0,1]
	Data type	DINT
	Range	[0, 1]
	Unit	N/A
Mode	Description	Configures the Fast Inputs as 0= Disabled, 1=Rising Edge, 2=Falling edge
	Data type	DINT
	Range	[0, 2]
	Unit	N/A
Default		—

2.1.4.8.2.2 Output

Q	Description	Returns true when the function successfully executes. Returns false if the fast input could not be configured due to an invalid PDO mapping in the .XML file.
	Data type	BOOL
	Unit	N/A

2.1.4.8.3 Related Functions

[MLAxisIsTriggered](#)

[MLAxisRstFastIn](#)

2.1.4.8.4 See Also

- [Fast Inputs with Pipe Network Motion](#)
- [Fast Homing Example with the Pipe Network Motion Engine Axis Pipe Block](#)
- [Fast Homing Example with the PLCopen Motion Engine](#)
- [Pipe Network Registration and Fast Homing](#)
- [Registration Position Capture Example with Pipe Network Trigger Block](#)

2.1.4.8.5 Example

2.1.4.8.5.1 Structured Text

```
MLAxisCfgFastIn( PipeNetwork.Axis1, 0, 1 ) ;
```

2.1.4.8.5.2 Ladder Diagram

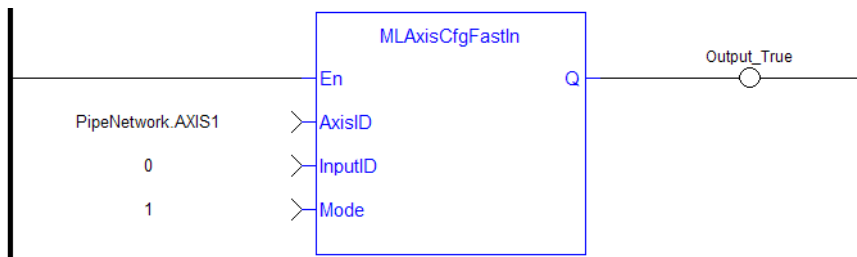

2.1.4.8.5.3 Function Block Diagram

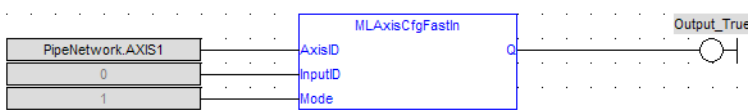

2.1.4.9 MLAxisCmdPos Pipe Network ✓

2.1.4.9.1 Description

Returns the reference position of the axis.

NOTE

This function or function block returns cached data. See [Programming a Dual Core Controller](#) for more information.

2.1.4.9.2 Arguments

2.1.4.9.2.1 Input

ID	Description	ID Name of the Axis block
	Data type	DINT
	Range	—
	Unit	N/A
	Default	—

2.1.4.9.2.2 Output

OK	Description	Returns true when function successfully executes
	Data type	BOOL
	Unit	N/A
Position	Description	Returns the Axis reference position
	Data type	LREAL
	Unit	User unit

2.1.4.9.3 Related Functions

[MLAxisReadActPos](#)

[MLAxisFBackPos](#)

[MLAxisGenPos](#)

[MLAxisPipePos](#)

[MLAxisWritePipPos](#)

2.1.4.9.4 Previous Function Name

MLAxisRefPos

2.1.4.9.5 Example

2.1.4.9.5.1 Structured Text

```
Axis1_ReferencePosition := MLAxisCmdPos(PipeNetwork.AXIS1);
```

2.1.4.9.5.2 Ladder Diagram

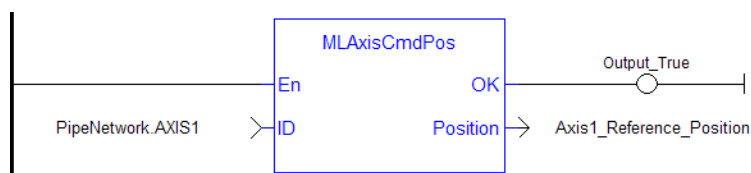

2.1.4.9.5.3 Function Block Diagram

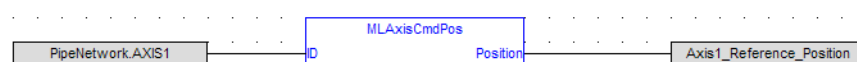

2.1.4.10 MLAxisDriveNumber Pipe Network ✓

2.1.4.10.1 Description

This function block returns the drive number that is associated with the axis, or -1 if the function block failed.

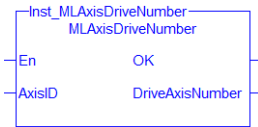

Figure 1-19: ML_AxisDriveNumber

TIP

MLPNAxisCreate assigns the drive axis number.

2.1.4.10.2 Arguments

2.1.4.10.2.1 Input

AxisID	Description	ID name of the Axis
	Data type	DINT
	Range	—
	Unit	N/A
	Default	—

2.1.4.10.2.2 Output

OK	Description	Returns true when the function successfully executes
	Data type	BOOL
	Range	N/A
	Unit	N/A
DriveAxisNumber	Description	Drive number that is associated with the axis, or -1 if the function block failed.
	Data type	INT
	Range	-1 or [1,32767]
	Unit	N/A

2.1.4.10.3 Related Functions

2.1.4.10.4 Example

2.1.4.10.4.1 Structured Text

```

Inst_MLAxisDriveNumber( AxisID)
IF Inst_MLAxisDriveNumber.OK Then
    Axis1DriveNumber := Inst_MLAxisDriveNumber.DriveAxisNumber
End_IF;
    
```

2.1.4.10.4.2 Ladder Diagram

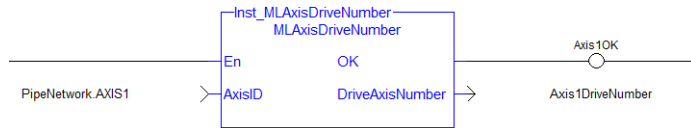

2.1.4.10.4.3 Function Block Diagram

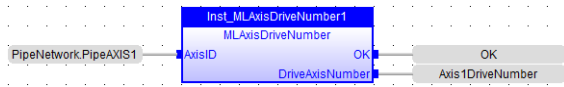

2.1.4.11 MLAxisFBackPos Pipe Network ✓

2.1.4.11.1 Description

Returns the Feedback Position of the axis

NOTE

This function or function block returns cached data. See [Programming a Dual Core Controller](#) for more information.

2.1.4.11.2 Arguments

2.1.4.11.2.1 Input

ID	Description	ID name of the Axis Block
	Data type	DINT
	Range	—
	Unit	N/A
	Default	—

2.1.4.11.2.2 Output

OK	Description	Returns true when function successfully executes
	Data type	BOOL
	Unit	N/A
Position	Description	Returns the Feedback Position of the axis
	Data type	LREAL
	Unit	User unit

2.1.4.11.3 Related Functions

[MLAxisReadActPos](#)

[MLAxisGenPos](#)

[MLAxisPipePos](#)

[MLAxisCmdPos](#)

[MLAxisWritePipPos](#)

2.1.4.11.4 Example

2.1.4.11.4.1 Structured Text

```
Axis1_Position := MAxisFBackPos( PipeNetwork.Axis1 ) ;
```

2.1.4.11.4.2 Ladder Diagram



2.1.4.11.4.3 Function Block Diagram



2.1.4.12 MAxisGenEN Pipe Network ✓

2.1.4.12.1 Description

Enables or disables the internal TMP generator of the axis.

NOTE
 This function or function block returns cached data. See [Programming a Dual Core Controller](#) for more information.

2.1.4.12.2 Arguments

2.1.4.12.2.1 Input

ID	Description	ID Name of the Axis block
	Data type	DINT
	Range	—
	Unit	N/A
	Default	—
Enable	Description	Boolean switch to activate the generator
	Data type	BOOL
	Range	0, 1
	Unit	N/A
	Default	—

2.1.4.12.2.2 Output

Default (.Q)	Description	Returns true when function successfully executes
	Data type	BOOL
	Unit	N/A

2.1.4.12.3 Related Functions

[MLAxisGenIsEN](#)

2.1.4.12.4 Example

2.1.4.12.4.1 Structured Text

```
MLAxisGenEN( PipeNetwork.Axis1, true) ;
```

2.1.4.12.4.2 Ladder Diagram

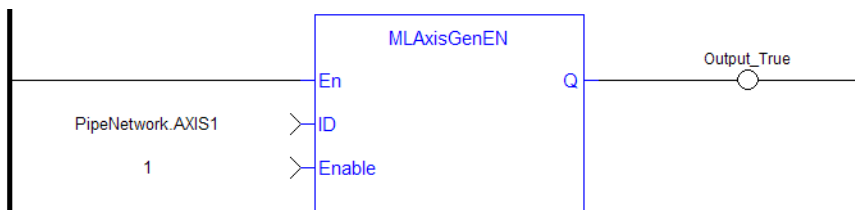

2.1.4.12.4.3 Function Block Diagram

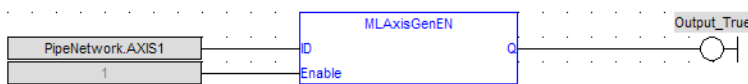

2.1.4.13 MLAxisGenIsEN Pipe Network ✓

2.1.4.13.1 Description

Check if the internal TMP generator of the axis is enable. Returns TRUE if the internal generator is enabled.

2.1.4.13.2 Arguments

2.1.4.13.2.1 Input

ID	Description	ID Name of the Axis block
	Data type	DINT
	Range	—
	Unit	N/A
	Default	—

2.1.4.13.2.2 Output

Default (.Q)	Description	Returns true when function successfully executes
	Data type	BOOL
	Unit	N/A

2.1.4.13.3 Related Functions

[MLAxisGenIsRdy](#)

2.1.4.13.4 Example

2.1.4.13.4.1 Structured Text

```
MLAxisGenIsEN(PipeNetwork.Axis1 ) ;
```

2.1.4.13.4.2 Ladder Diagram



2.1.4.13.4.3 Function Block Diagram



2.1.4.14 MLAxisGenIsRdy Pipe Network ✓

2.1.4.14.1 Description

Check if an axis is ready. Returns TRUE if the internal generator axis is ready.

NOTE

This function or function block returns cached data. See [Programming a Dual Core Controller](#) for more information.

2.1.4.14.2 Arguments

2.1.4.14.2.1 Input

ID	Description	ID Name of the Axis block
	Data type	DINT
	Range	—
	Unit	N/A
	Default	—

2.1.4.14.2.2 Output

Default (.Q)	Description	Returns true when function successfully executes
	Data type	BOOL
	Unit	N/A

2.1.4.14.3 Related Functions

[MLAxisGenIsEN](#)

[MLAxisStatus](#)

2.1.4.14.4 Example

See [Usage Example of Axis Functions](#) for additional examples.

2.1.4.14.4.1 Structured Text

```
MLAxisGenIsRdy(PipeNetwork.Axis1 );
```

2.1.4.14.4.2 Ladder Diagram



2.1.4.14.4.3 Function Block Diagram



2.1.4.15 MLAxisGenPos Pipe Network

2.1.4.15.1 Description

Returns the generator position of the axis Returns TRUE if the internal generator axis is ready.

NOTE
 This function or function block returns cached data. See [Programming a Dual Core Controller](#) for more information.

2.1.4.15.2 Arguments

2.1.4.15.2.1 Input

ID	Description	ID Name of the Axis block
	Data type	DINT
	Range	—
	Unit	N/A
	Default	—

2.1.4.15.2.2 Output

Default (.Q)	Description	Returns true when function successfully executes
	Data type	BOOL
	Unit	N/A
Position	Description	Returns Axis generator position value
	Data type	LREAL
	Unit	User unit

2.1.4.15.3 Related Functions

- [MLAxisReadActPos](#)
- [MLAxisFBackPos](#)
- [MLAxisPipePos](#)
- [MLAxisCmdPos](#)
- [MLAxisWritePipPos](#)

2.1.4.15.4 Example

2.1.4.15.4.1 Structured Text

```
Axis1_Generator_Position := MLAxisGenPos(PipeNetwork.Axis1 ) ;
```

2.1.4.15.4.2 Ladder Diagram



2.1.4.15.4.3 Function Block Diagram



2.1.4.16 MLAxisGenReadAcc Pipe Network ✓

2.1.4.16.1 Description

Get the acceleration of the internal generator of an axis.

2.1.4.16.2 Arguments

2.1.4.16.2.1 Input

AxisID	Description	ID Name of the Axis block
	Data type	DINT
	Range	—
	Unit	N/A
	Default	—

2.1.4.16.2.2 Output

OK	Description	Returns true when function successfully executes
	Data type	BOOL
	Unit	N/A
Acceleration	Description	Returns Axis Acceleration value

Data type	LREAL
Unit	User unit/sec ²

2.1.4.16.3 Related Functions

[MLAxisGenReadDec](#)

[MLAxisGenReadSpd](#)

2.1.4.16.4 Example

2.1.4.16.4.1 Structured Text

```
Axis1_Acceleration := MLAxisGenReadAcc( PipeNetwork.Axis1 );
```

2.1.4.16.4.2 Ladder Diagram



2.1.4.16.4.3 Function Block Diagram



2.1.4.17 MLAxisGenReadDec Pipe Network ✓

2.1.4.17.1 Description

Get the Deceleration of the internal generator of an axis.

2.1.4.17.2 Arguments

2.1.4.17.2.1 Input

AxisID	Description	ID Name of the Axis block
	Data type	DINT
	Range	—
	Unit	N/A
	Default	—

2.1.4.17.2.2 Output

OK	Description	
	Data type	BOOL
	Unit	N/A
Deceleration	Description	Returns Axis Deceleration value
	Data type	LREAL
	Unit	User unit/sec ²

2.1.4.17.3 Related Functions

[MLAxisGenReadAcc](#)

[MLAxisGenReadSpd](#)

2.1.4.17.4 Example

2.1.4.17.4.1 Structured Text

```
Axis1_Deceleration := MLAxisGenReadDec ( PipeNetwork.Axis1 );
```

2.1.4.17.4.2 Ladder Diagram



2.1.4.17.4.3 Function Block Diagram

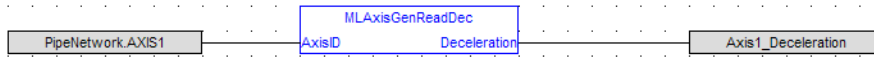

2.1.4.18 MLAxisGenReadSpd Pipe Network ✓

2.1.4.18.1 Description

Get the speed of the internal generator of an axis.

2.1.4.18.2 Arguments

2.1.4.18.2.1 Input

AxisID	Description	ID Name of the Axis block
	Data type	DINT
	Range	—
	Unit	N/A
	Default	—

2.1.4.18.2.2 Output

OK	Description	
	Data type	BOOL
	Unit	N/A
Speed	Description	Returns Axis Speed value
	Data type	LREAL
	Unit	User unit/sec

2.1.4.18.3 Related Functions

[MLAxisGenReadDec](#)

[MLAxisGenReadAcc](#)

2.1.4.18.4 Example

2.1.4.18.4.1 Structured Text

```
Axis1_Speed := MLAxisGenReadSpd( PipeNetwork.Axis1 ) ;
```

2.1.4.18.4.2 Ladder Diagram



2.1.4.18.4.3 Function Block Diagram



2.1.4.19 MLAxisGenWriteAcc

2.1.4.19.1 Description

Set the acceleration of the internal generator of an axis Returns TRUE if the internal generator axis is ready.

2.1.4.19.2 Arguments

2.1.4.19.2.1 Input

AxisID	Description	ID Name of the Axis block
	Data type	DINT
	Range	—
	Unit	N/A
	Default	—
Acceleration	Description	Sets the generator Acceleration value
	Data type	LREAL
	Range	—
	Unit	User unit/sec ²
	Default	—

2.1.4.19.2.2 Output

Default (.Q)	Description	Returns true when function successfully executes
	Data type	BOOL
	Unit	N/A

2.1.4.19.3 Related Functions

[MLAxisGenWriteDec](#)

[MLAxisGenWriteSpd](#)

2.1.4.19.4 Example

2.1.4.19.4.1 Structured Text

```
MLAxisGenWriteAcc(PipeNetwork.Axis1, 100000 ) ;
```

2.1.4.19.4.2 Ladder Diagram

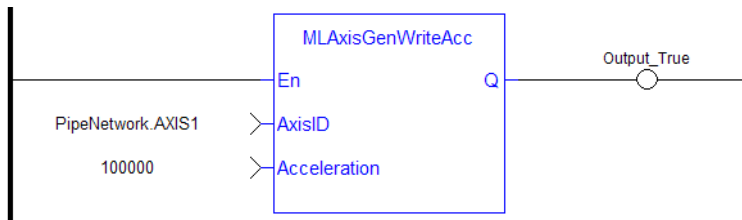

2.1.4.19.4.3 Function Block Diagram

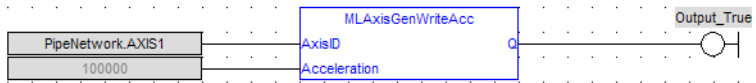

2.1.4.20 MLAxisGenWriteDec Pipe Network ✓

2.1.4.20.1 Description

Set the Deceleration of the internal generator of an axis Returns TRUE if the internal generator axis is ready.

2.1.4.20.2 Arguments

2.1.4.20.2.1 Input

AxisID	Description	ID Name of the Axis block.
	Data type	DINT
	Range	—
	Unit	N/A
	Default	—
Deceleration	Description	Sets the generator Deceleration value. The axis deceleration rate is limited such that the velocity cannot change by more than the value of the declared velocity limit in a single iteration. The Pipe Network Axis block uses the TRAVEL_SPEED parameter to scale this limit. The maximum deceleration is therefore affected by the Pipe Network Axis Block parameter "TRAVEL_SPEED", as well as the axis update rate.
	Data type	LREAL
	Range	—
	Unit	User unit/sec ²
	Default	—

2.1.4.20.2.2 Output

Default (.Q)	Description	Returns true when function successfully executes.
	Data type	BOOL

Unit	N/A
-------------	-----

2.1.4.20.3 Related Functions

[MLAxisGenWriteAcc](#)

[MLAxisGenWriteSpd](#)

2.1.4.20.4 Example

2.1.4.20.4.1 Structured Text

```
MLAxisGenWriteDec (PipeNetwork.Axis1, 100000 ) ;
```

2.1.4.20.4.2 Ladder Diagram

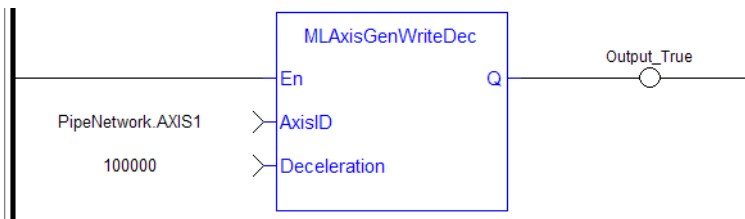

2.1.4.20.4.3 Function Block Diagram



2.1.4.21 MLAxisGenWriteSpd Pipe Network ✓

2.1.4.21.1 Description

Set the speed of the internal generator of an axis. Returns TRUE if the function succeeded. This function does not generate any motion.

2.1.4.21.2 Arguments

2.1.4.21.2.1 Input

AxisID	Description	ID Name of the Axis block
	Data type	DINT
	Range	—
	Unit	N/A
	Default	—
Speed	Description	Sets the generator Speed value
	Data type	LREAL
	Range	—
	Unit	User unit
	Default	—

2.1.4.21.2.2 Output

Default (.Q)	Description	Returns true when function successfully executes
	Data type	BOOL
	Unit	N/A

2.1.4.21.3 Related Functions

[MLAxisGenWriteAcc](#)

[MLAxisGenWriteDec](#)

2.1.4.21.4 Example

2.1.4.21.4.1 Structured Text

```
MLAxisGenWriteSpd(PipeNetwork.Axis1, 500 ) ;
```

2.1.4.21.4.2 Ladder Diagram

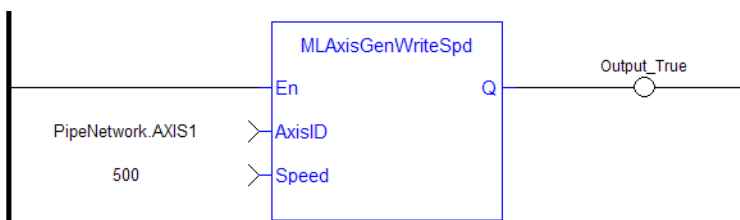

2.1.4.21.4.3 Function Block Diagram



2.1.4.22 MLAxisInit Pipe Network ✓

2.1.4.22.1 Description

Initializes an axis object. Returns TRUE if the function succeeded. The axis object can be mapped to servo or stepper drives.

2.1.4.22.2 Arguments

2.1.4.22.2.1 Input

AxisID	Description	ID Name of the Axis block
	Data type	DINT
	Range	—
	Unit	N/A
	Default	—

ModuloPosition	Description	Value of the period of a cyclic system expressed in user units. The parameter is defined to correctly manage the periodicity (modulo) of the input values.
	Data type	LREAL
	Range	—
	Unit	User unit
	Default	—
UserUnitPerTurn	Description	Define the unit which is equivalent to one revolution of the physical motor.
	Data type	LREAL
	Range	—
	Unit	N/A
	Default	—
FeedbackUnitPerTurn	Description	
	Data type	DINT
	Range	—
	Unit	N/A
	Default	—
Speed	Description	Sets the Axis Speed
	Data type	LREAL
	Range	—
	Unit	User unit
	Default	—
Acceleration	Description	Sets the Axis Acceleration value
	Data type	LREAL
	Range	—
	Unit	User unit/sec ²
	Default	—
Deceleration	Description	Sets the Axis Deceleration value
	Data type	LREAL
	Range	—
	Unit	User unit/sec ²
	Default	—

InitialPosition	Description	Initial position value expressed in user logical units. Used only at the pipe activation to initialize the position starting point
	Data type	LREAL
	Range	—
	Unit	User unit
	Default	—
Modulo	Description	Define the mode which can be Modulo (True) or not (False)
	Data type	BOOL
	Range	0, 1
	Unit	N/A
	Default	—

2.1.4.22.2.2 Output

Default (.Q)	Description	Returns true when function successfully executes
	Data type	BOOL
	Unit	N/A

2.1.4.22.3 Example

2.1.4.22.3.1 Structured Text

```
MLAxisInit( PipeNetwork.Axis1, 360.0, 360.0, SHL(1,20), 500.0, 100000.0,
100000.0, 0.0, true ) ;
```

2.1.4.22.3.2 Ladder Diagram

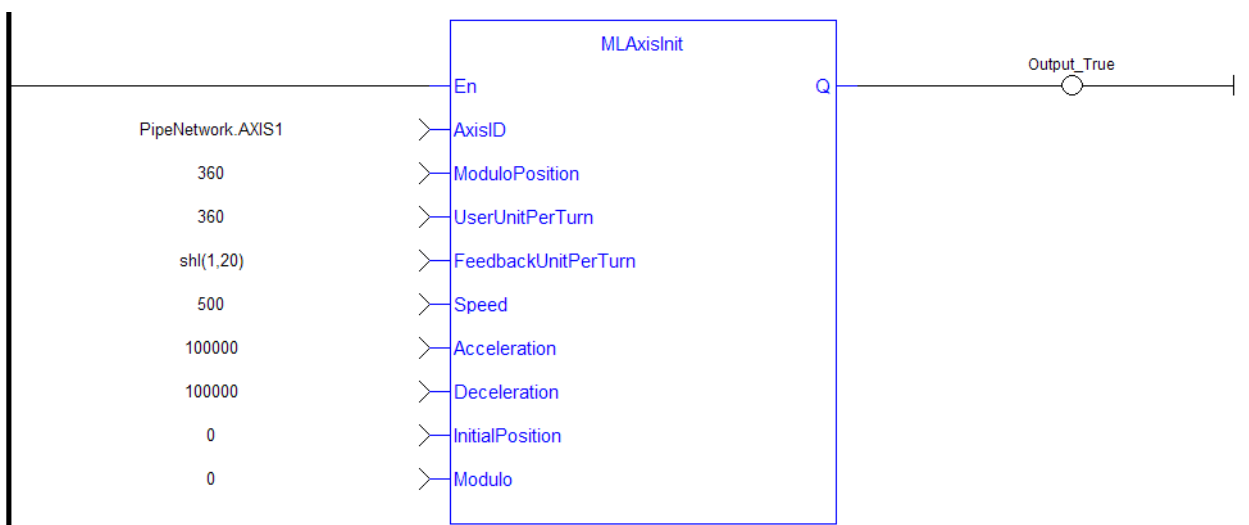

2.1.4.22.3.3 Function Block Diagram

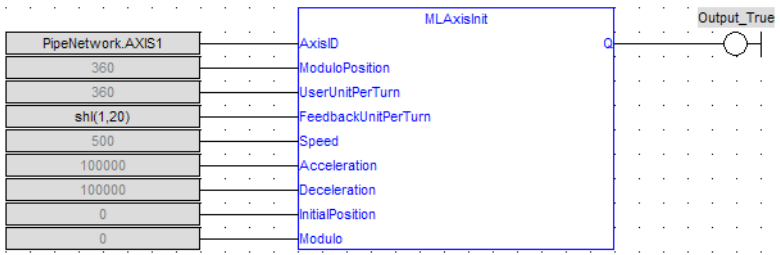

2.1.4.23 MLAxisIsCnctd Pipe Network ✓

2.1.4.23.1 Description

Check if a pipe is currently connected to the axis. Returns TRUE if a pipe is connected.

2.1.4.23.2 Arguments

2.1.4.23.2.1 Input

ID	Description	ID Name of the Axis block
	Data type	DINT
	Range	—
	Unit	N/A
	Default	—

2.1.4.23.2.2 Output

Default (.Q)	Description	Returns true when function successfully executes
	Data type	BOOL
	Unit	N/A

2.1.4.23.3 Example

2.1.4.23.3.1 Structured Text

```
MLAxisIsCnctd(PipeNetwork.Axis1 ) ;
```

2.1.4.23.3.2 Ladder Diagram

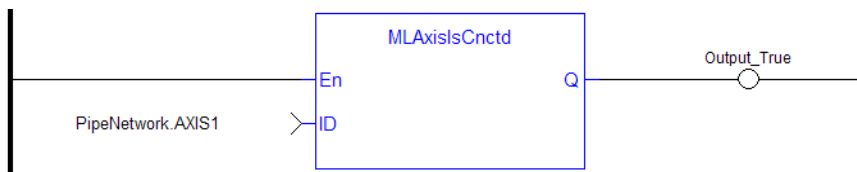

2.1.4.23.3.3 Function Block Diagram



2.1.4.24 MAxisTrigged Pipe Network

2.1.4.24.1 Description

Checks if the axis got a trigger event. Returns TRUE if the Fast Input event has been **triggered** and not yet been reset.

2.1.4.24.2 Arguments

2.1.4.24.2.1 Input

ID	Description	ID Name of the Axis block
	Data type	DINT
	Range	—
	Unit	N/A
	Default	—
InputID	Description	ID of the triggered Fast input of an axis (ie IN1 and IN2 on S300) . 0 = Touch Probe 1 / Capture Engine 0 1 = Touch Probe 2 / Capture Engine 1 Range is [0,1]
	Data type	DINT
	Range	—
	Unit	N/A
	Default	—
edge	Description	Configures the Inputs as 0= Disabled, 1=Rising Edge, 2=Falling edge
	Data type	DINT
	Range	—
	Unit	N/A
	Default	—

2.1.4.24.2.2 Output

Default (.Q)	Description	Returns true when function successfully executes.
	Data type	BOOL
	Unit	N/A

2.1.4.24.3 Related Functions

[MLAxisRstFastIn](#)

2.1.4.24.4 Example

2.1.4.24.4.1 Structured Text

```
MLAxisIsTriggered (PipeNetwork.Axis1, 0,1 ) ;
```

2.1.4.24.4.2 Ladder Diagram

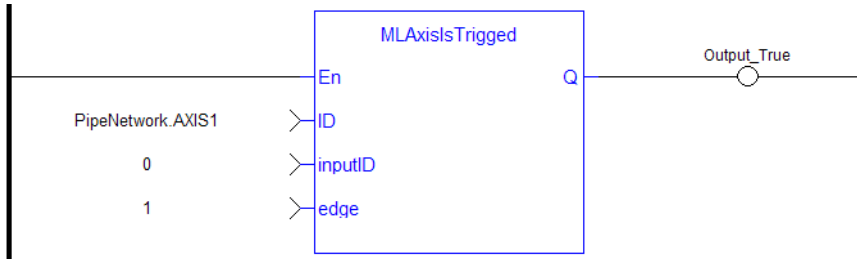

2.1.4.24.4.3 Function Block Diagram

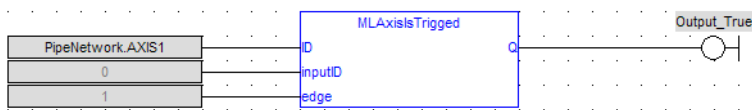

2.1.4.25 MLAxisMoveVel Pipe Network ✓

2.1.4.25.1 Description

Jog at the specified speed. Returns TRUE if the function succeeded.

2.1.4.25.2 Arguments

2.1.4.25.2.1 Input

ID	Description	ID Name of the Axis block.
	Data type	DINT
	Range	—
	Unit	N/A
	Default	—
Speed	Description	Sets the Axis Speed.
	Data type	LREAL
	Range	—
	Unit	User unit/sec
	Default	—

2.1.4.25.2.2 Output

Default (.Q)	Description	Returns true when function successfully executes, after the motion has reached jog speed.
	Data type	BOOL

Unit	N/A
-------------	-----

2.1.4.25.3 Related Functions

[MLAxisGenWriteSpd](#)

[MLAxisGenWriteDec](#)

[MLAxisGenWriteAcc](#)

2.1.4.25.4 Previous Function Name

MLAxisRun

2.1.4.25.5 Example

See [Usage Example of Axis Functions](#) for additional examples.

2.1.4.25.5.1 Structured Text

```
MLAxisMoveVel (PipeNetwork.Axis1, 500 ) ;
```

2.1.4.25.5.2 Ladder Diagram

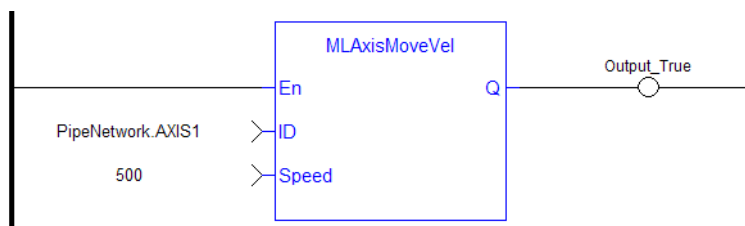

2.1.4.25.5.3 Function Block Diagram



2.1.4.26 MLAxisPipePos Pipe Network ✓

2.1.4.26.1 Description

Returns the pipe position of the axis.

NOTE
 This function or function block returns cached data. See [Programming a Dual Core Controller](#) for more information.

2.1.4.26.2 Arguments

2.1.4.26.2.1 Input

ID	Description	ID Name of the Axis block
	Data type	DINT
	Range	[-2147483648, 2147483648]

Unit	N/A
Default	—

2.1.4.26.2.2 Output

OK	Description	Returns true when function successfully executes
	Data type	BOOL
	Unit	N/A
Position	Description	
	Data type	LREAL
	Range	—
	Unit	User unit

2.1.4.26.3 Related Functions

- [MLAxisReadActPos](#)
- [MLAxisFBackPos](#)
- [MLAxisGenPos](#)
- [MLAxisCmdPos](#)
- [MLAxisWritePipPos](#)

2.1.4.26.4 Example

2.1.4.26.4.1 Structured Text

```
Axis1_Pipe_Position := MLAxisPipePos (PipeNetwork.Axis1 ) ;
```

2.1.4.26.4.2 Ladder Diagram



2.1.4.26.4.3 Function Block Diagram



2.1.4.27 MLAxisPower Pipe Network ✓

2.1.4.27.1 Description

Powers up or down the axis. Enables or disables a Servo drive or Stepper drive mapped to the axis.

When the axis is powered up, the **ReferencePosition** is modified to equal the **ActualPosition**. For that, KAS updates the **GeneratorPosition**.

⚠ IMPORTANT

Powering on an axis affects the position and motion state of an axis. `MLAxisPower` should not be called with the `On` input flag set to `True` while the axis is in motion.

2.1.4.27.2 Arguments

2.1.4.27.2.1 Input

ID	Description	ID Name of the Axis block
	Data type	DINT
	Range	—
	Unit	N/A
	Default	—
On	Description	Flag to power up (True) or down (False) the Axis
	Data type	BOOL
	Range	0, 1
	Unit	N/A
	Default	—

2.1.4.27.2.2 Output

Default (.Q)	Description	Returns true when function successfully executes
	Data type	BOOL
	Unit	N/A

2.1.4.27.3 Related Functions

[MLAxisPowerDOff](#)

2.1.4.27.4 Previous Function Name

MLAxisPowerOn

MLAxisPowerOff

2.1.4.27.5 Example

2.1.4.27.5.1 Structured Text

```
(* If Power_OnOff is TRUE then power in ON, otherwise OFF*)
MLAxisPower( PipeNetwork.Axis1, Power_OnOff) ;
```

2.1.4.27.5.2 Ladder Diagram

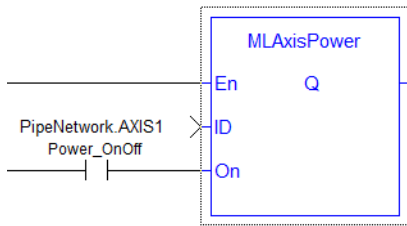

2.1.4.27.5.3 Function Block Diagram



2.1.4.28 MLAxisPowerDOff Pipe Network ✓

2.1.4.28.1 Description

This function has been deprecated.

2.1.4.29 MLAxisRatedTq Pipe Network ✓

2.1.4.29.1 Description

Allows conversion of drive torque values from rated torque units (1000 = rated motor continuous torque) to N.m (Newton meter).

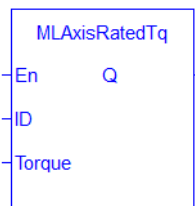

2.1.4.29.2 Arguments

2.1.4.29.2.1 Input

ID	Description	Pipe network identifier of the axis block
	Data type	DINT
	Range	—
	Unit	N/A
	Default	—

Torque	Description	<p>Actual torque applied by the drive associated to the axis</p> <p>Rated torque = Nominal Drive Current * Torque factor = DRV.ICONT * MOTOR.KT</p> <p><i>About SDO</i></p> <p>DRV.ICONT is obtained by SDO parameter: index 5083h (sub-index 0)</p> <p>MOTOR.KT is obtained by SDO parameter: index 3593h (sub-index 0)</p> <p>For more details, refer to:</p> <ul style="list-style-type: none"> • Communication SDOs • Manufacturer specific SDOs • Profile specific SDOs <p>To read/write an SDO object with an index greater than 16#7FFF (32767), the value must be entered in the form any_to_int(index # in hex format). For example any_to_int(16#8321).</p> <p>The actual units of DRV.ICONT and MOTOR.KT are 1/1000 of the actual values if obtained by SDO. So the formula, if using the SDO values, is:</p> <p>Rated Torque = Torque = (SDO(DRV.ICONT)/1000) * (SDO(MOTOR.KT)/1000)</p>
	Data type	LREAL
	Unit	N.m (Newton meter)

2.1.4.29.2.2 Output

Default (.Q)	Description	Returns true when function successfully executes
	Data type	BOOL
	Unit	N/A

2.1.4.29.3 Related Functions

[MLAxisReadTq](#)

2.1.4.29.4 Example

2.1.4.29.4.1 Structured Text

```
MLAxisRatedTq(PipeNetwork.Axis1, Axis1_Torque ) ;
```

2.1.4.29.4.2 Ladder Diagram

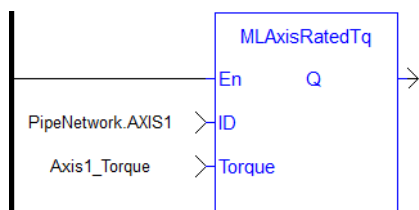

2.1.4.29.4.3 Function Block Diagram



2.1.4.30 MLAxisReadActPos Pipe Network ✓

2.1.4.30.1 Description

Returns the Actual Position of the axis

NOTE

This function or function block returns cached data. See [Programming a Dual Core Controller](#) for more information.

2.1.4.30.2 Arguments

2.1.4.30.2.1 Input

ID	Description	ID name of the Axis Block
	Data type	DINT
	Range	—
	Unit	N/A
	Default	—

2.1.4.30.2.2 Output

Default (.Q)	Description	Returns true when function successfully executes
	Data type	BOOL
	Unit	N/A
Position	Description	Returns the absolute position of the axis
	Data type	LREAL
	Unit	User unit

2.1.4.30.3 Related Functions

[MLAxisFBackPos](#)

[MLAxisGenPos](#)

[MLAxisPipePos](#)

[MLAxisCmdPos](#)

[MLAxisWritePipPos](#)

2.1.4.30.4 Previous Function Name

MLAxisActualPos

2.1.4.30.5 Example

2.1.4.30.5.1 Structured Text

```
Axis1_Position := MLAxisReadActPos( PipeNetwork.Axis1 ) ;
```

2.1.4.30.5.2 Ladder Diagram

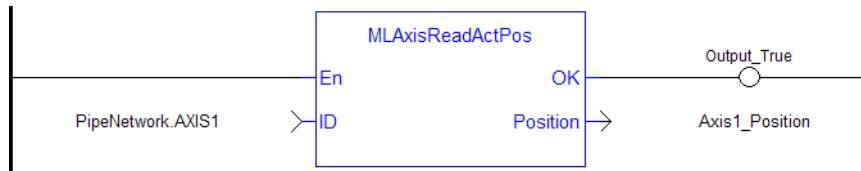

2.1.4.30.5.3 Function Block Diagram



2.1.4.31 MLAxisReadFBUnit Pipe Network ✓

2.1.4.31.1 Description

Get the feedback units per revolution value of the axis

2.1.4.31.2 Arguments

2.1.4.31.2.1 Input

AxisID	Description	ID Name of the Axis block
	Data type	DINT
	Range	—
	Unit	N/A
	Default	—

2.1.4.31.2.2 Output

OK	Description	Returns true when function successfully executes
	Data type	BOOL
	Unit	N/A
FBUnitsPerRev	Description	Returns the Axis Feedback Units per revolution
	Data type	LREAL
	Unit	N/A

2.1.4.31.3 Example

2.1.4.31.3.1 Structured Text

```
Axis1_Feedback_Units := MLAxisReadFBUnit( PipeNetwork.Axis1 ) ;
```

2.1.4.31.3.2 Ladder Diagram



2.1.4.31.3.3 Function Block Diagram

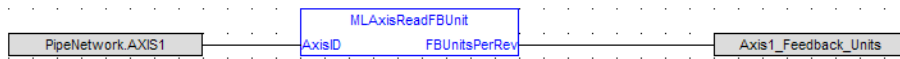

2.1.4.32 MLAxisReadFEUU Pipe Network ✓

2.1.4.32.1 Description

Return the difference between the reference position and the actual position of the drive mapped to the specified axis

2.1.4.32.2 Arguments

2.1.4.32.2.1 Input

ID	Description	Pipe network identifier of the axis block
	Data type	DINT
	Range	—
	Unit	N/A
	Default	—

2.1.4.32.2.2 Output

Error	Description	Difference between the reference position and the actual position of the drive associated to the axis
	Data type	LREAL
	Unit	User unit

2.1.4.32.3 Related Functions

[MLAxisReadActPos](#)

2.1.4.32.4 Example

2.1.4.32.4.1 Structured Text

```
Axis1_Error := MLAxisReadFEUU(PipeNetwork.Axis1) ;
```

2.1.4.32.4.2 Ladder Diagram

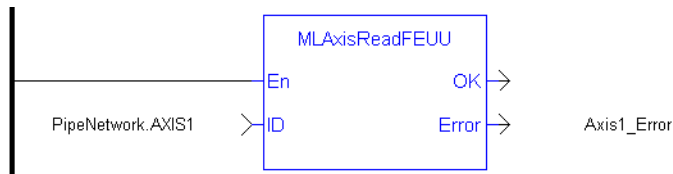

2.1.4.32.4.3 Function Block Diagram



2.1.4.33 MAxisReadGenStatus Pipe Network ✓

2.1.4.33.1 Description

Returns the status of the internal generator of the axis.

0	RUN mode (acceleration)
1	RUNNING or STOPPED
2	MOVE: Changing move destination
3	MOVE: Changing move destination
4	MOVE: Acceleration
5	MOVE: Constant speed (travel speed)
6	MOVE: Deceleration
7	MOVE: Single step (micro movement)

NOTE

This function or function block returns cached data. See [Programming a Dual Core Controller](#) for more information.

2.1.4.33.2 Arguments

2.1.4.33.2.1 Input

ID	Description	ID Name of the Axis block
	Data type	DINT
	Range	—
	Unit	N/A
	Default	—

2.1.4.33.2.2 Output

OK	Description	Returns true when function successfully executes
	Data type	BOOL
	Unit	N/A
Default (.Q)	Description	Shows the status of the internal generator based on the table at the top of this topic
	Data type	DINT

Unit	N/A
-------------	-----

2.1.4.33.3 Related Functions

[MLAxisGenIsRdy](#)

[MLAxisStatus](#)

2.1.4.33.4 Previous Function Name

MLAxisGenStatus

2.1.4.33.5 Example

2.1.4.33.5.1 Structured Text

```
MLAxisReadGenStatus (PipeNetwork.Axis1 ) ;
```

2.1.4.33.5.2 Ladder Diagram



2.1.4.33.5.3 Function Block Diagram



2.1.4.34 MLAxisReadModPos Pipe Network ✓

2.1.4.34.1 Description

Get the value period of the axis.

2.1.4.34.2 Arguments

2.1.4.34.2.1 Input

AxisID	Description	ID Name of the Axis block
	Data type	DINT
	Range	—
	Unit	N/A
	Default	—

2.1.4.34.2.2 Output

OK	Description	Returns true when function successfully executes
	Data type	BOOL
	Unit	N/A
ModuloPosition	Description	Returns the Axis Value Period

Data type	LREAL
Unit	User unit

2.1.4.34.3 Example

2.1.4.34.3.1 Structured Text

```
Axis1_Value_Period := MLAxisReadModPos (PipeNetwork.Axis1 ) ;
```

2.1.4.34.3.2 Ladder Diagram



2.1.4.34.3.3 Function Block Diagram



2.1.4.35 MLAxisReadTq Pipe Network ✓

2.1.4.35.1 Description

Return the actual torque applied by the drive which is mapped to the specified axis.



NOTE

This function or function block returns cached data. See [Programming a Dual Core Controller](#) for more information.

2.1.4.35.2 Arguments

2.1.4.35.2.1 Input

ID	Description	Pipe network identifier of the axis block
	Data type	DINT
	Range	—
	Unit	N/A
	Default	—

2.1.4.35.2.2 Output

Torque	Description	Actual torque applied by the drive associated to the axis in N.m (Newton meter). If you have not previously invoked the MLAxisRatedTq function, the Output value is rated motor continuous torque (where 1000.0 = rated torque)
	Data type	LREAL
	Unit	N.m (Newton meter)

2.1.4.35.3 Related Functions

[MLAxisRatedTq](#)

[MLAxisReadActPos](#)

[MLAxisReadVel](#)

2.1.4.35.4 Example

2.1.4.35.4.1 Structured Text

```
Axis1_Torque := MLAxisReadTq(PipeNetwork.Axis1 ) ;
```

2.1.4.35.4.2 Ladder Diagram

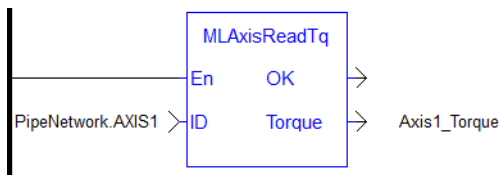

2.1.4.35.4.3 Function Block Diagram



2.1.4.36 MLAxisReadUUnits Pipe Network ✓

2.1.4.36.1 Description

Get the User units per revolution value of the axis.

2.1.4.36.2 Arguments

2.1.4.36.2.1 Input

AxisID	Description	ID Name of the Axis block.
	Data type	DINT
	Range	—
	Unit	N/A
	Default	—

2.1.4.36.2.2 Output

OK	Description	Returns true when function successfully executes.
-----------	--------------------	---

	Data type	BOOL
	Unit	N/A
UserUnitsPerRev	Description	Returns the Axis User Units per revolution.
	Data type	LREAL
	Unit	N/A

2.1.4.36.3 Example

2.1.4.36.3.1 Structured Text

```
Axis1_User_Units := MAxisReadUUnits (PipeNetwork.Axis1 ) ;
```

2.1.4.36.3.2 Ladder Diagram



2.1.4.36.3.3 Function Block Diagram



2.1.4.37 MAxisReadVel Pipe Network ✓

2.1.4.37.1 Description

Return the actual velocity of the axis, based on the data provided by the drive's feedback device.

AKD, S300, S700 drives: The actual velocity is calculated internally by the drive. The 'Velocity Actual Value' object (CoE object 0x606C, subindex 0) must be included in the drive's Input (Tx) PDO data for the controller to read the axis actual velocity from the drives. This can be added via the [PDO Editor Tab](#). The 'Velocity Actual Value' object is included by default in the AKD PDOs 0x1B20, 0x1B22, and 0x1B23.

NOTE
 This function or function block returns cached data. See [Programming a Dual Core Controller](#) for more information.

2.1.4.37.2 Arguments

2.1.4.37.2.1 Input

ID	Description	Pipe network identifier of the axis block.
	Data type	DINT
	Range	—
	Unit	N/A

Default	—
----------------	---

2.1.4.37.2.2 Output

Velocity	Description	The actual velocity of the axis.
	Data type	LREAL
	Unit	User unit/sec

2.1.4.37.3 Related Functions

[MLAxisReadActPos](#)

[MLAxisReadTq](#)

2.1.4.37.4 Example

2.1.4.37.4.1 Structured Text

```
Axis1_Velocity := MLAxisReadVel(PipeNetwork.Axis1 ) ;
```

2.1.4.37.4.2 Ladder Diagram

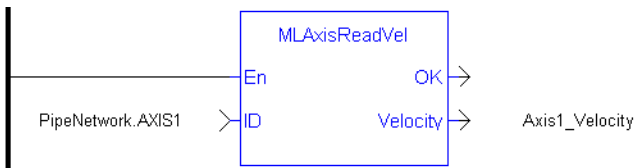

2.1.4.37.4.3 Function Block Diagram



2.1.4.38 MLAxisReAlignRdy Pipe Network ✓

2.1.4.38.1 Description

Check if an axis is ready. Returns TRUE if the internal realignment axis is ready.

NOTE

This function or function block returns cached data. See [Programming a Dual Core Controller](#) for more information.

2.1.4.38.2 Arguments

2.1.4.38.2.1 Input

ID	Description	ID Name of the Axis block.
	Data type	DINT
	Range	—
	Unit	N/A
	Default	—

2.1.4.38.2.2 Output

Default (.Q)	Description	Returns true when function successfully executes.
	Data type	BOOL
	Unit	N/A

2.1.4.38.3 Related Functions

[MLAxisReAlign](#)

2.1.4.38.4 Example

2.1.4.38.4.1 Structured Text

```
MLAxisReAlgnRdy(PipeNetwork.Axis1 ) ;
```

2.1.4.38.4.2 Ladder Diagram

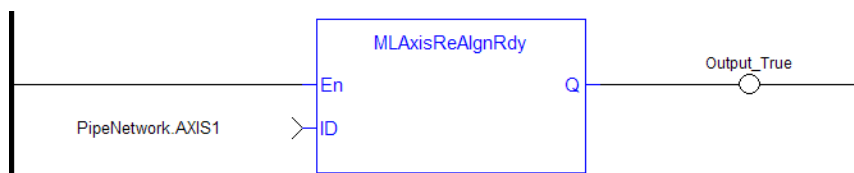

2.1.4.38.4.3 Function Block Diagram



2.1.4.39 MLAxisReAlign Pipe Network ✓

2.1.4.39.1 Description

When stopping the drive a motion profile is applied to decelerate. During the deceleration, the Reference position changes. Calling MLAxisReAlign realigns the actual position with the reference position by moving the axis by the specified delta position, which is typically calculated by the application code. After a [MLAxisStop](#) is executed, a MLAxisReAlign is required for the Pipe Position to be used again.

The function returns TRUE if it succeeds.

NOTE

The realign function do not work properly if the [MLAxisStop](#) function is continuously executed via its Start input

2.1.4.39.2 Arguments

2.1.4.39.2.1 Input

ID	Description	ID Name of the Axis block.
	Data type	DINT
	Range	—
	Unit	N/A

	Default	—
Acceleration	Description	Sets the Realign Acceleration.
	Data type	LREAL
	Range	—
	Unit	User unit/sec ²
	Default	—
Deceleration	Description	Sets the Realign Deceleration rate.
	Data type	LREAL
	Range	—
	Unit	User unit/sec ²
	Default	—
Speed	Description	Sets the Axis Speed.
	Data type	LREAL
	Range	—
	Unit	User unit/sec
	Default	—
DeltaPos	Description	Sets the Axis Delta Position, or the relative distance to be moved.
	Data type	LREAL
	Range	—
	Unit	User unit
	Default	—

2.1.4.39.2.2 Output

Default (.Q)	Description	Returns true when function successfully executes.
	Data type	BOOL
	Unit	N/A

2.1.4.39.3 Related Functions

[MLAxisReAlgnRdy](#)

2.1.4.39.4 Example

2.1.4.39.4.1 Structured Text

```
MLAxisReAlign(PipeNetwork.Axis1, 100000, 100000, 500, 20 ) ;
```

2.1.4.39.4.2 Ladder Diagram

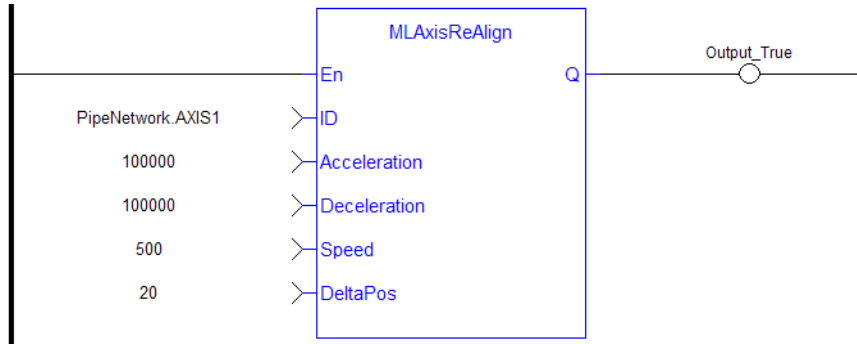

2.1.4.39.4.3 Function Block Diagram

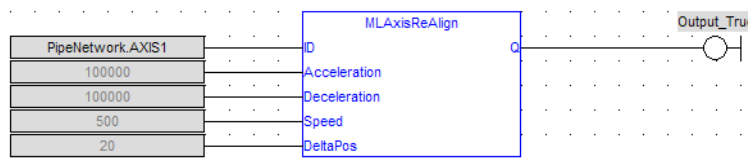

2.1.4.40 MLAxisRel Pipe Network ✓

2.1.4.40.1 Description

A selected Axis performs a move for a specified distance relative to the current position. The DeltaPosition input is signed so that the move can be in the positive or negative direction, and the Axis moves this distance in user units. The travel speed, acceleration, deceleration, and User Units of the move are values inherited from the selected Axis. The default settings are entered when an Axis is created and initiated, and can be changed with other MLAxis commands such as [MLAxisGenWriteSpd](#), [MLAxisGenWriteAcc](#), and [MLAxisWriteUUnits](#).

NOTE

If you wish to know when a move has completed, we recommend using [MLAxisGenIsRdy](#). The output of MLAxisRel can occur before moves have finished.

2.1.4.40.2 Arguments

2.1.4.40.2.1 Input

ID	Description	ID Name of the Axis block.
	Data type	DINT
	Range	—
	Unit	N/A
	Default	—
DeltaPosition	Description	Sets the Axis Delta Position, or the relative distance to be moved.

Data type	LREAL
Range	—
Unit	User unit
Default	—

2.1.4.40.2.2 Output

Default (.Q)	Description	Returns true when function successfully executes. This occurs immediately after the function is called; the function does not wait for the motion profile to be completed.
	Data type	BOOL
	Unit	N/A

2.1.4.40.3 Related Functions

- [MLAxisGenWriteAcc](#)
- [MLAxisGenWriteDec](#)
- [MLAxisGenWriteSpd](#)

2.1.4.40.4 Example

See [Usage Example of Axis Functions](#) for additional examples.

2.1.4.40.4.1 Structured Text

```
MLAxisRel (PipeNetwork.Axis1, 2500 ) ;
```

2.1.4.40.4.2 Ladder Diagram

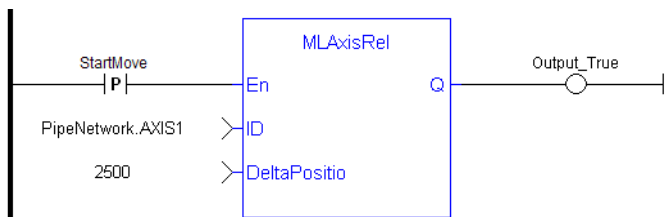

NOTE

You must use a [pulse contact](#) to start the FB

2.1.4.40.4.3 Function Block Diagram



2.1.4.41 MLAxisResetErrors Pipe Network ✓

2.1.4.41.1 Description

Clears errors of the specified axis

2.1.4.41.2 Arguments

2.1.4.41.2.1 Input

ID	Description	ID name of the Axis Block.
	Data type	DINT
	Range	—
	Unit	N/A
	Default	—

2.1.4.41.2.2 Output

Default (.Q)	Description	Returns true when function successfully executes.
	Data type	BOOL
	Unit	N/A

2.1.4.41.3 Previous Function Name

MLAxisClrErrors

2.1.4.41.4 Example

2.1.4.41.4.1 Structured Text

```
MLAxisResetErrors ( PipeNetwork.Axis1 ) ;
```

2.1.4.41.4.2 Ladder Diagram

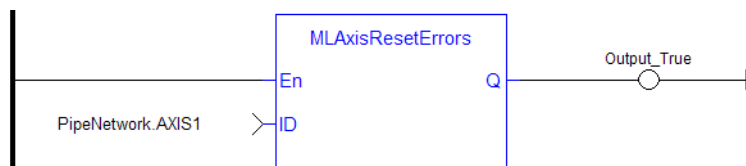

2.1.4.41.4.3 Function Block Diagram



2.1.4.42 MLAxisRstFastIn Pipe Network ✓

2.1.4.42.1 Description

Write in the Latch Control Word to reset the Fast Input.

2.1.4.42.2 Arguments

2.1.4.42.2.1 Input

AxisID	Description	ID Name of the Axis block.
---------------	--------------------	----------------------------

	Data type	DINT
	Range	—
	Unit	N/A
	Default	—
InputID	Description	ID name of the Fast input to be reset on an axis, (ie IN1 and IN2 on S300). 0 = Touch Probe 1 / Capture Engine 0 1 = Touch Probe 2 / Capture Engine 1 Range is [0,1]
	Data type	DINT
	Range	—
	Unit	N/A
	Default	—

2.1.4.42.2.2 Output

Default (.Q)	Description	Returns true when function successfully executes.
	Data type	BOOL
	Unit	N/A

2.1.4.42.3 Related Functions

[MLAxisCfgFastIn](#)

[MLAxisIsTriggered](#)

2.1.4.42.4 Example

2.1.4.42.4.1 Structured Text

```
MLAxisRstFastIn(PipeNetwork.Axis1, 0 ) ;
```

2.1.4.42.4.2 Ladder Diagram



2.1.4.42.4.3 Function Block Diagram

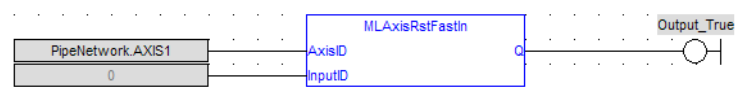

2.1.4.43 MLAxisStatus Pipe Network ✓

2.1.4.43.1 Description

Returns the status of the axis.

NOTE

This function or function block returns cached data. See [Programming a Dual Core Controller](#) for more information.

2.1.4.43.2 Arguments

2.1.4.43.2.1 Input

ID	Description	ID Name of the Axis block.
	Data type	DINT
	Range	—
	Unit	N/A
	Default	—

2.1.4.43.2.2 Output

OK	Description	Returns true when function successfully executes.
	Data type	BOOL
	Unit	N/A

Default (.Q)	Description	Returns the status of the axis																												
		<table border="1"> <thead> <tr> <th>Bit</th> <th>Description</th> </tr> </thead> <tbody> <tr> <td>0</td> <td>Initialized (1 if initialized)</td> </tr> <tr> <td>1</td> <td>Power (1 if power is on) Is linked to bit 1 (Switched on) of the Status Word For more information on the status machine</td> </tr> <tr> <td>2</td> <td>Enabled (1 if enabled) Is linked to bit 0 (Ready to switch on) of the Status Word</td> </tr> <tr> <td>3</td> <td>Found (1 if found on the network). EtherCAT state is Pre-Operational, see EtherCAT State Machine.</td> </tr> <tr> <td>4</td> <td>Configured (1 if configured) EtherCAT state is Safe-Operational, see EtherCAT State Machine.</td> </tr> <tr> <td>5</td> <td>Running (1 if running) EtherCAT state is Operational, see EtherCAT State Machine.</td> </tr> <tr> <td>6</td> <td>Error (1 if in error)</td> </tr> <tr> <td>7</td> <td>Simulated (1 if working with a simulated axis)</td> </tr> <tr> <td>8</td> <td>Connected (1 if a pipe is connected)</td> </tr> <tr> <td>9</td> <td>Warning (1 if the drive signals a warning)</td> </tr> <tr> <td>10</td> <td>Stopping (1 if the drive is performing a Stop)</td> </tr> <tr> <td>11</td> <td>Stopped (1 if the drive has finished the Stop)</td> </tr> <tr> <td>12 to 31</td> <td>Reserved</td> </tr> </tbody> </table>	Bit	Description	0	Initialized (1 if initialized)	1	Power (1 if power is on) Is linked to bit 1 (Switched on) of the Status Word For more information on the status machine	2	Enabled (1 if enabled) Is linked to bit 0 (Ready to switch on) of the Status Word	3	Found (1 if found on the network). EtherCAT state is Pre-Operational, see EtherCAT State Machine .	4	Configured (1 if configured) EtherCAT state is Safe-Operational, see EtherCAT State Machine .	5	Running (1 if running) EtherCAT state is Operational, see EtherCAT State Machine .	6	Error (1 if in error)	7	Simulated (1 if working with a simulated axis)	8	Connected (1 if a pipe is connected)	9	Warning (1 if the drive signals a warning)	10	Stopping (1 if the drive is performing a Stop)	11	Stopped (1 if the drive has finished the Stop)	12 to 31	Reserved
Bit	Description																													
0	Initialized (1 if initialized)																													
1	Power (1 if power is on) Is linked to bit 1 (Switched on) of the Status Word For more information on the status machine																													
2	Enabled (1 if enabled) Is linked to bit 0 (Ready to switch on) of the Status Word																													
3	Found (1 if found on the network). EtherCAT state is Pre-Operational, see EtherCAT State Machine .																													
4	Configured (1 if configured) EtherCAT state is Safe-Operational, see EtherCAT State Machine .																													
5	Running (1 if running) EtherCAT state is Operational, see EtherCAT State Machine .																													
6	Error (1 if in error)																													
7	Simulated (1 if working with a simulated axis)																													
8	Connected (1 if a pipe is connected)																													
9	Warning (1 if the drive signals a warning)																													
10	Stopping (1 if the drive is performing a Stop)																													
11	Stopped (1 if the drive has finished the Stop)																													
12 to 31	Reserved																													
	Data type	DINT																												
	Unit	N/A																												

2.1.4.43.3 Example

2.1.4.43.3.1 Structured Text

```
AxisStatus := MAxisStatus(PipeNetwork.AXI_A1_Axis) ;
IF AxisStatus.11 THEN
    MAxisStop(PipeNetwork.AXI_A1_Axis, FALSE, DEF_A1_StopDec) ;
END_IF;
```

```
AxisStatus := MAxisStatus(PipeNetwork.AXI_A1);
If AxisStatus.0 Then
    (*Axis is initialized*)
ElsIf AxisStatus.1 Then
    (*Axis' power is ON*)
ElsIf AxisStatus.2 Then
    (*Axis is READY to be enabled*)
End_If;
```

2.1.4.43.3.2 Ladder Diagram

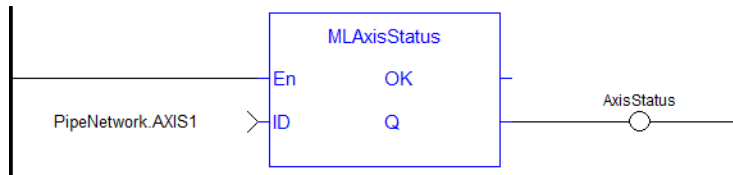

2.1.4.43.3.3 Function Block Diagram



2.1.4.44 MLAxisStop Pipe Network ✓

2.1.4.44.1 Description

Stop with the specified deceleration.

After stopping the drive, you need to restart the motion by realigning the actual position with the reference position.

The purpose of the MLAxisStop Command is not to remove the input source, but to stop the drive from continuing to move.

When the stop occurs, the master keeps moving and the axis starts ignoring the Pipe Position value and begins a controlled stop based on the input parameters. Also at that point, any Axis Block level profile (issued from FB like MLAxisAbs, MLAxisRel...) are aborted. When the stop is complete, it is up to the application to decide how to move the axis, master, or both to a position where they can be realigned, and the master restarted.

The [realign](#) function is used to move the axis to a restart position in order to enable synchronized machine motion to start again. Once the realign function is successfully completed, the Pipe Position is again summed with the Generator Position to create the Reference Position.

NOTE

This function or function block returns cached data. See [Programming a Dual Core Controller](#) for more information.

2.1.4.44.2 Arguments

2.1.4.44.2.1 Input

ID	Description	ID Name of the Axis block.
	Data type	DINT
	Range	—
	Unit	N/A
	Default	—
Start	Description	
	Data type	BOOL
	Range	0, 1
	Unit	N/A

	Default	—
Deceleration	Description	
	Data type	LREAL
	Range	—
	Unit	User unit/sec ²
	Default	—

2.1.4.44.2.2 Output

Default (.Q)	Description	Comes true when the Axis is completely stopped.
	Data type	BOOL
	Unit	N/A
PipePos	Description	Corresponds to the Pipe Position input to the axis at the time the stop is triggered.
	Data type	LREAL
	Unit	User unit
GenPos	Description	Corresponds to the Generator Position input to the axis at the time the stop is triggered.
	Data type	LREAL
	Unit	User unit
RealignPos	Description	Realign Position is the Reference Position at which the stop is triggered. The Realign Position is obtained by converting the last value sent to the drive from drive interface units into user units. The Realign Position is useful if you want to return to the point at which the trajectory was abandoned, or in case you need to realign the master to the slave.
	Data type	LREAL
	Unit	User unit
StopPos	Description	Corresponds to the last Reference Position sent to the drive at the time when the Axis is completely stopped. It is functionally different than the Actual Position because that position is the drive position converted to user units. The correct delta for the realign move to get in sync with the trajectory in order to realign the slave to the master is the current Reference Position minus the Stop Position for the realign move. After stopping, if the axis is disabled and the motor position is manually altered, this distance must be taken into account when performing the realign.
	Data type	LREAL
	Unit	User unit

2.1.4.44.3 Related Functions

MLAxisReAlign

2.1.4.44.4 Example

2.1.4.44.4.1 Structured Text

```

Inst_MLAxisStop(PipeNetwork.AXIS1, bStop, 200000);
If Inst_MLAxisStop.Done Then
  Axis1_PipePosition      := Inst_MLAxisStop.PipePos;
  Axis1_GeneratorPosition := Inst_MLAxisStop.GenPos;
  Axis1_RealignPosition   := Inst_MLAxisStop.RealignPos;
  Axis1_StopPosition      := Inst_MLAxisStop.StopPos;
End_if;
    
```

2.1.4.44.4.2 Ladder Diagram

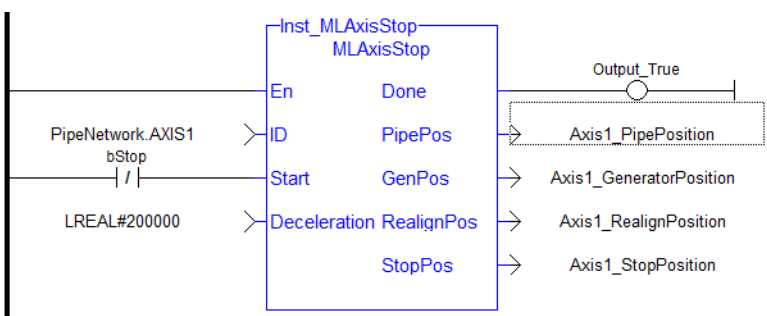

2.1.4.44.4.3 Function Block Diagram



2.1.4.45 MLAxisTimeStamp Pipe Network ✓

2.1.4.45.1 Description

Returns the timestamp of the triggered axis.

NOTE
 This function or function block returns cached data. See [Programming a Dual Core Controller](#) for more information.

2.1.4.45.2 Arguments

2.1.4.45.2.1 Input

En	Description	Enables execution
	Data type	BOOL
	Unit	N/A
	Default	—

ID	Description	ID Name of the Axis block.
	Data type	DINT
	Range	—
	Unit	N/A
	Default	—
InputID	Description	ID of the triggered Fast input of an axis, 0=first , 1=second (ie IN1 and IN2 on S300).
	Data type	DINT
	Range	[0, 1]
	Unit	N/A
	Default	—
edge	Description	Configures the Inputs as 0= Disabled, 1=Rising Edge, 2=Falling edge
	Data type	DINT
	Range	[0, 2]
	Unit	N/A
	Default	—

2.1.4.45.2.2 Output

OK	Description	Returns true when function successfully executes.
	Data type	BOOL
	Unit	N/A
Q	Description	Returns the time stamp value. This value is explained in How To Interpret a Timestamp .
	Data type	DINT
	Unit	microseconds

2.1.4.45.3 Related Functions

[MLAxisCfgFastIn](#)

[MLAxisRstFastIn](#)

[MLAxisIsTriggered](#)

2.1.4.45.4 Example

2.1.4.45.4.1 Structured Text

```
MLAxisTimeStamp(PipeNetwork.Axis1, 0, 1) ;
```

2.1.4.45.4.2 Ladder Diagram

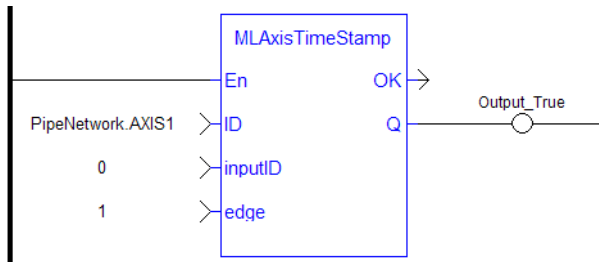

2.1.4.45.4.3 Function Block Diagram



2.1.4.46 MLAxisWriteModPos Pipe Network ✓

2.1.4.46.1 Description

Set the value period of the axis. Returns TRUE if the function succeeded.

2.1.4.46.2 Arguments

2.1.4.46.2.1 Input

AxisID	Description	ID Name of the Axis block
	Data type	DINT
	Range	—
	Unit	N/A
	Default	—
ModuloPosition	Description	Sets the Axis Period Value when Mode is set to Modulo.
	Data type	LREAL
	Range	—
	Unit	User unit
	Default	—

2.1.4.46.2.2 Output

Default (.Q)	Description	Returns true when function successfully executes
	Data type	BOOL
	Unit	N/A

2.1.4.46.3 Example

2.1.4.46.3.1 Structured Text

```
MLAxisWriteModPos (PipeNetwork.Axis1, 360) ) ;
```

2.1.4.46.3.2 Ladder Diagram



2.1.4.46.3.3 Function Block Diagram



2.1.4.47 MLAxisWritePipPos Pipe Network ✓

2.1.4.47.1 Description

Force the pipe position internal value. This function is working only when no pipe is connected.

2.1.4.47.2 Arguments

2.1.4.47.2.1 Input

AxisID	Description	ID Name of the Axis block.
	Data type	DINT
	Range	—
	Unit	N/A
	Default	—
PipePosition	Description	Sets the Axis Pipe Position.
	Data type	LREAL
	Range	—
	Unit	User unit
	Default	—

2.1.4.47.2.2 Output

Default (.Q)	Description	Returns true when function successfully executes
	Data type	BOOL
	Unit	N/A

2.1.4.47.3 Related Functions

- [MLAxisReadActPos](#)
- [MLAxisFBackPos](#)
- [MLAxisGenPos](#)
- [MLAxisPipePos](#)
- [MLAxisCmdPos](#)

2.1.4.47.4 Example

2.1.4.47.4.1 Structured Text

```
MLAxisWritePipPos (PipeNetwork.Axis1, 3000 ) ;
```

2.1.4.47.4.2 Ladder Diagram

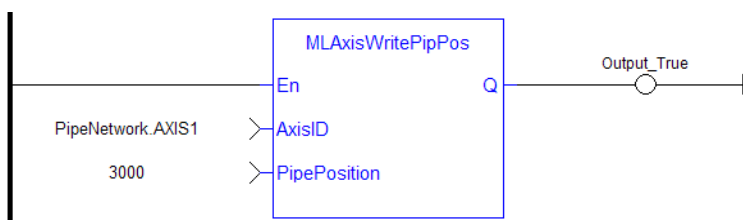

2.1.4.47.4.3 Function Block Diagram

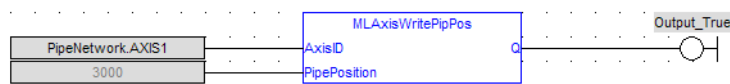

2.1.4.48 MLAxisWritePos Pipe Network ✓

2.1.4.48.1 Description

Sets a new value to an axis' current location. After this function is called, the axis' current location will have a value equal to the **Position** argument.

About associated data on Positions

The following data are illustrated in the figure below.

NOTE	
All positions are in user units with modulo applied if active, unless specified.	
Position / Offset	Description
Actual Position	Actual Position refers to the actual position of the underlying axis as reported by the drive. It is the sum of the feedback value (Position actual value) returned from the communication link to the drive and any zero-offset due to an MLWritePos function block (MLAxisWritePipPos , MLAxisWritePos).
$\text{ActualPos} := \text{FeedbackPos} + \text{ZeroOffset}$	
Feedback Position	Feedback Position is the current position the drive reports for an axis, scaled to user units. It does not take into account the value of the Zero Offset or axis modulo.

Position / Offset	Description
Generator Position	Generator Position is the summation of all previous commands (i.e. calls to functions which perform motion such as MLAxisAbs , MLAxisMoveVel , and MLAxisRel) to the Axis internal motion generator. It is modified by MLAxisWritePos in order to insure no jumps in the Reference Position command. It also accumulates changes in pipe position due to activate and deactivation of the pipe the Axis block is associated with.
Pipe Position	The output of the convertor block is written into the Pipe Position value whenever the Convertor block is connected to the axis and the pipe is active.
Reference Position	Reference Position is the commanded axis position sent to the drive. It is the summation of Pipe Position and Generator Position .
$\text{ReferencePosition} = \text{Pipe Position} + \text{Generator Position}$	
Zero Offset	The Zero Offset adjusts the coordinate system so that the Actual Position reports correct values after homing or using MLAxisWritePos .

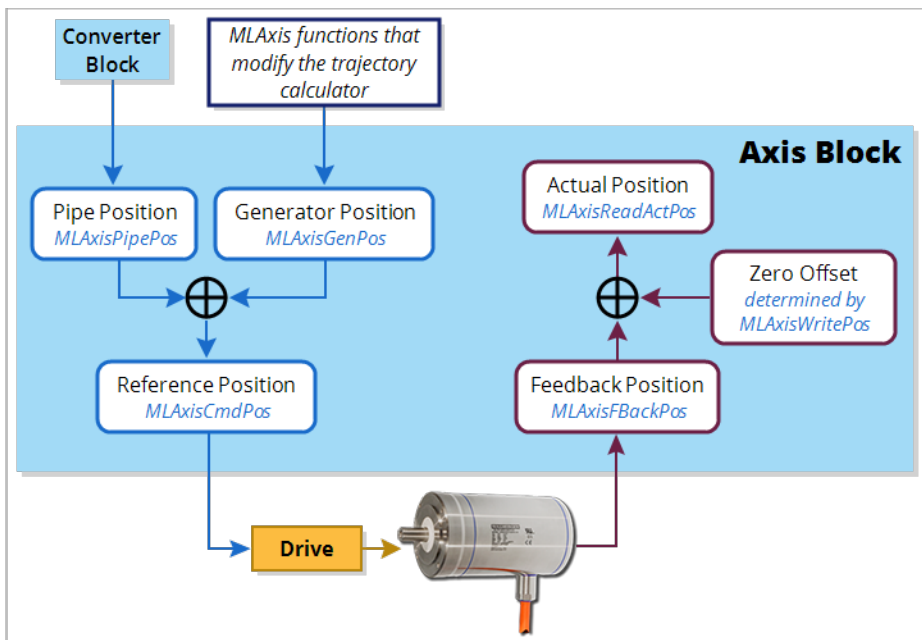

2.1.4.48.2 Arguments

2.1.4.48.2.1 Input

ID	Description	ID Name of the Axis block.
	Data type	DINT
	Range	—
	Unit	N/A
	Default	—
Position	Description	The new value for the axis' current location.
	Data type	LREAL

Range	—
Unit	User unit
Default	—

2.1.4.48.2.2 Output

Default (.Q)	Description	Returns true when function successfully executes.
	Data type	BOOL
	Unit	N/A

2.1.4.48.3 Previous Function Name

MLAxisSetZero

2.1.4.48.4 Example

2.1.4.48.4.1 Structured Text

```
MLAxisWritePos(PipeNetwork.Axis1, 0) ;
```

2.1.4.48.4.2 Ladder Diagram



2.1.4.48.4.3 Function Block Diagram



2.1.4.49 MLAxisWriteUUnits Pipe Network ✓

2.1.4.49.1 Description

Set the user units per revolution value of the axis. Returns TRUE if the function succeeded. User units are user-defined position units used within the KAS application. Selected units must be as natural as possible and must make sense for the machine. It must be related to the final moving object (e.g. the driven belt rather than the axis shaft). The same unit must be used for all related axes for simplicity reasons. Speeds are defined in [user units / second] and accelerations in [user units / second²].

2.1.4.49.2 Arguments

2.1.4.49.2.1 Input

AxisID	Description	ID Name of the Axis block.
	Data type	DINT
	Range	—

Unit	N/A
Default	—

2.1.4.49.2.2 Output

Default (.Q)	Description	Returns true when function successfully executes.
	Data type	BOOL
	Unit	N/A
UserUnitsPerRev	Description	Sets the Axis User Units per revolution.
	Data type	LREAL
	Unit	N/A

2.1.4.49.3 Example

2.1.4.49.3.1 Structured Text

```
MLAxisWriteUUnits (PipeNetwork.Axis1, 360 ) ;
```

2.1.4.49.3.2 Ladder Diagram

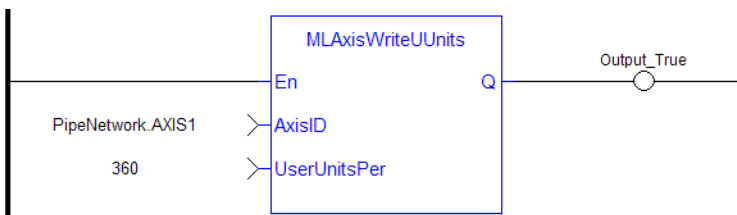

2.1.4.49.3.3 Function Block Diagram



2.1.4.50 MLPNAxisCreate Pipe Network ✓

2.1.4.50.1 Description

Creates a new axis object. Returns the ID of the newly created axis object or 0 if the function failed.

TIP

This function should be called after [MLMotionInit](#) is called and before [MLMotionStart](#) is called.



2.1.4.50.2 Arguments

2.1.4.50.2.1 Input

Name	Description	Name of the created Axis.
	Data type	STRING
	Range	—
	Unit	N/A
	Default	—
DriverName	Description	Is the Motion bus driver name or Simulated.
	Data type	STRING
	Range	—
	Unit	N/A
	Default	—
DriveAxisNumber	Description	This one-based number specifies the axis on the drive. For a single-axis drive, this number should be 1.
	Data type	UINT
	Range	[1,256]
	Unit	N/A
	Default	—
Address	Description	Axis motion bus address
	Data type	DINT
	Range	—
	Unit	N/A
	Default	—

2.1.4.50.2.2 Output

OK	Description	Returns true when function successfully executes.
	Data type	BOOL
	Unit	N/A

2.1.4.50.3 Example

2.1.4.50.3.1 Structured Text

```
PipeNetwork.AXIS1 := MLPNAxisCreate('AXIS1', 'SercosDriver', 0, 1001);
```

2.1.4.50.3.2 Ladder Diagram



2.1.4.50.3.3 Function Block Diagram

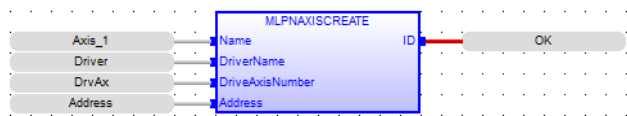

2.1.4.51 Usage Example of Axis Functions

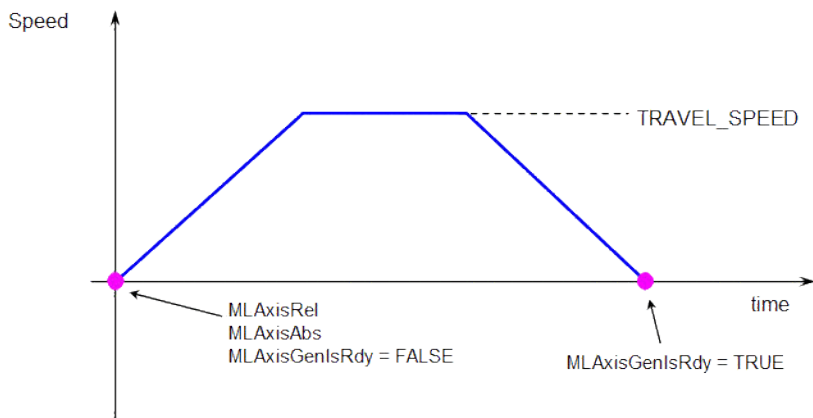

MLAxisMoveVel(Speed) starts to run the axis. Then **MLAxisGenIsRdy** returns TRUE when the Speed is reached.

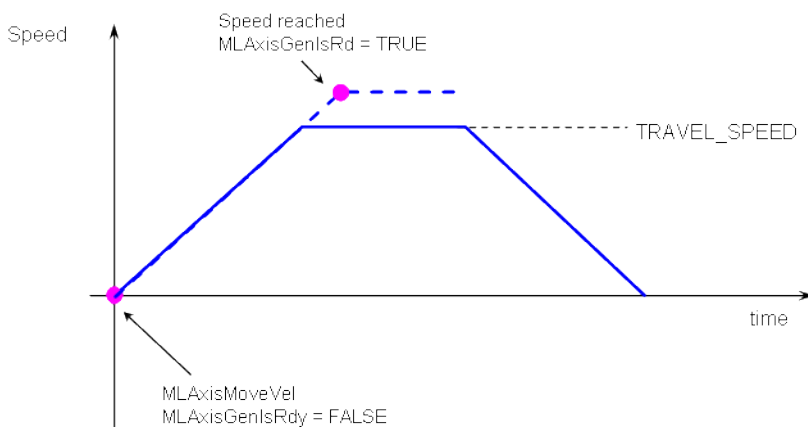

MLAxisMoveVel(0.0) reduces the speed down to 0. Then **MLAxisGenIsRdy** returns TRUE once the axis is ready.

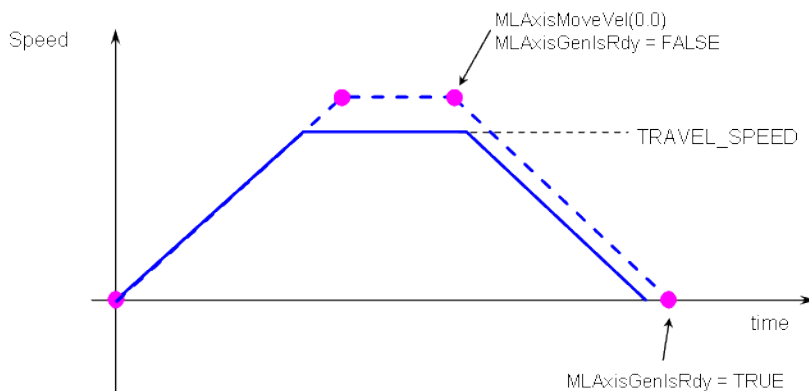

Figure 1-20: Axis Functions Usage

2.1.5 Motion Library - Cam Profile

Name	Description	Return type
MLCamInit	Initializes a cam Pipe Block with user-defined settings	BOOL
MLCamSwitch	Switches profiles of the selected cam object	BOOL
MLPrfReadIOffset	Returns the Input Offset value of a selected cam profile	None
MLPrfReadIScale	Returns the Input Ratio value of a selected cam profile	None
MLPrfReadOOffset	Returns the Output Offset value of a selected cam profile	None
MLPrfReadOScale	Returns the Output Ratio value of a selected cam profile	None
MLPrfWriteIOffset	Sets the Input Offset value of a selected cam profile	BOOL
MLPrfWriteIScale	Sets the Input Ratio value of a selected cam profile	BOOL
MLPrfWriteOOffset	Sets the Output Offset value of a selected cam profile	BOOL
MLPrfWriteOScale	Sets the Output Ratio value of a selected cam profile	BOOL
MLProfileBuild	Builds a cam profile from application data	See Output
MLProfileCreate	Creates a new cam profile object	None
MLProfileInit	Initializes a previously created cam profile object	BOOL
MLProfileRelease	Removes a Profile so the Profile ID may be used by a different or new Profile.	See Output

2.1.5.1 MLCamInit 

2.1.5.1.1 Description

Initializes a Cam Pipe Block for use in a PLC Program. Function block is automatically called if a Cam Block is added to the Pipe Network, with user-defined settings then entered in the Pipe Blocks Properties screen.

The Cam Pipe Block is used to generate motion profiles of any shape. These profiles are created and initiated separately and the shape is modified with the Cam Editor. With the Editor profiles can be changed graphically or by manually changing values in a numeric table relating input and output values with specific slopes. The Cam Editor software tool provides the capability to visualize, analyze, edit, and smooth profiles.

With the PipeNetwork (PN) Cam block:

- the Cam block's profile is in reference to the input positions coming into the PN Cam block (Master Absolute)
- the PN Cam block output positions are in reference to PN Cam block's output position at the end of the last cam cycle (Slave Relative)

Profile switching can be done on the fly, without losing synchronization and without dead time. In addition, the offsets and ratios of Cam Profiles can be changed on the fly. See [Cam Profile Switching](#) for more information.

NOTE

CAM objects are normally created in the Pipe Network using the graphical engine. Then you do not have to add MLCamInit function blocks to their programs. Parameters are entered directly in pop-up windows, and the code is then automatically added to the current project.

2.1.5.1.2 Arguments

2.1.5.1.2.1 Input

BlockID	Description	ID number of a created Pipe Block
	Data type	DINT
	Range	[-2147483648, 2147483648]
	Unit	N/A
	Default	CAM
ProfileName	Description	Name of the current profile assigned to the cam. It must be a declared profile object
	Data type	STRING
	Range	—
	Unit	N/A
	Default	—

ModuloPosition	Description	Value of the period of the cam output values expressed in user units, for a cyclic system
	Data type	LREAL
	Range	—
	Unit	User unit
	Default	360.0

2.1.5.1.2.2 Output

Default (.Q)	Description	Returns TRUE if the CAM Pipe Block is initialized
	Data type	BOOL
	Unit	N/A

2.1.5.1.2.3 Return Type

BOOL

2.1.5.1.3 Related Functions

[MLProfileCreate](#)

[MLProfileInit](#)

2.1.5.1.4 Example

2.1.5.1.4.1 Structured Text

```
//Initialize a Pipe Network block named "CAM" with a profile named
"Profile_A", set the cam modulo position to 360
CAM := MLBlkCreate( 'CAM', 'CAM' );
MLCamInit( CAM, 'Profile_A', 360.0 );
```

2.1.5.1.4.2 Ladder Diagram

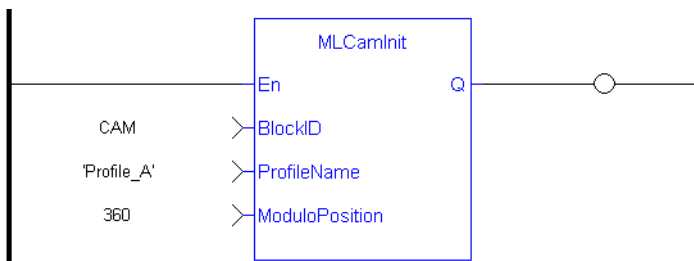

2.1.5.1.4.3 Function Block Diagram

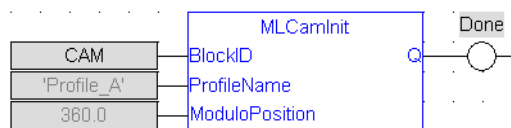

2.1.5.2 MLCamSwitch Pipe Network ✓

2.1.5.2.1 Description

Switches the CAM Profile in a selected CAM object. Can be used in combination with a comparator to check that profiles are switched at a time where the input and output values of both the old and new profiles are equal, so an Axis receives continuous position values and does not jump.

These profiles are created and initiated separately and the shape is created with the CAM Editor. With the Editor profiles can be changed graphically or by manually changing values in a numeric table relating input and output values with specific slopes. The Cam Editor software tool provides the capability to visualize, analyze, edit, and smooth profiles.

See [Cam Profile Switching](#) for more information.

2.1.5.2.2 Arguments

2.1.5.2.2.1 Input

BlockID	Description	ID number of an initialized CAM Pipe Block
	Data type	DINT
	Range	[-2147483648, 2147483648]
	Unit	N/A
	Default	—
ProfileID	Description	Name of the new CAM profile which is assigned to the CAM Pipe Block. It must be a declared profile object.
	Data type	DINT
	Range	[-2147483648, 2147483648]
	Unit	N/A
	Default	—

2.1.5.2.2.2 Output

Default (.Q)	Description	Returns TRUE if the CAM Profile is changed
	Data type	BOOL
	Unit	N/A

2.1.5.2.2.3 Return Type

BOOL

2.1.5.2.3 Related Functions

[MLProfileCreate](#)

[MLProfileInit](#)

[MLPrfWriteIOffset](#)

[MLPrfWriteOScale](#)

2.1.5.2.4 Example

2.1.5.2.4.1 Structured Text

```
//Switch CAM Profile
MLCamSwitch(PipeNetwork.CAM, Profiles.Profile_B);
```

2.1.5.2.4.2 Ladder Diagram

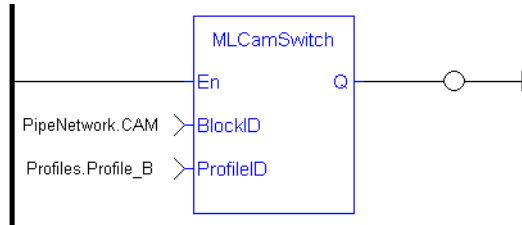

2.1.5.2.4.3 Function Block Diagram

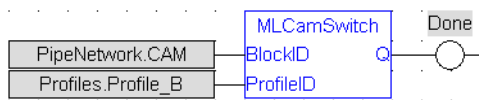

2.1.5.3 MLPrfReadIOffset Pipe Network ✓

2.1.5.3.1 Description

Returns the Input Offset value of a selected CAM Profile. Offsets can be changed on the fly to modify the CAM Profile while maintaining its shape. A change in input offset is equivalent to shifting the CAM Profile on the x or Input Axis.

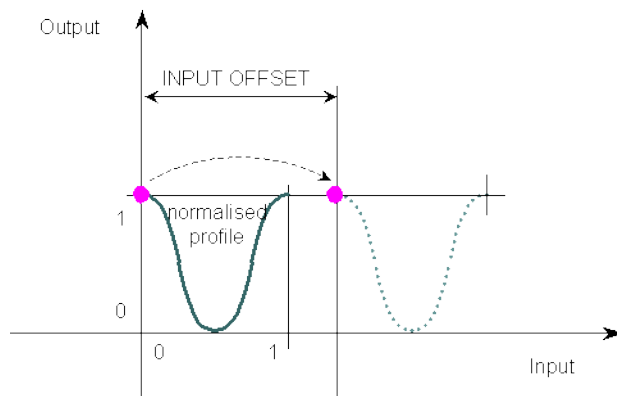

Figure 1-21: MLPrfReadIOffset

2.1.5.3.2 Arguments

2.1.5.3.2.1 Input

ProfileID	Description	Name of an initialized CAM Profile
	Data type	DINT
	Range	[-2147483648, 2147483648]
	Unit	N/A
	Default	—

2.1.5.3.2.2 Output

OK	Description	Returns true when function successfully executes
----	-------------	--

Offset	Data type	BOOL
	Description	Returns the Input Offset of the selected CAM Profile
	Data type	LREAL
	Unit	N/A

2.1.5.3.3 Related Functions

[MLPrfWriteIOffset](#)

[MLProfileCreate](#)

[MLProfileInit](#)

2.1.5.3.4 Example

2.1.5.3.4.1 Structured Text

```
//Save value of input offset
CamOffset := MLPrfReadIOffset ( Profiles.Profile_A );
```

2.1.5.3.4.2 Ladder Diagram

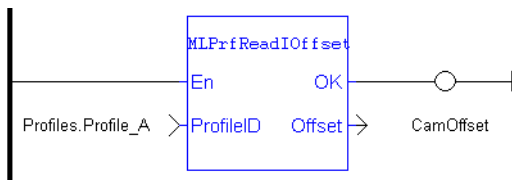

2.1.5.3.4.3 Function Block Diagram



2.1.5.4 MLPrfReadIScale Pipe Network ✓

2.1.5.4.1 Description

Returns the Input Ratio value of a selected CAM Profile. Ratios can be changed on the fly to modify the CAM Profile while maintaining its basic shape. A change in input ratio is equivalent to stretching the CAM Profile on the X (or Input) Axis. A negative value is not allowed.

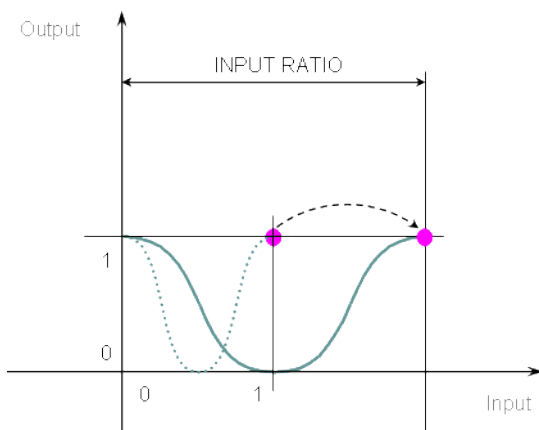

Figure 1-22: MLPrfReadIScale

2.1.5.4.2 Arguments

2.1.5.4.2.1 Input

ProfileID	Description	ID number of an initialized CAM Profile
	Data type	DINT
	Range	[-2147483648, 2147483648]
	Unit	N/A
	Default	—

2.1.5.4.2.2 Output

Ratio	Description	Returns the Input Ratio of the selected CAM Profile
	Data type	LREAL
	Unit	N/A

2.1.5.4.3 Related Functions

[MLPrfWriteIScale](#)

[MLProfileCreate](#)

[MLProfileInit](#)

2.1.5.4.4 Previous Function Name

MLPrfGetIRatio

2.1.5.4.5 Example

2.1.5.4.5.1 Structured Text

```
//Save value of input ratio
CamRatio := MLPrfReadIScale( Profiles.Profile_A );
```

2.1.5.4.5.2 Ladder Diagram

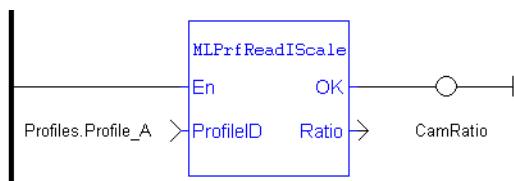

2.1.5.4.5.3 Function Block Diagram

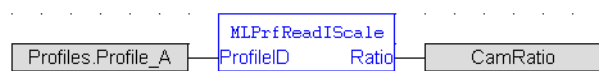

2.1.5.5 MLPrfReadOOffset Pipe Network ✓

2.1.5.5.1 Description

Returns the Output Offset value of a selected CAM Profile. Offsets can be changed on the fly to modify the CAM Profile while maintaining its shape. A change in output offset is equivalent to shifting the CAM Profile on the Y (or Output) Axis.

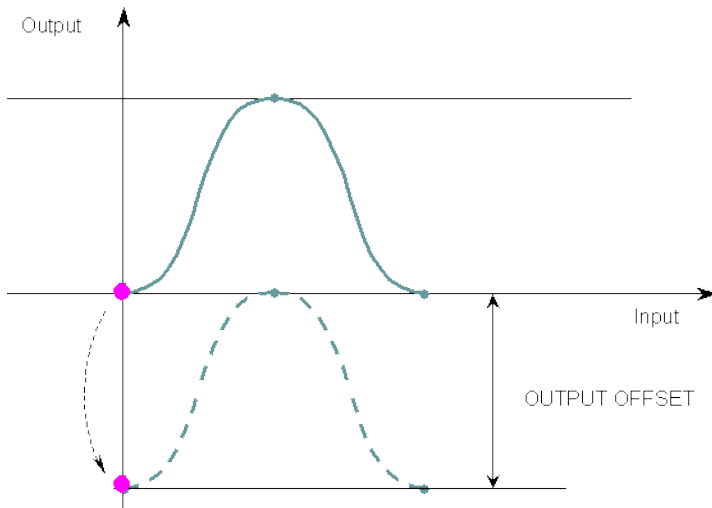

Figure 1-23: MLPrfReadOOffset

2.1.5.5.2 Arguments

2.1.5.5.2.1 Input

ProfileID	Description	ID number of an initialized CAM Profile
	Data type	DINT
	Range	[-2147483648, 2147483648]
	Unit	N/A
	Default	—

2.1.5.5.2.2 Output

Offset	Description	Returns the Output Offset of the selected CAM Profile
	Data type	LREAL
	Unit	N/A

2.1.5.5.3 Related Functions

[MLPrfWriteOOffset](#)

[MLProfileCreate](#)

[MLProfileInit](#)

2.1.5.5.4 Example

2.1.5.5.4.1 Structured Text

```
//Save value of output offset
CamOffset := MLPrfReadOOffset ( Profiles.Profile_A );
```

2.1.5.5.4.2 Ladder Diagram

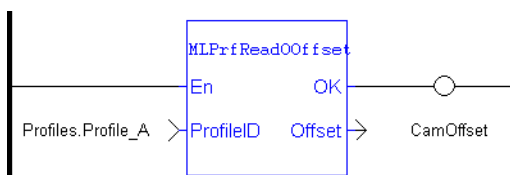

2.1.5.5.4.3 Function Block Diagram



2.1.5.6 MLPrfReadOScale Pipe Network ✓

2.1.5.6.1 Description

Returns the Output Ratio value of a selected CAM Profile. Ratios can be changed on the fly to modify the CAM Profile while maintaining its basic shape. A change in output ratio is equivalent to stretching, and flipping if negative, the CAM Profile on the Y (or Output) Axis.

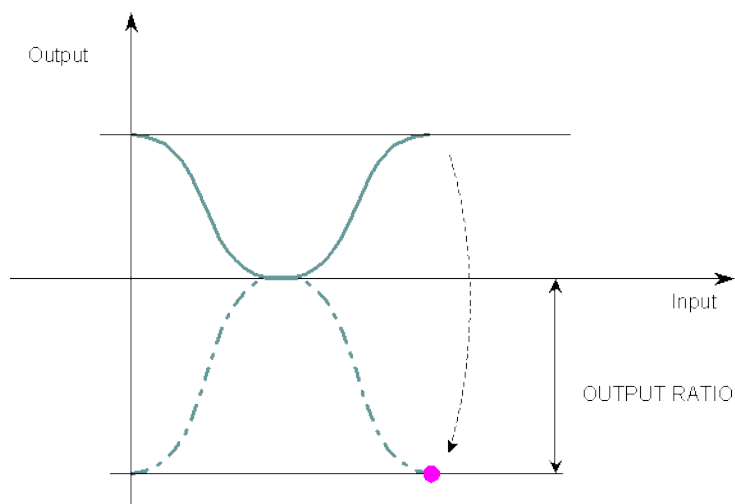

Figure 1-24: MLPrfReadOScale

2.1.5.6.2 Arguments

2.1.5.6.2.1 Input

	Description	ID number of an initialized CAM Profile
ProfileID	Data type	DINT
	Range	[-2147483648, 2147483648]
	Unit	N/A
	Default	—

2.1.5.6.2.2 Output

	Description	Returns the Output Ratio of the selected CAM Profile
Ratio	Data type	LREAL
	Unit	N/A

2.1.5.6.3 Related Functions

[MLPrfWriteOScale](#)

[MLProfileCreate](#)

[MLProfileInit](#)

2.1.5.6.4 Previous Function Name

MLPrfGetORatio

2.1.5.6.5 Example

2.1.5.6.5.1 Structured Text

```
//Save value of output ratio
CamRatio := MLPrfReadOScale( Profiles.Profile_A );
```

2.1.5.6.5.2 Ladder Diagram

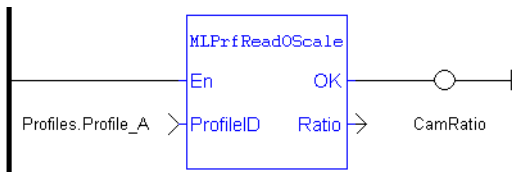

2.1.5.6.5.3 Function Block Diagram



2.1.5.7 MLPrfWriteIOffset Pipe Network ✓

2.1.5.7.1 Description

Set the Input Offset value of a selected CAM Profile. Offsets are changed on the fly to modify the CAM Profile while maintaining its shape. A change in input offset is equivalent to shifting the CAM Profile on the X (or Input) Axis.

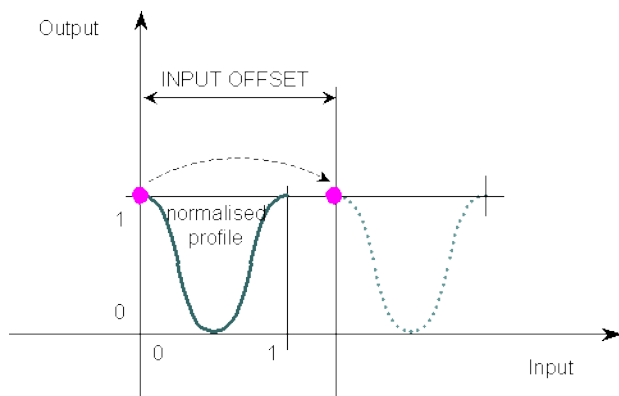

Figure 1-25: MLPrfWriteIOffset

2.1.5.7.2 Arguments

2.1.5.7.2.1 Input

ProfileID	Description Data type Range Unit Default	ID number of an initialized CAM Profile DINT [-2147483648, 2147483648] N/A —
Offset	Description Data type Range Unit Default	Desired new value of Input Offset LREAL — N/A —

2.1.5.7.2.2 Output

Default (.Q)	Description	Returns TRUE if the Input Offset is changed to the new value
	Data type	BOOL
	Unit	N/A

2.1.5.7.2.3 Return Type

BOOL

2.1.5.7.3 Related Functions

[MLPrfReadIOffset](#)

[MLProfileCreate](#)

[MLProfileInit](#)

2.1.5.7.4 Example

2.1.5.7.4.1 Structured Text

```
//Change the value of input offset
MLPrfWriteIOffset( Profiles.Profile_A , 45 );
```

2.1.5.7.4.2 Ladder Diagram

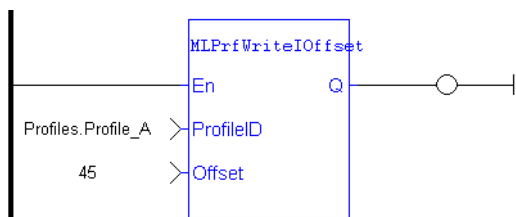

2.1.5.7.4.3 Function Block Diagram

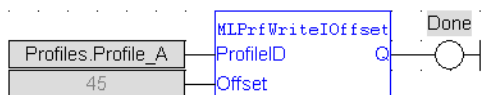

2.1.5.8 MLPrfWriteIScale Pipe Network ✓

2.1.5.8.1 Description

Set the Input Ratio value of a selected CAM Profile. Ratios are changed on the fly to modify the CAM Profile while maintaining its basic shape. A change in input ratio is equivalent to stretching the CAM Profile on the X (or Input) Axis.

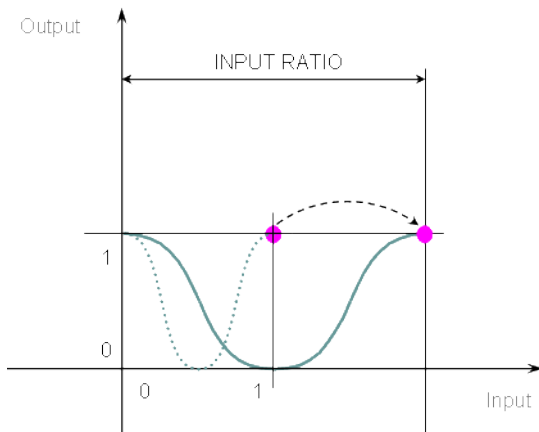

Figure 1-26: MLPrfWriteIScale

2.1.5.8.2 Arguments

2.1.5.8.2.1 Input

ProfileID	Description	ID number of initialized CAM Profile
	Data type	DINT
	Range	[-2147483648, 2147483648]
	Unit	N/A
	Default	—
Ratio	Description	Desired new value for Input Ratio
	Data type	LREAL
	Range	Positive
	Unit	N/A
	Default	—

2.1.5.8.2.2 Output

Default (.Q)	Description	Returns TRUE if the Input Ratio is changed
	Data type	BOOL
	Unit	N/A

2.1.5.8.2.3 Return Type

BOOL

2.1.5.8.3 Related Functions

[MLPrfReadIScale](#)

[MLProfileCreate](#)

[MLProfileInit](#)

2.1.5.8.4 Previous Function Name

MLPrfSetIRatio

2.1.5.8.5 Example

2.1.5.8.5.1 Structured Text

```
//Change value of input ratio
MLPrfWriteIScale( Profiles.Profile_A, 360 );
```

2.1.5.8.5.2 Ladder Diagram

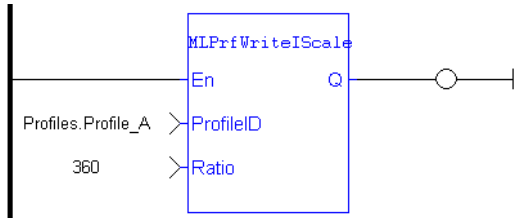

2.1.5.8.5.3 Function Block Diagram

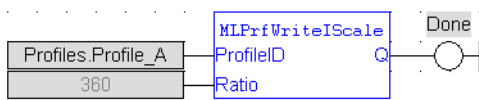

2.1.5.9 MLPrfWriteOOffset Pipe Network ✓

2.1.5.9.1 Description

Changes the Output Offset value of a selected CAM Profile. Offsets are changed on the fly to modify the CAM Profile while maintaining its shape. A change in output offset is equivalent to shifting the CAM Profile on the Y (or Output) Axis.

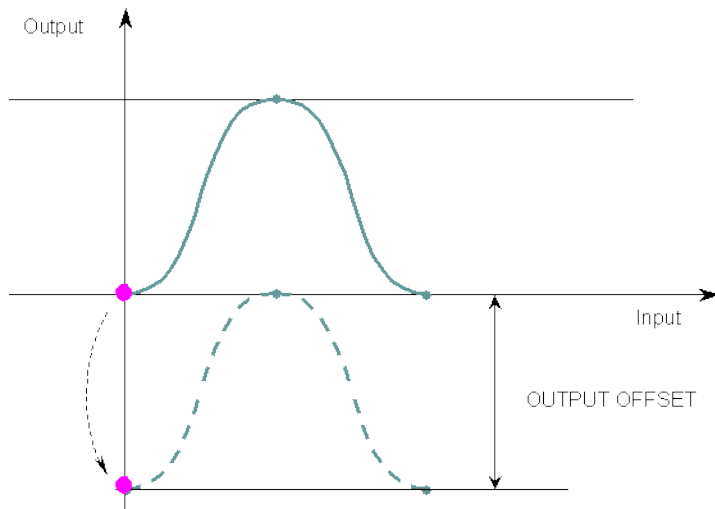

Figure 1-27: MLPrfWriteOOffset

2.1.5.9.2 Arguments

2.1.5.9.2.1 Input

	Description	ID number of an initialized CAM Profile
ProfileID	Data type	DINT
	Range	[-2147483648, 2147483648]
	Unit	N/A
	Default	—

	Description	Desired new value of Output Offset
	Data type	LREAL
Offset	Range	—
	Unit	N/A
	Default	—

2.1.5.9.2.2 Output

	Description	Returns TRUE if the Output Offset value is changed
Default (.Q)	Data type	BOOL
	Unit	N/A

2.1.5.9.2.3 Return Type

BOOL

2.1.5.9.3 Related Functions

[MLPrfReadOOffset](#)

[MLProfileCreate](#)

[MLProfileInit](#)

2.1.5.9.4 Example

2.1.5.9.4.1 Structured Text

```
//Change value of output offset
MLPrfWriteOOffset( Profiles.Profile_A , 45 );
```

2.1.5.9.4.2 Ladder Diagram

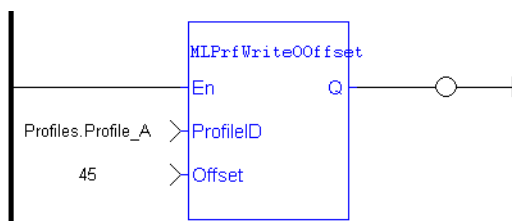

2.1.5.9.4.3 Function Block Diagram

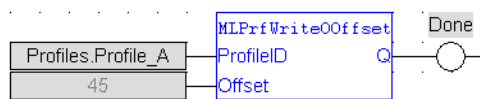

2.1.5.10 MLPrfWriteOScale Pipe Network ✓

2.1.5.10.1 Description

Set the Output Ratio value of a selected CAM Profile. Ratios are changed on the fly to modify the CAM Profile while maintaining its basic shape. A change in output ratio is equivalent to stretching, and flipping if negative (as shown on figure below), the CAM Profile on the Y (or Output) Axis.

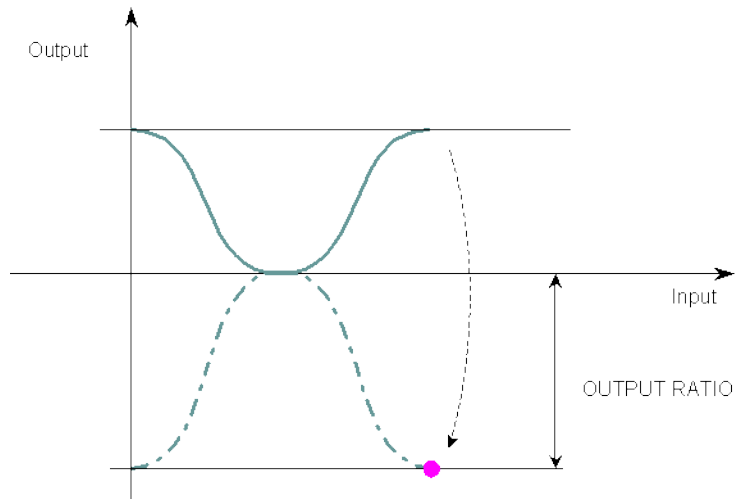

Figure 1-28: MLPrfWriteOScale

2.1.5.10.2 Arguments

2.1.5.10.2.1 Input

ProfileID	Description	ID number of an initialized CAM Profile
	Data type	DINT
	Range	[-2147483648, 2147483648]
	Unit	N/A
Ratio	Default	—
	Description	Desired new value of Output Ratio
	Data type	LREAL
	Range	—
	Unit	N/A
Default	—	

2.1.5.10.2.2 Output

Default (.Q)	Description	Returns TRUE if the Output Ratio is changed
	Data type	BOOL
	Unit	N/A

2.1.5.10.2.3 Return Type

BOOL

2.1.5.10.3 Related Functions

[MLPrfReadOScale](#)

[MLProfileCreate](#)

[MLProfileInit](#)

2.1.5.10.4 Previous Function Name

MLPrfSetORatio

2.1.5.10.5 Example

2.1.5.10.5.1 Structured Text

```
//Change value of output ratio
MLPrfWriteOScale( Profiles.Profile_A , -180 );
```

2.1.5.10.5.2 Ladder Diagram

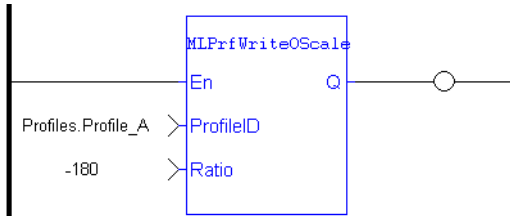

2.1.5.10.5.3 Function Block Diagram

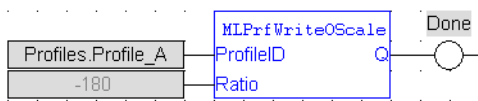

2.1.6 Motion Library - Comparator

TIP

- For a Comparator function example, see [Usage example of Comparator Functions](#)

Name	Description	Return type
MLCompCheck	Checks if the reference of a comparator Pipe Block has been crossed. Returns TRUE if the reference has been crossed	BOOL
MLCompInit	Initializes a comparator Pipe Block with user-defined settings	BOOL
MLCompReadRef	Returns the reference position of a comparator block	None
MLCompReset	Clears the Transition Flag of a comparator Pipe Block	BOOL
MLCompWriteRef	Sets the reference position of a comparator block	BOOL

2.1.6.1 MLCompCheck Pipe Network ✓

2.1.6.1.1 Description

Check if the reference of a comparator Pipe Block has been crossed. Returns the Transition Flag of a comparator object, which turns TRUE if the input position to the comparator is greater or equal to the reference. The Comparator Transition Flag stays TRUE until it is reset.

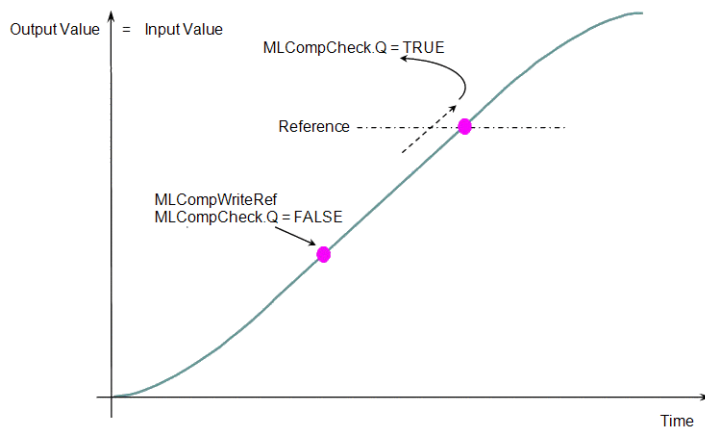

Figure 1-29: MLCompCheck

NOTE

This function or function block returns cached data. See [Programming a Dual Core Controller](#) for more information.

2.1.6.1.2 Arguments

2.1.6.1.2.1 Input

BlockID	Description	ID number of an initiated Comparator object
	Data type	DINT
	Range	[-2147483648, 2147483648]
	Unit	N/A
	Default	—

2.1.6.1.2.2 Output

Default (.Q)	Description	Returns TRUE if reference position of the Comparator object has been crossed
	Data type	BOOL
	Unit	N/A

2.1.6.1.2.3 Return Type

BOOL

2.1.6.1.3 Related Functions

[MLCompReset](#)

[MLCompWriteRef](#)

[MLCompReadRef](#)

2.1.6.1.4 Example

2.1.6.1.4.1 Structured Text

```
//Check if Comparator Reference has been reached
bCrossed := MLCompCheck( PipeNetwork.MyComp );
```

2.1.6.1.4.2 Ladder Diagram

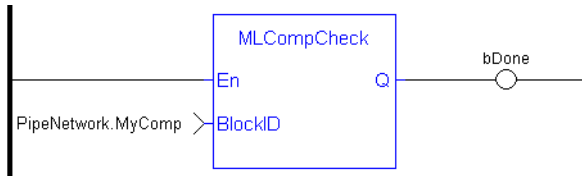

2.1.6.1.4.3 Function Block Diagram

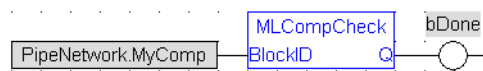

2.1.6.2 MLCompInit Pipe Network ✓

2.1.6.2.1 Description

Initializes a comparator Pipe Block for use in a PLC Program. Function block is automatically called if a Comparator Block is added to the Pipe Network, with user-defined settings entered in the Pipe Blocks Properties screen.

The Transition Flag of a comparator object turns TRUE if the input position to the comparator is greater or equal to the reference. The Comparator Transition Flag stays TRUE until it is reset.

If the input ThroughZero is set to TRUE, system must cross zero and then the reference position before the Transition Flag is set. If ThroughZero is FALSE, Transition Flag is set immediately if the input pipe position is greater or equal to the Reference value.

NOTE

Comparator objects are normally created in the Pipe Network using the graphical engine. Then you do not have to add MLCompInit function blocks to their programs. Parameters are entered directly in pop-up windows, and the code is then automatically added to the current project.

2.1.6.2.2 Arguments

2.1.6.2.2.1 Input

BlockID	Description	ID number of a created Comparator Pipe Block
	Data type	DINT
	Range	[-2147483648, 2147483648]
	Unit	N/A
	Default	—
ModuloPosition	Description	Value of the period of a cyclic system

	Data type	LREAL
	Range	—
	Unit	User unit
	Default	—
ThroughZero	Description	When TRUE, system must cross zero and then the reference position before the Transition Flag is set. If FALSE, Transition Flag is set immediately if the input pipe position is greater then or equal to the Reference value.
	Data type	BOOL
	Range	0, 1
	Unit	N/A
	Default	—
Reference	Description	Set the reference position in the new Comparator object
	Data type	LREAL
	Range	—
	Unit	User unit
	Default	—

2.1.6.2.2.2 Output

Default (.Q)	Description	Returns TRUE when function starts to execute
	Data type	BOOL
	Unit	N/A

2.1.6.2.2.3 Return Type

BOOL

2.1.6.2.3 Related Functions

[MLBlkCreate](#)

[MLCompCheck](#)

[MLCompReset](#)

[MLCompWriteRef](#)

2.1.6.2.4 Example

2.1.6.2.4.1 Structured Text

```
//Initiate a created Comparator Block named "MyComp" to:
// Modulo of 360
// Require the input position to first cross 0 before the
//   MLCompCheck output is triggered
// Input compared position to 45
```

```
Comp := MlBlkCreate ( 'MyComp', 'COMPARATOR' );
CompInit ( MyComp, 360.0, TRUE, 45.0 );
```

2.1.6.2.4.2 Ladder Diagram

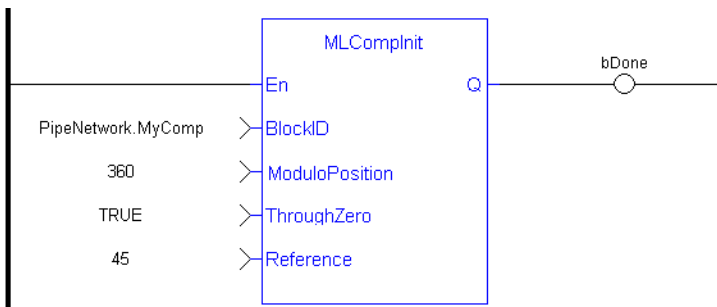

2.1.6.2.4.3 Function Block Diagram

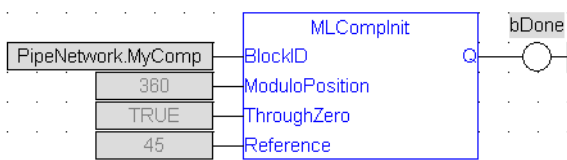

2.1.6.3 MLCompReadRef Pipe Network ✓

2.1.6.3.1 Description

Returns the reference position of a comparator block. The Transition Flag of a comparator object turns TRUE if the input position to the comparator is greater or equal to the reference. The Comparator Transition Flag stays TRUE until it is reset.

2.1.6.3.2 Arguments

2.1.6.3.2.1 Input

BlockID	Description	ID number of an initiated Comparator object
	Data type	DINT
	Range	[-2147483648, 2147483648]
	Unit	N/A
	Default	—

2.1.6.3.2.2 Output

Reference	Description	Returns the current reference position of the Comparator object
	Data type	LREAL
	Unit	User unit

2.1.6.3.3 Related Functions

[MLCompWriteRef](#)

MLCompReset

MLCompCheck

2.1.6.3.4 Example

2.1.6.3.4.1 Structured Text

```
//Return the Comparator Reference value
CompRef := MLCompReadRef( PipeNetwork.MyComp );
```

2.1.6.3.4.2 Ladder Diagram

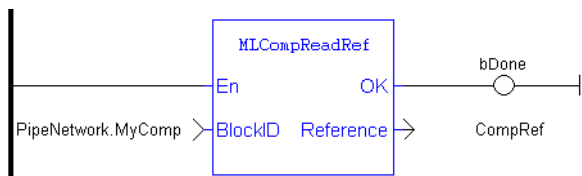

2.1.6.3.4.3 Function Block Diagram



2.1.6.4 MLCompReset Pipe Network ✓

2.1.6.4.1 Description

Clear the Transition Flag of a comparator Pipe Block. The Transition Flag of a comparator object turns TRUE if the input position to the comparator is greater or equal to the reference. The Comparator Transition Flag stays TRUE until it is reset.

2.1.6.4.2 Arguments

2.1.6.4.2.1 Input

BlockID	Description	ID number of an initiated Comparator object
	Data type	DINT
	Range	[-2147483648, 2147483648]
	Unit	N/A
	Default	—

2.1.6.4.2.2 Output

Default (.Q)	Description	Returns TRUE when function starts to execute
	Data type	BOOL
	Unit	N/A

2.1.6.4.2.3 Return Type

BOOL

2.1.6.4.3 Related Functions

MLCompCheck
 MLCompReadRef
 MLCompWriteRef

2.1.6.4.4 Example

2.1.6.4.4.1 Structured Text

```
//Clear the Transition Flag of a Comparator object
MLCompReset ( PipeNetwork.MyComp );
```

2.1.6.4.4.2 Ladder Diagram

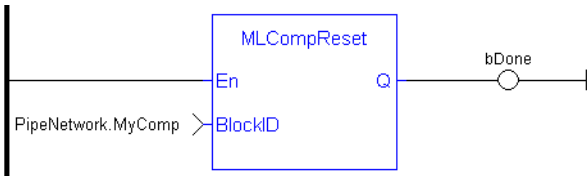

2.1.6.4.4.3 Function Block Diagram



2.1.6.5 MLCompWriteRef Pipe Network ✓

2.1.6.5.1 Description

Set the reference position of a comparator block. The Transition Flag of a comparator object turns TRUE if the input position to the comparator is greater or equal to the reference. The Comparator Transition Flag stays TRUE until it is reset.

If the input ThroughZero is set to TRUE, system must cross zero and then the reference position before the Transition Flag is set. If ThroughZero is FALSE, Transition Flag is set immediately if the input pipe position is greater then or equal to the Reference value.

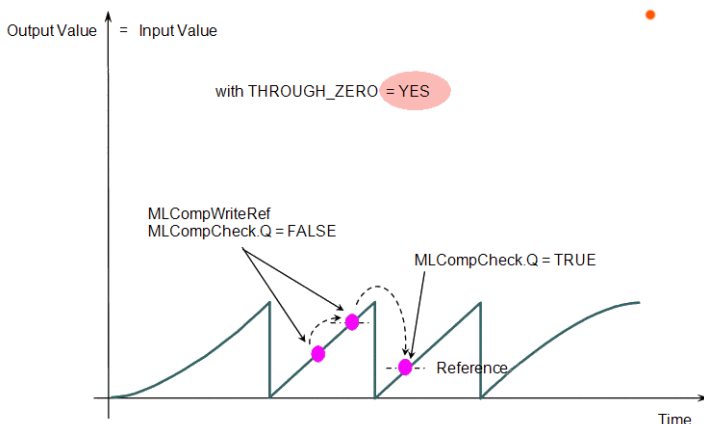

Figure 1-30: MLCompWriteRef

2.1.6.5.2 Arguments

2.1.6.5.2.1 Input

BlockID	Description
	ID number of an initiated Comparator object

	Data type	DINT
	Range	[-2147483648, 2147483648]
	Unit	N/A
	Default	—
ThroughZero	Description	When TRUE, system must cross zero and then the reference position before the Transition Flag is set. If FALSE, Transition Flag is set immediately if the input pipe position is greater then or equal to the Reference value.
	Data type	BOOL
	Range	0, 1
	Unit	N/A
	Default	—
Reference	Description	New reference position to set in the selected Comparator object
	Data type	LREAL
	Range	—
	Unit	User unit
	Default	—

2.1.6.5.2.2 Output

Default (.Q)	Description	Returns TRUE when function starts to execute
	Data type	BOOL
	Unit	N/A

2.1.6.5.2.3 Return Type

BOOL

2.1.6.5.3 Related Functions

[MLCompCheck](#)

[MLCompReadRef](#)

[MLCompReset](#)

2.1.6.5.4 Example

2.1.6.5.4.1 Structured Text

```
//Set the Comparator Reference value
MLCompWriteRef( PipeNetwork.MyComp , TRUE , 45 );
```

2.1.6.5.4.2 Ladder Diagram

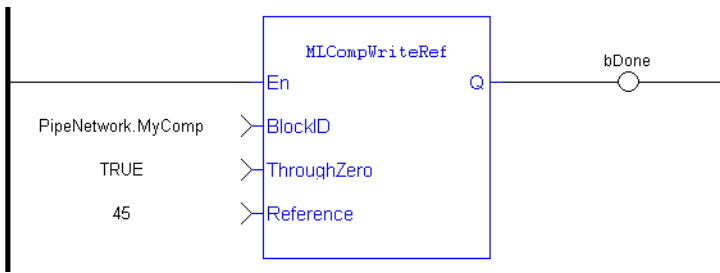

2.1.6.5.4.3 Function Block Diagram

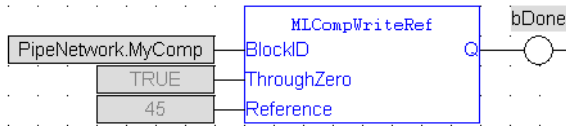

2.1.6.6 Usage example of Comparator Functions

When you call the **MLCompWriteRef** function, the output for **MLCompCheck** becomes True as soon as the input value reaches the reference.

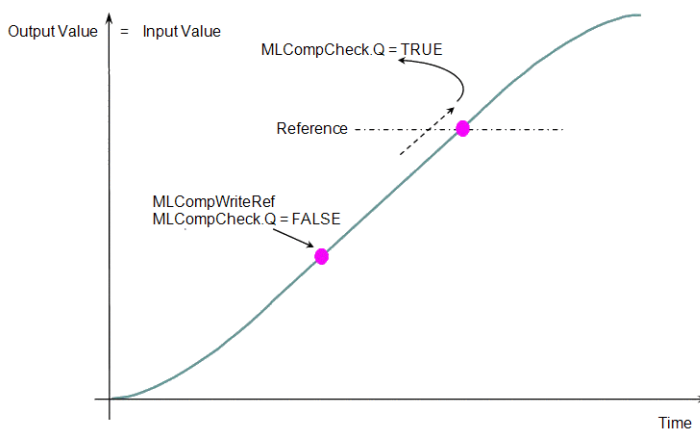
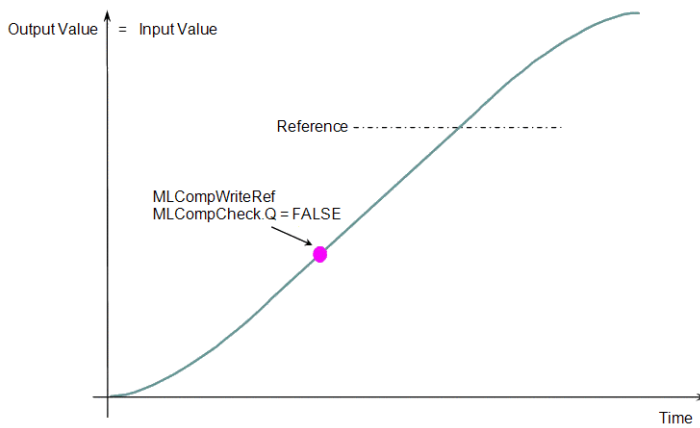

The same function can also be called for a cyclic input value.

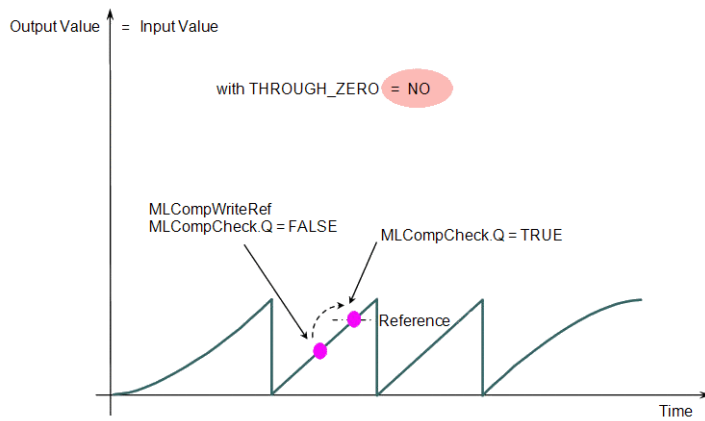
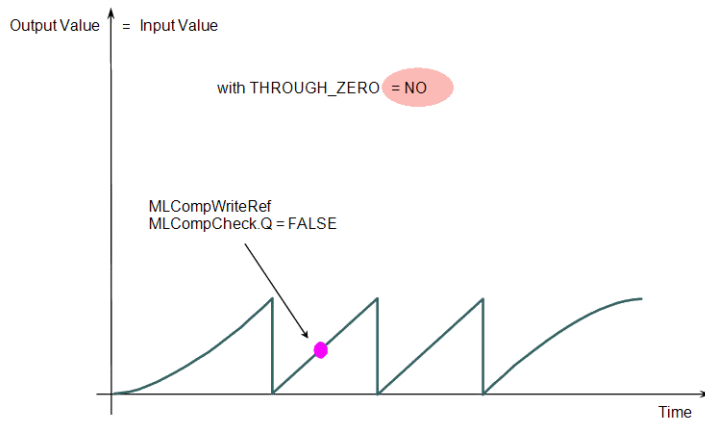

When the THROUGH_ZERO parameter is set to YES, the output for MLCompCheck becomes True as soon as the input value reaches the reference, but not before it has passed through zero.

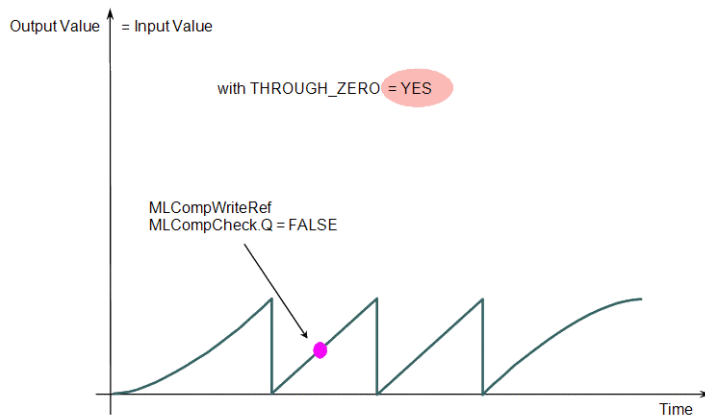

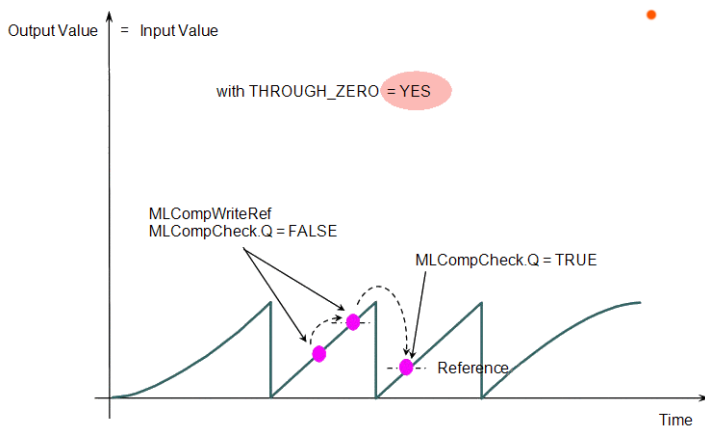

Figure 1-31: Comparator Functions Usage

2.1.7 Motion Library - Convertor

Name	Description	Return type
MLCNVConECAT	Connect the output of a pipe convertor block to an EtherCAT Output (Rx) PDO object.	
MLCNVConnect	Connects a converter Pipe Block to the specified axis	BOOL
MLCNVConnectEx	Connects an extra converter Pipe Block to the specified axis. This function connects the output of a pipe to an axis data other than the control position.	BOOL
MLCNVDisconnect	Disconnects a converter Pipe Block from its associated axis	BOOL
MLCNVInit	Initializes a converter Pipe Block in Position or Speed mode	BOOL

2.1.7.1 MLCNVConECAT

2.1.7.1.1 Description

This function will connect the output of a pipe convertor block to an EtherCAT Output (Rx) PDO object. The output value of the convertor block will then be written to the PDO object every update of the convertor block. The pipe block is specified by the BlockID input and the PDO object is specified by the DeviceAddr, Index, and SubIndex inputs.

2.1.7.1.2 Arguments

2.1.7.1.2.1 Input

BlockID	Description	The convertor block whose output value will be written to the PDO object. For example: PipeNetwork:CNV1
	Data type	DINT
	Range	N/A
	Unit	N/A
	Default	—
DeviceAddr	Description	The device address of the PDO object to be written. EtherCAT devices are numbered in order with the first device being 1001, the second 1002, etc.
	Data type	INT

	Range	N/A
	Unit	N/A
	Default	—
Index	Description	The index of the PDO object to be written. The index can be determined from the table located in the “PDO Selection/Mapping” tab of the EtherCAT device page. (In Project Explorer, under EtherCAT, select the device, then select the PDO Selection/Mapping tab.)
	Data type	UINT
	Range	N/A
	Unit	N/A
	Default	—
SubIndex	Description	The sub index of the PDO object to be written. The sub index can be determined from the table located in the “PDO Selection/Mapping” tab of the EtherCAT device page. (In Project Explorer, under EtherCAT, select the device, then select the PDO Selection/Mapping tab.)
	Data type	USINT
	Range	N/A
	Unit	N/A
	Default	—

2.1.7.1.2.2 Output

Default (.Q)	Description	Returns TRUE if this function has successfully connected the output of the pipe convertor block to the EtherCAT Output (Rx) PDO Object.
	Data type	BOOL
	Unit	N/A

2.1.7.1.3 Related Functions

[MLCNVDisconnect](#)

[MLCNVInit](#)

2.1.7.1.4 Example

2.1.7.1.4.1 Structured Text

```
//Connect a converter Pipe Block named "CNV2" to PDO 16#60B2 (Accel FF)
on ECAT address 1002.
MLCNVConECAT( PipeNetwork.CNV2, 1002, 16#60B2, 0 );
```

2.1.7.1.4.2 Ladder Diagram

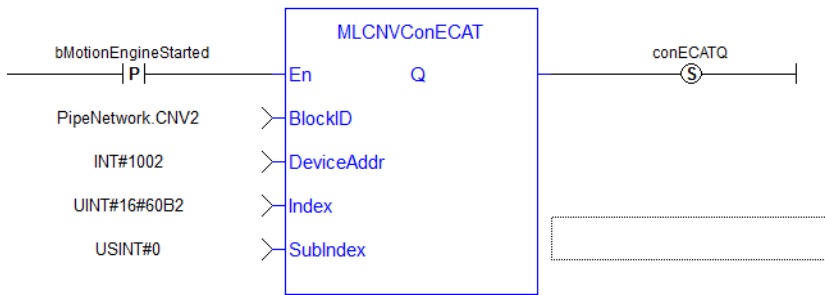

2.1.7.1.4.3 Function Block Diagram



2.1.7.2 MLCNVConnect

2.1.7.2.1 Description

Connect a converter Pipe Block to the specified axis. When using the Pipe Network for coordinated motion, Pipe Blocks have to be Activated, Connected, and then Powered On before move commands work.

The Converter block changes the incoming flow of values to continuous position output with no periodicity. If a converter block is not connected to an Axis, it does not send position output values to its assigned Axis. Every pipe branch must end in a converter, whether or not it is connected to a destination Axis object, as seen in Figure 1 below.

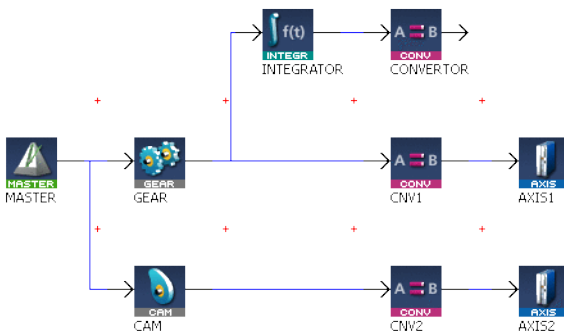

Figure 1-32: MLCNVConnect

NOTE

All converters in the Pipe Network can be connected at once with the command PipeNetwork (MLPN_Connect). This calls automatically generated code with MLCNVConnect commands for each Converter block. Therefore, in a multi-axis program only one command can be used to connect Pipe Blocks instead of writing code for each Axis separately.

TIP

The converter block has the ability to control the analog output on the AKD. See for information on the parameters.

2.1.7.2.2 Arguments

2.1.7.2.2.1 Input

BlockID	Description
	ID number of an initiated Converter object
	Data type
	DINT

	Range	[-2147483648, 2147483648]
	Unit	N/A
	Default	—
AxisID	Description	ID number of an initiated Axis object
	Data type	DINT
	Range	[-2147483648, 2147483648]
	Unit	N/A
	Default	—

2.1.7.2.2.2 Output

Default (.Q)	Description	Returns TRUE if the converter is connected to the Axis object
	Data type	BOOL
	Unit	N/A

2.1.7.2.2.3 Return Type

BOOL

2.1.7.2.3 Related Functions

[MLCNVConnectEx](#)

[MLCNVDisconnect](#)

[MLCNVInit](#)

2.1.7.2.4 Example

2.1.7.2.4.1 Structured Text

```
//Connect a converter Pipe Block named "CNV1" to Pipe Block AXIS1
MLCNVConnect( PipeNetwork.CNV1, AXIS1 );
```

2.1.7.2.4.2 Ladder Diagram

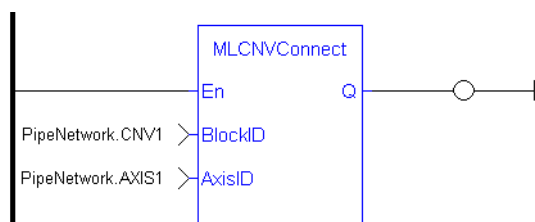

2.1.7.2.4.3 Function Block Diagram

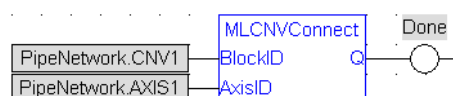

2.1.7.3 MLCNVConnectEx

2.1.7.3.1 Description

Connect a converter Pipe Block to the specified axis. This function connects the output of a pipe to an axis data other than the control position. With this function, several converter Pipe Blocks can connect to the same axis and acts on different data.

Normally a Converter block sends position values to an Axis. However, some cases exist that require additional information such as torque feed-forward (IDN 3056) that needs to be provided by a second converter.

NOTE

This FB does not work when you choose to [simulate](#) the device. In such a case, the FB continuously generates error messages displayed in the Controller log window.

NOTE

Need to add 16#8000 to desired IDN number for ValueID input. 8000 in hexadecimal signals a vendor-specific IDN value.

2.1.7.3.2 Arguments

2.1.7.3.2.1 Input

BlockID	Description	ID number of an initiated Converter object
	Data type	DINT
	Range	[-2147483648, 2147483648]
	Unit	N/A
	Default	—
AxisID	Description	ID number of an initiated Axis object
	Data type	DINT
	Range	[-2147483648, 2147483648]
	Unit	N/A
	Default	—
ValueID	Description	Specify the following constant: <ul style="list-style-type: none"> • EC_ADDITIVE_TORQUE_VALUE (for torque feed-forward) • EC_ANALOG_OUTPUT (for control of Analog Output: AKD parameter: "AOUT.VALUEU") <p>If the Analog Output is mapped to a PLC variable, the connection to the analog output by EC_ANALOG_OUTPUT will not work as the output value will be overwritten by the PLC mapped variable data. In order to function properly the AOUT.MODE must be set to "User Mode (mode = 0)".</p> <p>See the TIP below for more information.</p>
	Data type	DINT
	Range	[-2147483648, 2147483648]

	Unit	N/A
	Default	—
ValueInfo	Description	This value is ignored and must be set to zero
	Data type	DINT
	Range	[-2147483648, 2147483648]
	Unit	N/A
	Default	—

TIP

The PDO values will be overwritten by Mapped PLC variables including a possible link to the mapping of variables or the section on MLCParamWrite() warning indicating that the function block write of Analog output will be overwritten by the MLCnvConnectEx function.

Precedence rules:

1. A PLC variable mapped to Analog Output takes precedence.
2. If MLCNVConnect assigns a Pipe output to Analog Output it will take precedence over a DriveParamWrite function call.
3. DriveParamWrite will modify the Analog Output but get overwritten by the higher precedent options if they are present.

2.1.7.3.2.2 Output

Default (.Q)	Description	Returns TRUE if the converter is connected to the Axis object
	Data type	BOOL
	Unit	N/A

2.1.7.3.2.3 Return Type

BOOL

2.1.7.3.3 Related Functions

[MLCNVConnect](#)

[MLCNVDisconnect](#)

[MLCNVInit](#)

2.1.7.3.4 Example

2.1.7.3.4.1 Structured Text

```
//Connect a converter Pipe Block named "CNV1" to the pipe block named
//AXIS1, And send feed-forward (EC_ADDITIVE_TORQUE_VALUE) to the drive
MLCNVConnectEx( PipeNetwork.CNV1, PipeNetwork.AXIS1, EC_ADDITIVE_TORQUE_
//VALUE, 0 );
```

2.1.7.3.4.2 Ladder Diagram

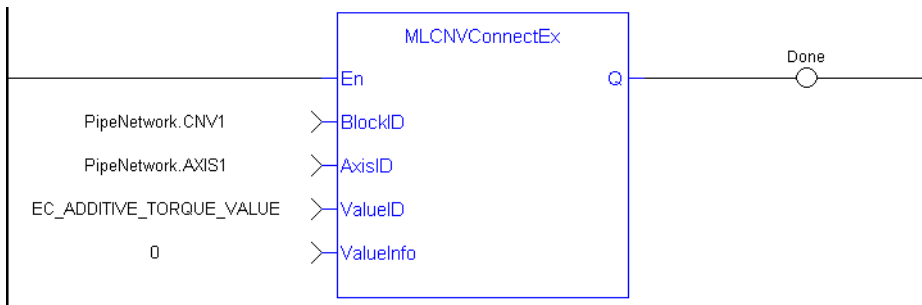

2.1.7.3.4.3 Function Block Diagram

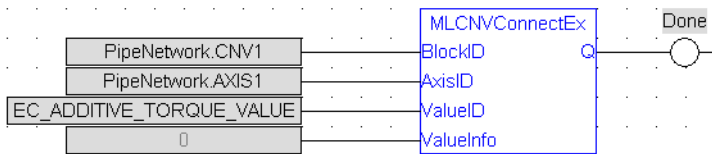

2.1.7.4 MLCNVDisconnect

2.1.7.4.1 Description

Disconnect a converter Pipe Block from its associated axis.

If a converter block is not connected to an Axis, it does not send position output values to its assigned Axis. Can disconnect one or multiple Axis from the Pipe Network and still send single-axis motion commands. Axis can be disconnected while the Pipe Positions are reset to different values or if coordinated motion is only not needed with every axis in the project in a certain state.

2.1.7.4.2 Arguments

2.1.7.4.2.1 Input

BlockID	Description	ID number of an initiated Converter object
	Data type	DINT
	Range	[-2147483648, 2147483648]
	Unit	N/A
	Default	—

2.1.7.4.2.2 Output

Default (.Q)	Description	Returns TRUE if the converter is disconnected from the Axis object
	Data type	BOOL
	Unit	N/A

2.1.7.4.2.3 Return Type

BOOL

2.1.7.4.3 Related Functions

[MLCNVConnect](#)

[MLCNVInit](#)

2.1.7.4.4 Example

2.1.7.4.4.1 Structured Text

```
//Disconnect a converter Pipe Block name " CNV1" from its present
connection
MLCNVDisconnect( PipeNetwork.CNV1);
```

2.1.7.4.4.2 Ladder Diagram

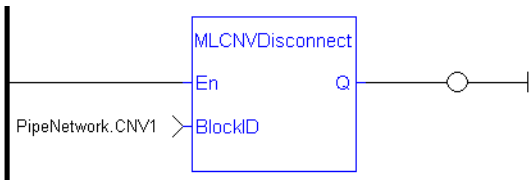

2.1.7.4.4.3 Function Block Diagram



2.1.7.5 MLCNVInit

2.1.7.5.1 Description

Initializes a converter Pipe Block. Function block is automatically called if a Converter Block is added to the Pipe Network, with the input mode (position or speed) entered in the Pipe Blocks Properties screen. The Converter block changes the incoming flow of speed or position values to continuous position output with no periodicity.

NOTE
 Converter objects are normally created in the Pipe Network using the graphical engine. Then you do not have to add MLCNVInit function blocks to their programs. Parameters are entered directly in pop-up windows, and the code is then automatically added to the current project.

2.1.7.5.2 Arguments

2.1.7.5.2.1 Input

BlockID	Description	ID number of a created Pipe Block
	Data type	DINT
	Range	[-2147483648, 2147483648]
	Unit	N/A
	Default	—
Mode	Description	1 for Position mode, 2 for Speed mode. Determines the type of input to the Converter Object.
	Data type	DINT
	Range	[1, 2]
	Unit	N/A
	Default	—

2.1.7.5.2.2 Output

Default (.Q)	Description	Returns TRUE if the Convertor Pipe Block is initialized
	Data type	BOOL
	Unit	N/A

2.1.7.5.2.3 Return Type

BOOL

2.1.7.5.3 Related Functions

[MLBlkCreate](#)

[MLCNVConnect](#)

2.1.7.5.4 Example

2.1.7.5.4.1 Structured Text

```
// Initiate a created convertor block named "CNV1"
CNV1 := MLBlkCreate( 'CNV1', 'CONVERTOR' );
MLCNVInit( CNV1, 1 );
```

2.1.7.5.4.2 Ladder Diagram

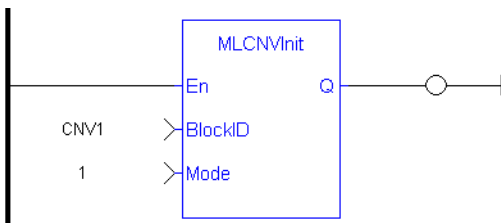

2.1.7.5.4.3 Function Block Diagram

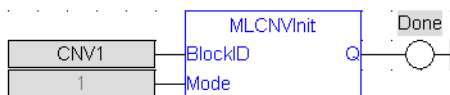

2.1.8 Motion Library - Delay

Name	Description	Return type
MLDelayInit	Initializes a delay object	BOOL

2.1.8.1 MLDelayInit Pipe Network ✓

2.1.8.1.1 Description

Initializes a delay object. Returns TRUE if the function succeeded. This FB is automatically created in the compiled code of a Pipe Network. It is included in the MLPN_CREATE_OBJECT (created in ST) which is typically executed in a project as part of the startup sequence of the Pipe Network.

2.1.8.1.2 Arguments

2.1.8.1.2.1 Input

BlockID	Description	ID number of a created Pipe Block
	Data type	DINT
	Range	[-2147483648, 2147483648]
	Unit	N/A
	Default	—
CycleDelay	Description	Number of delay cycles
	Data type	DINT
	Range	[0 , 9]
	Unit	Cycle
	Default	0

2.1.8.1.2.2 Example

2.1.8.1.2.3 Structured Text

```
MLDelayInit (PipeNetwork.DELAY1, 2 );
```

2.1.8.1.2.4 Ladder Diagram

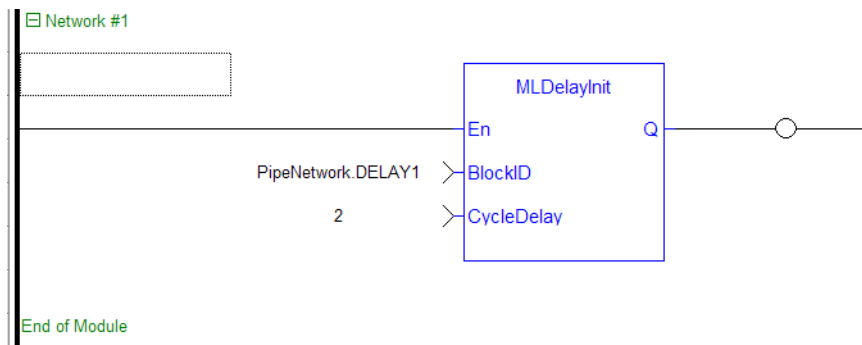

2.1.8.1.2.5 Function Block Diagram

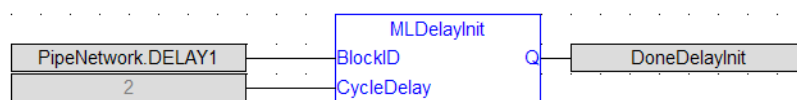

2.1.9 Motion Library - Derivator

Name	Description	Return type
MLDerInit	Initializes a derivator object	BOOL
MLDerReadInModPos	Returns the input MODULO_POSITION of the Derivator block	None
MLDerWriteInModPos	Sets the input MODULO_POSITION of the Derivator block	BOOL

2.1.9.1 MLDerInit Pipe Network ✓

2.1.9.1.1 Description

Initializes an derivator object. Function block is automatically called if a Derivator Block is added to the Pipe Network, with user-defined settings entered in the Pipe Blocks Properties screen. Input ModuloPosition is defined to manage the periodicity (modulo) of the input values.

NOTE

Derivator objects are normally created in the Pipe Network using the graphical engine. Then you do not have to add MLDerInit function blocks to their programs. Parameters are entered directly in pop-up windows, and the code is then automatically added to the current project.

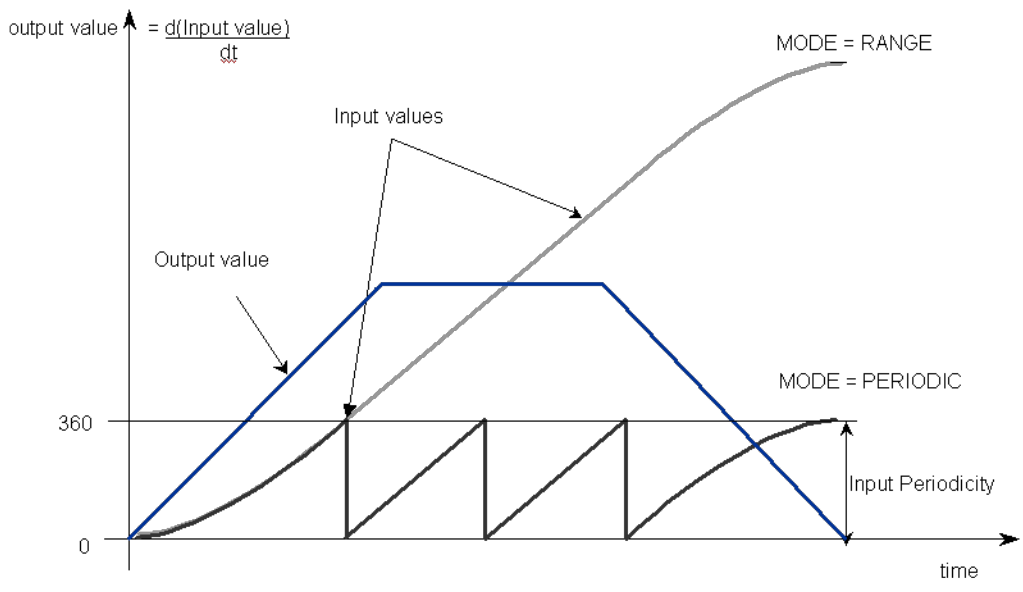

Figure 1-33: MLDerInit

2.1.9.1.2 Arguments

2.1.9.1.2.1 Input

BlockID	Description	ID number of a created Pipe Block
	Data type	DINT
	Range	[-2147483648, 2147483648]
	Unit	N/A
	Default	—
ModuloPosition	Description	Input ModuloPosition of Derivator object
	Data type	LREAL
	Range	—
	Unit	User unit
	Default	360.0

2.1.9.1.2.2 Output

Default (.Q)	Description	Returns TRUE if the Derivator object is initialized
	Data type	BOOL
	Unit	N/A

2.1.9.1.2.3 Return Type

BOOL

2.1.9.1.3 Related Functions

[MLBlkCreate](#)

[MLDerReadInModPos](#)

[MLDerWriteInModPos](#)

2.1.9.1.4 Example

2.1.9.1.4.1 Structured Text

```
//Create and Initiate a Derivator object
MyDerivator := MLBlkCreate( 'MyDerivator', 'DERIVATOR' );
MLDerInit( MyDerivator, 360.0 );
```

2.1.9.1.4.2 Ladder Diagram

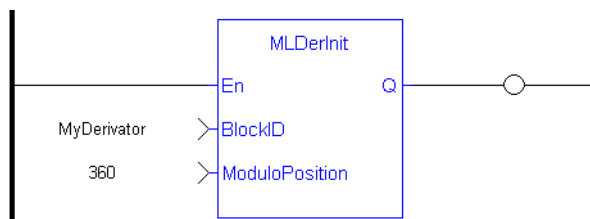

2.1.9.1.4.3 Function Block Diagram

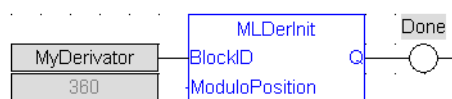

2.1.9.2 MLDerReadInModPos Pipe Network ✓

2.1.9.2.1 Description

Returns the Input ModuloPosition of the derivator block. Input ModuloPosition is defined to manage the periodicity (modulo) of the input values.

For example, if the input value increases each millisecond by one degree then the output value is 1000 degrees per second. Now lets imagine that the input value skips suddenly from 359 to 0.

- If Input ModuloPosition = 360, the output continues to indicate 1000 degrees per second, indicating that rollover into the next period has been properly handled.
- If Input ModuloPosition = 1000, the output then indicates 359,000 degrees per second, indicating that the input has incorrectly interpreted roll-over as a 359 degree move in one millisecond.

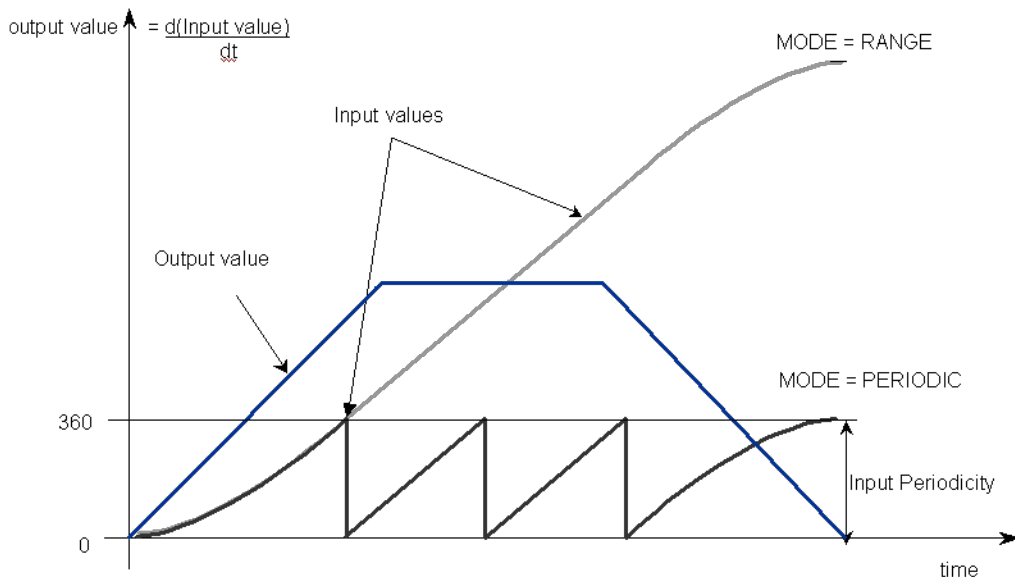

Figure 1-34: MLDerReadInModPos

NOTE

The first calculation of a Derivator Pipe Block just after the pipe installation indicates zero regardless of the initial input value.

2.1.9.2.2 Arguments

2.1.9.2.2.1 Input

ID	Description	ID number of an initiated Derivator object.
	Data type	DINT
	Range	[-2147483648, 2147483648]
	Unit	N/A
	Default	—

2.1.9.2.2.2 Output

ModuloPosition	Description	Current Input ModuloPosition of the selected Derivator object.
	Data type	LREAL
	Unit	User unit
	Default	—

2.1.9.2.3 Related Functions

[MLDerWriteInModPos](#)

[MLDerInit](#)

2.1.9.2.4 Example

2.1.9.2.4.1 Structured Text

```
//save the current input MODULO_POSITION of a Derivator object
DerInputPeriod := MLDerReadInModPos ( PipeNetwork.MyDerivator );
```

2.1.9.2.4.2 Ladder Diagram

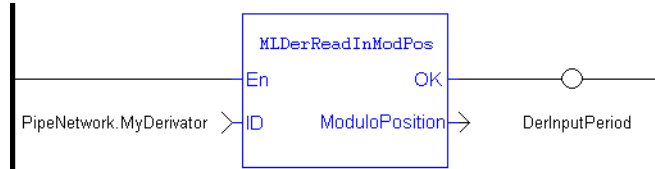

2.1.9.2.4.3 Function Block Diagram

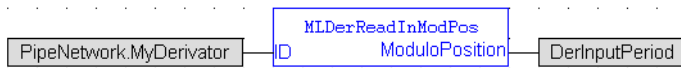

2.1.9.3 MLDerWriteInModPos Pipe Network ✓

2.1.9.3.1 Description

Sets the Input ModuloPosition of the Derivator block. Input ModuloPosition is defined to manage the periodicity (modulo) of the input values.

For example, if the input value increases each millisecond by one degree then the output value is 1000 degrees per second. Now lets imagine that the input value skips suddenly from 359 to 0

-If Input ModuloPosition = 360, the output continues to indicate 1000 degrees per second, indicating that rollover into the next period has been properly handled

-If Input ModuloPosition = 1000, the output then indicates 359,000 degrees per second, indicating that the input has incorrectly interpreted roll-over as a 359 degree move in one millisecond

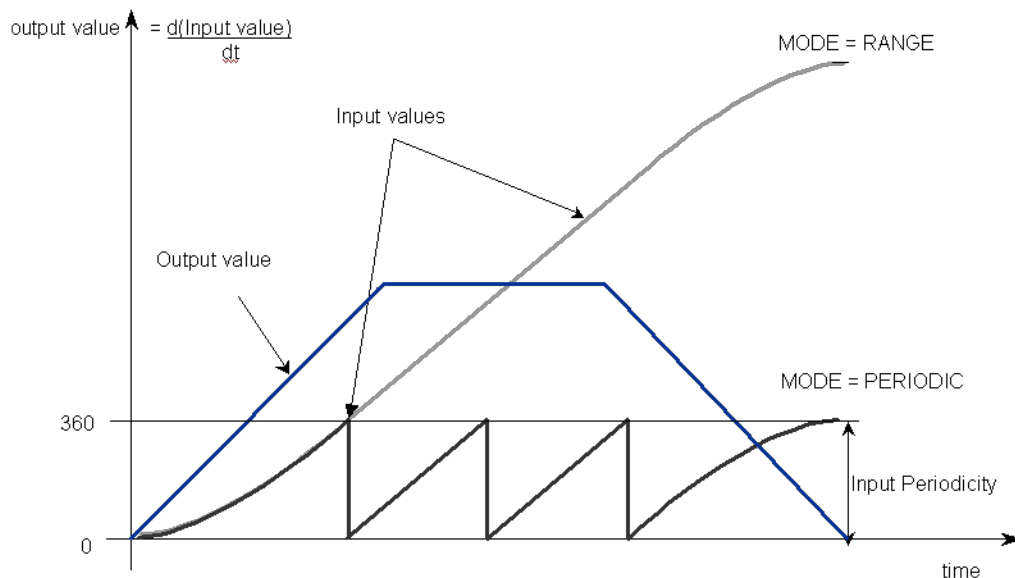

Figure 1-35: MLDerWriteInModPos

NOTE

The first calculation of a Derivator Pipe Block just after the pipe installation indicates zero regardless of the initial input value.

2.1.9.3.2 Arguments**2.1.9.3.2.1 Input**

ID	Description	ID number of an initiated Derivator object
	Data type	DINT
	Range	[-2147483648, 2147483648]
	Unit	N/A
	Default	—
ModuloPosition	Description	Desired new value of Input ModuloPosition of the selected Derivator object
	Data type	LREAL
	Range	—
	Unit	User unit
	Default	—

2.1.9.3.2.2 Output

Default (.Q)	Description	Returns TRUE if the Input ModuloPosition value is changed
	Data type	BOOL
	Unit	N/A

2.1.9.3.2.3 Return Type

BOOL

2.1.9.3.3 Related Functions

[MLDerReadInModPos](#)

[MLDerInit](#)

2.1.9.3.4 Example**2.1.9.3.4.1 Structured Text**

```
//change the input MODULO_POSITION of a Derivator object to 720
MLDerWriteInModPos ( PipeNetwork.MyDerivator, 720 );
```

2.1.9.3.4.2 Ladder Diagram

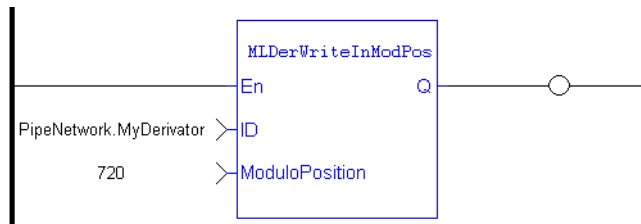

2.1.9.3.4.3 Function Block Diagram

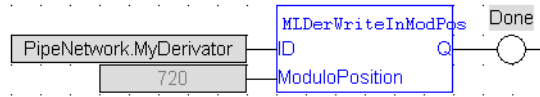

2.1.10 Motion Library - Gear

Name	Description	Return type
MLGearInit	Initializes a Gear Pipe Block with user-defined settings	BOOL
MLGearReadOffset	Returns the offset value of selected Gear Block	None
MLGearReadOffSlp	Returns the Offset Slope value of selected Gear Block	None
MLGearReadRatio	Returns the ratio value of a gear block	None
MLGearReadRatSlp	Returns the ratio slope value of a gear block	None
MLGearWriteOff	Sets the Offset value of a selected Gear Pipe Block	BOOL
MLGearWriteOSlp	Sets the Offset Slope value of a selected Gear Pipe Block	BOOL
MLGearWriteRatio	Sets the Ratio value of a selected Gear Pipe Block	BOOL
MLGearWriteRatSlp	Sets the Ratio Slope value of a selected Gear Pipe Block	BOOL

2.1.10.1 Usage example of Gear Functions

The output value starts with offset = 0 and gain = 1 (blue line)

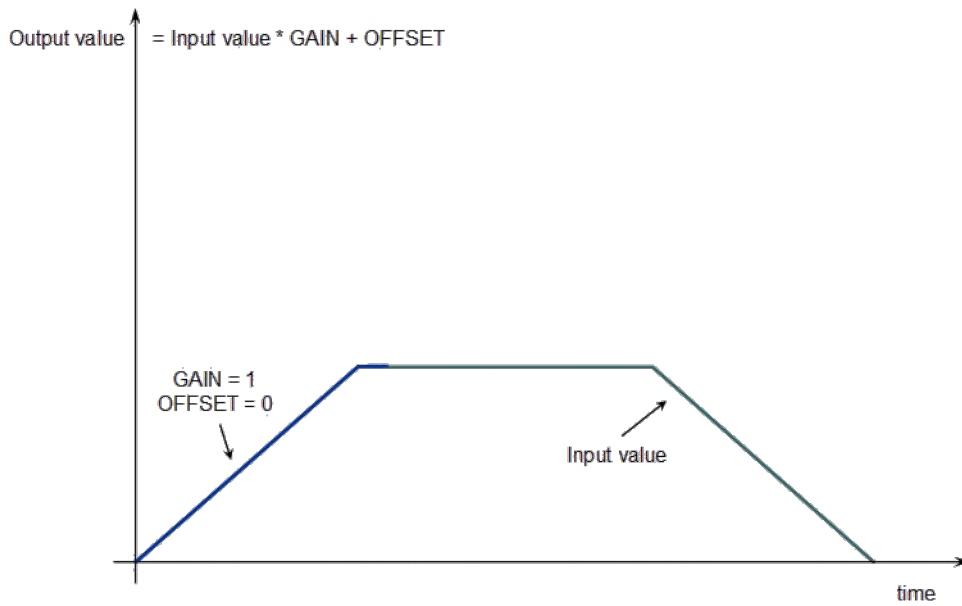

You can call the **MLGearWriteOff** function to modify the Offset (where Offset_Slope is set with the **MLGearWriteOSlp** function).

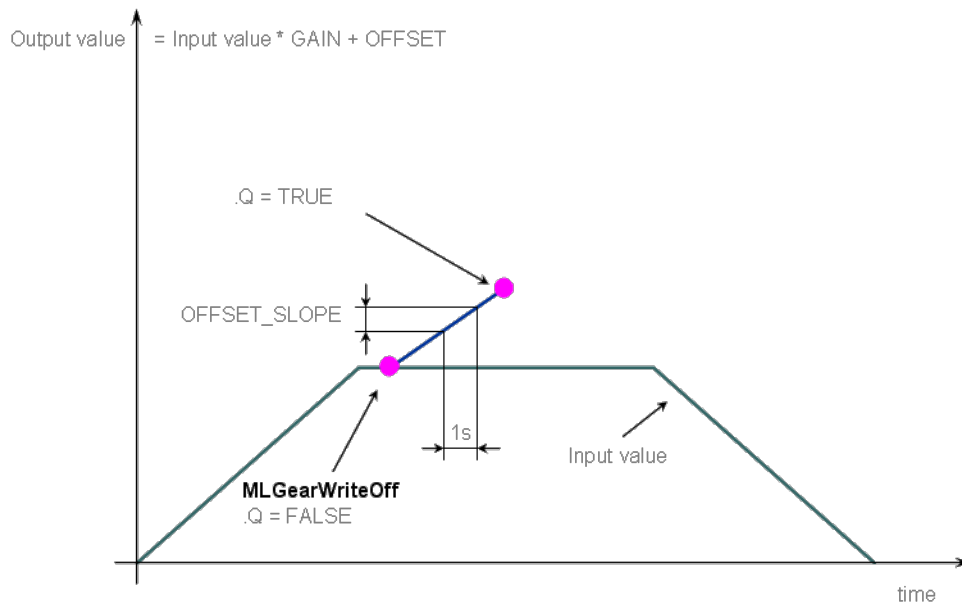

After setting the Offset (Q=TRUE in the previous figure), you can call the **MLGearWriteRatio** function to modify the gear Ratio (where Gain_Slope is set with the **MLGearWriteRatSlp** function).

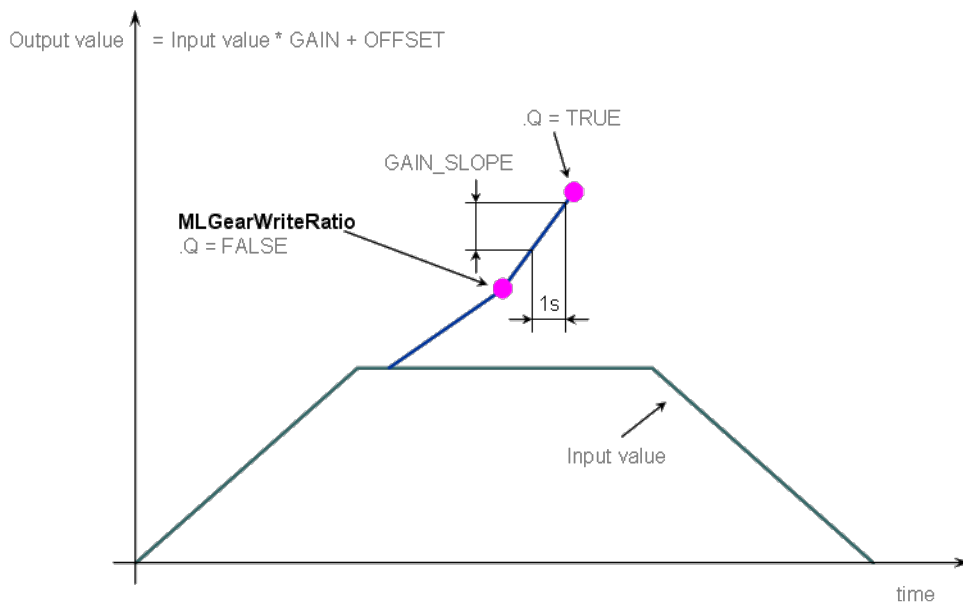

The output value is finally adapted with the gear offset and ratio (blue line).

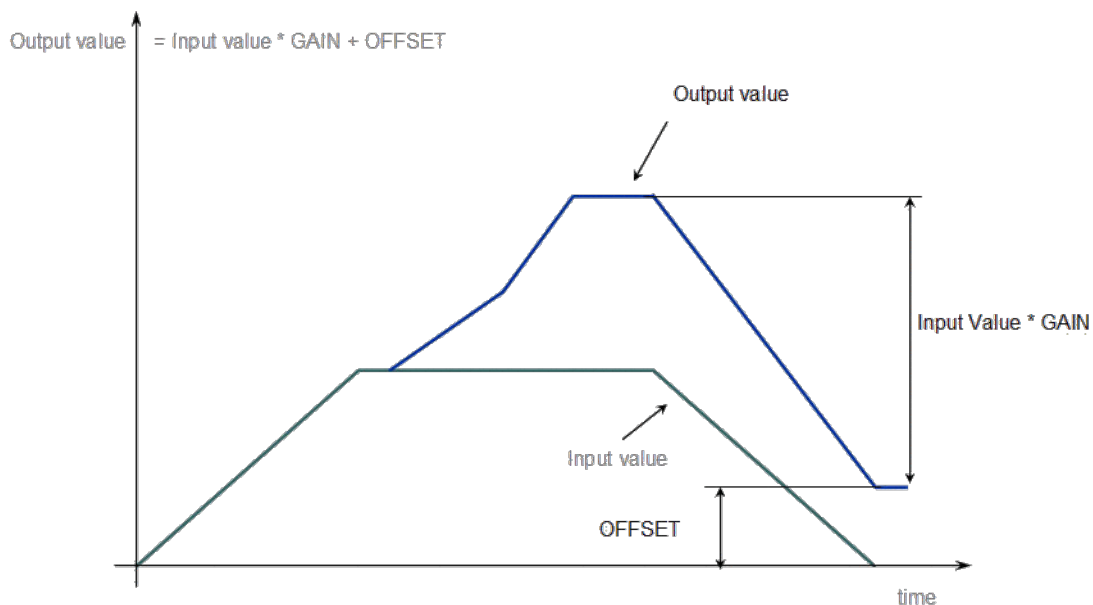

Figure 1-36: Gear Functions Usage

2.1.10.2 MLGearInit Pipe Network ✓

2.1.10.2.1 Description

Initializes a Gear Pipe Block for use in a PLC Program. This function block is automatically called if a Gear Block is added to the Pipe Network, with user-defined settings entered in the Pipe Blocks Properties screen.

The Pipe Block is assigned a **Name**, **Ratio**, **Offset**, and **Slopes** for changes in Ratio and Offset values. You can also choose between Modulo or Not modulo mode. Slopes set the limit at which step changes in Ratio and Offset are implemented.

The output of a Gear Block = Input value * Ratio + Offset

⚠ IMPORTANT

Be sure to set $\text{RatioSlope} < (\text{Ratio} * \text{EtherCAT Update Rate})$. The Gear block will make a jump (without a ramp) from one gear to the next when the RatioSlope is greater than the Ratio change factor multiplied by the update rate scale factor.

NOTE

If the Gear block's input is a modulo value, and the position delta is greater than $\frac{1}{2}$ the modulo value within one sample period in the opposite direction, then the Gear block cannot detect the change in the direction of motion. As an example, suppose the sample period is 1 msec and the Master is configured for a 360 degree modulo and the Master position is changed by >180 degrees within 1 msec. In this case the Gear block cannot determine whether the direction is in the same or opposite direction.

To avoid modulo calculation problems, either deactivate and reactivate the PipeNetwork when forcing the Master position with [MLMstForcePos](#), or use a [MLMstAbs](#) or [MLMstRel](#) move to force the Master's position value. For example, to force the Master position to zero you could do the following:

```
PipeNetwork(MLPN_DEACTIVATE);
MLMstForcePos(PipeNetwork.MASTER, 0);
PipeNetwork(MLPN_ACTIVATE);
```

👉 TIP

Gear objects are normally created in the Pipe Network using the graphical engine. Then you do not have to add MLGearInit function blocks to their programs. Parameters are entered directly in pop-up windows, and the code is then automatically added to the current project.

2.1.10.2.2 Arguments**2.1.10.2.2.1 Input**

BlockID	Description	ID number of a created Pipe Block
	Data type	DINT
	Range	[-2147483648, 2147483648]
	Unit	N/A
	Default	GEAR
Ratio	Description	Ratio of new Gear Pipe Block. Values lower than 1.0 can be entered, but require a leading zero (for example 0.8 instead of .8)
	Data type	LREAL
	Range	—
	Unit	N/A
	Default	1.0
Offset	Description	Offset of new Gear Pipe Block. Values lower than 1.0 can be entered, but require a leading zero (for example 0.8 instead of .8)
	Data type	LREAL

	Range	—
	Unit	N/A
	Default	0.0
UseUserRatioSlope	Description	FALSE to use the maximum Slope, causing an instantaneous gear change within one cycle. TRUE to use user-defined RatioSlope
	Data type	BOOL
	Range	0, 1
	Unit	N/A
	Default	FALSE
RatioSlope	Description	User-defined limit at which step changes in Ratio are implemented. Values lower than 1.0 can be entered, but require a leading zero (for example 0.8 instead of .8)
	Data type	LREAL
	Range	—
	Unit	1/sec
	Default	0.0
UseUserOffsetSlope	Description	FALSE to use the maximum Slope, causing an instantaneous gear change within one cycle. TRUE to use user-defined OffsetSlope
	Data type	BOOL
	Range	0, 1
	Unit	N/A
	Default	FALSE
OffsetSlope	Description	User-defined limit at which step changes in Offset are implemented. Values lower than 1.0 can be entered, but require a leading zero (for example 0.8 instead of .8)
	Data type	LREAL
	Range	—
	Unit	User unit/sec
	Default	0.0
Modulo	Description	TRUE when mode is modulo. Modulo mode adapts the output values according to the ModuloPosition (modulo)
	Data type	BOOL
	Range	0, 1
	Unit	N/A

Default	FALSE
----------------	-------

2.1.10.2.2.2 Output

Default (.Q)	Description	Returns TRUE if the Gear Pipe Block is initialized
	Data type	BOOL
	Unit	N/A

2.1.10.2.2.3 Return Type

BOOL

2.1.10.2.3 Related Functions

[MLBlkCreate](#)

[MLGearWriteRatio](#)

2.1.10.2.4 Example

2.1.10.2.4.1 Structured Text

```

//Initialize a Gear Pipe Block named GEAR1 with:
// Ratio = 1,Offset = 0, User Ratio Slope OFF, User Ratio
// Slope = 0, Offset Slope = 0, and no Modulo
GEAR1 := MLBlkCreate( 'GEAR1', 'GEAR' );
MLGearInit( GEAR1, 1.0, 0.0, false, 0.0, false, 0.0, false);
    
```

2.1.10.2.4.2 Ladder Diagram

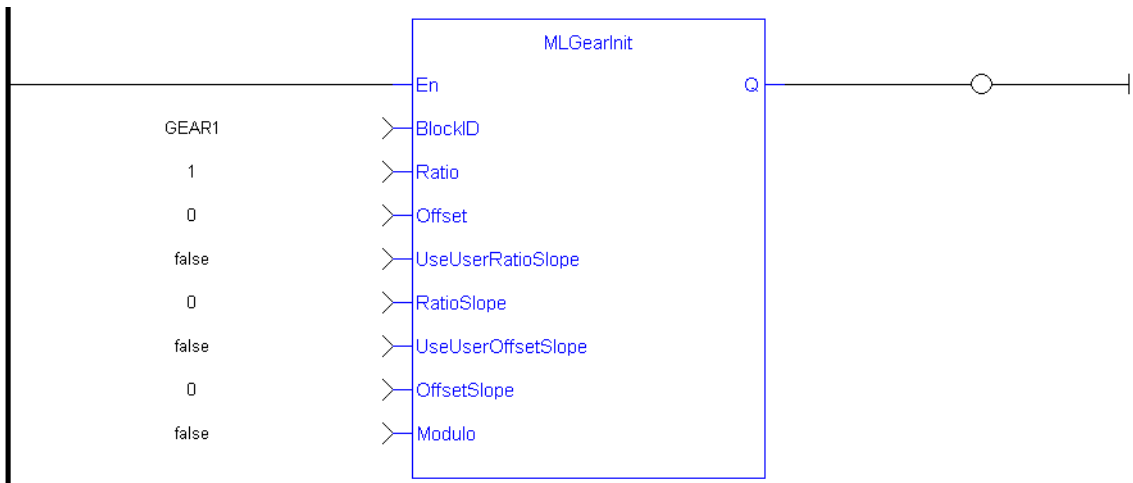

2.1.10.2.4.3 Function Block Diagram

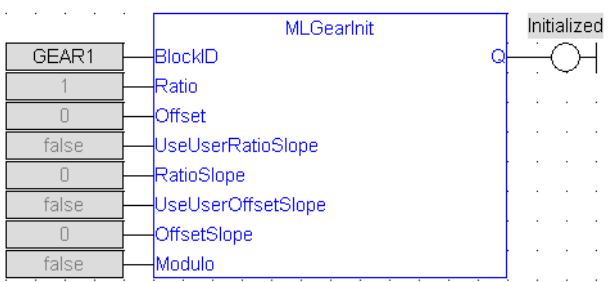

2.1.10.3 MLGearReadOffset Pipe Network ✓

2.1.10.3.1 Description

Returns the Offset value of a selected Gear Block from the Pipe Network.

The output of a Gear Block = Input value * Ratio + Offset

2.1.10.3.2 Arguments

2.1.10.3.2.1 Input

BlockID	Description	ID number of an initiated an initialized Gear object
	Data type	DINT
	Range	[-2147483648, 2147483648]
	Unit	N/A
	Default	—

2.1.10.3.2.2 Output

Offset	Description	The offset value currently assigned to the selected Gear Pipe Block
	Data type	LREAL
	Unit	User unit

2.1.10.3.3 Related Functions

[MLGearWriteOff](#)

[MLGearInit](#)

2.1.10.3.4 Example

2.1.10.3.4.1 Structured Text

```
//Find the Offset value of Gear1 Pipe Block
Gear1Offset := MLGearReadOffset( PipeNetwork.GEAR1 );
```

2.1.10.3.4.2 Ladder Diagram

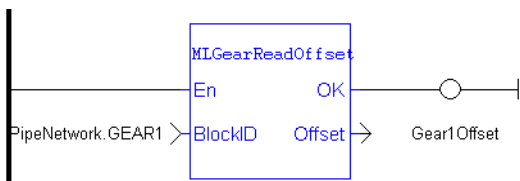

2.1.10.3.4.3 Function Block Diagram



2.1.10.4 MLGearReadOffSlp Pipe Network ✓

2.1.10.4.1 Description

Returns the Offset Slope value of a selected Gear Block from the Pipe Network. Offset Slope sets the limit in User Units per Second at which step changes in offset are implemented. The default value when creating a Gear Block is OFFSET_SLOPE_MAX or infinite.

2.1.10.4.2 Arguments

2.1.10.4.2.1 Input

BlockID	Description	ID number of an initiated an initialized Gear object
	Data type	DINT
	Range	[-2147483648, 2147483648]
	Unit	N/A
	Default	—

2.1.10.4.2.2 Output

Slope	Description	The offset slope value currently assigned to the selected Gear Pipe Block, which may be a different sign than what is programmed with MLGearWriteOSlp.
	Data type	LREAL
	Unit	User unit/sec

2.1.10.4.3 Related Functions

[MLGearWriteOSlp](#)

[MLGearInit](#)

2.1.10.4.4 Example

2.1.10.4.4.1 Structured Text

```
//Find the Offset Slope value of Gear1 Pipe Block
Gear1OffsetSlope := MLGearReadOffSlp(PipeNetwork.GEAR1);
```

2.1.10.4.4.2 Ladder Diagram

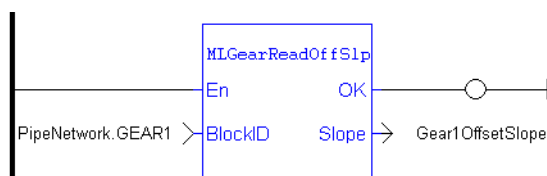

2.1.10.4.4.3 Function Block Diagram



2.1.10.5 MLGearReadRatio Pipe Network ✓

2.1.10.5.1 Description

Returns the Ratio value of a selected Gear Block from the Pipe Network. The output of a Gear Block
 $\text{= Input value} * \text{Ratio} + \text{Offset}$

2.1.10.5.2 Arguments

2.1.10.5.2.1 Input

BlockID	Description	ID number of an initialized Gear Pipe Block
	Data type	DINT
	Range	[-2147483648, 2147483648]
	Unit	N/A
	Default	—

2.1.10.5.2.2 Output

Ratio	Description	The Ratio value currently assigned to the selected Gear Pipe Block
	Data type	LREAL
	Unit	N/A

2.1.10.5.3 Related Functions

[MLGearWriteRatio](#)

[MLGearInit](#)

2.1.10.5.4 Example

2.1.10.5.4.1 Structured Text

```
//Find the Ratio value of Gear1 Pipe Block
Gear1Ratio := MLGearReadRatio(PipeNetwork.GEAR1);
```

2.1.10.5.4.2 Ladder Diagram

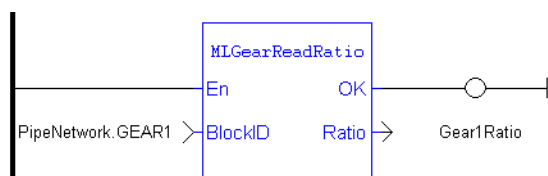

2.1.10.5.4.3 Function Block Diagram



2.1.10.6 MLGearReadRatSlp Pipe Network ✓

2.1.10.6.1 Description

Returns the Ratio Slope value of a selected Gear Block from the Pipe Network. Ratio Slope sets the limit in 1/Seconds (or s^{-1}) at which step changes in Ratio are implemented.

2.1.10.6.2 Arguments

2.1.10.6.2.1 Input

BlockID	Description	ID number of an initialized Gear Pipe Block
	Data type	DINT
	Range	[-2147483648, 2147483648]
	Unit	N/A
	Default	—

2.1.10.6.2.2 Output

Slope	Description	The Ratio Slope value currently assigned to the selected Gear Pipe Block, , which may be a different sign than what is programmed with MLGearWriteRatSlp.
	Data type	LREAL
	Unit	1/sec (or s^{-1})

2.1.10.6.3 Related Functions

[MLGearWriteRatSlp](#)

[MLGearInit](#)

2.1.10.6.4 Example

2.1.10.6.4.1 Structured Text

```
//Find the Ratio Slope value of Gear1 Pipe Block
Gear1RatioSlope := MLGearReadRatSlp(PipeNetwork.GEAR1);
```

2.1.10.6.4.2 Ladder Diagram

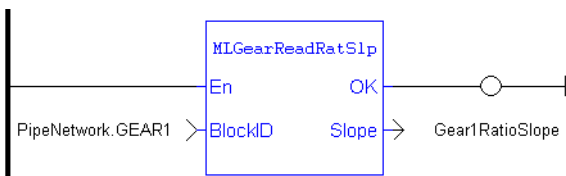

2.1.10.6.4.3 Function Block Diagram



2.1.10.7 MLGearWriteOff Pipe Network ✓

2.1.10.7.1 Description

Sets the Offset value of a selected Gear Pipe Block.

The output of a Gear Block = Input value * Ratio + Offset

TIP

Values lower than 1.0 can be entered, but require a leading zero (for example 0.8 instead of .8)

2.1.10.7.2 Arguments**2.1.10.7.2.1 Input**

BlockID	Description	ID number of an initialized Gear Pipe Block
	Data type	DINT
	Range	[-2147483648, 2147483648]
	Unit	N/A
	Default	—
Offset	Description	New Offset value to be assigned to selected Gear Pipe Block. Values lower than 1.0 can be entered, but require a leading zero (for example 0.8 instead of .8)
	Data type	LREAL
	Range	—
	Unit	User unit
	Default	—

2.1.10.7.2.2 Output

Default (.Q)	Description	Returns TRUE if Offset value is changed in the selected Gear Pipe Block
	Data type	BOOL
	Unit	N/A

2.1.10.7.2.3 Return Type

BOOL

2.1.10.7.3 Related Functions

[MLGearReadOffset](#)

[MLGearInit](#)

2.1.10.7.4 Example**2.1.10.7.4.1 Structured Text**

```
//Set the Offset value of Gear1 Pipe Block to 5 User Units
MLGearWriteOff(PipeNetwork.GEAR1, 5.0);
```

2.1.10.7.4.2 Ladder Diagram

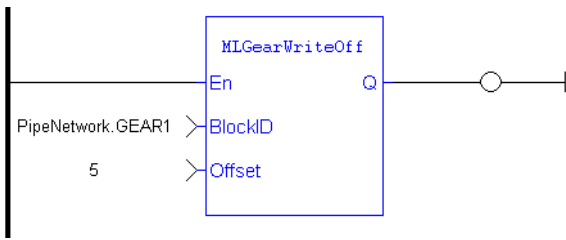

2.1.10.7.4.3 Function Block Diagram

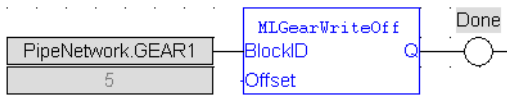

2.1.10.8 MLGearWriteOSlp Pipe Network ✓

2.1.10.8.1 Description

Sets the Offset Slope value of a selected Gear Pipe Block. Offset Slope sets the limit in User Units per Second at which step changes in offset are implemented. The default value when creating a Gear Block is OFFSET_SLOPE_MAX or infinite.

TIP

Values lower than 1.0 can be entered, but require a leading zero (for example 0.8 instead of .8)

2.1.10.8.2 Arguments

2.1.10.8.2.1 Input

BlockID	Description	ID number of an initialized Gear Pipe Block
	Data type	DINT
	Range	[-2147483648, 2147483648]
	Unit	N/A
	Default	—
Slope	Description	New Offset Slope value to be assigned to selected Gear Pipe Block. Values lower than 1.0 can be entered, but require a leading zero (for example 0.8 instead of .8)
	Data type	LREAL
	Range	—
	Unit	User unit/sec
	Default	—

2.1.10.8.2.2 Output

Default (.Q)	Description	Returns TRUE if Offset Slope value is changed in the selected Gear Pipe Block
	Data type	BOOL

Unit	N/A
-------------	-----

2.1.10.8.2.3 Return Type

BOOL

2.1.10.8.3 Related Functions

[MLGearReadOffSlp](#)

[MLGearInit](#)

2.1.10.8.4 Example

2.1.10.8.4.1 Structured Text

```
//Set the Offset Slope value of Gear1 Pipe Block to 100
MLGearWriteOSlp(PipeNetwork.GEAR1, 100.0);
```

2.1.10.8.4.2 Ladder Diagram

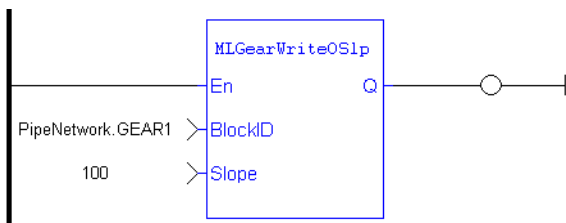

2.1.10.8.4.3 Function Block Diagram

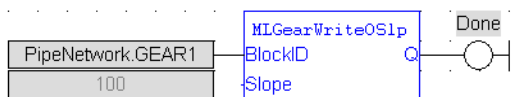

2.1.10.9 MLGearWriteRatio Pipe Network ✓

2.1.10.9.1 Description

Set the Ratio value of a selected Gear Pipe Block.

The output of a Gear Block = Input value * Ratio + Offset

TIP

Values lower than 1.0 can be entered, but require a leading zero (for example 0.8 instead of .8)

2.1.10.9.2 Arguments

2.1.10.9.2.1 Input

BlockID	Description	ID number of an initialized Gear Pipe Block
	Data type	DINT
	Range	[-2147483648, 2147483648]
	Unit	N/A

	Default	—
Ratio	Description	New Ratio value to be assigned to selected Gear Pipe Block. Values lower then 1.0 can be entered, but require a leading zero (for example 0.8 instead of .8)
	Data type	LREAL
	Range	—
	Unit	N/A
	Default	—

2.1.10.9.2.2 Output

Default (.Q)	Description	Returns TRUE if Ratio value is changed in the selected Gear Pipe Block
	Data type	BOOL
	Unit	N/A

2.1.10.9.2.3 Return Type

BOOL

2.1.10.9.3 Related Functions

[MLGearReadRatio](#)

[MLGearInit](#)

2.1.10.9.4 Example

2.1.10.9.4.1 Structured Text

```
//Set the Ratio value of Gear1 Pipe Block to 5
MLGearWriteRatio(PipeNetwork.GEAR1, 5.0);
```

2.1.10.9.4.2 Ladder Diagram

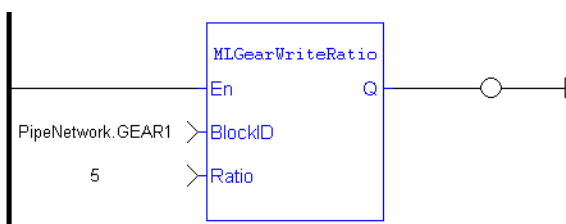

2.1.10.9.4.3 Function Block Diagram

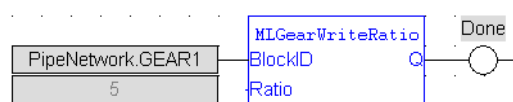

2.1.10.10 MLGearWriteRatSlp Pipe Network ✓

2.1.10.10.1 Description

Set the Ratio Slope value of a selected Gear Pipe Block. Ratio Slope sets the limit at which step changes in ratio are implemented.

⚠ IMPORTANT

Be sure to set $\text{RatioSlope} < (\text{Ratio} * \text{EtherCAT Update Rate})$. The Gear block will make a jump (without a ramp) from one gear to the next when the RatioSlope is greater than the Ratio change factor multiplied by the update rate scale factor.

👉 TIP

Values lower than 1.0 can be entered, but require a leading zero (for example 0.8 instead of .8)

NOTE

The GEAR block output will add a position offset to the GEAR block input when using a RatioSlope. See [RatioSlope Offset](#) in the Examples below.

2.1.10.10.2 Arguments

2.1.10.10.2.1 Input

BlockID	Description	ID number of an initialized Gear Pipe Block
	Data type	DINT
	Range	[-2147483648, 2147483648]
	Unit	N/A
	Default	—
Slope	Description	New Ratio Slope value to be assigned to selected Gear Pipe Block. Values lower than 1.0 can be entered, but require a leading zero (for example 0.8 instead of .8)
	Data type	LREAL
	Range	—
	Unit	1/sec
	Default	—

2.1.10.10.2.2 Output

Default (.Q)	Description	Returns TRUE if Ratio Slope value is changed in the selected Gear Pipe Block
	Data type	BOOL
	Unit	N/A

2.1.10.10.2.3 Return Type

BOOL

2.1.10.10.3 Related Functions

[MLGearReadOffSp](#)

[MLGearInit](#)

2.1.10.10.4 Example

2.1.10.10.4.1 Structured Text

```
//Set the Ratio Slope value of Gear1 Pipe Block to 100
MLGearWriteRatSlp(PipeNetwork.GEAR1, 100.0);
```

2.1.10.10.4.2 Ladder Diagram

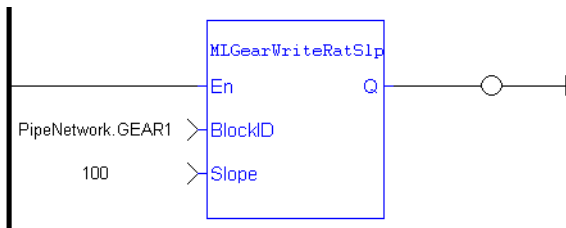

2.1.10.10.4.3 Function Block Diagram

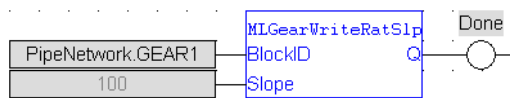

2.1.10.10.4.4 RatioSlope Offset

If MLGearWriteRatSlp is set as `MLGearWriteRatSlp(PipeNetwork.GEAR1 12 , Gear1RatioSlope 500.0);` to generate a ramp (instead of a step) when going from a gear ratio of 1 to 2, then there will be a position offset when the gear ratio settles as 2. In the image below the ratio goes from 1.0 to 2.0; Green is PN Gear Block Output and Red is Gearbox Input.



1. Green line: PN Gear Block Output
2. Red line: PN Gearbox Input
3. When the ratio is changed
4. Phase difference

If MLGearWriteRatSlp is set without a ramp,

```
MLGearWriteRatSlp( PipeNetwork.GEAR1 12 , Gear1RatioSlope 1e+301 );
```

, then there will not be an offset.



1. Green line: PN Gear Block Output
2. Red line: PN Gearbox Input
3. When the ratio changes
4. Synched

2.1.11 ssMotion Library - Integrator

Name	Description	Return type
MLIntInit	Initializes an integrator object	BOOL

Name	Description	Return type
MLIntWriteOutVal	Sets the output value of an integrator object	BOOL

2.1.11.1 MLIntInit Pipe Network ✓

2.1.11.1.1 Description

Initializes an integrator object. Function block is automatically called if an Integrator Block is added to the Pipe Network, with user-defined settings entered in the Pipe Blocks Properties screen.

Integrator object can operate in Modulo or not modulo mode. While in Modulo mode, the output values are adapted according to the entered ModuloPosition value.

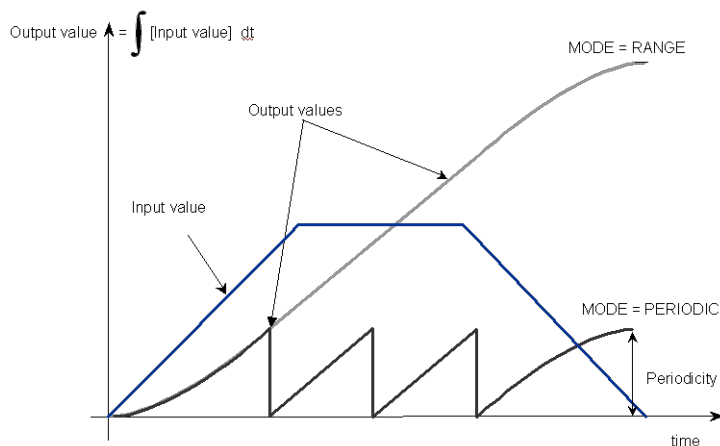

Figure 1-37: MLIntInit

NOTE

Integrator objects are normally created in the Pipe Network using the graphical engine. Then you do not have to add MLIntInit function blocks to their programs. Parameters are entered directly in pop-up windows, and the code is then automatically added to the current project.

2.1.11.1.2 Arguments

2.1.11.1.2.1 Input

BlockID	Description	ID number of a created Pipe Block
	Data type	DINT
	Range	[-2147483648, 2147483648]
	Unit	N/A
	Default	—
ModuloPosition	Description	Output ModuloPosition of Integrator object
	Data type	LREAL
	Range	—
	Unit	User unit
	Default	360.0

Modulo	Description	TRUE when mode is modulo. Modulo mode adapts the output values according to the ModuloPosition (modulo)
	Data type	BOOL
	Range	0, 1
	Unit	N/A
	Default	TRUE

2.1.11.1.2.2 Output

Default (.Q)	Description	Returns TRUE if the Integrator object is initialized
	Data type	BOOL
	Unit	N/A

2.1.11.1.2.3 Return Type

BOOL

2.1.11.1.3 Related Functions

[MLBlkCreate](#)

[MLIntWriteOutVal](#)

2.1.11.1.4 Example

2.1.11.1.4.1 Structured Text

```
//Initiate an Integrator Pipe Block named "MyIntegrator" with a Modulo of 360
MLIntInit(MyIntegrator, 360.0, true );
```

2.1.11.1.4.2 Ladder Diagram

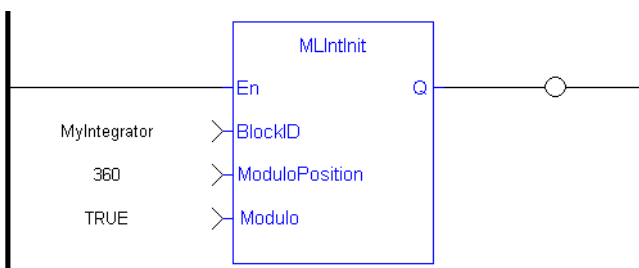

2.1.11.1.4.3 Function Block Diagram

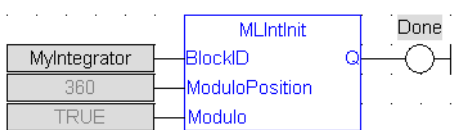

2.1.11.2 MLIntWriteOutVal Pipe Network ✓

2.1.11.2.1 Description

Sets the output value of an integrator object. This function can force the output to an entered value not dependent on the input value from the Pipe Network.

NOTE

Output value can jump to another value instantly after the function is executed if the Pipe Network is running.

NOTE

This function or function block returns cached data. See [Programming a Dual Core Controller](#) for more information.

2.1.11.2.2 Arguments

2.1.11.2.2.1 Input

BlockID	Description	ID number of an initiated Integrator object
	Data type	DINT
	Range	[-2147483648, 2147483648]
	Unit	N/A
	Default	—
Value	Description	Desired new output value of the selected Integrator object
	Data type	LREAL
	Range	—
	Unit	User unit
	Default	—

2.1.11.2.2.2 Output

Default (.Q)	Description	Returns TRUE if the output value if the Integrator object is changed
	Data type	BOOL
	Unit	N/A

2.1.11.2.2.3 Return Type

BOOL

2.1.11.2.3 Related Functions

[MLIntInit](#)

2.1.11.2.4 Example

2.1.11.2.4.1 Structured Text

```
//change the output value of an integrator object to 35
MLIntWriteOutVal ( PipeNetwork.MyIntegrator, 35.0 );
```

2.1.11.2.4.2 Ladder Diagram

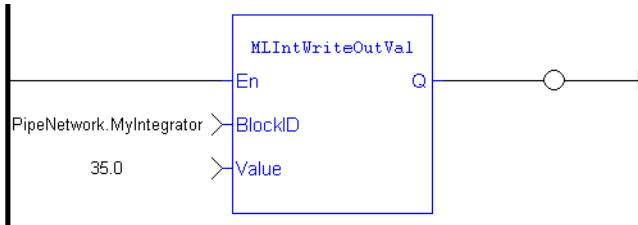

2.1.11.2.4.3 Function Block Diagram

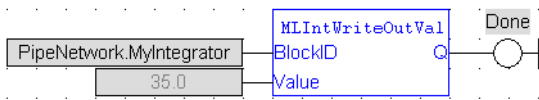

2.1.12 Motion Library - Master

TIP

- For an example of Master Functions, see [Usage example of Master Functions](#)

Functions sorted by types:

Motion Control	Inquiry Functions	Position setting
MLMstInit	MLMstReadAccel	MLMstAbs
MLMstRun	MLMstReadDecel	MLMstAdd
MLMstWriteAccel	MLMstReadInitPos	MLMstForcePos
MLMstWriteDecel	MLMstReadSpeed	MLMstRel
MLMstWriteSpeed	MLMstStatus	

Functions sorted in alphabetical order:

Name	Description	Return type
MLMstAbs	Does an absolute move	BOOL
MLMstAdd	Does an additive move relative for a specified distance from the endpoint of the previous move	BOOL
MLMstForcePos	Forces the specified position. Possible only when the block is not moving.	BOOL
MLMstInit	Initializes a master object (TMP generator)	BOOL
MLMstReadAccel	Gets the present acceleration value of a master block	None
MLMstReadDecel	Gets the present deceleration value of a master block	None
MLMstReadInitPos	Gets the initial position of a master block	None
MLMstReadSpeed	Gets the speed of a master block	None

Name	Description	Return type
MLMstRel	Does an Relative move for a specified distance from the current position	BOOL
MLMstRun	Jogs at the specified speed. Returns TRUE if the function succeeded	BOOL
MLMstStatus	Returns the status of the generator	DINT
MLMstWriteAccel	Sets the acceleration of a master block	BOOL
MLMstWriteDecel	Sets the deceleration of a master block	BOOL
MLMstWriteInitPos	Sets the initial position of a master block	BOOL
MLMstWriteSpeed	Sets the speed of a master block	BOOL

2.1.12.1 Usage example of Master Functions

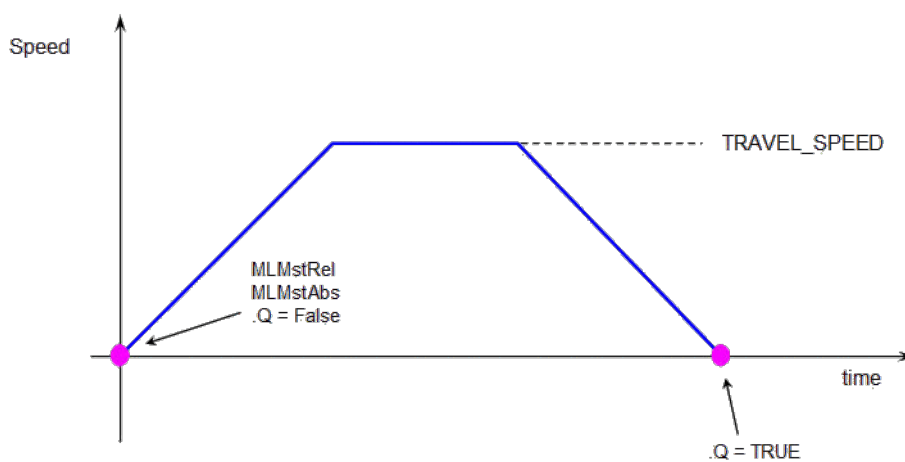

MLMstRun(0.0) reduce the speed down to 0.

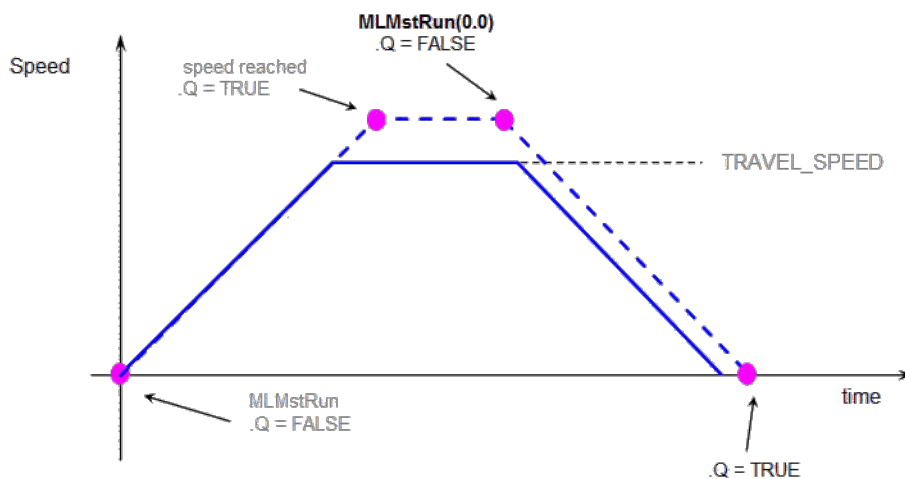

Figure 1-38: Master Functions Usage

2.1.12.2 MLMstAbs Pipe Network ✓

2.1.12.2.1 Description

Performs a move to an absolute position. Returns TRUE if the function succeeded.

2.1.12.2.2 Arguments

2.1.12.2.2.1 Input

BlockID	Description	ID name of the Master Block
	Data type	DINT
	Range	[-2147483648, 2147483648]
	Unit	N/A
	Default	—
Position	Description	Sets the value of the absolute destination position. When the Modulo is turned on, see more explanations below.
	Data type	LREAL
	Range	—
	Unit	User unit
	Default	—

2.1.12.3 Position with Modulo On

NOTE

This information applies to both [MLMstAbs](#) and [MLAxisAbs](#). For simplicity, the term Axis Block also refers to Master Block.

When the Modulo is turned on, the Axis Block moves to the targeted position during the corresponding period, calculated as follows:

- If the Position input is between 0 and the Modulo Position, then the Axis Block moves within the **current** period (no position rollover).
- If the Position input is greater than the Modulo Position, then the Axis Block moves during one of the **next** period (positive position rollover).

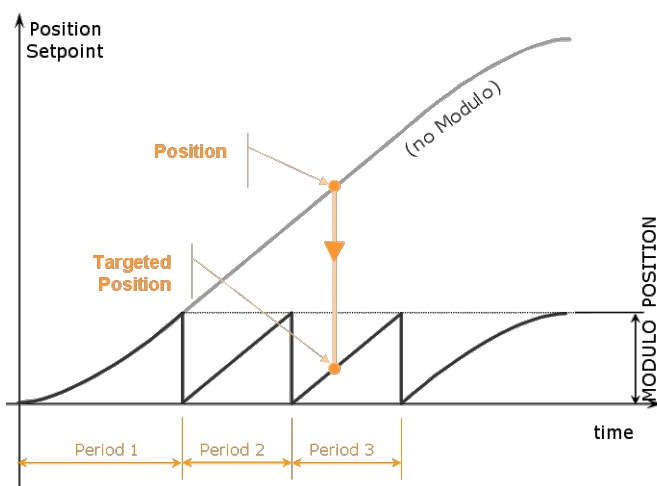

The Axis Block works similarly for negative positions: if the Position input is less than zero, then the Axis Block moves during one of the **previous** period (negative position rollover).

2.1.12.4 Forcing the direction of rotation

In some applications, the direction of rotation for the axis is forced in one direction only. As a consequence, the motor movement goes to the next or previous modulo in the following situations:

- If the **End Position** is less than the **Start Position** and the direction of rotation for the axis is forced to be clockwise (the **red point** shows when the modulo position is reached).

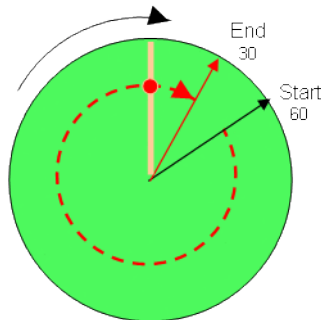

(see an example in row#2 of the table below)

- If the **End Position** is greater than the **Start Position** and the direction of rotation for the axis is forced to be counter clockwise.

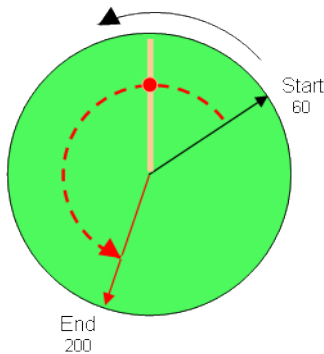

(see an example in row#4 of the table below)

Examples

Start Position	End Position	Direction of rotation	Cross Modulo	Position Input to MLAxisAbs (1)	RelativeDistance Moved (2)	
60	200	clockwise	No	200	140	(i.e. 200 - 60 + 0)
60	30	clockwise	Yes	390	330	(i.e. 30 - 60 + 360)
60	30	counter clockwise	No	30	-30	(i.e. 30 - 60 - 0)
60	200	counter clockwise	Yes	-160	-220	(i.e. 200 - 60 - 360)

With:

(1) **Position Input** = End Position (+ Modulo * *Direction of rotation*)

(2) **Relative Distance Moved** = End Position - Start Position (+ Modulo * *Direction of rotation*)

Where:

Direction of rotation = 1 when clockwise and -1 when anti-clockwise

2.1.12.5 Travel Speed Update with MLAxisAbs

The travel speed of the generator can be updated using the function block [MLAxisGenWriteSpd](#). Depending on the state of the generator, this speed is directly reflected on the current move or a future move.

- If MLAxisAbs is not currently being executed, the new travel speed will be applied for the trajectory calculation for a future MLAxisAbs command.
- If MLAxisAbs is currently being executed and a new MLAxisAbs with the same target position is called, the new travel speed will be taken into account only if the current state of the TMP profile is the constant velocity or acceleration. If the axis was decelerating to stop at the goal position the new travel speed will not be taken into account.
- If a MLAxisAbs is currently being executed and a new MLAxisAbs with a different target position is called, the new travel speed is taken into account.

Following are several examples.

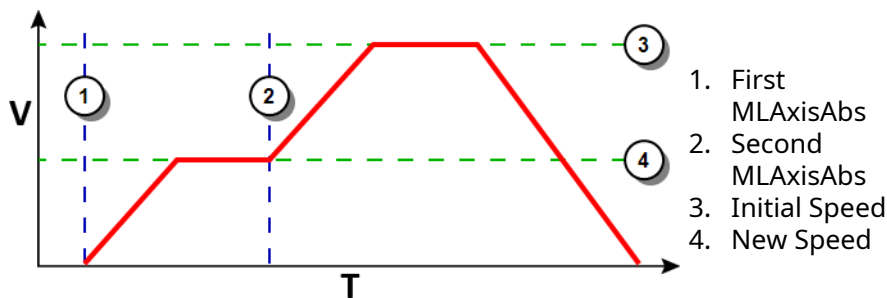

Figure 1-39: Initial speed is smaller than the new speed

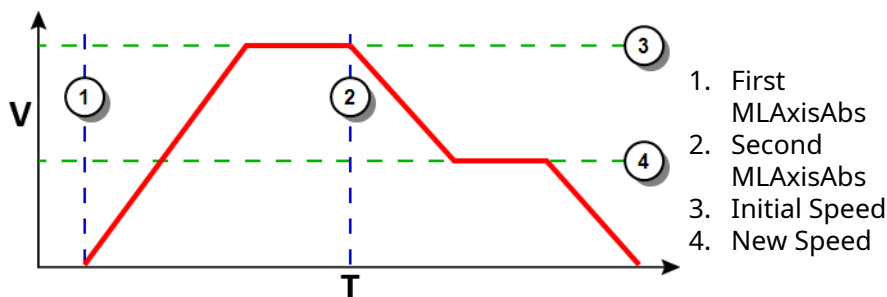

Figure 1-40: Initial speed is bigger than the new speed

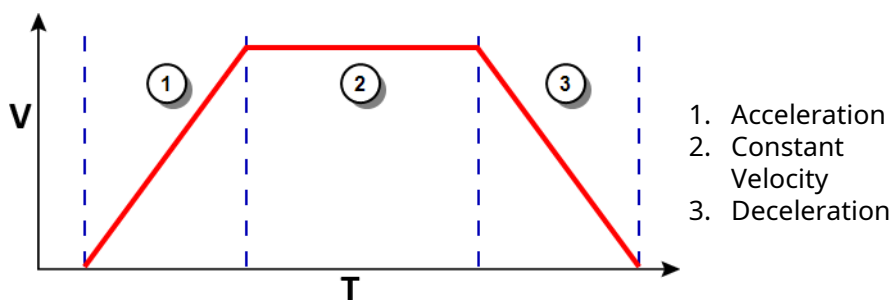

Figure 1-41: The speed update is taken into account only if the second MLAxisAbs is triggered during acceleration or constant velocity

2.1.12.5.0.1 Output

Default (.Q)	Description	Returns true when function successfully executes
	Data type	BOOL

Unit	N/A
------	-----

TIP

To reduce the load on the CPU, call MLMstAbs only once for each move. This can be achieved by adding a control variable, which is illustrated below.

```

// Master: modulo is on and modulo range is 0 - 360 with
// rollover at 360

If Not MoveStarted Then
    Position := 500;
    MLMstAbs( PipeNetwork.MASTER, Position);
    MovesStarted := TRUE;
End_if;

```

NOTE

Perform one of the following to prevent undesired axis movement if modulo is turned on.

- Verify that the **Position** value is within the modulo range.
- If the **Position** value is outside of the modulo range, call MLMstAbs function only once. See the **TIP** above for an example of how to do this.

2.1.12.5.1 Related Functions

[MLMstWriteSpeed](#)

[MLMstWriteDecel](#)

2.1.12.5.2 Examples**2.1.12.5.2.1 Structured Text**

```

//Make an absolute position move with a Master block called "MASTER" to
//position 1000.0
MLMstAbs( PipeNetwork.MASTER, 1000.0 );

```

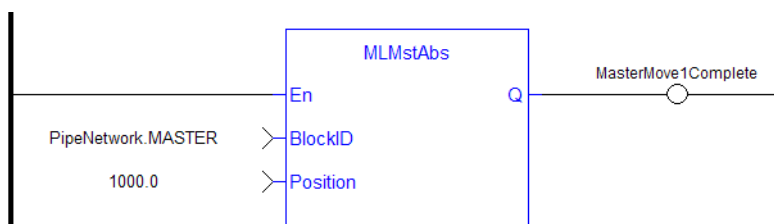
2.1.12.5.2.2 Ladder Diagram**2.1.12.5.2.3 Function Block Diagram****2.1.12.6 MLMstAdd** Pipe Network ✓**2.1.12.6.1 Description**

Performs a move for a specified distance relative to the endpoint of the previous move. Returns TRUE if the function succeeded.

2.1.12.6.2 Arguments

2.1.12.6.2.1 Input

EN	Description	Enables FB to be executed
	Data type	BOOL
	Range	0, 1
	Unit	N/A
	Default	—
Block ID	Description	ID name of the Master Block
	Data type	DINT
	Range	[-2147483648, 2147483648]
	Unit	N/A
	Default	—
DeltaPos	Description	Relative distance to move
	Data type	LREAL
	Range	—
	Unit	User unit
	Default	—

2.1.12.6.2.2 Output

Default (.Q)	Description	Returns true when function successfully executes
	Data type	BOOL
	Unit	N/A

2.1.12.6.3 Related Functions

[MLMstWriteSpeed](#)

[MLMstWriteDecel](#)

2.1.12.6.4 Example

2.1.12.6.4.1 Structured Text

```
//At the endpoint of the previous move, with the Master pipe block named
"MASTER", make a move of 750.0
MLMstAdd( PipeNetwork.MASTER, 750.0 );
```

2.1.12.6.4.2 Ladder Diagram

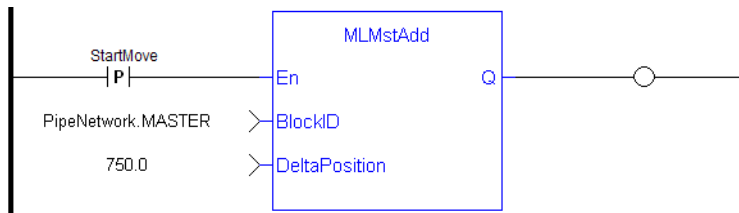

NOTE
 You must use a **pulse contact** to start the FB

2.1.12.6.4.3 Function Block Diagram



2.1.12.7 MLMstForcePos Pipe Network ✓

2.1.12.7.1 Description

Forces the position of a Master Block to a specified position. This block can only be executed when motion is not occurring. It can be used to force the master starting position to the desired values from which to start motion.

2.1.12.7.2 Arguments

2.1.12.7.2.1 Input

EN	Description	Enables FB to be executed
	Data type	BOOL
	Range	0, 1
	Unit	N/A
	Default	—
Block ID	Description	ID name of the Master Block
	Data type	DINT
	Range	[-2147483648, 2147483648]
	Unit	N/A
	Default	—
Position	Description	Defines the Master starting position when the motion starts
	Data type	LREAL
	Range	—
	Unit	User unit
	Default	—

2.1.12.7.2.2 Output

Default (.Q)	Description	Returns true when function successfully executes
	Data type	BOOL
	Unit	N/A

2.1.12.7.3 Related Functions

[MLMstReadInitPos](#)

2.1.12.7.4 Example

2.1.12.7.4.1 Structured Text

```
//Reset the output position of the Master Pipe Block named "Master" to 2500.0
MLMstForcePos(PipeNetwork.Master, 2500.0);
```

2.1.12.7.4.2 Ladder Diagram

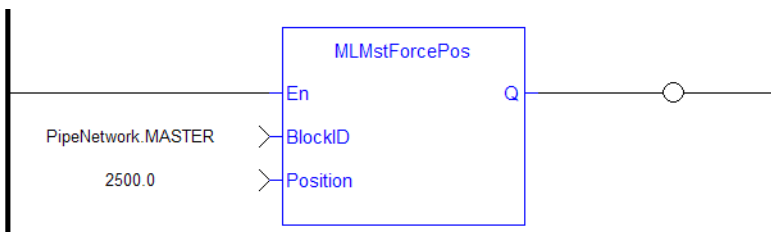

NOTE
You must use a [pulse contact](#) to start the FB

2.1.12.7.4.3 Function Block Diagram

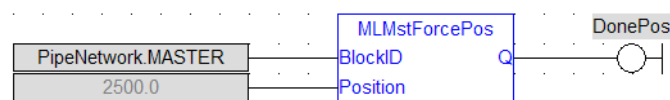

2.1.12.8 MLMstInit Pipe Network ✓

2.1.12.8.1 Description

Initializes a Master TMP (trapezoidal motion profile) generator block. This function is automatically created when the MLMaster Block is included in the Pipe Network Editor. Based on the parameters defined in the pipe block (see figure below), the Inputs for this function are initialized by default.

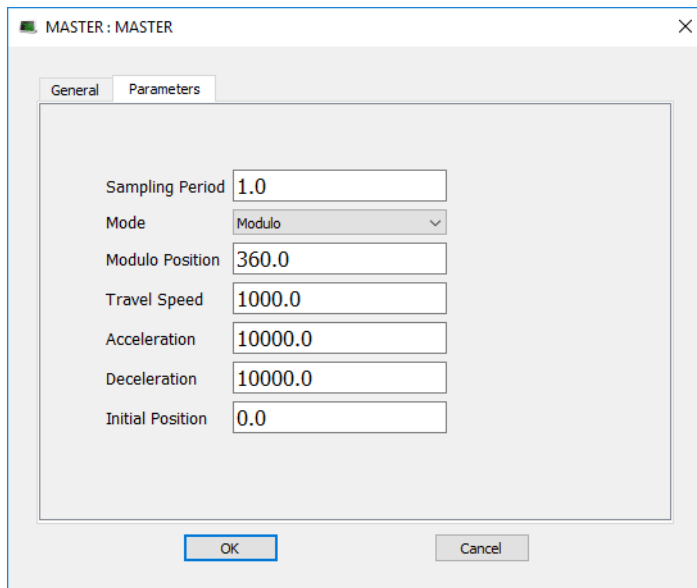

Figure 1-42: TMP Initialization

2.1.12.8.2 Arguments

2.1.12.8.2.1 Input

Block ID	Description	ID name of the Master Block
	Data type	DINT
	Range	[-2147483648, 2147483648]
	Unit	N/A
	Default	—
ModuloPosition	Description	Modulo Position for cyclic motion systems expressed in user logical units (Position Rollover Value)
	Data type	LREAL
	Range	—
	Unit	User unit
	Default	—
Period	Description	Sampling period of the generator expressed according to the update cycle (e.g. 2.0 means the sampling is done once every 2 cycles)
	Data type	LREAL
	Range	—
	Unit	Cycles
	Default	—
Speed	Description	Travel speed value expressed in user logical units per second. The travel speed value is used to set the constant speed part of the trapezoidal motion profile

	Data type	LREAL
	Range	—
	Unit	User unit / sec
	Default	—
Acceleration	Description	Acceleration value expressed in user logical units per second squared. The acceleration value is always used to generate the first part of the trapezoidal motion profile
	Data type	LREAL
	Range	—
	Unit	User unit/sec ²
	Default	—
Deceleration	Description	Deceleration value expressed in user logical units per second squared. The deceleration value is always used to generate the last part of the trapezoidal motion profile
	Data type	LREAL
	Range	—
	Unit	User unit/sec ²
	Default	—
Initial Position	Description	Initial position value expressed in user logical units. Used only at the pipe activation to initialize the position starting point
	Data type	LREAL
	Range	—
	Unit	User unit
	Default	—
Modulo	Description	The available modes are Modulo (True) or No modulo (False)
	Data type	BOOL
	Range	0, 1
	Unit	N/A
	Default	—

2.1.12.8.2.2 Output

Default (.Q)	Description	Returns true when function successfully executes
	Data type	BOOL
	Unit	N/A

2.1.12.8.3 Example

2.1.12.8.3.1 Structured Text

```
//Initialize a Master Pipe Block named "MASTER" to a Modulo of 360,
motion generator sample period of 1,Speed of 1000.0, Accel and Decel of
10000.0, Initial position of 0.0,
MLMstInit( PipeNetwork.MASTER, 360.0, 1.0, 1000.0, 10000.0, 10000.0, 0.0,
true );
```

2.1.12.8.3.2 Ladder Diagram

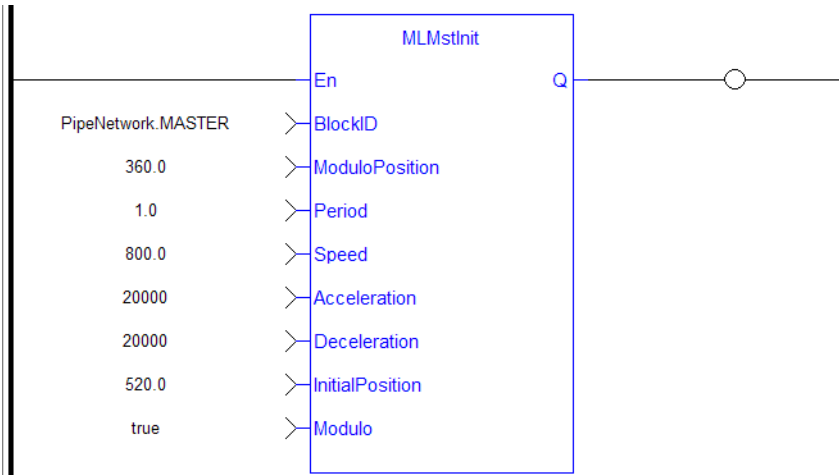

2.1.12.8.3.3 Function Block Diagram

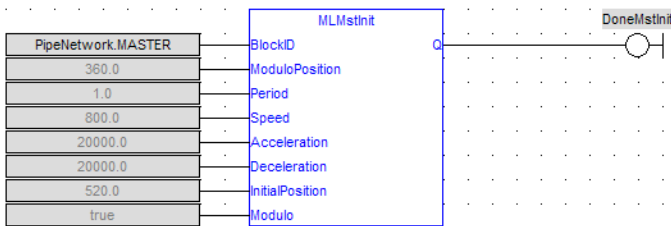

2.1.12.9 MLMstReadAccel Pipe Network ✓

2.1.12.9.1 Description

Get the presently used value for acceleration of a master block.

2.1.12.9.2 Arguments

2.1.12.9.2.1 Input

EN	Description	Enables FB to be executed
	Data type	BOOL
	Range	0, 1
	Unit	N/A
	Default	—
	Description	ID name of the Master Block

Data type	DINT
Range	[-2147483648, 2147483648]
Unit	N/A
Default	—

2.1.12.9.2.2 Output

OK	Description	Returns true when function successfully executes
	Data type	BOOL
	Unit	N/A
Acceleration	Description	Returns Acceleration value
	Data type	LREAL
	Unit	User unit/sec ²

2.1.12.9.3 Related Functions

[MLMstReadSpeed](#)

[MLMstReadDecel](#)

2.1.12.9.4 Example

2.1.12.9.4.1 Structured Text

```
// Read the present acceleration of a Pipe Block named "MASTER"
MLMstReadAccel( PipeNetwork.MASTER );
```

2.1.12.9.4.2 Ladder Diagram

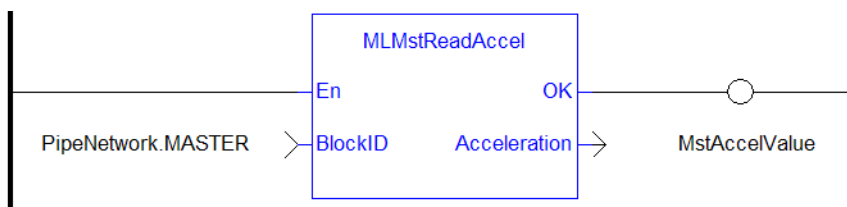

2.1.12.10 Function Block Diagram

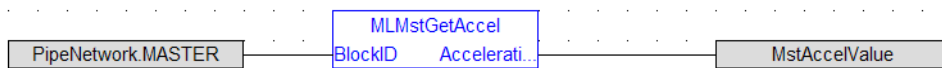

2.1.12.11 MLMstReadDecel Pipe Network ✓

2.1.12.11.1 Description

Get the presently used value for deceleration of a master block.

2.1.12.11.2 Arguments

2.1.12.11.2.1 Input

EN	Description	Enables FB to be executed
	Data type	BOOL
	Range	0, 1
	Unit	N/A
	Default	—
Block ID	Description	ID name of the Master Block
	Data type	DINT
	Range	[-2147483648, 2147483648]
	Unit	N/A
	Default	—

2.1.12.11.2.2 Output

OK	Description	Returns true when function successfully executes
	Data type	BOOL
	Unit	N/A
Deceleration	Description	Returns Deceleration value
	Data type	LREAL
	Unit	User unit/sec ²

2.1.12.11.3 Example

2.1.12.11.3.1 Structured Text

```
// Read the present deceleration of a Pipe Block named "MASTER"
MLMstReadDecel( PipeNetwork.MASTER );
```

2.1.12.11.3.2 Ladder Diagram



2.1.12.11.3.3 Function Block Diagram

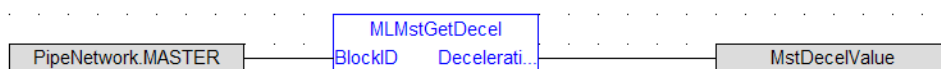

2.1.12.12 MLMstReadInitPos Pipe Network ✓

2.1.12.12.1 Description

Get the presently used value for initial position of a master block.

2.1.12.12.2 Arguments

2.1.12.12.2.1 Input

EN	Description	Enables FB to be executed
	Data type	BOOL
	Range	0, 1
	Unit	N/A
	Default	—
Block ID	Description	PipeNetwork Block
	Data type	DINT
	Range	[-2147483648, 2147483648]
	Unit	N/A
	Default	—

2.1.12.12.2.2 Output

OK	Description	Returns true when function successfully executes
	Data type	BOOL
	Unit	N/A
Position	Description	Returns Intial Postion
	Data type	LREAL
	Unit	User unit

2.1.12.12.3 Example

2.1.12.12.3.1 Structured Text

```
MstInitPos := MLMstReadInitPos ( PipeNetwork.MASTER );
```

2.1.12.12.3.2 Ladder Diagram

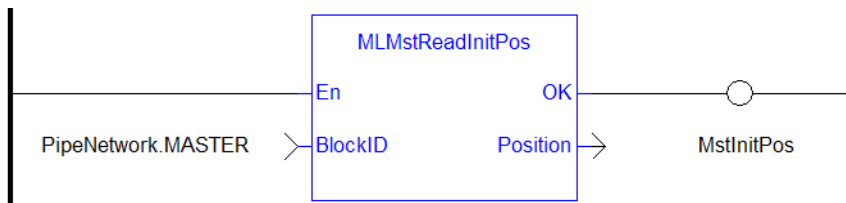

2.1.12.12.3.3 Function Block Diagram

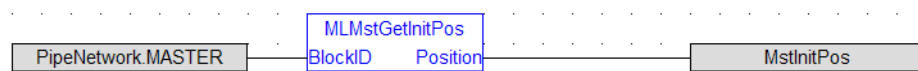

2.1.12.13 MLMstReadSpeed Pipe Network ✓

2.1.12.13.1 Description

Get the presently used value for speed of a master block.

2.1.12.13.2 Arguments

2.1.12.13.2.1 Input

EN	Description	Enables FB to be executed
	Data type	BOOL
	Range	0, 1
	Unit	N/A
	Default	—
Block ID	Description	ID name of the Master Block
	Data type	DINT
	Range	[-2147483648, 2147483648]
	Unit	N/A
	Default	—

2.1.12.13.2.2 Output

OK	Description	Returns true when function successfully executes
	Data type	BOOL
	Unit	N/A
Speed	Description	Returns current Speed
	Data type	LREAL
	Unit	User unit /sec

2.1.12.13.3 Related Functions

[MLMstReadAccel](#)

[MLMstReadDecel](#)

2.1.12.13.4 Example

2.1.12.13.4.1 Structured Text

```
MstSpeed := MLMstReadSpeed( PipeNetwork.MASTER );
```

2.1.12.13.4.2 Ladder Diagram

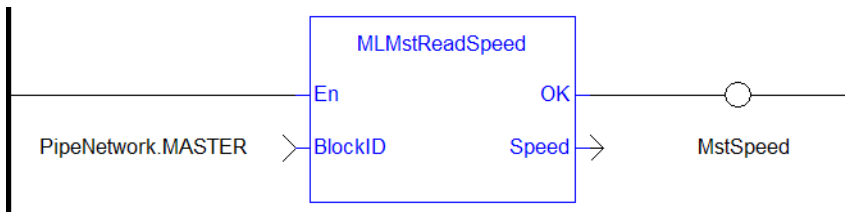

2.1.12.13.4.3 Function Block Diagram

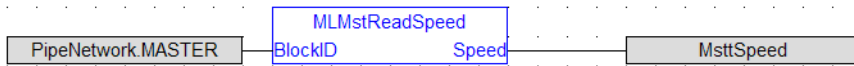

2.1.12.14 MLMstRel Pipe Network ✓

2.1.12.14.1 Description

Performs a move for a specified distance relative to the current position. Returns TRUE if the function succeeded.

2.1.12.14.2 Arguments

2.1.12.14.2.1 Input

EN	Description	Enables FB to be executed
	Data type	BOOL
	Range	0, 1
	Unit	N/A
	Default	—
Block ID	Description	ID name of the Master Block
	Data type	DINT
	Range	[-2147483648, 2147483648]
	Unit	N/A
	Default	—
DeltaPos	Description	Relative distance to move
	Data type	LREAL
	Range	—
	Unit	User unit
	Default	—

2.1.12.14.2.2 Output

Default (.Q)	Description	Returns true when function successfully executes
	Data type	BOOL
	Unit	N/A

2.1.12.14.3 Related Functions

MLMstWriteSpeed

MLMstWriteDecel

2.1.12.14.4 Example

2.1.12.14.4.1 Structured Text

```
MLMstRel( PipeNetwork.MASTER, 750.0 );
```

2.1.12.14.4.2 Ladder Diagram

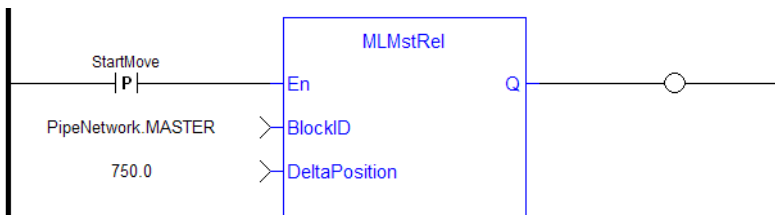

NOTE
You must use a pulse contact to start the FB

2.1.12.14.4.3 Function Block Diagram



2.1.12.15 MLMstRun Pipe Network ✓

2.1.12.15.1 Description

Jog at the specified speed. Returns TRUE if the function succeeded.

2.1.12.15.2 Arguments

2.1.12.15.2.1 Input

EN	Description	Enables FB to be executed
	Data type	BOOL
	Range	0, 1
	Unit	N/A
	Default	—
Block ID	Description	ID name of the Master Block
	Data type	DINT
	Range	[-2147483648, 2147483648]
	Unit	N/A
	Default	—

Speed	Description	Speed to jog motor
	Data type	LREAL
	Range	—
	Unit	User unit/sec
	Default	—

2.1.12.15.2.2 Output

Default (.Q)	Description	Returns true when function successfully executes
	Data type	BOOL
	Unit	N/A

2.1.12.15.3 Related Functions

[MLMstWriteSpeed](#)

[MLMstWriteDecel](#)

2.1.12.15.4 Example

2.1.12.15.4.1 Structured Text

```
MLMstRun( PipeNetwork.MASTER, 1250.0 );
```

2.1.12.15.4.2 Ladder Diagram

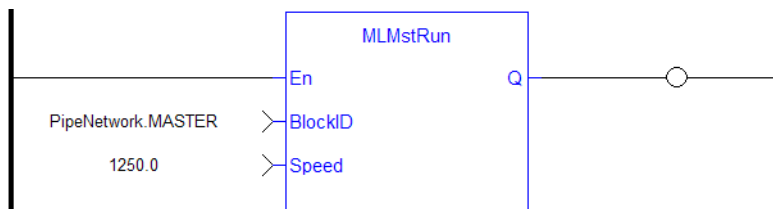

2.1.12.15.4.3 Function Block Diagram

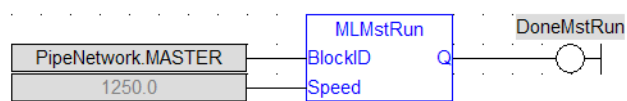

2.1.12.16 MLMstStatus Pipe Network

2.1.12.16.1 Description

The value returned is the state being executed by the TMP generator as it processes the various motion commands. Some states are transitory, others are stable until the next event takes place. The following terms are relevant to the returned values.

Term	Definition
Running	Speed is non-zero

Term	Definition
Stopped	Speed is zero
Positioning	A target position has been programmed with a relative, additive or absolute command.
Status	Definition
0	(New speed programmed) is entered when a jog move (MLMstRun) is commanded and the current speed is not at the commanded speed.
1	(Stable state Running or Stopped) is entered when a jog move (MLMstRun) is commanded and the current speed is at the commanded speed. (Stable state Running or Stopped) is entered when a position move is programmed and motion is completed.
2	(Speed change) is entered when the current speed is greater than the commanded speed.
3	(Speed reversal while positioning) is entered when a position move is programmed and the distance to go requires a speed reversal.
4	(Acceleration while positioning) current speed is below the travel speed
5	(Constant Speed while positioning) is entered when a positioning move is commanded and the current speed is at the commanded speed.
6	(Deceleration while positioning) is entered when a positioning move is commanded and the current speed is changing to achieve the target position at zero speed.
7	(Micro step) is entered when a small change in position is required and the current speed is zero.

2.1.12.16.2 Arguments

2.1.12.16.2.1 Input

EN	Description	Enables FB to be executed
	Data type	BOOL
	Range	0, 1
	Unit	N/A
	Default	—
Block ID	Description	ID name of the Master Block
	Data type	DINT
	Range	[-2147483648, 2147483648]
	Unit	N/A
	Default	—

2.1.12.16.2.2 Output

OK	Description	Returns true when function successfully executes
	Data type	BOOL
	Unit	N/A

Default (.Q)	Description	Returns the status of the generator
	Data type	DINT
	Unit	N/A

2.1.12.16.3 Example

2.1.12.16.3.1 Structured Text

```
MasterStatus := MLMstStatus( PipeNetwork.MASTER );
```

2.1.12.16.3.2 Ladder Diagram

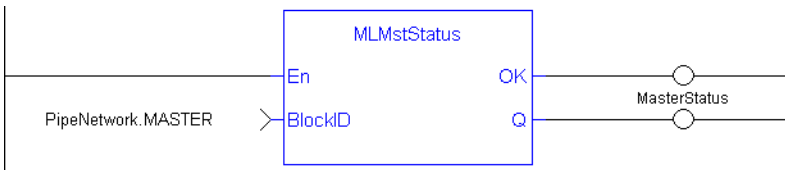

2.1.12.16.3.3 Function Block Diagram



2.1.12.17 MLMstWriteAccel Pipe Network ✓

2.1.12.17.1 Description

Set the acceleration of a master block. Returns TRUE if the function succeeded.

2.1.12.17.2 Arguments

2.1.12.17.2.1 Input

EN	Description	Enables FB to be executed
	Data type	BOOL
	Range	0, 1
	Unit	N/A
	Default	—
Block ID	Description	ID name of the Master Block
	Data type	DINT
	Range	[-2147483648, 2147483648]
	Unit	N/A
	Default	—
Acceleration	Description	Acceleration value expressed in user logical units per second squared

Data type	LREAL
Range	—
Unit	User unit/sec ²
Default	—

2.1.12.17.2.2 Output

Default (.Q)	Description	Returns true when function successfully executes
	Data type	BOOL
	Unit	N/A

2.1.12.17.3 Related Functions

[MLMstAbs](#)

[MLMstRel](#)

[MLMstWriteSpeed](#)

[MLMstWriteDecel](#)

2.1.12.17.4 Example

2.1.12.17.4.1 Structured Text

```
MLMstWriteAccel ( PipeNetwork.MASTER, 40000.0 );
```

2.1.12.17.4.2 Ladder Diagram

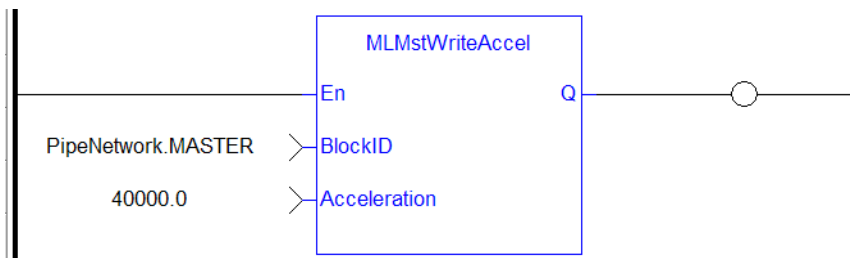

2.1.12.17.4.3 Function Block Diagram

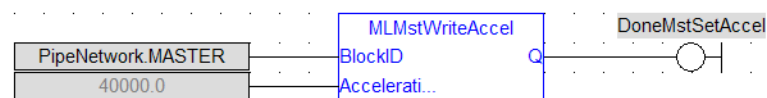

2.1.12.18 MLMstWriteDecel Pipe Network ✓

2.1.12.18.1 Description

Set the deceleration of a master block. Returns TRUE if the function succeeded.

2.1.12.18.2 Arguments

2.1.12.18.2.1 Input

EN	Description	Enables FB to be executed
	Data type	BOOL
	Range	0, 1
	Unit	N/A
	Default	—
Block ID	Description	ID name of the Master Block
	Data type	DINT
	Range	[-2147483648, 2147483648]
	Unit	N/A
	Default	—
Deceleration	Description	Deceleration value
	Data type	LREAL
	Range	—
	Unit	User unit/sec ²
	Default	—

2.1.12.18.2.2 Output

Default (.Q)	Description	Returns true when function successfully executes
	Data type	BOOL
	Unit	N/A

2.1.12.18.3 Related Functions

[MLMstWriteSpeed](#)

2.1.12.18.4 Example

2.1.12.18.4.1 Structured Text

```
MLMstWriteDecel( PipeNetwork.MASTER, 40000.0 );
```

2.1.12.18.4.2 Ladder Diagram

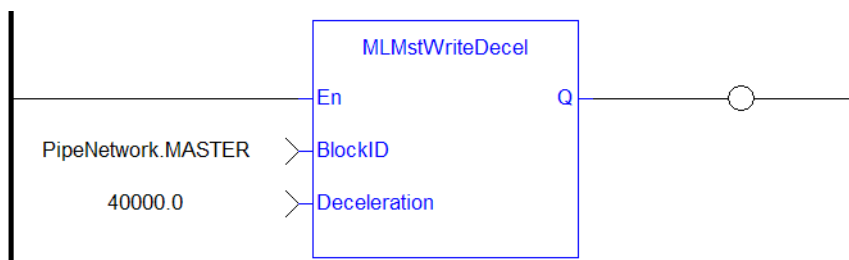

2.1.12.18.4.3 Function Block Diagram

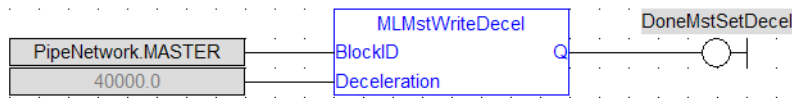

2.1.12.19 MLMstWriteInitPos Pipe Network ✓

2.1.12.19.1 Description

Set the initial position of a master block. Returns TRUE if the function succeeded.

2.1.12.19.2 Arguments

2.1.12.19.2.1 Input

EN	Description	Enables FB to be executed
	Data type	BOOL
	Range	0, 1
	Unit	N/A
	Default	—
Block ID	Description	ID name of the Master Block
	Data type	DINT
	Range	[-2147483648, 2147483648]
	Unit	N/A
	Default	—
Position	Description	Initial position
	Data type	LREAL
	Range	—
	Unit	User unit
	Default	—

2.1.12.19.2.2 Output

Default (.Q)	Description	Returns true when function successfully executes
	Data type	BOOL
	Unit	N/A

2.1.12.19.3 Example

2.1.12.19.3.1 Structured Text

```
MLMstWriteInitPos ( PipeNetwork.MASTER, 120.0 );
```

2.1.12.19.3.2 Ladder Diagram

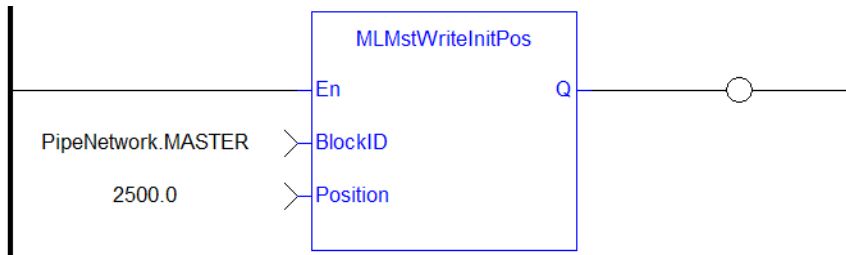

2.1.12.19.3.3 Function Block Diagram



2.1.12.20 MLMstWriteSpeed Pipe Network ✓

2.1.12.20.1 Description

Set the speed of motion for the [MLMstAbs](#) and [MLMstRel](#) blocks. Returns TRUE if the function succeeded. This function does not generate any motion.

2.1.12.20.2 Arguments

2.1.12.20.2.1 Input

EN	Description	Enables FB to be executed
	Data type	BOOL
	Range	0, 1
	Unit	N/A
	Default	—
Block ID	Description	ID name of the Master Block
	Data type	DINT
	Range	[-2147483648, 2147483648]
	Unit	N/A
	Default	—
Speed	Description	Speed of the motion
	Data type	LREAL
	Range	—
	Unit	User unit/sec
	Default	—

2.1.12.20.2.2 Output

Default (.Q)	Description	Returns true when function successfully executes
---------------------	--------------------	--

Data type	BOOL
Unit	N/A

2.1.12.20.3 Related Functions

[MLMstWriteDecel](#)

2.1.12.20.4 Example

2.1.12.20.4.1 Structured Text

```
MLMstWriteSpeed( PipeNetwork.MASTER, 400.0 );
```

2.1.12.20.4.2 Ladder Diagram

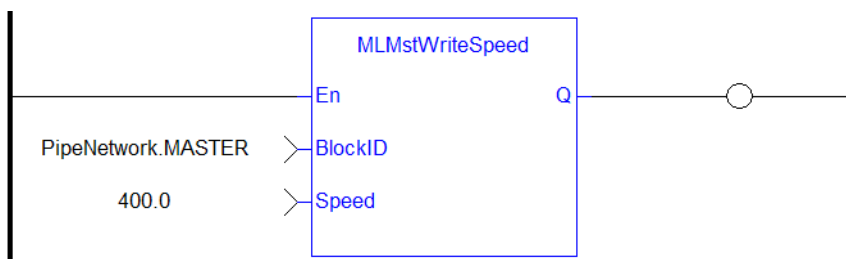

2.1.12.20.4.3 Function Block Diagram



2.1.13 Motion Library - Phaser

TIP

- For an example of Phaser functions, see [Usage example of Phaser Functions](#)

Names	Description	Return type
MLPhaInit	Initializes a phaser Pipe Block	BOOL
MLPhaReadPhase	Gets the phase value of a phaser block	None
MLPhaReadSlope	Gets the phase slope value of a phaser block	None
MLPhaWritePhase	Sets the phase value of a phaser block	BOOL
MLPhaWriteSlope	Sets the phase slope value of a phaser block	BOOL
MLPhaReadActPhase	Get the actual phase value of a phaser block.	LREAL

TIP

There is a delay when using an external encoder. The delay is five cycles (2 cycles to read the encoder from the AKD via EtherCAT, 1 cycle for computing, 2 cycles for sending the new position set point to the AKD). This lag error is speed proportional (5 cycles * speed). A Phaser block can be used to compensate for this lag.

When executing, the phaser block is in one of three states: **Standby**, **Changing phase**, or **Applying phase**.

Standby	Entered when the Block is initialized. Exits to the State "Changing Phase" when the Phase value is changed via the MLPhaWritePhase command
Changing Phase	Entered when a new value is programmed, and exits to "Applying phase" state when the programmed phase offset is reached. The current Phase offset value is slewed to the new phase offset by the amount of the slew value.
Applying Phase	Entered when the programmed Phase value is reached. Exits to the Changing phase state whenever a new value is programmed via the MLPhaWritePhase function changes the Phase Offset target.

2.1.13.1 Usage example of Phaser Functions

You can call [MLPhaWritePhase](#) function to modify the Phase value..

You can call [MLPhaWriteSlope](#) to modify the rate of change of phase, or slope, applied when the Phase value is changed.

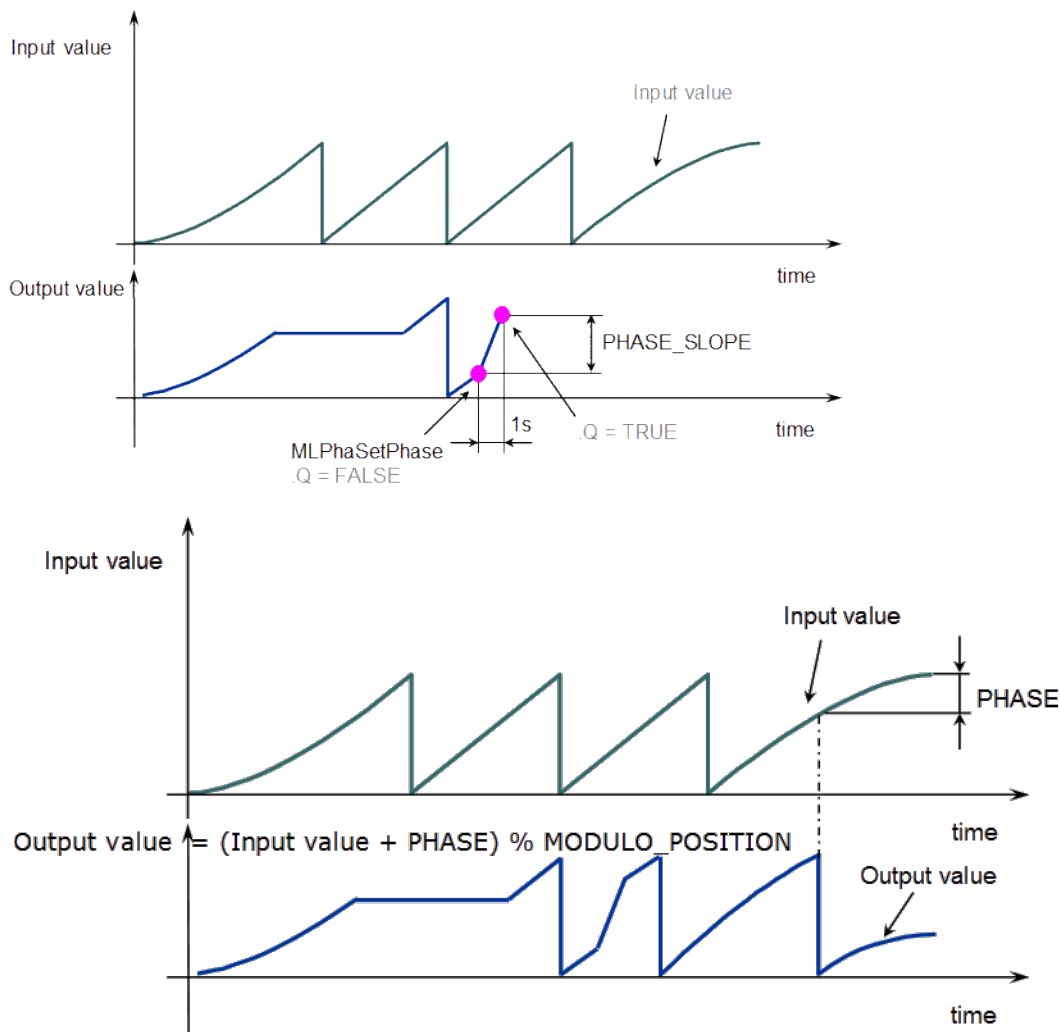

Figure 1-43: Phaser Functions Usage

NOTE

% MODULO_POSITION is in the equation to take into account the modulo (periodicity) of the value.

2.1.13.2 MLPhaInit [Pipe Network](#) ✓

2.1.13.2.1 Description

Initializes a phaser Pipe Block. Returns TRUE if the function succeeded.

This function block is automatically called by the Function PipeNetwork(MLPN_CREATE_OBJECTS) if a Phaser Block is added to the Pipe Network, with user-defined settings entered in the Pipe Blocks Properties screen.

The Phaser Pipe Block is assigned a Name, OUTPUT_PERIOD, PHASE, PHASE_SLOPE_TYPE, and STANDBY_VALUE.

2.1.13.2.2 Arguments

2.1.13.2.2.1 Input

BlockID	Description	ID Name of a Phaser function block in the Pipe Network
	Data type	DINT
	Range	[-2147483648, 2147483648]
	Unit	N/A
	Default	—
ModuloPosition	Description	Rollover Position of the Phaser block
	Data type	LREAL
	Range	—
	Unit	User unit
	Default	360.0
Phase	Description	Amount of Phase adjustment
	Data type	LREAL
	Range	—
	Unit	N/A
	Default	0.0
UseUserSlope	Description	Setting determines if Max Slope or user-defined slope is used
	Data type	BOOL
	Range	0, 1
	Unit	N/A
	Default	Max Slope
PhaseSlope	Description	User-defined slope for making the phase adjustment
	Data type	LREAL
	Range	—
	Unit	User unit/sec
	Default	0.0

StandbyValue	Description	This value is output from the Phaser Block, when the pipe is active, until the MLPhaWritePhase function is executed.
	Data type	LREAL
	Range	—
	Unit	N/A
	Default	0.0

2.1.13.2.2.2 Output

Default (.Q)	Description	Returns True if the function block is successfully executing
	Data type	BOOL
	Unit	N/A

2.1.13.2.3 Related Functions

[MLPhaReadPhase](#)

[MLPhaReadSlope](#)

[MLPhaInit](#)

[MLPhaWritePhase](#)

2.1.13.2.4 Example

2.1.13.2.4.1 Structured Text

```
//Initialize a Phaser Pipe Block named "PhaseAdjust" to a Modulo of 720, phase offset value of 30, use the Max Slope
MLPhaInit( PipeNetwork.PhaseAdjust , 720, 30, false, 30 , 10 );
```

2.1.13.2.4.2 Ladder Diagram

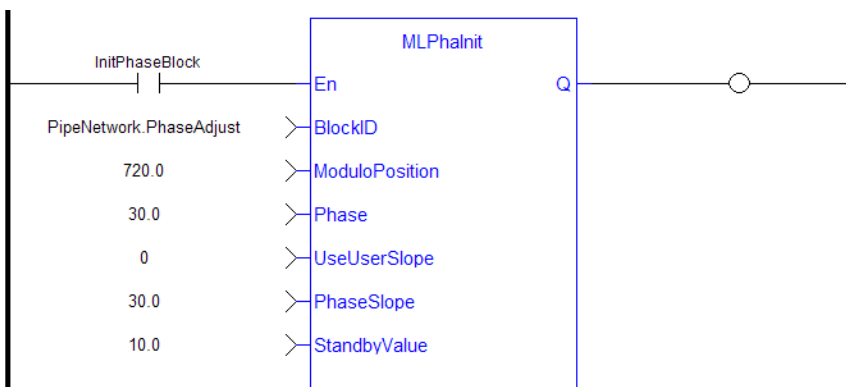

2.1.13.2.4.3 Function Block Diagram

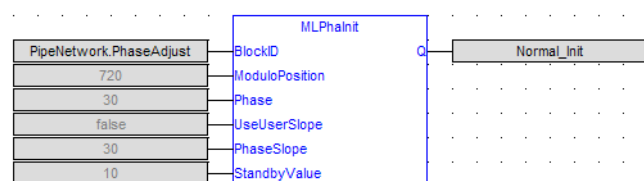

2.1.13.3 MLPhaReadActPhase

2.1.13.3.1 Description

Get the actual phase value of a phaser block.

If a "PHASE_SLOPE_USER" (refer to [MLPhaReadSlope](#) and [MLPhaWriteSlope](#)) value is being used, the new phase (refer to [MLPhaWritePhase](#)) isn't set immediately; the phase will be ramped with the slope value from the old phase value to the new phase value. MLPhaReadActPhase returns this ramping value.

[MLPhaReadPhase](#) returns the new value and this also when the phaser is still ramping. If using max slope means no ramping MLPhaReadActPhase and MLPhaReadPhase return always the same value.

NOTE

This function or function block returns cached data. See [Programming a Dual Core Controller](#) for more information.

2.1.13.3.2 Arguments

2.1.13.3.2.1 Input

Enable	Description	
	Data type	
	Range	
	Unit	
	Default	
BlockID	Description	ID Name of a Phaser function block in the Pipe Network
	Data type	DINT
	Range	[-2147483648, 2147483648]
	Unit	N/A
	Default	—

2.1.13.3.2.2 Output

OK	Description	
	Data type	
	Unit	
Phase	Description	
	Data type	LREAL
	Unit	

2.1.13.3.3 Related Functions

MLPhaReadPhase, MLPhaWritePhase, MLPhaReadSlope, MLPhaWriteSlope

2.1.13.4 MLPhaReadPhase

2.1.13.4.1 Description

Get the phase value of a phaser block.

2.1.13.4.2 Arguments

2.1.13.4.2.1 Input

BlockID	Description	ID Name of a Phaser function block in the Pipe Network
	Data type	DINT
	Range	[-2147483648, 2147483648]
	Unit	N/A
	Default	—

2.1.13.4.2.2 Output

Phase	Data type	LREAL
--------------	------------------	-------

2.1.13.4.3 Example

2.1.13.4.3.1 Structured Text

```
PresentPhase := MLPhaReadPhase( PipeNetwork.PhaseAdjust );
```

2.1.13.4.3.2 Ladder Diagram



2.1.13.4.3.3 Function Block Diagram

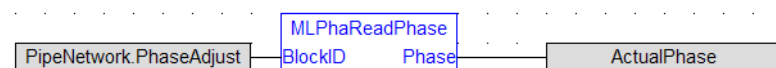

2.1.13.5 MLPhaReadSlope Pipe Network ✓

2.1.13.5.1 Description

Get the phase slope value of a phaser block.

2.1.13.5.2 Arguments

2.1.13.5.2.1 Input

BlockID	Description	ID Name of a Phaser function block in the Pipe Network
	Data type	DINT
	Range	[-2147483648, 2147483648]

Unit	N/A
Default	—

2.1.13.5.2.2 Output

Slope	Description	Present Slope value
	Data type	LREAL
	Unit	User unit/sec
	Default	Value defined in the setup of a Phaser Block within a Pipe Network. Depending on the phase slope type setting, it is the VALUE in "PHASE_SLOPE_USER", "PHASE" or the max slope.

2.1.13.5.3 Related Functions

[MLPhaReadSlope](#)

2.1.13.5.4 Example

2.1.13.5.4.1 Structured Text

```
PresentSlope :=MLPhaReadSlope( PipeNetwork.PhaseAdjust );
```

2.1.13.5.4.2 Ladder Diagram



2.1.13.5.4.3 Function Block Diagram



2.1.13.6 MLPhaWritePhase Pipe Network ✓

2.1.13.6.1 Description

Set the phase value of a phaser block.

2.1.13.6.2 Arguments

2.1.13.6.2.1 Input

BlockID	Description	ID Name of a Phaser function block in the Pipe Network
	Data type	DINT
	Range	[-2147483648, 2147483648]

	Unit	N/A
	Default	—
Phase	Description	Phase value
	Data type	LREAL
	Range	—
	Unit	User unit/sec
	Default	Value defined in the setup of a phaser Block within a Pipe Network. It is in the “PHASE” field in the parameter tab

2.1.13.6.2.2 Output

Default (.Q)	Description	Returns True if the function block is successfully executing
	Data type	BOOL
	Unit	N/A

2.1.13.6.3 Related Functions

[MLPhaReadPhase](#)

2.1.13.6.4 Example

2.1.13.6.4.1 Structured Text

```
MLPhaWritePhase( PipeNetwork.PhaseAdjust , 30 );
```

2.1.13.6.4.2 Ladder Diagram



2.1.13.6.4.3 Function Block Diagram

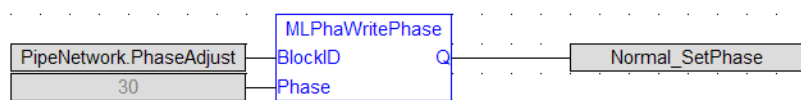

2.1.13.7 MLPhaWriteSlope Pipe Network ✓

2.1.13.7.1 Description

Set the phase value of a phaser block. Returns TRUE if the function succeeded.

2.1.13.7.2 Arguments

2.1.13.7.2.1 Input

BlockID	Description	ID Name of a Phaser function block in the Pipe Network
Data type		DINT
Range		[-2147483648, 2147483648]
Unit		N/A
Default		—
Description	Description	Set slope of phase adjust
Data type		LREAL
Range		—
Unit		User unit/sec
Default		Value defined in the setup of a Phaser Block within a Pipe Network. Depending on the phase slope type setting, it is the VALUE in "PHASE_SLOPE_USER", "PHASE" or the max slope.

2.1.13.7.2.2 Output

Default (.Q)	Description	Returns True if the function block is successfully executing
	Data type	BOOL
	Unit	N/A

2.1.13.7.3 Related Functions

[MLPhaReadSlope](#)

2.1.13.7.4 Example

2.1.13.7.4.1 Structured Text

```
MLPhaWriteSlope( PipeNetwork.PhaseAdjust , 10 );
```

2.1.13.7.4.2 Ladder Diagram

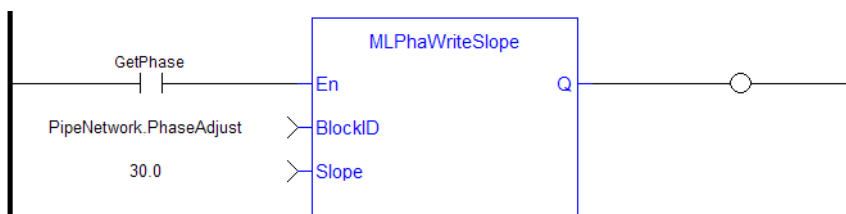

2.1.13.7.4.3 Function Block Diagram

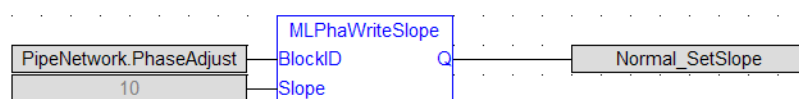

2.1.14 Motion Library - PMP

Name	Description	Return type
MLPmpAbs	Moves to an Absolute Position	BOOL
MLPmpForcePos	Forces the specified position. Possible only when the block is not moving.	BOOL
MLPmpInit	Initializes a PMP object (Parabolic Motion Profile generator) with user-defined settings	BOOL
MLPmpReadAccel	Gets the Acceleration parameter of a PMP block	None
MLPmpReadFstSpd	Gets the FirstTravelSpeed parameter of a PMP block	None
MLPmpReadInitPos	Gets the InitialPosition parameter of a PMP block	None
MLPmpReadJerk	Gets the Jerk parameter of a PMP block	None
MLPmpReadLstSpd	Gets the LastTravelSpeed parameter of a PMP block	None
MLPmpRel	Does two subsequent relative moves	BOOL
MLPmpRun	Jog the generator at the specified speed	BOOL
MLPmpStatus	Returns the status of the PMP block generator	None
MLPmpWriteAccel	Sets the acceleration parameter of a PMP block	BOOL
MLPmpWriteFstSpd	Sets the FirstTravelSpeed parameter of a PMP block	BOOL
MLPmpWriteJerk	Sets the jerk parameter of a PMP block	BOOL
MLPmpWriteLstSpd	Sets the LastTravelSpeed parameter of a PMP block	BOOL

2.1.14.1 MLPmpAbs

2.1.14.1.1 Description

Move to an Absolute Position using a parabolic acceleration profile. The FIRST_TRAVEL_SPEED is used as the velocity for the motion. JERK determines the level of parabolic acceleration. Returns TRUE if the function succeeded.

2.1.14.1.2 Arguments

2.1.14.1.2.1 Input

BlockID	Description	ID Name of the PMP function block in the Pipe Network
	Data type	DINT
	Range	[-2147483648, 2147483648]
	Unit	N/A
	Default	—
Position	Description	Absolute Position of motor/load to be at after this FB is complete
	Data type	LREAL
	Range	—

Unit	User unit
Default	—

2.1.14.1.2.2 Output

Default (.Q)	Description	Returns True if the function block is successfully executing
	Data type	BOOL
	Unit	N/A

2.1.14.1.3 Related Functions

- [MLPmpWriteAccel](#)
- [MLPmpWriteJerk](#)
- [MLPmpWriteFstSpd](#)

2.1.14.1.4 Example

2.1.14.1.4.1 Structured Text

```
MLPmpAbs ( PipeNetwork.PmpMaster, 1000.0 ) ;
```

2.1.14.1.4.2 Ladder Diagram

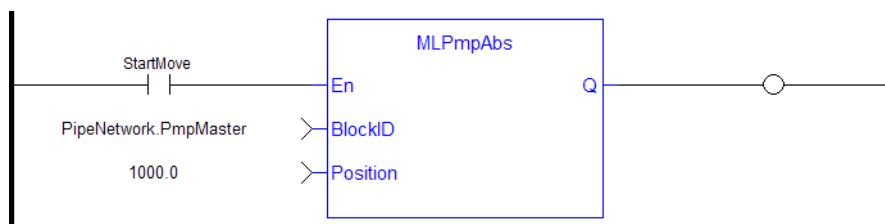

2.1.14.1.4.3 Function Block Diagram

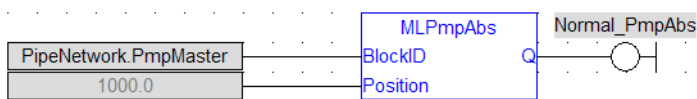

2.1.14.2 MLPmpForcePos Pipe Network ✓

2.1.14.2.1 Description

Forces the position of a PMP Block to a specified position. This block can only be executed when motion is not occurring. It can be used to force the PMP starting position to the desired values from which to start motion.

2.1.14.2.2 Arguments

2.1.14.2.2.1 Input

EN	Description	Enables FB to be executed
	Data type	BOOL

	Range	0, 1
	Unit	N/A
	Default	—
Block ID	Description	ID name of the PMP Block
	Data type	DINT
	Range	[-2147483648, 2147483648]
	Unit	N/A
	Default	—
Position	Description	Defines the PMP starting position when the motion starts
	Data type	LREAL
	Range	—
	Unit	User unit
	Default	—

2.1.14.2.2.2 Output

Default (.Q)	Description	Returns true when function successfully executes
	Data type	BOOL
	Unit	N/A

2.1.14.2.3 Related Functions

[MLPmpReadInitPos](#)

2.1.14.2.4 Example

2.1.14.2.4.1 Structured Text

```
MLPmpForcePos( PipeNetwork.PMP, 2500.0 );
```

2.1.14.2.4.2 Ladder Diagram

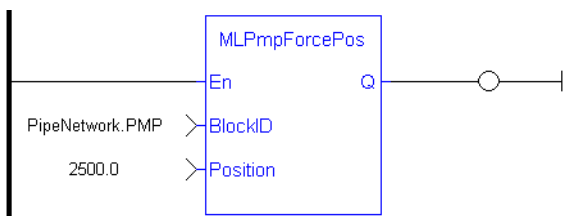

NOTE

You must use a [pulse contact](#) to start the FB

2.1.14.2.4.3 Function Block Diagram



2.1.14.3 MLPmpInit Pipe Network ✓

2.1.14.3.1 Description

Initializes a Pmp Block for use in a PLC Program. This function block is automatically called by the Function PipeNetwork(MLPN_CREATE_OBJECTS) if a Pmp Block is added to the Pipe Network, with user-defined settings entered in the Pipe Blocks Properties screen.

The Pmp Pipe Block is assigned a Name, SAMPLING_PERIOD, MODULO_POSITION, FIRST_TRAVEL_SPEED, LAST_TRAVEL_SPEED, ACCELERATION, JERK, and INITIAL Position. Some of these parameters can be changes in an application program using other MLPmp function blocks

A MLPmpRel function block is used to make a bi directional motion. First movement in one direction, then a return motion back to the initial position. A MLPmpAbs function block is use to move one direction to an absolute position.

NOTE

Pmp objects are normally created in the Pipe Network using the graphical engine. Then you do not have to add MLPmpInit function blocks to their programs. Parameters are entered directly in pop-up windows, and the code is then automatically added to the current project.

2.1.14.3.2 Arguments

2.1.14.3.2.1 Input

BlockID	Description	ID Name of a PMP function block in the Pipe Network
	Data type	DINT
	Range	[-2147483648, 2147483648]
	Unit	N/A
	Default	—
ModuloPosition	Description	Modulo Position for cyclic motion systems expressed in user logical units (Position Rollover Value)
	Data type	LREAL
	Range	—
	Unit	User unit
	Default	360.0
Period	Description	Sampling period of the generator expressed according to the update cycle (e.g. 2.0 means the sampling is done once every 2 cycles)
	Data type	LREAL
	Range	—
	Unit	User unit
	Default	1.0

FirstTravelSpeed	Description	First Travel Speed of the motion
	Data type	LREAL
	Range	—
	Unit	User unit/sec
	Default	100.0
LastTravelSpeed	Description	Last Travel Speed of the motion
	Data type	LREAL
	Range	—
	Unit	User unit/sec
	Default	100.0
Acceleration	Description	Acceleration of the Pmp block motion
	Data type	LREAL
	Range	—
	Unit	User unit/sec ²
	Default	1000.0
Jerk	Description	Jerk
	Data type	LREAL
	Range	—
	Unit	User unit/sec ³
	Default	0
InitialPosition	Description	Initial Position of the Pmp block when the Pipe Network is start up
	Data type	LREAL
	Range	—
	Unit	User unit
	Default	0
Modulo	Description	The available modes are Modulo (True) or No modulo (False)
	Data type	BOOL
	Range	0, 1
	Unit	N/A
	Default	—

2.1.14.3.2.2 Output

Default (.Q)	Description	Returns True if the function block is successfully executing
	Data type	BOOL
	Unit	N/A

2.1.14.3.3 Related Functions

- [MLPmpReadAccel](#)
- [MLPmpReadFstSpd](#)
- [MLPmpReadInitPos](#)
- [MLPmpReadJerk](#)
- [MLPmpReadLstSpd](#)

2.1.14.3.4 Example

2.1.14.3.4.1 Structured Text

```
//Initialize a PMP Pipe Block named "PMP" to a modulo roll over of 360,
motion generator sample period of 1,First Travel Speed of 800.0, Second
Travel Speed of 20000.0, Accel of 20000.0,Jerk of 520.0, Initial position
of 0.0
MLPmpInit( PipeNetwork.Pmp , 360.0, 1.0, 800.0, 20000.0, 20000.0, 520.0,
0, true ) ;
```

2.1.14.3.4.2 Ladder Diagram

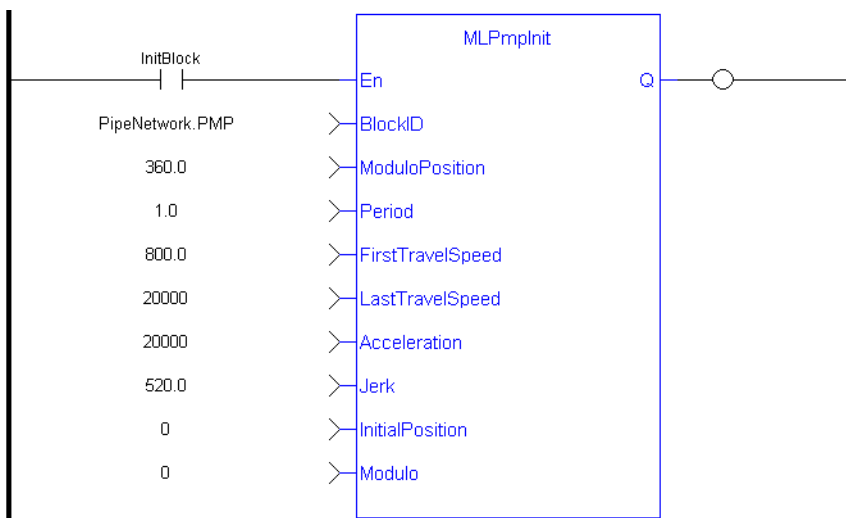

2.1.14.3.4.3 Function Block Diagram

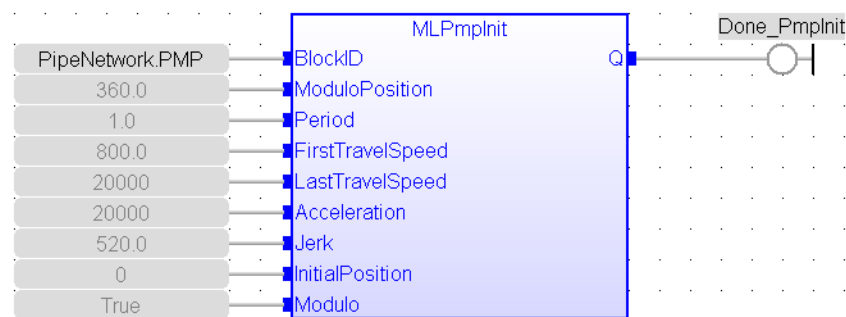

2.1.14.4 MLPmpReadAccel Pipe Network ✓

2.1.14.4.1 Description

Get the Acceleration parameter of a PMP block used in both the MLPmpAbs and MLPmpRel function block.

2.1.14.4.2 Arguments

2.1.14.4.2.1 Input

BlockID	Description	ID Name of the PMP function block in the Pipe Network
	Data type	DINT
	Range	[-2147483648, 2147483648]
	Unit	N/A
	Default	—

2.1.14.4.2.2 Output

Acceleration	Description	Present Acceleration of the PMP PipeNetwork Function Block
	Data type	LREAL
	Unit	User unit/sec ²
	Default	Value defined PMP Block when creating a Pipe Network. It is in the "ACCELERATION" field in the parameter tab.

2.1.14.4.3 Related Functions

[MLPmpReadFstSpd](#)

[MLPmpReadInitPos](#)

[MLPmpReadJerk](#)

[MLPmpReadLstSpd](#)

2.1.14.4.4 Example

2.1.14.4.4.1 Structured Text

```
PmpAccelValue := MLPmpReadAccel ( PipeNetwork.PmpMaster ) ;
```

2.1.14.4.4.2 Ladder Diagram

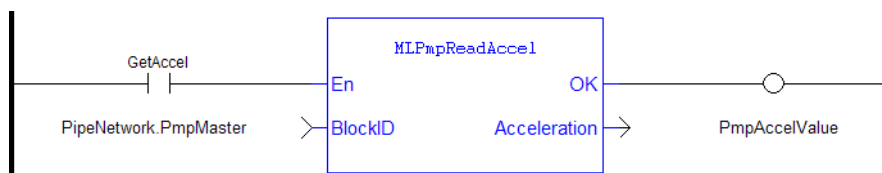

2.1.14.4.4.3 Function Block Diagram

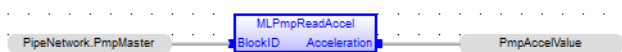

2.1.14.5 MLPmpReadFstSpd Pipe Network ✓

2.1.14.5.1 Descriptions

Get the FirstTravelSpeed parameter of a PMP block. This parameter is used as the first of 2 speeds in an MLPmpRel Motion Block. It is also used as the speed in an MLPmpAbs Motion Block.

2.1.14.5.2 Arguments

2.1.14.5.2.1 Input

BlockID	Description	ID Name of a PMP function block in the Pipe Network
	Data type	DINT
	Range	[-2147483648, 2147483648]
	Unit	N/A
	Default	—

2.1.14.5.2.2 Output

FirstTravelSpeed	Description	Present first travel velocity of the PMP PipeNetwork Function Block
	Data type	LREAL
	Unit	User unit/sec
	Default	Value defined in the setup of a PMP Block within a Pipe Network. It is in the "FIRST_TRAVEL_SPEED" field in the parameter tab

2.1.14.5.3 Related Functions

- [MLPmpReadAccel](#)
- [MLPmpReadFstSpd](#)
- [MLPmpReadInitPos](#)
- [MLPmpReadJerk](#)
- [MLPmpReadLstSpd](#)
- [MLPmpWriteLstSpd](#)

2.1.14.5.4 Example

2.1.14.5.4.1 Structured Text

```
FirstSpeedValue := MLPmpReadFstSpd( PipeNetwork.PmpMaster ) ;
```

2.1.14.5.4.2 Ladder Diagram

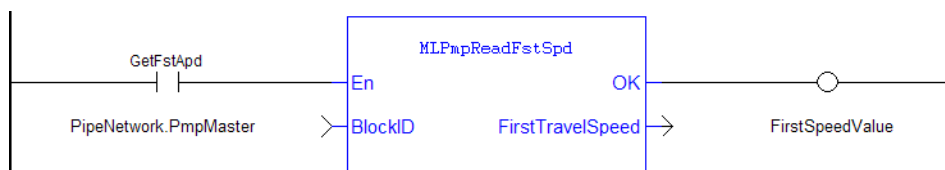

2.1.14.5.4.3 Function Block Diagram



2.1.14.6 MLPmpReadInitPos Pipe Network ✓

2.1.14.6.1 Description

Get the Initial Position parameter of a PMP block. This value is the position the Pmpblock starts at when the Pipe Network is enabled. This position can be set when adding a Pmp Block to a Pipe Network and defining the parameters for that block.

2.1.14.6.2 Arguments

2.1.14.6.2.1 Input

BlockID	Description	ID Name of a PMP function block in the Pipe Network
	Data type	DINT
	Range	[-2147483648, 2147483648]
	Unit	N/A
	Default	—

2.1.14.6.2.2 Output

InitialPosition	Description	Present Initial Position of the PMP PipeNetwork Function Block
	Data type	LREAL
	Unit	User unit
	Default	Value defined in the setup of a PMP Block within a Pipe Network. It is in the "INITIAL_POSITION" field in the parameter tab.

2.1.14.6.3 Related Functions

[MLPmpInit](#)

2.1.14.6.4 Example

2.1.14.6.4.1 Structured Text

```
PmpInitPos := MLPmpReadInitPos ( PipeNetwork.PmpMaster ) ;
```

2.1.14.6.4.2 Ladder Diagram

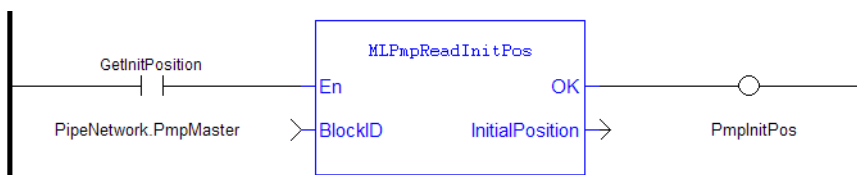

2.1.14.6.4.3 Function Block Diagram

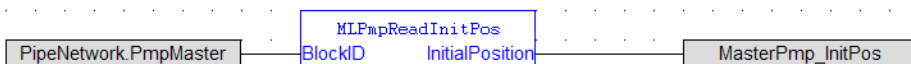

2.1.14.7 MLPmpReadJerk Pipe Network ✓

2.1.14.7.1 Description

Get the Jerk parameter of a PMP block used in both the MLPmpAbs and MLPmpRel function block.

2.1.14.7.2 Arguments

2.1.14.7.2.1 Input

BlockID	Description	ID Name of a PMP function block in the Pipe Network
	Data type	DINT
	Range	[-2147483648, 2147483648]
	Unit	N/A
	Default	—

2.1.14.7.2.2 Output

Jerk	Description	Jerk of the PMP PipeNetwork Function Block
	Data type	LREAL
	Unit	User unit/sec ³
	Default	Value defined in the setup of a PMP Block within a Pipe Network. It is in the "JERK" field in the parameter tab.

2.1.14.7.3 Example

2.1.14.7.3.1 Structured Text

```
PmpJerkValue := MLPmpReadJerk( PipeNetwork.PmpMaster ) ;
```

2.1.14.7.3.2 Ladder Diagram

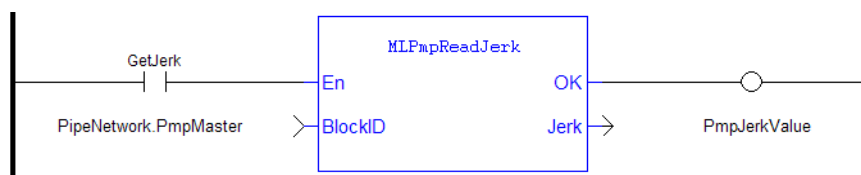

2.1.14.7.3.3 Function Block Diagram



2.1.14.8 MLPmpReadLstSpd Pipe Network ✓

2.1.14.8.1 Description

Get the LastTravelSpeed parameter of a PMP block used in the MLPmpRel function block.

2.1.14.8.2 Arguments

2.1.14.8.2.1 Input

BlockID	Description	ID Name of a PMP function block in the Pipe Network
	Data type	DINT
	Range	[-2147483648, 2147483648]
	Unit	N/A
	Default	—

2.1.14.8.2.2 Output

LastTravelSpeed	Description	Last Travel Speed of the PMP PipeNetwork Function Block
	Data type	LREAL
	Unit	User unit/sec
	Default	Value defined in the setup of a PMP Block within a Pipe Network. It is in the "LAST_TRAVEL_SPEED" field in the parameter tab.

2.1.14.8.3 Related Functions

- [MLPmpReadAccel](#)
- [MLPmpReadFstSpd](#)
- [MLPmpReadInitPos](#)
- [MLPmpReadJerk](#)

2.1.14.8.4 Example

2.1.14.8.4.1 Structured Text

```
PmpLastSpeed := MLPmpReadLstSpd( PipeNetwork.PmpMaster ) ;
```

2.1.14.8.4.2 Ladder Diagram

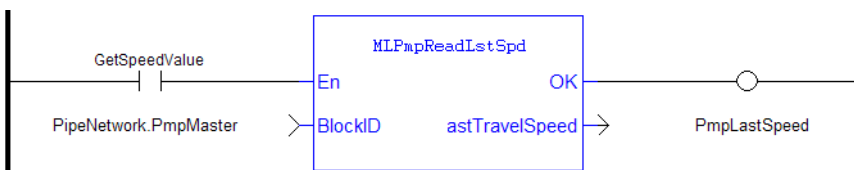

2.1.14.8.4.3 Function Block Diagram

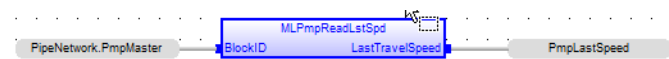

2.1.14.9 MLPmpRel Pipe Network ✓

2.1.14.9.1 Description

This function is used to perform two subsequent relative moves. Using the MLPmpRel function block, the PMP Generator is capable of producing forward-backward motions with a non-stop, jerk-free transition through zero speed (see Figure below). This feature is frequently useful for linear axes which must move back and forward without any pause at one end.

This function can also be used to do a single relative move, ending in zero speed, by setting the **DeltaSecond** argument to zero (0.0). If it is done, for the controlling speed to be the first move, the "Last_Travel_Speed" parameter has to be set equal to or greater than the "First_Travel_Speed" parameter.

In general, the slower of the two "Speeds" is utilized to optimize the S-curve behavior for the move whether it is a 2 or 1 delta move.

If the DeltaSecond argument is non-zero, it must have the opposite sign than the sign of the DeltaFirst argument.

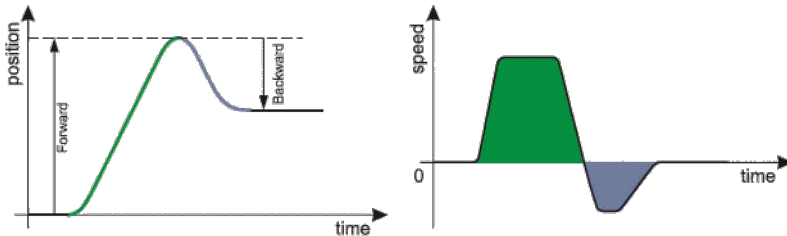

Figure 1-44: PMP Generator Forward & Backward Motion Profile

2.1.14.9.2 Arguments

2.1.14.9.2.1 Input

BlockID	Description	ID Name of the PMP function block in the Pipe Network
	Data type	DINT
	Range	[-2147483648, 2147483648]
	Unit	N/A
	Default	—
DeltaFirst	Description	Length of first Move
	Data type	LREAL
	Range	—
	Unit	User unit
	Default	Value defined in the setup of a PMP Block within a Pipe Network. It is the "FIRST_TRAVEL_SPEED" field in the parameter tab.
DeltaSecond	Description	Length of second (return) Move
	Data type	LREAL
	Range	—
	Unit	User unit
	Default	Value defined in the setup of a PMP Block within a Pipe Network. It is the "LAST_TRAVEL_SPEED" field in the parameter tab.

2.1.14.9.2.2 Output

Default (.Q)	Description	Returns True if the MLPmlRel successfully completed
---------------------	--------------------	---

Data type	BOOL
Unit	N/A

2.1.14.9.3 Related Functions

- [MLPmpWriteAccel](#)
- [MLPmpWriteFstSpd](#)
- [MLPmpWriteJerk](#)
- [MLPmpWriteLstSpd](#)

2.1.14.9.4 Example

2.1.14.9.4.1 Structured Text

```
//Execute a Relative move on a PMP Block name "PmpMaster" with a First
Travel Speed of 750.0, Second Travel Speed of -500,
MLPmpRel( PipeNetwork.PmpMaster, 750 , -500);
```

2.1.14.9.4.2 Ladder Diagram

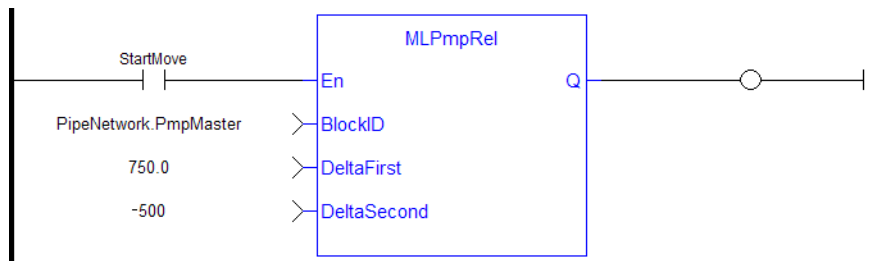

2.1.14.9.4.3 Function Block Diagram



2.1.14.10 MLPmpRun Pipe Network ✓

2.1.14.10.1 Description

Jog the generator at the requested speed.

2.1.14.10.2 Arguments

2.1.14.10.2.1 Input

EN	Description	Enables FB to be executed. Is only recognized if the PMP generator is Idle or at constant velocity as determined from the MLPmpStatus function.
	Data type	BOOL
	Range	0, 1
	Unit	N/A

	Default	—
BlockID	Description	ID Name of the PMP function block in the Pipe Network
	Data type	DINT
	Range	[-2147483648, 2147483648]
	Unit	N/A
	Default	—
Speed	Description	The desired rate at which to Jog. If the speed is 0.0 User Units / second the PMP block decelerates to zero speed and switches to the Idle state (0).
	Data type	LREAL
	Range	—
	Unit	User unit/sec
	Default	—

2.1.14.10.2.2 Output

Default (.Q)	Description	Returns True if the MLPmpRun successfully completed.
	Data type	BOOL
	Unit	N/A

2.1.14.10.3 Related Functions

[MLPmpStatus](#)

2.1.14.10.4 Example

2.1.14.10.4.1 Structured Text

```
//Execute a Relative move on a PMP Block name "PmpMaster" with a Jog speed of 1000.0
MLPmpRun( PipeNetwork.PmpMaster, 1000.0 ) ;
```

2.1.14.10.4.2 Ladder Diagram

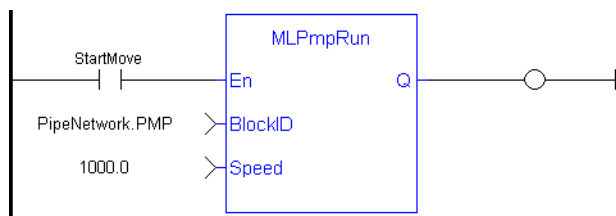

2.1.14.10.4.3 Function Block Diagram



2.1.14.11 MLPmpStatus Pipe Network ✓

2.1.14.11.1 Description

Returns the status of the PMP block generator.

NOTE

This function or function block returns cached data. See [Programming a Dual Core Controller](#) for more information.

2.1.14.11.2 Arguments

2.1.14.11.2.1 Input

EN	Description	Enables FB to be executed.
	Data type	BOOL
	Range	0, 1
	Unit	N/A
	Default	—
BlockID	Description	ID Name of the PMP function block in the Pipe Network
	Data type	DINT
	Range	[-2147483648, 2147483648]
	Unit	N/A
	Default	—

2.1.14.11.2.2 Output

OK	Description	Returns true when function successfully executes								
	Data type	BOOL								
	Unit	N/A								
Default (.Q)	Description	Returns the status of the PMP block generator								
	<table border="1"> <thead> <tr> <th>Value</th> <th>Description</th> </tr> </thead> <tbody> <tr> <td>0</td> <td>Indicates that the PMP block is idle. No command is currently running in the generator. It can be used to determine that a previous move is complete.</td> </tr> <tr> <td>1</td> <td>Indicates that the PMP block is either accelerating to a position or speed, or is decelerating to a position or speed.</td> </tr> <tr> <td>2</td> <td>Indicates that the PMP block is running at a constant speed.</td> </tr> </tbody> </table>		Value	Description	0	Indicates that the PMP block is idle. No command is currently running in the generator. It can be used to determine that a previous move is complete.	1	Indicates that the PMP block is either accelerating to a position or speed, or is decelerating to a position or speed.	2	Indicates that the PMP block is running at a constant speed.
	Value	Description								
	0	Indicates that the PMP block is idle. No command is currently running in the generator. It can be used to determine that a previous move is complete.								
1	Indicates that the PMP block is either accelerating to a position or speed, or is decelerating to a position or speed.									
2	Indicates that the PMP block is running at a constant speed.									
Data type	DINT									

Unit	N/A
-------------	-----

2.1.14.11.3 Example

2.1.14.11.3.1 Structured Text

```
PMP_Status := MLPmpStatus ( PipeNetwork.PmpMaster ) ;
Done :=TRUE;
```

2.1.14.11.3.2 Ladder Diagram

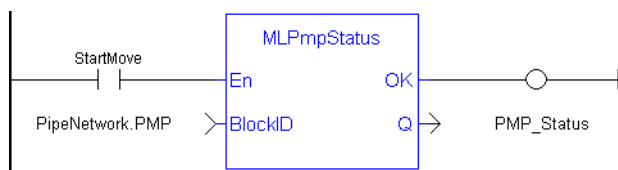

2.1.14.11.3.3 Function Block Diagram



2.1.14.12 MLPmpWriteAccel Pipe Network ✓

2.1.14.12.1 Description

Set the acceleration parameter of a PMP block. Returns TRUE if the function succeeded. Acceleration can also be set when adding a Pmp Block to a Pipe Network and defining the parameters for that block.

2.1.14.12.2 Arguments

2.1.14.12.2.1 Input

BlockID	Description	ID Name of the PMP function block in the Pipe Network
	Data type	DINT
	Range	[-2147483648, 2147483648]
	Unit	N/A
	Default	—
Acceleration	Description	Acceleration Value
	Data type	LREAL
	Range	> 0
	Unit	User unit/sec ²
	Default	Value defined in the setup of a PMP Block within a Pipe Network. It is the "ACCELERATION" field the parameter tab.

2.1.14.12.2.2 Output

Default (.Q)	Description	Returns True if the function block is successfully executing
	Data type	BOOL
	Unit	N/A

2.1.14.12.3 Related Functions

- [MLPmpAbs](#)
- [MLPmpRel](#)
- [MLPmpWriteFstSpd](#)
- [MLPmpWriteJerK](#)
- [MLPmpWriteLstSpd](#)

2.1.14.12.4 Example

2.1.14.12.4.1 Structured Text

```
MLPmpWriteAccel( PipeNetwork.PmpMaster, 40000.0 ) ;
```

2.1.14.12.4.2 Ladder Diagram

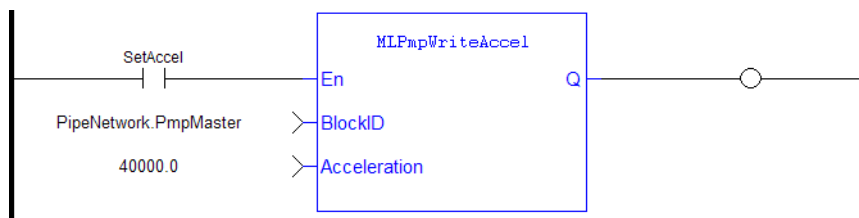

2.1.14.12.4.3 Function Block Diagram

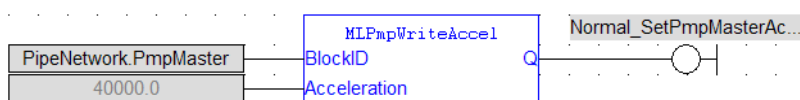

2.1.14.13 MLPmpWriteFstSpd Pipe Network ✓

2.1.14.13.1 Description

Set the FirstTravelSpeed parameter of a PMP block. Returns TRUE if the function succeeded. FirstTravelSpeed can also be set when adding a Pmp Block to a Pipe Network and defining the parameters for that block.

2.1.14.13.2 Arguments

2.1.14.13.2.1 Input

BlockID	Description	ID Name of the PMP function block in the Pipe Network
	Data type	DINT
	Range	[-2147483648, 2147483648]

	Unit	N/A
	Default	—
First Travel Speed	Description	First Travel Speed Value
	Data type	LREAL
	Range	> 0
	Unit	User unit/sec
	Default	Value defined in the setup of a PMP Block within a Pipe Network. It is the "FIRST_TRAVEL_SPEED" field in the parameter tab.

2.1.14.13.2.2 Output

Default (.Q)	Description	Returns True if the function block is successfully executing
	Data type	BOOL
	Unit	N/A

2.1.14.13.3 Related Functions

[MLPmpAbs](#)

[MLPmpRel](#)

[MLPmpWriteAccel](#)

[MLPmpWriteJerk](#)

[MLPmpWriteLstSpd](#)

2.1.14.13.4 Example

2.1.14.13.4.1 Structured Text

```
MLPmpWriteFstSpd( PipeNetwork.PmpMaster, 300.0 ) ;
```

2.1.14.13.4.2 Ladder Diagram

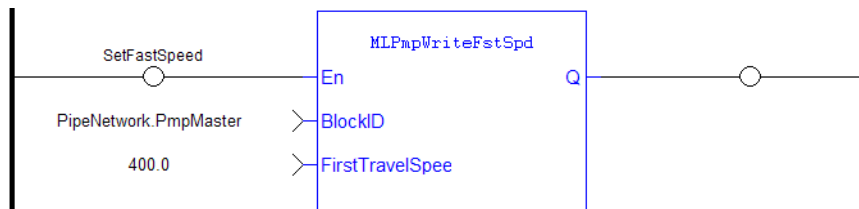

2.1.14.13.4.3 Function Block Diagram

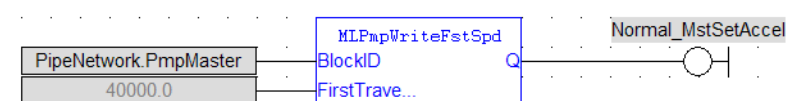

2.1.14.14 MLPmpWriteJerk

Pipe Network ✓

2.1.14.14.1 Description

Set the jerk parameter of a PMP block. Returns TRUE if the function succeeded. Jerk can also be set when adding a Pmp Block to a Pipe Network and defining the parameters for that block.

2.1.14.14.2 Arguments

2.1.14.14.2.1 Input

BlockID	Description	ID Name of the PMP function block in the Pipe Network
	Data type	DINT
	Range	[-2147483648, 2147483648]
	Unit	N/A
	Default	—
Jerk	Description	Jerk Value
	Data type	LREAL
	Range	> 0
	Unit	User unit/sec ³
	Default	Value defined in the setup of a PMP Block within a Pipe Network. It is the "JERK" field in the parameter tab.

2.1.14.14.2.2 Output

Default (.Q)	Description	Returns True if the function block is successfully executing
	Data type	BOOL
	Unit	N/A

2.1.14.14.3 Related Functions

[MLPmpAbs](#)

[MLPmpReadJerk](#)

[MLPmpRel](#)

[MLPmpWriteAccel](#)

[MLPmpWriteFstSpd](#)

[MLPmpWriteLstSpd](#)

2.1.14.14.4 Example

2.1.14.14.4.1 Structured Text

```
MLPmpWriteJerk( PipeNetwork.PmpMaster, 15.0 ) ;
```

2.1.14.14.4.2 Ladder Diagram



2.1.14.14.3 Function Block Diagram

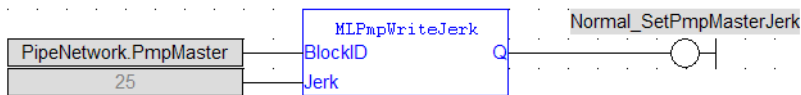

2.1.14.15 MLPmpWriteLstSpd Pipe Network ✓

2.1.14.15.1 Description

Set the LastTravelSpeed parameter of a PMP block. Returns TRUE if the function succeeded. Last Travel Speed can also be set when adding a Pmp Block to a Pipe Network and defining the parameters for that block.

2.1.14.15.2 Arguments

2.1.14.15.2.1 Input

BlockID	Description	ID Name of the PMP function block in the Pipe Network
	Data type	DINT
	Range	[-2147483648, 2147483648]
	Unit	N/A
	Default	—
Last Speed	Description	Last Travel Speed Value
	Data type	LREAL
	Range	> 0
	Unit	User unit/sec
	Default	Value defined in the setup of a PMP Block within a Pipe Network. It is in the "LAST_TRAVEL_SPEED" field in the parameter tab.

2.1.14.15.2.2 Output

Default (.Q)	Description	Returns True if the function block is successfully executing
	Data type	BOOL
	Unit	N/A

2.1.14.15.3 Related Functions

[MLPmpAbs](#)

[MLPmpReadLstSpd](#)

- [MLPmpRel](#)
- [MLPmpWriteAccel](#)
- [MLPmpWriteFstSpd](#)
- [MLPmpWriteJerK](#)

2.1.14.15.4 Example

2.1.14.15.4.1 Structured Text

```
MLPmpWriteLstSpd( PipeNetwork.PmpMaster, 650 ) ;
```

2.1.14.15.4.2 Ladder Diagram

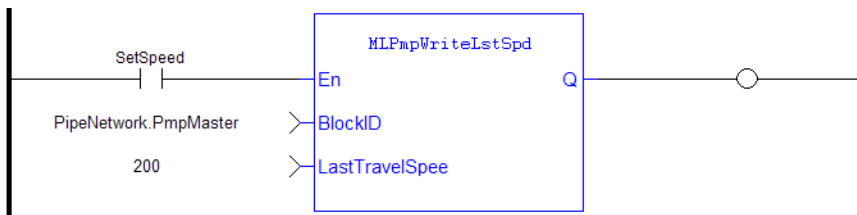

2.1.14.15.4.3 Function Block Diagram

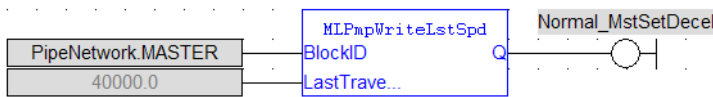

2.1.15 Motion Library - Sampler

Name	Description	Return type
MLSmpConECAT	Connects a sampler block to the specified CoE object in a PDO	BOOL
MLSmpConnect	Connects a sampler block to a pipe network axis or pipe block	BOOL
MLSmpConPLCAxis	Connects a sampler block to a PLCopen axis variable	BOOL
MLSmpConPNAxis	Connects a sampler block to a Pipe Network axis variable	BOOL
MLSmpInit	Initializes a sampler object	BOOL

TIP

There is a delay when using an external encoder. The delay is five cycles (2 cycles to read the encoder from the AKD via EtherCAT, 1 cycle for computing, 2 cycles for sending the new position set point to the AKD). This lag error is speed proportional (5 cycles * speed). A Phaser block can be used to compensate for this lag.

2.1.15.1 MLSmpConECAT Pipe Network ✓

2.1.15.1.1 Description

Connects a sampler block to the specified CoE object. The CoE object must be included in a PDO for the specified EtherCAT device.

Using this function, you can use any EtherCAT data source as input for the specified sampler block.

What happens when the device providing the CoE Object for the Sampler block is removed?

The CoE object value will become zero if the EtherCAT device providing the CoE object for the Sampler block is removed using the [ECATDeviceAction](#) function block. The CoE object will automatically connect to the sampler block when the device is reconnected to the EtherCAT network.

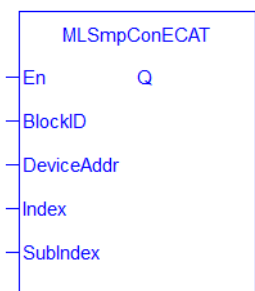
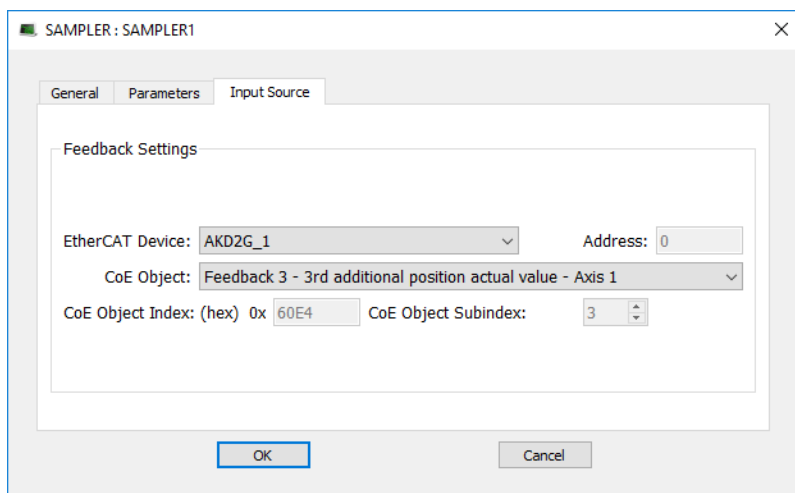

Figure 1-45: MLSmpConECAT function

This function can also be programmed from within the PipeNetwork block. Simply right-click on the block and select **Properties**.



2.1.15.1.1 Related Function Blocks

[MLSmpConnect](#), [MLSmpInit](#)

2.1.15.1.2 Arguments

2.1.15.1.2.1 Input

BlockID	Description	ID Name of the Sampler function block in the Pipe Network
	Data type	DINT
	Range	[-2147483648, 2147483648]
	Unit	N/A
	Default	—
DeviceAddr	Description	The EtherCAT address of the slave device. The first node usually has the value '1001'. Alternately, you can use the members of the EtherCATCode structure to specify a device's address.

	Data type	INT
	Range	—
	Unit	N/A
	Default	—
Index	Description	The CoE index of the object to be connected with the Sampler block.
	Data Type	UINT
	Range	—
	Unit	N/A
	Default	—
SubIndex	Description	The CoE sub-index of the object to be connected with the Sampler block.
	Data Type	UINT
	Range	—
	Unit	N/A
	Default	—

2.1.15.1.2.2 Output

Default (.Q)	Description	Function block is operational
	Data type	BOOL
	Unit	N/A

2.1.15.1.2.3 Return Type

BOOL

2.1.15.1.3 Example

2.1.15.1.3.1 Structured Text

```
//Connect a Sampler pipe block named "EncoderMaster" to an ECAT Index
Object defined by variable "CoE_SubIndex" with the SubIndex defined by
variable "CoE_SubIndex", from a device with Ethercat Address defined by
"ECAT_Addr"
MLSmpConECAT(PipeNetwork.EncoderMaster, ECAT_Addr, CoE_Index, CoE_
SubIndex );
```

2.1.15.1.3.2 Ladder Diagram

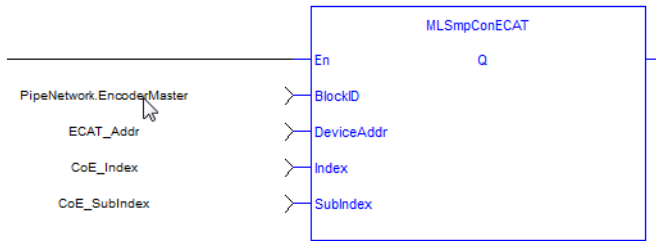

2.1.15.1.3.3 Function Block Diagram

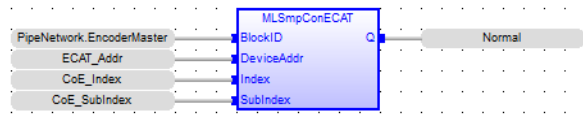

2.1.15.2 MLSmpConnect Pipe Network

2.1.15.2.1 Description

Connect a sampler to an axis or pipe block as a value source. Returns TRUE if the function succeeded.

2.1.15.2.1.1 Related Function Blocks

[MLSmpConECAT](#), [MLSmpInit](#), [MLSmpConPNAxis](#), [MLSmpConPLCAxis](#)

2.1.15.2.2 Arguments

2.1.15.2.2.1 Input

BlockID	Description	ID Name of the SMP function block in the Pipe Network
	Data type	DINT
	Range	[-2147483648, 2147483648]
	Unit	N/A
	Default	—
PipeBlockID	Description	ID Name of the Pipe Block the sampler is connected to
	Data type	DINT
	Range	[-2147483648, 2147483648]
	Unit	N/A
	Default	—

2.1.15.2.2.2 Output

Default (.Q)	Description	Returns True if the Sampler is connected.
	Data type	BOOL
	Unit	N/A

2.1.15.2.2.3 Return Type

BOOL

2.1.15.2.3 Example

2.1.15.2.3.1 Structured Text

```
//Connect a Sampler pipe block named "EncoderMaster1" to a PipeNetwork
Axis block named AXIS1
MLSmpConnect( PipeNetwork.EncoderMaster1, PipeNetwork.AXIS1 ) ;
```

2.1.15.2.3.2 Ladder Diagram

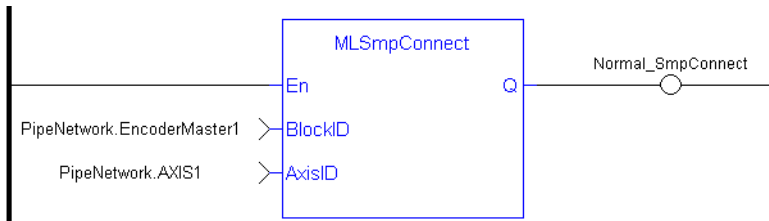

2.1.15.2.3.3 Function Block Diagram



2.1.15.3 MLSmpConPLCAxis Pipe Network ✓

2.1.15.3.1 Description

This function connects a sampler block to a specific variable from a PLCOpen Axis.

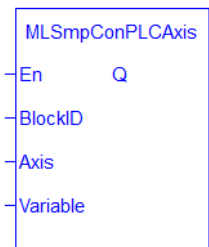

Figure 1-46: MLSmpConPLCAxis function

2.1.15.3.2 Arguments

2.1.15.3.2.1 Input

BlockID	Description	ID Name of the SMP function block in the Pipe Network
	Data type	DINT
	Range	[-2147483648, 2147483648]
	Unit	N/A
	Default	—
AxisID	Description	Name of a declared instance of the AXIS_REF library function (for more details, click here....)
	Data Type	AXIS_REF
	Range	[1,256]
	Unit	N/A

	Default	—
Variable	Description	Variable to be connected to. You need to use one of the following Internal Defines : <ul style="list-style-type: none"> • MC_ACTUAL_POSITION • MC_COMMAND_POSITION • MC_NORMAL_COMMAND_POSITION • MC_SUPERIMPOSED_COMMAND_POSITION • MC_PHASE_COMMAND_POSITION
	Data Type	UINT
	Range	N/A (use available macros)
	Unit	N/A
	Default	—

2.1.15.3.2.2 Output

Default (.Q)	Description	Function block is operational
	Data type	BOOL
	Unit	N/A

2.1.15.3.2.3 Return Type

BOOL

2.1.15.3.3 Example

2.1.15.3.3.1 Structured Text

```
//Connect a Sampler pipe block named "SAMPLER" to a variable named "MC_
ACTUAL_POSITION" from a PLCOpen Axis named Axis1.
MLSmpConPLCAxis( PipeNetwork.SAMPLER, Axis1, MC_ACTUAL_POSITION);
```

2.1.15.3.3.2 Ladder Diagram

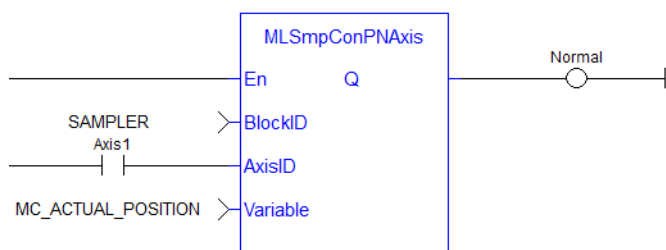

2.1.15.3.3.3 Function Block Diagram



2.1.15.4 MLSmpConPNAxis Pipe Network ✓

2.1.15.4.1 Description

This function connects a sampler block to a specific variable from a PipeNetwork Axis.

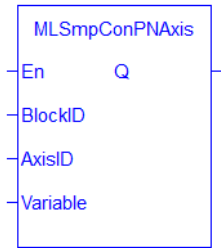

Figure 1-47: MLSmpConPNAxis function

2.1.15.4.2 Arguments

2.1.15.4.2.1 Input

BlockID	Description	ID Name of the SMP function block in the Pipe Network
	Data type	DINT
	Range	[-2147483648, 2147483648]
	Unit	N/A
	Default	—
AxisID	Description	ID Name of the Axis the sampler is connected to
	Data Type	DINT
	Range	[-2147483648, 2147483648]
	Unit	N/A
	Default	—
Variable	Description	Variable to be connected to. You need to use one of the following Internal Defines :
		<ul style="list-style-type: none"> • ML_PIPE_POSITION • ML_REFERENCE_POSITION • ML_GENERATOR_POSITION • ML_ACTUAL_POSITION • ML_FEEDBACK_POSITION • ML_ACTUAL_VELOCITY • ML_ACTUAL_TORQUE • ML_FOLLOWING_ERROR • ML_CURRENT_POSITION
	Data Type	UINT
	Range	N/A (use available macros)
	Unit	N/A
	Default	—

2.1.15.4.2.2 Output

Default (.Q)	Description	Function block is operational
	Data type	BOOL

Unit

N/A

2.1.15.4.2.3 Return Type

BOOL

2.1.15.4.3 Example

2.1.15.4.3.1 Structured Text

```
//Connect a sampler block named "SAMPLER" to a variable named ML_PIPE_POSITION from a Pipe Network Axis named PipeNetwork.AXIS1
MLSmpConPNAxis( PipeNetwork.SAMPLER , PipeNetwork.AXIS1, ML_PIPE_POSITION
);
```

2.1.15.4.3.2 Ladder Diagram



2.1.15.4.3.3 Function Block Diagram



2.1.15.5 MLSmpInit Pipe Network ✓

2.1.15.5.1 Description

The purpose of the sampler block is to periodically sample and place into a pipe some output of a source object. The sampled output can typically be the POSITION or SPEED of a source object measured by a resolver, an encoder or some other types of sensor.

The sampler implements the logical connection between an encoder on a physical master axis (the source object) and one or more pipes and performs the function of periodically sampling the source and placing the sampled values into the pipe.

This function block is automatically called by the Function PipeNetwork(MLPN_CREATE_OBJECTS) if a Smp Block is added to the Pipe Network, with user-defined settings entered in the Pipe Blocks Properties screen.

The Smp Pipe Block is assigned a Name, SAMPLING_PERIOD, MODE, INPUT_VALUE_PERIOD and OUTPUT_VALUE_PERIOD.

This function can also be programmed from within the PipeNetwork block. Simply right-click on the block and select **Properties**.

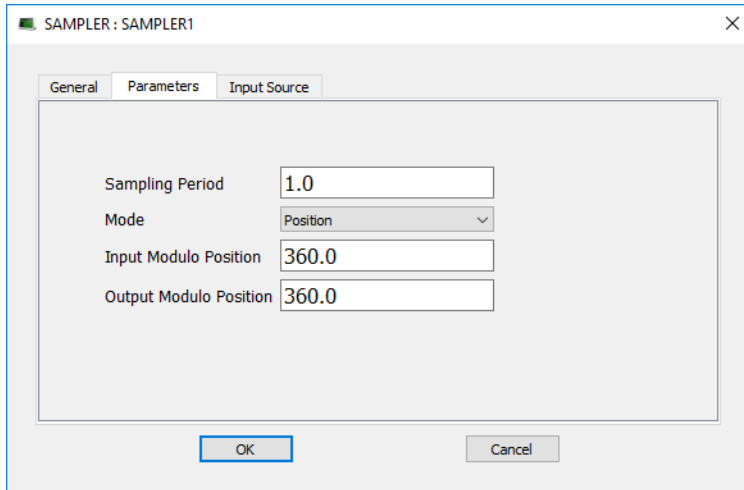

Using AKD Secondary Feedback	Using AKD2G Additional Feedback
<p>The Sampler can be connected to the secondary feedback on the AKD using MLSmpConPNAxis. The scaling for the AKD Secondary Feedback is setup using AKD Parameters: DRV.HANDWHEEL and FB2.ENCRES. The feedback signal comes through EtherCAT in object 0x2050.</p> <p>The scaling for this position signal is 0 to 4294967296 = 0 to FB2.ENCRES. Object 0x2050 rolls over to 0 when reaching 4294967296.</p>	<p>The Sampler can be connected to the additional feedback (1-5) on the AKD2G using MLSmpConPNAxis. Please refer to the AKD2G Feedback section for setting up the additional feedback type and resolution.</p> <p>The default feed constant value in the KAS IDE is scaled to 65536. This feed constant value can be changed using EtherCAT object 0x60E9 subindex 1-5. The feedback signal comes through EtherCAT in object 0x60E4 subindex 1-5.</p>

Place a Phaser Block (and write [MLPhaWritePhase](#) in the application code) or Gear Block (and write [MLGearWriteOff](#)) after the Sampler Block to offset the Sampler Block Output Position in the PipeNetwork.

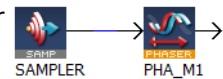

2.1.15.5.1.1 Related Function Blocks

[MLSmpConnect](#), [MLSmpConECAT](#), [MLSmpConPLCAxis](#), [MLSmpConPNAxis](#)

2.1.15.5.2 Arguments

2.1.15.5.2.1 Input

BlockID	Description	ID Name of the SMP function block in the Pipe Network
	Data type	DINT
	Range	[-2147483648, 2147483648]
	Unit	N/A
	Default	—
SamplingPeriod	Description	period that the device is sampled
	Data type	LREAL
	Range	0.25 to ?
	Unit	millisecond
	Default	1.0

Mode	Description	Sampled output can be either position or velocity
	Data type	DINT
	Range	[1 , 2] Position or Speed
	Unit	N/A
	Default	position
InputModuloPosition	Description	Period of the input signal. The value set depends upon the device used. <ul style="list-style-type: none"> • AKD: This should be set equal to 232 (4294967296.0) • AKD2G: The value should be set based on the feed constant value assigned in the EtherCAT object 0x60E4 subindex 1-5. The default feed constant value is 216 (65536)
	Data type	LREAL
	Range	—
	Unit	User unit
	Default	360.0
OutputModuloPosition	Description	Period of the output signal
	Data type	LREAL
	Range	—
	Unit	User unit
	Default	360.0

2.1.15.5.2.2 Output

Default (.Q)	Description	Smp Block successfully initiated
	Data type	BOOL
	Unit	N/A

2.1.15.5.3 Example

2.1.15.5.3.1 Structured Text

```
//Initialize a Sampler Pipe Block named "EncoderMaster1" to a Sample
Period of 1 millisec, Mode of Operation to 2 (Velocity), Input Modulo of
4294967296, and Output Modulo of 720
MLSmpInit( PipeNetwork.EncoderMaster1, 1.0,2,4294967296,720);
```

2.1.15.5.3.2 Ladder Diagram

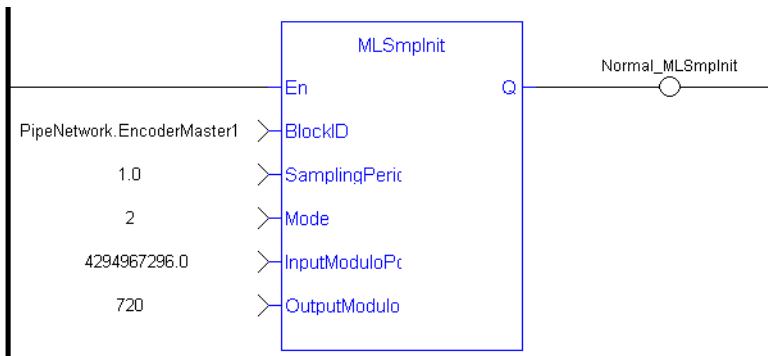

2.1.15.5.3.3 Function Block Diagram

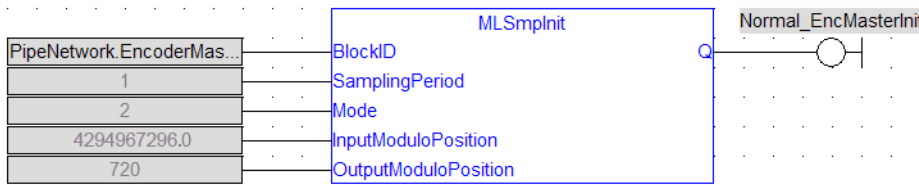

2.1.16 Motion Library - Synchronizer

TIP

- For a Synchronizer example, see [Usage Example of Synchronizer Functions](#)

Name	Description	Return Type
MLSyncInit	Initializes a synchronizer Pipe Block	BOOL
MLSyncReadDeltaS	Gets the output phasing value of a synchronizer block	None
MLSyncStart	Starts a synchronization of a synchronizer Pipe Block	BOOL
MLSyncStop	De-synchronizes a synchronizer Pipe Block	BOOL
MLSyncWriteDeltaS	Sets the output phasing value of a synchronizer block	BOOL

2.1.16.1 Usage Example of Synchronizer Functions

When you call the **MLSyncStop** function, the output value is adapted according to the specified Stop-Position (point B).

The OUTPUT_PHASING parameter is used to define point A, where the flow follows a curve in order to smooth the output value.

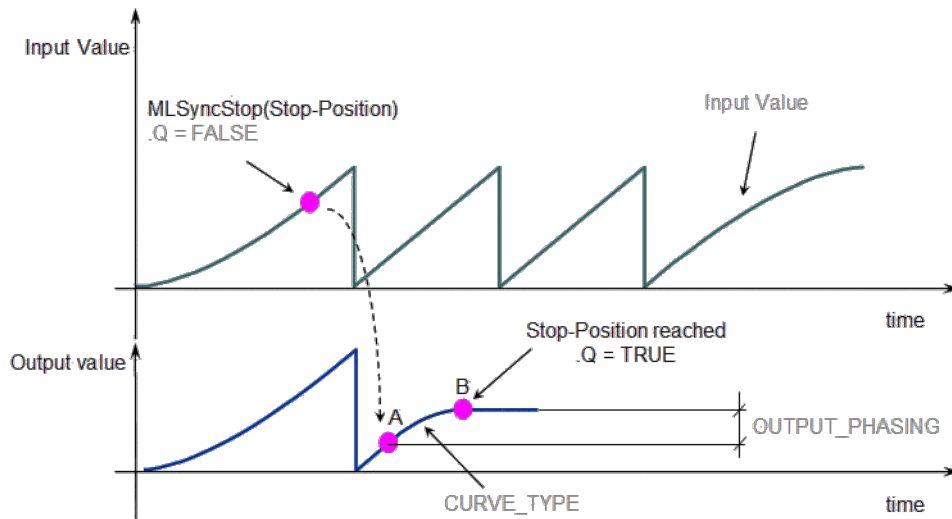

When you call the **MLSyncStart** function, the output value is adapted to catch up with the input value.

The **OUTPUT_PHASING** parameter is also used to define a curve in order to smooth the output value.

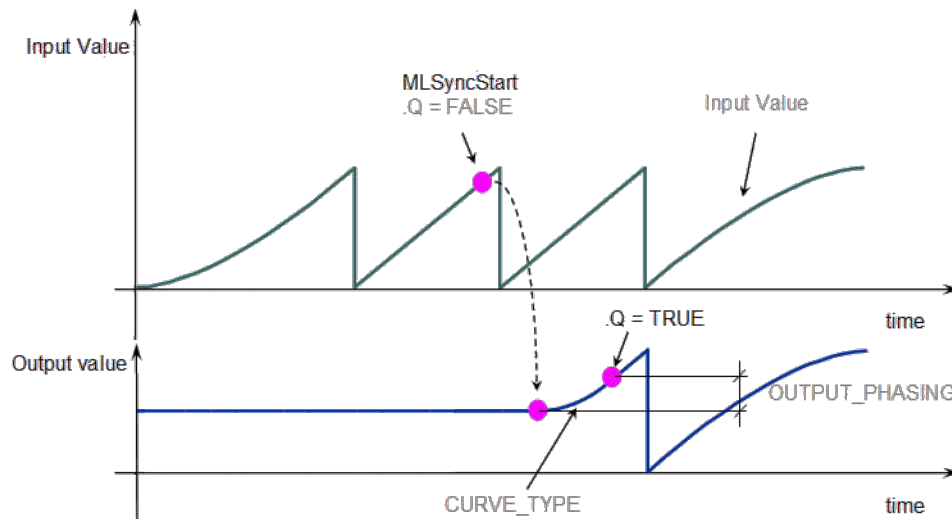

Figure 1-48: Synchronizer Functions Usage

2.1.16.2 MLSyncInit Pipe Network ✓

2.1.16.2.1 Description

Initializes a synchronizer Pipe Block. Returns TRUE if the function succeeded.

This FB is automatically created in the compiled code of a Pipe Network.

This function block is part of the `MLPN_CREATE_OBJECT` to initialize the Pipe Network. It is called at the beginning of an application program with the function call:

```
PipeNetwork(MLPN_CREATE_OBJECTS);
```

2.1.16.2.2 Arguments

2.1.16.2.2.1 Input

BlockID	Description	Name of the Pipe Network Block
	Data type	DINT
	Range	[-2147483648, 2147483648]
	Unit	n/a
	Default	—
ModuloPosition	Description	The modulo distance
	Data type	LREAL
	Range	—
	Unit	User unit
	Default	—
CurveType	Description	The curve type to the motion when starting and stopping synchronization. Option are Parabolic or Polynomial
	Data type	DINT
	Range	[1 , 2] (1 = Parabolic, 2 = Polynomial)
	Unit	n/a
	Default	—
DeltaS	Description	The Distance to get in or out of synchronization. This parameter is used in the MLSyncStart and MLSyncStop FunctionBlocks
	Data type	LREAL
	Range	—
	Unit	User unit
	Default	—

2.1.16.2.2.2 Output

Default (.Q)	Description	Function Block Execute Successfully
	Data type	BOOL
	Unit	n/a

2.1.16.2.3 Related Functions

[MLSyncWriteDeltaS](#)

2.1.16.2.4 Example

2.1.16.2.4.1 Structured Text

```
//Initialize a synchronizer Pipe Block named " SYN" with a modulo of
360, Curve Type of Parabolic, and a distance (DeltaS) of 30 to get in and
```

```

t of synchronization
SyncInit( PipeNetwork.SYN, 360, 1, 30 );
    
```

2.1.16.2.4.2 Ladder Diagram

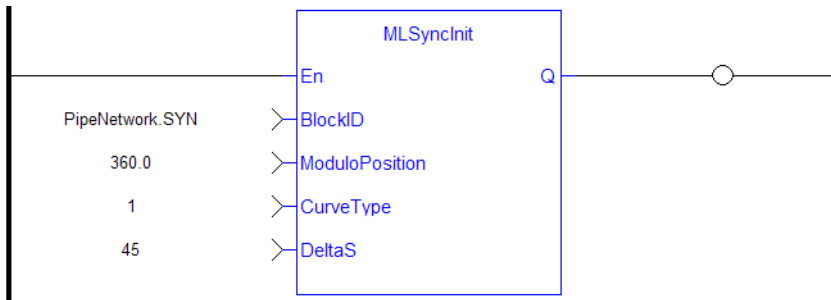

2.1.16.2.4.3 Function Block Diagram

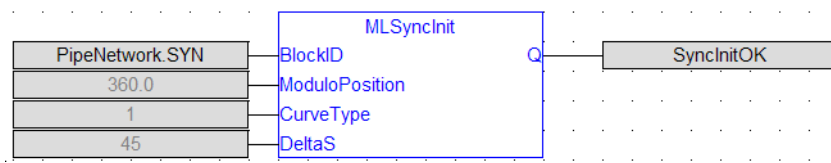

2.1.16.3 MLSyncReadDeltaS Pipe Network ✓

2.1.16.3.1 Description

Gets the output phasing value of a synchronizer block. Output phasing is the distance or the slope the output takes to synchronize with the input when MLSyncStart Block is executed (see [Get Output Phasing after MLSyncStart](#)). It also affects the distance or the slope the output takes to desynchronize with the input and come to a stop when MLSyncStop Block is executed (see [Get Output Phasing after MLSyncStop](#)).

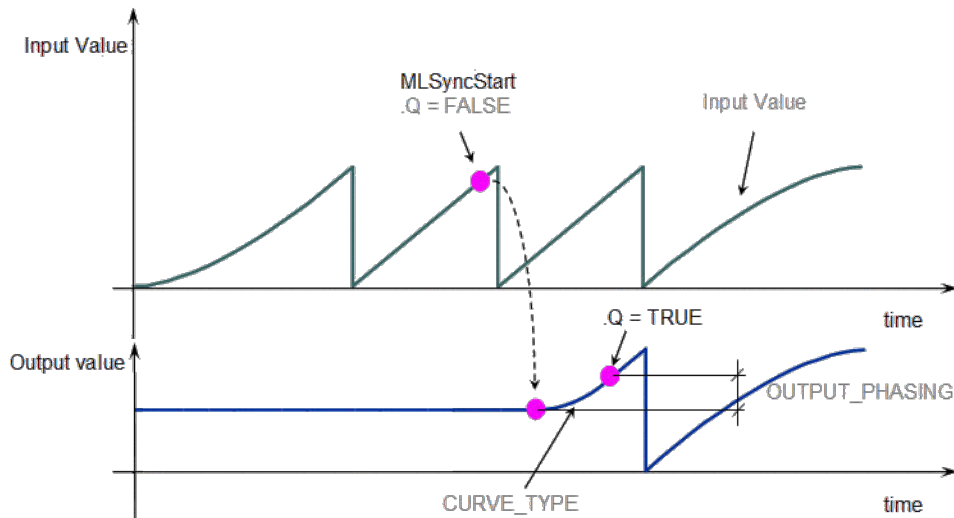

Figure 1-49: Get Output Phasing after MLSyncStart

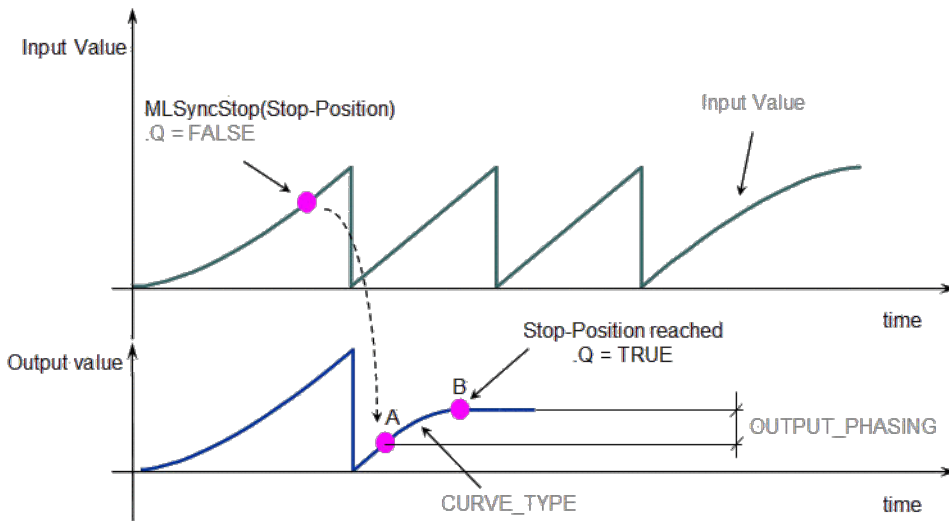

Figure 1-50: Get Output Phasing after MLSyncStop

2.1.16.3.2 Arguments

2.1.16.3.2.1 Input

BlockID	Description	Name of the Pipe Network Block
	Data type	DINT
	Range	[-2147483648, 2147483648]
	Unit	n/a
	Default	—

2.1.16.3.2.2 Output

DeltaS	Description	Present Delta Slope value
	Data type	LREAL
	Unit	User unit

2.1.16.3.3 Related Functions

[MLSyncWriteDeltaS](#)

2.1.16.3.4 Example

2.1.16.3.4.1 Structured Text

```
ActScope := MLSyncReadDeltaS( PipeNetwork.SYN );
```

2.1.16.3.4.2 Ladder Diagram



2.1.16.3.4.3 Function Block Diagram

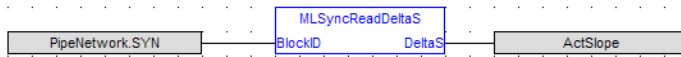

2.1.16.4 MLSyncStart Pipe Network ✓

2.1.16.4.1 Description

Start a synchronization of a synchronizer Pipe Block. Returns TRUE if the function succeeded.

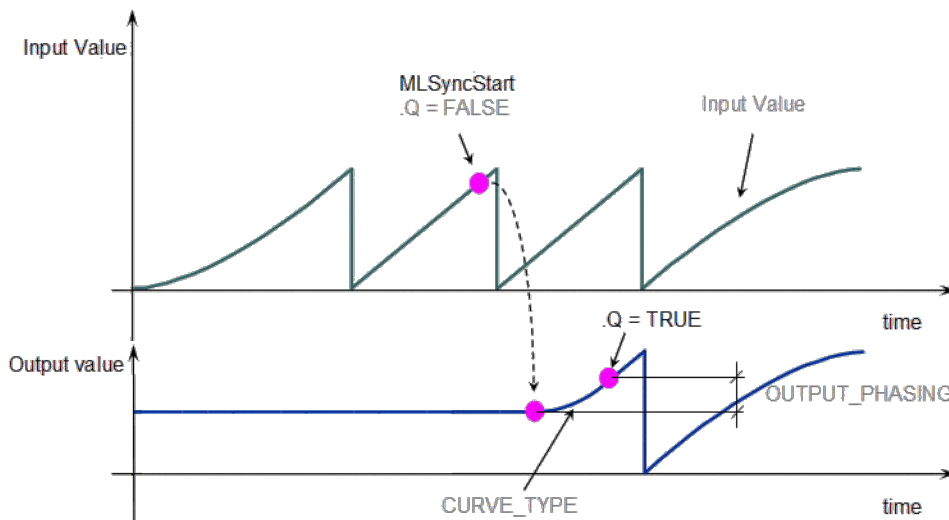

Figure 1-51: MLSyncStart

2.1.16.4.2 Arguments

2.1.16.4.2.1 Input

BlockID	Description	Name of the Pipe Network Block
	Data type	DINT
	Range	[-2147483648, 2147483648]
	Unit	n/a
	Default	—

2.1.16.4.2.2 Output

Default (.Q)	Description	Function Block Execute Successfully
	Data type	BOOL
	Unit	n/a

2.1.16.4.3 Example

2.1.16.4.3.1 Structured Text

```
MLSyncStart( PipeNetwork.SYN );
```

2.1.16.4.3.2 Ladder Diagram



2.1.16.4.3.3 Function Block Diagram

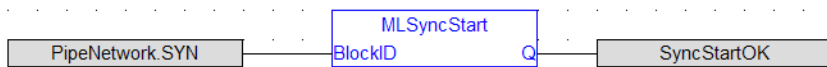

2.1.16.5 MLSyncStop Pipe Network ✓

2.1.16.5.1 Description

De-synchronizes a synchronizer Pipe Block. Returns TRUE if the function succeeded.

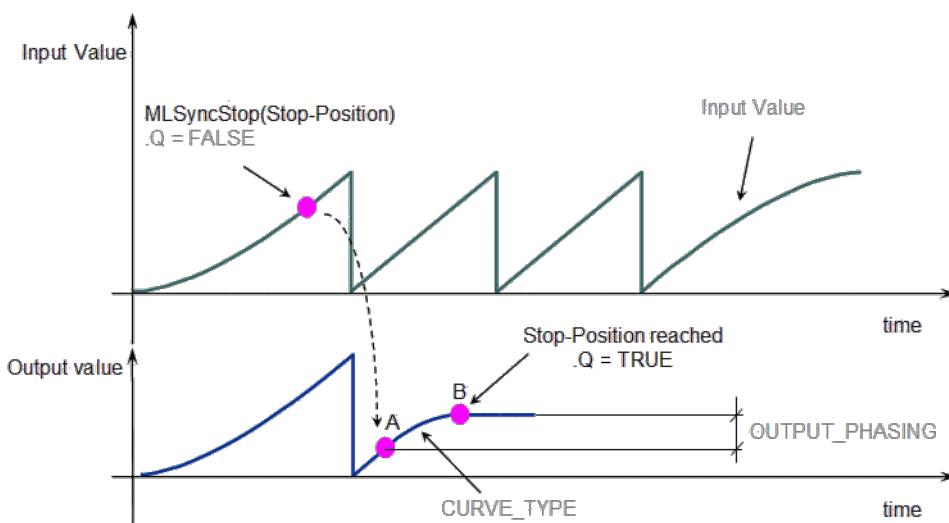

Figure 1-52: MLSyncStop

2.1.16.5.2 Arguments

2.1.16.5.2.1 Input

Position	Description	Motion Stop Position
	Data type	LREAL
	Range	—
	Unit	User unit
	Default	—

2.1.16.5.2.2 Output

Default (.Q)	Description	Function Block Execute Successfully
	Data type	BOOL
	Unit	n/a

2.1.16.5.3 Example

2.1.16.5.3.1 Structured Text

```
MLSyncStop( PipeNetwork.SYN , 120 );
```

2.1.16.5.3.2 Ladder Diagram

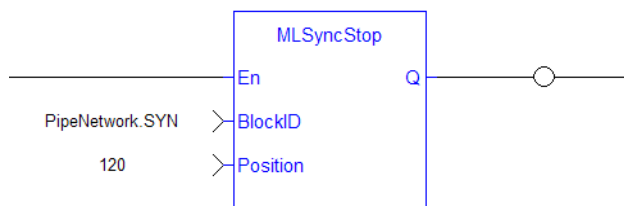

2.1.16.5.3.3 Function Block Diagram

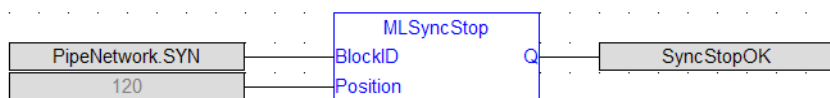

2.1.16.6 MLSyncWriteDeltaS Pipe Network ✓

2.1.16.6.1 Description

Set the output phasing value of a synchronizer block. Returns TRUE if the function succeeded. Output phasing is the distance or the slope the output takes to synchronize with the input when MLSyncStart Block is executed. It also affects the distance or the slope the output takes to desynchronize with the input and come to a stop when MLSyncStop Block is executed.

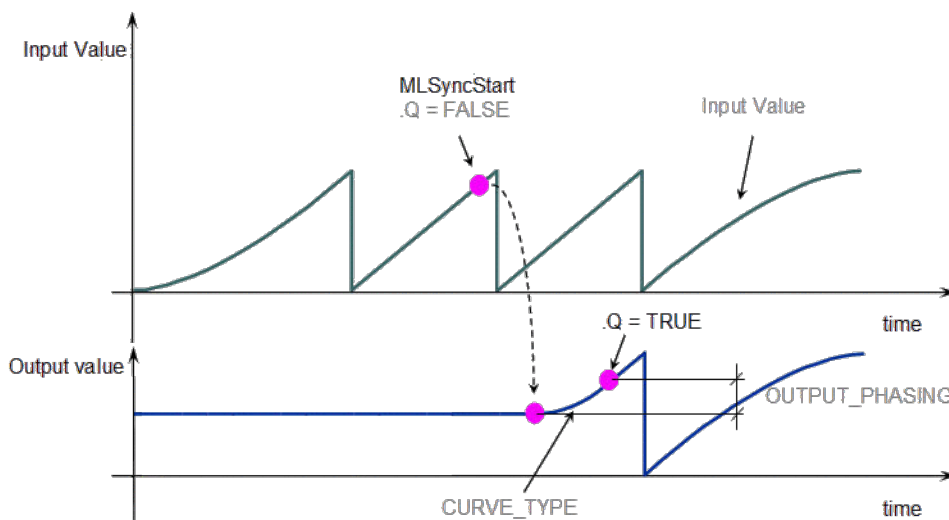

Figure 1-53: Set output phasing after MLSyncStart

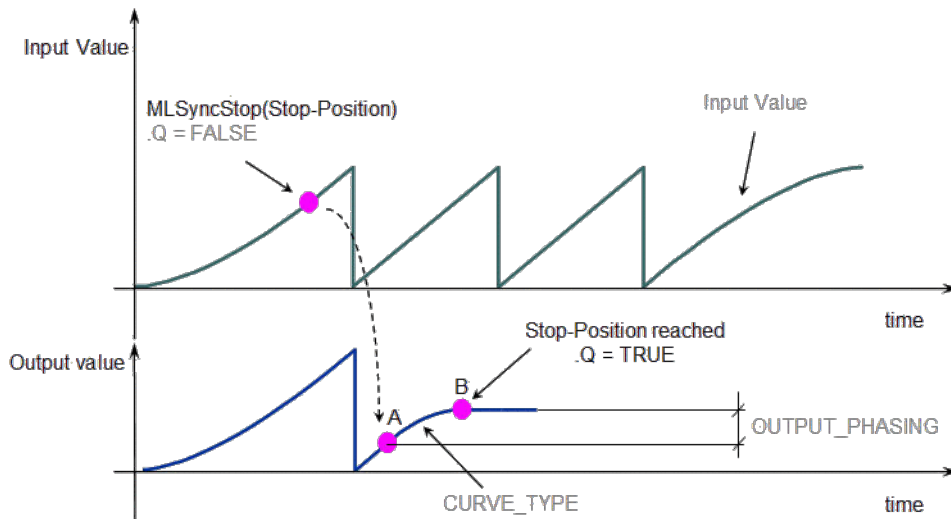

Figure 1-54: Set output phasing after MLSyncStop

NOTE

This function or function block returns cached data. See [Programming a Dual Core Controller](#) for more information.

2.1.16.6.2 Arguments

2.1.16.6.2.1 Input

BlockID	Description	Name of the Pipe Network Block
	Data type	DINT
	Range	[-2147483648, 2147483648]
	Unit	n/a
	Default	—
DeltaS	Description	Slope to be used during Start and stop of Synchronization
	Data type	LREAL
	Range	—
	Unit	User unit
	Default	—

2.1.16.6.2.2 Output

Default (.Q)	Description	Function Block Execute Successfully
	Data type	BOOL
	Unit	n/a

2.1.16.6.3 Example

2.1.16.6.3.1 Structured Text

```
MLSyncWriteDeltaS( PipeNetwork.SYN, 45 );
```

2.1.16.6.3.2 Ladder Diagram

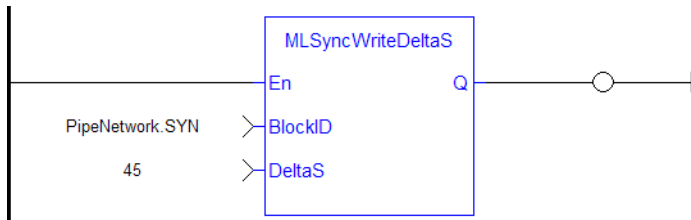

2.1.16.6.3.3 Function Block Diagram

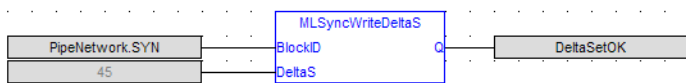

2.1.17 Motion Library - Trigger

TIP

- For an example of Trigger functions, see [Usage Example of Trigger Functions](#)

Name	Description	Return Type
MLTrigClearFlag	Clears the flag of an initiated Trigger block	BOOL
MLTrigInit	Initializes a Trigger object	BOOL
MLTrigIsTriggered	Checks if the selected block has been triggered	BOOL
MLTrigReadDelay	Returns the time that the trigger block uses to compensate the delay of the sensor that captures the triggering signal	None
MLTrigReadPos	Returns the position of the block at the moment when it was triggered	None
MLTrigReadTime	Returns the time of the moment where the block was triggered in milliseconds	None
MLTrigSetEdge	Sets the edge configuration for a Trigger object	BOOL
MLTrigWriteDelay	Sets the time that the trigger block uses to compensate for the delay introduced by the sensor that captures the triggering signal	BOOL

2.1.17.1 Usage Example of Trigger Functions

When you call the **MLTrigClearFlag** function, the flag for trigger is reset to False.

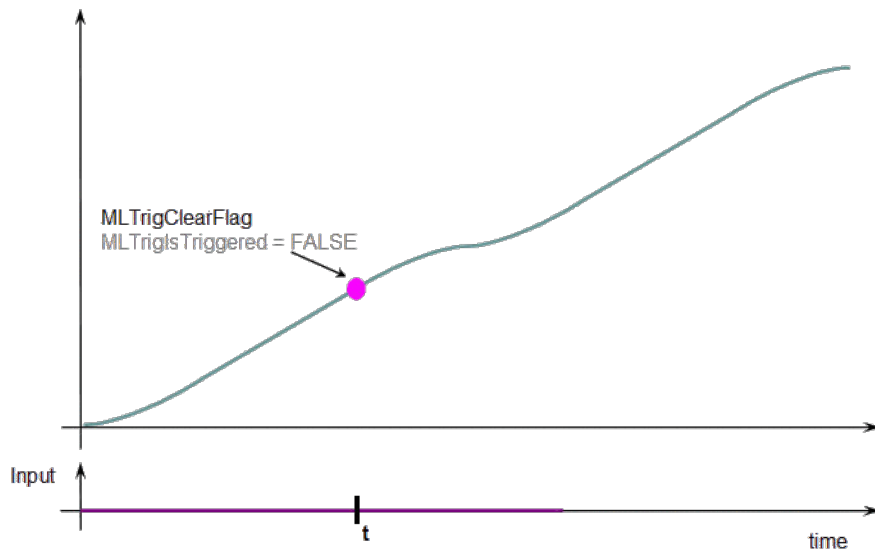

When a Fast Input is set, the **MLTrigIsTriggered** function returns True.

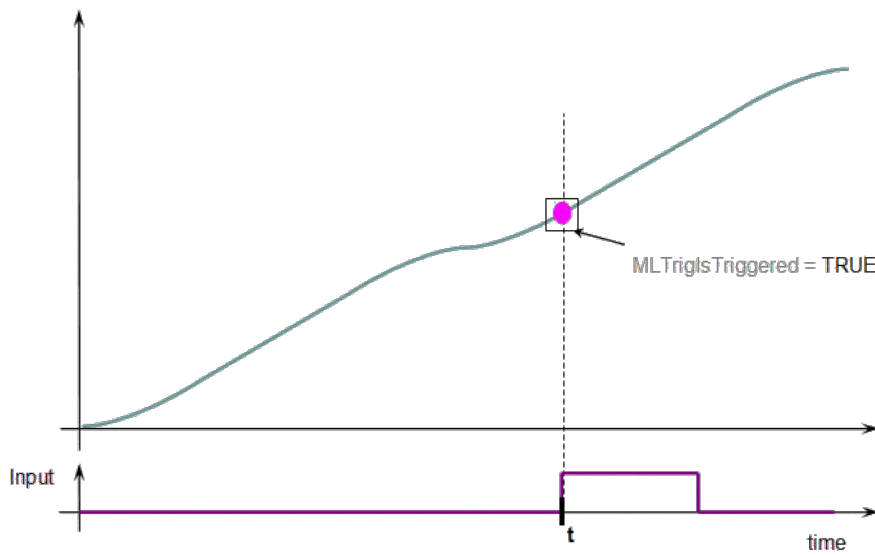

Then you can call the **MLTrigReadPos** and **MLTrigReadTime** functions to get more details.

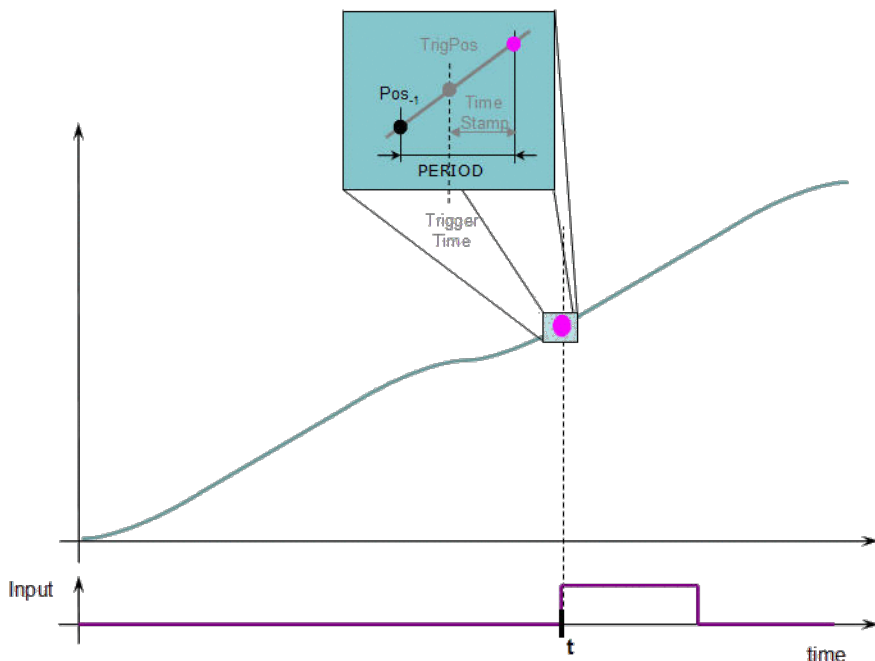

Figure 1-55: Trigger Functions Usage

ⓘ IMPORTANT

The trigger delay has to be calculated by **you** and set with the [MLTrigWriteDelay](#) function block. This delay belongs to the sensor and it is additional to the [MLTrigReadTime](#) / [MLTrigReadPos](#).

2.1.17.2 [MLTrigClearFlag](#) Pipe Network ✓

2.1.17.2.1 Description

Clears the flag of an initiated Trigger block so the block can capture the position and time of the next event. Once triggered, a block has to be reset with this command before it can be triggered again. All events that are sent to a block while in a triggered state are ignored and the position and time information is lost.

ⓘ IMPORTANT

The Fast Input assigned to a Trigger block has to be reset as well before information on a new event can be captured. [MLAxisRstFastIn](#) is generally used at the same time as [MLTrigClearFlag](#)

NOTE

This function or function block returns cached data. See [Programming a Dual Core Controller](#) for more information.

2.1.17.2.2 Arguments

2.1.17.2.2.1 Input

BlockID	Description	ID number of an initiated Trigger object
	Data type	DINT
	Range	[-2147483648, 2147483648]
	Unit	N/A
	Default	—

2.1.17.2.2.2 Output

Default (.Q)	Description	Returns TRUE if function block is executed
	Data type	BOOL
	Unit	N/A

2.1.17.2.3 Return Type

BOOL

2.1.17.2.4 Related Functions

[MLAxisRstFastIn](#)

[MLTrigIsTriggered](#)

[MLTrigReadPos](#)

[MLTrigReadTime](#)

2.1.17.2.5 See Also

- [Fast Inputs with Pipe Network Motion](#)
- [Fast Homing Example with the Pipe Network Motion Engine Axis Pipe Block](#)
- [Fast Homing Example with the PLCopen Motion Engine](#)
- [Pipe Network Registration and Fast Homing](#)
- [Registration Position Capture Example with Pipe Network Trigger Block](#)

2.1.17.2.6 Example

2.1.17.2.6.1 Structured Text

```
//Clear Trigger Flag
MLTrigClearFlag( PipeNetwork.TRIGGER );
```

2.1.17.2.6.2 Ladder Diagram

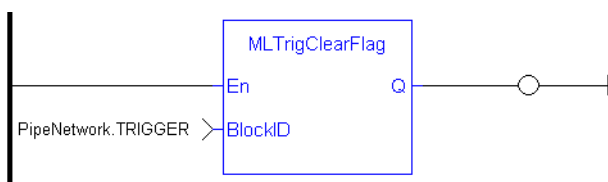

2.1.17.2.6.3 Function Block Diagram

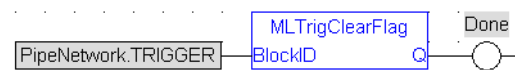

2.1.17.3 MLTrigInit Pipe Network ✓

2.1.17.3.1 Description

Initializes a Trigger object for use in a PLC Program. Function block is automatically called if a Trigger Block is added to the Pipe Network, with user-defined settings entered in the Pipe Blocks Properties screen.

The Trigger object monitors a selected Fast Input and captures the time of a rising or falling edge event. With the time and pipe position information the Trigger object extrapolates the axis position when the Fast Input event occurred.

Parameters to enter include the name of the Pipe Block, the Axis where the Fast Input is located, the number of the desired Fast Input, and whether to trigger on the rising or falling edge of the input.

NOTE

Trigger objects are normally created in the Pipe Network using the graphical engine. Then you do not have to add MLTrigInit function blocks to their programs. Parameters are entered directly in pop-up windows, and the code is then automatically added to the current project.

2.1.17.3.2 Arguments

2.1.17.3.2.1 Input

BlockID	Description	ID number of a created Pipe Block
	Data type	DINT
	Range	[-2147483648, 2147483648]
	Unit	N/A
	Default	—
Input_Axis	Description	Name of the axis where the Fast Input is located
	Data type	STRING
	Range	—
	Unit	N/A
	Default	—
InputID	Description	ID number of the Fast Input 0 = Touch Probe 1 / Capture Engine 0 1 = Touch Probe 2 / Capture Engine 1 Range is [0,1]
	Data type	DINT
	Range	[-2147483648, 2147483648]
	Unit	N/A
	Default	—
EdgeID	Description	Trigger at rising or falling edge of Fast Input. Enter 1 for rising edge, 2 for falling edge, and 0 disables the Fast Input
	Data type	DINT
	Range	[0, 2]

Unit	N/A
Default	1 (Rising edge)

2.1.17.3.2.2 Output

Default (.Q)	Description	Returns TRUE if function block is executed
	Data type	BOOL
	Unit	N/A

2.1.17.3.2.3 Return Type

BOOL

2.1.17.3.3 Related Functions

[MLTrigIsTriggered](#)

[MLTrigReadPos](#)

[MLTrigClearFlag](#)

[MLAxisRstFastIn](#)

2.1.17.3.4 See Also

- [Fast Inputs with Pipe Network Motion](#)
- [Fast Homing Example with the Pipe Network Motion Engine Axis Pipe Block](#)
- [Fast Homing Example with the PLCopen Motion Engine](#)
- [Pipe Network Registration and Fast Homing](#)
- [Registration Position Capture Example with Pipe Network Trigger Block](#)

2.1.17.3.5 Example

2.1.17.3.5.1 Structured Text

```
//Create and Initiate a Trigger Pipe Block named "Trigger" and set it up
//to receive the trigger signal from Axis1, capture engine 0, and the
//rising edge of the signal
TRIGGER := MlBlkCreate( 'TRIGGER', 'TRIGGER' );
MLTrigInit( TRIGGER, 'Axis1', 0, 1 );
```

2.1.17.3.5.2 Ladder Diagram

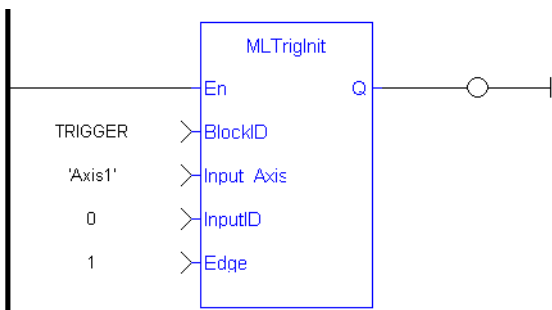

2.1.17.3.5.3 Function Block Diagram

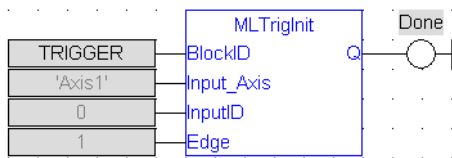

2.1.17.4 MLTrigsTriggered Pipe Network ✓

2.1.17.4.1 Description

Checks if the selected block has been triggered. When a block has been triggered, it contains the time and position when a Fast Input event occurred. The application has to reset the block before the block can be triggered again. All trigger events that are sent to the block during its triggered state are lost.

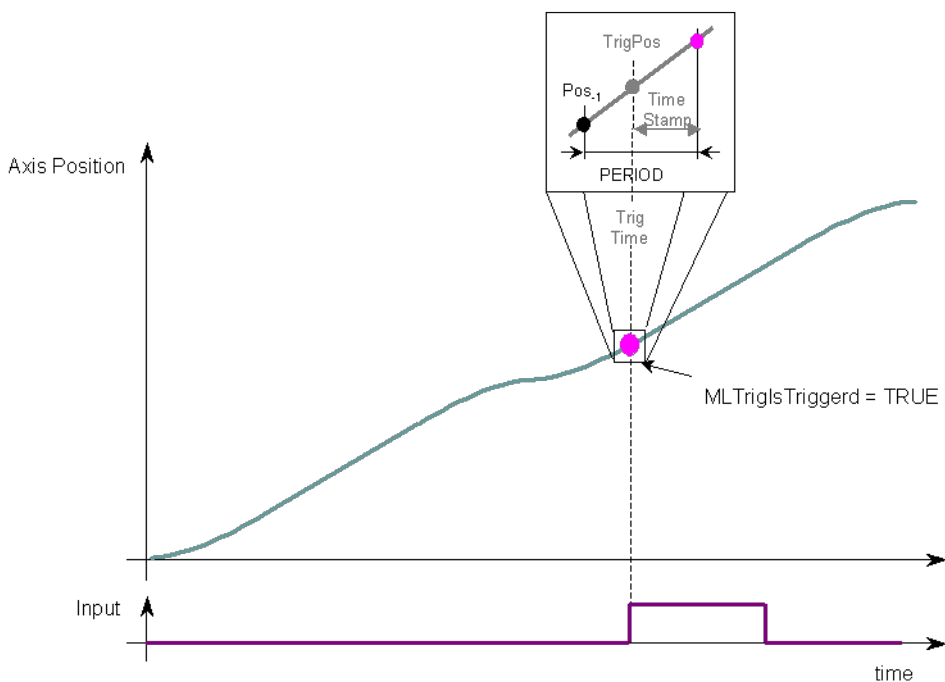

Figure 1-56: MLTrigIsTriggered

NOTE
Once triggered, a block has to be reset before it can be triggered again. All events that are sent to a block while in a triggered state are ignored and the position and time information is lost.

NOTE
This function or function block returns cached data. See [Programming a Dual Core Controller](#) for more information.

2.1.17.4.2 Arguments

2.1.17.4.2.1 Input

BlockID	Description	ID number of an initiated Trigger object
	Data type	DINT
	Range	[-2147483648, 2147483648]

Unit	N/A
Default	—

2.1.17.4.2.2 Output

Default (.Q)	Description	Returns TRUE if the selected Trigger Object has Triggered
	Data type	BOOL
	Unit	N/A

2.1.17.4.2.3 Return Type

BOOL

2.1.17.4.3 Related Functions

[MLTrigReadPos](#)

[MLTrigReadTime](#)

2.1.17.4.4 See Also

- [Fast Inputs with Pipe Network Motion](#)
- [Fast Homing Example with the Pipe Network Motion Engine Axis Pipe Block](#)
- [Fast Homing Example with the PLCopen Motion Engine](#)
- [Pipe Network Registration and Fast Homing](#)
- [Registration Position Capture Example with Pipe Network Trigger Block](#)

2.1.17.4.5 Example

//Check if a Trigger Block has been triggered, then save position

IF MLTrigIsTriggered(PipeNetwork.TRIGGER) THEN

Trig_Position := MLTrigReadPos(PipeNetwork.TRIGGER);

END_IF

2.1.17.4.5.1 Ladder Diagram

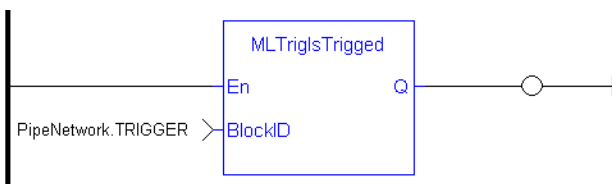

2.1.17.4.5.2 Function Block Diagram



2.1.17.5 MLTrigReadDelay Pipe Network ✓

2.1.17.5.1 Description

Electronic sensors are not able to respond immediately to a signal. Sensors usually require a certain amount of time to process a change of state in their input signal. This function returns the delay that has been programmed in a trigger block by the [MLTrigWriteDelay](#) function to compensate for this reaction time required by the sensor.

2.1.17.5.1.1 Input

BlockID	Description	Identifier of the trigger block whose delay is requested
	Data type	DINT
	Range	[-2147483648, 2147483648]
	Unit	N/A
	Default	—
En	Description	Enables execution
	Data type	BOOL
	Unit	N/A
	Default	-

2.1.17.5.1.2 Output

Delay	Description	Value of the delay compensation currently applied by the trigger block
	Data type	LREAL
	Unit	microseconds
OK	Description	Returns true when the function successfully executes
	Data type	BOOL
	Unit	N/A

2.1.17.5.2 Related Functions

[MLTrigWriteDelay](#)

2.1.17.5.3 See Also

- [Fast Inputs with Pipe Network Motion](#)
- [Fast Homing Example with the Pipe Network Motion Engine Axis Pipe Block](#)
- [Fast Homing Example with the PLCopen Motion Engine](#)
- [Pipe Network Registration and Fast Homing](#)
- [Registration Position Capture Example with Pipe Network Trigger Block](#)

2.1.17.6 MLTrigReadPos

2.1.17.6.1 Description

Returns the modulo-applied position of the pipe at the moment it is triggered by the Trigger Block's selected Fast Input. This value is only valid when TrigIsTriggered() returns TRUE. The Trigger block extrapolates the output value based on the timestamp of the Fast Input event to provide an accurate position even if the event occurs in the middle of a program cycle.

Once triggered, a block has to be reset before it can be triggered again. All events that are sent to a block while in a triggered state are ignored and the position and time information is lost.

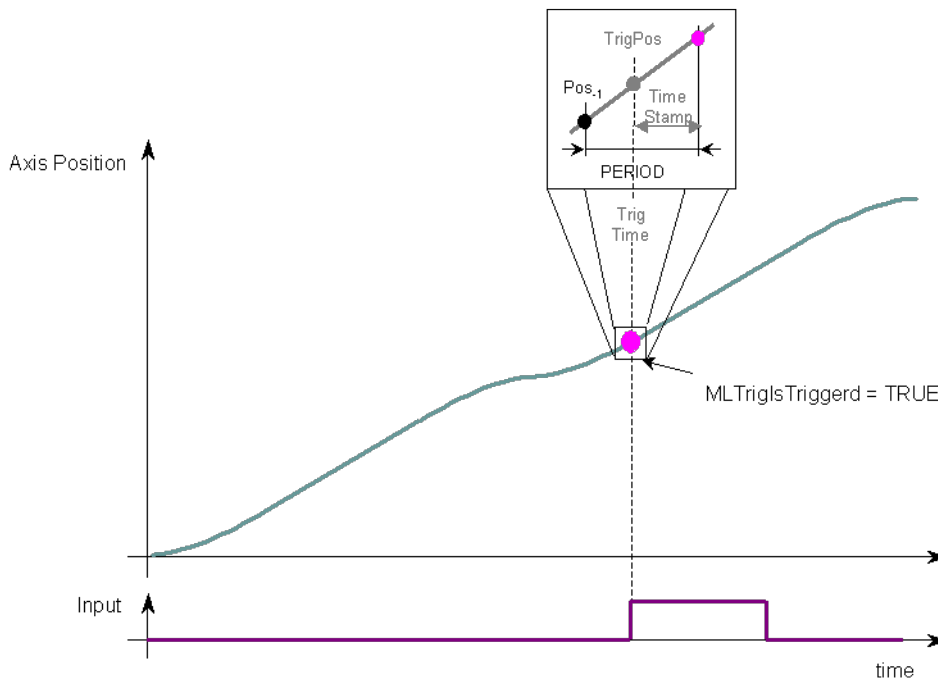

Figure 1-57: MLTrigReadPos

Modulo Calculation: MLTrigReadPos uses the “Output Modulo Position” value of the previous block in the pipe, even if the previous pipe is configured for “No Modulo” mode. The previous block must specify a zero value for “Output Modulo Position” before setting the “Mode” to “No Modulo” to prevent a modulo operation for MLTrigReadPosPipe.

NOTE

This function or function block returns cached data. See [Programming a Dual Core Controller](#) for more information.

2.1.17.6.2 Arguments

2.1.17.6.2.1 Input

BlockID	Description	ID number of an initiated Trigger object
	Data type	DINT
	Range	[-2147483648, 2147483648]
	Unit	N/A
	Default	—

2.1.17.6.2.2 Output

Position	Description	Returns the position of the selected block's Axis at the moment when it was triggered
	Data type	LREAL
	Unit	User unit

2.1.17.6.3 Related Functions

[MLTrigIsTriggered](#)

[MLTrigReadTime](#)[MLTrigClearFlag](#)[MLAxisRstFastIn](#)

2.1.17.6.4 See Also

- [Fast Inputs with Pipe Network Motion](#)
- [Fast Homing Example with the Pipe Network Motion Engine Axis Pipe Block](#)
- [Fast Homing Example with the PLCopen Motion Engine](#)
- [Pipe Network Registration and Fast Homing](#)
- [Registration Position Capture Example with Pipe Network Trigger Block](#)

2.1.17.6.5 Previous Function Name

MLTrigGetPos

2.1.17.6.6 Example

2.1.17.6.6.1 Structured Text

```
//Save position of Axis when Fast Input event occurs
Trig_Position := MLTrigReadPos( PipeNetwork.TRIGGER );
```

2.1.17.6.6.2 Ladder Diagram

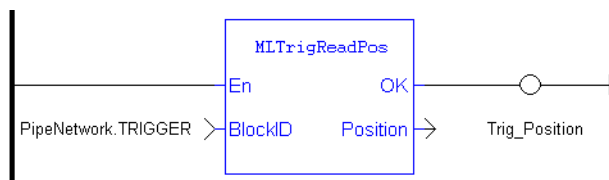

2.1.17.6.6.3 Function Block Diagram

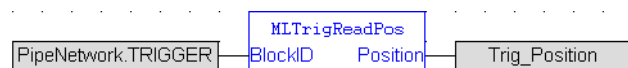

2.1.17.7 MLTrigReadTime Pipe Network ✓

2.1.17.7.1 Description

Returns the time of the moment where the block was triggered in milliseconds. This value is only valid when TrigIsTriggered() returns TRUE. The output is computed from the timestamp of a Fast Input time event

Once triggered, a block has to be reset before it can be triggered again. All events that are sent to a block while in a triggered state are ignored and the position and time information is lost.

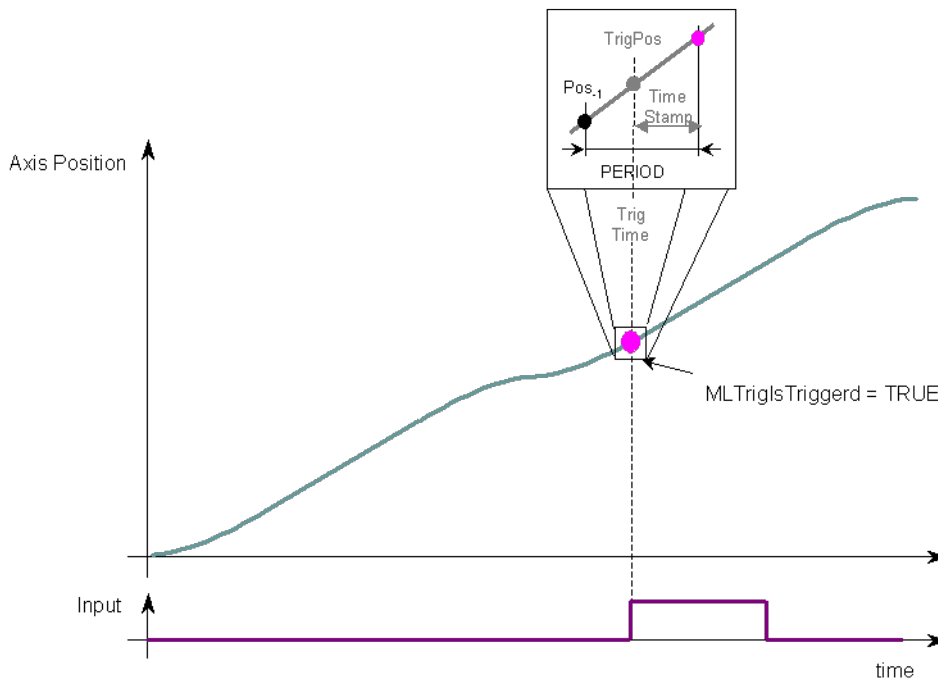

Figure 1-58: MLTrigReadTime

NOTE

This function or function block returns cached data. See [Programming a Dual Core Controller](#) for more information.

2.1.17.7.2 Arguments

2.1.17.7.2.1 Input

BlockID	Description	ID number of an initiated Trigger object
	Data type	DINT
	Range	[-2147483648, 2147483648]
	Unit	N/A
	Default	—

2.1.17.7.2.2 Output

Time	Description	Returns the time that the Trigger Block's selected Fast Input was triggered
	Data type	LREAL
	Unit	milliseconds

2.1.17.7.3 Related Functions

- [MLTrigIsTriggered](#)
- [MLTrigReadPos](#)
- [MLTrigClearFlag](#)

[MLAxisRstFastIn](#)

2.1.17.7.4 See Also

- [Fast Inputs with Pipe Network Motion](#)
- [Fast Homing Example with the Pipe Network Motion Engine Axis Pipe Block](#)
- [Fast Homing Example with the PLCopen Motion Engine](#)
- [Pipe Network Registration and Fast Homing](#)
- [Registration Position Capture Example with Pipe Network Trigger Block](#)

2.1.17.7.5 Previous Function Name

MLTrigGetTime

2.1.17.7.6 Example

//Save time when Fast Input event occurs

Trig_Time := MLTrigReadTime(PipeNetwork.TRIGGER);

2.1.17.7.6.1 Ladder Diagram

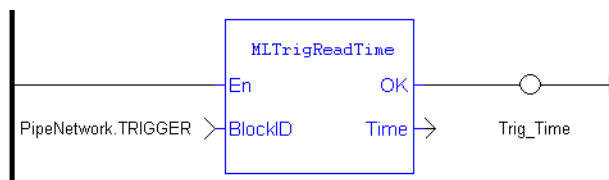

2.1.17.7.6.2 Function Block Diagram

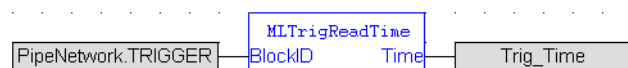

2.1.17.8 MLTrigSetEdge Pipe Network ✓

2.1.17.8.1 Description

Sets the edge configuration (rising, falling, etc.) for a trigger block. This block should be called prior to calling [MLAxisCfgFastIn](#). Also the value at the Edge input must match the value at [MLAxisCfgFastIn](#)'s Mode input.

2.1.17.8.2 Arguments

2.1.17.8.2.1 Input

BlockID	Description	Identifier of the trigger block
	Data type	DINT
	Range	[-2147483648, 2147483647]
	Unit	N/A
	Default	—
Edge	Description	The edge on which to trigger 0 = disable the fast input 1 = rising edge 2 = falling edge
	Data type	DINT

Range	[0,2]
Unit	N/A
Default	1 (rising edge)

2.1.17.8.2.2 Output

Q	Description	True if block executed successfully False if execution is not successful
	Data type	BOOL
	Unit	N/A

2.1.17.8.2.3 Return Type

BOOL

2.1.17.8.3 See Also

- [Fast Inputs with Pipe Network Motion](#)
- [Fast Homing Example with the Pipe Network Motion Engine Axis Pipe Block](#)
- [Fast Homing Example with the PLCopen Motion Engine](#)
- [Pipe Network Registration and Fast Homing](#)
- [Registration Position Capture Example with Pipe Network Trigger Block](#)

2.1.17.8.4 Examples

2.1.17.8.4.1 Function Block Diagram

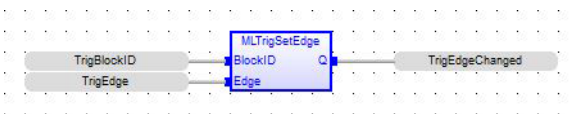

2.1.17.8.4.2 Ladder Diagram

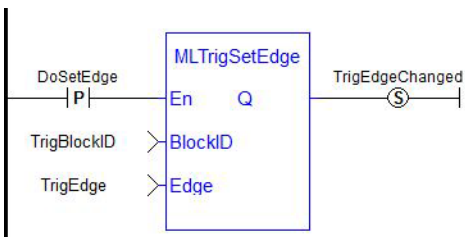

2.1.17.8.4.3 Structured Text

```
TrigEdgeChanged := MLTrigSetEdge(TrigBlockID,TrigEdge);
```

2.1.17.9 MLTrigWriteDelay Pipe Network ✓

2.1.17.9.1 Description

Electronic sensors are not able to respond immediately to a signal. Sensors usually require a certain amount of time to process a change of state in their input signal. This function allows the trigger block to calculate the exact moment at which a signal was triggered by letting you specify the compensation. The delay compensation should include drive processing time, sensor delay, and the communication latency through the EtherCAT network.

2.1.17.9.2 Arguments

2.1.17.9.2.1 Input

BlockID	Description	Identifier of the trigger block
	Data type	DINT
	Range	[-2147483648, 2147483648]
	Unit	N/A
	Default	—
Delay	Description	Reaction time of the sensor that the trigger block has to compensate
	Data type	LREAL
	Range	—
	Unit	microseconds
	Default	—

2.1.17.9.2.2 Output

Default (.Q)	Description	Returns TRUE if the delay is successfully set
	Data type	BOOL
	Unit	N/A

2.1.17.9.2.3 Return Type

BOOL

2.1.17.9.3 Related Functions

[MLTrigReadDelay](#)

2.1.17.9.4 See Also

- [Fast Inputs with Pipe Network Motion](#)
- [Fast Homing Example with the Pipe Network Motion Engine Axis Pipe Block](#)
- [Fast Homing Example with the PLCopen Motion Engine](#)
- [Pipe Network Registration and Fast Homing](#)
- [Registration Position Capture Example with Pipe Network Trigger Block](#)

2.2 Motion Library - PLCopen

Functions sorted in alphabetical order:

Name	Description
MC_AbortTrigger	Abort MC_TouchProbe
MC_AddSuperAxis	Add an axis to the axis's list of assigned, superimposed axes.
MC_CamIn	Performs a slave axis move based on the Cam Table
MC_CamOut	Disengages the slave axis from a MC_CamIn move
MC_CamResumePos	Returns the slave axis position for resuming an MC_CamIn move

Name	Description
MC_CamStartPos	Returns the slave axis position for starting an MC_CamIn move
MC_CamTblSelect	Defined to read and initialize the specified profile
MC_ClearFaults	Clear Drive Faults
MC_CreatePLCAxis	Creates a PLCopen Axis
MC_EStop	Performs a Emergency stop
MC_ErrorDescription	Converts the PLCopen error IDs into message strings.
MC_GearIn	Performs a slave axis move based on the ratio
MC_GearInPos	Performs a slave axis move based on the ratio
MC_GearOut	Disengages the slave axis from a MC_GearIn or MC_GearInPos move
MC_Halt	Decelerates an axis to zero velocity
MC_InitAxis	Initializes a PLCopen Axis' data
MC_InitAxisFeedback	Initializes a PLCopen Digitizing Axis' position data
MC_MachRegist	Runs Mark-to-Machine registration
MC_MarkRegist	Runs Mark-to-Mark registration
MC_MoveAbsolute	Performs a single-axis move to a specified endpoint position
MC_MoveAdditive	Performs a single-axis move for a specified distance from the endpoint of the previous move
MC_MoveRelative	Performs a single-axis move for a specified distance
MC_MoveSuperimp	Performs a single-axis move which is superimposed upon the active move
MC_MoveVelocity	Performs a single-axis non-ending move at a specified velocity
MC_Phasing	Performs a master position phase shift for the slave axis
MC_Power	Requests to enable the drive and close the loop, or disable the drive and open the loop
MC_ReadActPos	Reads the actual position of the axis
MC_ReadActVel	Reads the actual velocity of the axis
MC_ReadAxisErr	Returns the error status of the specified axis
MC_ReadBoolPar	Returns the value of the specified Boolean axis parameter
MC_ReadParam	Returns the value of the specified axis parameter
MC_ReadStatus	Returns the state of the specified axis
MC_Reference	Defines the position at the reference location for PLCopen Axis
MC_RemSuperAxis	Remove an axis from the axis's list of assigned, superimposed axes.
MC_ResetError	Resets the errors of the specified axis
MC_SetOverride	Writes velocity and acceleration override factors
MC_SetPosition	Deprecated by MC_SetPos
MC_SetPos	Sets a new axis position

Name	Description
MC_Stop	Aborts the active move, removes the next move from the queue, performs a controlled stop, and switches the axis to Stopping state
MC_StopRegist	Turns off registration for the specified axis
MC_SyncSlaves	Specifies synchronized slaves
MC_TouchProbe	Arm a Fast Input and capture an axis position
MC_WriteBoolPar	Writes the specified axis Boolean parameter
MC_WriteParam	Writes the specified axis parameter

2.2.1 Control Functions

This set of functions provide general controls to drives and axes.

2.2.1.1 MC_ClearFaults PLCopen

2.2.1.1.1 Description

The MC_ClearFaults function sends a request to the drive to clear any drive faults that exists.

NOTE

The condition causing the drive fault has to be corrected before calling this function. If the fault condition still exists when this function is called, this function sends a request to the drive but the drive faults remain.

TIP

This function does **not** reset axis errors. [MC_ResetError](#) is required to reset axis errors and possibly to re-enable or turn power on to the servo axis after the fault condition is cleared.

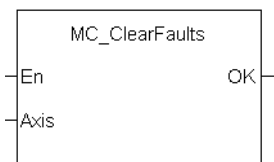

Figure 1-59: MC_ClearFaults

NOTE

This function or function block returns cached data. See [Programming a Dual Core Controller](#) for more information.

2.2.1.1.2 Arguments

2.2.1.1.2.1 Input

En	Description
	Function enable – execute function. This Input must be on shot.
	Data type BOOL
	Range 0, 1
	Unit N/A
	Default —

Axis	Description	AXIS_REF.AXIS_NUM is the master axis number
	Data type	AXIS_REF
	Range	[1,256]
	Unit	N/A
	Default	—

2.2.1.1.2.2 Output

OK	Description	Boolean output to indicate successful request. This output does not indicate that the fault are cleared, but simply indicates the request was made.
	Data type	BOOL

2.2.1.1.3 Usage

Upon the positive transition of the EN input, this function requests a Fault Reset of the Drive for the Axis defined in the axis input of this function.

2.2.1.1.4 Related Functions

[MC_ResetError](#)

2.2.1.1.5 Example

2.2.1.1.5.1 Structured Text

```
(* MC_ClearFaults ST example *)
MC_ClearFaults( Axis1); //clear drive faults for Axis 1
```

2.2.1.1.5.2 Function Block Diagram



2.2.1.1.5.3 Ladder Diagram

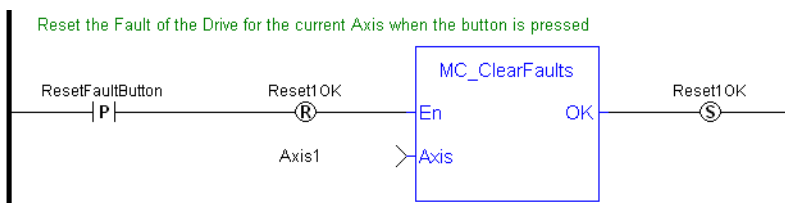

2.2.1.2 MC_CreatePLCAxis



2.2.1.2.1 Description

This function creates a PLCopen Axis. A call to this function is automatically generated when the application is compiled, based on the data entered in the PLCopen Axis Data dialog.

! IMPORTANT

MC_CreateAxis must be called between [MLMotionInit](#) and [MLMotionStart](#).

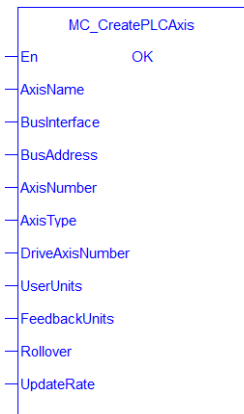

Figure 1-60: MC_CreatePLCAxis

2.2.1.2.2 Arguments

2.2.1.2.2.1 Input

En	Description	Requests to create a PLCopen axis
	Data type	BOOL
	Range	0, 1
	Unit	N/A
	Default	—
AxisName	Description	Axis name
	Data type	STRING
	Range	—
	Unit	N/A
	Default	—
BusInterface	Description	Bus interface identifier: "EtherCATDriver" = EtherCAT interface "MSBusDriver" = KAS Simulator interface
	Data type	STRING
	Range	—
	Unit	N/A
	Default	—
BusAddress	Description	Address of the drive on the bus
	Data type	DINT
	Range	bus dependent
	Unit	N/A

	Default	—									
AxisNumber	Description	Axis number									
	Data type	UINT									
	Range	[1,256]									
	Unit	N/A									
	Default	—									
AxisType	Description	<table border="1"> <tr> <td>0</td> <td>MC_AXIS_ TYPE_ SERVO_ STEPPER</td> <td>A Servo or Stepper axis can be mapped to a physical or simulated drive. Either a servo or stepper drive is supported.</td> </tr> <tr> <td>1</td> <td>MC_AXIS_ TYPE_ DIGITIZING</td> <td>A digital position input from a drive or other device. It is useful as an input for gearing, camming, etc.</td> </tr> <tr> <td>2</td> <td>MC_AXIS_ TYPE_ VIRTUAL</td> <td>A virtual axis cannot be mapped to a physical or simulated drive. It is useful for generating motion trajectory as an input for gearing, camming, etc.</td> </tr> </table>	0	MC_AXIS_ TYPE_ SERVO_ STEPPER	A Servo or Stepper axis can be mapped to a physical or simulated drive. Either a servo or stepper drive is supported.	1	MC_AXIS_ TYPE_ DIGITIZING	A digital position input from a drive or other device. It is useful as an input for gearing, camming, etc.	2	MC_AXIS_ TYPE_ VIRTUAL	A virtual axis cannot be mapped to a physical or simulated drive. It is useful for generating motion trajectory as an input for gearing, camming, etc.
0	MC_AXIS_ TYPE_ SERVO_ STEPPER	A Servo or Stepper axis can be mapped to a physical or simulated drive. Either a servo or stepper drive is supported.									
1	MC_AXIS_ TYPE_ DIGITIZING	A digital position input from a drive or other device. It is useful as an input for gearing, camming, etc.									
2	MC_AXIS_ TYPE_ VIRTUAL	A virtual axis cannot be mapped to a physical or simulated drive. It is useful for generating motion trajectory as an input for gearing, camming, etc.									
	Data type	USINT									
	Range	[0,1]									
	Unit	N/A									
	Default	—									
DriveAxisNumber	Description	This one-based number specifies the axis on the drive. For a single-axis drive this number should be 1.									
	Data type	UINT									
	Range	[1,256]									
	Unit	N/A									
	Default	—									
UserUnits	Description	User unit portion of the user unit/feedback unit ratio									
	Data type	DINT									
	Range	[1, 2147483647]									
	Unit	User unit									
	Default	—									
FeedbackUnits	Description	Feedback unit portion of the user unit/feedback unit ratio									
	Data type	DINT									
	Range	[1, 2147483647]									
	Unit	Feedback units									

	Default	—
Rollover	Description	Rollover position (0 = no rollover)
	Data type	LREAL
	Range	[0, 4294967296]
	Unit	User unit
	Default	—
UpdateRate	Description	Servo update rate (0, 1, and 2 are reserved for future enhancements) 3 = 125 µsec 4 = 250 µsec 5 = 500 µsec 6 = 1 msec 7 = 2 msec 8 = 4 msec 9 = 8 msec
	Data type	UINT
	Range	[3,9]
	Unit	N/A
	Default	—

2.2.1.2.2.2 Output

OK	Description	Indicates the axis has been created
	Data type	BOOL

2.2.1.2.3 Example

2.2.1.2.3.1 Structured Text

```
(* MC_CreatePLCAxis ST Example *)
AxisName1      := 'PLCOpenAxis1';
BusName1       := 'EtherCATDriver';
BusAddress1    := 1001;
AxisNumber1    := 1;
AxisType1      := MC_AXIS_TYPE_SERVO_STEPPER;
DriveAxisNumber1 := 1;
UserUnits1     := 360;
FeedbackUnits1 := 1048576;
Rollover1      := 0;
UpdateRate1    := 3;
MC_CreateAxis(AxisName1, BusName1, BusAddress1, AxisNumber1, AxisType1,
DriveAxisNumber1, UserUnits1, FeedbackUnits1, Rollover1, UpdateRate1);
```

2.2.1.2.3.2 Function Block Diagram

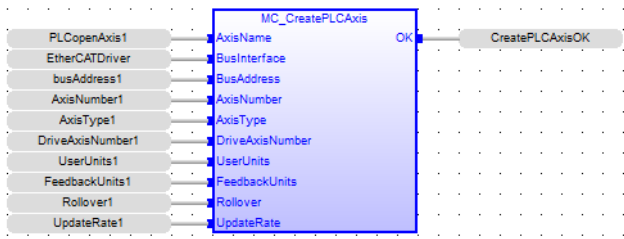

2.2.1.2.3.3 Ladder Diagram

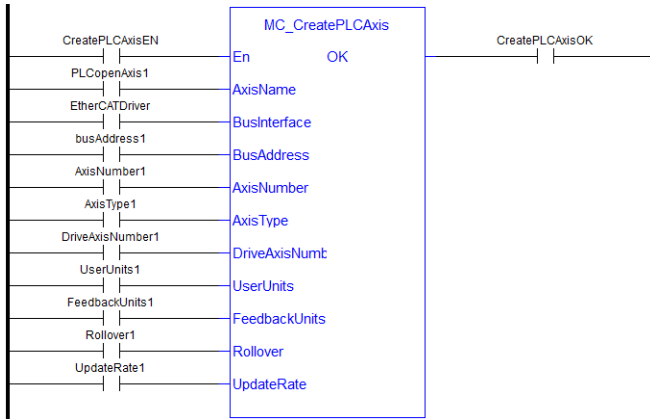

2.2.1.3 MC_EStop PLCopen ✔

2.2.1.3.1 Description

This function causes an emergency stop (E-stop). An E-stop stops motion interpolation, clear all moves from the queue (active and next), change the axis state to **ErrorStop**, and request the drive to open the position loop and disable the drive. The E-stop remains in effect until the application calls **MC_ResetError** to reset the E-stop.



Figure 1-61: MC_EStop

NOTE

This function or function block returns cached data. See [Programming a Dual Core Controller](#) for more information.

2.2.1.3.2 Arguments

2.2.1.3.2.1 Input

En	Description	A positive transition of this input causes an E-stop on the specified axis
	Data type	BOOL
	Range	0, 1
	Unit	N/A
	Default	—
Axis	Description	Axis identifier

Data type	AXIS_REF
Range	1-256 The AXIS_NUM element of the AXIS_REF structure must be in the range [1-256]
Unit	N/A
Default	—

2.2.1.3.2.2 Output

OK	Description	Indicates the E-stop was executed. If an invalid Axis input was specified, this output is not energized and no E-stop is performed.
	Data type	BOOL

2.2.1.3.3 Usage

Call MC_EStop to generate an emergency stop for an axis.

Call [MC_ResetError](#) to reset the emergency stop.

2.2.1.3.4 Related Functions

[MC_ResetError](#)

2.2.1.3.5 Example

2.2.1.3.5.1 Structured Text

```
(* MC_EStop ST example *)
ON EStopButton DO
MC_EStop( Axis1 );
MC_EStop( Axis2 );
END_DO;
```

2.2.1.3.5.2 Function Block Diagram

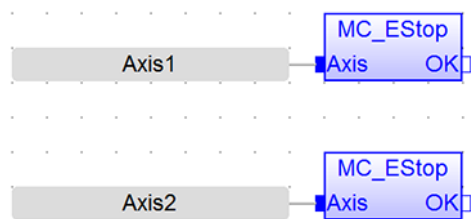

2.2.1.3.5.3 Ladder Diagram

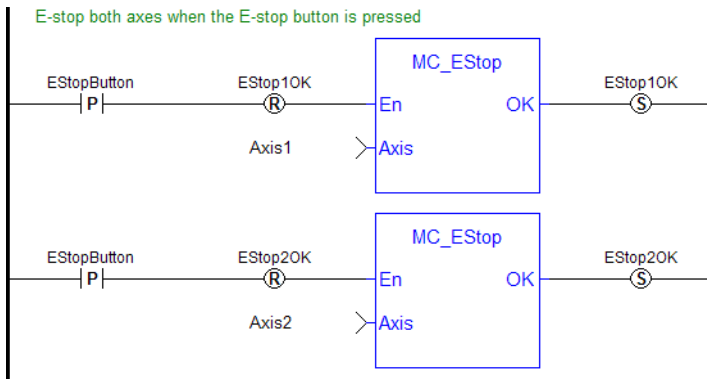

2.2.1.4 MC_InitAxis PLCopen

2.2.1.4.1 Description

MC_InitAxis initializes a PLCopen Axis' data. A call to this function is automatically generated when the application is compiled, based on the data entered in the PLCopen Axis Data dialog.

MC_InitAxis	
En	OK
AxisNumber	
VelocityLimit	
LowerLimit	
UpperLimit	
LimitControl	
PosErrorLimit	
InPositionBand	

Figure 1-62: MC_InitAxis

2.2.1.4.2 Arguments

2.2.1.4.2.1 Input

En	Description	Request to initialize a PLCopen axis
	Data type	BOOL
	Range	0, 1
	Unit	N/A
	Default	—
AxisNumber	Description	Axis number
	Data type	UINT
	Range	[1,256]
	Unit	none
	Default	—
VelocityLimit	Description	<i>Reserved for future use</i>
	Data type	LREAL
	Range	—
	Unit	User unit/sec

	Default	—
LowerLimit	Description	<i>Reserved for future use</i>
	Data type	LREAL
	Range	—
	Unit	User unit
	Default	—
UpperLimit	Description	<i>Reserved for future use</i>
	Data type	LREAL
	Range	—
	Unit	User unit
	Default	—
LimitControl	Description	<i>Reserved for future use</i>
	Data type	UINT
	Range	[0,2]
	Unit	N/A
	Default	—
PosErrorLimit	Description	Position error limit – when the Position Error (command position – actual position) exceeds this value, an E-stop is generated
	Data type	LREAL
	Range	—
	Unit	User unit
	Default	—
InPositionBand	Description	In-position bandwidth – when the axis actual position is within this distance from its programmed endpoint, the axis is considered “in position”
	Data type	LREAL
	Range	—
	Unit	User unit
	Default	—

2.2.1.4.2.2 Output

OK	Description	Indicates the initialization is complete
	Data type	BOOL

2.2.1.4.3 Example

2.2.1.4.3.1 Structured Text

```
(* MC_InitAxis ST example *)
AxisNumber1      := 1;
VelocityLimit1   := 10000; (*User unit/second*)
LowerPosLimit1   := 0;
UpperPosLimit1   := 0;
LimitControl1    := 0; (* Ignore lower and upper pos limit*)
PosErrorLimit1   := 10; (*User unit*)
InPosBand1       := 0;
MC_InitAxis(AxisNumber1, VelocityLimit1, LowerPosLimit1, UpperPosLimit1,
LimitControl1, PosErrorLimit1, InPosBand1);
```

2.2.1.4.3.2 Function Block Diagram

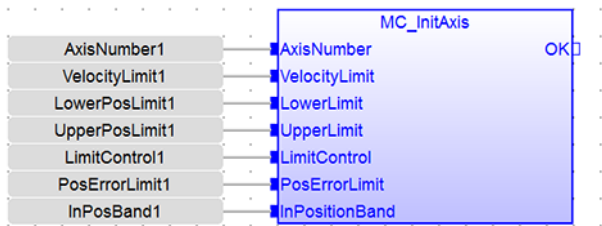

2.2.1.4.3.3 Ladder Diagram

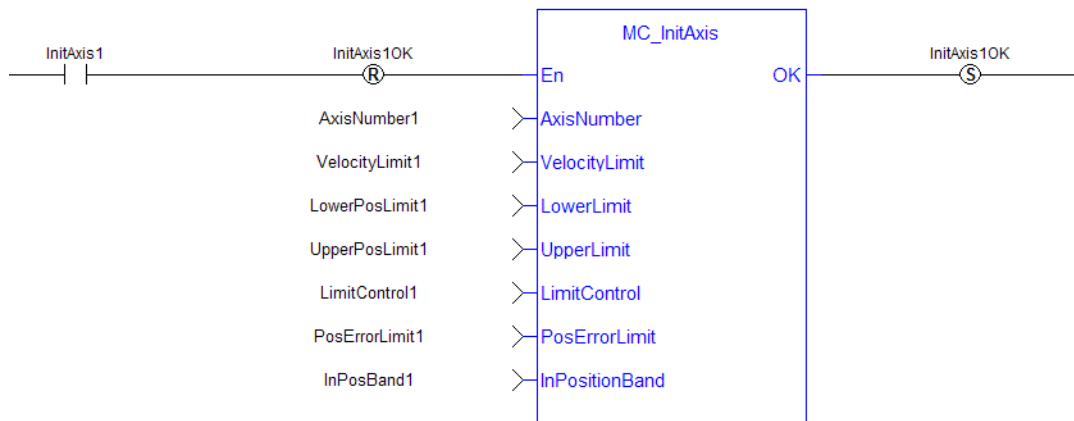

2.2.1.5 MC_InitAxisFeedback PLCopen ✔

2.2.1.5.1 Description

This function block initializes a PLCopen Digitizing Axis position data. A call to this function is automatically generated when the application is compiled, based on the data entered in the PLCopen Axis Data dialog.

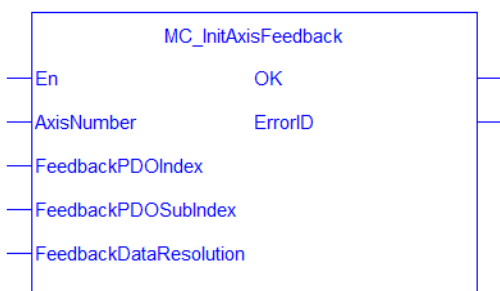

Figure 1-63: MC_InitAxisFeedback

2.2.1.5.2 Arguments

2.2.1.5.2.1 Input

En	Description	Request to Initialize a PLCopen Digitizing Axis. This input is only applicable to FFLD programs.
	Data type	BOOL
	Range	0,1
	Unit	N/A
	Default	-
AxisNumber	Description	Digitizing Axis Number
	Data type	UINT
	Range	[1,256]
	Unit	none
	Default	-
FeedbackPDOIndex	Description	The object Index through which the feedback data is sent.
	Data type	UINT
	Range	[0,65536]
	Unit	N/A
	Default	-
FeedbackPDOSubIndex	Description	The sub index of the object through which the feedback data is sent to controller.
	Data type	UINT
	Range	[0,255]
	Unit	
	Default	
FeedbackDataResolution	Description	The resolution of the Encoder
	Data type	UINT
	Range	[1,32]
	Unit	N/A
	Default	-

2.2.1.5.2.2 Output

OK	Description	Indicates the initialization is complete. This output is only applicable to FFLD programs.
	Data type	BOOL

ErrorID	Description	Indicates if the call failed or succeeded. If the call succeeds, will be set to 0.
	Data type	DINT

2.2.1.5.3 Example

2.2.1.5.3.1 Structured Text

```
(* MC_InitAxisFeedback ST example *)
// Initialize the digitizing Axis (Axis #3) with the Feedback object
0x60E4 subIndex 2.
Encoder resolution is 25bits.
ErrID := MC_InitAxisFeedback(3, 16#60E4, 16#02, 25);
```

2.2.1.5.3.2 FBD Example

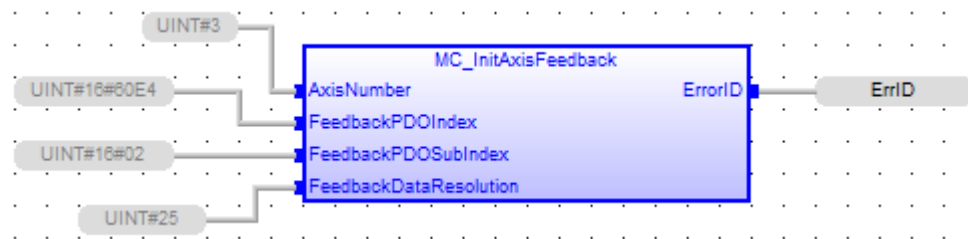

2.2.1.6 MC_Power PLCopen

2.2.1.6.1 Description

This function block requests to enable the drive and close the position loop, or disable the drive and open the position loop. The Status output indicates the state of the position loop. If the position loop is open, the axis command position is set to the actual position of the axis and tracks the actual position.

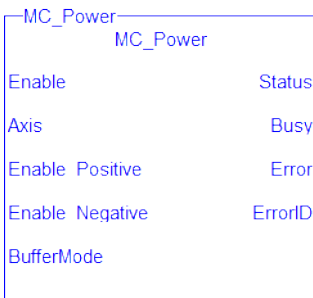

Figure 1-64: MC_Power

NOTE
 You must be careful if you have more than one instance of MC_Power FB for the same drive, scanned in the same cycle. The problem arises when one instance requests the drive to enable and the other requests the same drive to disable.
 To avoid this trap, it is recommended to have only one instance of MC_Power for all of your active programs.

NOTE
 This function or function block returns cached data. See [Programming a Dual Core Controller](#) for more information.

2.2.1.6.2 Arguments

2.2.1.6.2.1 Input

Enable	Description	When this transitions go to high, the control closes the servo loop and sends a command to the drive to enable . When this transitions go to low, the control opens the servo loop and sends a command to the drive to disable .
	Data type	BOOL
	Range	0, 1
	Unit	N/A
	Default	—
Axis	Description	Name of a declared instance of the AXIS_REF library function.
	Data type	AXIS_REF
	Range	[1,256]
	Unit	N/A
	Default	—
Enable Positive	Description	<i>for future enhancement</i>
	Data type	BOOL
	Range	0, 1
	Unit	N/A
	Default	—
Enable Negative	Description	<i>for future enhancement</i>
	Data type	BOOL
	Range	0, 1
	Unit	N/A
	Default	—
BufferMode	Description	Unused
	Data type	SINT
	Range	[0]
	Unit	N/A
	Default	—

2.2.1.6.2.2 Output

Status	Description	Indicates the enabled/disabled state of the drive
	Data type	BOOL
Busy	Description	for future enhancement – always false
	Data type	BOOL
Error	Description	Indicates an invalid input was specified
	Data type	BOOL
ErrorID	Description	Indicates the error if Error output is set to TRUE
	Data type	INT

2.2.1.6.3 Example

2.2.1.6.3.1 Structured Text

```
(* MC_Power ST example *)
Inst_MC_Power( CloseLoopReq, Axis1, TRUE, TRUE, 0 );
//Inst_MC_Power is an instance of MC_Power function block
DriveIsOn := Inst_MC_Power.Status; //store the Status output
into a user defined variable
```

2.2.1.6.3.2 Ladder Diagram

Close the servo loop and enable the drive when CloseLoop is high.
Open the servo loop and disable the drive when CloseLoop is low.

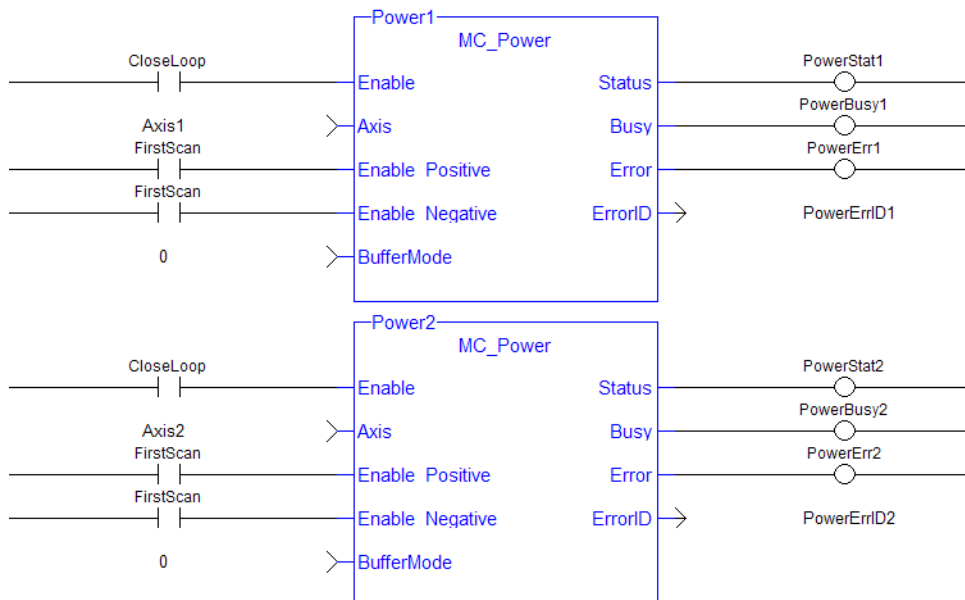

2.2.1.7 MC_ErrorDescription

PLCopen
✔
Pipe Network
✔

This function converts the PLCopen error IDs into message strings which can be used for display or logging.

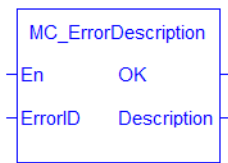

Figure 1-65: MC_ErrorDescription Function Block

2.2.1.7.1 Arguments

2.2.1.7.1.1 Inputs

En	Description	If True, then this function will convert the Error Id into a string message
	Data type	BOOL
	Range	0, 1
	Unit	N/A
	Default	—
ErrorID	Description	Error ID generated from a PLCopen Function Block. See PLCopen Function Block ErrorID Output for output details.
	Data type	INT
	Range	0,69
	Unit	N/A
	Default	—

2.2.1.7.1.2 Outputs

OK	Description	If True, then the command completed successfully.
	Data type	BOOL
	Range	0, 1
	Unit	N/A
	Default	—
Description	Description	String error description
	Data type	STRING
	Range	—
	Unit	N/A
	Default	—

2.2.1.7.2 Examples

2.2.1.7.2.1 Structured Text

```
Description := MC_ErrorDescription(ErrorID);
```

2.2.1.7.2.2 IL

Not applicable

2.2.1.7.2.3 Function Block



2.2.1.7.2.4 Ladder Diagram

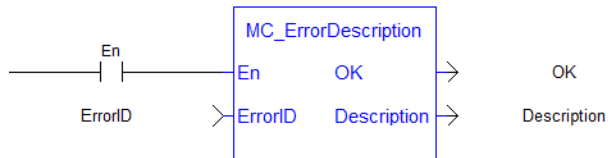

2.2.1.8 MC_ResetError PLCopen ✔

2.2.1.8.1 Description

The function MC_ResetError resets the errors of a specified axis.

This function performs in sequence the following tasks:

- It sends a request to the drive to clear any drive faults that exists
- Then it resets the axis errors

NOTE
The condition causing the axis error has to be corrected before calling this function. The axis error still remains until the error condition exists when this function is called.

See also transition 15 in the status machine of the CANopen protocol.

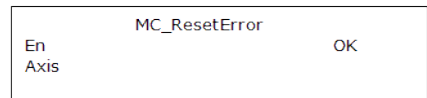

Figure 1-66: MC_ResetError

NOTE
This function or function block returns cached data. See [Programming a Dual Core Controller](#) for more information.

2.2.1.8.2 Arguments

2.2.1.8.2.1 Input

En	Description	Requests to reset the axis errors
	Data type	BOOL
	Range	0, 1
	Unit	N/A
	Default	—

Axis	Description	Name of a declared instance of the AXIS_REF library function)
	Data type	AXIS_REF
	Range	[1,256]
	Unit	N/A
	Default	—

2.2.1.8.2.2 Output

OK	Description	Indicates the function has completed successfully
	Data type	BOOL

2.2.1.8.3 Example

2.2.1.8.3.1 Structured Text

```

//reset the axis and drive errors for Axis 1

MC_ResetError( Axis1 );
    
```

2.2.1.8.3.2 Ladder Diagram

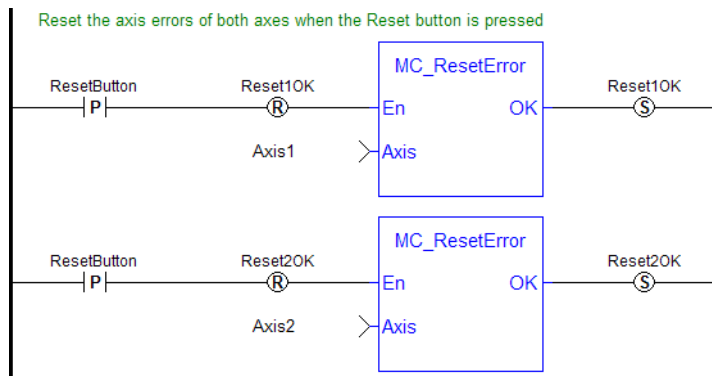

2.2.1.9 MC_Stop PLCopen ✔

2.2.1.9.1 Description

This function block aborts the active move, removes the next move from the queue, performs a controlled stop at the specified deceleration rate, and switches the axis to Stopping state.

MC_Stop cannot be aborted. This means that, while in Stopping state, no function block can command any motion on the axis. The axis remains in Stopping state until it reaches zero velocity and the Execute input is low. The application program can hold the axis in Stopping state even after it reaches zero velocity by leaving the Execute input high.

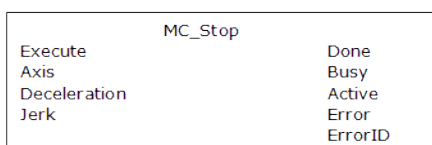

Figure 1-67: MC_Stop

2.2.1.9.2 Time Diagram

The example below shows the behavior of the combination of a MC_Stop FB with a [MC_MoveVelocity](#) FB.

- A rotating axis is ramped down with FB2 MC_Stop
- The axis rejects motion commands as long as MC_Stop parameter “Execute” = TRUE

FB1 MC_MoveVelocity reports an error indicating the busy MC_Stop command.

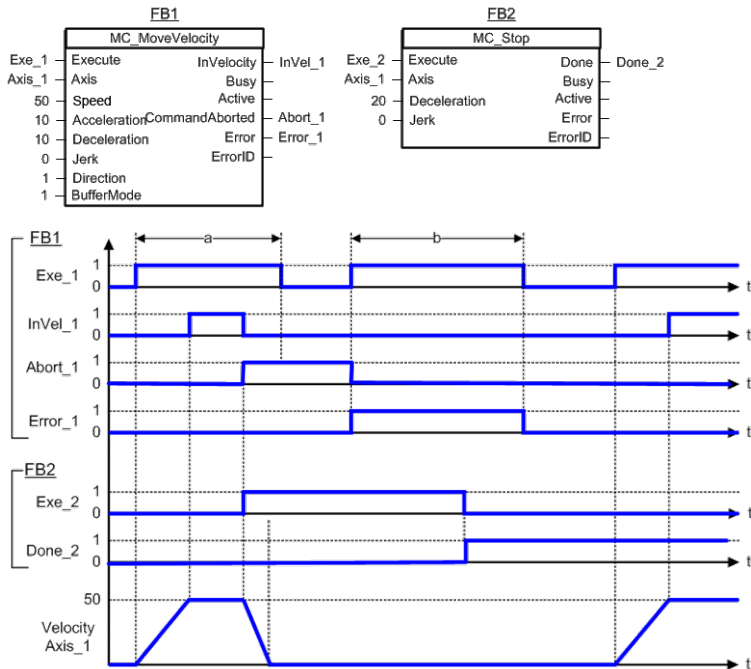

NOTE

This function block starts a motion-related action and therefore stores data for calculations and error checking. Please see [Calling Function Blocks Multiple Times in the Same Cycle](#) if you are using a dual-core controller.

2.2.1.9.3 Arguments

2.2.1.9.3.1 Input

Execute	Description	Requests to stop the axis. It can be held high to prevent any other moves from being queued
	Data type	BOOL
	Range	0, 1
	Unit	N/A
	Default	—
Axis	Description	Name of a declared instance of the AXIS_REF library function.
	Data type	AXIS_REF
	Range	[1,256]

	Unit	N/A
	Default	—
Deceleration	Description	Trapezoidal: Deceleration rate S-curve: Maximum deceleration
	Data type	LREAL
	Range	—
	Unit	User unit/sec ²
	Default	—
Jerk	Description	Trapezoidal: 0 S-curve: Constant jerk
	Data type	LREAL
	Range	—
	Unit	User unit/sec ³
	Default	—

2.2.1.9.3.2 Output

Done	Description	Indicates the axis has reached zero velocity AND the Execute input is low
	Data type	BOOL
Busy	Description	High from the time the Execute input goes high until the axis reaches zero velocity AND the Execute input is low
	Data type	BOOL
Active	Description	High from the time the MC_Stop move becomes the active move, until the axis reaches zero velocity AND the Execute input is low
	Data type	BOOL
Error	Description	Indicates an invalid input was specified
	Data type	BOOL
ErrorID	Description	Indicates the error if Error output is set to TRUE
	Data type	INT

2.2.1.9.4 Example

2.2.1.9.4.1 Structured Text

```
(* MC_Stop S
T example *)

Inst_MC_Stop( StopRequest , Axis1, 100.0, 100.0 ); //Inst_MC_Stop is an
instance of MC_Stop function block
```

```

StopComplete := Inst_MC_Stop.Done;      //store the Done output into a
user defined variable

StopActive := Inst_MC_Stop.Active;      //store the Active output into a
user defined variable

StopError := Inst_MC_Stop.Error;        //store the Error output into a
user defined variable
    
```

2.2.1.9.4.2 Ladder Diagram

Put Axis 1 into Stopping Mode

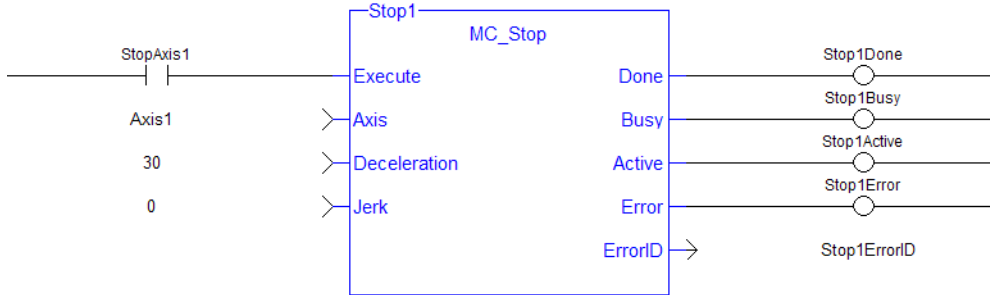

2.2.2 I/O Functions

This set of functions provides I/O control over TouchProbe functions.

2.2.2.1 MC_AbortTrigger PLCopen ✔

2.2.2.1.1 Description

When the Execute input transitions from low to high, this function block aborts an MC_TouchProbe function block.

NOTE

This function block starts a motion-related action and therefore stores data for calculations and error checking. Please see [Calling Function Blocks Multiple Times in the Same Cycle](#) if you are using a dual-core controller.

2.2.2.1.2 Arguments

2.2.2.1.2.1 Input

Execute	Description	Enables execution
	Data type	BOOL
	Range	0, 1
	Unit	N/A
Axis	Description	Specifies the axis that was specified in the MC_TouchProbe function block which is to be aborted
	Data type	AXIS_REF
	Range	[1,256]

	Unit	N/A
	Default	—
TriggerInput	Description	<p>Specifies the Fast Input that was specified in the MC_TouchProbe function block which is to be aborted. The elements of TriggerInput are as follows:</p> <p>InputID INT; 0 = Touch Probe 1 / Capture Engine 0 1 = Touch Probe 2 / Capture Engine 1 Range is [0,1]</p> <p>Direction INT; 1 = rising edge, 2 = falling edge Range is [1,2]</p> <p>TrigID INT; is the axis number of the input. 0 indicates that the trigger axis is to be the same as Axis.AXIS_NUM. Range is [0,256]</p> <p>NOTE</p> <p>TrigMode INT (TriggerInput.TrigMode) is not presently supported by this function. The TriggerInput.Mode may be supported in a future software version.</p>
	Data type	TRIGGER_REF
	Range	See Description above
	Unit	N/A
	Default	—

2.2.2.1.2.2 Output

Done	Description	Function block has completed
	Data type	BOOL
Busy	Description	Indicates the function block is currently executing
	Data type	BOOL
Error	Description	Indicates the function block did not complete due to an error. The ErrorID output indicates the type of error when this output is high
	Data type	BOOL
ErrorID	Description	When the Error output is high, this output indicates the type of error. When the Error output is low, this output is undefined
	Data type	INT

2.2.2.1.3 Usage

This function block is used to abort an MC_TouchProbe function block.

2.2.2.1.4 Related Functions

[MC_TouchProbe](#)

2.2.2.1.5 Example

2.2.2.1.5.1 Structured Text

```
(* MC_AbortTrigger ST example *)
Inst_MC_AbortTrigger( AbortReq, Axis1, TriggerInputRef );
//Inst_MC_AbortTrigger is an instance of MC_AbortTrigger
```

2.2.2.1.5.2 Ladder Diagram

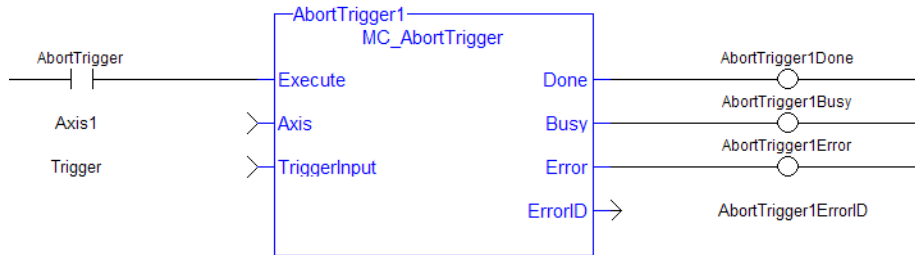

2.2.2.2 MC_TouchProbe PLCopen

2.2.2.2.1 Description

This function block arms a Fast Input and returns the latched position when the Fast Input event occurs. This function block causes no motion.

When the Execute input transitions from low to high, the control requests the drive to arm its Fast Input to latch the axis position when a Fast Input occurs. The Axis input specifies which axis's position to latch and the TriggerInput input specifies which Fast Input to use and whether to trigger on the rising or falling edge of the Fast Input. When the Fast Input event occurs, the drive latches the axis's position. This function block then returns the latched position at the RecordedPosition output and set the Done output high. This process can be canceled with the AbortTrigger function block.

If the WindowOnly input is high, the FirstPosition input and the LastPosition input define a window in which a Fast Input is accepted. Any Fast Input events that occur outside the window is ignored.

If First Position \leq LastPosition, the window in which a Fast Input is accepted is:

$$\text{FastInputPosition} \geq \text{FirstPosition} \text{ AND } \text{FastInputPosition} \leq \text{LastPosition}.$$

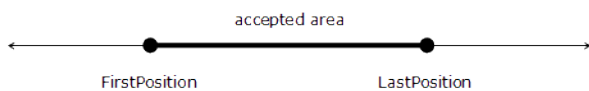

If First Position $>$ LastPosition, the window in which a Fast Input is accepted is:

$$\text{FastInputPosition} \geq \text{FirstPosition} \text{ OR } \text{FastInputPosition} \leq \text{LastPosition}.$$



The following figure shows the ladder diagram view of the MC_TouchProbe function block:

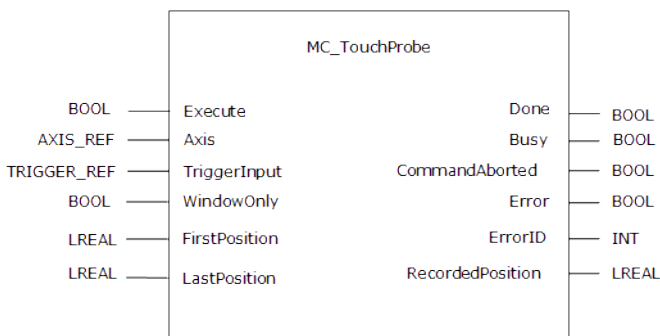

Figure 1-68: MC_TouchProbe

TIP

The accuracy of captured position data depends on the travel velocity. Please see the article [MC_TouchProbe and Time-Based Capture on KDN](#) for more information and how to correct for timing.

NOTE

This function block starts a motion-related action and therefore stores data for calculations and error checking. Please see [Calling Function Blocks Multiple Times in the Same Cycle](#) if you are using a dual-core controller.

IMPORTANT

There are some differences in how MC_TouchProbe interacts with AKD and AKD2G drives. Please refer to the following topics for some drive-specific information.

- [AKD Support With MC_TouchProbe](#)
- [AKD2G Support With MC_TouchProbe](#)

2.2.2.2 Arguments

2.2.2.2.1 Input

Execute	Description	Enables execution
	Data type	BOOL
	Range	0, 1
	Unit	N/A
	Default	—
Axis	Description	Selects the axis for which the position is latched
	Data type	AXIS_REF
	Range	[1,256]
	Unit	N/A
	Default	—
TriggerInput	Description	Sets up the mechanism on the controller for the capture input signal.

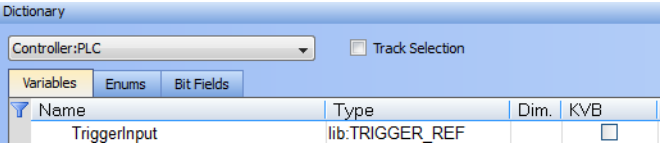
Data type	<p>TRIGGER_REF - an instance of the TRIGGER_REF reference function must first be setup in the Project Dictionary, as seen here.</p>  <p>The screenshot shows a 'Dictionary' window with 'Controller:PLC' selected. The 'Variables' tab is active, displaying a table with columns: Name, Type, Dim., and KVB. The entry 'TriggerInput' is listed with Type 'lib:TRIGGER_REF' and a checkbox in the KVB column.</p>
Elements	<p><u>Capture Engine (drive capture engine to be used)</u> INT TriggerInput.InputID 0 = Touch Probe 1 / Capture Engine 0 1 = Touch Probe 2 / Capture Engine 1 Range is [0,1]</p> <p><u>Trigger Direction (input signal's edge to capture)</u> INT TriggerInput.Direction 1 = rising edge 2 = falling edge Range is [1,2]</p> <p>TIP Trigger Direction is also sent to the servo drive and is shown in the WorkBench Position Capture screen Edge setup.</p> <p><u>Axis Number (where input comes from)</u> INT TriggerInput.TrigID 0 = trigger axis is to be the same as Axis.AXIS_NUM. Range is [0,256]</p> <p><u>Trigger Mode (capture method)</u> INT TriggerInput.TrigMode 0 = time based capture 1 = position based capture. For position based capture the TrigID must be the same as the Axis_Ref. Range is [0,1]</p> <p>NOTE The Mode (either Position or Time) must be configured the same in the servo drive. This can be done either:</p> <ul style="list-style-type: none"> • in COE Init commands and executed when the EtherCAT network is initialized (0x3460, subindex 3 and 4) • in the WorkBench Position Capture screen (see image above).
Unit	N/A
Default	—
WindowOnly Description	<p>Enables a position latching window. When this input is set, a window is defined by the FirstPosition and LastPosition inputs. Any Fast Input event that occurs outside the window is ignored. The first Fast Input event that occurs within the window latches the axis position</p>
Data type	BOOL
Range	—
Unit	N/A

	Default	—
FirstPosition	Description	See the function block Description above for an explanation of how this input and the LastPosition input define the window. This input is only applicable when the WindowOnly input is high. If the WindowOnly input is low, this input is ignored
	Data type	LREAL
	Range	—
	Unit	User unit
	Default	—
LastPosition	Description	See the function block Description above for an explanation of how this input and the FirstPosition input define the window. This input is only applicable when the WindowOnly input is high. If the WindowOnly input is low, this input is ignored
	Data type	LREAL
	Range	—
	Unit	User unit
	Default	—

2.2.2.2.2.2 Output

Done	Description	Function block has completed and the RecordedPosition output is valid
	Data type	BOOL
Busy	Description	Indicates that the specified input is arming or is armed, and waiting for the trigger and recording of the position to occur
	Data type	BOOL
CommandAborted	Description	A TriggerAbort function block has executed and canceled this function
	Data type	BOOL
Error	Description	The function block has not completed successfully due to an error. The ErrorID output indicates the type of error
	Data type	BOOL
ErrorID	Description	When the Error output is high, this output indicates the type of error. When the Error output is low, this output is undefined
	Data type	INT
RecordedPosition	Description	When the Done output goes high, this output returns the latched position. When the Done output is low, this output is undefined

Data type	LREAL
Unit	User unit

2.2.2.2.3 Usage

This function block can be used to:

- Perform registration
- Determine the position of a product
- Measure product length

2.2.2.2.4 Limitations

- Both high speed inputs cannot be used at the same time.
- The TrigMode option is only used by MC_TouchProbe.

2.2.2.2.5 Related Functions

[MC_AbortTrigger](#)

2.2.2.2.6 See Also

- [Fast Inputs with Pipe Network Motion](#)
- [Fast Homing Example with the Pipe Network Motion Engine Axis Pipe Block](#)
- [Fast Homing Example with the PLCopen Motion Engine](#)
- [Pipe Network Registration and Fast Homing](#)
- [Registration Position Capture Example with Pipe Network Trigger Block](#)

2.2.2.2.7 Example

2.2.2.2.7.1 Structured Text

```
(* MC_TouchProbe ST example *)
TriggerInputRef.InputID := 1; //configure InputID
TriggerInputRef.Direction := 1; //configure Direction
TriggerInputRef.TrigID := 0; //configure TrigID
TriggerInputRef.TrigMode := 0; //Capture trigger based on
distributed clock time
Inst_MC_TouchProbe( ArmProbe, Axis1, TriggerInputRef, FALSE,0.0, 0.0 );
//Inst_MC_TouchProbe is an instance of MC_TouchProbe function block
ProbeIsDone := Inst_MC_TouchProbe.Done; //store Done output
into a user defined variable
ProbeValue := Inst_MC_TouchProbe.RecordedPosition; //store
RecordedPosition output into a user defined variable
```

2.2.2.2.7.2 Ladder Diagram

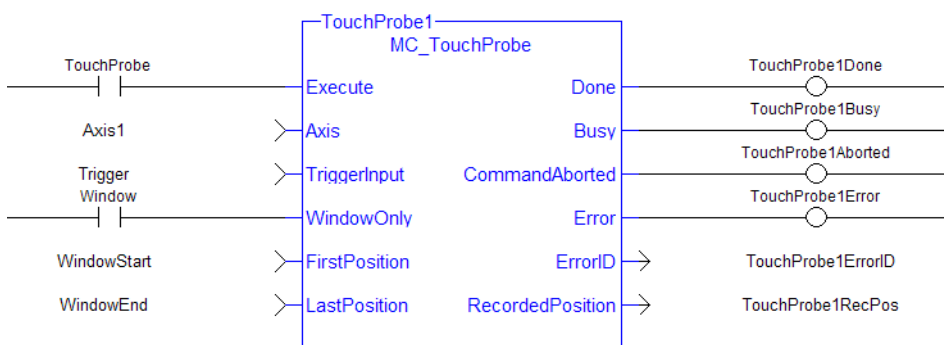

2.2.2.2.8 AKD Support With MC_TouchProbe

Following are several tips related to using MC_TouchProbe with AKD drives.

TIP

To use Capture Engine 1 modify the input PDOs that are used and add the Latch Position 1 parameter.

TIP

When using position-based capture, the proper Capture Mode and FB Source may need to be set up in the drive. One place to do that is in the Position Capture Screen in the KAS IDE embedded WorkBench:

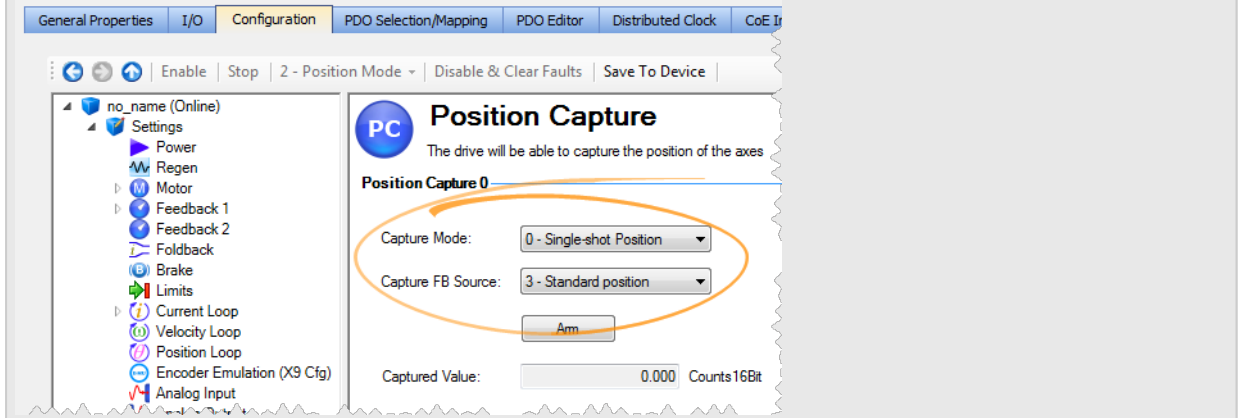

TIP

When setting up Position Capture, check the CoE-Init Command settings shown below. This is to verify they do not overwrite the corresponding drive parameters with unwanted values when the EtherCAT network initializes.

Index	Subindex	Value	Comment	Direction	Source
0x6060	0	7	Opmode	Write	ESI File
0x60C2	1	1	Cycle time	Write	ESI File
0x60C2	2	-3	Cycle exp	Write	ESI File
0x3460	1	0	Latching engine 0 config to F10, CAP0.TRIGGER=0, 0x3460-1:=0 (1 byte)	Write	ESI File
0x3460	2	1	Latching engine 1 config to F11, CAP1.TRIGGER=1, 0x3460-2:=1 (1 byte)	Write	ESI File
0x60FE	2	196608	Digital Outputs Mask, 0x60fe:=0x30000 (4 bytes)	Write	ESI File
0x36E6	0	1	Set FBUS.PARAM02 to activate synchronization with the interrupt	Write	ESI File
0x36E8	0	1	Set FBUS.PARAM04 to disabled the drive on a motion error	Write	ESI File
0x3506	0	1	Set DRV.HWENMODE to disabled the rising edge of the hardware enable from clearing the drive faults	Write	ESI File
0x35CA	0	1048576	Set UNIT.PIN to set gear IN to the correct unit conversion.	Write	ESI File
0x365F	0	0	Set UNIT.VROTARY to set the velocity units to RPM.	Write	ESI File
0x3460	3	2	Capture mode to distributed clock time (DCT), CAP0.MODE=2, 0x3460-3:=0 (1 byte)	Write	ESI File
0x3460	4	2	Capture mode to distributed clock time (DCT), CAP1.MODE=2, 0x3460-4:=0 (1 byte)	Write	ESI File
0x50E2	0	1000	Set ILKBUSFF (1.0 = 1000) UINT32	Write	ESI File
0x3498	0	1	Set FBUS.PROTECTION (available only since FW 01-07-03-000)	Write	ESI File

2.2.2.2.9 AKD2G Support With MC_TouchProbe

Following are several tips related to using MC_TouchProbe with AKD2G drives.

NOTE

Currently, AKD2G only supports position capture.

- AKD2G does not use CAP1 or CAP2 to provide the EtherCAT touch probes. AKD2G supports ETG6010 and DS402 for Touch Probe objects

Two touch probes per axis are supported over EtherCAT with their own dedicated hardware in the drive. Each touch probe can capture two positions, the position on the rising and the position of the falling edge of the trigger input.

Following are the standards-compliant ETG6010 and DS402, EtherCAT / CANopen objects AKD2G supports.

Axis 1 Index	Axis 2 Index	Name	Note
60B8h	68B8h	Touch probe function / control	
60B9h	68B9h	Touch probe status	
60BAh	68BAh	Touch probe position 1 positive value	AXIS#.PL.FB, Scaling same as axis
60BBh	68BBh	Touch probe position 1 negative value	
60BCh	68BCh	Touch probe position 2 positive value	
60BDh	68BDh	Touch probe position 2 negative value	
60D0h	68D0h	Touch probe source	

- The KAS IDE prepopulates the following PDOs with the required Touch probe objects by default.
 - Rx PDO 0x1602 with the required Touch Probe control objects
 - Tx PDO 0x1A02 with the required Touch Probe status and position value objects.

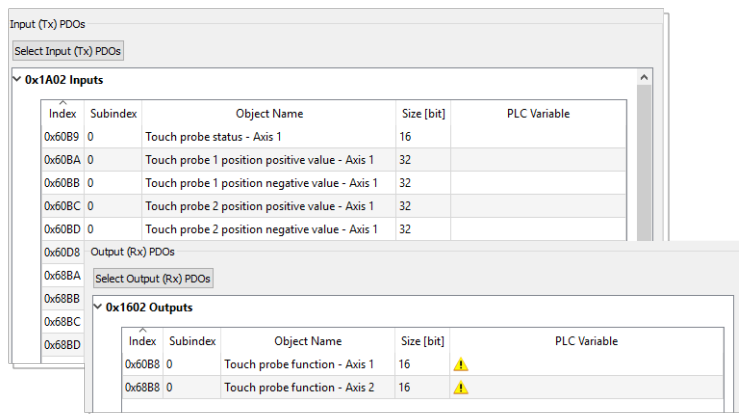

- The Trigger input source can be set by sending a SDO command.
 - Axis1:
 - 0x60D0 sub Index 1 for Touch Probe 1 Source
 - 0x60D0 sub Index 2 for Touch Probe 2 Source
 - Axis2:
 - 0x68D0 sub Index 1 for Touch Probe 1 Source
 - 0x68D0 sub Index 2 for Touch Probe 2 Source
- 6#D0h, Touch Probe Source. The following table shows how AKD2G signals are mapped to the touch probe source entry in the object dictionary. Note that a few sources appear in both the standard and the manufacture ranges to provide some consistency.

DS402 & ETG6010 Values	Text from Standard	AKD2G Values for 6#D0h	Equivalent CAP#.TRIGGER	AKD2G Note
-32768 to -1	Manufacturer specific	-41 to -42	41 to 42	Z pulse for Axis 1 to 2
		-31 to -35	31 to 35	Z pulse for Feedback 1 to 5 As FB1, 2, 4, and 5 do not support Z pulses then these will not be shown. When we support SFA on FB 1 and 2 then Z pulse may be possible. X23 is optional so if not fitted then -33 will not be valid.
		-21 to -26	21 to 26	DIO1 to DIO6 When X22 is not fitted options -21 and -22 will not be valid. When X23 is not fitted options -23 to -26 will not be valid.
		-1 to -12	1 to 12	DIN1 to DIN12 When X22 is not fitted options -9 to -12 will not be valid.
0	Reserved			Not valid
1	Digital Input 1 (Touch Probe input)	1	1	DIN1. Fast Opto
2	Digital Input 2 (Touch Probe input)	2	2	DIN2. Fast Opto
3	Digital Input 3 (Touch Probe input)			Not valid
4	Digital Input 4 (Touch Probe input)			Not valid
5	Hardware zero pulse signal of position encoder	5	41 for Axis 1 42 for Axis 2	Valid if PL.FBSOURCE is using a feedback that supports a Z pulse.
6	Software zero pulse encoder			Not valid
7 to 32767	Reserved			Not valid

2.2.3 Information Functions

This set of functions provides feedback and allows you to writer parameters.

2.2.3.1 MC_ReadActPos

2.2.3.1.1 Description

The MC_ReadActPos function block reads the actual position of the axis.

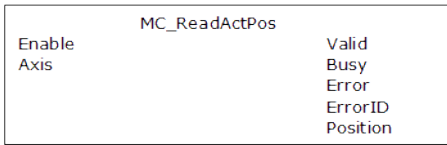

Figure 1-69: MC_ReadActPos

NOTE

This function or function block returns cached data. See [Programming a Dual Core Controller](#) for more information.

2.2.3.1.2 Arguments

2.2.3.1.2.1 Input

Enable	Description	Request to read the axis's actual position Keeps continuously to read the actual position every PLC cycle, as long as the Enable remains high
	Data type	BOOL
	Range	0, 1
	Unit	N/A
	Default	—
Axis	Description	Name of a declared instance of the AXIS_REF library function.)
	Data type	AXIS_REF
	Range	[1,256]
	Unit	N/A
	Default	—

2.2.3.1.2.2 Output

Valid	Description	Indicates the value at the Position output is available
	Data type	BOOL
Busy	Description	Indicates this function block is executing
	Data type	BOOL
Error	Description	Indicates an invalid input
	Data type	BOOL
ErrorID	Description	Indicates the error if Error output is set to TRUE.
	Data type	INT
Position	Description	Actual position of the axis.
	Unit	User unit
	Data type	LREAL

2.2.3.1.3 Example

2.2.3.1.3.1 Structured Text

```

(* MC_ReadActPos S
   T example *)
Inst_MC_ReadActPos( TRUE, Axis1 );
//Inst_MC_ReadActPos is an instance of MC_ReadActPos function block

ActualPos := Inst_MC_ReadActPos.Position;
//store Position output into a user defined variable
    
```

2.2.3.1.3.2 Ladder Diagram

Get the Axis 1 actual position for the Control Panel to display

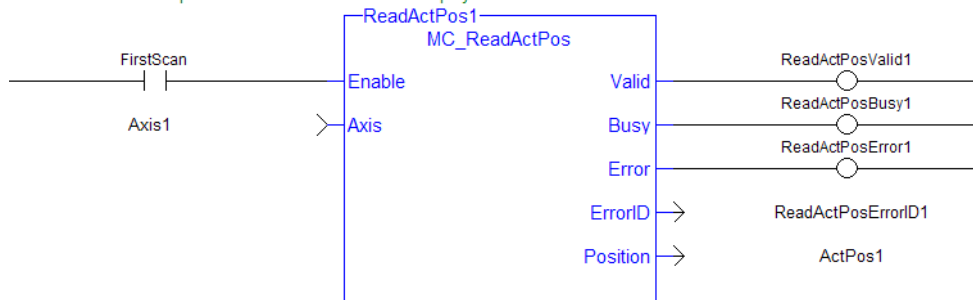

2.2.3.2 MC_ReadActVel PLCopen

2.2.3.2.1 Description

The MC_ReadActVel function block reads the actual velocity of the axis.

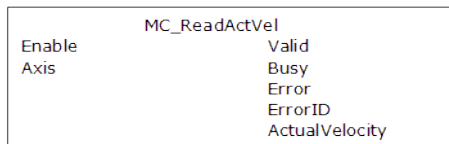

Figure 1-70: MC_ReadActVel

NOTE
 This function or function block returns cached data. See [Programming a Dual Core Controller](#) for more information.

2.2.3.2.2 Arguments

2.2.3.2.2.1 Input

Enable	Description	Requests to read the axis's actual velocity
	Data type	BOOL
	Range	0, 1
	Unit	N/A
	Default	—

Axis	Description	Name of a declared instance of the AXIS_REF library function.
	Data type	AXIS_REF
	Range	[1,256]
	Unit	N/A
	Default	—

2.2.3.2.2.2 Output

Valid	Description	Indicates the value at the ActualVelocity output is available
	Data type	BOOL
Busy	Description	Indicates this function block is executing
	Data type	BOOL
Error	Description	Indicates an invalid input
	Data type	BOOL
ErrorID	Description	Indicates the error if Error output is set to TRUE.
	Data type	INT
ActualVelocity	Description	Actual velocity of the axis. Please note that oscillations may be seen due to this being an instant velocity, not an average velocity.
	Unit	User unit/sec
	Data type	LREAL

2.2.3.2.3 Example

2.2.3.2.3.1 Structured Text

```

* MC_ReadActVel S
T example *);
Inst_MC_ReadActVel( TRUE, Axis1 ); //Inst_MC_ReadActVel is an instance of
MC_ReadActVel function block

ActualVel := Inst_MC_ReadActVel.ActualVelocity; // store ActualVelocity
output into a user defined variable

```

2.2.3.2.3.2 Ladder Diagram

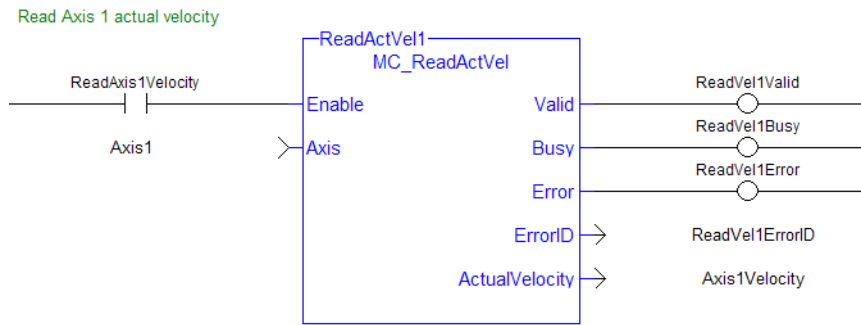

2.2.3.3 MC_ReadAxisErr PLCopen ✔

2.2.3.3.1 Description

The Function Block MC_ReadAxisErr returns the error status of the specified axis.

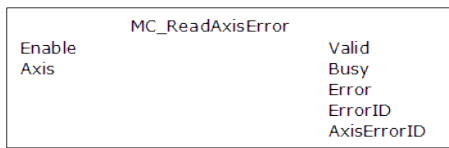

Figure 1-71: MC_ReadAxisErr

NOTE

This function or function block returns cached data. See [Programming a Dual Core Controller](#) for more information.

2.2.3.3.2 Arguments

2.2.3.3.2.1 Input

Enable	Description	requests to read the error status of the axis
	Data type	BOOL
	Range	0, 1
	Unit	N/A
	Default	—
Axis	Description	Name of a declared instance of the AXIS_REF library function.
	Data type	AXIS_REF
	Range	[1,256]
	Unit	N/A
	Default	—

2.2.3.3.2.2 Output

Valid	Description	Indicates the AxisErrorID output is valid
	Data type	BOOL

Busy	Description	Indicates this function block is executing
	Data type	BOOL
Error	Description	Indicates an invalid input
	Data type	BOOL
ErrorID	Description	Indicates the error if Error output is set to TRUE
	Data type	INT
AxisErrorID	Description	Indicates the error status of the axis. Each bit indicates a specific error. Both emergency-stop (E-stop) and controlled-stop (C-stop) errors are indicated. The table below defines the bits of this output.
	Data type	INT

Hexadecimal	Decimal	Description
0000H	0	No Error
0001H	1	User-set E-stop via MC_EStop, E-stop
0002H	2	Loss of Feedback, E-stop
0004H	4	Drive Fault, E-stop
0008H	8	Drive Communication Failure, E-stop
0400H	1024	Synchronization Error, C-stop
0700H	7192	Drive Overtravel Limit Exceeded, Cstop (see Overtravel Conditions)

NOTE

Multiple errors can be active at the same time. For example, if a User-set E-stop and an Excess Position Error E-stop are both active, the value would be 00000011H (17 decimal).

2.2.3.3.3 Example**2.2.3.3.3.1 Structured Text**

```
(* MC_ReadAxisErr ST example *)

Inst_MC_ReadAxisErr( TRUE, Axis1 );
//Inst_MC_ReadAxisErr is an instance of MC_ReadAxisErr function block
AxisErrorBits := Inst_MC_ReadAxisErr.AxisErrorID; //AxisErrorID contains
the error bits
```

2.2.3.3.3.2 Ladder Diagram

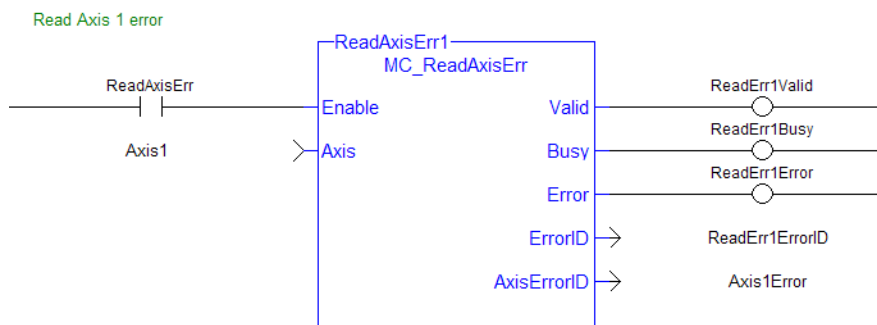

2.2.3.4 MC_ReadBoolPar PLCopen

2.2.3.4.1 Description

The MC_ReadBoolPar function block returns the value of the specified Boolean axis parameter.

MC_ReadBoolPar	
Enable	Valid
Axis	Busy
ParameterNumber	Error
	ErrorID
	Value

Figure 1-72: MC_ReadBoolPar

NOTE

This function or function block returns cached data. See [Programming a Dual Core Controller](#) for more information.

2.2.3.4.2 Arguments

2.2.3.4.2.1 Input

Enable	Description	Requests to read the Boolean axis parameter
	Data type	BOOL
	Range	0, 1
	Unit	N/A
	Default	—
Axis	Description	Name of a declared instance of the AXIS_REF library function.)
	Data type	AXIS_REF
	Range	[1,256]
	Unit	N/A
	Default	—
ParameterNumber	Description	Parameter number, see table in Axis Parameters
	Data type	INT
	Range	—
	Unit	N/A

Default	—
----------------	---

2.2.3.4.2.2 Output

Valid	Description	Indicates the Value output is valid
	Data type	BOOL
Busy	Description	Indicates this function block is executing
	Data type	BOOL
Error	Description	Indicates an invalid input
	Data type	BOOL
ErrorID	Description	Indicates the error if Error output is set to TRUE
	Data type	INT
Value	Description	State of the Boolean parameter
	Data type	BOOL

2.2.3.4.3 Example

2.2.3.4.3.1 Structured Text

```
(* MC_ReadBoolPar ST example *)
Inst_MC_ReadBoolPar( EnableRead, Axis1, MC_AXIS_PARAM_IN_POSITION );
Axis1InPosition := Inst_MC_ReadBoolPar.Value;
```

2.2.3.4.3.2 Ladder Diagram

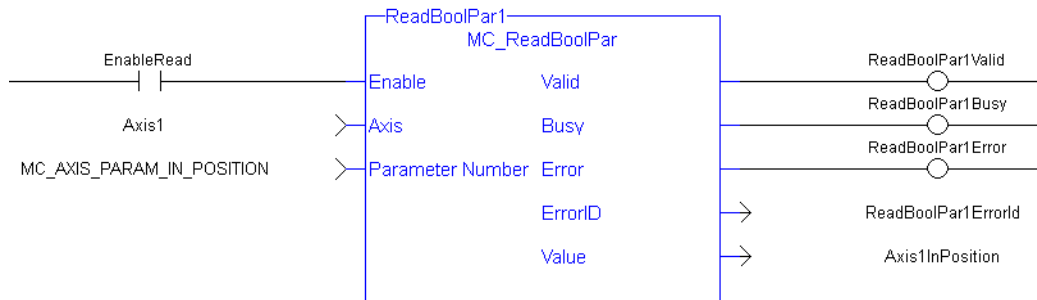

2.2.3.5 MC_ReadParam PLCopen ✔

2.2.3.5.1 Description

The MC_ReadParam function block returns the value of the specified axis parameter.

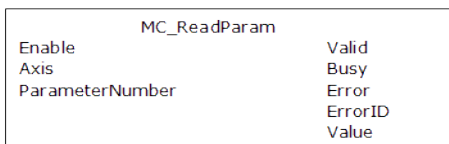

Figure 1-73: MC_ReadParam

NOTE

This function or function block returns cached data. See [Programming a Dual Core Controller](#) for more information.

2.2.3.5.2 Arguments**2.2.3.5.2.1 Input**

Enable	Description	Requests to read the axis parameter
	Data type	BOOL
	Range	0, 1
	Unit	N/A
	Default	—
Axis	Description	Name of a declared instance of the AXIS_REF library function.)
	Data type	AXIS_REF
	Range	[1,256]
	Unit	N/A
	Default	—
ParameterNumber	Description	Parameter number, see table in Axis Parameters
	Data type	INT
	Range	—
	Unit	N/A
	Default	—

2.2.3.5.2.2 Output

Valid	Description	Indicates the Value output is valid
	Data type	BOOL
Busy	Description	Indicates this function block is executing
	Data type	BOOL
Error	Description	Indicates an invalid input
	Data type	BOOL
ErrorID	Description	Indicates the error if Error output is set to TRUE
	Data type	INT
Value	Description	Value of the parameter
	Data type	LREAL

2.2.3.5.3 Example

2.2.3.5.3.1 Structured Text

```
(* MC_ReadParam ST example *)
Inst_MC_ReadParam( EnableRead, Axis1, MC_AXIS_PARAM_CMD_VEL );
Axis1_CmdVel := Inst_MC_ReadParam.Value;
```

2.2.3.5.3.2 Ladder Diagram

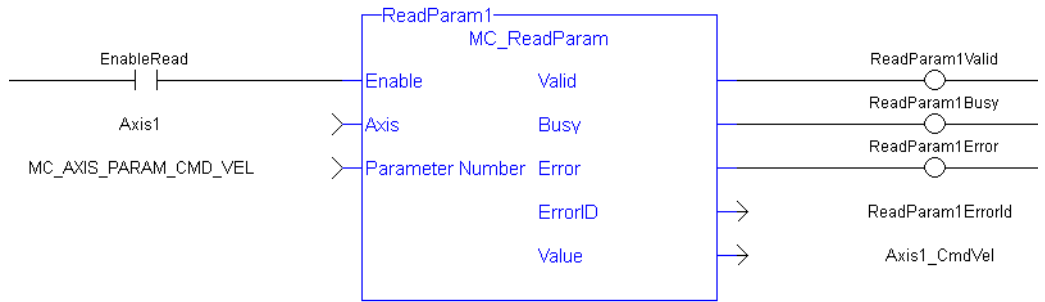

2.2.3.6 MC_ReadStatus PLCopen ✔

2.2.3.6.1 Description

The function block MC_ReadStatus returns the state of the specified axis.

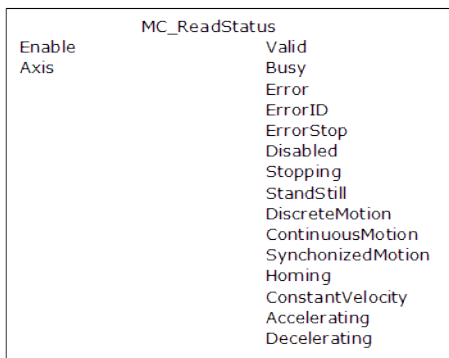

Figure 1-74: MC_ReadStatus

NOTE
This function or function block returns cached data. See [Programming a Dual Core Controller](#) for more information.

2.2.3.6.2 Arguments

2.2.3.6.2.1 Input

Enable	Description	Requests to read and return the axis status
	Data type	BOOL
	Range	0, 1
	Unit	N/A
	Default	—
Axis	Description	Name of a declared instance of the AXIS_REF library function. click here...

Data type	AXIS_REF
Range	[1,256]
Unit	N/A
Default	—

2.2.3.6.2.2 Output

Valid	Description	Indicates the outputs are valid
	Data type	BOOL
Busy	Description	Indicates this function block is executing
	Data type	BOOL
Error	Description	Indicates an invalid input
	Data type	BOOL
ErrorID	Description	Indicates the error if Error output is set to TRUE
	Data type	INT
ErrorStop	Description	Indicates Error Stop state – E-stop or C-stop
	Data type	BOOL
Disabled	Description	Indicates Disabled state – open loop and drive is disabled
	Data type	BOOL
Stopping	Description	Indicates Stopping state – MC_Stop command
	Data type	BOOL
StandStill	Description	Indicates Stand Still state – no move, closed loop, drive enabled
	Data type	BOOL
DiscreteMotion	Description	Indicates Discrete Motion state – programmed endpoint move is active
	Data type	BOOL
ContinuousMotion	Description	Indicates Continuous Motion state – unending, single-axis move is active
	Data type	BOOL
SynchronizedMotion	Description	Indicates Synchronized Motion state – slave move is active
	Data type	BOOL
Homing	Description	Indicates Homing state – a homing cycle is currently executing
	Data type	BOOL
ConstantVelocity	Description	Indicates the axis is moving at a constant velocity

	Data type	BOOL
Accelerating	Description	Indicates the axis is accelerating
	Data type	BOOL
Decelerating	Description	Indicates the axis is decelerating
	Data type	BOOL

2.2.3.6.3 Example

2.2.3.6.3.1 Structured Text

```
(* MC_ReadStatus ST example *)

Inst_MC_ReadStatus( EnableRead, Axis1 );
//Inst_MC_ReadStatus is an instance of MC_ReadStatus function block
AxisStopping := Inst_MC_ReadStatus.Stopping; // store Stopping output to
a user defined variable
AxisAccelerating := Inst_MC_ReadStatus.Accelerating; // store
Accelerating output to a user defined variable
```

2.2.3.6.3.2 Ladder Diagram

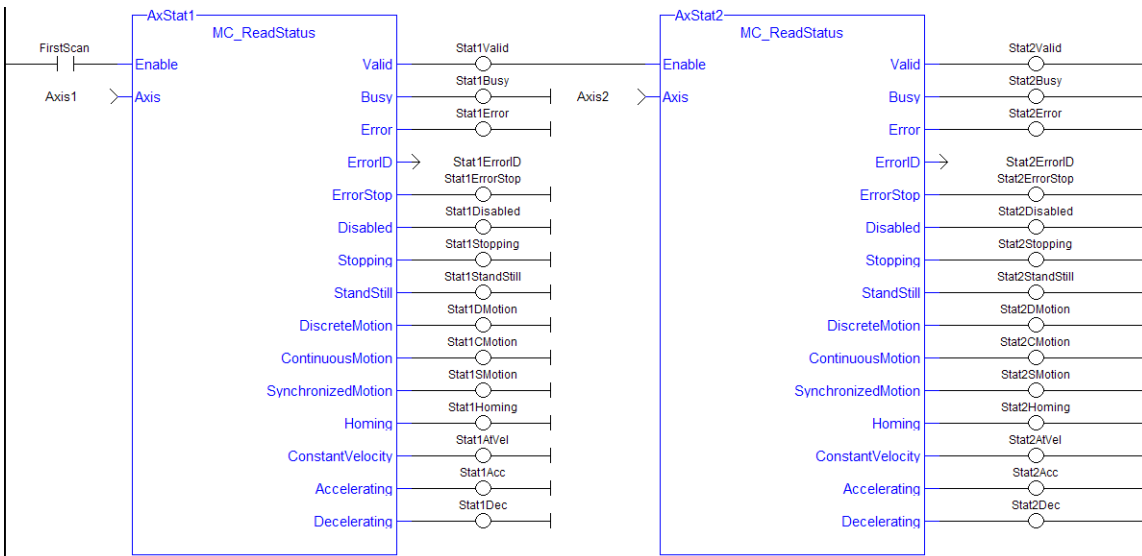

2.2.3.7 MC_WriteBoolPar PLCopen

2.2.3.7.1 Description

The MC_WriteBoolPar function block writes the specified axis Boolean parameter.

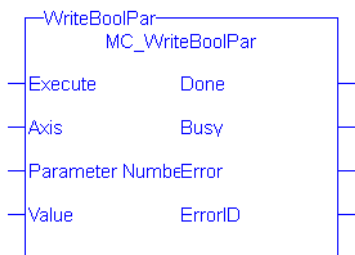

The MC_WriteBoolPar function block

2.2.3.7.2 Arguments

2.2.3.7.2.1 Input

Execute	Description	Requests to write a Boolean axis parameter
	Data type	BOOL
	Range	0, 1
	Unit	N/A
	Default	—
Axis	Description	Name of a declared instance of the AXIS_REF library function.
	Data type	AXIS_REF
	Range	[1,256]
	Unit	N/A
	Default	—
ParameterNumber	Description	Parameter number, see table in Axis Parameters
	Data type	INT
	Range	—
	Unit	N/A
	Default	—
Value	Description	State to write
	Data type	BOOL
	Range	0, 1
	Unit	N/A
	Default	—

2.2.3.7.2.2 Output

Done	Description	Indicates the Boolean parameter has been written
	Data type	BOOL
Busy	Description	Indicates this function block is executing
	Data type	BOOL
Error	Description	Indicates an invalid input
	Data type	BOOL
ErrorID	Description	Indicates the error if Error output is set to TRUE
	Data type	INT

2.2.3.7.3 Example

2.2.3.7.3.1 Structured Text

```
(* MC_WriteBoolPar ST example *)
WriteBool := FALSE;
Inst_MC_WriteBoolPar( WriteReq, Axis1, 1050, WriteBool );
```

2.2.3.7.3.2 Ladder Diagram

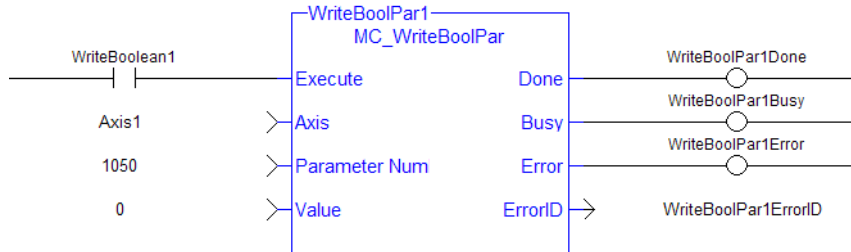

NOTE
Currently, MC_WriteBoolPar does not support any parameters (1050 is an arbitrary number chosen for example)

2.2.3.8 MC_WriteParam PLCopen

2.2.3.8.1 Description

The MC_WriteParam function block writes the specified axis parameter.

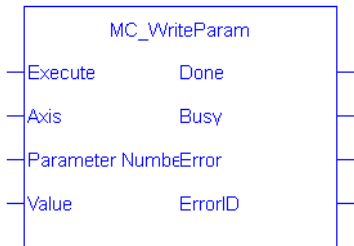

Figure 1-75: The MC_WriteParam function block

NOTE
This function or function block returns cached data. See [Programming a Dual Core Controller](#) for more information.

2.2.3.8.2 Arguments

2.2.3.8.2.1 Input

Execute	Description	Requests to write the axis parameter
	Data type	BOOL
	Range	0, 1
	Unit	N/A
	Default	—
Axis	Description	Name of a declared instance of the AXIS_REF library function.

	Data type	AXIS_REF
	Range	[1,256]
	Unit	N/A
	Default	—
ParameterNumber	Description	Parameter number, see table in Axis Parameters
	Data type	INT
	Range	—
	Unit	N/A
	Default	—
Value	Description	Value to write
	Data type	LREAL
	Range	—
	Unit	N/A
	Default	—

2.2.3.8.2.2 Output

Done	Description	Indicates the parameter has been written
	Data type	BOOL
Busy	Description	Indicates this function block is executing
	Data type	BOOL
Error	Description	Indicates an invalid input
	Data type	BOOL
ErrorID	Description	Indicates the error if Error output is set to TRUE
	Data type	INT

2.2.3.8.3 Example

2.2.3.8.3.1 Structured Text

```
(* MC_WriteParam ST example *)
MasterOffset := 12.34;
Inst_MC_WriteParam( EnableWrite, Axis1, MC_AXIS_PARAM_MASTER_OFFSET,
MasterOffset);
```

2.2.3.8.3.2 Ladder Diagram

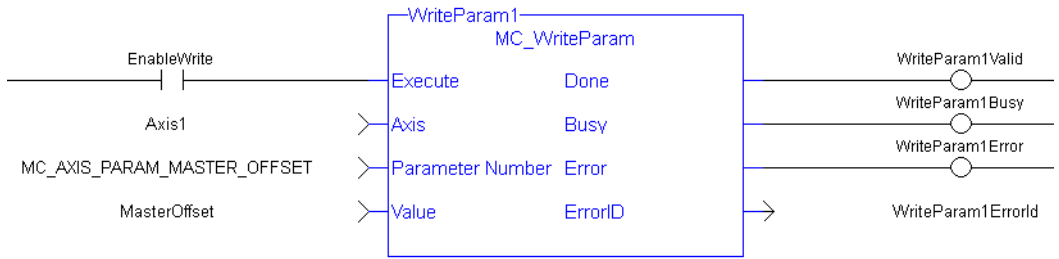

2.2.4 PLCOpenMotion Functions

This set of functions provides control over an axis.

2.2.4.1 MC_Halt PLCopen ✔

2.2.4.1.1 Description

This function block decelerates an axis to zero velocity. It is a queued single-axis move. The move is complete when the axis reaches zero velocity. It is typically used with Abort at the BufferMode input to terminate a move. To execute a stop that cannot be aborted, see [MC_Stop](#).

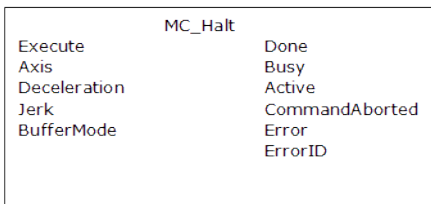

Figure 1-76: MC_Halt

2.2.4.1.2 Time Diagram

The example below shows the behavior in combination with a [MC_MoveVelocity](#).

- A rotating axis is ramped down with FB2 MC_Halt
- Another motion command overrides the MC_Halt command

MC_Halt allows this, in contrast to MC_Stop. The axis can accelerate again without reaching standstill.

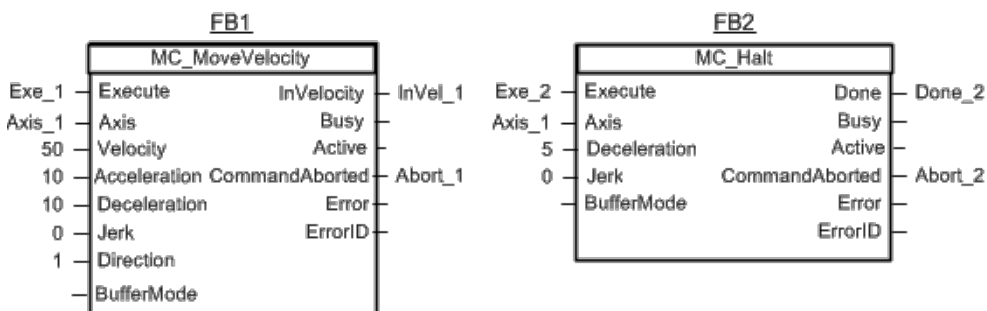

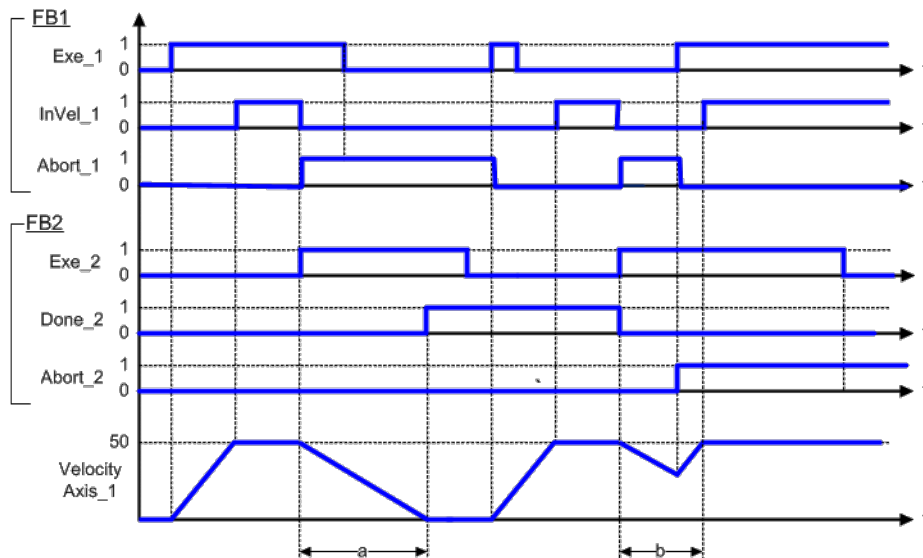

NOTE
 This function block starts a motion-related action and therefore stores data for calculations and error checking. Please see [Calling Function Blocks Multiple Times in the Same Cycle](#) if you are using a dual-core controller.

2.2.4.1.3 Arguments

2.2.4.1.3.1 Input

Execute	Description	Requests to queue the move
	Data type	BOOL
	Range	0, 1
	Unit	N/A
	Default	—
Axis	Description	Name of a declared instance of the AXIS_REF library function
	Data type	AXIS_REF
	Range	[1,256]
	Unit	N/A
	Default	—
Deceleration	Description	Trapezoidal: Deceleration rate S-curve: Maximum deceleration
	Data type	LREAL
	Range	—
	Unit	User unit/sec ²
	Default	—

Jerk	Description	Trapezoidal: 0 S-curve: Constant jerk
	Data type	LREAL
	Range	—
	Unit	User unit/sec ³
	Default	—
BufferMode	Description	0 = abort 1 = buffer 2 = blend to active 3 = blend to next 4 = blend to low velocity 5 = blend to high velocity
	Data type	SINT
	Range	[0,5]
	Unit	N/A
	Default	—

2.2.4.1.3.2 Output

Done	Description	Indicates the move completed successfully. The Command Position has reached the endpoint.
	Data type	BOOL
Busy	Description	High from the moment the Execute input is one-shot to the time the move is ended
	Data type	BOOL
Active	Description	Indicates this move is the active move
	Data type	BOOL
CommandAborted	Description	Indicates this move was aborted
	Data type	BOOL
Error	Description	Indicates an invalid input was specified or the move was terminated due to an error
	Data type	BOOL
ErrorID	Description	Indicates the error if Error output is set to TRUE
	Data type	INT

2.2.4.1.4 Example

2.2.4.1.4.1 Structured Text

```
(* MC_Halt ST example *)
Inst_MC_Halt( HaltReq, Axis1,100.0, 100.0, 0 );
//Inst_MC_Halt is an instance of MC_halt function block
HaltComplete := Inst_MC_Halt.Done; //store Done output into user
defined variable
```

2.2.4.1.4.2 Ladder Diagram

Stop both axes when the Run/Stop switch is set to Stop

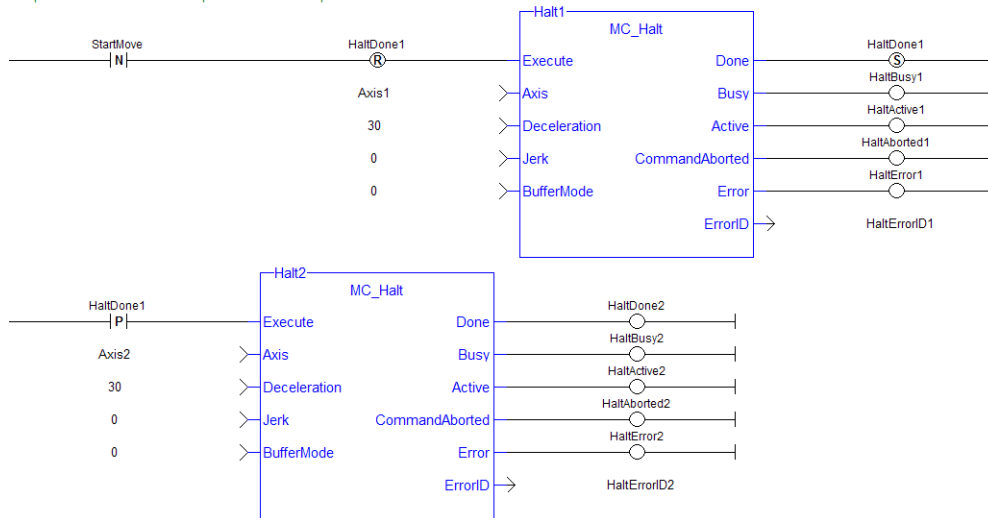

2.2.4.2 MC_MoveAbsolute PLCopen

2.2.4.2.1 Description

This function block performs a single-axis move to a specified endpoint position based on Axis, Position, Velocity, Acceleration, Deceleration, Jerk, and Direction parameters.

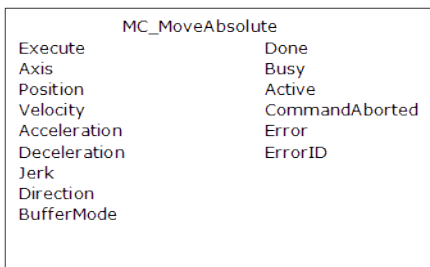

Figure 1-77: MC_MoveAbsolute

2.2.4.2.2 Time Diagram

The following figure shows two examples of the combination of two absolute move Function Blocks:

- The left part of timing diagram illustrates the case if the Second Function Block is called **after** the First one. If First reaches the commanded position of 6000 (and the velocity is 0)

- then the output Done causes the Second FB to move to the position 10000
- The right part of the timing diagram illustrates the case if the Second move Function Block starts the execution **while** the First FB is still executing. In this case the First motion is interrupted and aborted by the Test signal during the constant velocity of the First FB. The Second FB moves directly to the position 10000 although the position of 6000 is not yet reached

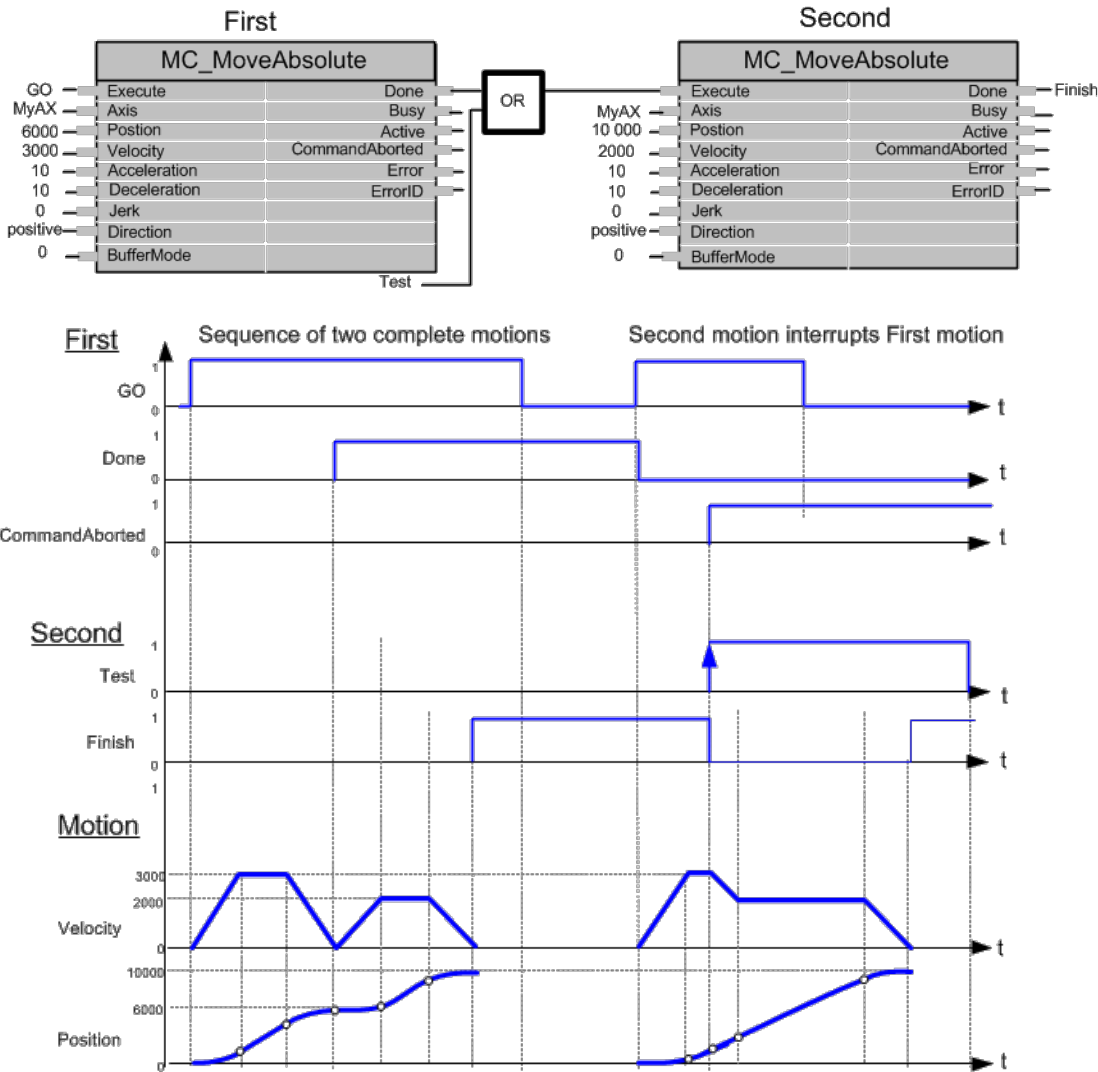

NOTE
 This function block starts a motion-related action and therefore stores data for calculations and error checking. Please see [Calling Function Blocks Multiple Times in the Same Cycle](#) if you are using a dual-core controller.

2.2.4.2.3 Arguments

2.2.4.2.3.1 Input

Execute	Description	Requests to queue the move
	Data type	BOOL
	Range	0, 1
	Unit	N/A

	Default	—
Axis	Description	Name of a declared instance of the AXIS_REF library function
	Data type	AXIS_REF
	Range	[1,256]
	Unit	N/A
	Default	—
Position	Description	Endpoint position. If Rollover Position is nonzero, this value must be in the range $0 \leq \text{Position} < \text{Rollover Position}$ When not in Rollover mode, the input accepts a 64-bit floating point value. When converted to feedback units, the range is [-251,251-1] feedback units.
	Data type	LREAL
	Range	[see Description]
	Unit	User unit
	Default	—
Velocity	Description	Velocity setpoint
	Data type	LREAL
	Range	—
	Unit	User unit/sec
	Default	—
Acceleration	Description	Trapezoidal: Acceleration rate S-curve: Maximum acceleration If Acceleration is not valid, ErrorID is set to 21 Selection of Acceleration and Jerk Parameters for Function Blocks
	Data type	LREAL
	Range	—
	Unit	User unit/sec ²
	Default	—
Deceleration	Description	Trapezoidal: Deceleration rate S-curve: Unused
	Data type	LREAL
	Range	—

	Unit	User unit/sec ²												
	Default	—												
Jerk	Description	<p>Trapezoidal: 0</p> <p>S-curve: Constant jerk</p> <p>If Jerk is not valid, ErrorID is set to 21</p> <p>Selection of Acceleration and Jerk Parameters for Function Blocks</p>												
	Data type	LREAL												
	Range	—												
	Unit	User unit/sec ³												
	Default	—												
Direction	Description	<p>When Rollover Position is zero, a value of 0 must be specified.</p> <p>When Rollover Position is nonzero, a value of 1, 2, 3, or 4 must be specified.</p> <table border="1" data-bbox="644 920 1377 1346"> <thead> <tr> <th>Value</th> <th>Description</th> </tr> </thead> <tbody> <tr> <td>0</td> <td>no direction specification</td> </tr> <tr> <td>1</td> <td>positive direction. The axis travels in the positive direction to the endpoint</td> </tr> <tr> <td>2</td> <td>shortest distance. The axis travels in the direction that provides the shortest distance to the endpoint</td> </tr> <tr> <td>3</td> <td>negative direction. The axis travels in the negative direction to the endpoint</td> </tr> <tr> <td>4</td> <td>last direction. The axis travels to the endpoint in the same direction as its previous move</td> </tr> </tbody> </table> <p>If the Position input is the same as the axis's current position, then:</p> <ul style="list-style-type: none"> when Direction = 2 (shortest distance), the axis does not move and the Done output goes high indicating that the move has been completed. when Direction = 1, 3, or 4, the axis travels in the specified direction, through one rollover cycle, and arrives back at the same position. 	Value	Description	0	no direction specification	1	positive direction. The axis travels in the positive direction to the endpoint	2	shortest distance. The axis travels in the direction that provides the shortest distance to the endpoint	3	negative direction. The axis travels in the negative direction to the endpoint	4	last direction. The axis travels to the endpoint in the same direction as its previous move
Value	Description													
0	no direction specification													
1	positive direction. The axis travels in the positive direction to the endpoint													
2	shortest distance. The axis travels in the direction that provides the shortest distance to the endpoint													
3	negative direction. The axis travels in the negative direction to the endpoint													
4	last direction. The axis travels to the endpoint in the same direction as its previous move													
	Data type	SINT												
	Range	[0,4]												
	Unit	N/A												
	Default	—												

BufferMode	Description	0 = abort 1 = buffer 2 = blend to active 3 = blend to next 4 = blend to low velocity 5 = blend to high velocity
	Data type	SINT
	Range	[0,5]
	Unit	N/A
	Default	—

2.2.4.2.3.2 Output

Done	Description	Indicates the move completed successfully. The Command Position has reached the endpoint.
	Data type	BOOL
Busy	Description	High from the moment the Execute input is one-shot to the time the move is ended
	Data type	BOOL
Active	Description	Indicates this move is the active move
	Data type	BOOL
CommandAborted	Description	Indicates the move was aborted
	Data type	BOOL
Error	Description	Indicates an invalid input was specified or the move was terminated due to an error
	Data type	BOOL
ErrorID	Description	Indicates the error if Error output is set to TRUE
	Data type	INT

2.2.4.2.4 Example

2.2.4.2.4.1 Structured Text

```

(* MC_MoveAbsolute S
T example *)
Inst_MC_MoveAbsolute( MovAbsReq, Axis1, 1234.567, 100.0, 100.0, 100.0, 0,
0, 0 ); //instance of MC_MoveAbsolute
MovAbsDone := Inst_MC_MoveAbsolute.Done; //store done output into user
defined variable
MovAbsBusy := Inst_MC_MoveAbsolute.Busy;
MovAbsActive := Inst_MC_MoveAbsolute.Active;
MovAbsAborted := Inst_MC_MoveAbsolute.CommandAborted;
MovAbsError := Inst_MC_MoveAbsolute.Error;
MovAbsErrID := Inst_MC_MoveAbsolute.ErrorID;

```

2.2.4.2.4.2 Ladder Diagram

Move Axis 1 to 1000

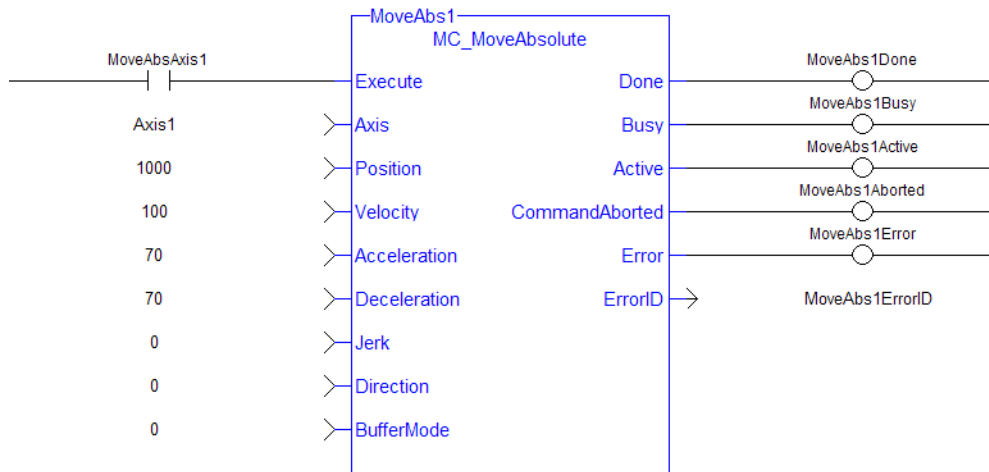

2.2.4.3 MC_MoveAdditive PLCopen

2.2.4.3.1 Description

This function block performs a single-axis move for a specified distance from the endpoint of the previous move. It is typically used with Abort specified at the BufferMode input. If BufferMode is not Abort, this move is identical to an MC_MoveRelative.

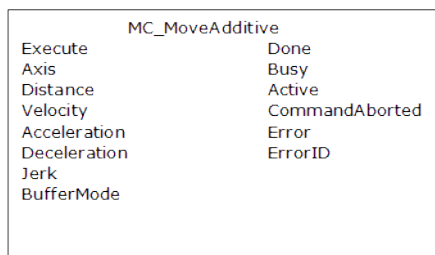
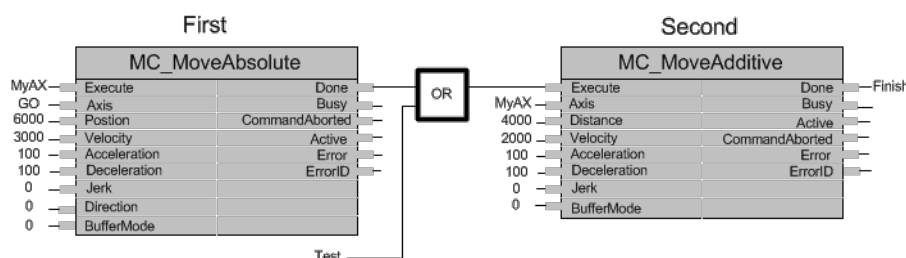

Figure 1-78: MC_MoveAdditive

2.2.4.3.2 Time Diagram

The following figure shows two examples of the combination of two Function Blocks while the axis is in Discrete Motion state:

- The left part of timing diagram illustrates the case if the Second Function Block is called **after** the First one. If First reaches the commanded distance 6000 (and the velocity is 0) then the output **Done** causes the Second FB to move to the distance 10000
- The right part of the timing diagram illustrates the case if the Second move Function Blocks starts the execution **while** the First FB is still executing. In this case the First motion is interrupted and aborted by the Test signal during the constant velocity of the First FB. The Second FB **adds on the previous commanded position** of 6000 the distance 4000 and moves the axis to the resulting position of 10000



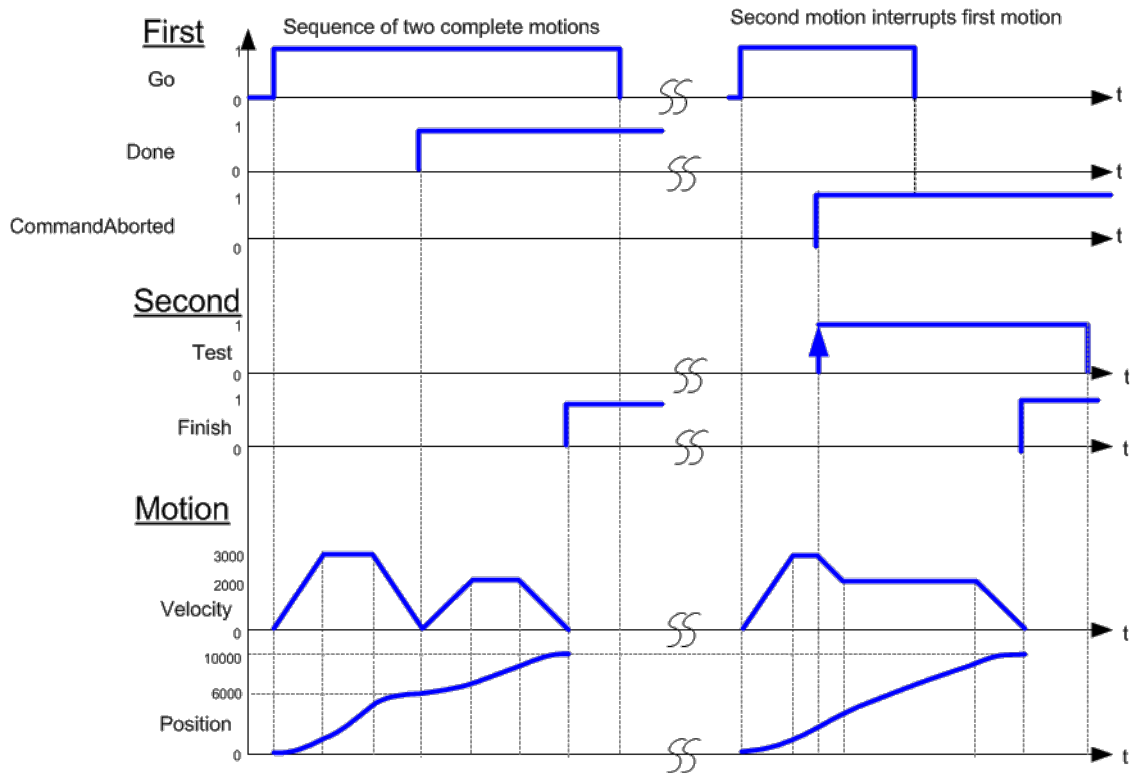

NOTE
 This function block starts a motion-related action and therefore stores data for calculations and error checking. Please see [Calling Function Blocks Multiple Times in the Same Cycle](#) if you are using a dual-core controller.

2.2.4.3.3 Arguments

2.2.4.3.3.1 Input

Execute	Description	Requests to queue the move
	Data type	BOOL
	Range	0, 1
	Unit	N/A
	Default	—
Axis	Description	Name of a declared instance of the AXIS_REF library function.)
	Data type	AXIS_REF
	Range	[1,256]
	Unit	N/A
	Default	—
Distance	Description	Distance to add to the endpoint of the previous move
	Data type	REAL
	Range	—

	Unit	User unit
	Default	—
Velocity	Description	Velocity setpoint
	Data type	LREAL
	Range	—
	Unit	User unit/sec
	Default	—
Acceleration	Description	Trapezoidal: Acceleration rate S-curve: Maximum acceleration
	Data type	LREAL
	Range	—
	Unit	User unit/sec ²
	Default	—
Deceleration	Description	Trapezoidal: Deceleration rate S-curve: Unused
	Data type	LREAL
	Range	—
	Unit	User unit/sec ²
	Default	—
Jerk	Description	Trapezoidal: 0 S-curve: Constant jerk
	Data type	LREAL
	Range	—
	Unit	User unit/sec ³
	Default	—
BufferMode	Description	0 = abort 1 = buffer 2 = blend to active 3 = blend to next 4 = blend to low velocity 5 = blend to high velocity
	Data type	SINT
	Range	[0,5]
	Unit	N/A
	Default	—

2.2.4.3.3.2 Output

Done	Description	Indicates the move completed successfully. The Command Position has reached the endpoint.
	Data type	BOOL
Busy	Description	High from the moment the Execute input is one-shot to the time the move is ended
	Data type	BOOL
Active	Description	Indicates this move is the active move
	Data type	BOOL
CommandAborted	Description	Indicates the move was aborted
	Data type	BOOL
Error	Description	Indicates an invalid input was specified or the move was terminated due to an error
	Data type	BOOL
ErrorID	Description	Indicates the error if Error output is set to TRUE
	Data type	INT

2.2.4.3.4 Example

2.2.4.3.4.1 Structured Text

```
(* MC_MoveAdditive ST example *)

Inst_MC_MoveAdditive( MovAddReq, Axis1, 123.456, 100.0, 100.0, 100.0, 0,
0 );
//Inst_MC_MoveAdditive is an instance of MC_MoveAdditive function
block
MovAddDone := Inst_MC_MoveAdditive.Done;
//store Done output into user defined variable
```

2.2.4.3.4.2 Ladder Diagram

Move Axis 1 an additive distance of 300

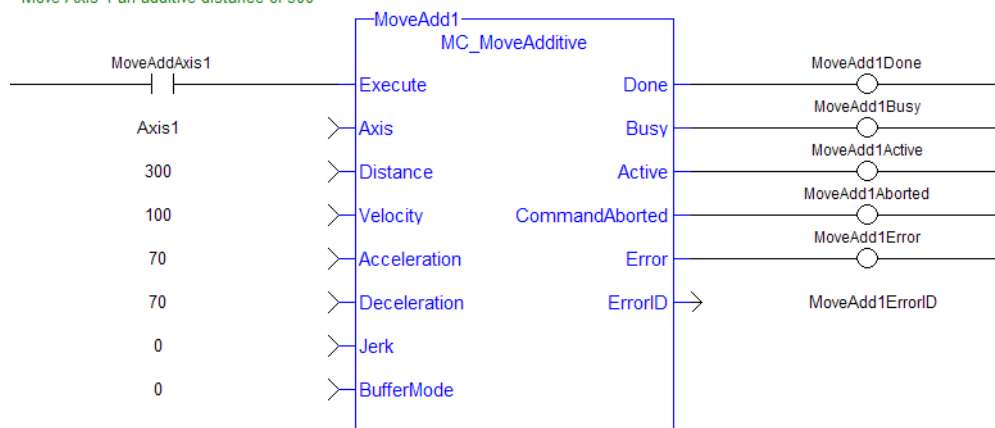

2.2.4.4 MC_MoveRelative

PLCopen

2.2.4.4.1 Description

This function block executes a single-axis move for a specified distance to perform incremental motion.

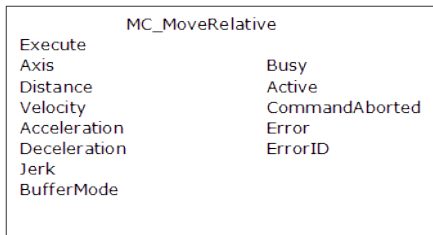
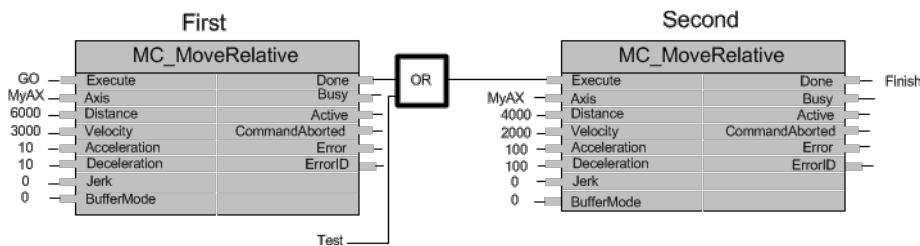

Figure 1-79: MC_MoveRelative

2.2.4.4.2 Time Diagram

The following figure shows the example of the combination of two relative move Function Blocks:

- The left part of timing diagram illustrates the case if the Second Function Block is called **after** the First one. If First reaches the commanded distance 6000 (and the velocity is 0) then the output **Done** causes the Second FB to move to the distance 10000
- The right part of the timing diagram illustrates the case if the Second move Function Blocks starts the execution **while** the First FB is still executing. In this case the First motion is interrupted and aborted by the Test signal during the constant velocity of the First FB. The Second FB **adds on the actual position** of 3250 the distance 4000 and moves the axis to the resulting position of 7250



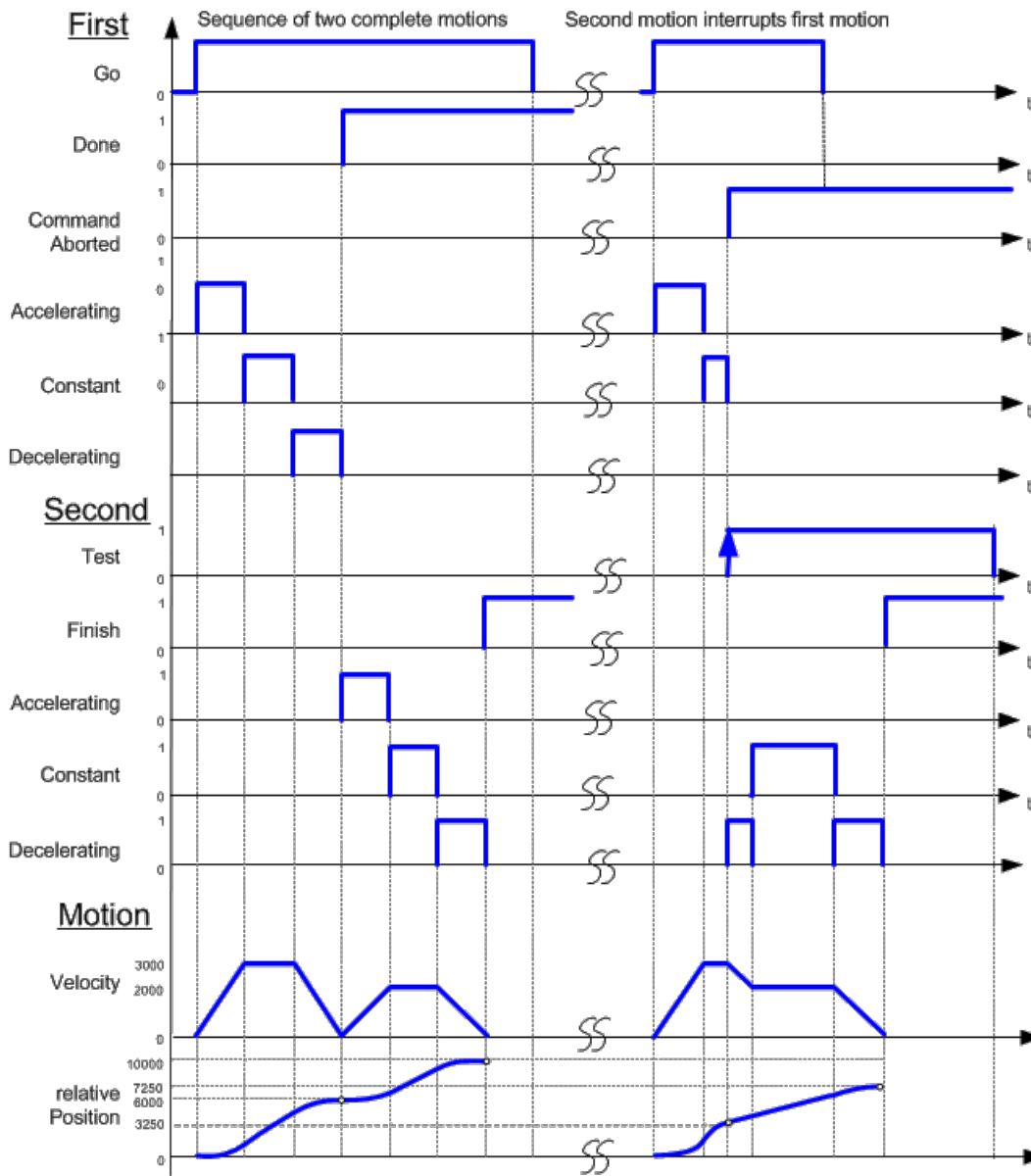

NOTE
 This function block starts a motion-related action and therefore stores data for calculations and error checking. Please see [Calling Function Blocks Multiple Times in the Same Cycle](#) if you are using a dual-core controller.

2.2.4.4.3 Arguments

2.2.4.4.3.1 Input

Execute	Description	Requests to queue the move
	Data type	BOOL
	Range	0, 1
	Unit	N/A
	Default	—

Axis	Description	Name of a declared instance of the AXIS_REF library function.
	Data type	AXIS_REF
	Range	[1,256]
	Unit	N/A
	Default	—
Distance	Description	Distance
	Data type	LREAL
	Range	—
	Unit	User unit
	Default	—
Velocity	Description	Velocity setpoint
	Data type	LREAL
	Range	—
	Unit	User unit/sec
	Default	—
Acceleration	Description	Trapezoidal: Acceleration rate S-curve: Maximum acceleration
	Data type	LREAL
	Range	—
	Unit	User unit/sec ²
	Default	—
Deceleration	Description	Trapezoidal: Deceleration rate S-curve: Unused
	Data type	LREAL
	Range	—
	Unit	User unit/sec ²
	Default	—
Jerk	Description	Trapezoidal: 0 S-curve: Constant jerk
	Data type	LREAL
	Range	—
	Unit	User unit/sec ³

	Default	—
BufferMode	Description	0 = abort 1 = buffer 2 = blend to active 3 = blend to next 4 = blend to low velocity 5 = blend to high velocity
	Data type	SINT
	Range	[0,5]
	Unit	N/A
	Default	—

2.2.4.4.3.2 Output

Done	Description	Indicates the move completed successfully. The Command Position has reached the endpoint.
	Data type	BOOL
Busy	Description	High from the moment the Execute input is one-shot to the time the move is ended
	Data type	BOOL
Active	Description	Indicates this move is the active move
	Data type	BOOL
CommandAborted	Description	Indicates the move was aborted
	Data type	BOOL
Error	Description	Indicates an invalid input was specified or the move was terminated due to an error
	Data type	BOOL
ErrorID	Description	Indicates the error if Error output is set to TRUE
	Data type	INT

2.2.4.4.4 Example

2.2.4.4.4.1 Structured Text

```
(* MC_MoveRelative ST example *)
Inst_MC_MoveRelative( MovRelReq, Axis1, 10.0, 200.0,150.0, 150.0, 0,0 );
MovRelDone := Inst_MC_MoveRelative.Done; //store Done output into user
defined variable
```

See also how this function is used in the Hole punch project [here](#)

2.2.4.4.4.2 Ladder Diagram

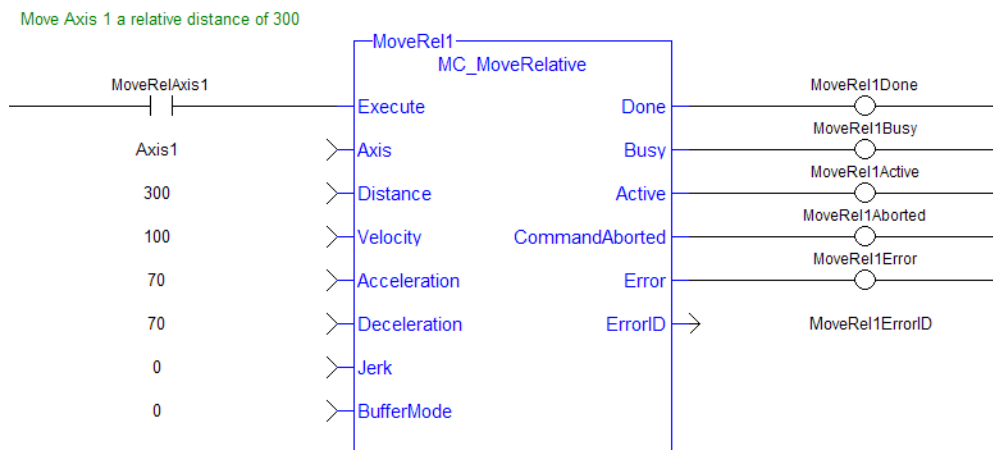

2.2.4.5 MC_MoveSuperimp PLCopen

2.2.4.5.1 Description

This function block provides the ability to cause additional axis motion superimposed upon a currently executing move. A superimposed move is executed like an **MC_MoveRelative** move using the specified **Distance**, **Velocity** (i.e. VelocityDiff), **Acceleration**, **Deceleration**, and **Jerk** values. The interpolated command generated by a superimposed move is added to the command of the currently executing move. Subsequent calls to MC_MoveSuperimp can abort or blend to an executing MC_MoveSuperimp move.

This function block provides a way to smoothly apply a shift in axis position while it is executing a move.

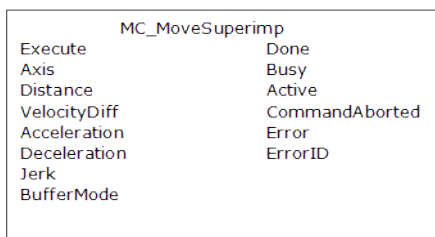
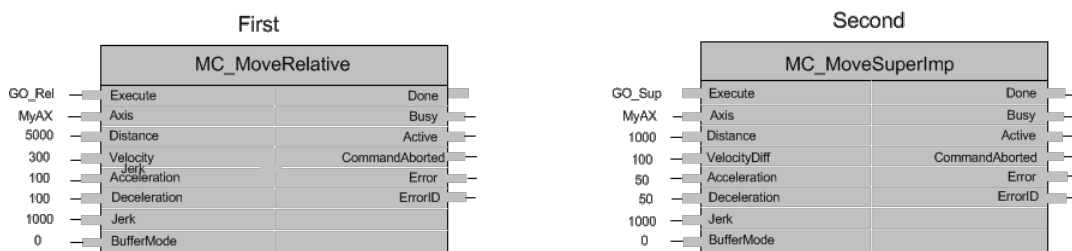
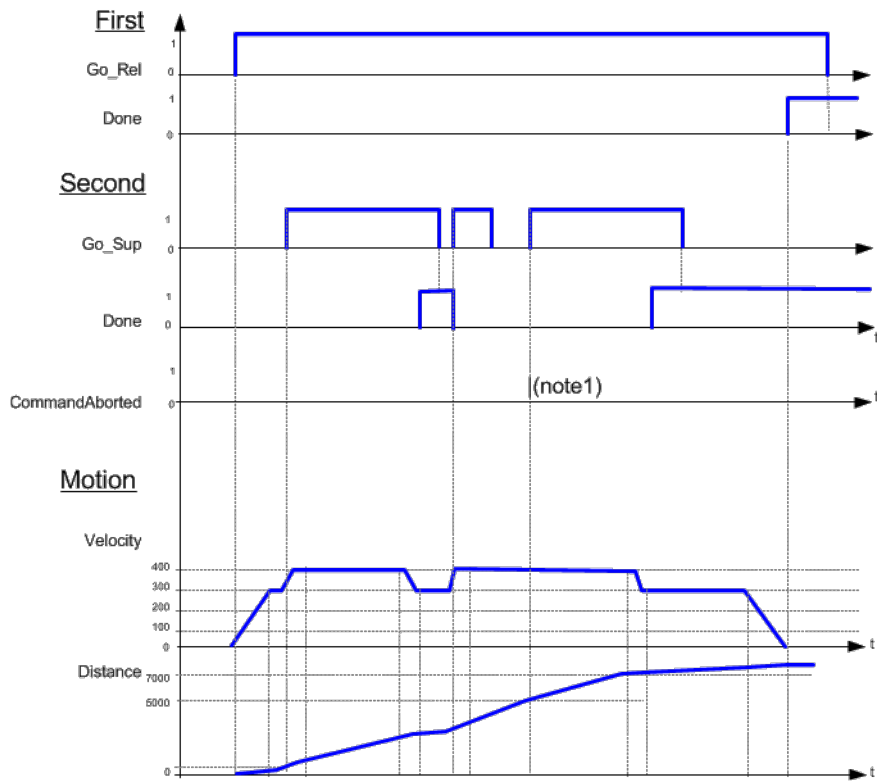

Figure 1-80: MC_MoveSuperimp

2.2.4.5.2 Time Diagram





- NOTE**
1. The CommandAborted is not visible here, because the new command works on the same instance
 2. The end position is between 7000 and 8000, depending on the timing of the aborting of the second command set for the MC_MoveSuperimposed

NOTE
 This function block starts a motion-related action and therefore stores data for calculations and error checking. Please see [Calling Function Blocks Multiple Times in the Same Cycle](#) if you are using a dual-core controller.

2.2.4.5.3 Arguments

2.2.4.5.3.1 Input

Execute	Description	Requests to queue the superimposed move
	Data type	BOOL
	Range	0, 1
	Unit	N/A
	Default	—
Axis	Description	Name of a declared instance of the AXIS_REF library function.
	Data type	AXIS_REF
	Range	[1,256]
	Unit	N/A

	Default	—
Distance	Description	Distance
	Data type	LREAL
	Range	—
	Unit	User unit
	Default	—
VelocityDiff	Description	Velocity rate
	Data type	LREAL
	Range	—
	Unit	User unit/sec
	Default	—
Acceleration	Description	Trapezoidal: Acceleration rate S-curve: Maximum acceleration
	Data type	LREAL
	Range	—
	Unit	User unit/sec ²
	Default	—
Deceleration	Description	Trapezoidal: Deceleration rate S-curve: Unused
	Data type	LREAL
	Range	—
	Unit	User unit/sec ²
	Default	—
Jerk	Description	Trapezoidal: 0 S-curve: Constant jerk
	Data type	LREAL
	Range	—
	Unit	User unit/sec ³
	Default	—
BufferMode	Description	0. abort 1. buffer 2. blend to active 3. blend to next 4. blend to low velocity 5. blend to high velocity
	Data type	SINT

Range	[0,5]
Unit	N/A
Default	—

2.2.4.5.3.2 Output

Done	Description	Indicates the move completed successfully. The Command Position has reached the endpoint.
	Data type	BOOL
Busy	Description	High from the moment the Execute input is one-shot to the time the move is ended
	Data type	BOOL
Active	Description	Indicates this move is the active superimposed move
	Data type	BOOL
CommandAborted	Description	Indicates the move was aborted
	Data type	BOOL
Error	Description	Indicates an invalid input was specified or the move was terminated due to an error
	Data type	BOOL
ErrorID	Description	Indicates the error if Error output is set to TRUE
	Data type	INT

2.2.4.5.4 Example

2.2.4.5.4.1 Structured Text

```
(* MC_MoveSuperimp ST example *)
Inst_MC_MoveSuperimp( MovSupReq, Axis1, 123.555, 10.0, 100.0, 100.0, 0, 0
);
MovSupDone := Inst_MC_MoveSuperimp.Done; //store Done output into user
defined variable
```

2.2.4.5.4.2 Ladder Diagram

Move Axis 1 a superimposed distance of 500

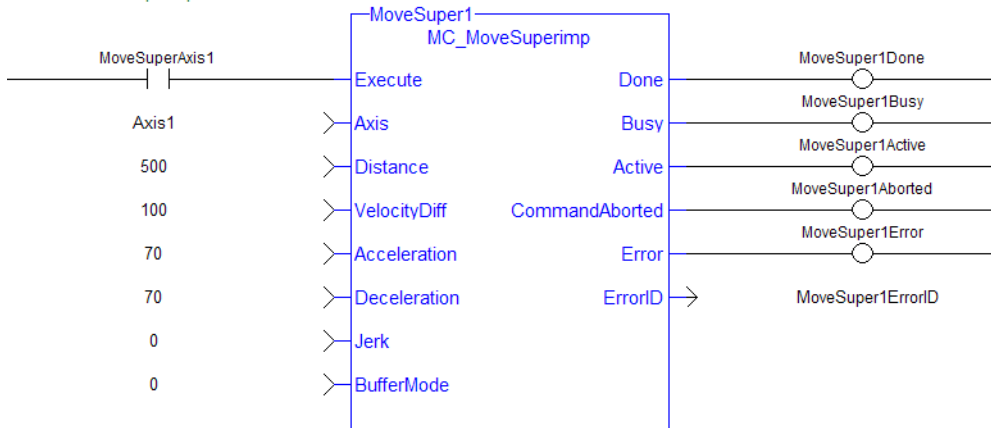

2.2.4.6 MC_MoveVelocity PLCopen

2.2.4.6.1 Description

This function block performs a single-axis non-ending move at a specified velocity. This type of move can be terminated with the MC_Halt function block or by aborting it with another move.

TIP

Consider using the [MC_MoveContVel](#) function block. It is more flexible and allows for the continuous update of motion parameters.

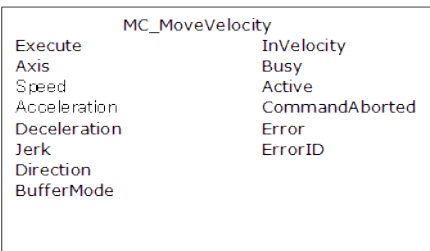

Figure 1-81: MC_MoveVelocity

[MC_MoveContVel](#)

2.2.4.6.2 Time Diagram

The example below shows the behavior of the combination of a [MC_Stop](#) FB with a [MC_MoveVelocity](#) FB.

- A rotating axis is ramped down with FB2 MC_Stop
- The axis rejects motion commands as long as MC_Stop parameter “Execute” = TRUE

FB1 MC_MoveVelocity reports an error indicating the busy MC_Stop command.

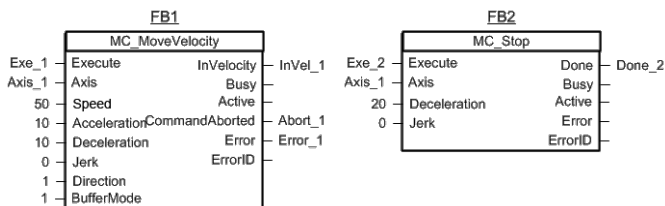

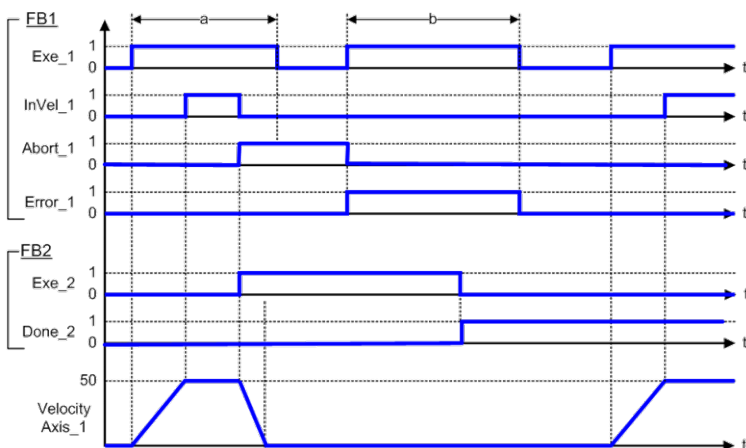

NOTE
 This function block starts a motion-related action and therefore stores data for calculations and error checking. Please see [Calling Function Blocks Multiple Times in the Same Cycle](#) if you are using a dual-core controller.

2.2.4.6.3 Arguments

2.2.4.6.3.1 Input

Execute	Description	Requests to queue the move
	Data type	BOOL
	Range	False, True
	Unit	N/A
	Default	—
Axis	Description	Identifier of a declared instance of the AXIS_REF library function. For more details,.
	Data type	AXIS_REF
	Range	[1,256]
	Unit	N/A
	Default	—
Speed	Description	The target axis speed. Direction is specified by the Direction input parameter.
	Data type	LREAL
	Range	Positive values
	Unit	User unit/sec
	Default	—
Acceleration	Description	Trapezoidal: Acceleration rate S-curve: Maximum acceleration
	Data type	LREAL

	Range	Positive values
	Unit	User unit/sec ²
	Default	—
Deceleration	Description	Trapezoidal: Deceleration rate S-curve: Unused
	Data type	LREAL
	Range	Positive values
	Unit	User unit/sec ²
	Default	—
Jerk	Description	Trapezoidal: 0 S-curve: Constant jerk
	Data type	LREAL
	Range	—
	Unit	User unit/sec ³
	Default	—
Direction	Description	A 0 or False value specifies that the axis should move in the positive direction. A 1 or True value specifies that the axis should move in the negative direction.
	Data type	SINT
	Range	[0, 1]
	Unit	N/A
	Default	—
BufferMode	Description	The specified buffer mode. For more information see "Buffer Modes" .
	Data type	SINT
	Range	MC_BUFFER_MODE_ABORTING MC_BUFFER_MODE_BUFFERED MC_BUFFER_MODE_BLENDED_PREVIOUS MC_BUFFER_MODE_BLENDED_NEXT MC_BUFFER_MODE_BLENDED_LOW MC_BUFFER_MODE_BLENDED_HIGH
	Unit	N/A
	Default	—

2.2.4.6.3.2 Output

InVelocity	Description	Indicates the command velocity has reached the programmed velocity
-------------------	--------------------	--

	Data type	BOOL
Busy	Description	High from the moment the Execute input is one-shot to the time the move is ended
	Data type	BOOL
Active	Description	Indicates this move is the active move
	Data type	BOOL
CommandAborted	Description	Indicates the move was aborted
	Data type	BOOL
Error	Description	Indicates an invalid input was specified or the move was terminated due to an error
	Data type	BOOL
ErrorID	Description	Indicates the error if Error output is set to TRUE. See table in PLCopen Function Block ErrorID Output
	Data type	INT

2.2.4.6.4 Example

2.2.4.6.4.1 Structured Text

```
(* MC_MoveVelocity ST example *)

Inst_MC_MoveVelocity( MovVelReq , Axis1, 200.0, 100.0, 100.0, 0, True,
MC_BUFFER_MODE_ABORTING );
```

2.2.4.6.4.2 Ladder Diagram

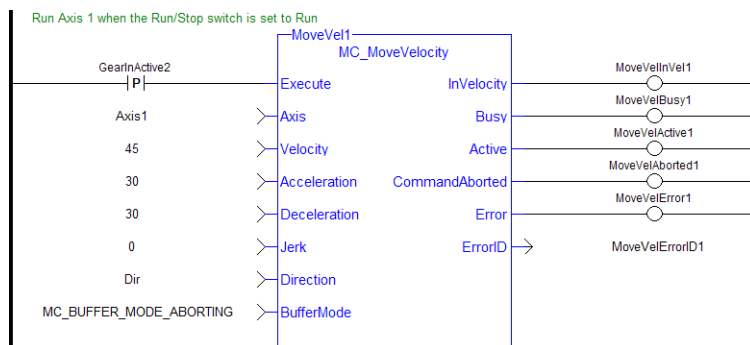

2.2.4.7 MC_MoveContVel PLCopen

2.2.4.7.1 Description

This function block performs a single-axis non-ending move at a specified velocity with the option of continually updating the ongoing motion with the current input parameters. After **MC_MoveContVel** execution begins (**Execute** input - low to high), follow up changes to input parameters immediately affect the ongoing motion, without requiring an additional low to high transition on the **Execute** input.

This type of move can be terminated with the [MC_Halt](#) function block or by aborting it with another move.



Figure 1-82: MC_MoveContVel

NOTE

This function or function block returns cached data. See [Programming a Dual Core Controller](#) for more information.

[MC_MoveVelocity](#)

2.2.4.7.2 Time Diagram

The example below shows the behavior of the combination of a [MC_Stop](#) function block with a MC_MoveContVel function block.

- A rotating axis is ramped down with FB2 [MC_Stop](#)
- The axis rejects motion commands as long as [MC_Stop](#) parameter "Execute" = TRUE

FB1 MC_MoveContVel reports an error indicating the busy [MC_Stop](#) command.

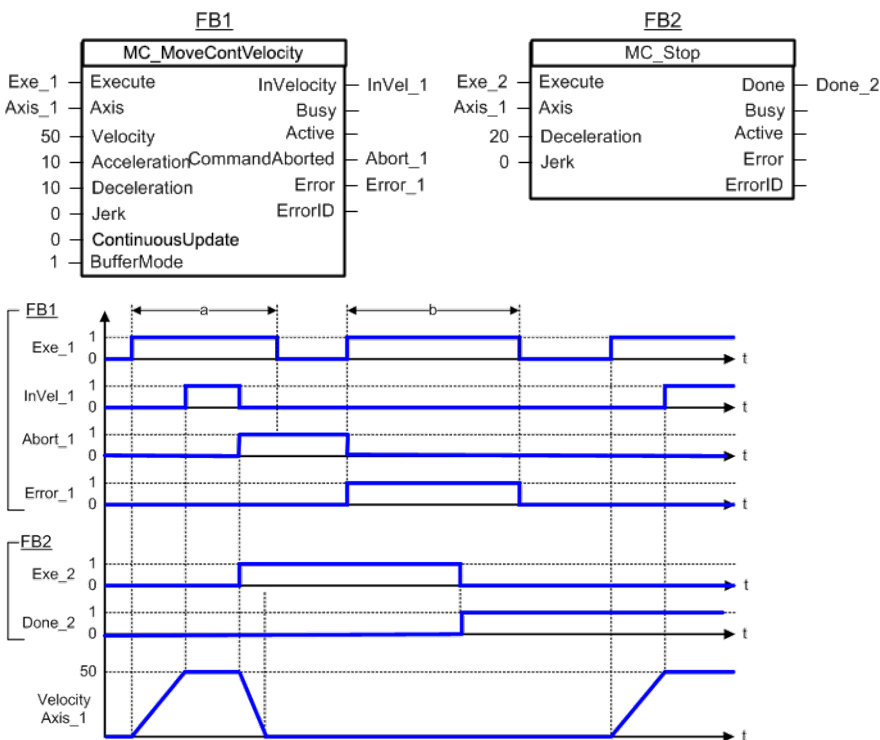

NOTE

This function block starts a motion-related action and therefore stores data for calculations and error checking. Please see [Calling Function Blocks Multiple Times in the Same Cycle](#) if you are using a dual-core controller.

2.2.4.7.3 Arguments

2.2.4.7.3.1 Input

Execute	Description	Requests to queue the move.
	Data type	BOOL
	Range	False, True
	Unit	N/A
	Default	—
Axis	Description	Identifier of a declared instance of the the AXIS_REF library function (for more details, .
	Data type	AXIS_REF
	Range	[1,256]
	Unit	N/A
	Default	—
Velocity	Description	The target axis velocity. Negative values of velocity will move the axis in the negative direction. Positive values will move the axis in the positive direction. A value of 0 is valid and indicates a deceleration to zero velocity.
	Data type	LREAL
	Range	All finite values
	Unit	User unit/sec
	Default	—
Acceleration	Description	Trapezoidal: Acceleration rate S-curve: Maximum acceleration
	Data type	LREAL
	Range	Positive values
	Unit	User unit/sec ²
	Default	—
Deceleration	Description	Trapezoidal: Deceleration rate S-curve: Unused
	Data type	LREAL
	Range	Positive values
	Unit	User unit/sec ²
	Default	—

Jerk	Description	Trapezoidal: 0 S-curve: Constant jerk
	Data type	LREAL
	Range	—
	Unit	User unit/sec ³
	Default	—
ContinuousUpdate	Description	Determines if the inputs of the function block are re-evaluated every cycle or if they are only evaluated on the rising edge of Execute . If TRUE when the function block is triggered (on the rising edge of Execute), the function block uses the current updated values of the input variables and apply it to the ongoing movement of the axis. This will continue as long as ContinuousUpdate stays TRUE. The impact of ContinuousUpdate ends as soon as the function block is no longer busy (Busy output is FALSE) or ContinuousUpdate is set to FALSE.
	Data type	BOOL
	Range	False, True
	Unit	N/A
	Default	—
BufferMode	Description	The specified buffer mode. For more information see "Buffer Modes" .
	Data type	SINT
	Range	MC_BUFFER_MODE_ABORTING MC_BUFFER_MODE_BUFFERED MC_BUFFER_MODE_BLENDED_PREVIOUS MC_BUFFER_MODE_BLENDED_NEXT MC_BUFFER_MODE_BLENDED_LOW MC_BUFFER_MODE_BLENDED_HIGH
	Unit	N/A
	Default	—

2.2.4.7.3.2 Output

InVelocity	Description	Indicates the command velocity has reached the programmed velocity
	Data type	BOOL
Busy	Description	High from the moment the Execute input is one-shot to the time the move is ended
	Data type	BOOL
Active	Description	Indicates this move is the active move

	Data type	BOOL
CommandAborted	Description	Indicates the move was aborted
	Data type	BOOL
Error	Description	Indicates an invalid input was specified or the move was terminated due to an error
	Data type	BOOL
ErrorID	Description	Indicates the error if Error output is set to TRUE. See table in PLCopen Function Block ErrorID Output
	Data type	INT

2.2.4.7.4 Example

2.2.4.7.4.1 Structured Text

```
(* MC_MoveContVel ST example *)
Inst_MC_MoveContVel( MovVelReq , Axis1, Vel, 100.0, 100.0, 0, True, MC_
BUFFER_MODE_ABORTING );
```

2.2.4.7.4.2 Freeform Ladder Diagram

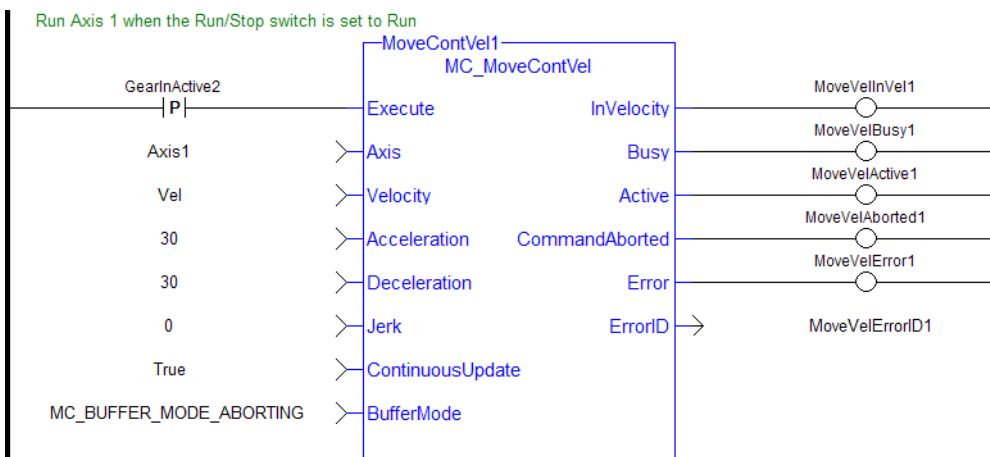

2.2.4.8 MC_SetOverride PLCopen ✔

2.2.4.8.1 Description

This function block writes the velocity override factor. A change in the velocity override factor takes effect immediately on the active move.

The velocity override factor is applied to the programmed velocity (of a [MC_MoveAbsolute](#), [MC_MoveAdditive](#), [MC_MoveRelative](#), [MC_MoveSuperimp](#), or [MC_MoveVelocity](#) function block) to determine the command velocity:

```
command velocity = programmed velocity * VelFactor
```

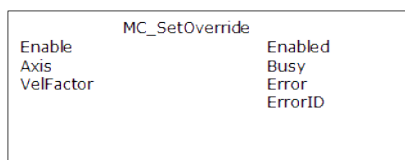

Figure 1-83: MC_SetOverride

2.2.4.8.2 Arguments

2.2.4.8.2.1 Input

Enable	Description	Request to write the override factors
	Data type	BOOL
	Range	0, 1
	Unit	N/A
	Default	—
Axis	Description	Name of a declared instance of the AXIS_REF library function.
	Data type	AXIS_REF
	Range	[1,256]
	Unit	N/A
	Default	—
VelFactor	Description	Velocity override factor
	Data type	REAL
	Range	[0.0, 2.0]
	Unit	N/A
	Default	—

2.2.4.8.2.2 Output

Enabled	Description	Indicates the override values have been written
	Data type	BOOL
Busy	Description	Indicates the function block is executing
	Data type	BOOL
Error	Description	Indicates an invalid input is specified
	Data type	BOOL
ErrorID	Description	Indicates the error if Error output is set to TRUE
	Data type	INT

2.2.4.8.3 Example

2.2.4.8.3.1 Structured Text

```
(* MC_SetOverride ST example *)

VelFactor := 1.25 ; //set the velocity factor to 1.25 (125%)
Inst_MC_SetOverride( TRUE , Axis1, VelFactor ); // Inst_MC_Setoverride is
an instance of MC_SetOverride
```

2.2.4.8.3.2 Ladder Diagram

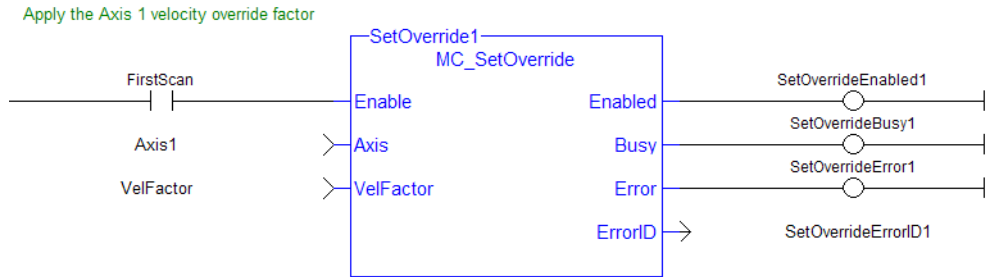

2.2.5 Profile Functions

This set of functions provides commands for slave axes, such as cams and gearing.

2.2.5.1 MC_CamIn PLCopen

2.2.5.1.1 Description

This function block performs a slave axis move which follows the master axis based on the Cam Table specified by CamTableID.

This function block is used to either initiate a new MC_CamIn move or to resume a previously programmed MC_CamIn move. Refer to [MC_CamStartPos](#) and [MC_CamResumePos](#) for information on positioning the slave axis prior to calling MC_CamIn.



Figure 1-84: MC_CamIn

Aborting Camming

There are two common options to stop camming after MC_CamIn has been called.

- [MC_CamOut](#) will continue motion at the instantaneous final actual velocity of the slave axis when it is called, and axis motion will continue at that final actual velocity.
- [MC_Halt](#) (with buffer mode input = 0) will decelerate axis motion to 0 speed and stop motion.

The master / slave relationship between the two axes is ended when MC_CamOut or MC_Halt is called.

NOTE

Ending camming is also possible with other single axis function blocks such as [MC_MoveRelative](#) and [MC_MoveAbsolute](#).

NOTE

This function block starts a motion-related action and therefore stores data for calculations and error checking. Please see [Calling Function Blocks Multiple Times in the Same Cycle](#) if you are using a dual-core controller.

2.2.5.1.2 Arguments**2.2.5.1.2.1 Input**

Execute	Description	Requests to queue the CamIn move
	Data type	BOOL
	Range	0, 1
	Unit	N/A
Master	Description	Name of a declared instance of the AXIS_REF library function
	Data type	AXIS_REF
	Range	1 - 256
	Unit	N/A
Slave	Description	AXIS_REF.AXIS_NUM is the slave axis number
	Data type	AXIS_REF
	Range	1-256
	Unit	N/A
MasterOffset	Description	Profile shift along the master axis. This input is not used if the StartMode input is set to 1 for Resume Mode.
	Data type	LREAL
	Range	—
	Unit	User unit
SlaveOffset	Description	Profile shift along the slave axis. This input is not used if the StartMode input is set to 1 for Resume Mode.
	Data type	LREAL
	Range	—
	Unit	User unit

MasterScaling	Description	Master axis profile range. This input is not used if the StartMode input is set to 1 for Resume Mode. Scaling must be a positive value that is greater than 0.
	Data type	LREAL
	Range	—
	Unit	User unit
	Description	Slave axis profile range. This input is not used if the StartMode input is set to 1 for Resume Mode. Scaling must be a positive value that is greater than 0.
	Data type	LREAL
SlaveScaling	Range	—
	Unit	User unit
	Description	Starting mode of the cam profile. 0 = Start Mode. Start a cam profile move. 1 = Resume Mode. Resume the most recent MC_CamIn move. This input indicates whether the axis should start a MC_CamIn move as an initial cam start (StartMode = 0) or if the axis should resume the most recently programmed MC_CamIn move (StartMode = 1). It should be noted that in the case of Resume Mode (StartMode = 1) that the inputs MasterOffset, SlaveOffset, MasterScaling, and SlaveScaling are not used. The function block will use the values that were in effect during the most recently programmed MC_CamIn move for the slave axis.
	Data type	INT
	Range	[0,1]
	Unit	N/A
CamTableID	Description	ID number of the profile to be used with MC_CamIn
	Data type	INT
	Range	—
	Unit	N/A

BufferMode	Description	<p>The Buffer mode for CamIn block. Valid values include:</p> <ul style="list-style-type: none"> • MC_BUFFER_MODE_ABORT • MC_BUFFER_MODE_BUFFERED <p>For more information see Buffer Modes.</p> <p>MC_BUFFER_MODE_BUFFERED may only be used when an endpoint is specified with the previous move. This limits the use of MC_BUFFER_MODE_BUFFERED to when the previous move is a point-to-point move (MC_MoveAbsolute or MC_MoveRelative).</p> <p>MC_BUFFER_MODE_ABORT may be used to abort an existing camming, gearing, point-to-point, or velocities move.</p>
	Data type	SINT
	Range	MC_BUFFER_MODE_ABORT , MC_BUFFER_MODE_BUFFERED
	Unit	N/A

2.2.5.1.2.2 Output

InSync	Description	Indicates the slave axis is in sync with the profile
	Data type	BOOL
	Range	0, 1
	Unit	N/A
Busy	Description	Indicates this function block is executing
	Data type	BOOL
	Range	0, 1
	Unit	N/A
Active	Description	Indicates this move is the Active move
	Data type	BOOL
	Range	0, 1
	Unit	N/A
CommandAborted	Description	Indicates the move was aborted
	Data type	BOOL
	Range	0, 1
	Unit	N/A
Error	Description	Indicates an invalid input, or the move was terminated due to an error
	Data type	BOOL

	Range	0, 1
	Unit	N/A
ErrorID	Description	Indicates the error if the Error output is high.
	Data type	INT
	Range	—
	Unit	N/A
EndOfProfile	Description	Indicates the end of profile has been reached. If the profile is periodic this output is set to ON for one ladder scan. If the profile is not periodic, the output remains ON while outside the range of the profile.
	Data type	BOOL
	Range	0, 1
	Unit	N/A

2.2.5.1.3 Usage

The slave axis immediately locks on to the Cam Table profile.

The **Master Offset** is used to shift the profile along the master axis.

The **Master Scaling** defines the range of the profile along the master axis.

The **Slave Offset** is used to shift the profile along the Slave axis.

The **Slave Scaling** defines the range of the profile along the slave axis.

If the profile is periodic, when the end of profile reached, the profile continues at the start of the profile. The EndOfProfile output is ON for 1 ladder scan.

If the profile is not periodic, when the end of profile is reached, the slave axis stops and remains at the end of the profile until the master axis returns to within the profile range as defined by MasterScaling. The EndOfProfile output remains ON anytime the master axis is outside of the profile range.

Adjustments computation is done as follows:

When cam is first started, offsets are adjusted if necessary

- If slave is not absolute, then slave offset = slave offset + starting position
- If master is not absolute, then master offset = master offset + starting position.

At run-time

- Master position for profile = master position - master offset
- Use master position for profile table to obtain slave profile position
- Slave commanded position = slave profile position + slave offset

2.2.5.1.3.1 Dynamically Changing a Cam Profile

MC_CamIn can be used to dynamically change from one cam profile to another. Care must be taken when doing this to avoid unexpected motion.

TIP

Some tips for dynamically changing cam profiles:

- Verify that the first cam’s last position and the replacement cam’s first position are the same. **Note:** Offsets as set by `MC_CamTblSelect` will affect actual cam position.
- Verify that the first cam’s last velocity and the replacement cam’s first velocity do not cause any unexpected motion.
- Jumps can be eliminated by defining the present cam as *Cyclic* and defining the replacement cam as an *Absolute Master* and *Slave*, as set by the `MC_CamTblSelect` inputs. This eliminates any possible small error accumulating when the cam is switched.

2.2.5.1.4 Related Functions

[MC_CamResumePos](#)

[MC_CamStartPos](#)

[MC_CamTblSelect](#)

[MC_CamOut](#)

2.2.5.1.5 Examples

2.2.5.1.5.1 Structured Text

```
(* MC_CamIn ST example *) //Inst_MC_CamIn is an instance of MC_CamIn
Inst_MC_CamIn( CamStartBool, Axis1, Axis2, 0.0, 0.0, 360.0, 360.0, 0,
CamTableID, 0 );
```

2.2.5.1.5.2 Ladder Diagram

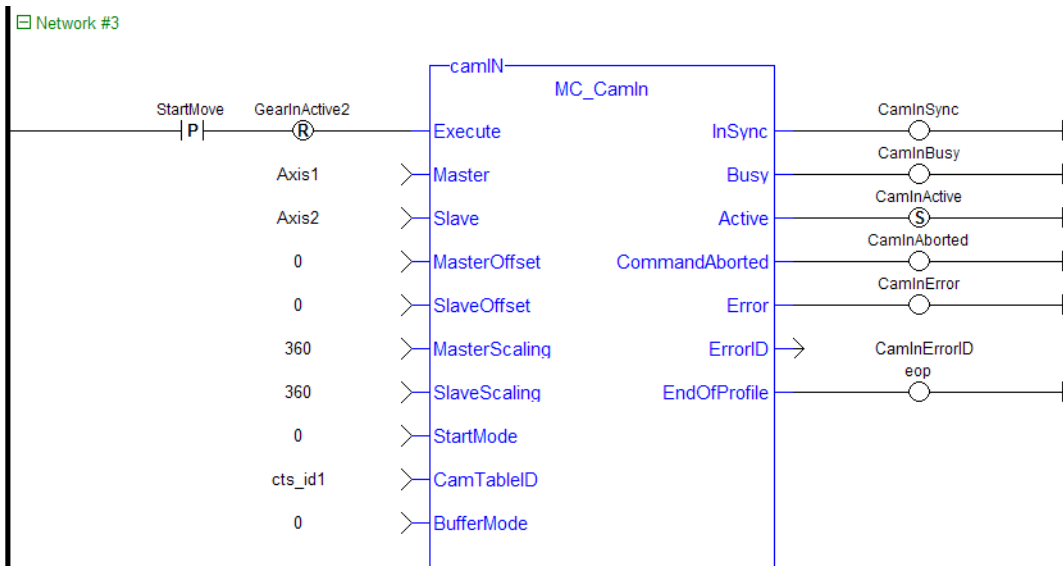

The three following examples utilizes the screen shot below showing the cam profile “MyProfile”

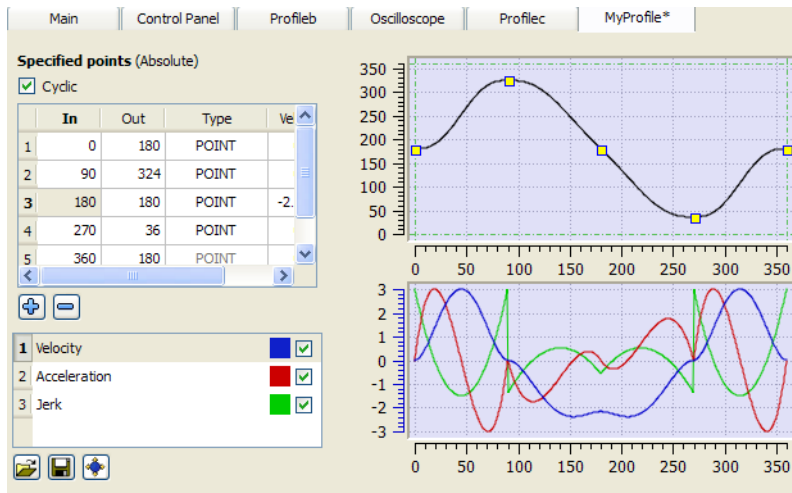
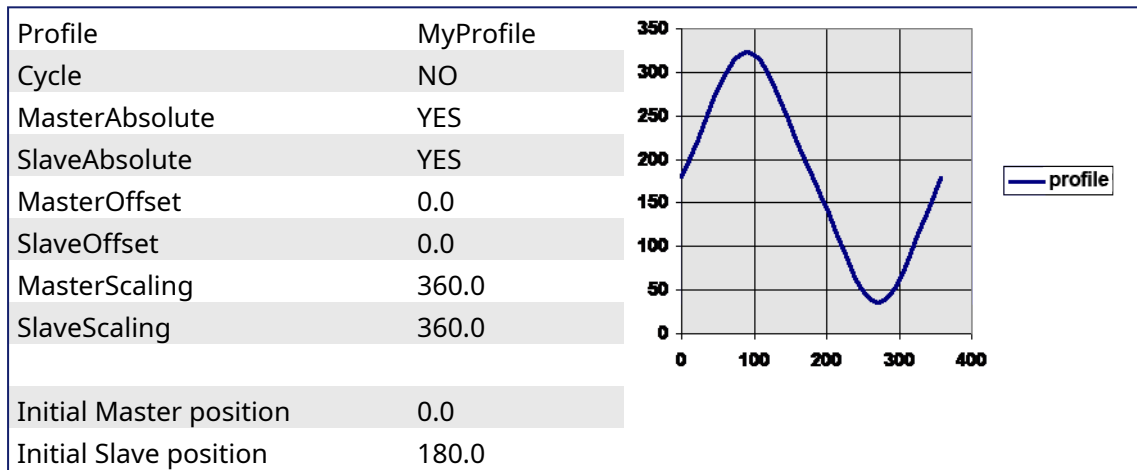

Figure 1-85: MC_CamIn examples

2.2.5.1.5.3 Example 1



After MC_CamTblSelect and MC_CamIn are programmed with the above parameters, the slave axis is locked on to the profile. Since both have zero offsets, the profile is not shifted in either axis. The initial condition of the master axis at position 0, yields a slave command position of 180.0. As the master axis moves positive, the slave position follows the profile. When the master position is at 90.0, the slave is commanded to 324.0 (see curve below where in = 90, out = 324). The slave follows the profile as the master axis moves until the master axis reaches a position of 360.0. At this time the slave is commanded to 180.0.

If the master were to continue to move past 360.0 the slave commanded position would remain at 180.0 since the Cyclic input is false. If the master moves negative and its position returns to less than 360.0, then the slave follows the profile again.

2.2.5.1.5.4 Example 2

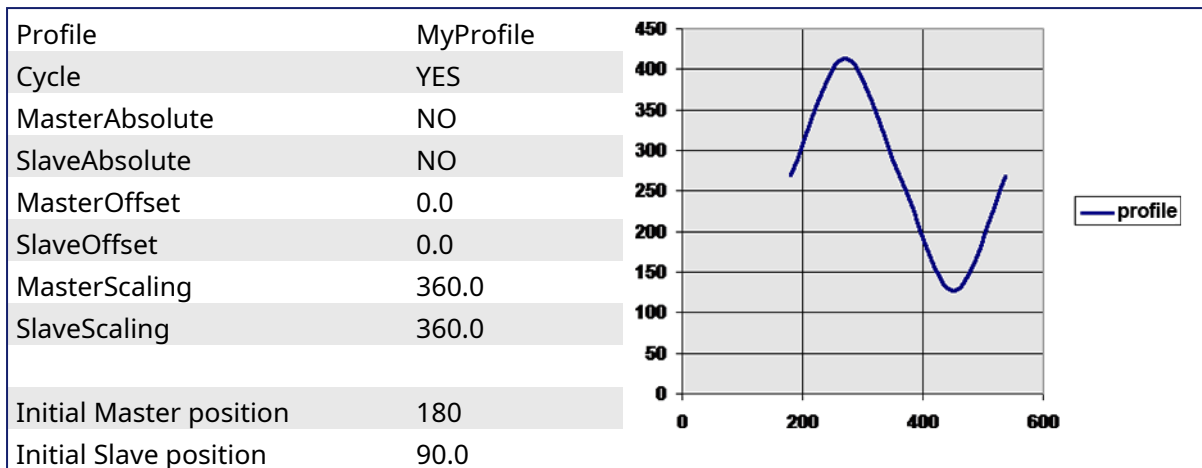

After MC_CamTblSelect and MC_CamIn are programmed with the above parameters, the slave axis is locked on to the profile. Since the both axes have zero offsets, the profile is not shifted in either axis. Neither the *MasterAbsolute* nor *SlaveAbsolute* input is on, so the profile is relative to the axes initial positions. Specifically, the initial condition of the master axis at position 180 would represent a master profile position of 0 (180-180). This yields a slave command position of 270 (180 + 90). As the master axis moves positive, the slave position follows the profile. When the master position is at 270, the slave is commanded to 414.0 (324 + 90). The slave follows the profile as the master axis moves until the master axis reaches a position of 540. At this time the slave is commanded to 270.0 (180 + 90).

If the master continues to move past 540.0, the slave commanded position follows the profile from the beginning since the Cyclic input is TRUE. When the master reaches a position of 630, the slave is commanded to a position of 414.0 (324 + 90).

2.2.5.1.5.5 Example 3

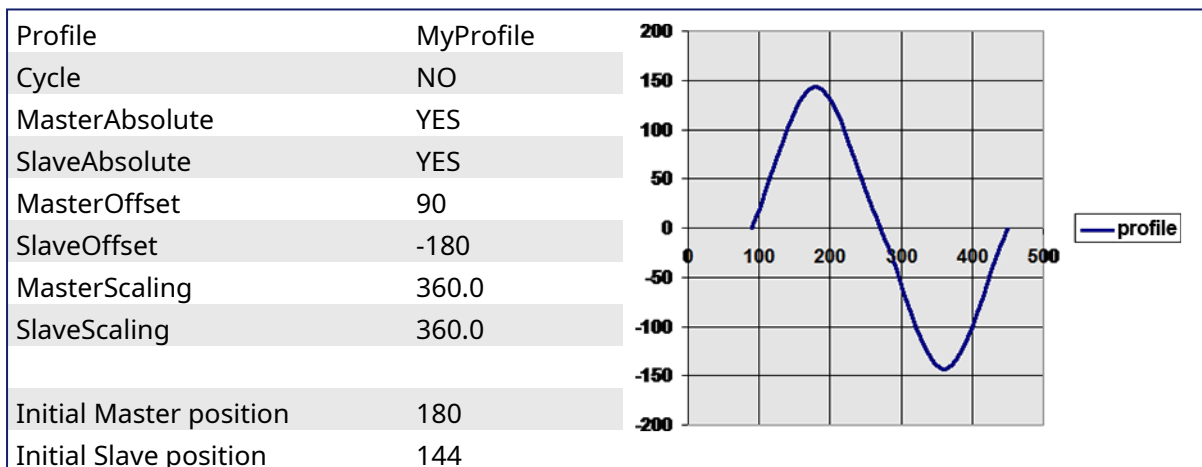

After MC_CamTblSelect and MC_CamIn are programmed with the above parameters, the slave axis is locked on to the profile. Since the both axes have offsets, the profile is shifted along both axes. Specifically the master axis is shifted 90, and the slave axis is shifted -180. Initially the master axis position of 180 yields a master position for the profile calculation of 90 (master position 180 - Master offset 90), which yields a slave command position of 144 (slave profile command 324 + slave offset (-180)). As the master axis moves positive, the slave position follows the profile. When the master axis position is at 270, the master position for profile calculation is 180 (270 - 90). This yields a slave command position of 0 (180 + (-180)).

The slave follows the profile as the master axis moves until the master axis reaches a position of 450. The master axis position of 450 yields a master position for profile calculation of 360 (450 - 90). The slave command position is 0 (180 + (-180)).

When the master reaches a position of 450, the slave commanded position remains at 0 since the Cyclic input is false.

2.2.5.2 MC_CamOut

2.2.5.2.1 Description

This function block:

- aborts the active MC_CamIn move
- disengages the axis from its master
- and commands the axis to continue at its current velocity

TIP

The current velocity is calculated by taking the average of the actual velocity during the previous 16 cycles.

Like a MC_MoveVelocity move, the control continues to command the axis to move at this velocity until this MC_CamOut move is aborted. If this function block is called and the active move is not a MC_CamIn move, this function block returns an error and the active move is not aborted.

TIP

As an alternative method to cancel the cam motion, a single axis move ([MC_MoveAbsolute](#), [MC_MoveRelative](#), [MC_MoveAdditive](#), [MC_MoveVelocity](#), and [MC_Halt](#)) with the **buffermode** input set to 0 can be called. This will cancel the [MC_CamIn](#) function and start the new motion function on the slave axis. Many applications prefer calling MC_Halt instead of MC_CamOut because it will not send a velocity command to the slave axis.

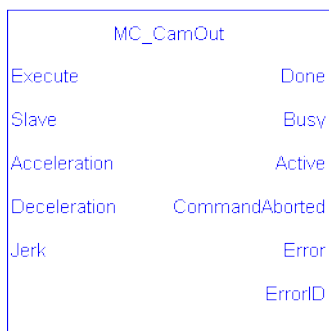

Figure 1-86: MC_CamOut

NOTE

This function block starts a motion-related action and therefore stores data for calculations and error checking. Please see [Calling Function Blocks Multiple Times in the Same Cycle](#) if you are using a dual-core controller.

2.2.5.2.2 Arguments

2.2.5.2.2.1 Input

Execute	Description	Requests to queue the CamOut move
	Data type	BOOL
	Range	0, 1
	Unit	N/A

	Default	—
Slave	Description	Name of a declared instance of the AXIS_REF library function
	Data type	AXIS_REF
	Range	1 – 256
	Unit	N/A
	Default	—
Acceleration	Description	Trapezoidal: Acceleration rate S-curve: Maximum acceleration
	Data type	LREAL
	Range	—
	Unit	User unit/sec ²
	Default	—
Deceleration	Description	Trapezoidal: Deceleration rate S-curve: Unused
	Data type	LREAL
	Range	—
	Unit	User unit/sec ²
	Default	—
Jerk	Description	Trapezoidal: 0 S-curve: Constant jerk
	Data type	LREAL
	Range	—
	Unit	User unit/sec ³
	Default	—

2.2.5.2.2.2 Output

Done	Description	Indicates the axis is disengaged from its master
	Data type	BOOL
	Range	0, 1
	Unit	N/A
Busy	Description	Indicates this function block is executing
	Data type	BOOL
	Range	0, 1

	Unit	N/A
Active	Description	Indicates this move is the Active move
	Data type	BOOL
	Range	0, 1
	Unit	N/A
CommandAborted	Description	Indicates the move was aborted
	Data type	BOOL
	Range	0, 1
	Unit	N/A
Error	Description	Indicates an invalid input was specified or no MC_CamIn move was active
	Data type	BOOL
	Range	0, 1
	Unit	N/A
ErrorID	Description	Indicates the error if the Error output is high
	Data type	INT
	Range	—
	Unit	N/A

2.2.5.2.3 Usage

This function block disengages the slave axis from a MC_CamIn move and then leaves the axis running at its current velocity. The axis continues to run at this velocity until this move is aborted.

2.2.5.2.4 Related Functions

[MC_CamIn](#)

[MC_CamTblSelect](#)

2.2.5.2.5 Example

2.2.5.2.5.1 Structured Text

```
(* MC_CamOut ST example *)
Inst_MC_CamOut
(ExecCamOut1,Axis1,CamOut1Acc,CamOut1Dec,CamOut1Jerk);
//Inst_MC_CamOut is an instance of MC_CamOut
```

2.2.5.2.5.2 Ladder Diagram

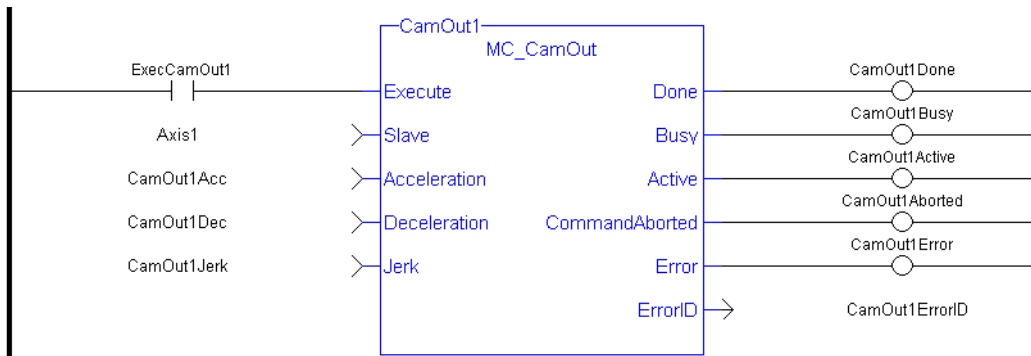

See also [MC_CamIn](#) for examples.

2.2.5.3 MC_CamResumePos PLCopen

2.2.5.3.1 Description

This function block returns the slave axis position for the most recently executed [MC_CamIn](#) profile, based on the current position of the master axis. This slave axis position can be used to command the slave axis to return to the proper location prior to resuming a [MC_CamIn](#) function. When calculating the slave axis position, [MC_CamResumePos](#) will utilize the master offset, slave offset, master scaling, and slave scaling of the most recently executed [MC_CamIn](#) function block for the slave axis.

The typical application of [MC_CamResumePos](#) is to aid in returning a slave axis back to its profile position after an event (e.g. E-stop) caused the slave axis to go off path. See [Resuming Camming After an E-Stop](#) for complete instructions.

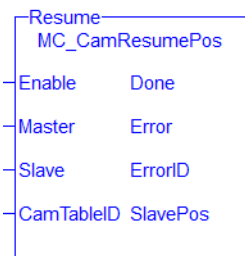

Figure 1-87: [MC_CamStartPos](#)

NOTE

This function block starts a motion-related action and therefore stores data for calculations and error checking. Please see [Calling Function Blocks Multiple Times in the Same Cycle](#) if you are using a dual-core controller.

2.2.5.3.2 Related Functions

[MC_CamIn](#)

[MC_CamStartPos](#)

2.2.5.3.3 Arguments

2.2.5.3.3.1 Inputs

Enable	Description	Enables execution of the function block
	Data Type	BOOL

	Range	N/A
	Units	N/A
	Default	—
Master	Description	Master axis. This must be the same as the Master Axis specified for the most recently executed MC_CamIn function block.
	Data Type	AXIS_REF
	Range	[1,256] for .AXIS_NUM
	Units	N/A
	Default	—
Slave	Description	Slave axis. This must be the same as the Slave Axis specified for the most recently executed MC_CamIn function block.
	Data Type	AXIS_REF
	Range	[1,256] for .AXIS_NUM
	Units	N/A
	Default	—
CamTableID	Description	Profile ID number. This value was generated by MC_CamTblSelect . This must be the same as the CamTableID specified for the most recently executed MC_CamIn function block.
	Data Type	INT
	Range	[0,255]
	Units	N/A
	Default	—

2.2.5.3.3.2 Outputs

Done	Description	TRUE = the function block has successfully calculated the slave position. The slave position is available at the SlavePos output.
	Data Type	BOOL
	Units	N/A
Error	Description	TRUE = an invalid input was specified or an error occurred in the calculations. The value at the SlavePos output is undefined.
	Data Type	BOOL
	Units	N/A

ErrorID	Description	Indicates the error if Error output is set to TRUE. See table in PLCopen Function Block ErrorID Output
	Data Type	INT
	Units	N/A
SlavePos	Description	If the Done output is TRUE, this output returns the position for the slave axis given the profile, the current master axis position, and the previously programmed master and slave offsets and scaling.
	Data Type	LREAL
	Units	User Units

2.2.5.3.4 Examples

2.2.5.3.4.1 ST

```
Inst_MC_CamStartPos( TRUE, Axis1, Axis2, Profile1CamTableID);
```

2.2.5.3.4.2 IL

```
CALL Inst_MC_CamResumePos( TRUE, Axis1, Axis2, Profile1CamTable ID)
```

2.2.5.3.4.3 FBD

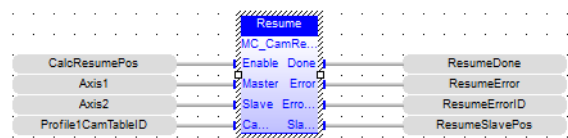

2.2.5.3.4.4 FFLD

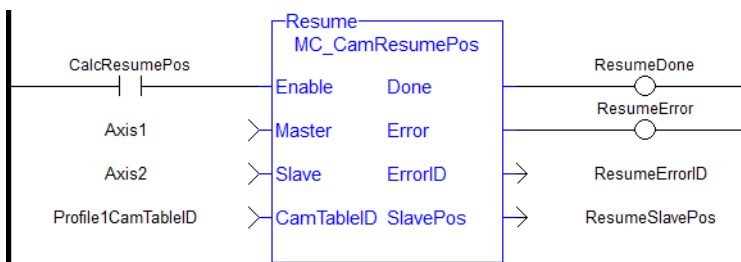

2.2.5.4 MC_CamStartPos PLCopen ✔

2.2.5.4.1 Description

This function block returns the slave axis position for the specified profile, based on the current position of the master axis. This slave axis position can be used to command the slave axis to move to the proper location prior to commanding a [MC_CamIn](#) move with StartMode = 0 (Start mode).

The typical application of MC_CamStartPos is to aid in positioning a slave axis to its starting position for a MC_CamIn move with a slave absolute profile. See [Positioning an Axis Before Starting Camming](#) for complete instructions.

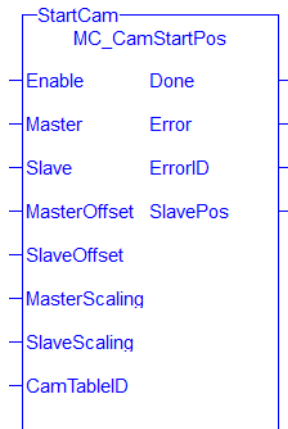

Figure 1-88: MC_CamStartPos

NOTE

This function block starts a motion-related action and therefore stores data for calculations and error checking. Please see [Calling Function Blocks Multiple Times in the Same Cycle](#) if you are using a dual-core controller.

2.2.5.4.2 Arguments

2.2.5.4.2.1 Inputs

Enable	Description	Enables execution of the function block
	Data Type	BOOL
	Range	N/A
	Units	N/A
	Default	—
Master	Description	Master axis
	Data Type	AXIS_REF
	Range	[1,256] for .AXIS_NUM
	Units	N/A
	Default	—
Slave	Description	Slave axis
	Data Type	AXIS_REF
	Range	[1,256] for .AXIS_NUM
	Units	N/A
	Default	—
MasterOffset	Description	Master axis offset
	Data Type	LREAL
	Range	—
	Units	User Units

	Default	—
SlaveOffset	Description	Slave axis offset
	Data Type	LREAL
	Range	—
	Units	User Units
	Default	—
MasterScaling	Description	Master axis scale factor. Scaling must be a positive value that is greater than 0.
	Data Type	LREAL
	Range	—
	Units	User Units
	Default	—
SlaveScaling	Description	Slave axis scale factor. Scaling must be a positive value that is greater than 0.
	Data Type	LREAL
	Range	—
	Units	User Units
	Default	—
CamTableID	Description	Profile ID number. This number was generated by MC_CamTblSelect .
	Data Type	INT
	Range	[0,255]
	Units	N/A
	Default	—

2.2.5.4.2.2 Outputs

Done	Description	TRUE = the function block has successfully calculated the slave position. The slave position is available at the SlavePos output.
	Data Type	BOOL
	Units	N/A
Error	Description	TRUE = an invalid input was specified or an error occurred in the calculations. The value at the SlavePos output is undefined.
	Data Type	BOOL
	Units	N/A

ErrorID	Description	Indicates the error if Error output is set to TRUE. See table in PLCopen Function Block ErrorID Output
	Data Type	INT
	Units	N/A
SlavePos	Description	If the Done output is TRUE, this output returns the position for the slave axis given the profile and the current master axis position.
	Data Type	LREAL
	Units	User Units

2.2.5.4.3 Examples

2.2.5.4.3.1 ST

```
Inst_MC_CamStartPos( TRUE, Axis1, Axis2, MasterOffset, SlaveOffset,
MasterScale, SlaveScale, Profile1CamTableID);
```

2.2.5.4.3.2 IL

```
CALL Inst_MC_CamStartPos( TRUE, Axis1, Axis2, MasterOffset,
SlaveOffset, MasterScale, SlaveScale, Profile1CamTable ID)
```

2.2.5.4.3.3 FBD

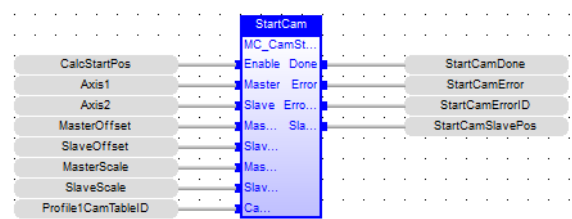

2.2.5.4.3.4 FFLD

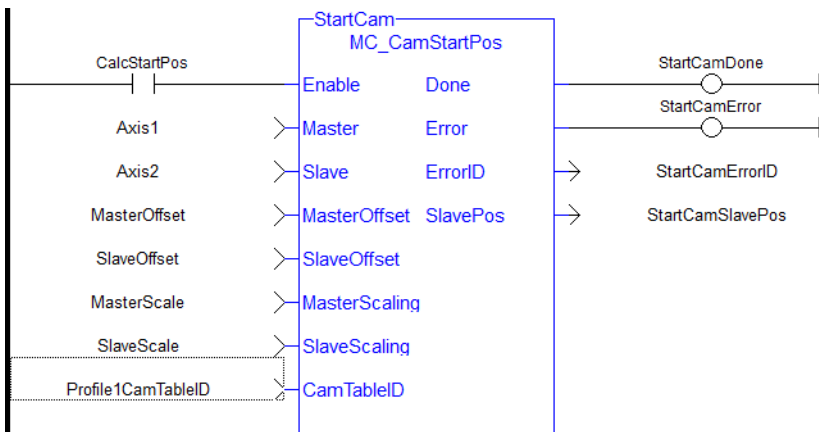

2.2.5.5 MC_CamTblSelect PLCopen

2.2.5.5.1 Description

This Function Block is defined to read and initialize the specified profile, returning an ID to be used with MC_CamIn function block.

2.2.5.5.2 Arguments

2.2.5.5.2.1 Input

Execute	Description	Requests to queue the slave gear ratio move
	Data type	BOOL
	Range	0, 1
	Unit	N/A
	Default	—
CamTable	Description	Profile name as defined in the CAM Profile Properties dialog
	Data type	STRING
	Range	—
	Unit	N/A
	Default	—
Periodic	Description	Selects if the profile is periodic (see also Usage section)
	Data type	BOOL
	Range	0, 1
	Unit	N/A
	Default	—
MasterAbsolute	Description	Selects if master profile is absolute or relative (see also Usage section)
	Data type	BOOL
	Range	0, 1
	Unit	N/A
	Default	—
SlaveAbsolute	Description	Selects if Slave profile is absolute or relative (see also Usage section)
	Data type	BOOL
	Range	0, 1
	Unit	N/A
	Default	—

2.2.5.5.2.2 Output

Done	Description	Indicates the function block has completed successfully
	Data type	BOOL
	Range	0, 1
	Unit	N/A
Busy	Description	Indicates this function block is executing
	Data type	BOOL
	Range	0, 1
	Unit	N/A
Error	Description	Indicates an invalid input was specified
	Data type	BOOL
	Range	0, 1
	Unit	N/A
ErrorID	Description	Indicates the error if the Error output is high
	Data type	INT
	Range	—
	Unit	N/A
CamTableID	Description	Indicates the ID number of the profile to be used with MC_CamIn
	Data type	INT
	Range	0 - 255
	Unit	N/A

2.2.5.5.3 Usage

- Each positive transition of the **Enable** input will create a unique Cam ID and store the profile information in a table. The number of unique Cam IDs is limited to 256. If the application attempts to create more than 256 Cam IDs, the **Error** output will be true and the **ErrorID** output will be 22 (**Too Many Profiles**). It is only necessary to call MC_CamTblSelect once for each Profile/Periodic/MasterAbsolute/SlaveAbsolute configuration to be used.
- The **Periodic** input selects if the profile is to repeat each cycle. If the profile is not periodic and the master axis moves beyond the profile range, the slave stops at the end of the profile.

NOTE

If the master axis moves back into the profile range, the slave resumes following the profile.

- If the **MasterAbsolute** input is ON, the profile is in reference to the Master axis position. If the MasterAbsolute input is OFF, the profile is in reference to the Master axis position at the time the MC_CamIn function block is executed.
- Similarly, the **SlaveAbsolute** input selects if the slave positions are in reference to the Slave axis position or the Slave axis position at the time the MC_CamIn function block is executed.

TIP

If the SlaveAbsolute input is set to TRUE, the axis jumps back to the starting position. If you set this input to FALSE, the axis will no longer jump back; but rather, as the profile repeats, the slave moves relative to the start of each period.

2.2.5.5.4 Related Functions

- [MC_CamIn](#)
- [MC_CamOut](#)

2.2.5.5.5 Example

2.2.5.5.5.1 Structured Text

```
(* MC_CamTblSelect ST example *) //call this function block every
scan until "Done"

Inst_MC_CamTblSelect(DoSelect, 'Profileb', TRUE, TRUE, TRUE ); //Inst_MC_
CamTblSelect is instance of MC_CamTblSelect
CamSelDone := Inst_MC_CamTblSelect.Done; //store Done output to user
defined variable
IF CamSelDone = TRUE THEN//when function block is "done" store
CamTableID := Inst_MC_CamTblSelect.CamTableID; //CamTableID in user
defined variable
END_IF;
```

See also how this function is used in the Hole punch project [here](#)

2.2.5.5.5.2 Ladder Diagram

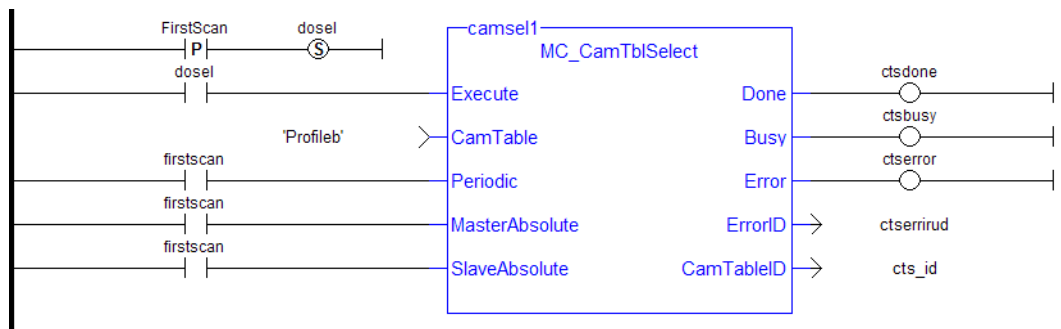

See also [MC_CamIn](#) for examples.

2.2.5.6 MC_GearIn PLCopen ✔

2.2.5.6.1 Description

This function block performs a slave axis move which follows the master axis based on the ratio specified by RatioNumerator and RatioDenominator.

```
SlaveCommandPosition = MasterActualPosition * RatioNumerator /
RatioDenominator
```

When this command is executed, the slave axis accelerates or decelerates (using the Acceleration, Deceleration, and Jerk) to the target velocity determined by the master axis velocity and the ratio. When the slave axis reaches a velocity within the "In Gear" bandwidth around the target velocity, it

locks on to the master, and the InGear output goes high. When the slave is locked to the master, the slave motion is no longer affected by the acceleration, deceleration, and jerk inputs.

For example if the "In Gear" bandwidth is set to 0.1 User Units per second, the InGear output will turn on if the slave velocity is within +/- 0.1 User Units per second of the target velocity.

The slave axis then continues to follow the master axis until this move is aborted.

Aborting Gearing

Gearing functions can generate large accelerations while following the master. If the aborting function block has small, non-zero Jerk, or small acceleration values, it can take a long time for an accelerating axis to reach the target velocity, or position of the aborting function block. If the Jerk and/or acceleration of the aborting function cannot be increased to suitable values, it may be desirable to:

- Abort the gearing function with an [MC_GearOut](#) with higher accelerations and/or Jerk values (or zero jerk value),
- Execute the next MC motion function block such as [MC_Halt](#).

Time to Reach the Target Velocity

While following the master, gearing functions can generate large accelerations. If the gearing function is aborted while the axis is currently accelerating, and the aborting function block has small non-zero Jerk or small acceleration values, it can take a long time to reach the target velocity, or position of the aborting function block. If the Jerk and/or acceleration of the aborting function cannot be increased to suitable values, it may be desirable to:

- Abort the gearing function with an [MC_GearOut](#) with higher accelerations and/or Jerk values (or zero jerk value),
- Execute the next MC motion function block such as [MC_Halt](#).

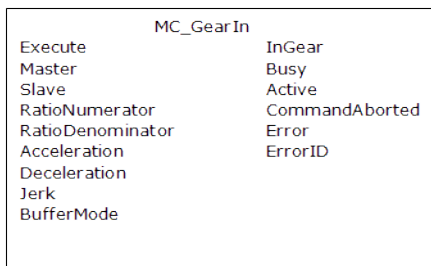
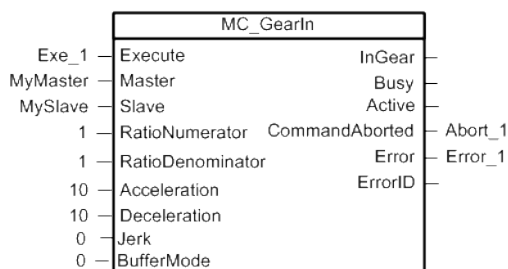
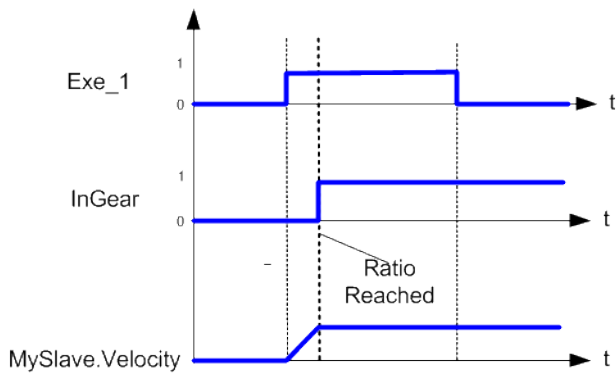

Figure 1-89: MC_GearIn

2.2.5.6.2 Time Diagram





NOTE

This function block starts a motion-related action and therefore stores data for calculations and error checking. Please see [Calling Function Blocks Multiple Times in the Same Cycle](#) if you are using a dual-core controller.

2.2.5.6.3 Arguments

2.2.5.6.3.1 Input

Execute	Description	Requests to queue the slave gear ratio move
	Data type	BOOL
	Range	0, 1
	Unit	N/A
	Default	—
Master	Description	Name of a declared instance of the AXIS_REF library function
	Data type	AXIS_REF
	Range	[1,256]
	Unit	N/A
	Default	—
Slave	Description	AXIS_REF.AXIS_NUM is the slave axis number
	Data type	AXIS_REF
	Range	[1,256]
	Unit	N/A
	Default	—
RatioNumerator	Description	Numerator of master/slave ratio
	Data type	DINT
	Range	[-2147483648, 2147483647]
	Unit	N/A
	Default	—

RatioDenominator	Description	Denominator of master/slave ratio
	Data type	DINT
	Range	[-2147483648, 2147483647]
	Unit	N/A
	Default	—
Acceleration	Description	Trapezoidal: Acceleration rate S-curve: Maximum acceleration
	Data type	LREAL
	Range	—
	Unit	User unit/sec ²
	Default	—
Deceleration	Description	Trapezoidal: Deceleration rate S-curve: Unused
	Data type	LREAL
	Range	—
	Unit	User unit/sec ²
	Default	—
Jerk	Description	Trapezoidal: 0 S-curve: Constant jerk
	Data type	LREAL
	Range	—
	Unit	User unit/sec ³
	Default	—
BufferMode	Description	0 = abort 1 = buffer
	Data type	SINT
	Range	[0,1]
	Unit	N/A
	Default	—

2.2.5.6.3.2 Output

InGear	Description	Indicates the slave axis is locked on to the master axis
	Data type	BOOL
Busy	Description	High from the moment the Execute input goes high until the time the move is ended

	Data type	BOOL
Active	Description	Indicates this move is the Active move
	Data type	BOOL
CommandAborted	Description	Indicates the move was aborted
	Data type	BOOL
Error	Description	Indicates an invalid input was specified or the move was terminated due to an error
	Data type	BOOL
ErrorID	Description	Indicates the error if Error output is set to TRUE
	Data type	INT

2.2.5.6.4 Example

2.2.5.6.4.1 Structured Text

```
(* MC_GearIn ST example *)
Inst_MC_GearIn( GearInReq, Axis1, Axis2, 2, 1, 150.0, 150.0, 0, 0 );
//Inst_MC_GearIn is an instance of MC_GearIn
```

See also how this function is used in the Hole punch project [here](#)

2.2.5.6.4.2 Ladder Diagram

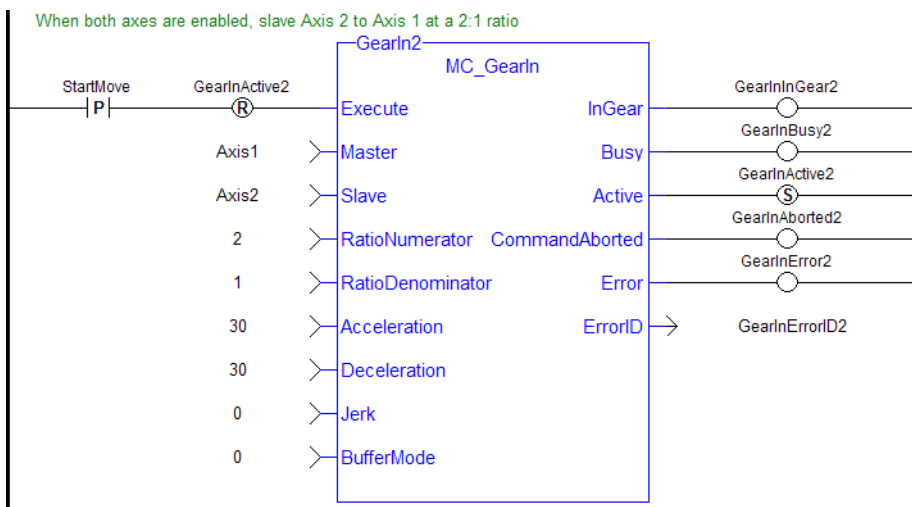

2.2.5.7 MC_GearInPos PLCopen ✔

2.2.5.7.1 Description

This function block performs a slave axis move which follows the master axis based on the ratio specified by RatioNumerator and RatioDenominator.

```
SlaveCommandPosition = MasterActualPosition * RatioNumerator /
RatioDenominator
```

This function block also allows the application to specify sync positions for the master and slave axes. It is the point in which the master and slave axes become engaged in synchronous motion. When the master axis reaches the MasterStartDistance from the MasterSyncPosition, the slave axis begins to accelerate to the target velocity determined by the master axis velocity and the ratio. The slave axis arrives at the target velocity and the SlaveSyncPosition at the same time the master axis arrives at the MasterSyncPosition. At that time, the slave is locked on to the master and follows the master at the ratio specified. The slave axis continues to follow the master axis until this move is aborted.

Aborting Gearing

Gearing functions can generate large accelerations while following the master. If the aborting function block has small, non-zero Jerk, or small acceleration values, it can take a long time for an accelerating axis to reach the target velocity, or position of the aborting function block. If the Jerk and/or acceleration of the aborting function cannot be increased to suitable values, it may be desirable to:

- Abort the gearing function with an [MC_GearOut](#) with higher accelerations and/or Jerk values (or zero jerk value),
- Execute the next MC motion function block such as [MC_Halt](#).

Time to Reach the Target Velocity

While following the master, gearing functions can generate large accelerations. If the gearing function is aborted while the axis is currently accelerating, and the aborting function block has small non-zero Jerk or small acceleration values, it can take a long time to reach the target velocity, or position of the aborting function block. If the Jerk and/or acceleration of the aborting function cannot be increased to suitable values, it may be desirable to:

- Abort the gearing function with an [MC_GearOut](#) with higher accelerations and/or Jerk values (or zero jerk value),
- Execute the next MC motion function block such as [MC_Halt](#).

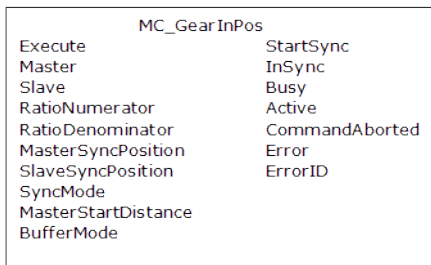
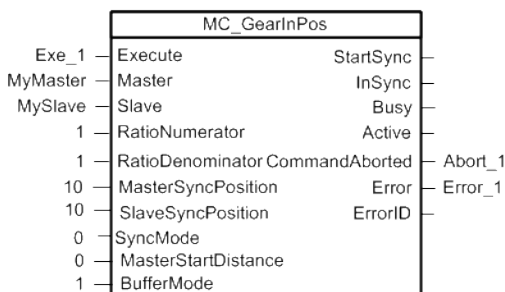
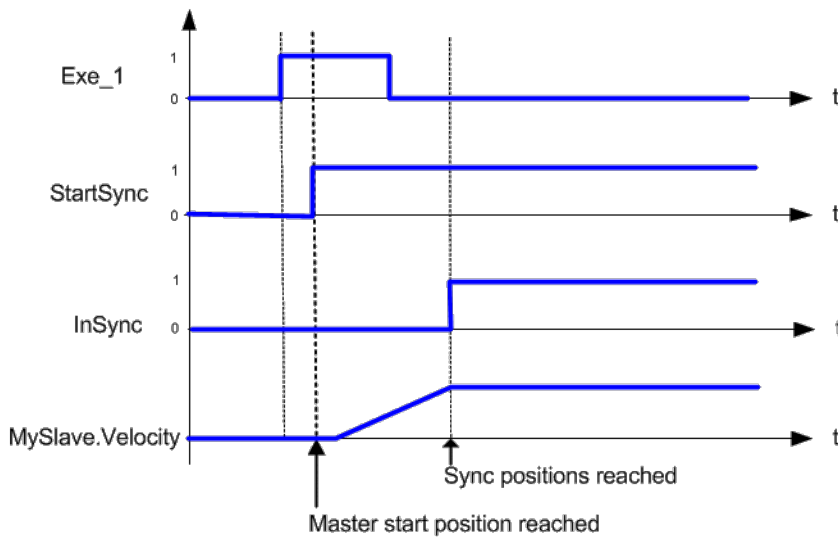

Figure 1-90: MC_GearInPos

2.2.5.7.2 Time Diagram





NOTE

This function block starts a motion-related action and therefore stores data for calculations and error checking. Please see [Calling Function Blocks Multiple Times in the Same Cycle](#) if you are using a dual-core controller.

2.2.5.7.3 Arguments

2.2.5.7.3.1 Input

Execute	Description	Requests to queue the slave gear ratio move
	Data type	BOOL
	Range	0, 1
	Unit	N/A
	Default	—
Master	Description	Name of a declared instance of the AXIS_REF library function (for more details,
	Data type	AXIS_REF
	Range	[1,256]
	Unit	N/A
	Default	—
Slave	Description	AXIS_REF.AXIS_NUM is the slave axis number
	Data type	AXIS_REF
	Range	[1,256]
	Unit	N/A
	Default	—
RatioNumerator	Description	Numerator of master/slave ratio. The sign (+ or -) indicates the direction for the slave axis.

	Data type	DINT
	Range	[-2147483648, 2147483647]
	Unit	N/A
	Default	—
RatioDenominator	Description	Denominator of master/slave ratio. The sign (+ or -) indicates the direction for the master axis. The direction determines the sync trigger comparison direction for the slave. <ul style="list-style-type: none"> • For a master moving in the positive direction, use a positive RatioDenominator. • For a master moving in the negative direction, use a negative RatioDenominator.
	Data type	DINT
	Range	[-2147483648, 2147483647]
	Unit	N/A
	Default	—
MasterSyncPosition	Description	Master axis sync position
	Data type	LREAL
	Range	-1.7 ³⁰⁸ to 1.7 ³⁰⁸ (14 to 15 significant digits of accuracy)
	Unit	N/A
	Default	—
SlaveSyncPosition	Description	Slave axis sync position
	Data type	LREAL
	Range	-1.7 ³⁰⁸ to 1.7 ³⁰⁸ (14 to 15 significant digits of accuracy)
	Unit	N/A
	Default	—

SyncMode	<p>Description SyncMode determines the allowed conditions for synchronization:</p> <p>0 = Normal synchronization. Prior to executing the MC_GearInPos function block, the <i>Master</i> axis position must be before the <i>MasterSyncPosition</i> by a distance greater than the <i>MasterStartDistance</i>. The <i>Slave</i> axis position must be before the <i>SlaveSyncPosition</i>. In the case of axes that have a non-zero rollover, the MC_GearInPos function block will always assume the axes meet these conditions by assuming the sync point is in the next occurrence of the sync position. <i>MasterStartDistance</i> must be positive and greater than the distance the master axis is currently moving per axis update. If the master start distance and the slave axis distance from the <i>SlaveSyncPosition</i> are sufficiently large enough, the slave axis will ramp to the sync position. If not sufficiently large enough, acceleration of the slave axis may be excessive.</p> <p>1 = Immediate synchronization allowed. This mode is only allowed if both the master and slave axes have rollover = 0. If the conditions of SyncMode = 0 are not met, Synchronization is allowed even though the axis positions may be beyond their respective Sync Positions. The <i>MasterStartDistance</i> may be 0. If the <i>MasterStartDistance</i> is zero, the Slave axis will synchronize with the master the instant the master axis crosses the <i>MasterSyncPosition</i>. If either the master or slave axis are beyond their respective sync start positions, the slave axis will immediately synchronize to the master axis. If the master start distance and the slave axis distance from the <i>SlaveSyncPosition</i> are sufficiently large enough, the slave axis will ramp to the sync position. If not sufficiently large enough or immediate synchronization occurs, slave axis acceleration may be excessive. Excessive slave acceleration may also occur if the master axis velocity is large or the master and slave axes have disproportionally different distances to their respective sync positions. If the slave axis is ahead of the master axis at the time of synchronization, the slave axis will move backwards.</p>
	<p>Data type INT</p>
	<p>Range 0-1</p>
	<p>Unit N/A</p>
	<p>Default —</p>

MasterStartDistance	Description	When the master axis reaches this distance before MasterSyncPosition, the slave axis begins its lock-on process.
		<p>ⓘ IMPORTANT</p> <p>The MasterStartDistance * (RatioNumerator/RatioDenominator) should be greater than (or equal to) the slave sync distance. The slave sync distance is defined as the distance between the slave position when MC_GearInPos executes and the SlaveSyncPosition. If the MasterStartDistance is too short, the MC_GearInPos may have excessive acceleration and a warning log message will be generated.</p>
	Data type	LREAL
	Range	1.7 ⁻³⁰⁸ to 1.7 ³⁰⁸ (14 to 15 significant digits of accuracy)
	Unit	User unit
	Default	—
BufferMode	Description	1 = buffer
	Data type	SINT
	Range	[1]
	Unit	N/A
	Default	—

2.2.5.7.3.2 Output

StartSync	Description	Indicates that the master axis has reached the MasterStartDistance from the MasterSyncPosition and the lock-on process has begun
	Data type	BOOL
InSync	Description	Indicated the slave axis is locked on to the master axis
	Data type	BOOL
Busy	Description	High from the moment the Execute input goes high until the time the move is ended
	Data type	BOOL
Active	Description	Indicates this move is the Active move
	Data type	BOOL
CommandAborted	Description	Indicates the move was aborted. If the abort arises because the inputs cause inconsistent motion, then this FB: <ul style="list-style-type: none"> • performs no motion • sets an error flag • set the ErrorID to 13

	Data type	BOOL
Error	Description	Indicates an invalid input was specified or the move was terminated due to an error
	Data type	BOOL
ErrorID	Description	Indicates the error if Error output is set to TRUE
	Data type	INT

2.2.5.7.4 Example

2.2.5.7.4.1 Example Description

- Master and Slave are rotary axes with rollovers at 360 degrees.
- The Master initial position is 0 degrees and the slave initial position is 45 degrees.
- The GearInPos FB commands the slave to accelerate up to the geared ratio (1:1) during the master start distance (90 degrees) and be synchronized with the master at the master and slave sync positions.

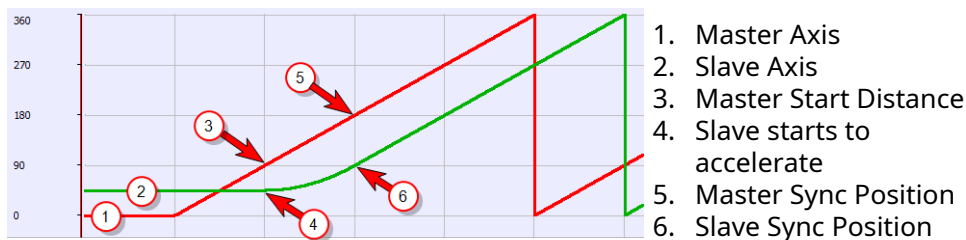
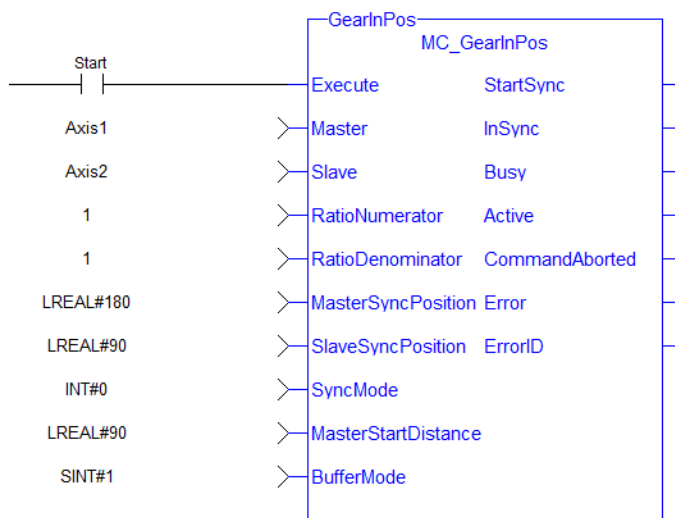

2.2.5.7.4.2 Structured Text

```
(* MC_GearInPos ST example *)

Inst_MC_GearInPos( GearInPosReq, Axis1, Axis2, 2, 1, 0, 0, 0, 100.0, 1 );
//Inst_MC_GearInPos is instance of MC_GearInPos
GearInPosSync:= Inst_MC_GearInPos.InSync;
//store InSync output into user defined variable
```

2.2.5.7.4.3 Ladder Diagram

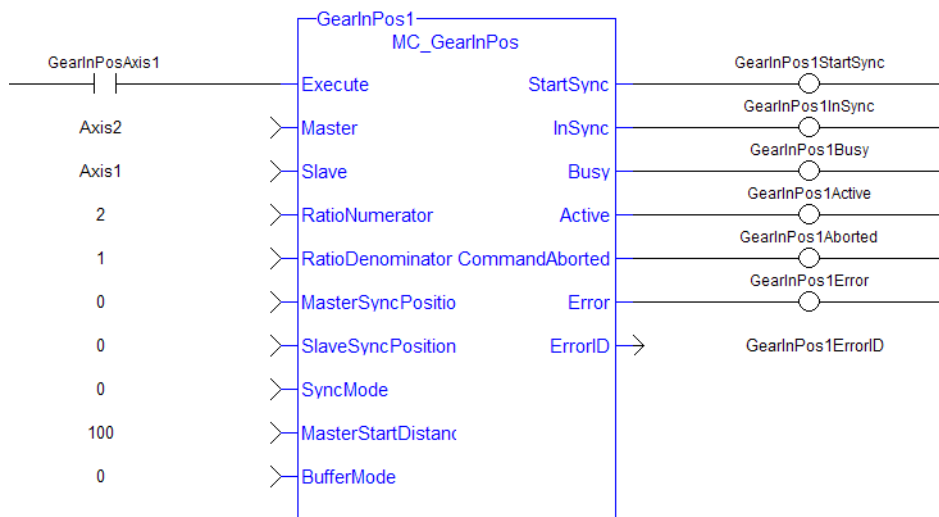

2.2.5.8 MC_GearOut PLCopen

2.2.5.8.1 Description

This function block:

- aborts the active MC_GearIn or MC_GearInPos move,
- disengages the axis from its master,
- and commands the axis to continue at its current velocity.

TIP

The current velocity is calculated by taking the average of the actual velocity during the previous 16 cycles.

Like a [MC_MoveVelocity](#) move, the control continues to command the axis to move at this velocity until this MC_GearOut move is aborted. The Acceleration, Deceleration and Jerk input parameters are applied if this command velocity is modified by the [MC_SetOverride](#) function block. If this function block is called and the active move is not a [MC_GearIn](#) or [MC_GearInPos](#) move, this function block returns an error and the active move is not aborted.

NOTE

The MC_GearOut is done when the slave axis is disengaged from the master axis. Once done, the MC_GearOut will remain busy and active until it is aborted by a different motion function block. This is different behavior than most other motion function blocks. The MC_GearOut function block represents an exception to the exclusivity rule as the **Done** and **Active** outputs may be true at the same time.

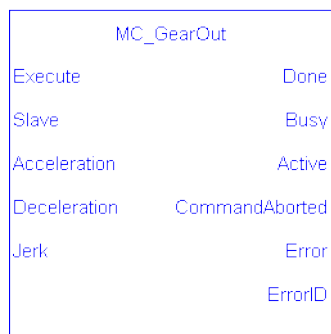

Figure 1-91: MC_GearOut

NOTE

This function block starts a motion-related action and therefore stores data for calculations and error checking. Please see [Calling Function Blocks Multiple Times in the Same Cycle](#) if you are using a dual-core controller.

2.2.5.8.2 Arguments**2.2.5.8.2.1 Input**

Execute	Description	Requests to disengage the slave axis from a MC_GearIn or MC_GearInPos move
	Data type	BOOL
	Range	0, 1
	Unit	N/A
	Default	—
Slave	Description	Name of a declared instance of the AXIS_REF library function
	Data type	AXIS_REF
	Range	[1,256]
	Unit	N/A
	Default	—
Acceleration	Description	Trapezoidal: Acceleration rate S-curve: Maximum acceleration
	Data type	LREAL
	Range	—
	Unit	User unit/sec ²
	Default	—
Deceleration	Description	Trapezoidal: Deceleration rate S-curve: Unused
	Data type	LREAL
	Range	—
	Unit	User unit/sec ²
	Default	—
Jerk	Description	Trapezoidal: 0 S-curve: Constant jerk
	Data type	LREAL
	Range	—
	Unit	User unit/sec ³

Default	—
----------------	---

2.2.5.8.2.2 Output

Done	Description	Indicates the axis is disengaged from its master
	Data type	BOOL
Busy	Description	Indicates the function is executing
	Data type	BOOL
Active	Description	Indicates this move is the Active move
	Data type	BOOL
CommandAborted	Description	Indicates the move was aborted
	Data type	BOOL
Error	Description	Indicates an invalid input was specified or no MC_GearIn or MC_GearInPos move is active
	Data type	BOOL
ErrorID	Description	Indicates the error if Error output is set to TRUE
	Data type	INT

2.2.5.8.3 Example

2.2.5.8.3.1 Structured Text

```

(* MC_GearOut ST example *)

Inst_MC_GearOut(ExecGearOut1,Axis1,GearOut1Acc,GearOut1Dec,GearOut1Jerk);
//Inst_MC_GearOut is instance of MC_GearOut
    
```

2.2.5.8.3.2 Ladder Diagram

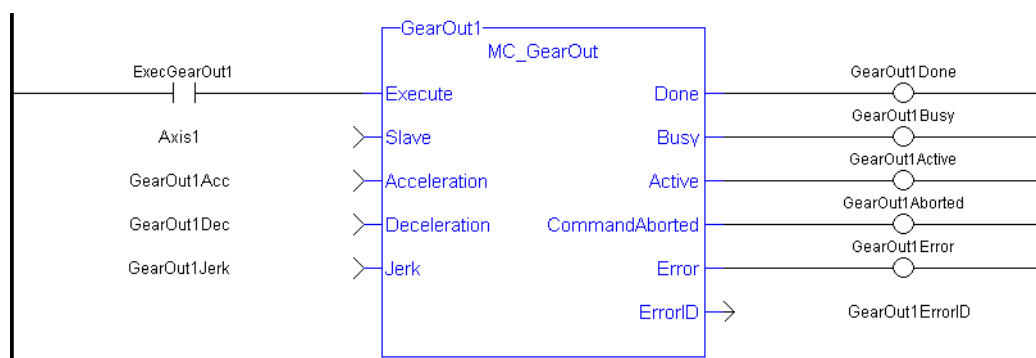

2.2.5.9 MC_Phasing PLCopen ✔

2.2.5.9.1 Usage

This function block:

- performs a master position phase shift for the slave axis
- provides a way to smoothly apply a master offset instead of writing values directly to the Master Offset Parameter 1002.
- is commonly used along with [MC_TouchProbe](#) for performing position corrections on the slave axis in a Mark to Mark registration application.

TIP

MC_Phasing performs a similar function to adjusting the MasterOffset input in the [MC_CamIn](#) function block but has the additional feature of setting the velocity, acceleration, deceleration, and jerk motion parameters.

2.2.5.9.2 Description

The MC_Phasing function block performs a master position phase shift for a slave axis. The distance entered at the **PhaseShift** input is iterated into the Slave axis’s Master Offset. This distance is iterated like a [MC_MoveRelative](#) move using the specified **Velocity**, **Acceleration**, **Deceleration**, and **Jerk** values. The difference is that the interpolated command delta is not commanded to the axis but is, instead, added to the Slave axis’s Master Offset. This will shift the Master axis’s position as viewed by the Slave axis, causing a change in the Slave axis’s physical position. This will only affect the Slave axis if it is executing a slave move. Subsequent calls to MC_Phasing can abort or blend to an executing MC_Phasing command.

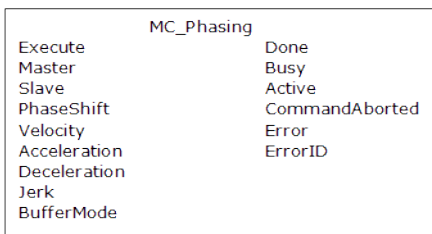

Figure 1-92: MC_Phasing

NOTE

This function block starts a motion-related action and therefore stores data for calculations and error checking. Please see [Calling Function Blocks Multiple Times in the Same Cycle](#) if you are using a dual-core controller.

2.2.5.9.3 Arguments

2.2.5.9.3.1 Input

Execute	Description	Requests to queue the phase shift
	Data type	BOOL
	Range	0, 1
	Unit	N/A
	Default	—
Master	Description	Name of a declared instance of the AXIS_REF library function.)
	Data type	AXIS_REF
	Range	[1,256]
	Unit	N/A

	Default	—
Slave	Description	AXIS_REF AXIS_NUM is the slave axis number
	Data type	AXIS_REF
	Range	[1,256]
	Unit	N/A
	Default	—
PhaseShift	Description	Amount of phase shift
	Data type	LREAL
	Range	—
	Unit	User unit
	Default	—
Velocity	Description	Velocity setpoint
	Data type	LREAL
	Range	—
	Unit	User unit/sec
	Default	—
Acceleration	Description	Trapezoidal: Acceleration rate S-curve: Maximum acceleration
	Data type	LREAL
	Range	—
	Unit	User unit/sec ²
	Default	—
Deceleration	Description	Trapezoidal: Deceleration rate S-curve: Unused
	Data type	LREAL
	Range	—
	Unit	User unit/sec ²
	Default	—
Jerk	Description	Trapezoidal: 0 S-curve: Constant jerk
	Data type	LREAL
	Range	—
	Unit	User unit/sec ³
	Default	—

BufferMode	Description	0. abort 1. buffer 2. blend to active 3. blend to next 4. blend to low velocity 5. blend to high velocity
	Data type	SINT
	Range	[0,5]
	Unit	N/A
	Default	—

2.2.5.9.3.2 Output

Done	Description	Indicates the phase shift has been completely applied
	Data type	BOOL
Busy	Description	High from the moment the Execute input is one-shot to the time the move is ended
	Data type	BOOL
Active	Description	Indicates this phase shift is the active phase shift
	Data type	BOOL
CommandAborted	Description	Indicates the move was aborted
	Data type	BOOL
Error	Description	Indicates an invalid input was specified or the move was terminated due to an error
	Data type	BOOL
ErrorID	Description	Indicates the error if Error output is set to TRUE
	Data type	INT

2.2.5.9.4 Example

2.2.5.9.4.1 Structured Text

```
(* MC_Phasing ST example *) //Inst_MC_Phasing is an instance of MC_
Phasing function block
Inst_MC_Phasing(PhasingAxis1, Axis2, Axis1, 1000.0,100.0, 200.0, 200.0,
0, 0 );
```

2.2.5.9.4.2 Ladder Diagram

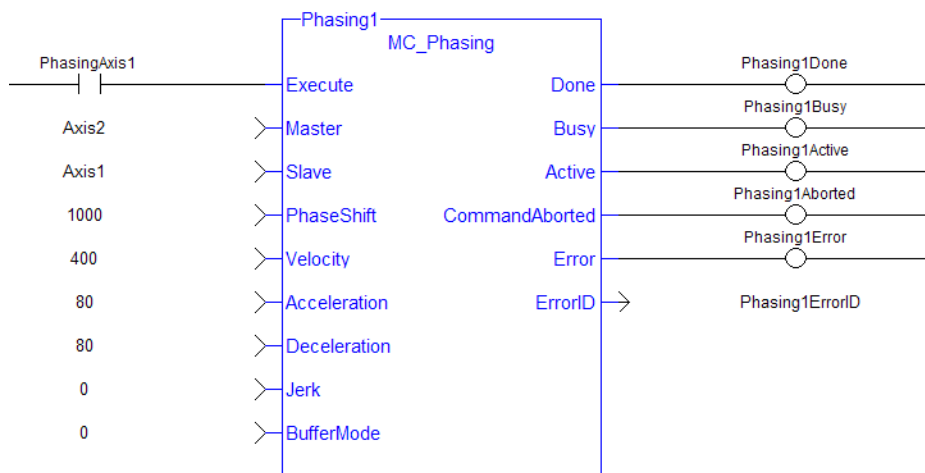

2.2.5.10 MC_SyncSlaves PLCopen

2.2.5.10.1 Description

This function block allows the application to specify what slave axes are to be synchronized and which master they follow. After this function block is executed successfully, all the slave axes specified at the SlaveList input start their slave moves (i.e. MC_GearIn, MC_CamIn, etc.) on the same servo interrupt for a synchronized slave start. When a slave move is commanded for one of the slave axes listed, the slave move is queued but the motion is held off until all of the listed slaves have queued their slave moves.

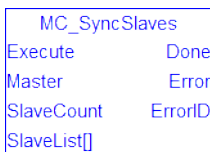

Figure 1-93: MC_SyncSlaves

NOTE
 This function block starts a motion-related action and therefore stores data for calculations and error checking. Please see [Calling Function Blocks Multiple Times in the Same Cycle](#) if you are using a dual-core controller.

2.2.5.10.2 Arguments

2.2.5.10.2.1 Input

Execute	Description	A positive transition of this input causes the function block to execute
	Data type	BOOL
	Range	0, 1
	Unit	N/A
	Default	—
Master	Description	Master axis identifier
	Data type	AXIS_REF
	Range	1 - 256

	Unit	N/A
	Default	—
SlaveCount	Description	The number of slave axes listed in the SlaveList array input that are to be synchronized. This number must not be greater than the declared size of the SlaveList array. If this number is 0, the list of synchronized slaves for the specified Master axis is cleared.
	Data type	AXIS_REF
	Range	1-256 The AXIS_NUM element of the AXIS_REF structure must be in the range [1-256]
	Unit	N/A
	Default	—
SlaveList	Description	The list of slave axes that are to be synchronized. Each element of this array contains a unique axis number. The axis number must not be the same as the Master axis number.
	Data type	UINT
	Range	1-32
	Unit	N/A
	Default	—

2.2.5.10.2.2 Output

Done	Description	Indicates the synchronized slave assignments were completed without error
	Data type	BOOL
Error	Description	Indicates an invalid input was specified
	Data type	BOOL
ErrorID	Description	Indicates the error if Error output is set to TRUE
	Data type	INT

2.2.5.10.3 Usage

Call MC_SyncSlaves to specify the slave axes to synchronize.

Call each slave move (e.g. MC_GearIn) for each slave axis. The motion is held off until all the slave moves have been queued.

After all the slave moves have been queued, the interpolation for all the slave axes begin on the same servo interrupt, providing a synchronized start.

The master axis can be in motion prior to this sequence, or the master can be commanded after all the slave moves are queued.

2.2.5.10.4 Related Functions

[MC_GearIn](#)

[MC_GearInPos](#)

[MC_CamIn](#)

2.2.5.10.5 Example

2.2.5.10.5.1 Structured Text

```
(* MC_SyncSlaves ST example *)
// Inst_MC_SyncSlaves is an instance of MC_SyncSlaves function
block
Inst_MC_SyncSlaves( SyncSlaves, Axis1, SlaveCount, SlaveList );
```

2.2.5.10.5.2 Ladder Diagram

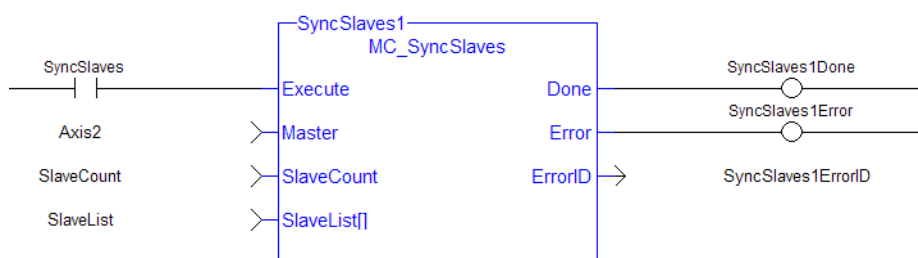

2.2.6 Reference Functions

This set of functions provides commands for reference points.

2.2.6.1 MC_Reference PLCopen

2.2.6.1.1 Description

This function block is used to execute a fast home to a switch. If the application selects to reference to the index mark of an encoder, or the null of a resolver (which is typical), the new position value is assigned to the position of the index of the encoder (or the null of the resolver) and not the position of the switch. The [ECATWriteSDO](#) function block is used to setup the trigger event and any desired preconditions. **This function block utilizes the Position Capture Mode of the AKD.**

NOTE

At this time, position capture is not available for PLCopen axes assigned to the secondary feedback input (digitizing axes). Therefore, MC_Reference cannot be used to home digitizing axes at this time.

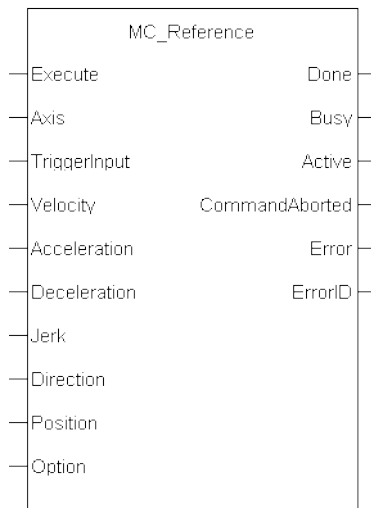

Figure 1-94: MC_Reference

TIP

There are a some differences between how an AKD and an AKD2G are used with this function block.

- [AKD Support With MC_TouchProbe](#)
- [AKD2G Support With MC_TouchProbe](#)

NOTE

This function block starts a motion-related action and therefore stores data for calculations and error checking. Please see [Calling Function Blocks Multiple Times in the Same Cycle](#) if you are using a dual-core controller.

2.2.6.1.2 Arguments

2.2.6.1.2.1 Input

Execute	Description	Requests to queue the MC_Reference move and arms reference trigger events
	Data type	BOOL
	Range	0, 1
	Unit	N/A
	Default	—
Axis	Description	Name of a declared instance of the AXIS_REF library function.)
	Data type	AXIS_REF
	Range	[1,256]
	Unit	N/A
	Default	—

TriggerInput	Description	TRIGGER_REF structure defines the trigger InputID INT : 0 = Touch Probe 1 / Capture Engine 0 1 = Touch Probe 2 / Capture Engine 1 Range is [0,1] Direction INT; 1 = rising edge of trigger, 2 = falling edge of trigger Trigid INT; must be zero
		NOTE TrigMode INT (TriggerInput.TrigMode) is not presently supported by this function. The TriggerInput.Mode may be supported in a future software version.
	Data type	TRIGGER_REF
	Range	See Description above
	Unit	N/A
	Default	—
Velocity	Description	Commanded velocity for the reference move
	Data type	LREAL
	Range	—
	Unit	User unit/sec
	Default	—
Acceleration	Description	Commanded acceleration for the reference move
	Data type	LREAL
	Range	—
	Unit	User unit/sec ²
	Default	—
Deceleration	Description	Commanded deceleration for the reference move
	Data type	LREAL
	Range	—
	Unit	User unit/sec ²
	Default	—
Jerk	Description	Commanded jerk for the reference move (if zero, then trapezoidal acc/dec is used)
	Data type	LREAL
	Range	—

	Unit	User unit/sec ³
	Default	—
Direction	Description	Commanded Direction of the reference
	Data type	SINT
	Range	[0,1]
	Unit	N/A
	Default	—
Position	Description	The position the axis will be reset to when at the machine reference location
	Data type	LREAL
	Range	—
	Unit	User unit
	Default	—
Option	Description	Option identifier for Resolvers/Modulo reference. 0 = Use latched position for reference 1 = use resolver position of nearest null for reference 2 pole resolver 2 = use resolver position of nearest null for reference 4 pole resolver 3 = use resolver position of nearest null for reference 6 pole resolver 4 = use resolver position of nearest null for reference 8 pole resolver 5 = use resolver position of nearest null for reference 10 pole resolver ... 15 = use resolver position of nearest null for reference 30 pole resolver
	Data type	SINT
	Range	[0,15]
	Unit	N/A
	Default	—

2.2.6.1.2.2 Output

Done	Description	Indicates the reference move and position adjustment is complete
	Data type	BOOL
Busy	Description	Indicates this function block is executing
	Data type	BOOL
Active	Description	Indicates this move is the Active move
	Data type	BOOL

CommandAborted	Description	Indicates the move was aborted
	Data type	BOOL
Error	Description	Indicates an invalid input, or the move was terminated due to an error
	Data type	BOOL
ErrorID	Description	Indicates the error if the Error output is high
	Data type	INT

2.2.6.1.3 Usage

The following lists the steps for homing a PLCopen axis, using the MC_Reference function block. Not all of the steps are necessary depending on the configuration and the homing cycle design.

The sequence of events of a PLCopen homing cycle consists of the following steps:

- Ensure Axis is not on Reference switch.
If a switch is used in the homing cycle for the event or precondition to the event, check to ensure the axis is not already tripping the switches that trigger the event and precondition. If it is, move the axis off the switches.
- Configure AKD capture engine
Configuration of the AKD capture engine is performed by writing drive CAN objects via SDO. It is accomplished with the [ECATWriteSdo](#) function. **The AKD Capture mode must be set to POSITION CAPTURE.**
The available configurations are discussed in [AKD Capture Engine Configuration](#) . Example AKD capture engine configurations and reference examples are discussed in [PLCopen Homing Methods](#).
- Call the MC_REFERENCE function to initiate optional homing motion and to arm the AKD capture engine
The MC_Reference function block selects the trigger edge (rising or falling edge) and arm the capture. Then, it optionally moves the axis to the reference location as directed by inputs to this function. When the AKD indicates that the capture event has occurred, the coordinate system is shifted so that the reference position input to this function block is set to the reference location. Then, the reference motion is stopped.
- Wait for the completion of the MC_Reference function block
The application is notified by the completion, abort or error of the homing by the MC_Reference function block.
- Upon completion of the MC_Reference function block, the axis can be moved to the home position with a [MC_MoveAbsolute](#) function block.

TIP

Once the MC_Reference block is queued, but before it is completed, the cycle can be aborted with a [MC_Halt](#) or [MC_Stop](#) function block or by queuing a new motion function block with the Abort selected for buffer mode.

2.2.6.1.4 Related Functions

[ECATWriteSdo](#)

[MC_MoveAbsolute](#)

2.2.6.1.5 Example

2.2.6.1.5.1 Structured Text

```
(* MC_Reference ST example *)
TriggerInput.InputID := 0; //configure the reference InputID
TriggerInput.DIRECTION := 1; //configure the reference direction
Inst_MC_Reference( RefReq, Axis1, TriggerInput, 20.0, 100.0, 100.0,
100.0, 0, 0.0, 0 );
```

2.2.6.1.5.2 Ladder Diagram

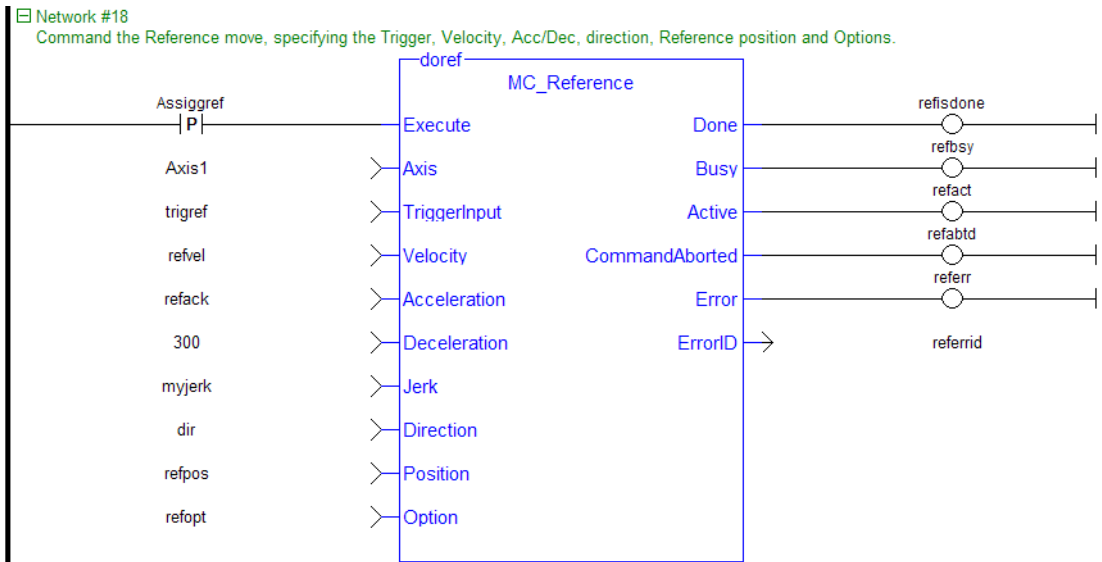

2.2.6.2 MC_SetPos PLCopen

2.2.6.2.1 Description

This function block changes the present actual position of the axis (as reported by [MC_ReadActPos](#)) to the position specified by the **Position** and **Mode** inputs. If a motor is associated with the axis, it will not move when MC_SetPos is executed. MC_SetPos does not cause any motion. It applies an offset to the command and actual positions.

MC_SetPos also sets the accumulated Superimposed distance value for the input axis to 0. See the table in [Axis Positions Data](#).

This function block replaces the MC_SetPosition function.

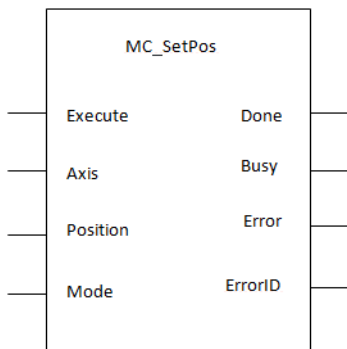

Figure 1-95: MC_SetPos

NOTE

This function or function block returns cached data. See [Programming a Dual Core Controller](#) for more information.

NOTE

This function block starts a motion-related action and therefore stores data for calculations and error checking. Please see [Calling Function Blocks Multiple Times in the Same Cycle](#) if you are using a dual-core controller.

2.2.6.2.2 Arguments

For more detail on how inputs and outputs work, refer to PLCopen Function Blocks - General Rules.

2.2.6.2.2.1 Inputs

Execute	Description	Requests to change the axis position
	Data type	BOOL
	Range	0,1
	Unit	N/A
	Default	—
Axis	Description	Name of a declared instance of the AXIS_REF library function. For more details Modify PLCopen Axis .
	Data type	AXIS_REF Structure
	Range	[1,256]
	Unit	N/A
	Default	—
Position	Description	Absolute Mode: New Axis Position to replace the present position. Relative Mode: Position offset to apply to present position (typically used with multiturn absolute position feedback devices).
	Data type	LREAL
	Range	—
	Unit	N/A
	Default	—
Mode	Description	LOW = Position input is an absolute position HIGH = Position input is a relative position
	Data type	BOOL
	Range	—
	Unit	N/A
	Default	—

2.2.6.2.2.2 Outputs

Done	Description	Indicates the reference move and position adjustment is complete
	Data type	BOOL

Busy	Description	Indicates this function block is executing
	Data type	BOOL
Error	Description	Indicates an invalid input, or the move was terminated due to an error
	Data type	BOOL
ErrorID	Description	Indicates the error if the Error output is high See table in PLCopen Function Block ErrorID Output
	Data type	INT

2.2.6.2.3 Example

2.2.6.2.3.1 Structured Text

```

(* MC_SetPos ST example *)

Inst_MC_SetPos ( Axis1 , 0 , 0 );
//Inst_MC_SetPos is an instance of MC_SetPos function

(* MC_SetPos absolute mode example: Set position value to zero. *)
Inst_MC_SetPos ( Axis1 , 0 , 0 );
//Inst_MC_SetPos is an instance of MC_SetPos function

(* MC_SetPos relative mode example: Increase position value by 1000. *)
Inst_MC_SetPos ( Axis1 , 1000 , 1 );
//Inst_MC_SetPos is an instance of MC_SetPos function
    
```

2.2.6.2.3.2 Ladder Diagram

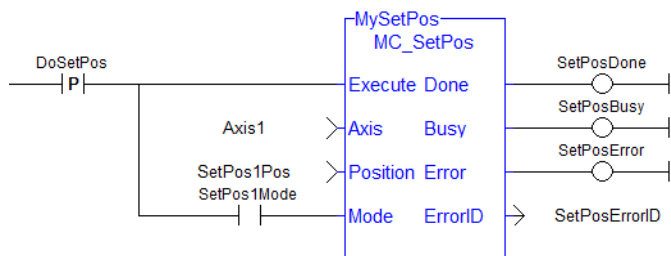

TIP

This function block finishes immediately. Due to finishing immediately, the **Done** output does not get set to false in a second call to the same MC_SetPos instance unless there is an error.

If your application needs to look for a state change to determine if a particular call to MC_SetPos was successful, then one should AND the rising edge of the **Execute** input, the **Done** output, and the inverse of the **Error** output.

The FFLD example below shows how this can be done. In the example, the 'SetPosSuccessful'

variable will be set to TRUE for one cycle upon a successful call to the MC_SetPos instance.

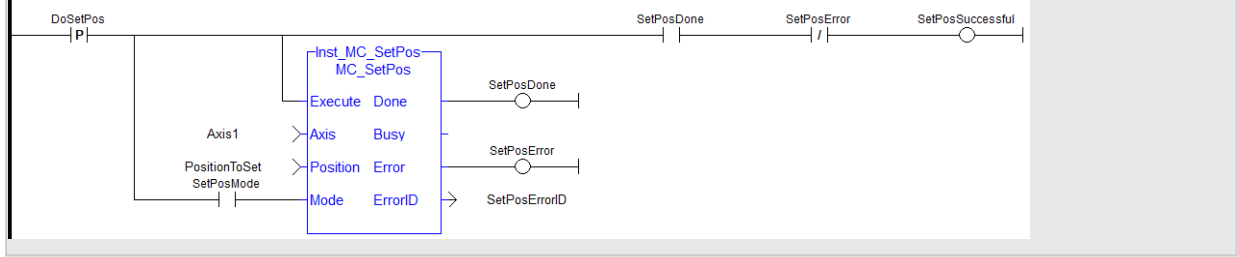

2.2.6.3 MC_SetPosition

2.2.6.3.1 Description

This function has been deprecated by the [MC_SetPos](#) function block.

2.2.7 Registration Function Blocks

This set of function blocks allow for Mark-to-Mark or Mark-to-Machine registration. See [Registration](#) for techniques on setting up and using the registration function blocks.

2.2.7.1 MC_MachRegist PLCopen

2.2.7.2 Description

This function block enables Mark-to-Machine registration and can be used on any servo or digitizing axis and with any move type. It is most frequently used in master/slave applications.

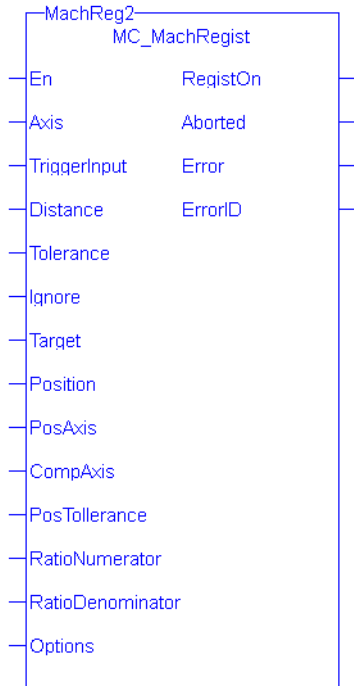

Used with ...	Effect
Non-slave moves	Resets the axis position when a good mark is captured by the fast input.

Used with ...	Effect
Slave moves	In addition to resetting the axis position, applies a compensation offset to correct for the difference between the target position and the measured position. This provides the ability to compensate for product or process inconsistencies providing a system that remains synchronized with no accumulated error and maintaining repeatable accuracy throughout the process.

- A positive transition of the **En** input will start registration. The application may change the registration parameters while registration is active by changing the input values and causing another positive transition of the En input. The function block will then read and apply the new values.
- The axis number at the **Axis** input indicates the axis whose position, at the fast input, is used to determine if the mark is a good mark.
- The **Distance**, **Tolerance**, and **Ignore** inputs are used to determine whether or not the registration mark is good. For a mark to be recognized as good, it must be outside of the Ignore distance and the correct Distance from the previous mark +/- the Tolerance window. A mark is considered bad if it occurs outside of the "good tolerance band" and is not ignored. Both good marks and bad marks are recognized as marks, ignored marks are not recognized. If all marks are to be recognized as good marks, enter 0 at both **Distance** and **Tolerance**.
- The **Distance** value defines the distance between good marks. In Clear Lane and Product registration the Distance input value typically is the same as the Target input value. However in Print registration the Distance is typically not the same as Target.
- The **Tolerance** value is the distance, plus and minus, about Distance. Marks that are detected within this window are considered good marks and registration will occur. Marks that are detected outside this window and outside the Ignore band, are considered bad marks and registration will not occur. This window should be large enough to allow for the worst case error in the distance between the previous mark and the current mark.
- The **Ignore** value defines the distance from the previous mark where all marks detected by the fast input will be ignored. This is crucial when registering products that do not have Clear Lane registration marks.
- The **Target** input is the expected target position that is used to calculate how much registration compensation is to be applied when a registration mark is considered good. When a good mark is detected, the position of the **PosAxis** is compared to the Target position to calculate a correction. The registration correction will only be applied with master/slave move types.
- The **Position** input is the position value that the registration Axis position will be reset to when a good registration mark is detected.
- When a good mark occurs the position of the **PosAxis** is compared to the Target position and used to calculate the amount of registration compensation to apply to the CompAxis.
- Registration compensation is applied to the axis specified at the **CompAxis** input under the following conditions. If CompAxis is executing a slave move (i.e. MC_GearIn or MC_CamIn), the compensation is applied directly to the axis. If CompAxis is a master axis, the compensation is applied to the master offsets of all its slaves. This shifts the master's position as seen by its slaves.
- The **PostTolerance** input is the distance, plus and minus, about the Target position used to determine if compensation will be applied. When a good mark occurs, the position of the **PosAxis** axis is checked to see if it lies within the window defined by PostTolerance. If it is in the window, compensation will be applied. If it is outside the window, compensation will not be applied even though a good mark was found.
- If **PosAxis** and **CompAxis** are different axes, the **RatioNumerator** and **RatioDenominator** inputs define the conversion factor for calculating the compensation value. This is needed because the amount of error between actual and target positions is determined by PosAxis's position and the compensation is applied to the CompAxis. The RatioNumerator should typically be the number of User Units of CompAxis motion for one registration cycle and the

RatioDenominator should typically be the number of User Units of PosAxis motion for one registration cycle. If PosAxis and CompAxis are the same, RatioNumerator and RatioDenominator should be the same value, thus resulting in a 1:1 ratio.

- The **Option** input defines various modes of operation for registration.
 - The first bit, 0001H, selects Absolute or Resetting. This refers to the way in which the second mark and all subsequent marks are determined to be good marks. With both registration schemes, the very first mark detected is the starting point. With Resetting registration, when the next mark is detected, the position of that mark becomes the starting point for the next good mark detection calculation and so on. The starting point is “reset” with each good or bad mark. This feature allows the product to re-synchronize, if necessary, due to process issues like product shift, etc. In contrast, Absolute registration determines all good marks based on the very first mark. The position of the second and each subsequent mark is compared to an integer multiple of Distance from the very first mark. This method insures the product will always register to a known fixed distance.
 - The third bit, 0004H, must always be 0. Mark-to-machine registration requires time-based capture.

NOTE

This function block starts a motion-related action and therefore stores data for calculations and error checking. Please see [Calling Function Blocks Multiple Times in the Same Cycle](#) if you are using a dual-core controller.

TIP

Is this the right function block to use? See [Deciding Which Function Blocks to Use for Registration and Registration Application Guide](#).

2.2.7.2.1 Arguments

2.2.7.2.1.1 Input

En	Description	Rising edge of EN enables execution
	Data type	BOOL
	Range	0, 1
	Unit	N/A
	Default	—
Axis	Description	Axis whose position is used to determine a good mark.
	Data type	Axis_Ref
	Range	The range of .AXIS_NUM is [1,256]
	Unit	N/A
	Default	N/A

TriggerInput	Description	Structure specifying the fast input. The structure elements are: InputID INT 0 = Touch Probe 1 / Capture Engine 0 1 = Touch Probe 2 / Capture Engine 1 Range is [0,1] Direction INT 1 = rising edge, 2 = falling edge, 3 = NA, 4 = toggle between both, falling edge first, 5 = toggle between both, rising edge first, range = [1,5] TrigID INT Axis number of the fast input. Zero indicates this trigger axis is to be the same as the Axis input. range = [0,256]
	NOTE	
	TrigMode INT (TriggerInput.TrigMode) is not presently supported by this function. The TriggerInput.Mode may be supported in a future software version.	
	Data type	TRIGGER_REF
	Range	
Unit		
Default		
Distance	Description	This is the expected distance between good marks. Along with Tolerance and Ignore, this value is used to determine if the mark detected by the fast input is a good mark.
	Data type	LREAL
	Range	When converted to feedback units, the range is $[-2^{51}, 2^{51}-1]$. This value must have the same sign as Ignore.
	Unit	user units
	Default	N/A
Tolerance	Description	This value specifies the distance, plus or minus, about Distance to determine if the mark detected by the fast input is a good mark.
	Data type	LREAL
	Range	When converted to feedback units, the range is $[0, 2^{51}-1]$
	Unit	user units
	Default	N/A
Ignore	Description	This value specifies the distance after the previous good mark in which any detected marks are ignored.
	Data type	LREAL
	Range	When converted to feedback units, the range is $[-2^{51}, 2^{51}-1]$. This value must have the same sign as Distance.

	Unit	user units
	Default	N/A
Target	Description	This is the target position. This position is compared to the actual position captured by the fast input to determine the amount of registration compensation to apply.
	Data type	LREAL
	Range	When converted to feedback units, the range is: <ul style="list-style-type: none"> [-251,251-1] if PosAxis' rollover value is zero [0, PosAxis' Rollover Value] if PosAxis' rollover value is non-zero (i.e., $\geq 0 < \text{PosAxis' Rollover Value}$)
	Unit	user units
	Default	N/A
Position	Description	The position the axis is set to when a good registration mark occurs. If the "Inhibit Reference on Good Mark" option is specified for the Option argument (see Options Table below), then this argument is not used and the position of the axis is not changed when a registration mark is encountered.
	Data type	LREAL
	Range	When converted to feedback units, the range is: <ul style="list-style-type: none"> [-251,251-1] if PosAxis' rollover value is zero [0, PosAxis' Rollover Value] if PosAxis' rollover value is non-zero (i.e., $\geq 0 < \text{PosAxis' Rollover Value}$)
	Unit	user units
	Default	N/A
PosAxis	Description	The position of this axis at the time the fast input occurs is compared to the Target position to determine the amount of registration compensation to apply.
	Data type	AXIS_REF
	Range	The range of .AXIS_NUM is [1,256]
	Unit	N/A
	Default	N/A
CompAxis	Description	The calculated registration compensation is applied to this axis.
	Data type	AXIS_REF
	Range	The range of .AXIS_NUM is [1,256]
	Unit	N/A

	Default	N/A	
PosTolerance	Description	This value specifies the distance, plus or minus, about the Target position to determine if the position will be accepted and compensation value is calculated and applied.	
	Data type	LREAL	
	Range	When converted to feedback units, the range is $[-2^{51}, 2^{51}-1]$	
	Unit	user units	
	Default	N/A	
RatioNumerator	Description	This value is typically the number of User Units of CompAxis motion for one product cycle. This value is used with RatioDenominator to create a conversion factor for calculating the compensation value when PosAxis and CompAxis are different axes.	
	Data type	DINT	
	Range	When converted to feedback units, the range is [1,4294967295]	
	Unit	user units	
	Default	N/A	
RatioDenominator	Description	This value is typically the number of User Units of PosAxis motion for one product cycle. This value is used with RatioNumerator to create a conversion factor for calculating the compensation value when PosAxis and CompAxis are different axes.	
	Data type	DINT	
	Range	When converted to feedback units, the range is [1,4294967295]	
	Unit	user units	
	Default	N/A	
Options	Description	Each bit enables/disables an option. The following table defines the bits. Any bits not defined are reserved. The third bit, 0004H, must be 0.	
	Data type	UINT	
	Range	refer to the following options table	
	Unit	N/A	
	Default	N/A	
Hexadecimal	Decimal	Option	Description
0001 H	1	Absolute/Resetting	0 = Resetting, 1 = Absolute
0002 H	2	Reserved	0

Hexadecimal	Decimal	Option	Description
0004 H	4	Time/position based capture	0 = time based capture, 1 = position based capture
0008 H	8	Inhibit Reference on Good Mark	0 = Perform reference, 1 = inhibit reference When this bit is set, the Position function block argument is unused and the axis position is not changed when a registration mark is encountered.
0010H	16	Inhibit Master Compensation	0 = Perform Master Compensation, 1 = Inhibit Master Compensation
0020H	32	Inhibit Slave Compensation	0 = Perform Slave Compensation, 1 = Inhibit Slave Compensation.

Table 1-2: MC_MachRegist Options Table

2.2.7.2.1.2 Outputs

RegistOn	Description	Indicates registration is activated
	Data type	BOOL
Aborted	Description	Indicates registration has been terminated by MC_StopRegist.
	Data type	BOOL
Error	Description	Indicates an invalid input was specified or registration was terminated due to an error
	Data type	BOOL
ErrorID	Description	Indicates the error if Error output is TRUE. See table in PLCopen Function Block ErrorID Output .
	Data type	INT

TIP

To use Capture Engine 1 modify the input PDOs that are used and add the Latch Position 1 parameter.

2.2.7.2.2 Related Functions

[MC_ReadParam](#)

[MC_StopRegist](#)

[MC_WriteParam](#)

2.2.7.2.3 Examples

2.2.7.2.3.1 Function Block

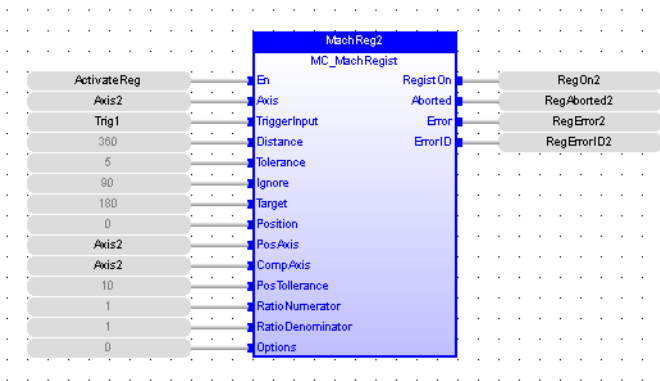

2.2.7.2.3.2 Instruction List

```
CAL Inst_MC_MachRegist( ActivateReg, Axis2, Trig1, 360, 5, 90, 180, 0, Axis2, Axis2, 5, 1, 1, 0 )
```

2.2.7.2.3.3 Ladder Diagram

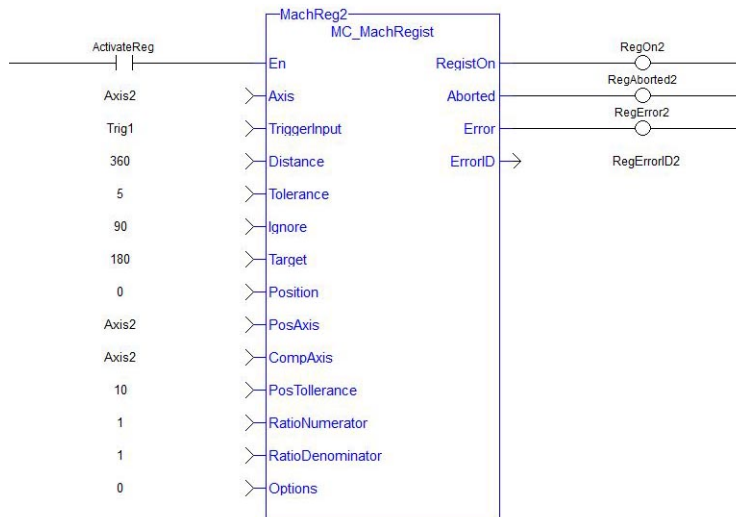

2.2.7.2.3.4 Structured Text

```
Inst_MC_MachRegist( ActivateReg, Axis2, Trig1, 360, 5, 90, 180, 0, Axis2, Axis2, 10, 1, 1, 0 );
```

2.2.7.3 MC_MarkRegist PLCopen

2.2.7.3.1 Description

This function block enables mark-to-mark registration and can be used on any servo or digitizing axis and with any move type. This function block is most frequently used in master/slave applications.

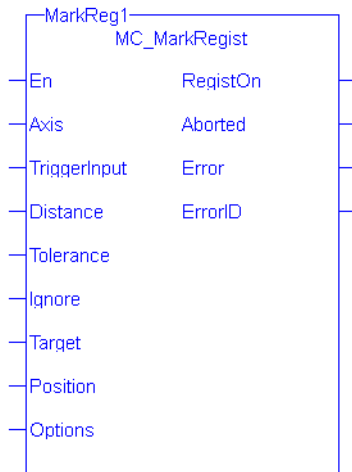

Used with ...	Effect
Non-slave moves	Resets the axis position when a good mark is captured by the fast input.
Slave moves	In addition to resetting the axis position, applies a compensation offset to correct for the difference between the target mark-to-mark distance and the measured mark-to-mark distance. This provides the ability to compensate for product or process inconsistencies providing a system that remains synchronized with no accumulated error and maintaining repeatable accuracy throughout the process.

- A positive transition of the **En** input will start registration. The application may change the registration parameters while registration is active by changing the input values and causing another positive transition of the En input. The function block will then read and apply the new values.
- The axis number at the **Axis** input identifies the axis of registration. If Axis is a master axis for another axis's slave move, Master Registration will be activated. Master Registration calculates a compensation that is added to the master offset of its slaves. This offset shifts the position of the master axis as seen by its slaves. The compensation is not applied to the master axis, but to its slaves. If Axis is a slave axis, Slave Registration will be activated. Slave Registration calculates a compensation that is added to the slave offset of the axis. This compensation value is applied directly to the slave axis.
- The **Distance**, **Tolerance**, and **Ignore** inputs are used to determine whether or not the registration mark is good. For a mark to be recognized as good, it must be outside of the Ignore distance and the correct Distance from the previous mark +/- the Tolerance window. A mark is considered bad if it occurs outside of the "good tolerance band" and is not ignored. Both good marks and bad marks are recognized as marks, ignored marks are not recognized. If all marks are to be recognized as good marks, enter 0 at both **Distance** and **Tolerance**.
- The **Distance** value defines the distance between good marks. In Clear Lane and Product registration the Distance input value typically is the same as the **Target** input value. However in Print registration the Distance is typically not the same as Target.
- The **Tolerance** value is the distance, plus and minus, about **Distance**. Marks that are detected within this window are considered good marks and registration will occur. Marks that are detected outside this window and outside the Ignore band, are considered bad marks and registration will not occur. This window should be large enough to allow for the worst case error in the distance between the previous mark and the current mark.
- The **Ignore** value defines the distance from the previous mark where all marks detected by the fast input will be ignored. This is crucial when registering products that do not have Clear Lane registration marks.
- The **Target** input is the expected distance between good registration marks and is used to calculate how much registration compensation is to be applied when a registration mark is

considered good. In many applications this is often equivalent to the product length or the cycle length. When a good mark is detected, the actual distance between the good mark and the previous mark is determined and compared to the Target distance to calculate a correction. The registration correction will only be applied with master/slave move types and always affects the slave axis.

- The **Position** input is the position value that the registration Axis position will be reset to when a good registration mark is detected.
- The **Option** input defines various modes of operation for registration. The first bit, 0001H, selects Absolute or Resetting. This refers to the way in which the second mark and all subsequent marks are determined to be good marks. With both registration schemes, the very first mark detected is the starting point. With Resetting registration, when the next mark is detected, the position of that mark becomes the starting point for the next good mark detection calculation and so on. The starting point is “reset” with each good or bad mark. This feature allows the product to re-synchronize, if necessary, due to process issues like product shift, etc. In contrast, Absolute registration determines all good marks based on the very first mark. The position of the second and each subsequent mark is compared to an integer multiple of Distance from the very first mark. This method insures the product will always register to a known fixed distance.

NOTE

This function block starts a motion-related action and therefore stores data for calculations and error checking. Please see [Calling Function Blocks Multiple Times in the Same Cycle](#) if you are using a dual-core controller.

TIP

Is this the right function block to use? See [Deciding Which Function Blocks to Use for Registration and Registration Application Guide](#).

2.2.7.3.2 Arguments

2.2.7.3.2.1 Input

En	Description	Rising edge of EN enables execution
	Data type	BOOL
	Range	0, 1
	Unit	N/A
	Default	—
Axis	Description	Axis to apply registration to
	Data type	AXIS_REF
	Range	The range of .AXIS_NUM is [1,256]
	Unit	N/A
	Default	N/A

TriggerInput	Description	Structure specifying the fast input. The structure elements are: InputID INT 0 = Touch Probe 1 / Capture Engine 0 1 = Touch Probe 2 / Capture Engine 1 Range is [0,1] Direction INT 1 = rising edge, 2 = falling edge, 3 = NA, 4 = toggle between both, falling edge first, 5 = toggle between both, rising edge first, range = [1,5] TrigID INT Axis number of the fast input. Zero indicates this trigger axis is to be the same as the Axis input. range = [0,256]
		NOTE
		TrigMode INT (TriggerInput.TrigMode) is not presently supported by this function. The TriggerInput.Mode may be supported in a future software version.
	Data type	TRIGGER_REF
	Range	
	Unit	
	Default	
Distance	Description	This is the expected distance between good marks. Along with Tolerance and Ignore, this value is used to determine if the mark detected by the fast input is a good mark.
	Data type	LREAL
	Range	When converted to feedback units, the range is $[-2^{51}, 2^{51}-1]$. This value must have the same sign as Ignore.
	Unit	user units
	Default	N/A
Tolerance	Description	This value specifies the distance, plus or minus, about Distance to determine if the mark detected by the fast input is a good mark.
	Data type	LREAL
	Range	When converted to feedback units, the range is $[0, 2^{51}-1]$
	Unit	user units
	Default	N/A
Ignore	Description	This value specifies the distance after the previous good mark in which any detected marks are ignored.
	Data type	LREAL

	Range	When converted to feedback units, the range is $[-2^{51}, 2^{51}-1]$. This value must have the same sign as Distance.
	Unit	user units
	Default	N/A
Target	Description	This is the target distance between good marks. This distance is compared to the actual distance measured by the fast input to determine the amount of registration compensation to apply.
	Data type	LREAL
	Range	When converted to feedback units, the range is $[-2^{51}, 2^{51}-1]$. This value must have the same sign as Distance.
	Unit	user units
	Default	N/A
Position	Description	The position the axis is set to when a good registration mark occurs. If the "Inhibit Reference on Good Mark" option is specified for the Option argument (see Options Table below), then this argument is not used and the position of the axis is not changed when a registration mark is encountered.
	Data type	LREAL
	Range	When converted to feedback units, the range is: <ul style="list-style-type: none"> • $[-251, 251-1]$ if PosAxis' rollover value is zero • $[0, \text{PosAxis' Rollover Value}]$ if PosAxis' rollover value is non-zero (i.e., $\geq 0 < \text{PosAxis' Rollover Value}$)
	Unit	user units
	Default	N/A
Options	Description	Each bit enables/disables an option. The following table defines the bits. Any bits not defined are reserved.
	Data type	UINT
	Range	Refer to the following options table.
	Unit	N/A
	Default	N/A

Hexadecimal	Decimal	Option	Description
0001 H	1	Absolute/Resetting	0 = Resetting, 1 = Absolute
0002 H	2	Reserved	0
0004 H	4	Time/position based capture	0 = time based capture, 1 = position based capture

Hexadecimal	Decimal	Option	Description
0008 H	8	Inhibit Reference on Good Mark	0 = Perform reference, 1 = inhibit reference When this bit is set, the Position function block argument is unused and the axis position is not changed when a registration mark is encountered.
0010H	16	Inhibit Master Compensation	0 = Perform Master Compensation, 1 = Inhibit Master Compensation
0020H	32	Inhibit Slave Compensation	0 = Perform Slave Compensation, 1 = Inhibit Slave Compensation.

Table 1-3: MC_MarkRegist Options Table.

TIP

To use Capture Engine 1 modify the input PDOs that are used and add the Latch Position 1 parameter.

2.2.7.3.2.2 Outputs

RegistOn	Description	Indicates that registration is active.
	Data type	BOOL
Aborted	Description	Indicates registration has been terminated by MC_StopRegist.
	Data type	BOOL
Error	Description	Indicates an invalid input was specified or registration was terminated due to an error
	Data type	BOOL
ErrorID	Description	Indicates the error if Error output is TRUE. See table in PLCopen Function Block ErrorID Output .
	Data type	INT

2.2.7.3.3 Related Functions

[MC_ReadParam](#)

[MC_Stop](#)

[MC_WriteParam](#)

2.2.7.3.4 Examples

2.2.7.3.4.1 Function Block

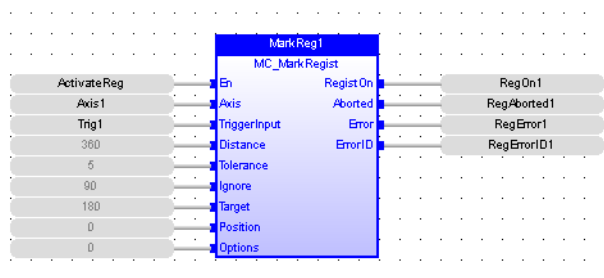

2.2.7.3.4.2 Instruction List

```
CAL Inst_MC_MarkRegist( ActivateReg, Axis1, Trig1, 360, 5, 90, 360, 0, 0 )
```

2.2.7.3.4.3 Ladder Diagram

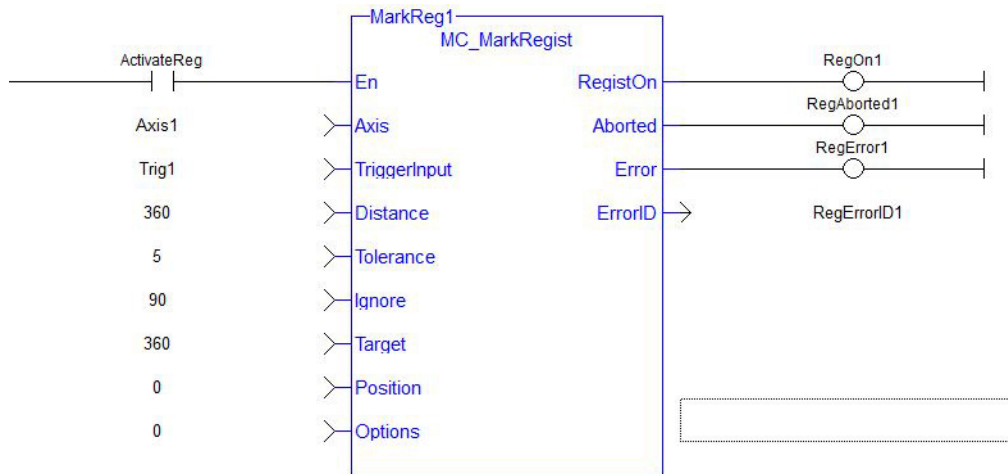

2.2.7.3.4.4 Structured Text

```
Inst_MC_MarkRegist( ActivateReg, Axis1, Trig1, 360, 5, 90, 360, 0, 0 );
```

2.2.7.4 MC_StopRegist PLCopen

2.2.7.4.1 Description

This function will turn off registration for the specified axis and disarm the specified fast input.



NOTE
This function or function block returns cached data. See [Programming a Dual Core Controller](#) for more information.

2.2.7.4.2 Arguments

2.2.7.4.2.1 Input

En	Description	Enables execution
	Data type	BOOL
	Range	0, 1
	Unit	N/A
	Default	—
Axis	Description	Axis registration to turn off
	Data type	AXIS_REF
	Range	The range of .AXIS_NUM is [1,256]

	Unit	N/A
	Default	N/A
TriggerInput	Description	<p>Structure specifying the fast input to disarm. The structure elements are:</p> <p>InputID INT 0 = Touch Probe 1 / Capture Engine 0 1 = Touch Probe 2 / Capture Engine 1 Range is [0,1]</p> <p>Direction INT 1 = rising edge, 2 = falling edge, 3 = NA, 4 = toggle between both, falling edge first, 5 = toggle between both, rising edge first, range = [1,5]</p> <p>TrigID INT Axis number of the fast input. 0 indicates this trigger axis is to be the same as the Axis input. range = [0,256]</p> <div style="border: 1px solid black; background-color: #f0f0f0; padding: 5px; margin-top: 10px;"> <p style="text-align: center;">NOTE</p> <p>TrigMode INT (TriggerInput.TrigMode) is not presently supported by this function. The TriggerInput.Mode may be supported in a future software version.</p> </div>
	Data type	TRIGGER_REF
	Range	
	Unit	
	Default	

2.2.7.4.2.2 Outputs

OK	Description	Indicates function executed successfully
	Data type	BOOL

TIP

To use Capture Engine 1 modify the input PDOs that are used and add the Latch Position 1 parameter.

2.2.7.4.3 Related Functions

[MC_MachRegist](#)

[MC_MarkRegist](#)

2.2.7.4.4 Examples

2.2.7.4.4.1 Function Block

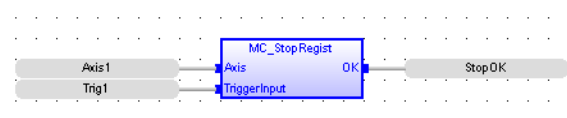

2.2.7.4.4.2 Ladder Diagram

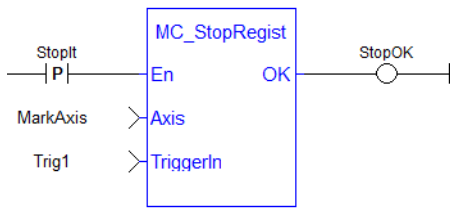

2.2.7.4.4.3 Structured Text

```
StopOK := MC_StopRegister( Axis1, Trig1);
```

2.2.8 Superimposed Axes

This feature allows the application program to superimpose the moves of multiple axes ("Superimposed Axes") on top of the move of another axis ("Receiving Axis"). This is performed internally by adding the command deltas of the Superimposed Axes to the command delta of the Receiving Axis. Up to four different Superimposed Axes can be superimposed upon a Receiving Axis.

See [MC_AddSuperAxis](#), [MC_RemSuperAxis](#) and [PLCopen Function Blocks - Overview](#) for more information.

2.2.8.1 MC_AddSuperAxis PLCopen

This function will add a Superimposed Axis to the Axis's list of assigned superimposed axes. While the Superimposed Axis is on this list, its command deltas will be added to the Axis's command deltas. Up to four different superimposed axes can be on an axis's list. The `Axis` and the `SuperimposedAxis` must have the same update rate. The `OK` output will go high to indicate that the function executed successfully. If the `OK` output does not go high, one of the following errors was detected:

- Axis and SuperimposedAxis do not have the same update rate
- Four different superimposed axes have already been assigned to Axis
- Axis is not a valid axis - Axis is not a servo or virtual axis
- SuperimposedAxis is not a valid axis number
- SuperimposedAxis is not a servo or virtual axis
- Axis could not acquire PLC motion engine lock

NOTE

This function or function block returns cached data. See [Programming a Dual Core Controller](#) for more information.

2.2.8.1.1 Inputs

En	Description	Enables Execution
	Data Type	BOOL
	Range	N/A
	Unit	N/A
	Default	N/A

Axis	Description	Axis to receive the additional superimposed axis's command delta
	Data Type	AXIS_REF
	Range	.AXIS_NUM [1,256]
	Unit	N/A
	Default	N/A
SuperimposedAxis	Description	Axis number of the superimposed axis whose command delta will be added to delta of <code>Axis</code>
	Data Type	UINT
	Range	[1,256]
	Unit	N/A
	Default	N/A

2.2.8.1.2 Outputs

OK	Description	Execution successful
	Data Type	BOOL
	Range	N/A

2.2.8.1.3 Examples

2.2.8.1.3.1 Structured Text

```
AddOKST := MC_AddSuperAxis( Axis1, 3 );
```

2.2.8.1.3.2 Function Block Diagram



2.2.8.1.3.3 Ladder Diagram

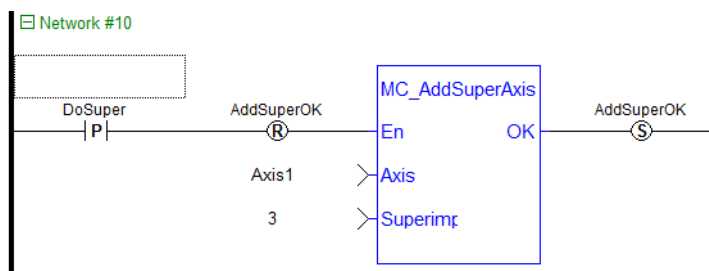

2.2.8.1.4 Related Functions

[MC_RemSuperAxis](#)

2.2.8.2 MC_RemSuperAxis PLCopen

This function removes the Superimposed Axis from the Axis's list of assigned superimposed axes. If the value at `SuperimposedAxis` is 0 all the assigned superimposed axes will be removed from Axis's list. The `OK` output will go high to indicate that the function executed successfully. If the `OK` output does not go high, one of the following errors was detected:

- Axis is not a valid axis
- Axis is not a servo or virtual axis

NOTE

This function or function block returns cached data. See [Programming a Dual Core Controller](#) for more information.

2.2.8.2.1 Inputs

En	Description	Enables Execution
	Data Type	BOOL
	Range	-
	Unit	N/A
	Default	
Axis	Description	Axis whose list of assigned superimposed axes will be updated.
	Data Type	AXIS_REF
	Range	.AXIS_NUM [1,256]
	Unit	N/A
	Default	N/A
SuperimposedAxis	Description	Axis number of the superimposed axis that will be removed from Axis's list of assigned superimposed axes. A value of 0 will remove all superimposed axes from Axis's list.
	Data Type	UINT
	Range	N/A
	Unit	N/A
	Default	N/A

2.2.8.2.2 Outputs

OK	Description	Execution successful
	Data Type	BOOL
	Range	N/A

2.2.8.2.3 Examples

2.2.8.2.3.1 Structured Text

```
RemOK := MC_RemSuperAxis(Axis1, 3);
```

2.2.8.2.3.2 Function Block Diagram

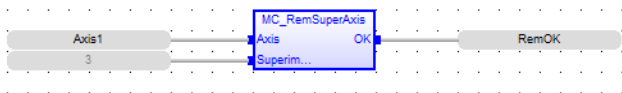

2.2.8.2.3.3 Ladder Diagram

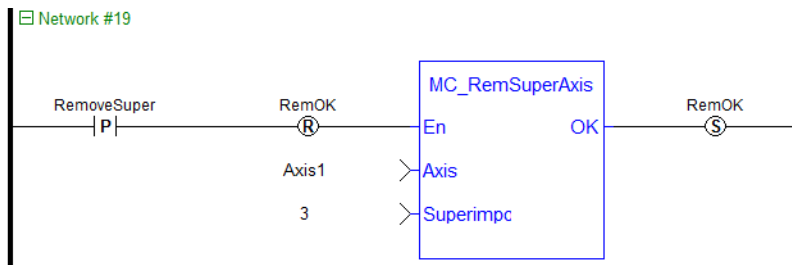

2.2.8.2.4 Related Functions

[MC_AddSuperAxis](#)

2.3 Motion Library- Common

Functions sorted in alphabetical order.

Name	Description	Return type
MC_ErrorDescription	Return a text description corresponding to a motion control error ID code	STRING
MLMotionCycleTime	Returns the Motion Base Cycle time in Seconds	
MLMotionInit	Initializes the motion library. Must be called before any other Motion Library function. Returns TRUE if the function succeeded. BasePeriod is the duration of one motion cycle in microseconds.	BOOL
MLMotionRstErr	Clears motion engine errors, motion bus driver errors, and EtherCAT network errors. MLMotionRstErr will return the motion engine status to the Stopped state, if an error condition was cleared successfully. Returns TRUE if the function succeeded.	BOOL
MLMotionStart	Starts the motion engine, motion bus driver, and initializes EtherCAT network to operational mode. Applicable to PLCopen and PipesNetwork motion engines. Returns TRUE if the function succeeded.	BOOL
MLMotionStatus	Returns the status of the motion engine 0: Not initialized 1: Running 2: Stopped 3: Error	None
MLMotionStop	Stops the motion bus driver, motion engine, and EtherCAT network operation, resulting in the EtherCAT network transitioning to the Init state. Returns TRUE if the function succeeded.	BOOL
MLMotionSysTime	Prints the system time to the log	BOOL
MLProfileBuild	Builds a cam profile from application data	See Output
MLProfileCreate	Creates a new cam profile object	None
MLProfileInit	Initializes a previously created cam profile object	BOOL

Name	Description	Return type
MLProfileRelease	Removes a Profile so the Profile ID may be used by a different or new Profile.	See Output

2.3.1 Motion Library - Common - Info

Name	Description	Return type
MC_ErrorDescription	Converts the PLCopen error IDs into message strings.	String

2.3.1.1 MC_ErrorDescription PLCopen ✓ Pipe Network ✓

This function converts the PLCopen error IDs into message strings which can be used for display or logging.

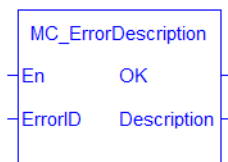

Figure 1-96: MC_ErrorDescription Function Block

2.3.1.1.1 Arguments

2.3.1.1.1.1 Inputs

En	Description	If True, then this function will convert the Error Id into a string message
	Data type	BOOL
	Range	0, 1
	Unit	N/A
	Default	—
ErrorID	Description	Error ID generated from a PLCopen Function Block. See PLCopen Function Block ErrorID Output for output details.
	Data type	INT
	Range	0,69
	Unit	N/A
	Default	—

2.3.1.1.1.2 Outputs

OK	Description	If True, then the command completed successfully.
	Data type	BOOL
	Range	0, 1

	Unit	N/A
	Default	—
Description	Description	String error description
	Data type	STRING
	Range	—
	Unit	N/A
	Default	—

2.3.1.1.2 Examples

2.3.1.1.2.1 Structured Text

```

Description := MC_ErrorDescription(ErrorID);
    
```

2.3.1.1.2.2 IL

Not applicable

2.3.1.1.2.3 Function Block



2.3.1.1.2.4 Ladder Diagram

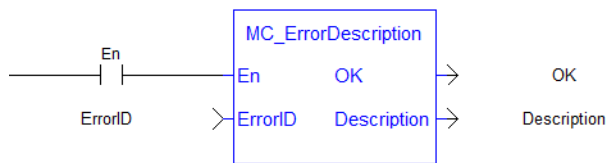

2.3.2 Motion Library - Common - Profiles

Name	Description	Return type
MLProfileBuild	Builds a cam profile from application data	See Output
MLProfileCreate	Creates a new cam profile object	None
MLProfileInit	Initializes a previously created cam profile object	BOOL
MLProfileRelease	Removes a Profile so the Profile ID may be used by a different or new Profile.	See Output

2.3.2.1 MLProfileBuild PLCopen ✓ Pipe Network ✓

2.3.2.1.1 Description

This Function Block allows the application to create a cam profile that may be executed by a cam block in PipeNetwork or PLCopen. This Function Block will take input as cam data (see [Cam Profile Editor's Cam Table](#) for information) and profile properties from application data memory and compile the input data to a form the controller can use to calculate cam positions. The input cam

data and profile properties are similar to the cam data entered in the IDE's Cam Editor and the runtime's Cam Profile Properties dialog. MLProfileBuild internally perform two functions:

1. Compile the cam data (like the cam editor performs in the IDE).
2. Puts the compiled profile into the profile object so it can be used by other Profile Function Blocks (provides similar functionality to [MLProfileInit](#)).

NOTE

Prior to using MLProfileBuild you must call [MLProfileCreate](#) to create the profile object. The ID output of MLProfileCreate is then used as the ProfileID input to MLProfileBuild. MLProfileCreate must be performed in the application *before* the [MLMotionStart](#) command is executed.

MLProfileBuild will compile the cam profile data specified at the CamData input and write the resulting profile to the CAM Profile object specified at input ProfileID. The created profile can then be used as an input to PLCopen Cam Function Blocks ([MC_CamTblSelect](#), [MC_CamIn](#), [MC_CamOut](#)), or any Pipe network Cam Profile Function/Function Blocks. When the operation is complete, the Done output will go high. If an error is encountered, the Error output will go high and the ErrorID output will return a error code. If the Error can be attributed to a specific profile element in the CamData array, ErrorElem will attempt to indicate the element in error.

2.3.2.1.1.1 CamProps_Ref Structure

The cam properties structure (CamProps_Ref) will contain the following data members:

Parameter	Type	Description
InputScale	LREAL	The input amplitude or master axis multiplier applied to the CAM profile
OutputScale	LREAL	The output amplitude or slave axis multiplier applied to the CAM profile
InputOffset	LREAL	input offset or master axis shift applied to the CAM profile
OutputOffset	LREAL	The output offset or slave axis shift applied to the CAM profile

See [Master/Input offset](#) for more information about the parameters which transform the cam profile.

2.3.2.1.1.2 CamData_Ref Structure

The Cam_Data function block input will be an array of CamData_Ref structures. Each element of the structure will contain the following data members:

Parameter	Type	Description
MasterIn	LREAL	master position (in the unit range [0 - InputScale])
SlaveOut	LREAL	slave position (in the unit range [0 - OutputScale])
SegType	UINT	<p>Defines the segment type for the segment following the master positions defined by MasterIn.</p> <ol style="list-style-type: none"> 1. CAM_SEGMENT_TYPE_POINT = Point 5th order polynomial) 2. CAM_SEGMENT_TYPE_LINE = Line (constant velocity segment) 3. CAM_SEGMENT_TYPE_PARABOLIC = Parabolic (constant acceleration) <p>See Cam Profile Segment Overview for information on the segment types.</p>

Parameter	Type	Description
Vel	LREAL	Cam velocity at the master position specified by MasterIn . Units: (slave position user units) / (master position user units)
Accel	LREAL	<p><u>For CAM_SEGMENT_TYPE_POINT:</u></p> <p>Accel represents the cam acceleration at the master position specified by MasterIn. Units: (slave position user units) / (master position user units)</p> <p><u>For CAM_SEGMENT_TYPE_LINE and CAM_SEGMENT_TYPE_PARABOLIC:</u></p> <p>Accel is ignored.</p>

The type of the Nth cam segment is defined by the Nth Cam_Data element. Since the cam will be constructed with one less segment than the Cam_Data elements, the last element's SegType will not be used.

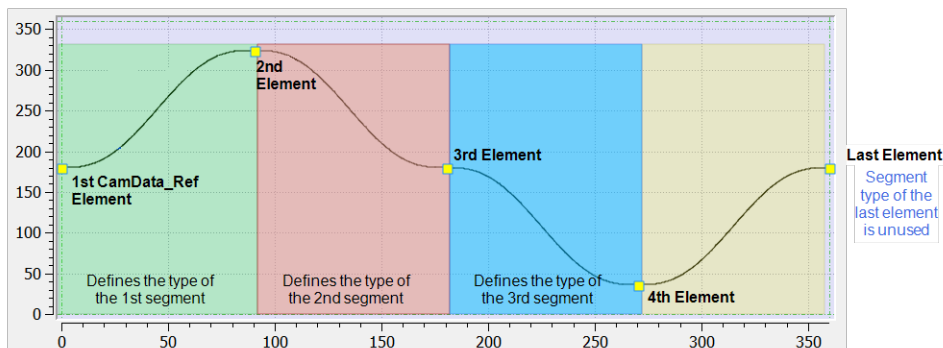

See [Cam Profile Editor's Cam Table](#) for more information.

2.3.2.1.2 Arguments

2.3.2.1.2.1 Input

Enable	Description	Enable execution. Starts on rising edge.
	Data Type	BOOL
	Range	
	Unit	
	Default	
Cam_Props	Description	Structures containing the cam profile properties
	Data Type	CamProps_ref
	Range	
	Unit	
	Default	

Cam_Data	Description	Array of structures containing the cam profile data
	Data Type	CamData_ref
	Range	N=3 to 20,000 elements
	Unit	
	Default	3 elements minimum size
CamDataCount	Description	Number of elements in the Cam_Data array to be used.
	Data Type	UINT
	Range	3 - 20,000
	Unit	elements
	Default	3
ProfileID	Description	ID number of a created CAM Profile
	Data Type	DINT
	Range	[-2147483648, 2147483648]
	Unit	N/A
	Default	--
Cyclic	Description	False: one time through the profile; True: repeating profile
	Data Type	BOOL
	Range	0-1 (FALSE/TRUE)
	Unit	
	Default	
Options	Description	Describes the combinations of segments that may be used to build a cam profile.
	Data Type	UINT
	Range	CAM_PROFILE_OPTION_DEFAULT: Allows the use of point and line segments. CAM_PROFILE_OPTION_PARABOLIC: Allows the use of line and parabolic segments.
		<div style="background-color: #f0f0f0; padding: 5px; border: 1px solid #ccc;"> <p style="text-align: center;">NOTE</p> <p>The DEFAULT and PARABOLIC options cannot be combined. A cam profile can only use point and line segments, or parabolic and line segments. Point and parabolic segments cannot both be used in the same profile.</p> </div>
	Unit	
Default		

2.3.2.1.2.2 Output

Done	Description	Indication of whether or not the profile was successfully compiled and built.
	Data Type	BOOL
	Range	0-1 (FALSE/TRUE)
	Unit	
Busy	Description	Indication that the function block is executing. TRUE if executing. False if not executing.
	Data Type	BOOL
	Range	0-1 (FALSE/TRUE)
	Unit	
Err	Description	Indication that the function did not execute correctly. ErrorID output will be valid and indicate the reason.
	Data Type	BOOL
	Range	0-1 (FALSE/TRUE)
	Unit	
ErrorID	Description	Indication of the reason for the failure to execute properly. See Error Codes table.
	Data Type	INT
	Range	
	Unit	
ErrorElem	Description	The array element number of the cam data where an error is detected
	Data Type	UINT
	Range	
	Unit	

2.3.2.1.3 Error Codes

NOTE

If **Cyclic** is TRUE and the Vel/Accel of the first and last elements do not match, MLProfileBuild will automatically copy the first element's vel/accel to the last element's. A LOG warning message will be posted indicating that this change has occurred.

ErrorID	Description
100	Cam_Data array does not have CamDataCount elements. The Cam_Data array is not large enough to hold the specified number of elements.
101	Invalid master or slave scale. The scale cannot be less than zero.
102	Element master or slave position is outside the range defined by Cam_Props.
103	A segment type was specified that is not supported by the value of the Options argument.

ErrorID	Description
104	Master position of an element is too close to the master position of a previous element. $0.0000125 * \text{InputScale}$ (see "CamProps_Ref Structure" on page 404) is the minimum distance allowed.. Each element is compared to all previous elements. If the master distance between any two elements in the list are too close, this error will be generated.
106	Invalid profile ID. This can occur if the profile ID: <ol style="list-style-type: none"> 1. does not exist 2. has not been created yet 3. profile ID is not a profile
107	CamDataCount exceeds maximum array size of 20,000.
108	Profile is currently in use.
109	Attempting to build a profile already containing elements. Profile needs to be released first using MLProfileRelease.
110	The controller is running low on memory and could not allocate memory to hold the cam table data.
111	CamDataCount is not large enough. The minimum allowed value is 3.
112	For CAM_PROFILE_OPTION_PARABOLIC: Elements are not sorted in increasing order by master position. After the first element, each element must have its master position be greater than the master position of the previous element.
113	For CAM_SEGMENT_TYPE_PARABOLIC: The average velocity for the segment is outside of range defined by start and end element velocities. The following diagram illustrates the valid range for the average velocity.
	<p>The diagram, titled "Cam Velocity Profile", shows a graph of Cam Velocity versus Master Position. The vertical axis is labeled "Cam Velocity" and the horizontal axis is labeled "Master Position". A red line represents the velocity profile, starting at a horizontal segment labeled "Start Velocity" and then rising linearly to a horizontal segment labeled "End Velocity". A red dashed line above the rising portion is labeled "Parabolic Segment". A vertical double-headed arrow between the "Start Velocity" and "End Velocity" levels is labeled "Valid Average Velocity Range".</p>
200	First element's MasterIn value not equal to zero.
201	Last element's MasterIn value does not equal value of X-amplitude.
202	Cannot modify the first element in the cam element table. SlaveOut value is outside the output range specified by Cam_Props.
203	Cannot modify the last element in the cam element table. SlaveOut value is outside the output range specified by Cam_Props.

2.3.2.1.4 Related Functions

- [MLCamInit](#)
- [MLCamSwitch](#)
- [MLProfileCreate](#)

- [MLProfileInit](#)
- [MLProfileRelease](#)
- [MC_CamIn](#)
- [MC_CamOut](#)
- [MC_CamTblSelect](#)

2.3.2.1.4.1 See Also

- [Cam Profile Segment Overview](#)

2.3.2.1.5 Example of How to Use MLProfileBuild

Prior to using MLProfileBuild you must first create a profile. This must be done prior to MLMotionStart.

```
// Allocate space for a profile that will be built later
profileID := MLProfileCreate('ProfileName');
```

Next you need to define your profile data. This is done by creating an array of CamData_Ref structures in the data dictionary and then entering each of your elements into that newly created structure. In this example ProfileData is the name of the CamData_Ref structure.

```
// Define the profile data
ProfileData[0].MasterIn := 0.0;
ProfileData[0].SlaveOut := 180.0;
ProfileData[0].SegType := CAM_SEGMENT_TYPE_POINT;
ProfileData[0].Velocity := 0.0;
ProfileData[0].Acceleration := 0.0;

ProfileData[1].MasterIn := 180.0;
ProfileData[1].SlaveOut := 324.0;
ProfileData[1].SegType := CAM_SEGMENT_TYPE_POINT;
ProfileData[1].Velocity := 0.5;
ProfileData[1].Acceleration := -0.025;

ProfileData[2].MasterIn := 360.0;
ProfileData[2].SlaveOut := 240.0;
ProfileData[2].SegType := CAM_SEGMENT_TYPE_POINT;
ProfileData[2].Velocity := 0.0;
ProfileData[2].Acceleration := 0.0;
```

Now you need to define your profile properties. This is done by creating a CamProps_Ref structure in the data dictionary and then entering each of the properties into the newly created structure. In this example ProfileProps is the name of the CamProps_Ref structure.

```
// Define the profile properties
ProfileProps.InputScale := 360.0; // Must be Positive!
ProfileProps.OutputScale := 360.0; // Must be Positive!
ProfileProps.InputOffset := 0.0;
ProfileProps.OutputOffset := 0.0;
```

Next call the MLProfileBuild Function Block in the IEC language of choice. As part of this call it is recommended that you validate the Done and Error output before proceeding.

```
// Build the profile
Inst_MLProfileBuild( TRUE, ProfileProps, ProfileData, 3, ProfileID, TRUE,
CAM_PROFILE_OPTION_DEFAULT);
```

Finally, after verifying that MLProfileBuild is Done and there are no errors, you can proceed and use the newly generated profile. The next step depends on the motion engine in use.

- PLCopen: call [MC_CamTblSelect](#)
- Pipe Network: call either [MLCamInit](#) or [MLCamSwitch](#)

NOTE

Pipe Network: In order to correctly set the cam scales and offsets (defined by the Cam_Props argument) [MLPrfWriteIScale](#), [MLPrfWriteOScale](#), [MLPrfWriteIOffset](#) and [MLPrfWriteOOffset](#) must be called before calling [MLCamSwitch](#),

```
// Switch Pipe Network Profile
MLPrfWriteIScale(profileID, ProfileProps.InputScale);
MLPrfWriteOScale(profileID, ProfileProps.OutputScale);
MLPrfWriteIOffset(profileID, ProfileProps.InputOffset);
MLPrfWriteOOffset(profileID, ProfileProps.OutputOffset);
MLCamSwitch(PipeNetwork.CAM, profileID);
```

2.3.2.1.6 Example of Building a Parabolic Cam Profile

In order to build a parabolic cam profile, your cam data elements must use `CAM_SEGMENT_TYPE_PARABOLIC` or `CAM_SEGMENT_TYPE_LINE` when defining the cam data array:

```
// Define the profile data
ProfileData[0].MasterIn      := 0.0;
ProfileData[0].SlaveOut     := 0.0;
ProfileData[0].SegType      := CAM_SEGMENT_TYPE_PARABOLIC;
ProfileData[0].Velocity     := 0.0;
ProfileData[0].Acceleration := 0.5;

ProfileData[1].MasterIn      := 50.0;
ProfileData[1].SlaveOut     := 150.0;
ProfileData[1].SegType      := CAM_SEGMENT_TYPE_LINE;
ProfileData[1].Velocity     := 5.0;
ProfileData[1].Acceleration := 0.0;           // Not used

ProfileData[2].MasterIn      := 55.0;
ProfileData[2].SlaveOut     := 175.0;
ProfileData[2].SegType      := CAM_SEGMENT_TYPE_PARABOLIC;
ProfileData[2].Velocity     := 5.0;
ProfileData[2].Acceleration := 0.0;           // No limit to the acceleration rate
of the segment.

ProfileData[3].MasterIn      := 105.0;
ProfileData[3].SlaveOut     := 250.0;
ProfileData[3].SegType      := CAM_SEGMENT_TYPE_PARABOLIC;
ProfileData[3].Velocity     := 0.0;
ProfileData[3].Acceleration := 0.5;

ProfileData[4].MasterIn      := 225.0;
ProfileData[4].SlaveOut     := 125.0;
```

```

ProfileData[4].SegType      := CAM_SEGMENT_TYPE_PARABOLIC;
ProfileData[4].Velocity     := -10.0;
ProfileData[4].Acceleration := 0.5;

ProfileData[5].MasterIn    := 360.0;
ProfileData[5].SlaveOut     := 0.0;
ProfileData[5].SegType     := CAM_SEGMENT_TYPE_PARABOLIC; // Not used
ProfileData[5].Velocity    := 0.0;
ProfileData[5].Acceleration := 0.0; // Not used
    
```

When calling the MLProfileBuild function block, make sure CAM_PROFILE_OPTION_PARABOLIC is specified for the Option argument: in the IEC language of choice. As part of this call it is recommended that you validate the Done and Error output before proceeding.

```

// Build the profile
Inst_MLProfileBuild( TRUE, ProfileProps, ProfileData, 3, ProfileID, TRUE,
CAM_PROFILE_OPTION_PARABOLIC);
    
```

2.3.2.1.7 Code Examples

Structured Text:

```

// Build the profile
Inst_MLProfileBuild( TRUE, ProfileProps, ProfileData, 3, ProfileID, TRUE,
CAM_PROFILE_OPTION_DEFAULT);
    
```

Function Block Diagram:

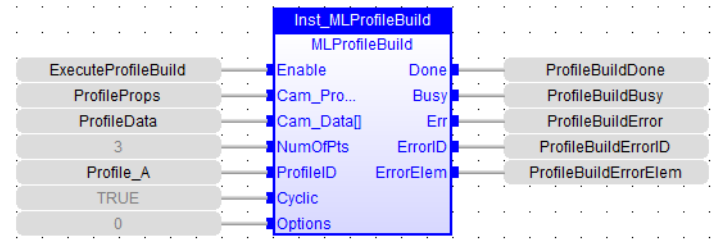

Ladder Diagram:

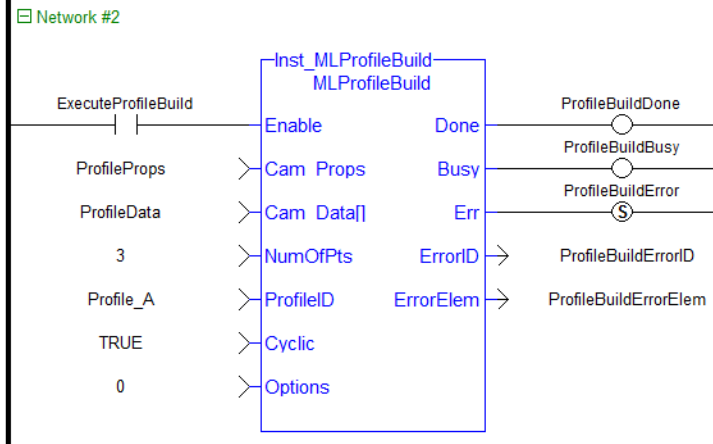

2.3.2.2 MLProfileCreate

PLCopen ✓ Pipe Network ✓

2.3.2.2.1 Description

Creates a new Profile Object for use in a PLC Program or Pipe Network CAM block. This function block is automatically called if a Profile is created in the Project Explorer, with user-defined settings then entered in the CAM Profile Properties screen.

Profiles are created and initiated separately and the shape is modified with the CAM Editor. With the Editor profiles can be changed graphically or by manually changing values in a numeric table relating input and output values with specific slopes. The Cam Editor software tool provides the capability to visualize, analyze, edit, and smooth profiles.

Profile switching can be done on the fly, without losing synchronization and without dead time. In addition, the offsets and ratios of CAM Profiles can be changed on the fly.

NOTE

Profile objects are normally created in the Project Explorer. Then you do not have to add `MLCamInit` function blocks to their programs. By right clicking the Profiles folder under the PLC->Motion Tree, you can select Add new profile. Parameters are entered directly in a pop-up window, and the code is then automatically added to the current project.

TIP

This function should be called after `MLMotionInit` is called and before `MLMotionStart` is called.

2.3.2.2.2 Arguments

2.3.2.2.2.1 Input

Name	Description	Name of initialized CAM Profile
	Data type	STRING
	Range	—
	Unit	N/A
	Default	—

2.3.2.2.2.2 Output

OK	Description	Indicates the profile has been created
	Data type	BOOL
ID	Description	Returns the ID number of the created CAM Profile. If <code>MLProfileCreate(...)</code> fails, then the ID is zero (NULL). A cam ProfileID = 0 (zero) is not valid for cam profile functions.
	Data type	DINT
	Unit	N/A

2.3.2.2.3 Related Functions

[MLProfileInit](#)

[MLCamInit](#)

2.3.2.2.4 Example

2.3.2.2.4.1 Structured Text

```
//Create a new Profile
Profile_A := MLProfileCreate( 'Profile_A' );
```

2.3.2.2.4.2 Ladder Diagram

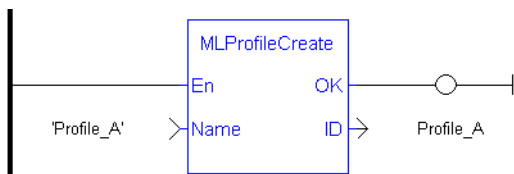

2.3.2.2.4.3 Function Block Diagram



2.3.2.3 MLProfileInit PLCopen ✓ Pipe Network ✓

2.3.2.3.1 Description

Initializes a previously created CAM Profile object for use in a PLC Program or Pipe Network CAM block. This function block is automatically called if a Profile is created in the Project Explorer, with user-defined settings then entered in the CAM Profile Properties screen.

Profiles are created and initiated separately and the shape is modified with the CAM Editor. With the Editor profiles can be changed graphically or by manually changing values in a numeric table relating input and output values with specific slopes. The Cam Editor software tool provides the capability to visualize, analyze, edit, and smooth profiles.

Profile switching can be done on the fly, without losing synchronization and without dead time. In addition, the offsets and ratios of CAM Profiles can be changed on the fly.

NOTE

Profile objects are normally initiated in the Project Explorer. Then you do not have to add MLCamInit function blocks to their programs. By right clicking the Profiles folder under the PLC->Motion Tree, you can select Add new profile. Parameters are entered directly in a pop-up window, and the code is then automatically added to the current project.

TIP

Loading a Profile Editor-generated profile into a ProfileID released by MLProfileRelease should be done with care. The MLProfileInit () function call can take in excess of 4 milliseconds to execute. Application execution is suspended during this time until the function call is completed.

2.3.2.3.2 Arguments

2.3.2.3.2.1 Input

ProfileID	Description	ID number of a created CAM Profile
	Data type	DINT
	Range	[-2147483648, 2147483648]
	Unit	N/A
	Default	—
FileName	Description	Filename used to save Profile on the computer's hard disk
	Data type	STRING
	Range	—
	Unit	N/A
	Default	—
InputScale	Description	The input amplitude or x-axis multiplier applied to the CAM Profile
	Data type	LREAL
	Range	Positive
	Unit	N/A
	Default	—
OutputScale	Description	The output amplitude or y-axis multiplier applied to the CAM Profile
	Data type	LREAL
	Range	—
	Unit	N/A
	Default	—
InputOffset	Description	The input offset or x-axis shift applied to the CAM Profile.
	Data type	LREAL
	Range	—
	Unit	N/A
	Default	—
OutputOffset	Description	The output offset or y-axis shift applied to the CAM Profile
	Data type	LREAL
	Range	—
	Unit	N/A
	Default	—

2.3.2.3.2.2 Output

Default (.Q)	Description	Returns TRUE if a new CAM Profile is initialized
	Data type	BOOL
	Unit	N/A

2.3.2.3.2.3 Return Type

BOOL

2.3.2.3.3 Related Functions

[MLProfileCreate](#)

[MLCamInit](#)

2.3.2.3.4 Example

2.3.2.3.4.1 Structured Text

```
//Initialize a previously created CAM Profile
MLProfileCreate( Profile_A , 'Profile_A.5op' , 360, 360, 0, 0 );
```

2.3.2.3.4.2 Ladder Diagram

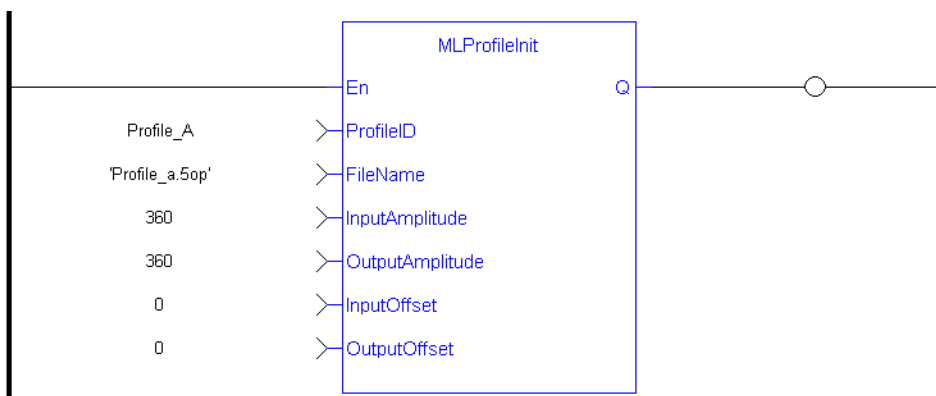

2.3.2.3.4.3 Function Block Diagram

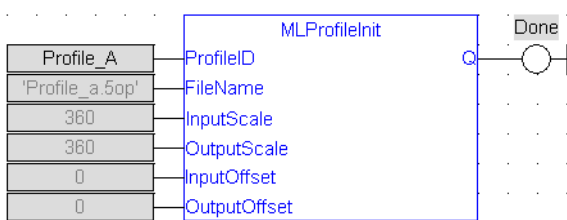

2.3.2.4 MLProfileRelease

PLCopen ✓
Pipe Network ✓

An application program is limited to 256 Profile ID's. This FB releases an existing profile ID definition so that the profile ID can be used for a different/new Profile (minimizing the risk of reaching 256 Profile ID's). Once the existing Profile ID definition has been successfully released, the Profile ID can then be used by either [MLProfileInit](#) or [MLProfileBuild](#) to create a new Profile.

The Profile ID selected by the input parameter must not be in-use by a motion engine. In-use is defined as:

- For Pipe Network – it must not be currently selected for use by an active CAM block in an active pipe. Pipe has been activated by [MLCamSwitch](#).
- For PLCOpen – selected for use by [MC_CamIn](#) and has an active move.

There are a number of ways to change an in-use profile to one that is not in-use (deactivated):

- For Pipe Network – Perform a [MLCamSwitch](#) on an active Pipe to a different Profile or deactivate the pipe.
- For PLCOpen – whenever the active profile move is halted or aborted, the profile is no longer in use. [MC_CamOut](#) is one way of aborting the profile move. Actually, any PLCopen motion command that aborts a profile move will also deactivate a profile.

NOTE

Any profile ID created by [MC_CamTblSelect](#) from the specified ProfileID will be destroyed and need to be recreated upon completion of this FB. This means that all derived profile ID's created by [MC_CamTblSelect](#) FB must also not be in use by the PLCopen motion engine in order for this function to succeed.

TIP

Loading a Profile Editor-generated profile into a ProfileID released by [MLProfileRelease](#) should be done with care. The [MLProfileInit](#) () function call can take in excess of 4 milliseconds to execute. Application execution is suspended during this time until the function call is completed.

2.3.2.4.1 Arguments

For more information on how Arguments work, refer to [PLCopen function blocks - General rules](#) .

2.3.2.4.1.1 Input

Enable	Description	Enable execution of the function block. Successful completion will result in a profile ID that is no longer assigned to a specific profile and can be reused for a different/new Profile. Prior to reusing this Profile ID it will need to be re-initialized by either an MLProfileInit Function call or by calling MLProfileBuild .
	Data Type	BOOL
	Range	0, 1
	Unit	
	Default	0
ProfileID	Description	Specify a Profile ID that has been created by MLProfileCreate . This is the profile ID that will be released so it can be reused for different/new Profiles. This Profile ID must not be in use by a motion engine.
	Data Type	DINT
	Range	1 to 256
	Unit	
	Default	0

2.3.2.4.1.2 Output

Done	Description	If high, Successful completion. The Profile can now be reused.
	Data Type	BOOL
	Range	0, 1
Err	Description	If high, the Function Block did not complete successfully. Reason is given in Error ID.
	Data Type	BOOL
	Range	0, 1
ErrorID	Description	Indicates the reason for the failure. See Error Codes table for possible reasons.
	Data Type	INT
	Range	

2.3.2.4.2 Error Codes

ErrorID	Description
106	Invalid profile ID. Profile ID: <ol style="list-style-type: none"> 1. does not exist 2. has not been created yet 3. profile ID is not a profile
108	Profile cannot be released because it is in use by the motion engine or currently selected by an active CAM block.

2.3.2.4.3 Related Functions

[MLProfileCreate](#)

[MLProfileInit](#)

[MLProfileBuild](#)

[MLCamInit](#)

[MC_CamTblSelect](#)

[MC_CamIn](#)

[MC_CamOut](#)

2.3.2.4.4 Example

2.3.2.4.4.1 Structured Text

```
//Release a Cam Profile
Inst_MLProfileRelease( Profile_A , 'Profile_A.5op');

If Inst_MLProfileRelease.Done THEN
  // Do Something
ELSIF Inst_MLProfileRelease.Err THEN
  // Handle Error
END_IF;
```

2.3.2.4.4.2 Ladder Diagram

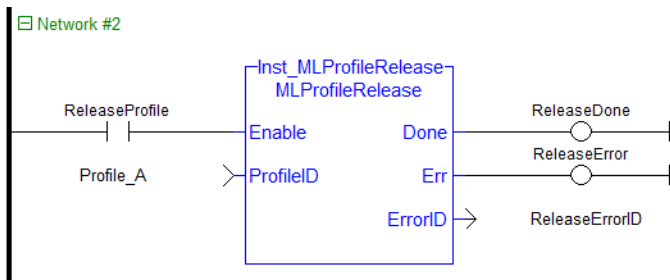

2.3.2.4.4.3 Function Block Diagram



2.3.3 Motion Library

Name	Description	Return type
MLMotionInit	Initializes the motion library. Must be called before any other Motion Library function. Returns TRUE if the function succeeded. BasePeriod is the duration of one motion cycle in microseconds.	BOOL
MLMotionRstErr	Re-initializes the motion engine after a motion error. Motion errors are for example communication errors of the motion bus. Returns TRUE if the function succeeded.	BOOL
MLMotionStart	Starts the motion engine, motion bus driver, and initializes EtherCAT network to operational mode. Applicable to PLCopen and PipesNetwork motion engines. Returns TRUE if the function succeeded.	BOOL
MLMotionStatus	Returns the status of the motion engine 0: Not initialized 1: Running 2: Stopped 3: Error	None
MLMotionStop	Stops the motion bus driver, motion engine, and EtherCAT network operation, resulting in the EtherCAT network transitioning to the Init state. Returns TRUE if the function succeeded.	BOOL
MLMotionSysTime	Prints the system time to the log	BOOL
MLMotionCycleTime	Returns the Motion Base Cycle time in seconds.	

2.3.3.1 State Machine

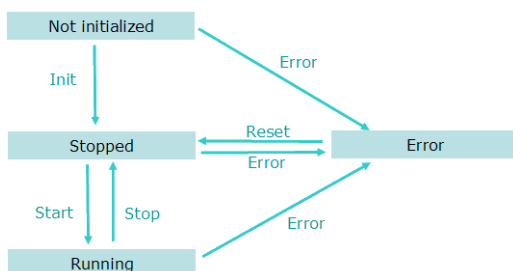

Figure 1-97: Motion State Machine

The Motion State Machine is driven by the IEC 61131-3 application with the help of the [Motion Library](#) function blocks.

Each arrow represents a transition from one State to another one.

2.3.3.2 MLMotionCycleTime PLCopen ✓ Pipe Network ✓

Returns the Motion Base Cycle time in seconds.

2.3.3.2.1 Arguments

2.3.3.2.1.1 Input

Enable	Description
	Data type
	Range
	Unit
	Default

2.3.3.2.1.2 Output

OK	Description
	Data type
CycleTime	Description Cycle time in seconds
	Data type
	Unit

2.3.3.2.2 Example

2.3.3.2.2.1 Structured Text

```
//Read EtherCAT cycle rate in ms
lrCycleTime:= MLMotionCycleTime();
```

2.3.3.2.2.2 Ladder Diagram

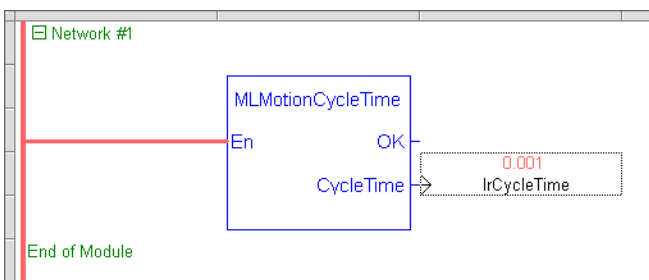

2.3.3.2.2.3 Function Block Diagram



2.3.3.3 MLMotionInit PLCopen ✓ Pipe Network ✓

2.3.3.3.1 Description

Initializes the motion library. Must be called before any other Motion Library function. Returns TRUE if the function succeeded.

NOTE

The BasePeriod argument establishes the base cycle time (in microseconds) for the Motion Engine when running simulations without the EtherCAT Motion Bus. When the EtherCAT Motion Bus is present, the EtherCAT cycle time overrides the BasePeriod argument (the cycle time is defined in the [Master](#) tab). The EtherCAT cycle time then becomes the base cycle time for the Motion Engine.

2.3.3.3.2 Parameter

BasePeriod : LREAL (input)

2.3.3.3.3 Return Type

BOOL

2.3.3.3.4 Example

2.3.3.3.4.1 ST

```
//Initialization code to start EtherCAT network.
//First initialize network with MLMotionInit command
//Then wait for command to finish by monitoring MLMotionStatus output
//Once initialized, create any cam profiles and PLCopen or Pipenetwork
devices
//Then call MLMotionStart and monitor MLMotionStatus again before
beginning rest of program
FirstCycle := TRUE;

On FirstCycle DO //Initialize the motion engine
  MLMotionInit( 1000);
END_DO;

MotionEngineStatus := MLMotionStatus();//Check the current status of the
motion engine
//Once motion engine is initialized, create CAM profiles and defined
Axis, then start the motion engine
ON MotionEngineStatus = MLSTATUS_INITIALISED DO
  Profiles( MLPR_CREATE_PROFILES );
  PLCopen( 0 );
  MLMotionStart();
END_DO;

IF MotionEngineStatus = MLSTATUS_RUNNING THEN
  bMotionEngineStarted := TRUE;
ELSE
  bMotionEngineStarted := FALSE;
END_IF;
```

2.3.3.3.4.2 FBD



2.3.3.3.4.3 FFLD

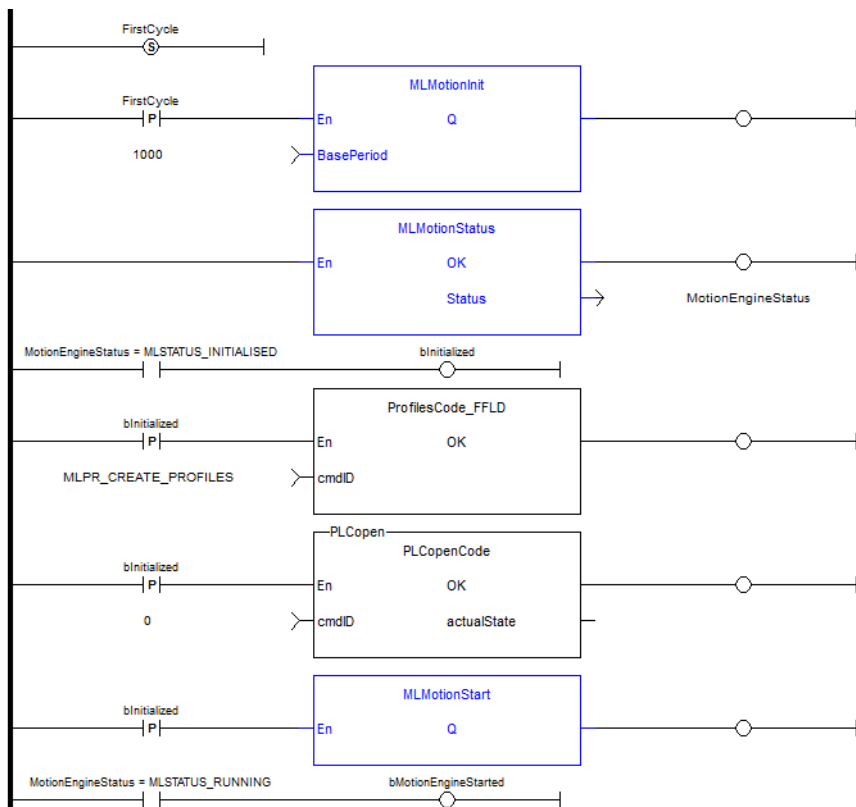

2.3.3.4 MLMotionRstErr PLCopen ✓ Pipe Network ✓

2.3.3.4.1 Description

Clears motion engine errors, motion bus driver errors, and EtherCAT network errors. `MLMotionRstErr` will return the motion engine status to the Stopped state. Returns TRUE if the function succeeded.

See also: [MLMotionStatus](#), [MLMotionStop](#), [MLMotionStart](#)

2.3.3.4.2 Return Type

BOOL

2.3.3.4.3 Example

2.3.3.4.3.1 ST

```

//Reset and restart motion engine
//Done to restart ethercat after controller error such as
//E30 or E33 that stops network communication
//First have to reset error, then start network again

ON ResetMotionEngineError DO
  MLMotionRstErr();
END_DO;

MotionEngineStatus:= MLMotionStatus();

ON StartMotionEngine DO
  MLMotionStart();
END_DO;
    
```

2.3.3.4.3.2 FBD

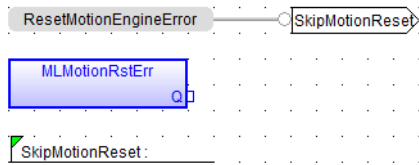

2.3.3.4.3.3 FFLD

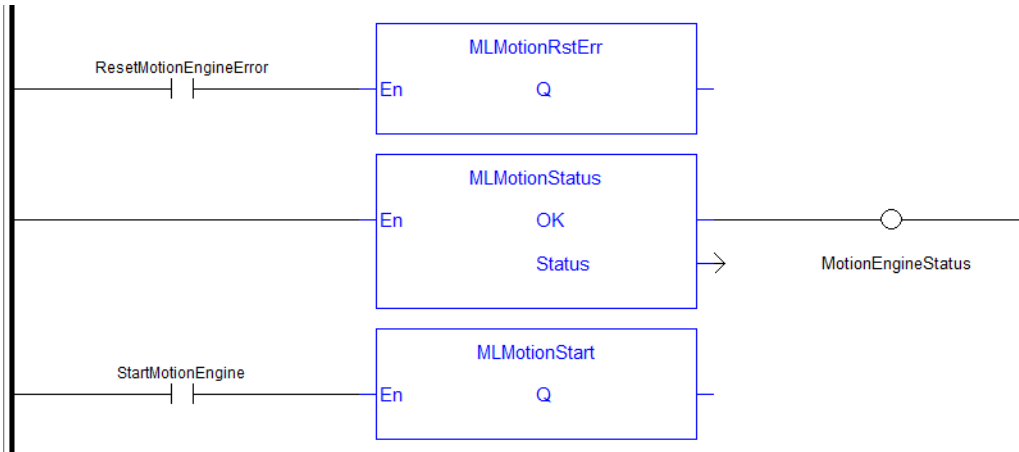

PLCopen ✓ **Pipe Network** ✓

2.3.3.5 MLMotionStart

2.3.3.5.1 Description

Starts the motion engine, motion bus driver, clears the EtherCAT diagnostic registers of all nodes, and initializes EtherCAT network to operational mode. Applicable to PLCopen and PipeNetwork motion engines. MLMotionStart does not clear any pre-existing error conditions. Returns TRUE if the function succeeded. If motion engine is in the Error state, MLMotionStart will return FALSE.

See also: [MLMotionStop](#), [MLMotionRstErr](#), [MLMotionStatus](#)

2.3.3.5.2 Return Type

BOOL

2.3.3.5.3 Example

2.3.3.5.3.1 ST

```
//Initialization code to start EtherCAT network.
//First initialize network with MLMotionInit command
//Then wait for command to finish by monitoring MLMotionStatus output
//Once initialized, create any cam profiles and PLCopen or Pipenetwork
devices
//Then call MLMotionStart and monitor MLMotionStatus again before
beginning rest of program
FirstCycle := TRUE;

On FirstCycle DO //Initialize the motion engine
    MLMotionInit( 1000);
END_DO;

MotionEngineStatus := MLMotionStatus();//Check the current status of the
```

```

motion engine
//Once motion engine is initialized, create CAM profiles and defined
Axis, then start the motion engine
ON MotionEngineStatus = MLSTATUS_INITIALISED DO
  Profiles( MLPR_CREATE_PROFILES );
  PLCopen( 0 );
  MLMotionStart();
END_DO;

IF MotionEngineStatus = MLSTATUS_RUNNING THEN
  bMotionEngineStarted := TRUE;
ELSE
  bMotionEngineStarted := FALSE;
END_IF;
    
```

2.3.3.5.3.2 FBD

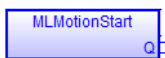

2.3.3.5.3.3 FFLD

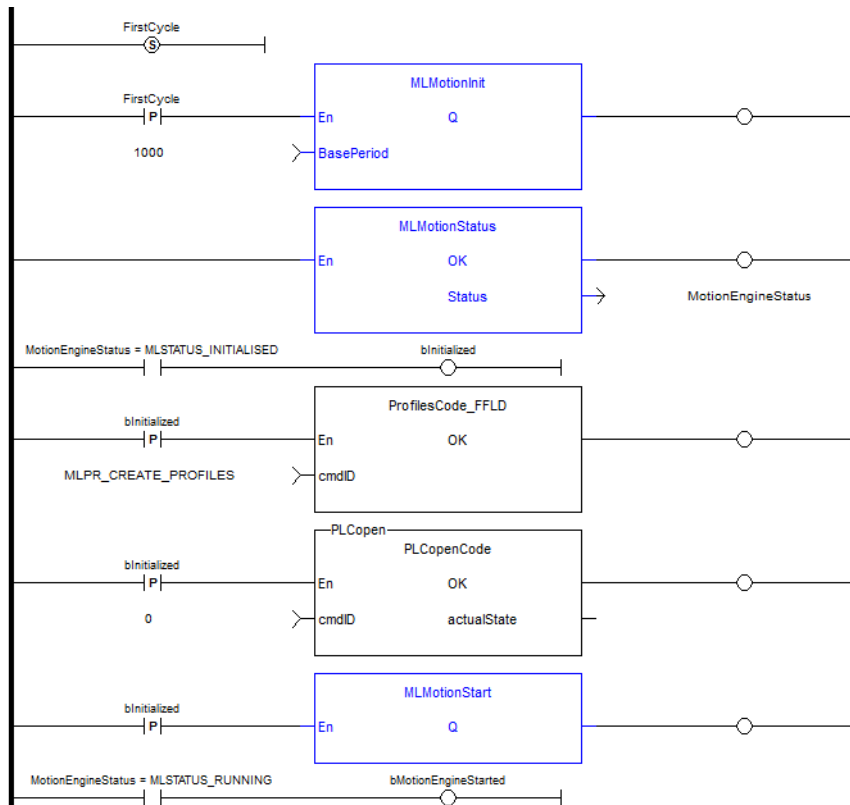

2.3.3.6 MLMotionStatus PLCopen ✓ Pipe Network ✓

2.3.3.6.1 Description

Returns the status of the motion engine. Based on the [Internal Defines](#), the status will be one of the following.

```
#define MLSTATUS_NOT_INITIALISED 0 (*Motion not initialised*)
#define MLSTATUS_RUNNING 1 (*Motion is running*)
#define MLSTATUS_STOPPED 2 (*Motion is stopped*)
#define MLSTATUS_ERROR 3 (*Motion is in error*)
```

NOTE

This function or function block returns cached data. See [Programming a Dual Core Controller](#) for more information.

2.3.3.6.2 Parameter

Status : DINT (output)

2.3.3.6.3 Return Type

None

2.3.3.6.4 Example**2.3.3.6.4.1 ST**

```
//Initialization code to start EtherCAT network.
//First initialize network with MLMotionInit command
//Then wait for command to finish by monitoring MLMotionStatus output
//Once initialized, create any cam profiles and PLCopen or Pipenetwork
devices
//Then call MLMotionStart and monitor MLMotionStatus again before
beginning rest of program
FirstCycle := TRUE;

On FirstCycle DO //Initialize the motion engine
MLMotionInit( 1000);
END_DO;

MotionEngineStatus := MLMotionStatus();//Check the current status of the
motion engine
//Once motion engine is initialized, create CAM profiles and defined
Axis, then start the motion engine
ON MotionEngineStatus = MLSTATUS_INITIALISED DO
Profiles( MLPR_CREATE_PROFILES );
PLCopen( 0 );
MLMotionStart();
END_DO;

IF MotionEngineStatus = MLSTATUS_RUNNING THEN
bMotionEngineStarted := TRUE;
ELSE
bMotionEngineStarted := FALSE;
END_IF;
```

2.3.3.6.4.2 FBD**2.3.3.6.4.3 FFLD**

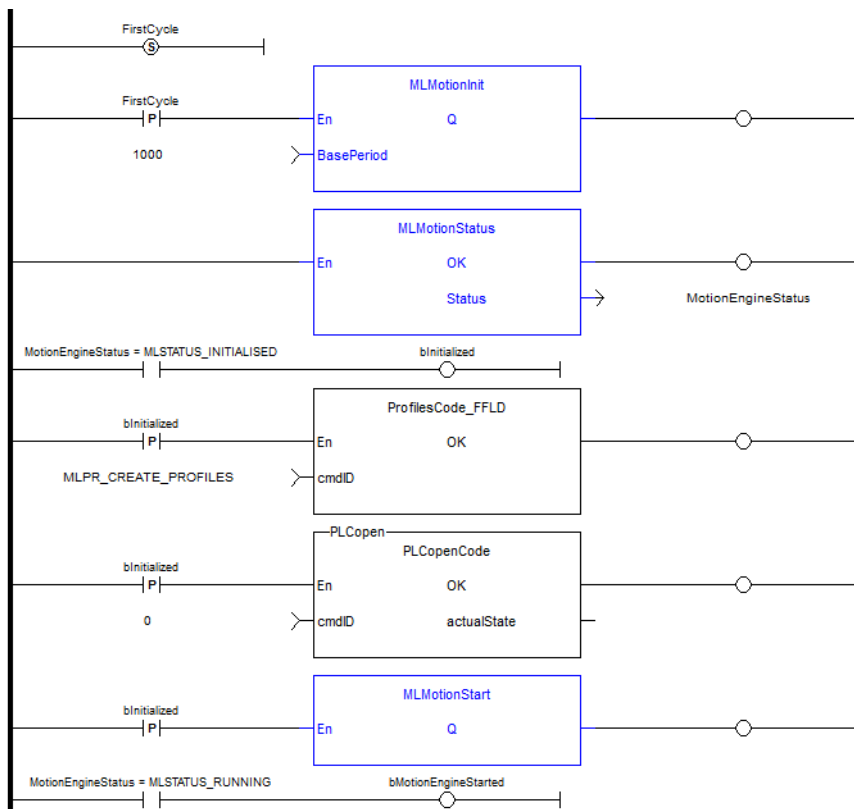

2.3.3.7 MLMotionStop PLCopen ✓ Pipe Network ✓

2.3.3.7.1 Description

Stops the motion bus driver, motion engine, and EtherCAT network operation, resulting in the EtherCAT network transitioning to the Init state. Returns TRUE if the function succeeded.

See also: [MLMotionStart](#), [MLMotionRstErr](#), [MLMotionStatus](#)

2.3.3.7.2 Return Type

BOOL

2.3.3.7.3 Example

2.3.3.7.3.1 ST

```
//Stop the EtherCAT network
ON StopMotionEngine DO
    MLMotionStop();
END_DO;
```

2.3.3.7.3.2 FBD

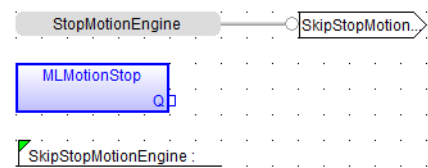

2.3.3.7.3.3 FFLD

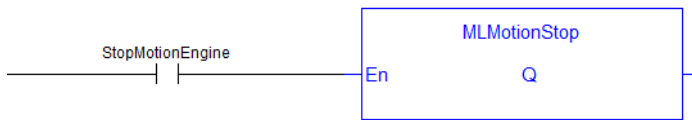

2.3.3.8 MLMotionSysTime PLCopen ✓ Pipe Network ✓

2.3.3.8.1 Description

Prints the system time to the log. Returns always TRUE.

2.3.3.8.2 Return Type

BOOL

2.3.3.8.3 Units

milliseconds

2.3.3.8.4 Example

2.3.3.8.4.1 ST

```
//Write the current system time to controller log message
ON PrintSystemTimeToLog DO
    MLMotionSysTime ();
END_DO;
```

2.3.3.8.4.2 FBD

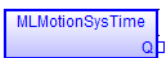

2.3.3.8.4.3 FFLD

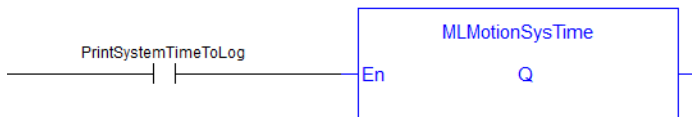

2.3.4 Coordinated Motion Function Blocks

This section contains a table with an alphabetical list of the Coordinated Motion function blocks. The table includes where the function block can be found in the KAS IDE library, starting from *Motion/Common > Coordinated Motion > (Grouping)*.

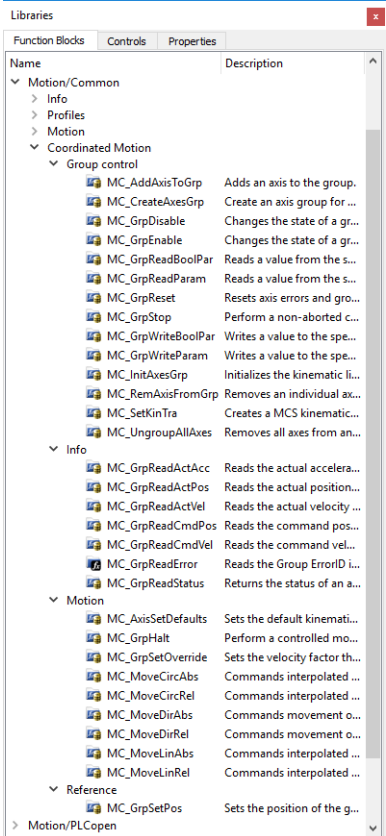
Name	Grouping	Description	Location in the Dictionary
MC_AddAxisToGrp	Group Control	Adds an axis to an axes group.	 <p>The screenshot shows a 'Libraries' window with a tree view. The path 'Motion/PLCopen' is expanded, and 'MC_AddAxisToGrp' is highlighted under the 'Group control' sub-category. The description for 'MC_AddAxisToGrp' is 'Adds an axis to the group.'</p>
MC_AxisSetDefaults	Motion	Sets the default kinematic parameters for an axis.	
MC_CreateAxesGrp	Group Control	Create an axis group for coordinated motion.	
MC_ErrorDescription	Motion/Common > Info	Converts the PLCopen error IDs into message strings	
MC_GrpReset	Group Control	Resets all the axes in an axes group.	
MC_GrpDisable	Group Control	Changes the state of a group to GroupDisabled.	
MC_GrpEnable	Group Control	Changes the state of a group from GroupDisabled to GroupStandby.	
MC_GrpHalt	Motion	Performs a controlled motion stop of all the axes in the group	
MC_GrpReadActAcc	Info	Reads the actual acceleration of the group and the axes in the group.	
MC_GrpReadActPos	Info	Reads the actual position of the axes in the group.	
MC_GrpReadActVel	Info	Reads the actual velocity of the group and the axes in the group.	
MC_GrpReadBoolPar	Group Control	Reads a value from the specified boolean group parameter	
MC_GrpReadParam	Group Control	Reads a value from the specified group parameter.	
MC_GrpReadCmdPos	Info	Reads the command position of the axes in the group.	

Name	Grouping	Description	Location in the Dictionary
MC_GrpReadCmdVel	Info	Reads the command velocity of the axes in the group and the path velocity.	
MC_GrpReadError	Info	Reads the Group ErrorID in State ERRORSTOP.	
MC_GrpReadStatus	Info	Returns the status of an axes group.	
MC_GrpReset	Group Control	Makes the transition from the state GroupErrorStop to GroupStandby by resetting all internal group-related errors. Also resets axis errors and drive faults for each axis in the group.	
MC_GrpSetOverride	Motion	Sets the velocity factor that is multiplied to the commanded velocity of all axes in the group.	
MC_GrpSetPos	Reference	Sets the axis position for all of the axes in an axes group to the positions specified in the <code>Position</code> input.	
MC_GrpStop	Group Control	Performs a non-aborted, controlled motion stop on all axes in an AxesGroup.	
MC_GrpWriteBoolPar	Group Control	Writes a value to the specified boolean group parameter.	
MC_GrpWriteParam	Group Control	Writes a value to the specified group parameter.	
MC_InitAxesGrp	Group Control	Initializes the kinematic limits for the axis group.	

Name	Grouping	Description	Location in the Dictionary
MC_MoveCircAbs	Motion	Commands interpolated circular movement on an axes group to the specified absolute positions.	
MC_MoveCircRel	Motion	Commands interpolated circular movement on an axes group to the specified relative positions.	
MC_MoveDirAbs	Motion	Commands movement of an axes group to an absolute position regardless of path.	
MC_MoveDirRel	Motion	Commands movement of an axes group to a relative position regardless of path.	
MC_MoveLinAbs	Motion	Commands interpolated linear movement on an axes group to the specified absolute positions.	
MC_MoveLinRel	Motion	Commands interpolated linear movement on an axes group to the specified relative positions.	
MC_RemAxisFromGrp	Group Control	Removes an individual axis from an axis group.	
MC_SetKinTra	Group Control	Sets the kinematic transform between the Machine Coordinate System and the Axes Coordinate System	
MC_UngroupAllAxes	Group Control	Removes all axes from an axes group.	

2.3.4.1 Coordinated Motion Group Control Library

Function	Description
Related Functions	Adds an axis to an axes group.
Related Function Blocks	Create an axis group for coordinated motion.
Related Functions	Changes the state of a group to GroupDisabled.
Related Functions	Changes the state of a group from GroupDisabled to GroupStandby.
Related Function Blocks	Reads a value from the specified Boolean group parameter
Input	Reads a value from the specified group parameter.
Related Functions	Makes the transition from the state GroupErrorStop to GroupStandby by resetting all internal group-related errors. Also resets axis errors and drive faults for each axis in the group.
Related Functions	Performs a non-aborted, controlled motion stop on all axes in an AxesGroup.
Related Function Blocks	Writes a value to the specified Boolean group parameter.
Input	Writes a value to the specified group parameter.
Related Function Blocks	Initializes the kinematic limits for the axis group.
Related Functions	Removes an individual axis from an axis group.
Related Functions	Removes all axes from an axes group.

2.3.4.1.1 MC_AddAxisToGrp PLCopen ✓ Pipe Network ✓

2.3.4.1.1.1 Description

This function block adds an axis to an axes group. Both the axis and the axes group must be created prior to calling this function block. See [Related Function Blocks](#) and [Create PLCopen Axis](#).

The IdentInGroup input specifies the index of the axis in the group. Axes do not need to be added in sequential order and gaps are acceptable. Gaps are ignored when the group is used.

The group must be in either the "GroupStandby" or "GroupDisabled" state when the axis is added. The state of the group can be read with [Related Functions](#). This implies that the group cannot be moving when the axis is added.

This function block does not cause motion.

TIP

- An axes group cannot contain more than one instance of an axis.
- Two active groups cannot contain the same axis. An "active" group is one in any state other than GroupDisabled.

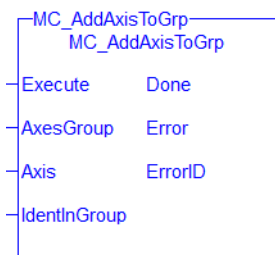

Figure 1-98: MC_AddAxisToGrp

NOTE

This function block starts a motion-related action and therefore stores data for calculations and error checking. Please see [Calling Function Blocks Multiple Times in the Same Cycle](#) if you are using a dual-core controller.

2.3.5 Related Functions

[Related Function Blocks](#), [Related Functions](#), [Related Functions](#), [Related Functions](#), [MC_ErrorDescription](#)

See also "Coordinated Motion", the top-level topic for Coordinated Motion.

2.3.5.0.1 Arguments

2.3.6 Input

Execute	Description	On the rising edge the axis is added to the group.
	Data type	BOOL
	Range	0, 1
	Unit	N/A
	Default	—
AxesGroup	Description	Reference to an axes group
	Data type	AXES_GROUP_REF
	Range	—
	Unit	N/A
	Default	—
Axis	Description	Reference to the axis to be added. An axes group cannot contain more than one instance of an axis.
	Data type	AXIS_REF
	Range	—
	Unit	N/A
	Default	—
IdentInGroup	Description	<p>The zero-based index of the axis in the group.</p> <ul style="list-style-type: none"> The axis slot in the group cannot be occupied by another axis. The index must be less than the maximum number of axes the group can contain. <code>MaxNumberOfAxes</code> is a property of the axes group and is set when the group is created. <p>To remove an axis from a group see Related Functions.</p>
	Data type	UINT
	Range	[0, MaxNumberOfAxes - 1]

Unit	N/A
Default	—

2.3.7 Output

Done	Description	If True, then the command completed successfully.
	Data type	BOOL
Error	Description	If True, an error has occurred.
	Data type	BOOL
ErrorID	Description	Indicates the error identifier if Error output is set to True. See the table in PLCopen Function Block ErrorID Output .
	Data type	INT

2.3.7.0.1 Example

2.3.8 Structured Text

```
(*MC_AddAxisToGrp ST example *)
Inst_MC_AddAxisToGrp (AddAxisToGrp, Group1_ref, Axis_1, 0);
```

2.3.9 IL

```
BEGIN_IL
CAL Inst_MC_AddAxisToGrp( AddAxisToGrp, Group1_ref, Axis_1, 0 )
END_IL
```

2.3.10 FBD

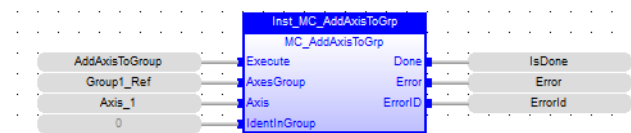

2.3.11 Ladder Diagram

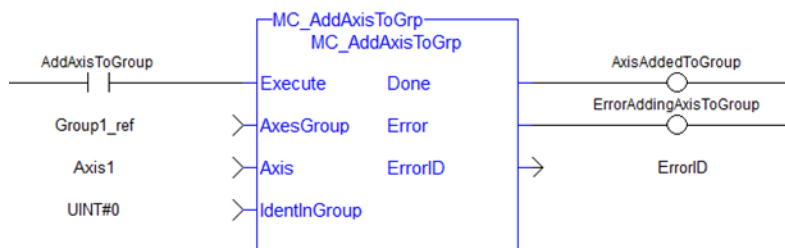

2.3.11.0.1 MC_CreateAxesGrp



2.3.11.0.1.1 Description

MC_CreateAxesGrp creates an axes group for coordinated motion. More than one axes group may be created and be active at the same time but each axis can only be a part of one group at a time.

Example of a valid setup:

```

AxesGroup1: Axis0, Axis1, Axis2
AxesGroup2: Axis3, Axis4
    
```

Example of an invalid setup:

```

AxesGroup1: Axis0, Axis1, Axis2
AxesGroup2: Axis2, Axis3, Axis4
    
```

The invalid setup is not allowed because Axis2 would be a part of two axes groups at the same time.

If an axis needs to be in more than one group, it can be removed from one and then added to another group. This is done using [Related Functions](#) and [Related Functions](#).

IMPORTANT

MC_CreateAxesGrp must be called between [MLMotionInit](#) and [MLMotionStart](#).

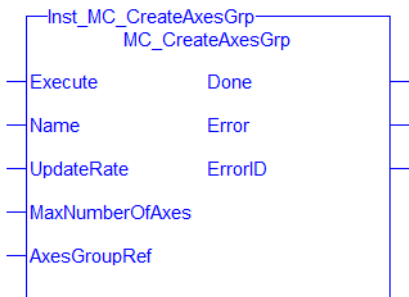

Figure 1-99: MC_CreateAxesGrp

2.3.12 Related Function Blocks

[Related Function Blocks, MC_ErrorDescription](#)

See also "Coordinated Motion", the top-level topic for Coordinated Motion.

2.3.12.0.0.1 Arguments

For more detail on how inputs and outputs work, refer to [PLCopen Function Blocks - General Rules](#).

2.3.12.0.0.2 Input

Execute	Description	On the rising edge, this function block will create a coordinated motion axes group
	Data Type	BOOL
	Range	0, 1
	Unit	N/A
	Default	—
Name	Description	Axes Group Name
	Data Type	STRING

	Range	String length from 1 to 64 characters. The string length is limited to 64 characters for optimal controller performance.
	Unit	N/A
	Default	—
UpdateRate	Description	Update rate of the axes group. The group update rate will be the same as the Base Period specified in MLMotionInit . The update rate will run at the Base Period if it is a smaller time than the Base Period. (0, 1, and 2 are reserved for future enhancements) 3 = 125 µsec 4 = 250 µsec 5 = 500 µsec 6 = 1 msec 7 = 2 msec 8 = 4 msec 9 = 8 msec
	Data Type	UINT
	Range	[3,9]
	Unit	N/A
	Default	—
MaxNumberOfAxes	Description	The maximum number of axes that can be controlled by the group.
	Data Type	UINT
	Range	[2,256]
	Unit	N/A
	Default	—
AxesGroupRef	Description	The axes group reference variable to be initialized with a reference to the new axes group.
	Data Type	AXES_GROUP_REF
	Range	N/A
	Unit	N/A
	Default	—

2.3.12.0.0.3 Output

Done	Description	If True, then the command completed successfully.
	Date Type	BOOL
Error	Description	If True, then an error has occurred.

	Date Type	BOOL
ErrorID	Description	Indicates the error if Error output is set to TRUE. See the table in PLCopen Function Block ErrorID Output .
	Date Type	INT

2.3.12.0.4 Example

Calls to this function block are automatically generated when the application is compiled. Users should not manually call this function block.

2.3.13 Structured Text

```
Inst_MC_CreateAxesGrp( DoExecute, 'Group1', UpdateRate_3, MaxAxes,
Group1_Ref);
```

2.3.14 Instruction List

```
BEGIN_IL
CAL Inst_MC_CreateAxesGrp1(DoExecute, 'Group1', UpdateRate_3,
MaxAxes, Group1_Ref)
END_IL
```

2.3.15 Function Block Diagram

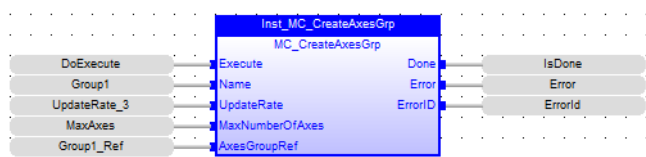

2.3.16 Ladder Diagram

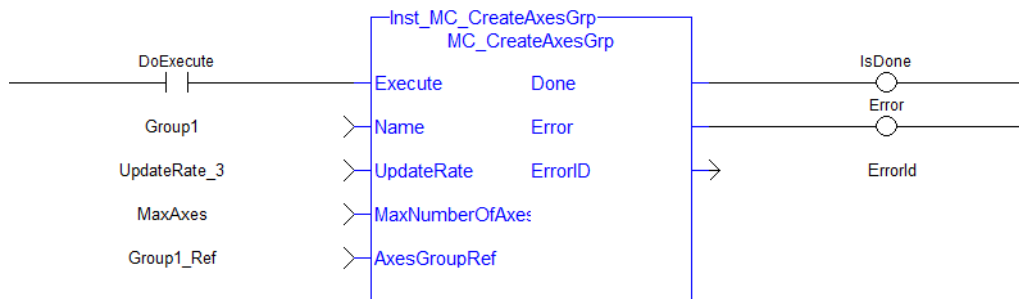

2.3.16.0.1 MC_GrpDisable PLCopen ✓ Pipe Network ✓

2.3.16.0.1.1 Description

MC_GrpDisable changes the state for a group to GroupDisabled. If the group is already in GroupDisabled, then MC_GrpDisable will do nothing. This function block can be issued in the group states: (GroupDisabled, GroupStandby, or GroupErrorStop).

NOTE
MC_GrpDisable will fail if the group is in any state other than GroupStandby or GroupDisabled.

Refer to [Group State Diagrams](#) for details.

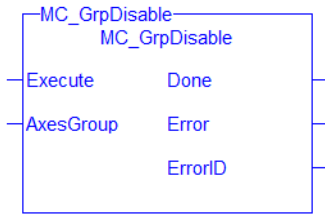

Figure 1-100: MC_GrpDisable

NOTE

This function block starts a motion-related action and therefore stores data for calculations and error checking. Please see [Calling Function Blocks Multiple Times in the Same Cycle](#) if you are using a dual-core controller.

2.3.17 Related Functions

[Related Functions](#), [MC_ErrorDescription](#)

See also "Coordinated Motion", the top-level topic for Coordinated Motion.

2.3.17.0.0.1 Arguments

2.3.18 Input

Execute	Description	On the rising edge, request to disable the axis group.
	Data Type	BOOL
	Range	0, 1
	Unit	N/A
	Default	—
AxesGroup	Description	The axis group to be disabled
	Data Type	AXIS_GROUP_REF
	Range	N/A
	Unit	N/A
	Default	—

2.3.19 Output

Done	Description	If True, then the command completed successfully.
	Data Type	BOOL
Error	Description	If True, then an error has occurred.
	Data Type	BOOL

ErrorID	Description	Indicates the error if Error output is set to TRUE. See the table in PLCopen Function Block ErrorID Output
	Data Type	INT

2.3.19.0.0.1 Example

2.3.20 ST

```
(* Inst_MC_GrpDisableST example *)
Inst_MC_GrpDisable( DisableGroup, Group1_Ref );
```

2.3.21 IL

```
BEGIN_IL
    CAL Inst_MC_GrpDisable( DisableGroup, Group1_Ref )
END_IL
```

2.3.22 FBD



2.3.23 FFLD

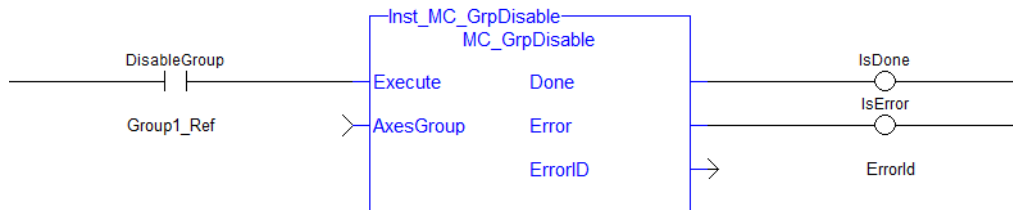

2.3.23.0.1 MC_GrpEnable

PLCopen ✓ **Pipe Network** ✓

2.3.23.0.1.1 Description

MC_GrpEnable changes the state of a group from GroupDisabled to GroupStandby. If the group is already in GroupStandby, then MC_GrpEnable will do nothing.

NOTE
The group must be in GroupStandby in order to perform motion.

MC_GrpEnable will fail under the following conditions.

- It contains no axes
- The group is not in GroupDisabled or GroupStandby
- One or more axes in the group are in another group that is not in GroupDisabled.

Refer to [Group State Diagrams](#) for more details.

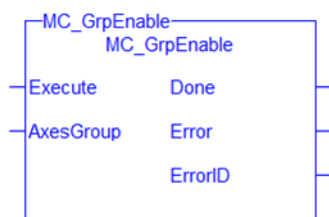

Figure 1-101: MC_GrpEnable

NOTE

This function block starts a motion-related action and therefore stores data for calculations and error checking. Please see [Calling Function Blocks Multiple Times in the Same Cycle](#) if you are using a dual-core controller.

2.3.24 Related Functions

[Related Functions](#), [MC_ErrorDescription](#)

See also "Coordinated Motion", the top-level topic for Coordinated Motion.

2.3.24.0.0.1 Arguments**2.3.25 Input**

Execute	Description	On the rising edge, request to enable the axis group
	Data Type	BOOL
	Range	0, 1
	Unit	N/A
	Default	—
AxesGroup	Description	The axis group to be enabled
	Data Type	AXIS_GROUP_REF
	Range	N/A
	Unit	N/A
	Default	—

2.3.26 Output

Done	Description	If True, then the command completed successfully.
	Data Type	BOOL
Error	Description	If True, an error has occurred.
	Data Type	BOOL

ErrorID	Description	Indicates the error if Error output is set to TRUE. See the table in PLCopen Function Block ErrorID Output
	Data Type	INT

2.3.26.0.0.1 Example

2.3.27 Structured Text

```
(* Inst_MC_GrpEnableST example *)
Inst_MC_GrpEnable( EnableGroup, Group1_Ref );
```

2.3.28 IL

```
BEGIN_IL
    CAL Inst_MC_GrpEnable( EnableGroup, Group1_Ref )
END_IL
```

2.3.29 FBD



2.3.30 FFLD

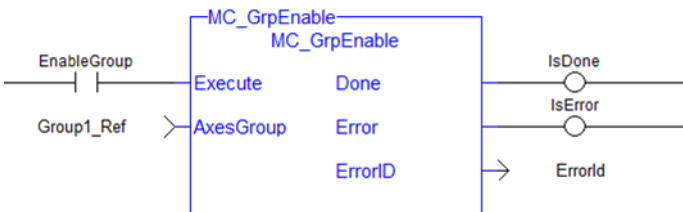

2.3.30.0.1 MC_GrpReadBoolPar



2.3.30.0.1.1 Description

This function block reads a value from the specified Boolean group parameter. See [Recovery of the System State After an Axis Error](#) for more information.

MC_GrpReadBoolPar(Axesgroup_Ref GroupID, Uint BoolID) where BoolID can be one of the following 2 currently defined Booleans:

IGNORE_AXIS_ESTOP: ID = 1000 : The value read will be either TRUE or False as set by the MC_GrpWriteBoolPar function block.

AXIS_ESTOP_ACTIVE: ID = 1001 : This Read-only parameter will be asserted TRUE whenever an axis in the group is experiencing an Axis Estop Error. When there are no Axis Estop Errors present on the axes in a group, this parameter will be set to FALSE.

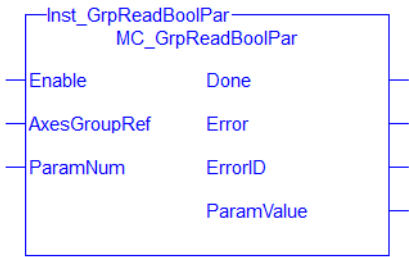

Figure 1-102: MC_GrpReadBoolPar

NOTE

This function or function block returns cached data. See [Programming a Dual Core Controller](#) for more information.

2.3.31 Related Function Blocks

[Related Function Blocks,MC_ErrorDescription](#)

See also "Coordinated Motion", the top-level topic for Coordinated Motion.

2.3.31.0.0.1 Arguments

For more details on how inputs and outputs work, refer to [PLCopen Function Blocks - General Rules](#).

2.3.32 Input

Enable	Description	If True, then request to read a value from the specified Boolean group parameter.
	Data Type	BOOL
	Range	0, 1
	Unit	N/A
	Default	—
AxesGroupRef	Description	The axis group that the Boolean parameter value will be read from.
	Data Type	AXES_GROUP_REF
	Range	N/A
	Unit	N/A
	Default	—

ParamNum	Description	ParamNum can be one of the following two currently defined Booleans: <ul style="list-style-type: none"> IGNORE_AXIS_ESTOP: ID = 1000 : The value read will be either TRUE or False as set by the MC_GrpWriteBoolPar function block. AXIS_ESTOP_ACTIVE: ID = 1001 : This Read-only parameter will be asserted TRUE whenever an axis in the group is experiencing an Axis Estop Error. When there are no Axis Estop Errors present on the axes in a group, this parameter will be set to FALSE.
	Data Type	UINT
	Range	1000, 1001
	Unit	UINT
	Default	—

2.3.33 Output

Done	Description	If True, then the command completed successfully.
	Data Type	BOOL
Error	Description	If True, an error has occurred.
	Data Type	BOOL
ErrorID	Description	Indicates the error if Error output is set to TRUE. See the table in PLCopen Function Block ErrorID Output .
	Data Type	INT
ParamValue	Description	True or False
	Data Type	BOOL

2.3.33.0.0.1 Example

2.3.34 ST

```
Inst_GrpReadBoolPar( DoEnable, Group1_Ref, AXIS_ESTOP_ACTIVE );
```

2.3.35 IL

```

BEGIN_IL
  Cal Inst_GrpReadBoolPar( DoEnable, Group1_Ref, AXIS_ESTOP_ACTIVE )
END_IL

```

2.3.36 FBD



2.3.37 FFLD

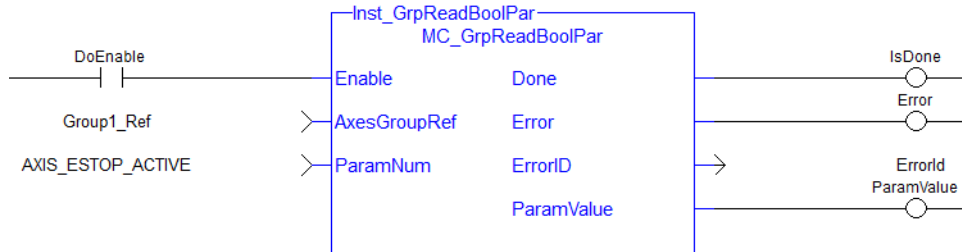

2.3.37.0.1 MC_GrpReadParam



This function block reads the value of the specified group parameter.

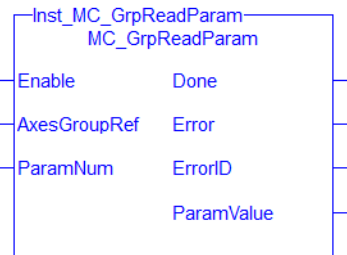

Figure 1-103: MC_GrpReadParam

NOTE

This function or function block returns cached data. See [Programming a Dual Core Controller](#) for more information.

Related Function Blocks

Input, MC_ErrorDescription

See also "Coordinated Motion", the top-level topic for Coordinated Motion.

2.3.37.0.1.1 Arguments

For more details on how inputs and outputs work, refer to PLCopen Function Blocks - General Rules.

2.3.38 Input

Enable	Description	If True, then request to read a value from the specified group parameter.
	Data Type	BOOL
	Range	0,1
	Unit	N/A
	Default	—

AxesGroupRef	Description	The axis group that the parameter value will be read from.
	Data Type	AXIS_GROUP_REF
	Range	N/A
	Unit	N/A
	Default	—
ParamNum	Description	Currently, only one parameter is supported: MC_GRP_PARAM_CIRCLE_TOLERANCE: (ID = 2000): The value read will be the axes group circle construction tolerance. See Precision Requirements for Circular Move Input Parameters for more information.
	Data Type	LREAL
	Range	See Axes Group Parameters
	Unit	LREAL
	Default	—

2.3.39 Output

Done	Description	If True, then the command completed successfully.
	Data Type	BOOL
Error	Description	If True, an error has occurred.
	Data Type	BOOL
ErrorID	Description	Indicates the error if Error output is set to TRUE. See the table in PLCopen Function Block ErrorID Output.
	Data Type	INT
ParamValue	Description	The value of the group parameter.
	Data Type	LREAL

2.3.39.0.0.1 Examples

2.3.40 ST

```

Inst_MC_GrpReadParam( DoEnable, Group1_ref, MC_GRP_PARAM_CIRCLE_TOLERANCE
);
CircleTolerance := Inst_MC_GrpReadParam.ParamValue;

```

2.3.41 FBD

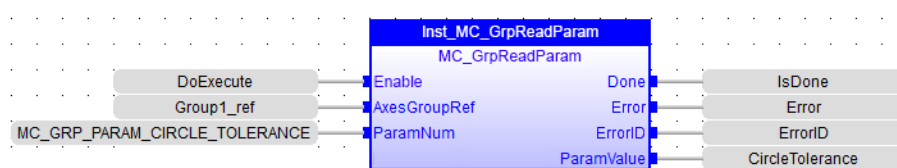

2.3.42 FFLD

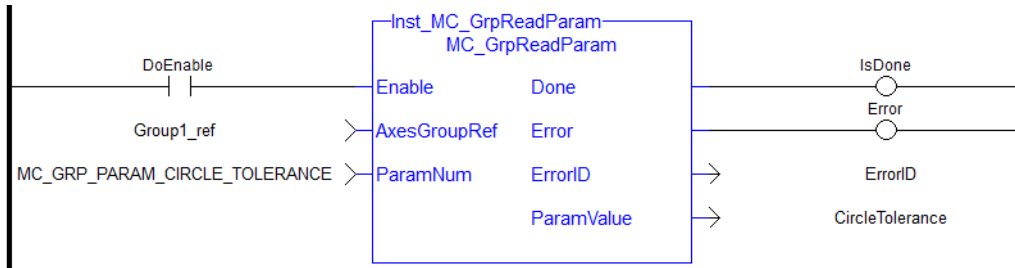

2.3.42.0.1 MC_GrpReset



2.3.42.0.1.1 Description

This function block makes the transition from the state GroupErrorStop to GroupStandby by resetting all internal group-related errors – it does not affect the output of the FB instances. This function block also resets axis errors and drive faults for each axis in the group. This function block does not cause any motion.

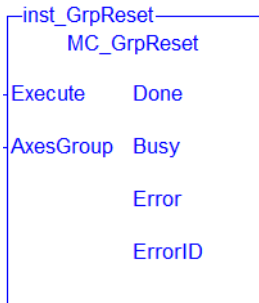

Figure 1-104: MC_GrpReset

NOTE

This function block starts a motion-related action and therefore stores data for calculations and error checking. Please see [Calling Function Blocks Multiple Times in the Same Cycle](#) if you are using a dual-core controller.

2.3.43 Related Functions

[Related Functions](#), [Related Functions](#), [MC_ErrorDescription](#)

See also "Coordinated Motion", the top-level topic for Coordinated Motion.

2.3.43.0.0.1 Arguments

For more details on how inputs and outputs work, refer to [PLCopen Function Blocks - General Rules](#).

2.3.44 Input

Execute	Description	On the rising edge, this FB resets group-related errors and all of the axes in the group.
	Data Type	BOOL
	Range	0, 1
	Unit	N/A

	Default	—
AxesGroup	Description	The axes group in which the axes will be reset.
	Data Type	AXES_GROUP_REF
	Range	N/A
	Unit	N/A
	Default	—

2.3.45 Output

Done	Description	If True, then the reset completed successfully.
	Data Type	BOOL
Busy	Description	If True, then the FB is executing.
	Data Type	BOOL
Error	Description	If True, an error has occurred.
	Data Type	BOOL
ErrorID	Description	Indicates the error identifier if Error output is set to TRUE. See table in PLCopen Function Block ErrorID Output .
	Data Type	INT

2.3.45.0.0.1 Example

2.3.46 ST

```
Inst_MC_GrpReset ( EnableReset, Group1_Ref );
```

2.3.47 FBD

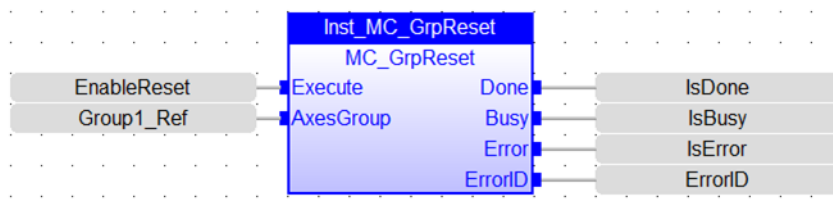

2.3.48 IL

```
BEGIN_IL
  CAL Inst_MC_GrpReset ( EnableReset, Group1_Ref )
END_IL
```

2.3.49 FFLD

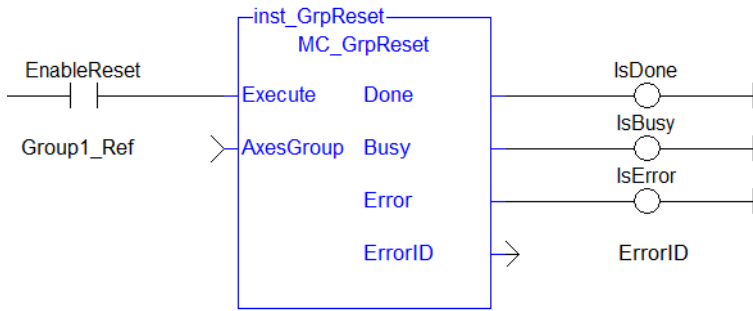

2.3.49.0.1 MC_GrpStop PLCopen ✓ Pipe Network ✓

2.3.49.0.1.1 Description

MC_GrpStop performs a controlled motion stop of all axes in the group. When the path velocity reaches zero any queued moves are flushed from the buffer and the Done output is set. When both the Done output is true and the application has cleared the Execute input the state transitions to GroupStandby. MC_GrpStop *can not be aborted*.

NOTE
MC_GrpStop does NOT prevent a single axis from executing nor does it prevent other Coordinated Motion moves from executing once MC_GrpStop has completed.

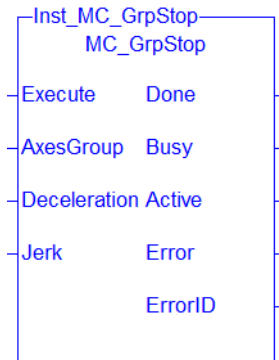

NOTE
This function block starts a motion-related action and therefore stores data for calculations and error checking. Please see [Calling Function Blocks Multiple Times in the Same Cycle](#) if you are using a dual-core controller.

2.3.50 Related Functions

Related Functions, [MC_ErrorDescription](#)

See also "Coordinated Motion", the top-level topic for Coordinated Motion.

2.3.50.0.1 Arguments

For more details on how inputs and outputs work, refer to [PLCopen Function Blocks - General Rules](#).

2.3.51 Input

Execute	Description	On the rising edge the command to stop all of the axes in the group is initiated.
	Data type	BOOL

	Range	0, 1
	Unit	N/A
	Default	—
AxesGroup	Description	The axes group in which the axes will be stopped.
	Data type	AXES_GROUP_REF
	Range	N/A
	Unit	N/A
	Default	—
Deceleration	Description	The path deceleration rate for all of the axes in the group
	Data type	LREAL
	Range	0 < Deceleration See Limitations on Acceleration and Jerk for more information.
	Unit	N/A
	Default	—
JerK	Description	Not supported
	Data type	LREAL
	Range	0 ≤ Jerk See Limitations on Acceleration and Jerk for more information.
	Unit	N/A
	Default	—

2.3.52 Output

Done	Description	If True, then the command completed successfully.
	Data type	BOOL
Busy	Description	TRUE from the moment the EXECUTE input is TRUE until the stop is complete.
	Data type	BOOL
Active	Description	If True, then the stop is still executing.
	Data type	BOOL
Error	Description	If True, an error has occurred.
	Data type	BOOL

ErrorID	Description	Indicates the error identifier if Error output is set to TRUE. See table in PLCopen Function Block ErrorID Output .
	Data type	INT

2.3.52.0.1 Example

2.3.53 Structured Text

```
Inst_MC_GrpStop ( EnableStop, Group1_Ref, Deceleration, Jerk );
```

2.3.54 IL

```

    BEGIN_IL
    CAL Inst_MC_GrpStop ( EnableStop, Group1_Ref, Deceleration, Jerk )
    END_IL

```

2.3.55 FBD

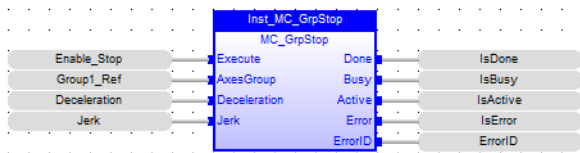

2.3.56 FFLD

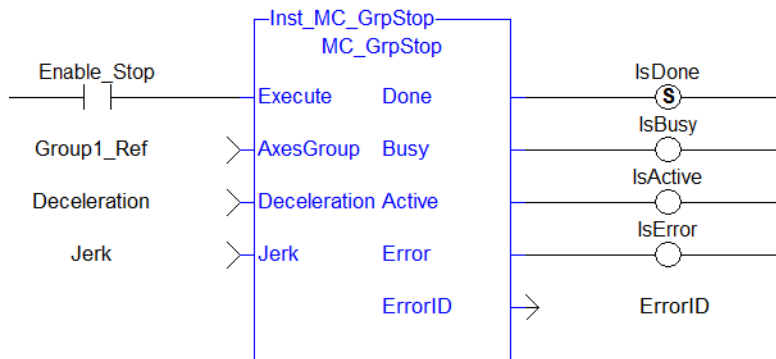

2.3.56.0.1 MC_GrpWriteBoolPar PLCopen ✓ Pipe Network ✓

2.3.56.0.1.1 Description

This function block writes a value to the specified Boolean group parameter. See [Recovery of the System State After an Axis Error](#) for more information.

IGNORE_AXIS_ESTOP (BoolID = 1000), and the Value can be either TRUE or FALSE.

- Setting this Boolean Parameter to TRUE will result in the Coordinated Motion Engine NOT stopping all axes in a group when one of them is stopped due to an Axis Estop Error. Only the axis experiencing the error will stop when this Parameter is set to TRUE.
- When this parameter is FALSE (Default), all axes in a group will be stopped and the power off request is asserted for each axis.

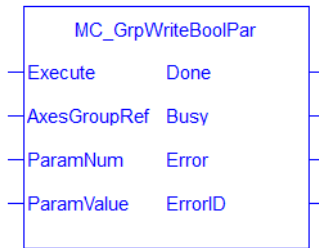

Figure 1-105: MC_GrpWriteBoolPar

NOTE

This function or function block returns cached data. See [Programming a Dual Core Controller](#) for more information.

2.3.57 Related Function Blocks

Related Function Blocks, [MC_ErrorDescription](#)

See also "Coordinated Motion", the top-level topic for Coordinated Motion.

2.3.57.0.0.1 Arguments

For more details on how inputs and outputs work, refer to [PLCopen Function Blocks - General Rules](#).

2.3.58 Input

Execute	Description	On the rising edge, request to write a value to the specified Boolean group parameter.
	Data Type	BOOL
	Range	0, 1
	Unit	N/A
	Default	—
AxesGroupRef	Description	The axis group that the Boolean parameter value will be written to.
	Data Type	AXES_GROUP_REF
	Range	N/A
	Unit	N/A
	Default	—
ParamNum	Description	The ID number of the Boolean parameter that is to be written IGNORE_AXIS_ESTOP (BoolID = 1000)
	Data Type	UINT
	Range	
	Unit	
	Default	

ParamValue	Description	True or false
	Data Type	BOOL
	Range	0, 1
	Unit	N/A
	Default	—

2.3.59 Output

Done	Description	If True, then the command completed successfully.
	Data Type	BOOL
Busy	Description	If True, then the function block is executing.
	Data Type	BOOL
Error	Description	If True, an error has occurred.
	Data Type	BOOL
ErrorID	Description	Indicates the error if Error output is set to TRUE. See the table in PLCopen Function Block ErrorID Output .
	Data Type	INT

2.3.59.0.0.1 Example

2.3.60 ST

```
Inst_MC_GrpWriteBoolPar( ExecuteWrite, Group1Ref, IGNORE_AXIS_ESTOP, true
);
```

2.3.61 IL

```

    BEGIN_IL
    Cal Inst_MC_GrpWriteBoolPar( ExecuteWrite, Group1Ref, IGNORE_AXIS_
ESTOP, true )
    END_IL

```

2.3.62 FBD

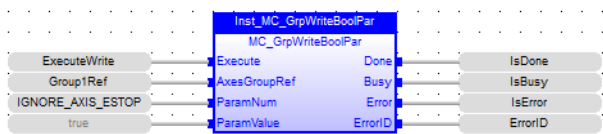

2.3.63 FFLD

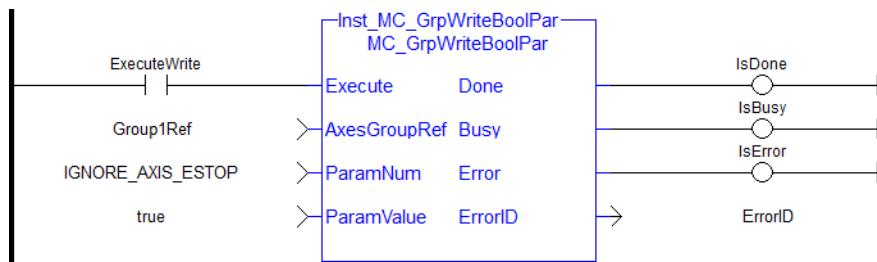

2.3.63.0.1 MC_GrpWriteParam PLCopen ✓ Pipe Network ✓

This function block writes a value to the specified group parameter.

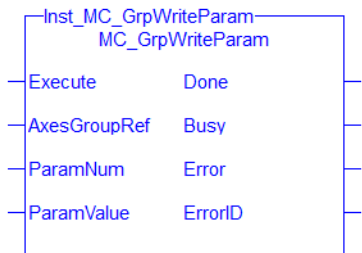

Figure 1-106: MC_GrpWriteParam

NOTE
 This function or function block returns cached data. See [Programming a Dual Core Controller](#) for more information.

Related Function Blocks

[Input, MC_ErrorDescription](#)

See also "Coordinated Motion", the top-level topic for Coordinated Motion.

2.3.63.0.1.1 Arguments

For more details on how inputs and outputs work, refer to PLCopen Function Blocks - General Rules.

2.3.64 Input

Execute	Description	On the rising edge, request to write a value to the specified group parameter.
	Data Type	BOOL
	Range	0,1
	Unit	N/A
	Default	—
AxesGroupRef	Description	The axis group that the parameter value will be written to.
	Data Type	AXIS_GROUP_REF
	Range	N/A
	Unit	N/A

	Default	—
ParamNum	Description	Currently, only one parameter is supported: MC_GRP_PARAM_CIRCLE_TOLERANCE: (ID = 2000): The value read will be the axes group circle construction tolerance. See Precision Requirements for Circular Move Input Parameters for more information.
	Data Type	LREAL
	Range	See Axes Group Parameters
	Unit	LREAL
	Default	—
ParamValue	Description	The new value for the group parameter
	Data Type	LREAL
	Range	parameter dependent
	Unit	parameter dependent
	Default	—

2.3.65 Output

Done	Description	If True, then the command completed successfully.
	Data Type	BOOL
Busy	Description	If True, then the function block is executing.
	Data Type	BOOL
Error	Description	If True, an error has occurred.
	Data Type	BOOL
ErrorID	Description	Indicates the error if Error output is set to TRUE. See the table in PLCopen Function Block ErrorID Output.
	Data Type	INT

2.3.65.0.0.1 Examples

2.3.66 ST.

```
Inst_MC_GrpWriteParam( DoExecute, Group1_ref, MC_GRP_PARAM_CIRCLE_TOLERANCE, CircleTolerance );
```

2.3.67 FBD

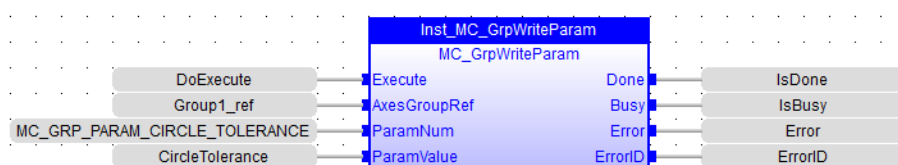

2.3.68 FFLD

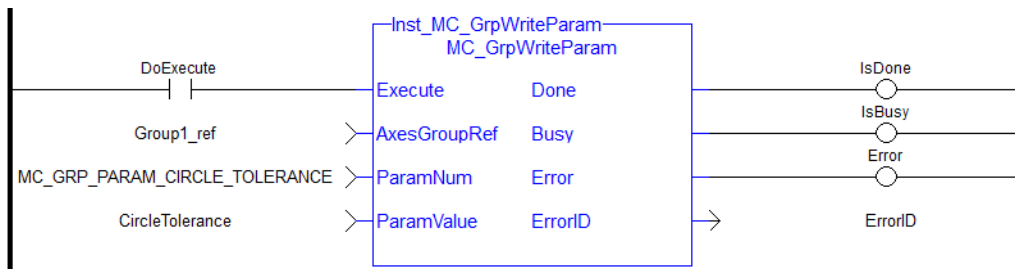

2.3.68.0.1 MC_InitAxesGrp



2.3.68.0.1.1 Description

MC_InitAxesGrp initializes the kinematic limits for the axis group. During a move, the motion engine verifies that the limits are not exceeded.

NOTE
The function block returns an error if the group state is not GroupStandby or GroupDisabled.

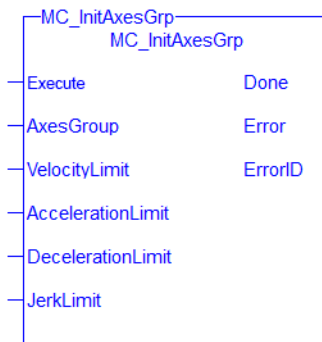

Figure 1-107: MC_InitAxesGrp

2.3.69 Related Function Blocks

[Related Function Blocks, MC_ErrorDescription](#)

See also "Coordinated Motion", the top-level topic for Coordinated Motion.

2.3.69.0.0.1 Arguments

2.3.70 Inputs

Execute	Description	On the rising edge, this function block will initialize the axis group.
	Data type	BOOL
	Range	0, 1
	Unit	N/A
	Default	—
AxesGroup	Description	The axis group to be initialized
	Data type	AXIS_GROUP_REF

	Range	N/A
	Unit	N/A
	Default	—
VelocityLimit	Description	Velocity limit
	Data type	LREAL
	Range	$0 < \text{Velocity} < (20 * \text{Acceleration})$ and $0 < \text{Velocity} < (20 * \text{Deceleration})$ See Limitations on Acceleration and Jerk for more information.
	Unit	user units per second
	Default	—
AccelerationLimit	Description	Acceleration limit
	Data type	LREAL
	Range	$0 < \text{Velocity} < (20 * \text{Acceleration})$ See Limitations on Acceleration and Jerk for more information.
	Unit	user units per second ²
	Default	—
DecelerationLimit	Description	Deceleration limit
	Data type	LREAL
	Range	$0 < \text{Velocity} < (20 * \text{Deceleration})$ See Limitations on Acceleration and Jerk for more information.
	Unit	User units per second ²
	Default	—
Jerklimit	Description	Jerklimit
	Data type	LREAL
	Range	$(\text{Velocity} / 20) < \text{Acceleration} < (2 * \text{Jerk})$ and $(\text{Velocity} / 20) < \text{Deceleration} < (2 * \text{Jerk})$ See Limitations on Acceleration and Jerk for more information.
	Unit	User units per second ³
	Default	

2.3.71 Outputs

Done	Description	If True, then the command completed successfully.
-------------	--------------------	---

	Data type	BOOL
Error	Description	If True, then an error has occurred.
	Data type	BOOL
ErrorID	Description	Indicates the error if Error output is set to TRUE. See the table in PLCopen Function Block ErrorID Output
	Data type	INT

2.3.71.0.0.1 Example

2.3.72 Structured Text

```
(* Inst_MC_InitAxesGrpST example *)
Inst_MC_InitAxesGrp( initAxesGrp, grp, velLim, accelLim, decelLim,
jerkLim );
```

2.3.73 IL

```
BEGIN_IL
CAL Inst_MC_InitAxesGrp( initAxesGrp, grp, velLim, accelLim,
decelLim, jerkLim )
END_IL
```

2.3.74 FBD

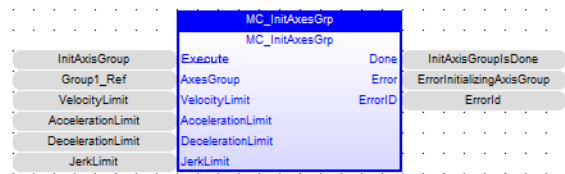

2.3.75 FFLD

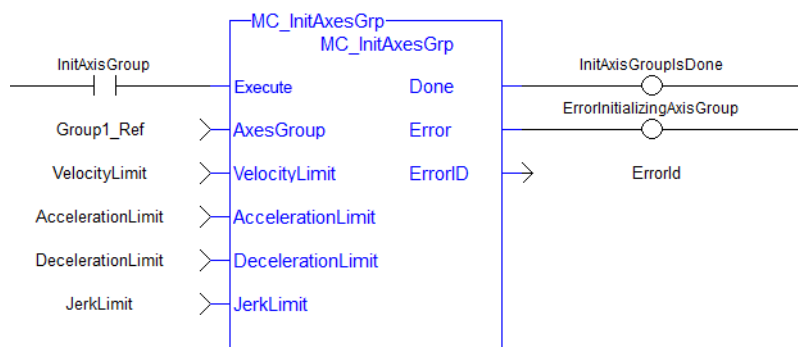

2.3.75.0.1 MC_RemAxisFromGrp



2.3.75.0.1.1 Description

MC_RemAxisFromGrp removes a single axis from a group. This function block can be issued in the group states: (GroupDisabled, GroupStandby, or GroupErrorStop). The group's state will change to GroupDisabled if the axis removed is the last valid axis in the group. This function block does not cause any motion.

NOTE

MC_RemAxisFromGrp will fail if the group is in any state other than GroupStandby or GroupDisabled.

Refer to [Group State Diagrams](#) for details.

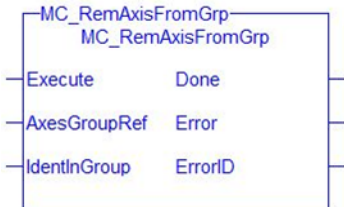

Figure 1-108: MC_RemAxisFromGrp

2.3.76 Related Functions

[Related Functions](#), [Related Functions](#), [MC_ErrorDescription](#)

See also "Coordinated Motion", the top-level topic for Coordinated Motion.

NOTE

This function block starts a motion-related action and therefore stores data for calculations and error checking. Please see [Calling Function Blocks Multiple Times in the Same Cycle](#) if you are using a dual-core controller.

2.3.76.0.0.1 Arguments

2.3.77 Input

Execute	Description	On the rising edge, request to remove an axis from the group
	Data type	BOOL
	Range	0, 1
	Unit	N/A
	Default	—
AxesGroupRef	Description	The axis group from which the axis will be removed
	Data type	AXIS_GROUP_REF
	Range	N/A
	Unit	N/A
	Default	—

IdentInGroup	Description	The zero-based index of the axis in the group. <ul style="list-style-type: none"> The axis index in the group must contain a valid axis The index must be less than the maximum number of axes the group can contain. <code>MaxNumberOfAxes</code> is a property of the axes group and is set when the group is created.
	Data type	UINT
	Range	[0, MaxNumberOfAxes - 1]
	Unit	N/A
	Default	—

2.3.78 Output

Done	Description	If True, then the command completed successfully.
	Data type	BOOL
Error	Description	If True, an error has occurred.
	Data type	BOOL
ErrorID	Description	Indicates the error identifier if Error output is set to True. See the table in PLCopen Function Block ErrorID Output .
	Data type	INT

2.3.78.0.0.1 Example

2.3.79 ST

```
(* Inst_MC_InitAxisGrpST example *)
Inst_MC_RemAxisFromGrp( ExecuteRemAxisFromGrp, Group1_Ref, AxisId );
```

2.3.80 IL

```

      BEGIN_IL
          CAL Inst_MC_RemAxisFromGrp( ExecuteRemAxisFromGrp, Group1_Ref,
AxisId )
      END_IL

```

2.3.81 FBD



2.3.82 FFLD



2.3.82.0.1 MC_SetKinTra PLCopen

2.3.82.0.1.1 Description

This function block sets the kinematic transform between the Machine Coordinate System and the Axes Coordinate System. It is useful for robotics, allowing the application to command motion in Cartesian coordinates for the robotic system.

After MC_SetKinTra(...) is called, the controller will automatically calculate the inverse kinematics for the robot axes, converting the robot path motion into the individual robot joint axis trajectories. Several transform types are available for common robotic systems and are configurable with the [MC_KIN_REF Structure](#). The parameters in the MC_KIN_REF structure define the specific robot geometry.

TIP

Description of the structure may be found in [MC_KIN_REF Structure](#).

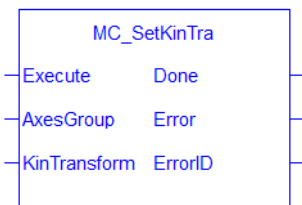

Figure 1-109: MC_SetKinTra

2.3.82.0.1.2 Arguments

2.3.83 Input

Execute	Description	On the rising edge, request to load the kinematic transform.
	Data type	BOOL
	Range	0, 1
	Unit	N/A
	Default	N/A
AxesGroup	Description	The axis group that will receive the axis trajectory values from the kinematic transform.
	Data type	AXIS_GROUP_REF
	Range	N/A
	Unit	N/A
	Default	N/A

KinTransform	Description	Kinematic robotic transform defined by the MC_KIN_REF Structure
	Data type	MC_KIN_REF
	Range	N/A
	Unit	N/A
	Default	N/A

2.3.84 Output

Done	Description	If True, then the command completed successfully.
	Data type	BOOL
Error	Description	If True, an error has occurred.
	Data type	BOOL
ErrorID	Description	Indicates the error if Error output is set to TRUE. See table in PLCopen Function Block ErrorID Output
	Data type	INT

2.3.84.0.1 Example

2.3.85 Structured Text

```
// MC_SetKinTra ST Example

// DeltaBotTransform is of type MC_KIN_REF

DeltaBotTransform.TransformType := MC_TRANSFORM_TYPE_DELTA;
DeltaBotTransform.KinParameters[MC_DELTA_KIN_PARAM_RADIUS_BASE_LENGTH] :=
10.0;
DeltaBotTransform.KinParameters[MC_DELTA_KIN_PARAM_RADIUS_END_LENGTH] :=
2.0;
DeltaBotTransform.KinParameters[MC_DELTA_KIN_PARAM_MOTOR_ARM_LENGTH] :=
5.0;
DeltaBotTransform.KinParameters[MC_DELTA_KIN_PARAM_END_ARM_LENGTH] :=
25.0;

Inst_MC_SetKinTra(True, DeltaBotAxesGrp, DeltaBotTransform);

// ...

Inst_MC_MoveLinAbs(True, DeltaBotAxesGrp, PositionList, DeltaBotVel,
DeltaBotAcc, DeltaBotDec, LREAL#0.0, MC_COORDINATE_SYSTEM_MCS, MC_BUFFER_
MODE_ABORTING, MC_TRANSITION_MODE_NONE, EmptyTransitionParams);
```

2.3.86 Function Block Diagram

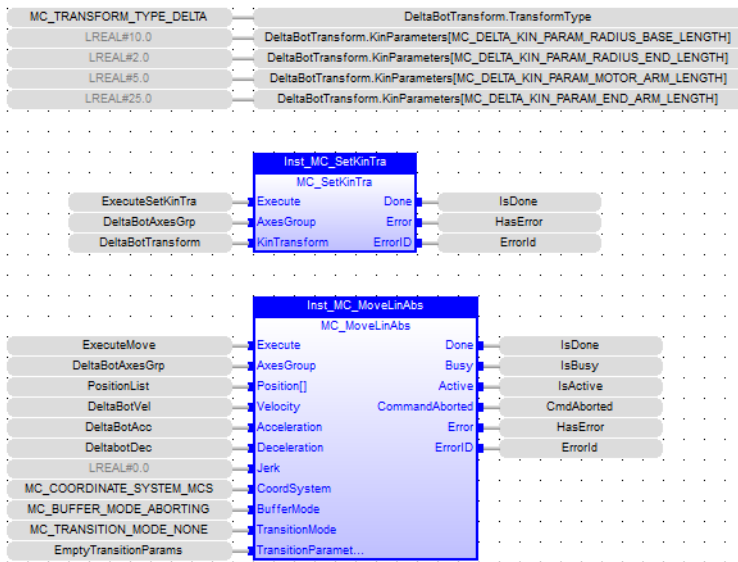

2.3.87 Ladder Diagram

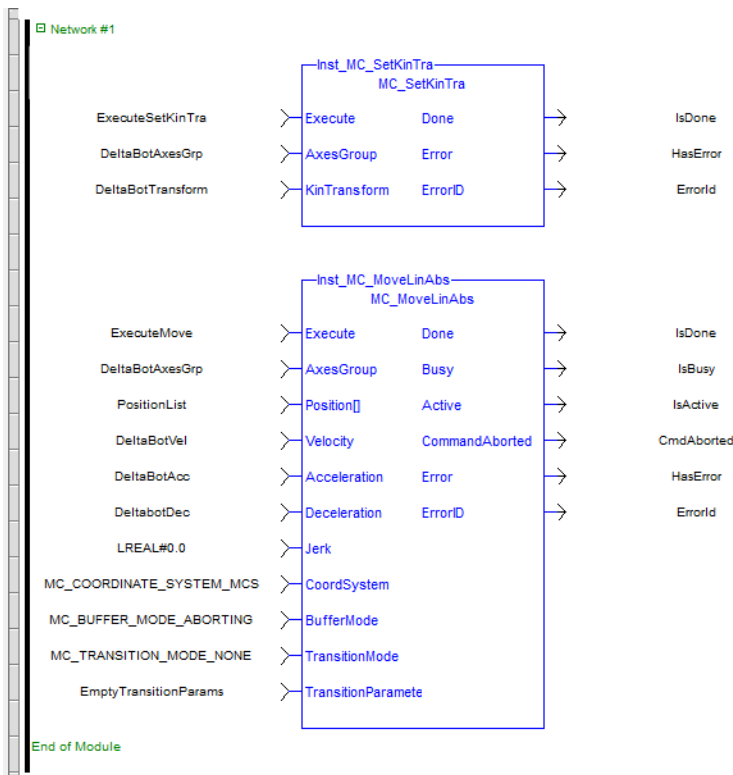

2.3.87.0.1 MC_UngroupAllAxes



2.3.87.0.1.1 Description

MC_UngroupAllAxes removes all axes from an axes group. This function block can be issued in the group states: (GroupDisabled, GroupStandby, or GroupErrorStop). The axes group state will be changed to GroupDisabled upon successful completion. This function block does not cause any motion.

NOTE

MC_UngroupAllAxes will fail if the group is in any state other than GroupStandby or GroupDisabled.

Refer to [Group State Diagrams](#) for details.

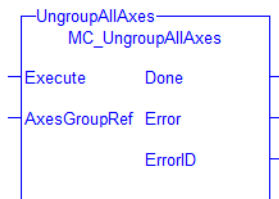

Figure 1-110: MC_UngroupAllAxes

2.3.88 Related Functions

[Related Functions](#), [Related Functions](#), [MC_ErrorDescription](#)

See also "Coordinated Motion", the top-level topic for Coordinated Motion.

NOTE

This function block starts a motion-related action and therefore stores data for calculations and error checking. Please see [Calling Function Blocks Multiple Times in the Same Cycle](#) if you are using a dual-core controller.

2.3.88.0.0.1 Arguments

2.3.89 Input

Execute	Description	On the rising edge, request to remove all axes in the axes group
	Data type	BOOL
	Range	0, 1
	Unit	N/A
	Default	—
AxesGroupRef	Description	The axis group from which to remove all axes
	Data type	AXIS_GROUP_REF
	Range	N/A
	Unit	N/A
	Default	—

2.3.90 Output

Done	Description	If True, then the command completed successfully.
	Data type	BOOL
Error	Description	If True, an error has occurred
	Data type	BOOL

ErrorID	Description	Indicates the error identifier if 'Error' output is set to TRUE. See the table in PLCopen Function Block ErrorID Output .
	Data type	INT

2.3.90.0.1 Examples

2.3.91 ST

```
Inst_MC_UngroupAllAxes( ExecuteUngroup, Group1_Ref );
```

2.3.92 IL

```
BEGIN_IL
    CAL Inst_MC_UngroupAllAxes( ExecuteUngroup, Group1_Ref )
END_IL
```

2.3.93 FBD



2.3.94 FLD

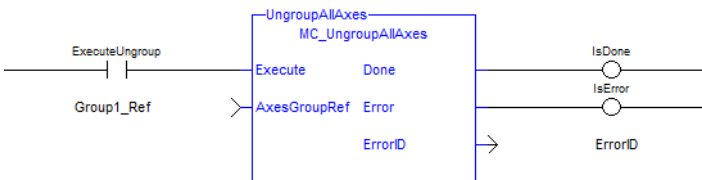

2.3.94.0.1 MC_KIN_REF Structure

The MC_KIN_REF structure defines the robotic system transform type and its parameters. The parameters are specific to each transform type. The general MC_KIN_REF structure is described below, with further parameter specific descriptions for each robotic transform type.

Member	Type	Description	Related Function Blocks
TransformType	UINT	A number that identifies the specific robotic system transform. The #defines for the transform types (MC_TRANSFORM_TYPE_GANTRY, MC_TRANSFORM_TYPE_DELTA, etc.) are listed below.	Input
KinParameters [0 - 31]	LREAL	An array of up to 32 parameters to define the robotic system and its kinematic transform. The parameter count (0 to 32) and the definition of each parameter is determined by the specific TransformType	Input

These parameters must be specified for all ACS axes in the AxisGroup, and there are two parameters for each ACS axis.

TransformType	Axis Mapping	Parameter Count	Parameter #	Description	Range
MC_TRANSFORM_TYPE_GANTRY		1	MC_GANTRY_KIN_PARAM_REVERSE_X	Reverse X-axis	0 = do not reverse 1 = reverse
MC_TRANSFORM_TYPE_GANTRY_WITH_SKEW		3	MC_GANTRY_WITH_SKEW_KIN_PARAM_REVERSE_X	Reverse X-axis	0 = do not reverse 1 = reverse
			MC_GANTRY_WITH_SKEW_KIN_PARAM_SKEW_SCALE	Skew to linear unit ratio	Positive value
			MC_GANTRY_WITH_SKEW_KIN_PARAM_REVERSE_SKEW	Reverse Skew-axis	0 = do not reverse 1 = reverse

Transform Type	Axis Mapping	Parameter Count	Parameter #	Description	Range
MC_TRANSFORM_TYPE_HBOT		3	MC_HBOT_KIN_PARAM_LIN_TO_ROT_RATIO	Linear to rotational unit ratio (ex: cm/degree)	Positive value
			MC_HBOT_KIN_PARAM_REVERSE_X	Reverse X-axis	0 = do not reverse 1 = reverse
			MC_HBOT_KIN_PARAM_REVERSE_Y	Reverse Y-axis	0 = do not reverse 1 = reverse
MC_TRANSFORM_TYPE_TBOT		3	MC_TBOT_KIN_PARAM_LIN_TO_ROT_RATIO	Linear to Rotational unit ratio (ex: cm/degree)	Positive value
			MC_TBOT_KIN_PARAM_REVERSE_X	Reverse X-axis	0 = do not reverse 1 = reverse
			MC_TBOT_KIN_PARAM_REVERSE_Z	Reverse Y-axis	0 = do not reverse 1 = reverse

Transform Type	Axis Mapping	Parameter Count	Parameter #	Description	Range
MC_TRANSFORM_TYPE_DELTA * Experimental *		4	MC_DELTA_KIN_PARAM_RADIUS_BASE_LENGTH	RadiusBaseLength	Positive, non-zero value
			MC_DELTA_KIN_PARAM_RADIUS_END_LENGTH	RadiusEndLength	
			MC_DELTA_KIN_PARAM_MOTOR_ARM_LENGTH	MotorArmLength	
			MC_DELTA_KIN_PARAM_END_ARM_LENGTH	EndArmLength	
MC_TRANSFORM_TYPE_SCARA_ELBOW_POS * Experimental *		2 or 3 The parameter count is depend on axis number of the AxisGroup. <ul style="list-style-type: none"> • 2 AxesGroup: 2 Parameters. (No Wrist) • 3 AxesGroup: 3 Parameters. (with Wrist) 	MC_SCARA_KIN_PARAM_UPPER_ARM_LENGTH	RobotUpperArmLength	Positive, non-zero value
			MC_SCARA_KIN_PARAM_LOWER_ARM_LENGTH	RobotLowerArmLength	
			MC_SCARA_KIN_PARAM_WRIST_LENGTH	RobotWristLength (Available for SCARA with wrist only)	

Transform Type	Axis Mapping	Parameter Count	Parameter #	Description	Range
MC_TRANSFORM_TYPE_SCARA_ELBOW_NEG * Experimental *		2 or 3 The parameter count is depend on axis number of the AxisGroup. <ul style="list-style-type: none"> • 2 AxesGroup: 2 Parameters. (No Wrist) • 3 AxesGroup: 3 Parameters. (with Wrist) 	MC_SCARA_KIN_UPPER_ARM_LENGTH	RobotUpperArmLength	Positive, non-zero value
			MC_SCARA_KIN_LOWER_ARM_LENGTH	RobotLowerArmLength	
			MC_SCARA_KIN_WRIST_LENGTH	RobotWristLength (Available for SCARA with wrist only)	

2.3.94.1 Coordinated Motion Info Library

Function	Description
Related Functions	Reads the actual acceleration of the group and the axes in the group.
Related Functions	Reads the actual position of the axes in the group.
Related Functions	Reads the actual velocity of the group and the axes in the group.
Related Function Blocks	Reads the command position of the axes in the group.
Related Function Blocks	Reads the command velocity of the axes in the group and the path velocity.
Related Functions	Reads the Group ErrorID in State ERRORSTOP.
Related Functions	Returns the status of an axes group.

2.3.94.1.1 MC_GrpReadActAcc PLCopen ✓ Pipe Network ✓

2.3.94.1.1.1 Description

The MC_GrpReadActAcc function block fills the array specified by the 'Acceleration' argument with the actual acceleration of the system in the coordinate system specified by the `CoordSystem` argument. The measured path acceleration is also calculated and reported via the 'PathAcceleration' output. This function block does not cause any motion.

NOTE

- The actual acceleration is smoothed over the last 10 samples. This reduces the error in acceleration estimation, but introduces a small amount of phase delay in the reported accelerations.
- Currently, only the ACS coordinate system is supported. See [Coordinate Systems](#) to learn more.

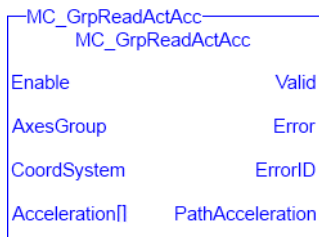
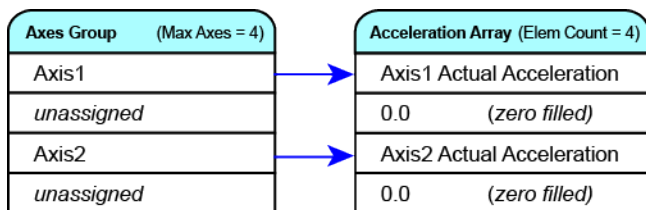

Figure 1-111: MC_GrpReadActAcc

There is a one-to-one correspondence between the axes in the Axes Group array and the acceleration values in the Acceleration array. Each element in the Acceleration array corresponds to the axis element in the Axes Group array. If an index in the Axes Group is unassigned then the acceleration value for that array element in the Acceleration array will be 0. If the element does contain an axis then the acceleration value will be filled with the current actual acceleration for that axis. Here is an example to illustrate how this works:



NOTE
 This function or function block returns cached data. See [Programming a Dual Core Controller](#) for more information.

2.3.95 Related Functions

[Related Functions](#), [Related Functions](#), [Related Function Blocks](#), [Related Function Blocks](#)
 See also "Coordinated Motion", the top-level topic for Coordinated Motion.

2.3.95.0.0.1 Arguments

For more detail on how inputs and outputs work, refer to [PLCopen Function Blocks - General Rules](#).

2.3.96 Input

Enable	Description	If True, then this function block will read the current actual acceleration of the group and the axes in the group
	Data type	BOOL
	Range	0, 1
	Unit	N/A
AxesGroup	Description	The axes group from which the actual acceleration will be read.
	Data type	AXES_GROUP_REF
	Range	N/A

	Unit	N/A
	Default	—
CoordSystem	Description	The coordinate system used when reading the actual acceleration
	Data type	SINT
	Range	One of the following enumeration values: <ul style="list-style-type: none"> • MC_COORDINATE_SYSTEM_ACS = 0 • MC_COORDINATE_SYSTEM_MCS = 1 • MC_COORDINATE_SYSTEM_PCS = 2
	Unit	N/A
	Default	—
Acceleration[]	Description	An array where the acceleration data will be written. The length of the array must equal the maximum number of axes allowed in the group. The maximum number of axes is an argument to Related Function Blocks that is used to create axes groups.
	Data type	LREAL
	Range	N/A
	Unit	User units per second ²
	Default	—

2.3.97 Output

Valid	Description	If true, the accelerations have been read without error.
	Data type	BOOL
Error	Description	If true, an error has occurred.
	Data type	BOOL
ErrorID	Description	Indicates the error if Error output was set to TRUE. See the table PLCopen Function Block ErrorID Output
	Data type	INT
PathAcceleration	Description	The current measured path acceleration of the group, measured by taking the square root of the sum of the squared accelerations of each axis.
	Data type	LREAL
	Unit	User units per second ²

2.3.97.0.0.1 Example

2.3.98 Structured Text

```
Inst_MC_GrpReadActAcc( DoRead, Group, CoordSys, AccList );
```

2.3.99 IL

```
BEGIN_IL
  CAL Inst_MC_GrpReadActAcc( DoRead, Group, CoordSys, AccList )
END_IL
```

2.3.100 FBD

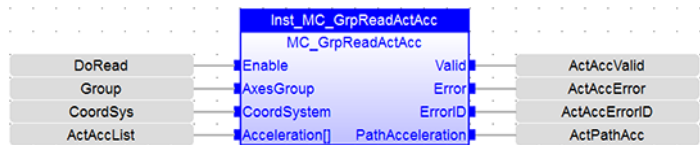

2.3.101 Ladder Diagram

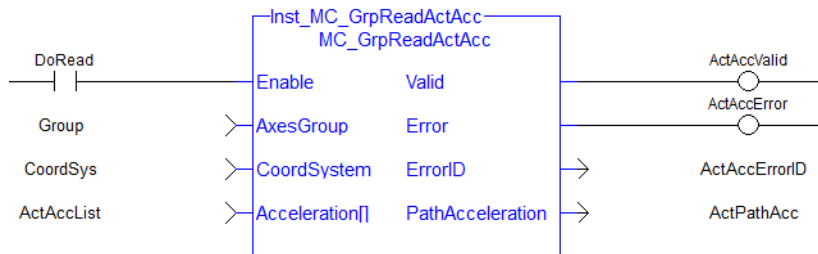

2.3.101.0.1 MC_GrpReadActPos

PLCopen ✓ Pipe Network ✓

2.3.101.0.1.1 Description

MC_GrpReadActPos fills the array specified by the 'Position' argument with the actual position of the system in the coordinate system specified by the CoordSystem argument. This function block does not cause any motion.

NOTE
Currently, only the ACS coordinate system is supported. See [Coordinate Systems](#) to learn more.

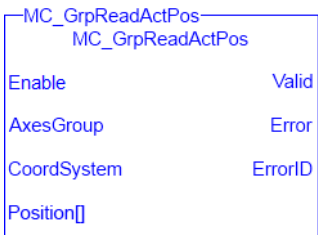
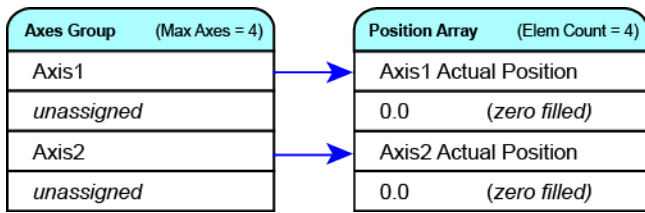

Figure 1-112: MC_GrpReadActPos

There is a one to one correspondence between the axes in the Axes Group and the position values in the Position Array. Each element in the Position Array corresponds to the axis element in the Axis Group array. If an index in the Axes Group is unassigned then the position value for that array element in the Position Array will be 0. If the element does contain an axis then the position value will be filled with the current actual position for that axis. Here is an example to illustrate how this works:



NOTE
 This function or function block returns cached data. See [Programming a Dual Core Controller](#) for more information.

2.3.102 Related Functions

[Related Functions](#), [Related Functions](#), [Related Function Blocks](#), [Related Function Blocks](#)

See also "Coordinated Motion", the top-level topic for Coordinated Motion.

2.3.102.0.0.1 Arguments

For more detail on how inputs and outputs work, refer to [PLCopen Function Blocks - General Rules](#).

2.3.103 Input

Enable	Description	If True, then this function block will read the current actual position of the axes in the group
	Data type	BOOL
	Range	0, 1
	Unit	N/A
	Default	—
AxesGroup	Description	The axes group from which the actual position will be read
	Data type	AXES_GROUP_REF
	Range	N/A
	Unit	N/A
	Default	—
CoordSystem	Description	The coordinate system used when reading the actual position
	Data type	SINT
	Range	One of the following enumeration values: <ul style="list-style-type: none"> • MC_COORDINATE_SYSTEM_ACS = 0 • MC_COORDINATE_SYSTEM_MCS = 1 • MC_COORDINATE_SYSTEM_PCS = 2
	Unit	N/A
	Default	—

Position[]	Description	An array where the position data will be written. The length of the array must equal the maximum number of axes allowed in the group. The maximum number of axes is an argument to the CreateAxesGrp function block that is used to create axes groups.
	Data type	LREAL
	Range	N/A
	Unit	User units
	Default	—

2.3.104 Output

Valid	Description	If true, the positions have been read without error
	Data type	BOOL
Error	Description	If true, an error has occurred.
	Data type	BOOL
ErrorID	Description	Indicates the error if Error output is set to TRUE. See the table PLCopen Function Block ErrorID Output
	Data type	INT

2.3.104.0.0.1 Example

2.3.105 Structured Text

```
Inst_MC_GrpReadActPos( DoRead, Group, CoordSys, PosList );
```

2.3.106 IL

```
BEGIN_IL
    CAL Inst_MC_GrpReadActPos( DoRead, Group, CoordSys, PosList )
END_IL
```

2.3.107 FBD



2.3.108 Ladder Diagram

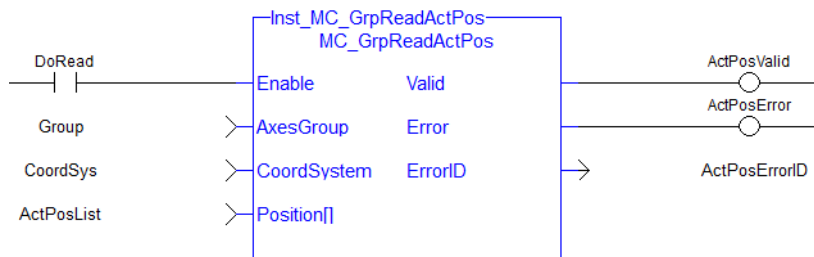

2.3.108.0.1 MC_GrpReadActVel



2.3.108.0.1.1 Description

MC_GrpReadActVel fills the array specified by the 'Velocity' argument with the actual velocity of the system in the coordinate system specified by the CoordSystem argument. The measured path velocity is also calculated and reported via the 'PathVelocity' output. This function block does not cause any motion.

NOTE

- The actual velocity is smoothed over the last 10 samples. This reduces the error in velocity estimation, but introduces a small amount of phase delay in the reported velocities.
- Currently, only the ACS coordinate system is supported. See [Coordinate Systems](#) to learn more.

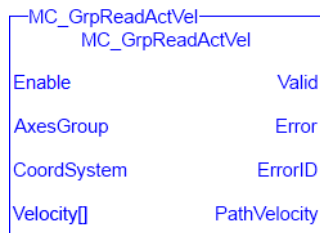
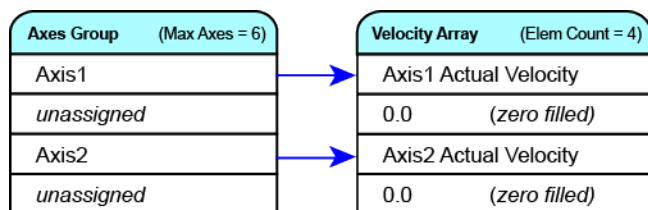

Figure 1-113: MC_GrpReadActVel

There is a one to one correspondence between the axes in the Axes Group and the velocity values in the Velocity Array. Each element in the Velocity array corresponds to the axis element in the Axes Group array. If a index in the Axes Group is unassigned then the velocity value for that array element in the Velocity array will be 0. If the element does contain an axis then the velocity value will be filled with the current actual velocity for that axis. Here is an example to illustrate how this works:



NOTE

This function or function block returns cached data. See [Programming a Dual Core Controller](#) for more information.

2.3.109 Related Functions

[Related Functions](#), [Related Functions](#), [Related Function Blocks](#), [Related Function Blocks](#)

See also "Coordinated Motion", the top-level topic for Coordinated Motion.

2.3.109.0.0.1 Arguments

For more detail on how inputs and outputs work, refer to [PLCopen Function Blocks - General Rules](#).

2.3.110 Input

Enable	Description	If True, then this function block will read the current actual velocity of the group and the axes in the group
	Data type	BOOL
	Range	0, 1
	Unit	N/A
	Default	—
AxesGroup	Description	The axes group from which the actual velocity will be read
	Data type	AXES_GROUP_REF
	Range	N/A
	Unit	N/A
	Default	—
CoordSystem	Description	The coordinate system used when reading the actual velocity
	Data type	SINT
	Range	One of the following enumeration values: <ul style="list-style-type: none"> MC_COORDINATE_SYSTEM_ACS = 0 MC_COORDINATE_SYSTEM_MCS = 1 MC_COORDINATE_SYSTEM_PCS = 2
	Unit	N/A
	Default	—
Velocity[]	Description	An array where the velocity data will be written. The length of the array must equal the maximum number of axes allowed in the group. The maximum number of axes is an argument to Related Function Blocks that is used to create axes groups.
	Data type	LREAL
	Range	N/A
	Unit	User units per second
	Default	—

2.3.111 Output

Valid	Description	If true, the velocities have been read without error.
	Data type	BOOL

Error	Description	If true, an error has occurred.
	Data type	BOOL
ErrorID	Description	Indicates the error if Error output is set to TRUE. See the table PLCopen Function Block ErrorID Output
	Data type	INT
PathVelocity	Description	The current measured path velocity of the group, measured by taking the square root of the sum of the squared velocities of each axis.
	Data type	LREAL
	Unit	User units per second

2.3.111.0.0.1 Example

2.3.112 Structured Text

```
Inst_MC_GrpReadActVel (DoRead, Group, CoordSys, VelList);
```

2.3.113 IL

```
BEGIN_IL
  CAL Inst_MC_GrpReadActVel (DoRead, Group, CoordsSys, VelList)
END_IL
```

2.3.114 FBD

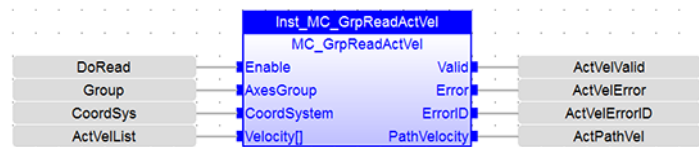

2.3.115 FFLD

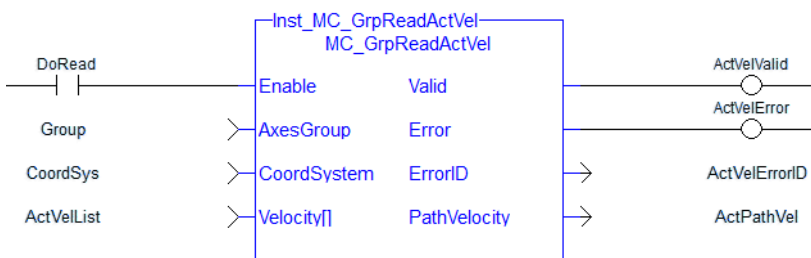

2.3.115.0.1 MC_GrpReadCmdPos



2.3.115.0.1.1 Description

MC_GrpReadCmdPos fills the array (specified by the `Position` argument) with the commanded position of the coordinate system specified by the `CoordSystem` argument. This function block does not cause any motion.

NOTE
 Currently, only the ACS coordinate system is supported. See [Coordinate Systems](#) to learn more.

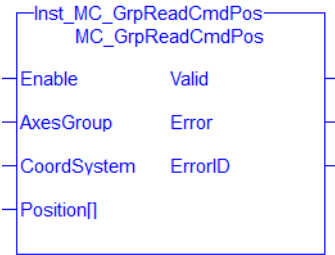
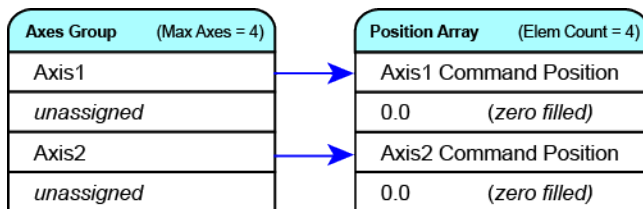

Figure 1-114: MC_GrpReadCmdPos

There is a one to one correspondence between the axes in the Axes Group and the position values in the Position Array. Each element in the Position Array corresponds to the axis element in the Axis Group array. If an index in the Axes Group is unassigned then the position value for that array element in the Position Array will be 0. If the element does contain an axis then the position value will be filled with the current actual position for that axis. Here is an example to illustrate how this works:



NOTE
 This function or function block returns cached data. See [Programming a Dual Core Controller](#) for more information.

2.3.116 Related Function Blocks

[Related Functions](#), [Related Functions](#), [Related Functions](#), [Related Function Blocks](#)

See also "Coordinated Motion", the top-level topic for Coordinated Motion.

2.3.116.0.0.1 Arguments

For more detail on how inputs and outputs work, refer to [PLCopen Function Blocks - General Rules](#).

2.3.117 Input

Enable	Description	If True, then this function block will read the current commanded position of the axes in the group
	Data type	BOOL
	Range	0, 1
	Unit	N/A
	Default	—
AxesGroup	Description	The axes group from which the commanded position will be read.
	Data type	AXES_GROUP_REF

	Range	N/A
	Unit	N/A
	Default	—
CoordSystem	Description	The coordinate system used when reading the commanded position.
	Data type	SINT
	Range	One of the following enumeration values: <ul style="list-style-type: none"> • MC_COORDINATE_SYSTEM_ACS = 0 • MC_COORDINATE_SYSTEM_MCS = 1 • MC_COORDINATE_SYSTEM_PCS = 2
	Unit	N/A
	Default	—
Position[]	Description	An array where the position data will be written. The length of the array must equal the maximum number of axes allowed in the group. The maximum number of axes is an argument to Related Function Blocks , which is used to create axes groups.
	Data type	LREAL
	Range	N/A
	Unit	User units
	Default	—

2.3.118 Output

Valid	Description	If true, that the positions have been read without error.
	Data type	BOOL
Error	Description	If true, an error has occurred.
	Data type	BOOL
ErrorID	Description	Indicates the error if Error output is set to TRUE. See the table in PLCopen Function Block ErrorID Output
	Data type	INT

2.3.118.0.0.1 Example

2.3.119 Structured Text

```
(*MC_GrpReadCmdPos ST example *)
Inst_MC_GrpReadCmdPos (DoRead, Group, CoordSys, PosList );
```

2.3.120 IL



```

BEGIN_IL
    CAL Inst_MC_GrpReadCmdPos( DoRead, Group, CoordSys, PosList )
END_IL
    
```

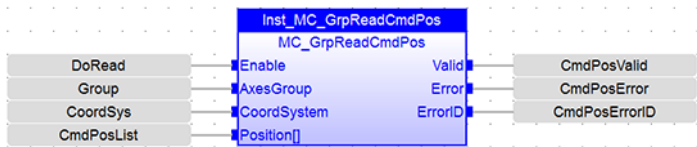
2.3.121 FBD

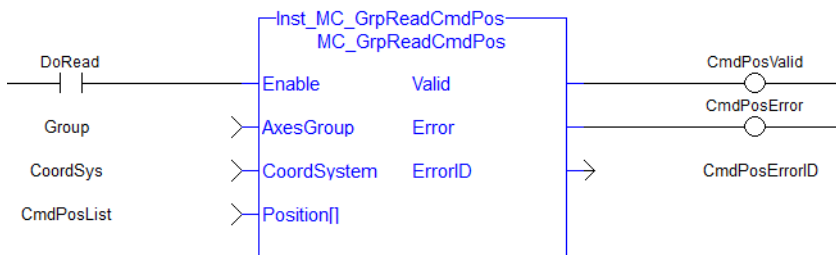

2.3.122 FFLD



2.3.122.0.1 MC_GrpReadCmdVel



2.3.122.0.1.1 Description

MC_GrpReadCmdVel fills the array specified by the `Velocity` argument with the commanded velocity for the coordinate system, which is specified by the `CoordSystem` argument. The path velocity is also reported via the 'PathVelocity' output. This function block does not cause any motion.

NOTE

Currently, only the ACS coordinate system is supported. See [Coordinate Systems](#) to learn more.

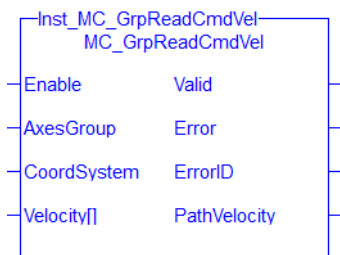
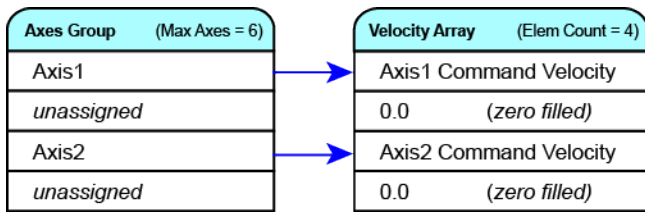

Figure 1-115: MC_GrpReadCmdVel

There is a one to one correspondence between the axes in the Axes Group and the velocity values in the Velocity Array. Each element in the Velocity Array corresponds to the axis element in the Axis Group array. If an index in the Axes Group is unassigned then the velocity value for that array element in the Velocity Array will be 0. If the element does contain an axis then the velocity value will be filled with the current velocity for that axis. Here is an example to illustrate how this works:



NOTE
 This function or function block returns cached data. See [Programming a Dual Core Controller](#) for more information.

2.3.123 Related Function Blocks

[Related Functions](#), [Related Functions](#), [Related Functions](#), [Related Function Blocks](#)

See also "Coordinated Motion", the top-level topic for Coordinated Motion.

2.3.123.0.0.1 Arguments

For more detail on how inputs and outputs work, refer to [PLCopen Function Blocks - General Rules](#).

2.3.124 Input

Enable	Description	If True, then this function block will read the current commanded velocity of the group and the axes in the group
	Data type	BOOL
	Range	0, 1
	Unit	N/A
	Default	—
AxesGroup	Description	The axes group from which the commanded velocity will be read.
	Data type	AXES_GROUP_REF
	Range	N/A
	Unit	N/A
	Default	—
CoordSystem	Description	The coordinate system used when reading the commanded velocity.
	Data type	SINT
	Range	One of the following enumeration values: <ul style="list-style-type: none"> MC_COORDINATE_SYSTEM_ACS = 0 MC_COORDINATE_SYSTEM_MCS = 1 MC_COORDINATE_SYSTEM_PCS = 2
	Unit	N/A
	Default	—

Velocity[]	Description	An array where the velocity data will be written. The length of the array must equal the maximum number of axes allowed in the group. The maximum number of axes is an argument to Related Function Blocks , which is used to create axes groups.
	Data type	LREAL
	Range	N/A
	Unit	User units per second
	Default	—

2.3.125 Output

Valid	Description	If true, that the velocities have been read without error.
	Data type	BOOL
Error	Description	If true, an error has occurred.
	Data type	BOOL
ErrorID	Description	Indicates the error if Error output is set to TRUE. See the table in PLCopen Function Block ErrorID Output
	Data type	INT
PathVelocity	Description	The current commanded path velocity of the group, measured by taking the square root of the sum of the squared velocities of each axis.
	Data type	LREAL
	Unit	User units per second

2.3.125.0.0.1 Example

2.3.126 Structured Text

```
(*MC_GrpReadCmdVel ST example *)
Inst_MC_GrpReadCmdVel(DoRead, Group, CoordSys, VelList );
```

2.3.127 IL

```
BEGIN_IL

    CAL Inst_MC_GrpReadCmdVel( DoRead, Group, CoordSys, VelList )
END_IL
```

2.3.128 FBD



2.3.129 FFLD

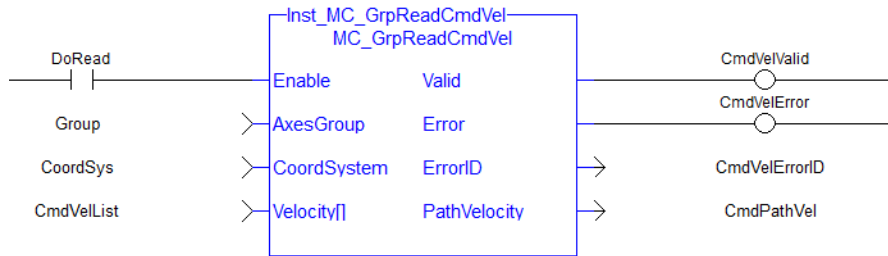

2.3.129.0.1 MC_GrpReadError



2.3.129.0.1.1 Description

This function describes general axes group errors. This function does not cause any motion.

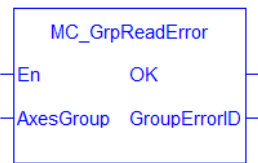

Figure 1-116: MC_GrpReadError

NOTE

This function or function block returns cached data. See [Programming a Dual Core Controller](#) for more information.

2.3.130 Related Functions

[Related Functions, MC_ErrorDescription](#)

See also "Coordinated Motion", the top-level topic for Coordinated Motion.

2.3.130.0.0.1 Arguments

2.3.131 Input

En	Description	Enables execution
	Data Type	BOOL
	Range	0,1
	Unit	N/A
	Default	—
AxesGroup	Description	The axes group from which the GroupErrorID will be read.
	Data Type	AXES_GROUP_REF

Range	N/A
Unit	N/A
Default	—

2.3.132 Output

OK	Description	Indicates the function executed successfully
	Data Type	BOOL
GroupErrorID	Description	Displays the Error ID for the given Axis Group. See table in PLCopen Function Block ErrorID Output
	Data Type	INT

2.3.132.0.0.1 Examples

2.3.133 Structured Text

```
//Read a group error number
GroupErrorID:= MC_GrpReadError( Axis_Group );
```

2.3.134 FBD

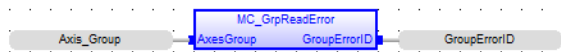

2.3.135 FFLD

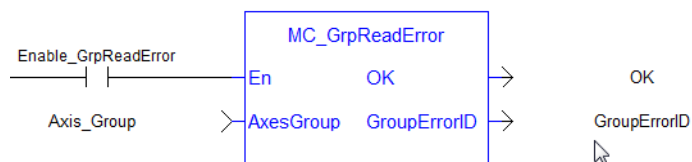

2.3.135.0.1 MC_GrpReadStatus

PLCopen ✓

Pipe Network ✓

2.3.135.0.1.1 Description

MC_GrpReadStatus returns the status of an axes group. This function block does not cause any motion. Refer to [Group State Diagrams](#) for details.

NOTE

The following output is not currently supported. It will be supported in a future release.

- GroupHoming



Figure 1-117: MC_GrpReadStatus

NOTE

This function or function block returns cached data. See [Programming a Dual Core Controller](#) for more information.

2.3.136 Related Functions

[MC_ErrorDescription](#)

See also "Coordinated Motion", the top-level topic for Coordinated Motion.

2.3.136.0.0.1 Arguments

2.3.136.0.0.2 Input

Enable	Description	If True, then the axes group status will be read.
	Data type	BOOL
	Range	0..1
	Unit	N/A
	Default	—
AxesGroup	Description	The axis group from which the status will be read
	Data type	AXIS_GROUP_REF
	Range	N/A
	Unit	N/A
	Default	—

2.3.136.0.0.3 Output

Valid	Description	True if valid outputs are available
--------------	--------------------	-------------------------------------

	Data type	BOOL
GroupMoving ¹	Description	The axes group is in the Moving state, indicating that the group is enabled and currently executing a coordinated motion command.
	Data type	BOOL
GroupHoming ¹	Description	Not supported
	Data type	BOOL
GroupErrorStop ¹	Description	The axes group is in the ErrorStop state due to an axis error or group error. The group cannot accept coordinated motion commands. The execution of MC_GrpReset is required to change the group's state from ErrorStop to Standby.
	Data type	BOOL
GroupStandby ¹	Description	The axes group is in the Standby state, meaning that the group is enabled and all its axes are enabled and the group is not currently executing a coordinated motion command. The axes group is ready to accept coordinated motion commands.
	Data type	BOOL
GroupStopping ¹	Description	The axes group is in the Stopping state due the execution of MC_GrpStop. The axes group is enabled but cannot accept coordinated motion commands while in the Stopping state. The axes group remains in the Stopping state while MC_GrpStop is executing and will remain in the Stopping state while MC_GrpStop's Execute input is held high.
	Data type	BOOL
GroupDisabled ¹	Description	The axis group is in the Disabled state and cannot accept coordinated motion commands.
	Data type	BOOL
ConstantVelocity	Description	True if the commanded path velocity is the same between the current scan of the application program and the previous scan. ConstantVelocity is always TRUE for Direct moves. The commanded path velocity of Direct moves is always zero.
	Data type	BOOL
Accelerating	Description	True if the commanded path velocity is accelerating between the current scan of the application program and the previous scan.
	Data type	BOOL
Decelerating	Description	True if the commanded path velocity is decelerating between the current scan of the application program and the previous scan.

	Data type	BOOL
InPosition	Description	<p>True indicates that the axes group is “in position”. The following must be true for the axes group to be “in position”:</p> <ul style="list-style-type: none"> • The axes group is enabled. • There are no moves in the group’s queue. • The servo loop is closed for each axis in the group. • There are no moves in the individual axis queue for each axis in the group. • The command delta is zero for each axis in the group. • The actual position is within the In-Position Bandwidth of the command position for each axis in the group.
	Data type	BOOL
Error	Description	If True, an error has occurred.
	Data type	BOOL
ErrorID	Description	Indicates the error identifier if the Error output is set to TRUE. See the table in PLCopen Function Block ErrorID Output .
	Data type	BOOL

¹ These outputs are mutually exclusive, meaning only one will be true at a time. All others will be false. Please refer to the [Group State Diagrams](#).

2.3.136.0.0.4 Example

2.3.137 Structured Text

```
//Check boolean status bits for an Axis Group
Inst_MC_GrpReadStatus( EnableGrpReadStatus, Group1_Ref );

IsGroupMoving:= Inst_MC_GrpReadStatus.GroupMoving;
IsGroupErrorStop:= Inst_MC_GrpReadStatus.GroupErrorStop;
IsGroupStandby:= Inst_MC_GrpReadStatus.GroupStandby;
IsGroupDisabled:= Inst_MC_GrpReadStatus.GroupDisabled;
Accelerating:= Inst_MC_GrpReadStatus.Accelerating;
IsConstantVelocity:= Inst_MC_GrpReadStatus.ConstantVelocity;
IsInPosition:= Inst_MC_GrpReadStatus.InPosition;
```

2.3.138 IL

```
BEGIN_IL

    CAL Inst_MC_GrpReadStatus( EnableGrpReadStatus, Group1_Ref )
END_IL
```

2.3.139 FBD

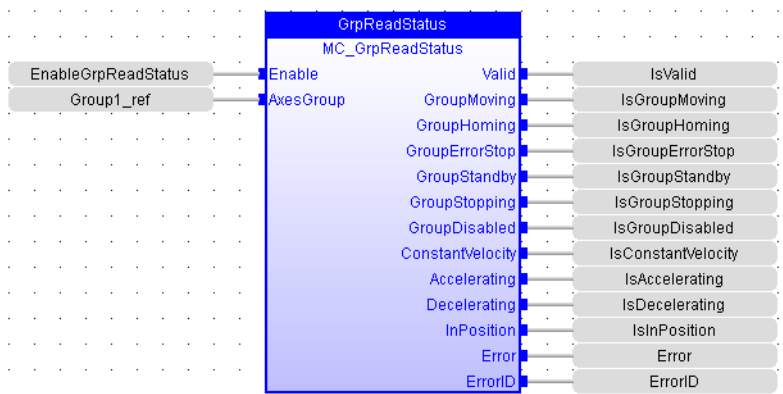

2.3.140 FFLD

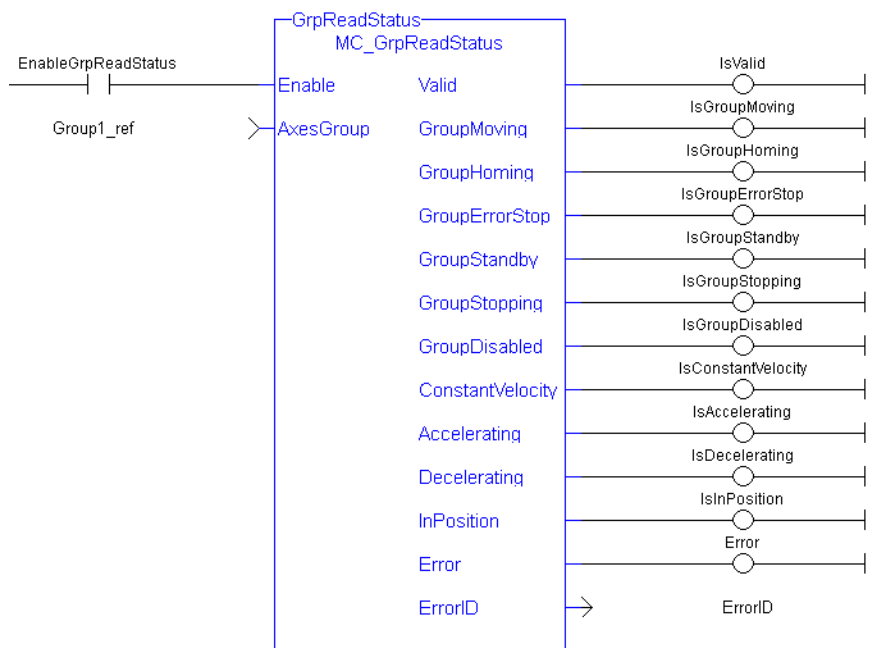

2.3.140.1 Coordinated Motion Motion Library

Function	Description
Related Functions	Sets the default kinematic parameters for an axis.
Related Functions	Performs a controlled motion stop of all the axes in the group
Related Functions	Sets the velocity factor that is multiplied to the commanded velocity of all axes in the group.
Related Functions	Commands interpolated circular movement on an axes group to the specified absolute positions.
Related Functions	Commands interpolated circular movement on an axes group to the specified relative positions.
Related Functions	Commands movement of an axes group to an absolute position regardless of path.
Related Functions	Commands movement of an axes group to a relative position regardless of path.
Related Functions	Commands interpolated linear movement on an axes group to the specified absolute positions.

Function	Description
Related Functions	Commands interpolated linear movement on an axes group to the specified relative positions.

2.3.140.1.1 MC_AxisSetDefaults PLCopen ✓ Pipe Network ✓

2.3.140.1.1.1 Description

MC_AxisSetDefaults sets the default kinematic variables for [Related Functions](#) and [Related Functions](#). These variables are only used with the MC_MoveDir function blocks.

Each axis within the group must have the default kinematic parameters of Velocity, Acceleration, Deceleration, and Jerk set to values greater than zero. A non-zero Jerk value will perform an S-Curve rather than a trapezoidal move. Each axis within the group must have these values set before a direct move can be started.

NOTE

Jerk with a non-zero value is currently not supported for coordinated motion. Jerk parameters are currently ignored.

The function block returns an error if the group state is not GroupStandby or GroupDisabled.

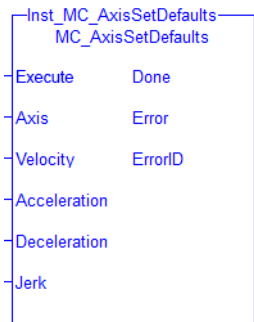

Figure 1-118: MC_AxisSetDefaults

NOTE

This function block starts a motion-related action and therefore stores data for calculations and error checking. Please see [Calling Function Blocks Multiple Times in the Same Cycle](#) if you are using a dual-core controller.

2.3.141 Related Functions

[Related Functions](#), [Related Functions](#), [MC_ErrorDescription](#)

See also "Coordinated Motion", the top-level topic for Coordinated Motion.

See also:

- [Differences Between Functions and Function Blocks](#)
- Calling a function

2.3.141.0.0.1 Arguments

2.3.142 Input

Execute	Description	On the rising edge, request to set the default kinematic parameters.
	Data type	BOOL

	Range	0, 1
	Unit	N/A
	Default	—
Axis	Description	Reference to the axis which will have its default kinematic parameters set.
	Data type	AXIS_REF
	Range	—
	Unit	N/A
	Default	—
Velocity	Description	The default velocity.
	Data type	LREAL
	Range	$0 < \text{Velocity} < (20 * \text{Acceleration})$ and $0 < \text{Velocity} < (20 * \text{Deceleration})$ See Limitations on Acceleration and Jerk for more information.
	Unit	User units per second
	Default	—
Acceleration	Description	Trapezoidal: Acceleration rate S-curve: Maximum acceleration see "Selection of Acceleration and Jerk Parameters for Function Blocks"
	Data type	LREAL
	Range	$(\text{Velocity} / 20) < \text{Acceleration} < (2 * \text{Jerk})$ See Limitations on Acceleration and Jerk for more information.
	Unit	User units per second ²
	Default	—
Deceleration	Description	Trapezoidal: Deceleration rate S-curve: Unused
	Data type	LREAL
	Range	$(\text{Velocity} / 20) < \text{Deceleration} < (2 * \text{Jerk})$
	Unit	User unit per second ²
	Default	—

Jerk	Description	Trapezoidal: 0 S-curve: Constant jerk
		NOTE Currently the Jerk value is ignored for motion. Only trapezoidal motion is supported.
		see "Selection of Acceleration and Jerk Parameters for Function Blocks"
	Data type	LREAL
	Range	$(\text{Velocity} / 20) < \text{Acceleration} < (2 * \text{Jerk})$ and $(\text{Velocity} / 20) < \text{Deceleration} < (2 * \text{Jerk})$
	Unit	User units per second ³
	Default	—

2.3.143 Output

Done	Description	If True, then the command completed successfully.
	Data type	BOOL
Error	Description	If True, then an error has occurred
	Data type	BOOL
ErrorID	Description	Indicates the error if Error output is set to TRUE. See the table in PLCopen Function Block ErrorID Output .
	Data type	DINT

2.3.143.0.0.1 Example

2.3.144 Structured Text

```
(* ST MC_AxisSetDefaults Example *)

default_velocity      := 50.0;
default_acceleration  := 250.0;
default_deceleration  := 300.0;
default_jerk          := 1000.0;

Inst_MC_AxisSetDefaults ( TRUE, CoordAxis1_ref, default_velocity,
default_acceleration, default_deceleration, default_jerk);
```

2.3.145 Instruction List

```
BEGIN_IL
  CAL Inst_MC_AxisSetDefaults( TRUE, CoordAxis1_Ref, default_velocity,
default_acceleration, default_deceleration, default_jerk)
END_IL
```

2.3.146 Function Block Diagram

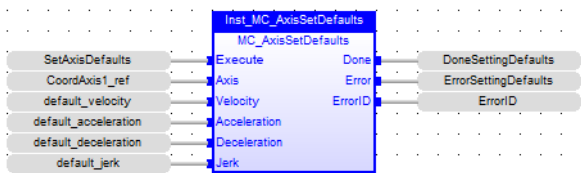

2.3.147 Ladder Diagram

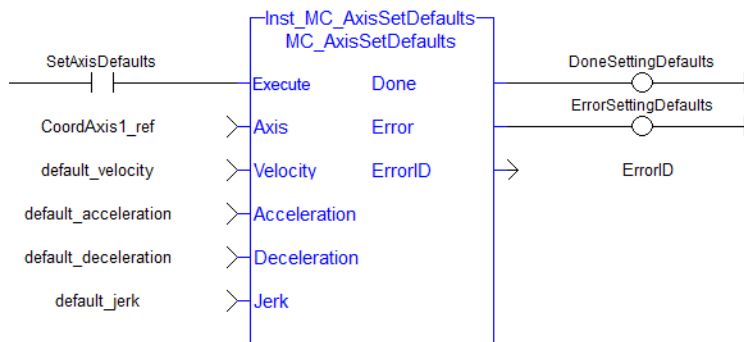

2.3.147.0.1 MC_GrpHalt



2.3.147.0.1.1 Description

MC_GrpHalt performs a controlled motion stop of all the axes in the group. When the path velocity reaches zero any queued moves are flushed from the buffer, the Done output is set, and the state transitions to GroupStandby. Unlike MC_GrpStop, MC_GrpHalt can be aborted.

NOTE

MC_GrpHalt does NOT prevent a single axis from executing nor does it prevent other Coordinated Motion moves from executing once MC_GrpHalt has completed.

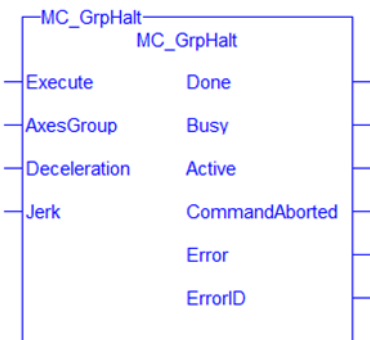

NOTE

This function block starts a motion-related action and therefore stores data for calculations and error checking. Please see [Calling Function Blocks Multiple Times in the Same Cycle](#) if you are using a dual-core controller.

2.3.148 Related Functions

[Related Functions](#), [MC_ErrorDescription](#)

See also "Coordinated Motion", the top-level topic for Coordinated Motion.

2.3.148.0.0.1 Arguments

For more details on how inputs and outputs work, refer to [PLCopen Function Blocks - General Rules](#).

2.3.149 Input

Execute	Description	On the rising edge the command to halt all of the axes in the group is initiated.
	Data type	BOOL
	Range	0, 1
	Unit	N/A
	Default	—
AxesGroup	Description	The axes group in which the axes will be stopped.
	Data type	AXES_GROUP_REF
	Range	N/A
	Unit	N/A
	Default	—
Deceleration	Description	The path deceleration rate for all of the axes in the group
	Data type	LREAL
	Range	0 < Deceleration See Limitations on Acceleration and Jerk for more information.
	Unit	N/A
	Default	—
Jerk	Description	Not supported
	Data type	LREAL
	Range	0 ≤ Jerk See Limitations on Acceleration and Jerk for more information.
	Unit	N/A
	Default	—

2.3.150 Output

Done	Description	If True, then the command completed successfully.
	Data type	BOOL
Busy	Description	TRUE from the moment the EXECUTE input is TRUE until the time the halt is completed.
	Data type	BOOL

Active	Description	Indicates that the halt is still executing.
	Data type	BOOL
CommandAborted	Description	If True, command was aborted by another FB.
	Data type	BOOL
Error	Description	If True, an error has occurred.
	Data type	BOOL
ErrorID	Description	Indicates the error identifier if Error output is set to TRUE.. See table in PLCopen Function Block ErrorID Output .
	Data type	INT

2.3.150.0.1 Example

2.3.151 Structured Text

```
Inst_MC_GrpHalt ( EnableHalt, Group1_Ref, Deceleration, Jerk );
```

2.3.152 IL

```
BEGIN_IL
    CAL Inst_MC_GrpHalt ( EnableHalt, Group1_Ref, Deceleration, Jerk )
END_IL
```

2.3.153 FBD

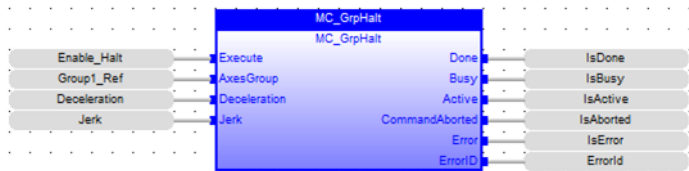

2.3.154 FFLD

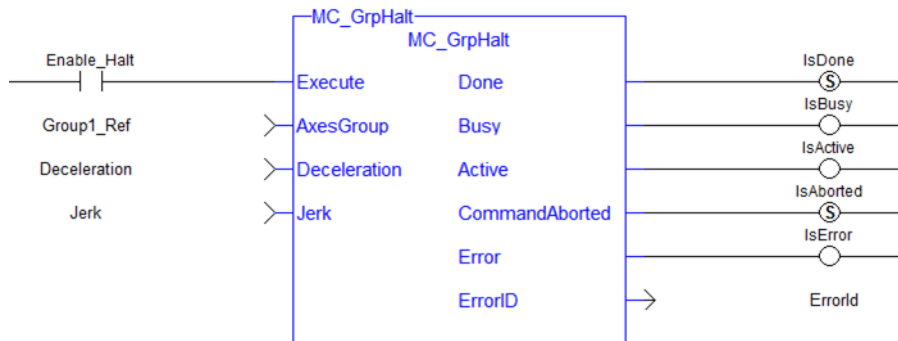

2.3.154.0.1 MC_GrpSetOverride PLCopen ✓ Pipe Network ✓

2.3.154.0.1.1 Description

MC_GrpSetOverride sets the velocity factor that is multiplied to the commanded velocity of all axes in the group. This function block in itself does not cause any motion.

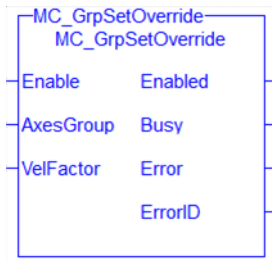

Figure 1-119: MC_GrpSetOverride

2.3.155 Related Functions

[MC_ErrorDescription](#)

See also "[Coordinated Motion](#)", the top-level topic for Coordinated Motion.

2.3.155.0.0.1 Arguments

For more detail on how inputs and outputs work, refer to [PLCopen Function Blocks - General Rules](#).

2.3.156 Input

Enable	Description	On the rising edge, changes the velocity multiplier for the axes group.
	Data type	BOOL
	Range	0, 1
	Unit	N/A
	Default	—
AxesGroup	Description	The axes group in which the velocity multiplier will be applied.
	Data type	AXES_GROUP_REF
	Range	N/A
	Unit	N/A
	Default	—
VelFactor	Description	The new multiplier factor for the commanded velocity of the axes group.
	Data type	REAL
	Range	[0.0 .. 2.0]
	Unit	N/A
	Default	—

2.3.157 Output

Enabled	Description	Indicates that the override was successful.
	Data type	BOOL
Busy	Description	If True, then the FB is executing.
	Data type	BOOL
Error	Description	If True, an error has occurred.
	Data type	BOOL
ErrorID	Description	Indicates the error identifier if Error output is set to TRUE. See the table PLCopen Function Block ErrorID Output .
	Data type	INT

2.3.157.0.0.1 Example

2.3.158 ST

```
Inst_MC_GrpSetOverride( EnableOverride, Group1_Ref, VelocityFactor );
```

2.3.159 IL

```
BEGIN_IL
    CAL Inst_MC_GrpSetOverride( EnableOverride, Group1_Ref,
    VelocityFactor )
END_IL
```

2.3.160 FBD



2.3.161 FFLD

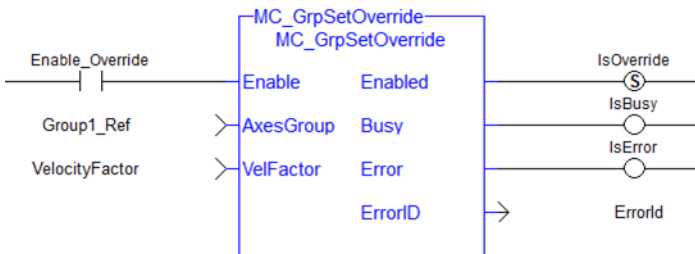

2.3.161.0.1 MC_MoveCircAbs PLCopen ✓ Pipe Network ✓

2.3.161.0.1.1 Description

MC_MoveCircAbs commands interpolated circular movement on an axes group to the specified absolute positions in the coordinate system as specified by the 'CoordSystem' argument. See [Circular Moves Diagrams](#) for detailed information on the movement options.

NOTE

- An error is returned if the group is in the GroupDisabled state.
- An error is returned if the input parameters do not meet the required precision. See [Precision Requirements for Circular Move Input Parameters](#) for more information.

NOTE

- Circular motion is only supported for axes groups with only two attached axes
- S-Curve motion is not currently supported. The *Jerk* input is currently ignored. S-Curve motion and the *Jerk* argument will be supported in a future release. .

When all motion has completed successfully, the state of the axes group goes to GroupStandby.

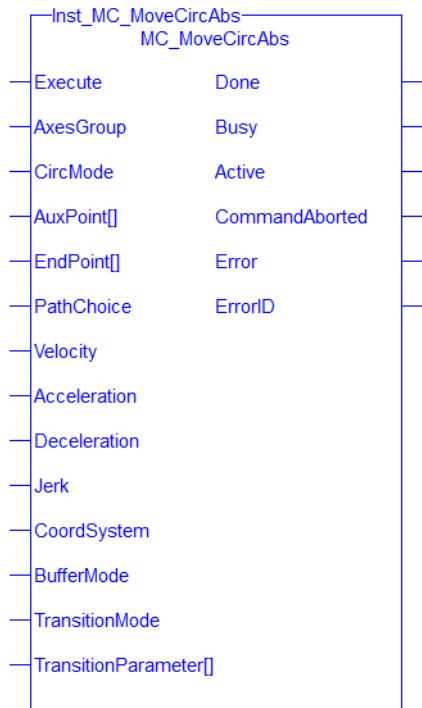

Figure 1-120: MC_MoveCircAbs

2.3.162 Related Functions

[Related Functions](#), [MC_ErrorDescription](#)

See also "[Coordinated Motion](#)", the top-level topic for Coordinated Motion.

2.3.162.0.0.1 Arguments

2.3.163 Input

Execute	Description	On the rising edge request to perform a circular absolute move
	Data type	BOOL
	Range	0, 1

	Unit	N/A
	Default	—
AxesGroup	Description	The axis group that will perform the circular absolute move
	Data type	AXIS_GROUP_REF
	Range	N/A
	Unit	N/A
	Default	—
CircMode	Description	Specifies the meaning of the AuxPoint[] input.
	Data type	SINT One of the following enumeration values: <ul style="list-style-type: none"> • MC_CIRC_MODE_BORDER = 0 • MC_CIRC_MODE_CENTER = 1
	Range	N/A
	Unit	N/A
	Default	—
AuxPoint[]	Description	Array of absolute positions for each axis in the group. The meaning depends on the value of the CircMode input: <ul style="list-style-type: none"> • MC_CIRC_MODE_BORDER: AuxPoint defines a point on the circle which is crossed on the path from the starting to the end point. • MC_CIRC_MODE_CENTER: AuxPoint defines the center point of the circle.
	Data type	LREAL
	Range	[0, Number of axes in group - 1]
	Unit	N/A
	Required Precision	1 part in 100,000. See Precision Requirements for Circular Move Input Parameters .
	Default	—
EndPoint[]	Description	Array of absolute end positions for each axis in the group
	Data type	LREAL
	Range	[0, Number of axes in group - 1]
	Unit	N/A
	Default	—

	Required Precision	1 part in 100,000. See Precision Requirements for Circular Move Input Parameters .
PathChoice	Description	Specifies the direction of the path. This argument is only relevant when CircMode is MC_CIRC_MODE_CENTER.
	Data type	SINT One of the following enumeration values: <ul style="list-style-type: none"> MC_CIRC_PATHCHOICE_CLOCKWISE = 0 = Clockwise MC_CIRC_PATHCHOICE_COUNTERCLOCKWISE = 1 = Counterclockwise
	Range	N/A
	Unit	N/A
	Default	—
Velocity	Description	Maximum velocity of the defined path
	Data type	LREAL
	Range	$0 < \text{Velocity} < (20 * \text{Acceleration})$ and $0 < \text{Velocity} < (20 * \text{Deceleration})$ See Limitations on Acceleration and Jerk for more information.
	Unit	user units per second
	Default	—
Acceleration	Description	Maximum acceleration
	Data type	LREAL
	Range	$0 < \text{Velocity} < (20 * \text{Acceleration})$ See Limitations on Acceleration and Jerk for more information.
	Unit	user units per second ²
	Default	—
Deceleration	Description	Maximum Deceleration
	Data type	LREAL
	Range	$0 < \text{Velocity} < (20 * \text{Deceleration})$ See Limitations on Acceleration and Jerk for more information.
	Unit	user units per second ²
	Default	—
Jerk	Description	Maximum jerk

	Data type	LREAL
	Range	<p>For trapezoidal velocity profiles: 0</p> <p>For S-Curve velocity profiles: $(\text{Velocity} / 20) < \text{Acceleration} < (2 * \text{Jerk})$ and $(\text{Velocity} / 20) < \text{Deceleration} < (2 * \text{Jerk})$</p> <p>See Limitations on Acceleration and Jerk for more information.</p> <div style="background-color: #f0f0f0; padding: 5px; border: 1px solid #ccc;"> <p>NOTE</p> <p>S-Curve motion is currently not supported and the <i>JerK</i> input is currently ignored. S-Curve motion and the <i>JerK</i> argument will be supported in a future release.</p> </div>
	Unit	user units per second ³
	Default	—
CoordSystem	Description	<p>The coordinate system used when commanding the circular absolute move.</p> <p>Currently, only the ACS coordinate system is supported. See Coordinate Systems to learn more.</p>
	Data type	SINT
	Range	<p>One of the following enumeration values:</p> <ul style="list-style-type: none"> • MC_COORDINATE_SYSTEM_ACS = 0 • MC_COORDINATE_SYSTEM_MCS = 1 • MC_COORDINATE_SYSTEM_PCS = 2
	Unit	N/A
	Default	—
BufferMode	Description	<p>Defines the chronological sequence of the function block relative to the previous block.</p> <p>The blending modes (2, 3, 4, & 5) match the path velocity at the active move's endpoint. Some individual axis velocities may make an abrupt change if the path of the next move travels in a different direction. A transition move may be programmed at the <code>TransitionMode</code> input to avoid this.</p> <p>See the table in Buffer Modes.</p>

	Data type	SINT One of the following enumeration values: <ul style="list-style-type: none"> • MC_BUFFER_MODE_BUFFERED = 1 = Buffered • MC_BUFFER_MODE_BLENDED_PREVIOUS = 2 = Blending Previous • MC_BUFFER_MODE_BLENDED_NEXT = 3 = Blending Next • MC_BUFFER_MODE_BLENDED_LOW = 4 = Blending Low • MC_BUFFER_MODE_BLENDED_HIGH = 5 = Blending High <i>BufferMode = Abort = 0 is not allowed with this function block.</i>
	Range	—
	Unit	N/A
	Default	—
TransitionMode	Description	Coupled with the TransitionParameter[], this input defines the shape and dynamics of the inserted contour to connect the current motion with the next motion in the queue. See Transition Between Moves for additional information.
	Data type	SINT
	Range	The value is limited to the following: <ul style="list-style-type: none"> • MC_TRANSITION_MODE_NONE = 0 • MC_TRANSITION_MODE_CORNER_DISTANCE = 3
	Unit	N/A
	Default	—
TransitionParameter[]	Description	This array is dependent on the TransitionMode specified. The transition parameter values are applied to the axis group. See table: "Transition Mode Parameters" for details.
	Data type	LREAL
	Range	[1, N] N values are supplier specified dependent on the TransitionMode selected.
	Unit	N/A
	Default	—

2.3.164 Output

Done	Description	If True, then the command completed successfully.
-------------	--------------------	---

	Data type	BOOL
Busy	Description	If True, then the function block is executing.
	Data type	BOOL
Active	Description	If True, then the function block is controlling motion.
	Data type	BOOL
CommandAborted	Description	If True, command was aborted by another function block.
	Data type	BOOL
Error	Description	If True, an error has occurred.
	Data type	BOOL
ErrorID	Description	Indicates the error if Error output is set to TRUE. See table in PLCopen Function Block ErrorID Output
	Data type	INT

2.3.164.0.0.1 Example

2.3.165 ST

```
Inst_MC_MoveCircAbs( ExecuteMove, Group1_Ref, MC_CIRC_MODE_BORDER,
AuxPoints, EndPoints, MC_CIRC_PATHCHOICE_CLOCKWISE, Velocity,
Acceleration, Deceleration, Jerk, MC_COORDINATE_SYSTEM_ACS, MC_BUFFER_
MODE_ABORTING, MC_TRANSITION_MODE_NONE, TransitionParams );
```

2.3.166 IL

```
BEGIN_IL

CAL Inst_MC_MoveCircAbs( ExecuteMove, Group1_Ref, MC_CIRC_MODE_
BORDER, AuxPoints, EndPoints, MC_CIRC_PATHCHOICE_CLOCKWISE, Velocity,
Acceleration, Deceleration, Jerk, MC_COORDINATE_SYSTEM_ACS, MC_BUFFER_
MODE_ABORTING, MC_TRANSITION_MODE_NONE, TransitionParams )

END_IL
```

2.3.167 FBD

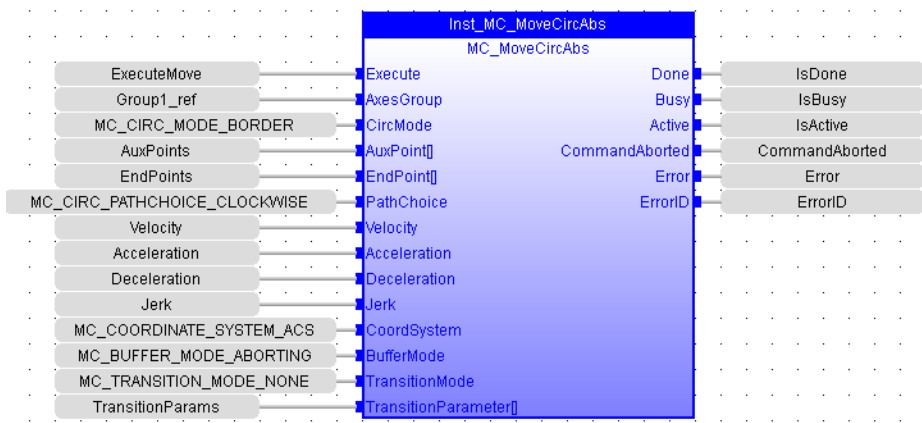

2.3.168 FFLD

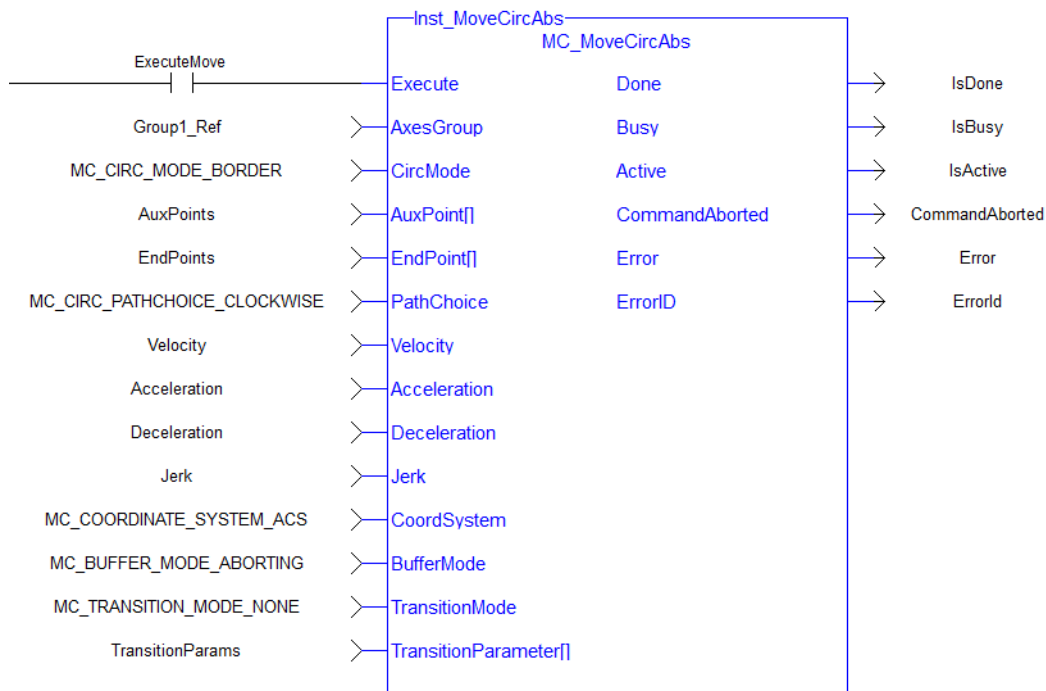

2.3.168.0.1 MC_MoveCircRel PLCopen ✓ Pipe Network ✓

2.3.168.0.1.1 Description

MC_MoveCircRel commands interpolated circular movement on an axes group to the specified relative positions in the coordinate system as specified by the 'CoordSystem' argument. See [Circular Moves Diagrams](#) for detailed information on the movement options.

NOTE

An error is returned if the group is in the GroupDisabled state.

NOTE

- Circular motion is only supported for axes groups with only two attached axes
- S-Curve motion is not currently supported. The *Jerk* input is currently ignored. S-Curve motion and the *Jerk* argument will be supported in a future release. .

When all motion has completed successfully, the state of the axes group goes to GroupStandby.

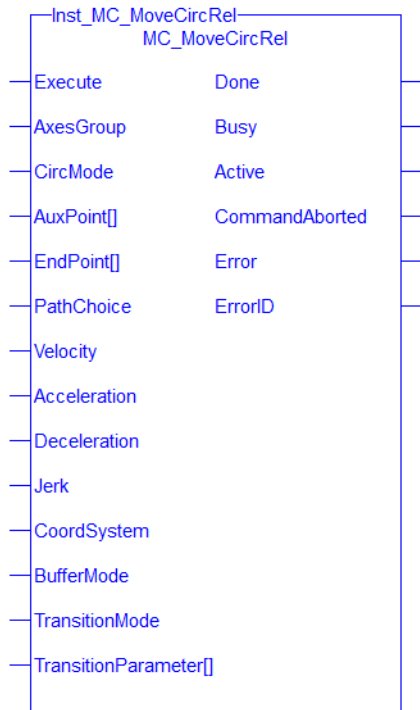

Figure 1-121: MC_MoveCircRel

2.3.169 Related Functions

Related Functions, [MC_ErrorDescription](#)

See also "Coordinated Motion", the top-level topic for Coordinated Motion.

2.3.169.0.0.1 Arguments

2.3.170 Input

Execute	Description	On the rising edge request to perform a circular relative move.
	Data type	BOOL
	Range	0, 1
	Unit	N/A
	Default	—
AxesGroup	Description	The axis group that will perform the circular relative move
	Data type	AXIS_GROUP_REF
	Range	N/A
	Unit	N/A
	Default	—
CircMode	Description	Specifies the meaning of the AuxPoint[] input (see AuxPoint[] below).

	Data type	SINT One of the following enumeration values: <ul style="list-style-type: none"> • MC_CIRC_MODE_BORDER = 0 • MC_CIRC_MODE_CENTER = 1
	Range	N/A
	Unit	N/A
	Default	—
AuxPoint[]	Description	Array of relative positions for each axis in the group. The meaning depends on the value of the CircMode input: <ul style="list-style-type: none"> • MC_CIRC_MODE_BORDER: AuxPoint defines a point on the circle which is crossed on the path from the starting to the end point. • MC_CIRC_MODE_CENTER: AuxPoint defines the center point of the circle. <p>In all cases the points are relative to the starting point.</p>
	Data type	LREAL
	Range	[0, Number of axes in group - 1]
	Unit	N/A
	Default	—
	Required Precision	1 part in 100,000. See Precision Requirements for Circular Move Input Parameters .
EndPoint[]	Description	Array of relative end positions for each axis in the group.
	Data type	LREAL
	Range	[0, Number of axes in group - 1]
	Unit	N/A
	Default	—
	Required Precision	1 part in 100,000. See Precision Requirements for Circular Move Input Parameters .
PathChoice	Description	Specifies the direction of the path. This argument is only relevant when CircMode is MC_CIRC_MODE_CENTER.
	Data type	SINT One of the following enumeration values: <ul style="list-style-type: none"> • MC_CIRC_PATHCHOICE_CLOCKWISE = 0 = Clockwise • MC_CIRC_PATHCHOICE_COUNTERCLOCKWISE = 1 = Counterclockwise
	Range	N/A

	Unit	N/A
	Default	—
Velocity	Description	Maximum velocity of the defined path
	Data type	LREAL
	Range	$0 < \text{Velocity} < (20 * \text{Acceleration})$ and $0 < \text{Velocity} < (20 * \text{Deceleration})$ See Limitations on Acceleration and Jerk for more information.
	Unit	user units per second
	Default	—
Acceleration	Description	Maximum acceleration
	Data type	LREAL
	Range	$0 < \text{Velocity} < (20 * \text{Acceleration})$ See Limitations on Acceleration and Jerk for more information.
	Unit	user units per second ²
	Default	—
Deceleration	Description	Maximum Deceleration
	Data type	LREAL
	Range	$0 < \text{Velocity} < (20 * \text{Deceleration})$ See Limitations on Acceleration and Jerk for more information.
	Unit	user units per second ²
	Default	—
Jerk	Description	Maximum jerk
	Data type	LREAL
	Range	For trapezoidal velocity profiles: 0 For S-Curve velocity profiles: $(\text{Velocity} / 20) < \text{Acceleration} < (2 * \text{Jerk})$ and $(\text{Velocity} / 20) < \text{Deceleration} < (2 * \text{Jerk})$ See Limitations on Acceleration and Jerk for more information.
		<div style="background-color: #333; color: white; padding: 2px; text-align: center;">NOTE</div> <div style="border: 1px solid #ccc; padding: 5px; background-color: #f0f0f0;"> S-Curve motion is currently not supported and the <i>Jerk</i> input is currently ignored. S-Curve motion and the <i>Jerk</i> argument will be supported in a future release. </div>

	Unit	user units per second ³
	Default	—
CoordSystem	Description	The coordinate system used when commanding the circular relative move Currently, only the ACS coordinate system is supported. See Coordinate Systems to learn more.
	Data type	SINT
	Range	One of the following enumeration values: <ul style="list-style-type: none"> • MC_COORDINATE_SYSTEM_ACS = 0 • MC_COORDINATE_SYSTEM_MCS = 1 • MC_COORDINATE_SYSTEM_PCS = 2
	Unit	N/A
	Default	—
BufferMode	Description	Defines the chronological sequence of the function block relative to the previous block. The blending modes (2, 3, 4, & 5) match the path velocity at the active move's endpoint. Some individual axis velocities may make an abrupt change if the path of the next move travels in a different direction. A transition move may be programmed at the <code>TransitionMode</code> input to avoid this. See the table in Buffer Modes .
	Data type	SINT One of the following enumeration values: <ul style="list-style-type: none"> • MC_BUFFER_MODE_ABORTING = 0 = Abort • MC_BUFFER_MODE_BUFFERED = 1 = Buffered • MC_BUFFER_MODE_BLENDED_PREVIOUS = 2 = Blending Previous • MC_BUFFER_MODE_BLENDED_NEXT = 3 = Blending Next • MC_BUFFER_MODE_BLENDED_LOW = 4 = Blending Low • MC_BUFFER_MODE_BLENDED_HIGH = 5 = Blending High
	Range	—
	Unit	N/A
	Default	—
TransitionMode	Description	Coupled with the <code>TransitionParameter[]</code> , this input defines the shape and dynamics of the inserted contour to connect the current motion with the next motion in the queue. See Transition Between Moves for additional information.

Data type	SINT
Range	The value is limited to the following: <ul style="list-style-type: none"> • MC_TRANSITION_MODE_NONE = 0 • MC_TRANSITION_MODE_CORNER_DISTANCE = 3
Unit	N/A
Default	—
TransitionParameter[] Description	This array is dependent on the TransitionMode specified. The transition parameter values are applied to the axis group. See table: "Transition Mode Parameters" for details.
Data type	LREAL
Range	[1, N] N values are supplier specified dependent on the TransitionMode selected.
Unit	N/A
Default	—

2.3.171 Output

Done	Description	If True, then the command completed successfully.
	Data type	BOOL
Busy	Description	If True, then the function block is executing.
	Data type	BOOL
Active	Description	If True, then the function block is controlling motion.
	Data type	BOOL
CommandAborted	Description	If True, command was aborted by another function block.
	Data type	BOOL
Error	Description	If True, an error has occurred.
	Data type	BOOL
ErrorID	Description	Indicates the error if Error output is set to TRUE. See table in PLCOpen Function Block ErrorID Output
	Data type	INT

2.3.171.0.0.1 Example

2.3.172 ST

```
Inst_MC_MoveCircRel( ExecuteMove, Group1_Ref, MC_CIRC_MODE_BORDER,
AuxPoints, EndPoints, MC_CIRC_PATHCHOICE_CLOCKWISE, Velocity,
Acceleration, Deceleration, Jerk, MC_COORDINATE_SYSTEM_ACS, MC_BUFFER_
MODE_ABORTING, MC_TRANSITION_MODE_NONE, TransitionParams );
```

2.3.173 IL

```
BEGIN_IL
CAL Inst_MC_MoveCircRel( ExecuteMove, Group1_Ref, MC_CIRC_MODE_
BORDER, AuxPoints, EndPoints, MC_CIRC_PATHCHOICE_CLOCKWISE, Velocity,
Acceleration, Deceleration, Jerk, MC_COORDINATE_SYSTEM_ACS, MC_BUFFER_
MODE_ABORTING, MC_TRANSITION_MODE_NONE, TransitionParams )
END_IL
```

2.3.174 FBD

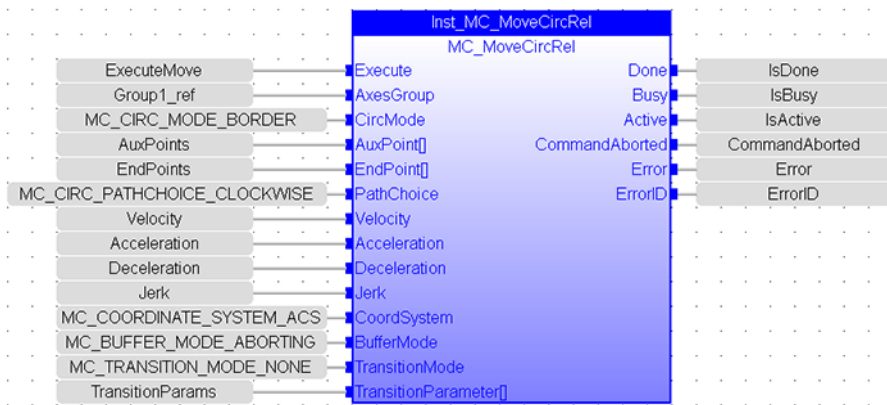

2.3.175 FFLD

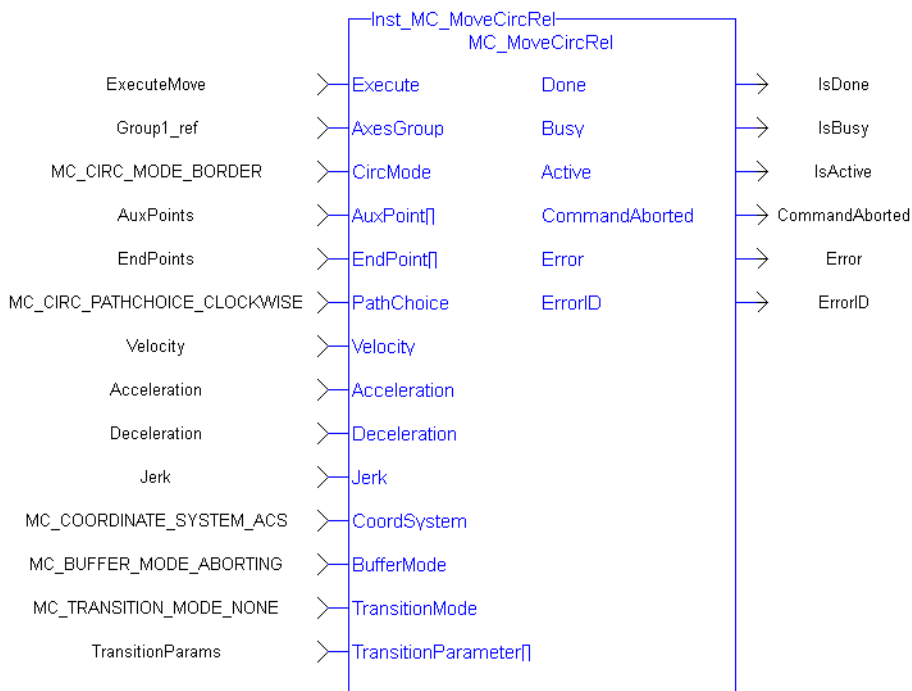

2.3.175.0.1 MC_MoveDirAbs PLCopen ✓ Pipe Network ✓

2.3.175.0.1.1 Description

MC_MoveDirAbs commands the movement of an axes group to a specified absolute position in the specified coordinate system without taking care of how (on which path) the target position is reached.

NOTE
<ul style="list-style-type: none"> • An error is returned if the group is in the GroupDisabled state. • This function block does not have its own Acceleration, Deceleration, Velocity, and Jerk arguments. These are set using Related Functions. • The maximum number of axes is set by the MaxNumberOfAxes input set in the Related Function Blocks function block. • S-Curve motion is not currently supported. The <i>Jerk</i> input is currently ignored. S-Curve motion and the <i>Jerk</i> argument will be supported in a future release. .

When all motion is completed successfully, the state becomes GroupStandby.

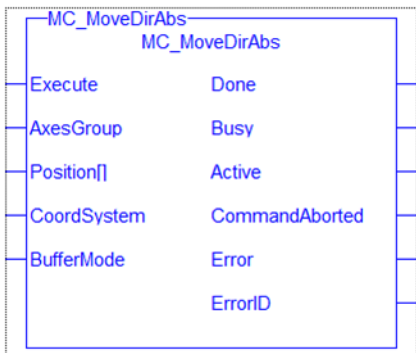

Figure 1-122: MC_MoveDirAbs

2.3.176 Related Functions

[Related Functions](#), [MC_ErrorDescription](#)

See also "Coordinated Motion", the top-level topic for Coordinated Motion.

2.3.176.0.0.1 Arguments

2.3.177 Input

Execute	Description	On the rising edge, request to perform a direct absolute move.
	Data Type	BOOL
	Range	0, 1
	Unit	N/A
	Default	—
AxesGroup	Description	Reference to an axes group
	Data Type	AXES_GROUP_REF
	Range	—

	Unit	N/A
	Default	—
Position[]	Description	Array of absolute end positions for each axis in the group.
	Data Type	LREAL
	Range	[0, Number of axes in group - 1]
	Unit	N/A
	Default	—
CoordSystem	Description	The coordinate system used when commanding the direct absolute move Currently, only the ACS coordinate system is supported. See Coordinate Systems to learn more.
	Data Type	SINT
	Range	<ul style="list-style-type: none"> • MC_COORDINATE_SYSTEM_ACS = 0 • MC_COORDINATE_SYSTEM_MCS = 1 • MC_COORDINATE_SYSTEM_PCS = 2
	Unit	N/A
	Default	—
BufferMode	Description	Defines the chronological sequence of the function block relative to the previous block. See the table in Buffer Modes .
	Data Type	SINT MC_BUFFER_MODE_ABORTING = 0 = Abort MC_BUFFER_MODE_BUFFERED = 1 = Buffered
	Range	—
	Unit	N/A
	Default	—

2.3.178 Output

Done	Description	If True, then the command completed successfully.
	Data type	BOOL
Busy	Description	If True, then the function block is executing.
	Data type	BOOL
Active	Description	If True, then the function block is controlling motion.
	Data type	BOOL

CommandAborted	Description	If True, command was aborted by another function block.
	Data type	BOOL
Error	Description	If True, an error has occurred.
	Data type	BOOL
ErrorID	Description	Indicates the error if Error output is set to TRUE. See table in PLCopen Function Block ErrorID Output .
	Data type	INT

2.3.178.0.0.1 Example

2.3.179 Structure Text

```
Inst_MC_MoveDirAbs( DirectMove, Group1_Ref, PositionList, MC_COORDSYSTEM_
ACS, MC_BUFFER_MODE_ABORTING);
```

2.3.180 IL

```
BEGIN_IL
CAL Inst_MC_MoveDirAbs( DirectMove, Group1_Ref, PositionList, MC_
COORD_SYSTEM_ACS, MC_BUFFER_MODE_ABORTING)
END_IL
```

2.3.181 Function Block Diagram

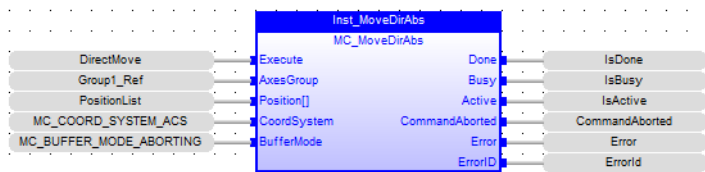

2.3.182 Ladder Diagram

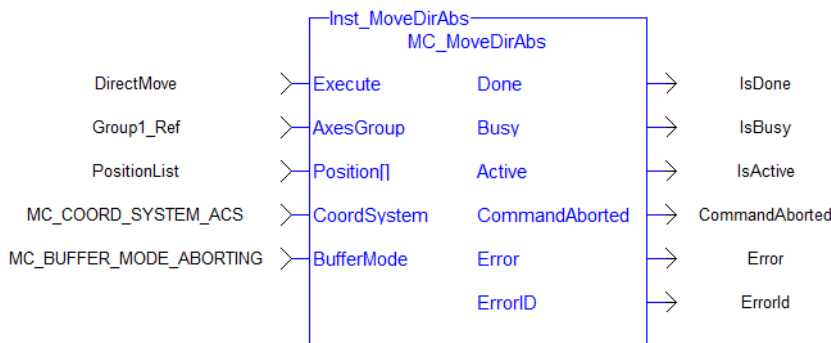

2.3.182.0.1 MC_MoveDirRel

PLCopen Pipe Network

2.3.182.0.1.1 Description

MC_MoveDirRel commands a movement of an axes group to a relative position in the specified coordinate system without taking care of how (on which path) the target position is reached.

NOTE

- An error is returned if the group is in the GroupDisabled state.
- This function block does not have its own Acceleration, Deceleration, Velocity, and Jerk arguments. These are set using [Related Functions](#).
- The maximum number of axes is set by the **MaxNumberOfAxes** input set in the [Related Function Blocks](#) function block.
- S-Curve motion is not currently supported. The *Jerk* input is currently ignored. S-Curve motion and the *Jerk* argument will be supported in a future release. .

When all motion has completed successfully, the state of the axes group goes to GroupStandby.

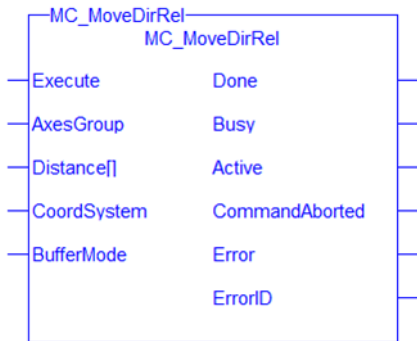

Figure 1-123: MC_MoveDirRel

2.3.183 Related Functions

[Related Functions](#), [MC_ErrorDescription](#)

See also "[Coordinated Motion](#)", the top-level topic for Coordinated Motion.

2.3.183.0.0.1 Arguments

2.3.184 Input

Execute	Description	On the rising edge request to perform a direct relative move.
	Data type	BOOL
	Range	0, 1
	Unit	N/A
	Default	—
AxesGroup	Description	Reference to an axes group
	Data type	AXES_GROUP_REF
	Range	—
	Unit	N/A
	Default	—

Distance[]	Description	An array containing the distance for each axis in the group.
	Data type	LREAL
	Range	[0, Number of axes in group - 1]
	Unit	N/A
	Default	—
CoordSystem	Description	The coordinate system used when commanding the direct relative move. Currently, only the ACS coordinate system is supported. See Coordinate Systems to learn more.
	Data type	SINT
	Range	<ul style="list-style-type: none"> • MC_COORDINATE_SYSTEM_ACS = 0 • MC_COORDINATE_SYSTEM_MCS = 1 • MC_COORDINATE_SYSTEM_PCS = 2
	Unit	N/A
	Default	—
BufferMode	Description	Defines the chronological sequence of the function block relative to the previous block. See the table in Buffer Modes
	Data type	SINT MC_BUFFER_MODE_ABORTING = 0 = Abort MC_BUFFER_MODE_BUFFERED = 1 = Buffered
	Range	—
	Unit	N/A
	Default	—

2.3.185 Output

Done	Description	If True, then the command completed successfully.
	Data type	BOOL
Busy	Description	If True, then the function block is executing. .
	Data type	BOOL
Active	Description	If True, then the function block is controlling motion.
	Data type	BOOL
CommandAborted	Description	If True, command was aborted by another function block.
	Data type	BOOL

Error	Description	If True, an error has occurred.
	Data type	BOOL
ErrorID	Description	Indicates the error if Error output is set to TRUE. See table in PLCopen Function Block ErrorID Output .
	Data type	INT

2.3.185.0.0.1 Example

2.3.186 Structure Text

```
Inst_MC_MoveDirRel( ExecuteMove, Group1_Ref, DistanceList, MC_COORDINATE_SYSTEM_ACS, MC_BUFFER_MODE_ABORTING );
```

2.3.187 IL

```
BEGIN_IL
    CAL Inst_MC_MoveDirRel( ExecuteMove, Group1_Ref, DistanceList, MC_COORDINATE_SYSTEM_ACS, MC_BUFFER_MODE_ABORTING )
END_IL
```

2.3.188 Function Block Diagram

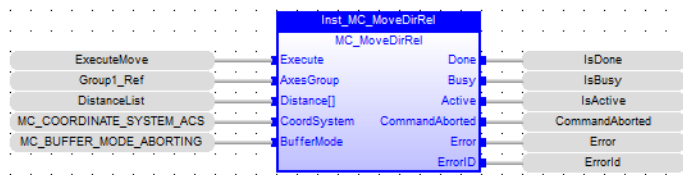

2.3.189 Ladder Diagram

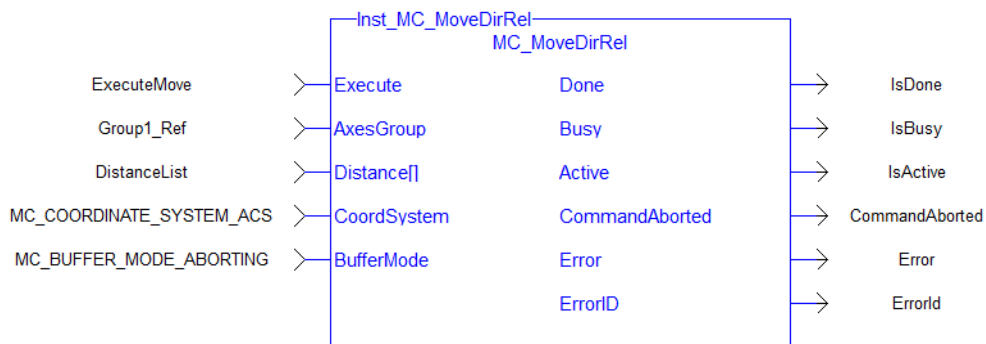

2.3.189.0.1 MC_MoveLinAbs PLCopen ✓ Pipe Network ✓

2.3.189.0.1.1 Description

MC_MoveLinAbs commands interpolated linear movement on an axes group to the specified absolute positions in the coordinate system as specified by the 'CoordSystem' argument. The dimensionality of the move is determined by the number of axes mapped to the group.

NOTE

- An error is returned if the group is in the GroupDisabled state.
- The maximum number of axes is set by the **MaxNumberOfAxes** input set in the [Related Function Blocks](#) function block.
- S-Curve motion is not currently supported. The *Jerk* input is currently ignored. S-Curve motion and the *Jerk* argument will be supported in a future release. .

When all motion has completed successfully, the state of the axes group goes to GroupStandby.

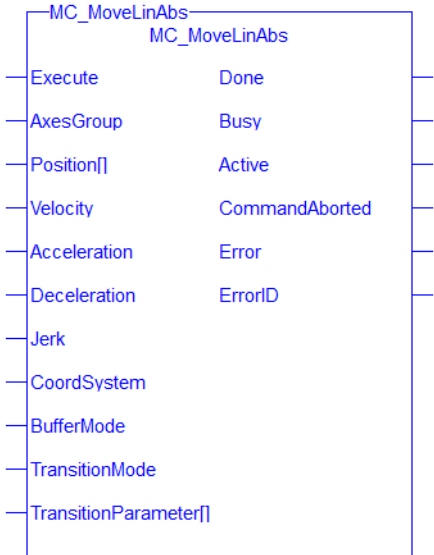

Figure 1-124: MC_MoveLinAbs

2.3.190 Related Functions

Related Functions, [MC_ErrorDescription](#)

See also "Coordinated Motion", the top-level topic for Coordinated Motion.

2.3.190.0.0.1 Arguments

2.3.191 Input

Execute	Description	On the rising edge request to perform a linear absolute move.
	Data Type	BOOL
	Range	0, 1
	Unit	N/A
	Default	—
AxesGroup	Description	The axis group that will perform the linear absolute move
	Data Type	AXIS_GROUP_REF
	Range	N/A
	Unit	N/A

	Default	—
Position[]	Description	Array of absolute end positions for each axis in the group.
	Data Type	LREAL
	Range	N/A
	Unit	user units
	Default	—
Velocity	Description	Maximum velocity of the defined path
	Data Type	LREAL
	Range	$0 < \text{Velocity} < (20 * \text{Acceleration})$ and $0 < \text{Velocity} < (20 * \text{Deceleration})$ See Limitations on Acceleration and Jerk for more information.
	Unit	user units per second
	Default	—
Acceleration	Description	Maximum acceleration
	Data Type	LREAL
	Range	$0 < \text{Velocity} < (20 * \text{Acceleration})$ See Limitations on Acceleration and Jerk for more information.
	Unit	user units per second ²
	Default	—
Deceleration	Description	Maximum deceleration
	Data Type	LREAL
	Range	$0 < \text{Velocity} < (20 * \text{Deceleration})$ See Limitations on Acceleration and Jerk for more information.
	Unit	user units per second ²
	Default	—
Jerk	Description	Maximum jerk
	Data Type	LREAL

	Range	<p>For trapezoidal velocity profiles: 0</p> <p>For S-Curve velocity profiles: $(\text{Velocity} / 20) < \text{Acceleration} < (2 * \text{Jerk})$ and $(\text{Velocity} / 20) < \text{Deceleration} < (2 * \text{Jerk})$</p> <p>See Limitations on Acceleration and Jerk for more information.</p>
		<p>NOTE</p> <p>S-Curve motion is currently not supported and the <i>JerK</i> input is currently ignored. S-Curve motion and the <i>JerK</i> argument will be supported in a future release.</p>
	Unit	user units per second ³
	Default	—
CoordSystem	Description	<p>The coordinate system used when commanding the linear absolute move.</p> <p>Currently, only the ACS coordinate system is supported. See Coordinate Systems to learn more.</p>
	Data Type	SINT
	Range	<p>One of the following enumeration values:</p> <ul style="list-style-type: none"> • MC_COORDINATE_SYSTEM_ACS = 0 • MC_COORDINATE_SYSTEM_MCS = 1 • MC_COORDINATE_SYSTEM_PCS = 2
	Unit	N/A
	Default	—
BufferMode	Description	<p>Defines the chronological sequence of the function block relative to the previous block.</p> <p>MC_BUFFER_MODE_ABORTING = 0 = Abort MC_BUFFER_MODE_BUFFERED = 1 = Buffered MC_BUFFER_MODE_BLENDED_PREVIOUS = 2 = Blending Previous MC_BUFFER_MODE_BLENDED_NEXT = 3 = Blending Next MC_BUFFER_MODE_BLENDED_LOW = 4 = Blending Low MC_BUFFER_MODE_BLENDED_HIGH = 5 = Blending High</p> <p>The buffer mode is limited to MC_BUFFER_MODE_BUFFERED for groups with more than two axes.</p> <p>The blending modes (2, 3, 4, & 5) match the path velocity at the active move's endpoint. Some individual axis velocities may make an abrupt change if the path of the next move travels in a different direction. A transition move may be programmed at the <code>TransitionMode</code> input to avoid this.</p> <p>See the table in Buffer Modes</p>
	Data Type	SINT

	Range	—
	Unit	N/A
	Default	—
TransitionMode	Description	Coupled with the TransitionParameter[], this input defines the shape and dynamics of the inserted contour to connect the current motion with the next motion in the queue. See Transition Between Moves for additional information.
	Data type	SINT
	Range	The value is limited to the following: <ul style="list-style-type: none"> MC_TRANSITION_MODE_NONE = 0 MC_TRANSITION_MODE_CORNER_DISTANCE = 3 The transition mode is limited to MC_TRANSITION_MODE_NONE for groups with more than three axes.
	Unit	N/A
	Default	—
TransitionParameter[]	Description	This array is dependent on the TransitionMode specified. The transition parameter values are applied to the axis group. See table: "Transition Mode Parameters" for details.
	Data Type	LREAL
	Range	[1, N] N values are supplier specified dependent on the TransitionMode selected.
	Unit	N/A
	Default	—

2.3.192 Output

Done	Description	If True, then the command completed successfully.
	Data type	BOOL
Busy	Description	If True, then the function block is executing.
	Data type	BOOL
Active	Description	If True, then the function block is controlling motion.
	Data type	BOOL
CommandAborted	Description	If True, then the command was aborted by another function block.
	Data type	BOOL

Error	Description	If True, an error has occurred.
	Data type	BOOL
ErrorID	Description	Indicates the error if Error output is set to TRUE. See table in PLCopen Function Block ErrorID Output
	Data type	INT

2.3.192.0.0.1 Example

2.3.193 Structured Text

```
(* Inst_MC_MoveLinAbsST example *)
Inst_MC_MoveLinAbs( ExecuteLinearMove, Group1_Ref, PositionList,
Velocity, Acceleration, Deceleration, Jerk, CoordSystem, BufferMode,
TransitionMode, TransitionParams );
```

2.3.194 IL

```
BEGIN_IL
CAL Inst_MC_MoveLinAbs( ExecuteLinearMove, Group1_Ref, PositionList,
Velocity, Acceleration, Deceleration, Jerk, CoordSystem, BufferMode,
TransitionMode, TransitionParams )
END_IL
```

2.3.195 FBD

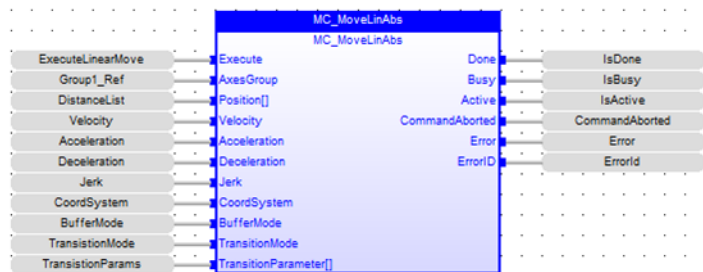

2.3.196 FFLD

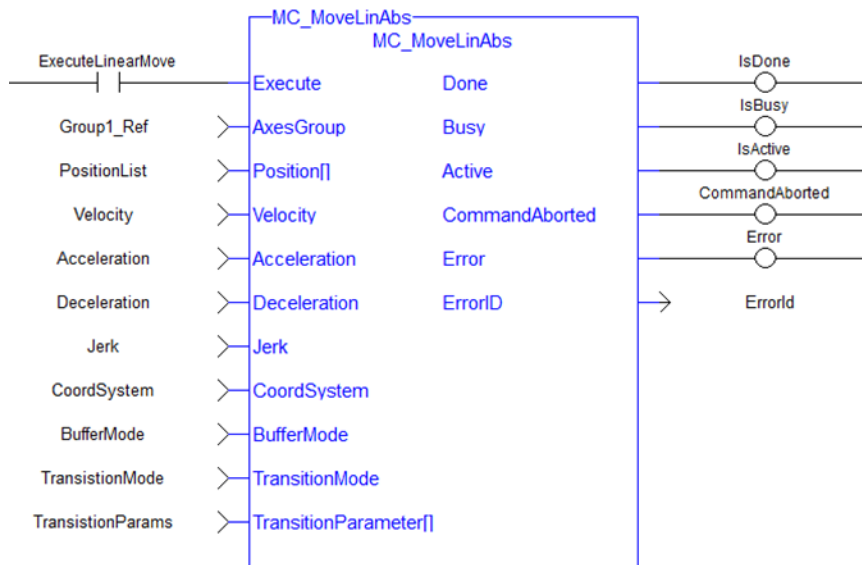

2.3.196.0.1 MC_MoveLinRel

PLCopen ✓ Pipe Network ✓

2.3.196.0.1.1 Description

MC_MoveLinRel commands interpolated linear movement of an axes group to the specified relative positions. The dimensionality of the move is determined by the number of axes mapped to the group.

NOTE

- An error is returned if the group is in the GroupDisabled state.
- The maximum number of axes is set by the **MaxNumberOfAxes** input set in the [Related Function Blocks](#) function block.
- S-Curve motion is not currently supported. The *Jerk* input is currently ignored. S-Curve motion and the *Jerk* argument will be supported in a future release. .

When all motion has completed successfully, the state of the axes group goes to GroupStandby. See [Transition Between Moves](#) for additional information.

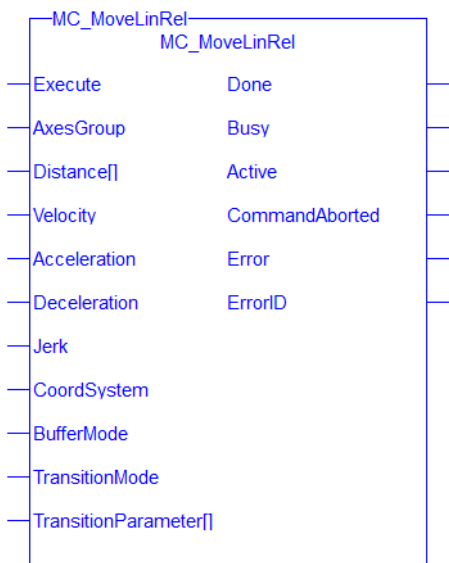

Figure 1-125: MC_MoveLinRel

2.3.197 Related Functions

[Related Functions](#), [MC_ErrorDescription](#)

See also "[Coordinated Motion](#)", the top-level topic for Coordinated Motion.

2.3.197.0.0.1 Arguments

2.3.198 Input

Execute	Description	On the rising edge request to perform a linear relative move
	Data Type	BOOL
	Range	0, 1
	Unit	N/A
	Default	—
AxesGroup	Description	The axis group that will perform the linear relative move
	Data Type	AXIS_GROUP_REF
	Range	N/A
	Unit	N/A
	Default	—
Distance[]	Description	Array of distances for each axis in the group.
	Data Type	LREAL
	Range	N/A
	Unit	user units
	Default	—
Velocity	Description	Maximum velocity of the defined path
	Data Type	LREAL
	Range	$0 < \text{Velocity} < (20 * \text{Acceleration})$ and $0 < \text{Velocity} < (20 * \text{Deceleration})$ See Limitations on Acceleration and Jerk for more information.
	Unit	user units per second
	Default	—
Acceleration	Description	Maximum acceleration
	Data Type	LREAL
	Range	$0 < \text{Velocity} < (20 * \text{Acceleration})$ See Limitations on Acceleration and Jerk for more information.

	Unit	user units per second ²
	Default	—
Deceleration	Description	Maximum deceleration
	Data Type	LREAL
	Range	0 < Velocity < (20 * Deceleration) See Limitations on Acceleration and Jerk for more information.
	Unit	user units per second ²
	Default	—
Jerk	Description	Maximum jerk
	Data Type	LREAL
	Range	For trapezoidal velocity profiles: 0 For S-Curve velocity profiles: (Velocity / 20) < Acceleration < (2 * Jerk) and (Velocity / 20) < Deceleration < (2 * Jerk) See Limitations on Acceleration and Jerk for more information.
		NOTE S-Curve motion is currently not supported and the <i>Jerk</i> input is currently ignored. S-Curve motion and the <i>Jerk</i> argument will be supported in a future release.
	Unit	user units per second ³
	Default	—
CoordSystem	Description	The coordinate system used when commanding the linear relative move Currently, only the ACS coordinate system is supported. See Coordinate Systems to learn more.
	Data Type	SINT
	Range	One of the following enumeration values: <ul style="list-style-type: none"> MC_COORDINATE_SYSTEM_ACS = 0 MC_COORDINATE_SYSTEM_MCS = 1 MC_COORDINATE_SYSTEM_PCS = 2
	Unit	N/A
	Default	—

BufferMode	Description	<p>Defines the chronological sequence of the function block relative to the previous block.</p> <p>MC_BUFFER_MODE_ABORTING = 0 = Abort MC_BUFFER_MODE_BUFFERED = 1 = Buffered MC_BUFFER_MODE_BLENDED_PREVIOUS = 2 = Blending Previous MC_BUFFER_MODE_BLENDED_NEXT = 3 = Blending Next MC_BUFFER_MODE_BLENDED_LOW = 4 = Blending Low MC_BUFFER_MODE_BLENDED_HIGH = 5 = Blending High</p> <p>The buffer mode is limited to MC_BUFFER_MODE_BUFFERED for groups with more than two axes.</p> <p>The blending modes (2, 3, 4, & 5) match the path velocity at the active move's endpoint. Some individual axis velocities may make an abrupt change if the path of the next move travels in a different direction. A transition move may be programmed at the <code>TransitionMode</code> input to avoid this.</p> <p>See the table in Buffer Modes</p>
	Data Type	SINT
	Range	—
	Unit	N/A
	Default	—
TransitionMode	Description	<p>Coupled with the <code>TransitionParameter[]</code>, this input defines the shape and dynamics of the inserted contour to connect the current motion with the next motion in the queue.</p> <p>See Transition Between Moves for additional information.</p>
	Data Type	SINT
	Range	<p>The value is limited to the following:</p> <ul style="list-style-type: none"> MC_TRANSITION_MODE_NONE = 0 MC_TRANSITION_MODE_CORNER_DISTANCE = 3 <p>The transition mode is limited to MC_TRANSITION_MODE_NONE for groups with more than three axes.</p>
	Unit	N/A
	Default	—
TransitionParameter[]	Description	<p>This array is dependent on the <code>TransitionMode</code> specified. The transition parameter values are applied to the axis group. See table: "Transition Mode Parameters" for details.</p>
	Data Type	LREAL

Range	[0, N] The value of N is dependent on the TransitionMode specified.
Unit	N/A
Default	—

2.3.199 Output

Done	Description	If True, then the command completed successfully.
	Data type	BOOL
Busy	Description	If True, then the function block is executing.
	Data type	BOOL
Active	Description	If True, then the function block is still controlling motion.
	Data type	BOOL
CommandAborted	Description	If True, then the command was aborted by another function block.
	Data type	BOOL
Error	Description	If True, then an error has occurred
	Data type	BOOL
ErrorID	Description	Indicates the error if Error output is set to TRUE. See table in PLCopen Function Block ErrorID Output
	Data type	INT

2.3.199.0.0.1 Example

2.3.200 Structured Text

```
(* Inst_MC_MoveLinRelST example *)
```

```
Inst_MC_MoveLinRel( ExecuteLinearMove, Group1_Ref, DistanceList,  
Velocity, Acceleration, Deceleration, Jerk, CoordSystem, BufferMode,  
TransitionMode, TransitionParams );
```

2.3.201 IL

```
BEGIN_IL  
    CAL Inst_MC_MoveLinRel( ExecuteLinearMove, Group1_Ref, DistanceList,  
Velocity, Acceleration, Deceleration, Jerk, CoordSystem, BufferMode,  
TransitionMode, TransitionParams )  
END_IL
```

2.3.202 FBD

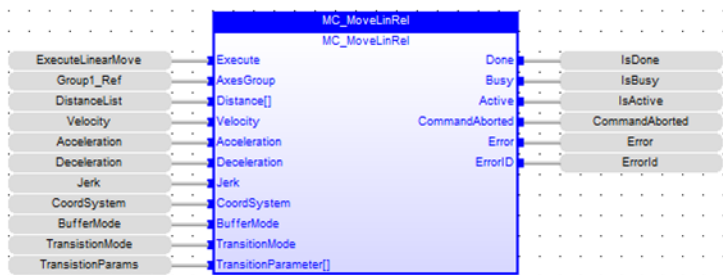

2.3.203 FFLD

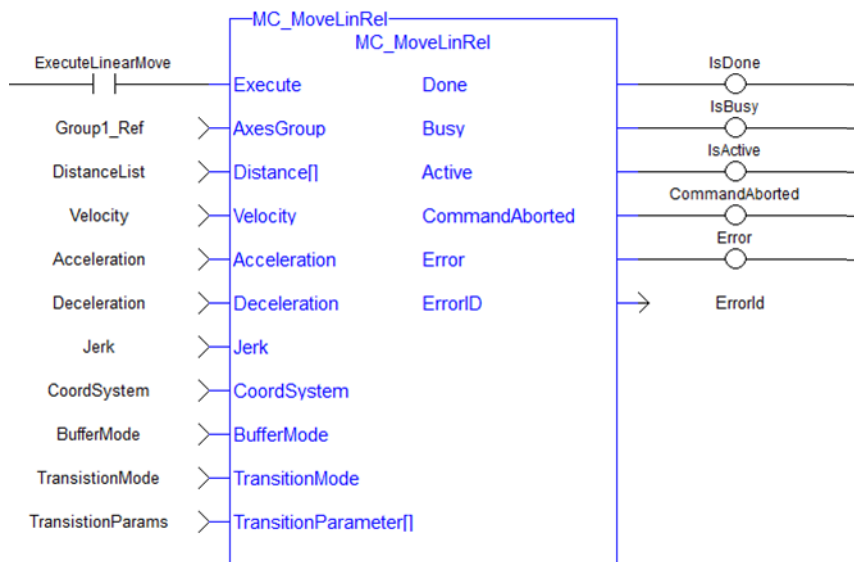

2.3.203.1 Coordinated Motion Reference Library

Function	Description
Related Functions	Sets the position of the group.

2.3.203.1.1 MC_GrpSetPos PLCopen ✓ Pipe Network ✓

2.3.203.1.1.1 Description

MC_GrpSetPos sets the axis command position for all of the axes in an axes group to the positions specified in the `Position` input. This function block does not cause any motion. The axes group must be enabled and in Standby mode for MC_GrpSetPos to execute. If it is not, this FB will return an error and the axis positions will remain unchanged. The command position is that returned by the Function Block MC_GrpReadCmdPos.

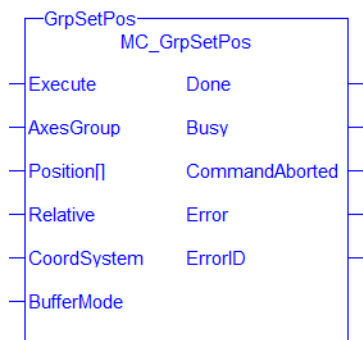

Figure 1-126: MC_GrpSetPos

NOTE

This function block starts a motion-related action and therefore stores data for calculations and error checking. Please see [Calling Function Blocks Multiple Times in the Same Cycle](#) if you are using a dual-core controller.

2.3.204 Related Functions

[MC_ErrorDescription](#), [Related Function Blocks](#)

See also "Coordinated Motion", the top-level topic for Coordinated Motion.

2.3.204.0.0.1 Arguments**2.3.205 Input**

Execute	Description	On the rising edge, request to set the position of the group
	Data Type	BOOL
	Range	0, 1
	Unit	N/A
	Default	—
AxesGroup	Description	The axis group for which to set the positions
	Data Type	AXIS_GROUP_REF
	Range	N/A
	Unit	N/A
	Default	—
Position[]	Description	An array containing the position for each axis in the group. If "Relative" is set, position represents a distance rather than an absolute position. The length of the array must equal the maximum number of axes allowed in the group. The maximum number of axes is an argument to <code>MC_CreateAxesGrp</code> , which is used to create axes groups.
	Data Type	LREAL
	Range	[0, Number of axes in group-1]
	Unit	N/A
	Default	—
Relative	Description	Request to set relative (1) or absolute (0) position
	Data Type	BOOL
	Range	1, 0
	Unit	N/A
	Default	—
CoordSystem	Description	The coordinate system used when setting the positions.

	Data Type	SINT
	Range	One of the following enumeration values: <ul style="list-style-type: none"> • MC_COORDINATE_SYSTEM_ACS = 0 • MC_COORDINATE_SYSTEM_MCS = 1 • MC_COORDINATE_SYSTEM_PCS = 2 <p>Currently, only the ACS coordinate system is supported. See Coordinate Systems for more information.</p>
	Unit	N/A
	Default	—
BufferMode	Description	Currently unused
	Data Type	SINT
	Range	[0, 0]
	Unit	N/A
	Default	—

2.3.206 Output

Done	Description	If True, then the command completed successfully.
	Data Type	BOOL
Busy	Description	Currently unused, returns FALSE
	Data Type	BOOL
CommandAborted	Description	Currently unused, returns FALSE
	Data Type	BOOL
Error	Description	If True, an error has occurred.
	Data Type	BOOL
ErrorID	Description	Indicates the error identifier if Error output is set to TRUE. See the table in PLCopen Function Block ErrorID Output .
	Data Type	INT

2.3.206.0.0.1 Example

2.3.207 ST

```
Inst_MC_GrpSetPos( DoSetPos, Group1, PositionArray, Relative, MC_
COORDINATE_SYSTEM_ACS, 0 );
```

2.3.208 FBD

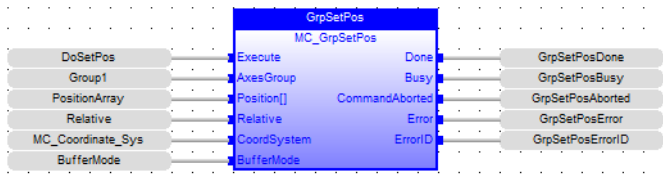

2.3.209 IL

```

BEGIN_IL
    CAL Inst_MC_GrpSetPos( DoSetPos, Group1, PositionArray, Relative,
        MC_COORDINATE_SYSTEM_ACS, BufferMode);
END_IL
    
```

2.3.210 FFLD

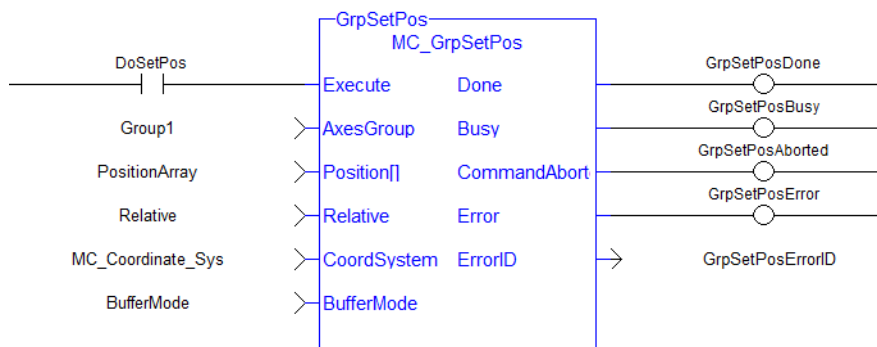

3 Fieldbus Library

3.1 EtherCAT Library

Name	Description
DriveParamRead	Reads a drive parameter (ASCII format)
DriveParamStrRead	Reads a single drive parameter (ASCII format)
DriveParamWrite	Writes a drive parameter (ASCII format)
ECATCommErrors	Returns a list of bad EtherCAT connections
ECATDeviceAction	Performs an action on an EtherCAT device.
ECATDeviceStatus	Provides EtherCAT state and port link status information for an EtherCAT device.
ECATDevReadParam	This function block returns the EtherCAT device-specific information.
ECATGetObjVal	Reads cyclic drive parameter (String format) by returning the value of an EtherCAT PDO element
ECATMasterStatus	Reads the EtherCAT master state and the lost frame counter
ECATReadData	Reads cyclic parameter (byte offset format)
ECATReadSDO	Reads parameter (32 bit format) using SDO command
ECATWCStatus	Returns the current number of working counter errors for the Sync unit
ECATWriteData	Writes cyclic parameter (byte offset format)
ECATWriteSDO	Writes parameter (32 bit format) using SDO command
FSoEParamsInit	Transfers safety parameters from the safety master to safety slave devices to initialize the safety network.

Table 1-4: List of EtherCAT Function Blocks

The four EtherCAT SDO function blocks are activated by the CANopen over EtherCAT (CoE) protocol in a client/server mode.

- The client (aka EtherCAT master) is the KAS Runtime application
- The servers (aka EtherCAT slaves) are the drives and I/O nodes where data can be retrieved

The SDO function blocks only support the reading and writing of 32-bit values. It is the fundamental size of CANopen SDO calls.

Why use ECATReadSdo and ECATWriteSdo FBs?

The ECATReadSdo and ECATWriteSdo response time is faster and therefore is typically preferred over the DriveParamRead and DriveParamWrite.

Why use the DriveParam FBs?

The two reasons to prefer the DriveParam FBs are:

- They allow direct use of the parameter name (e.g. IL.LIMITP instead of the SDO index: 356Eh)
- They can be used to setup a drive terminal in the HMI application (which is similar to the [Terminal](#) view available in the AKD widget embedded in the KAS IDE)

3.1.1 EtherCAT Function Blocks That Work With Drive Parameters

These function blocks are used to work with drive parameters that are not supported by ML and MC function blocks. They support reading and writing drive parameters using the non-cyclic SDO channel in the EtherCAT network. The ASCII name for the parameter is used as an input.

3.1.1.1 Execution Time

These function blocks typically take a longer time to execute (up to ten cycles to finish executing). It takes the same amount of time to Read or Write a parameter.

NOTE

It takes more than one cycle to execute these function blocks (but less than 100 ms).

3.1.1.1.1 Reason

It is not only linked to the SDO ASCII communication. Because these FBs are waiting for the AKD drive to respond, the execution time can also increase due to the load of the AKD firmware at the time you call them.

3.1.1.1.2 Result

The PLC code is overrunning the cycle duration. as explained in Tasking Model / Scheduling. As a consequence, you can see the following message in the Controller Log window:

"The Virtual Machine missed 1 cycle(s) of PLC execution"

3.1.1.1.3 Solution

When this happens we recommend to:

- Use these function blocks sparingly in programs
- Rely on the EtherCAT read/write SDO function blocks whenever possible
- Smooth the load of the PLC code by executing these function blocks at the required update rate.

See some **stats** about the FB execution time

- There is a small difference in timing when running EtherCAT at 2ms compared to other frequencies.

	0.25, 0.5, 1ms	2ms
Mean	9ms	14ms
Min	3ms	8ms
Max	16ms	24ms

- **Max** time to consider when executing a single SDO command, (i.e. before the Done output becomes true): **24ms**.
- **Max** time to consider when executing a single Drive Parameter command (i.e. before the Done output becomes True): **60 ms**

	4 kHz	1 kHz
Mean	20 ms	11 ms
Min	15 ms	9 ms
Max	45 ms	58 ms

- When sending multiple commands to a single drive, only one command can be sent at a time. Therefore the time to execute multiple commands is:
Number of commands x Execution time of a single command
- When commands are sent to different AKD drives at the same time, the requests do not interfere with each other. So you can be confident the function finishes execution in the same max time as to one drive.

3.1.2 EtherCAT Function Blocks That Work With SDOs

[ECATReadSDO](#) and [ECATWriteSDO](#) are used to work with drive or remote I/O parameters that are not supported by ML and MC function blocks. Drive or remote I/O parameters that have an associated SDO number can be read and written using these function blocks.

NOTE

It takes more than one cycle to execute these function blocks (but less than 100 ms).

See some **stats** about the FB execution time

- There is a small difference in timing when running EtherCAT at 2ms compared to other frequencies.

	0.25, 0.5, 1ms	2ms
Mean	9ms	14ms
Min	3ms	8ms
Max	16ms	24ms

- **Max** time to consider when executing a single SDO command, (i.e. before the Done output becomes true): **24ms**.
- **Max** time to consider when executing a single Drive Parameter command (i.e. before the Done output becomes True): **60 ms**

	4 kHz	1 kHz
Mean	20 ms	11 ms
Min	15 ms	9 ms
Max	45 ms	58 ms

- When sending multiple commands to a single drive, only one command can be sent at a time. Therefore the time to execute multiple commands is:
Number of commands x Execution time of a single command
- When commands are sent to different AKD drives at the same time, the requests do not interfere with each other. So you can be confident the function finishes execution in the same max time as to one drive.

3.1.3 DriveParamRead

PLCopen ✓

Pipe Network ✓

3.1.3.1 Description

This function block reads a drive parameter by sending an ASCII command to a drive.

See [EtherCAT Function Blocks That Work With Drive Parameters](#) for information about function blocks which work with drive parameters that are not supported by ML and MC function blocks.

It takes multiple cycles to complete this function block. Typically only *one* DriveParamRead or [DriveParamWrite](#) function should be active for *each axis* at one time. If executing this function block continuously or multiple times is required, add code that waits for this function block to complete (Done bit = 1) before executing it again, as shown in the example below.

See also some **stats** about the [Execution Time](#).

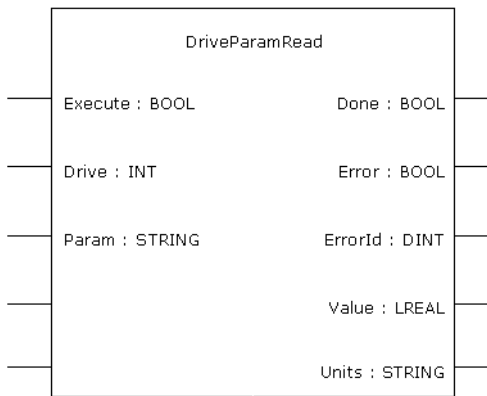

Figure 1-127: DriveParamRead

NOTE

This function block uses *and reserves* the EtherCAT SDO Channel. The SDO Channel will remain reserved until the done output is "true". Therefore, this FB should be called at each cycle until the done output is true. If it is not called at each cycle the rest of SDO communication (the AKD GUI Views, for example) will be blocked.

Using this FB in SFC P0 or P1 steps is not recommended as these steps are executed only once. If this FB is used in P0 or P1 then it must be used in an SFC N step to ensure the FB completes.

3.1.3.2 Arguments

3.1.3.2.1 Input

Execute	Description	On the rising edge of Execute, a drive parameter is read. The function block only handles one request at a time. If Execute is toggled quickly so that another rising edge occurs before the function block has completed, the function block does not issue a second read command.
	Data type	BOOL
	Range	0, 1
	Unit	N/A
	Default	—

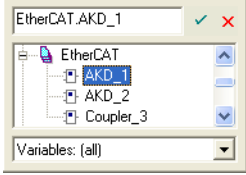
Drive	Description	The address of the drive from which data is read. The first node usually has the value '1001'. The second node usually has the value '1002'. Alternately, you can use the members of the EtherCAT structure to specify a drive's address when you create the variable .
		
	Data type	INT
	Range	—
	Unit	N/A
Param	Description	The parameter to read.
	Data type	STRING
	Range	—
	Unit	N/A
	Default	—

3.1.3.2.2 Output

Done	Description	Indicates whether the DriveParamRead function block has completed without error.
	Data type	BOOL
	Unit	N/A
Error	Description	Indicates whether the DriveParamRead function block call has completed with error:
	Data type	BOOL
	Unit	N/A
ErrorID	Description	The DriveParamRead error result if Error is TRUE (see list of Error Codes in table below). Upon success, Error is set to zero.
	Data type	DINT
	Unit	N/A

Value	Description	The value of the drive parameter. Value is only set when the function block has successfully completed.
	Data type	LREAL
	Unit	N/A
Units	Description	The units of the drive parameter. Value is only set when the function block has successfully completed.
	Data type	STRING
	Unit	N/A

Error Code	Value dec (hex)	Description
ECERR_OK	0	The SDO call succeeded
ECERR_DEVICE_ERROR	1792 (0x700)	EtherCAT device is not accessible
ECERR_DEVICE_INVALIDCMD	1794 (0x702)	Invalid mailbox command
ECERR_DEVICE_INVALIDINDEX	1795 (0x703)	An invalid value for the Index input was specified
ECERR_DEVICE_INVALIDACCESS	1796 (0x704)	Reading of the variable is not permitted
ECERR_DEVICE_INVALIDSIZE	1797 (0x705)	An invalid size for the parameter was specified
ECERR_DEVICE_INVALIDDATA	1798 (0x706)	Invalid parameter value(s) in SDO index and/or sub-index
ECERR_DEVICE_NOTREADY	1799 (0x707)	Device is not in a ready state, network is not in operational
ECERR_DEVICE_BUSY	1800 (0x708)	Device is not available to respond
ECERR_DEVICE_INVALIDCONTEXT	1801 (0x709)	Device responded with an illegal error code, indicating the command is not allowed under the present conditions
ECERR_DEVICE_NOMEMORY	1802 (0x70A)	EtherCAT mailbox is out of memory or device is out of disk space
ECERR_DEVICE_INVALIDPARM	1803 (0x70B)	EtherCAT mailbox request was not valid
ECERR_DEVICE_NOTFOUND	1804 (0x70C)	EtherCAT device not found
ECERR_DEVICE_SYNTAX	1805 (0x70D)	An unexpected error occurred
ECERR_DEVICE_INVALIDSTATE	1810 (0x712)	The EtherCAT device is in an invalid state
ECERR_DEVICE_TIMEOUT	1817 (0x719)	The EtherCAT device failed to respond, timing out
ECERR_DEVICE_INSERTMAILBOX	1826 (0x722)	Error while inserting the mailbox command into internal FIFO
ECERR_DEVICE_INVALIDOFFSET	1827 (0x723)	An invalid value for the SubIndex input was specified

Error Code	Value dec (hex)	Description
ECERR_DEVICE_UNKNOWNMAILBOXCMD	1828 (0x724)	The master sent an unknown mailbox command to the slave
ECERR_DEVICE_ACCESSDENIED	1829 (0x725)	Device responded with an invalid access error code, indicating the command is not allowed
ECERR_DEVICE_INVALIDADDR	1832 (0x728)	Can't send a mailbox command to the specified slave
ECERR_DEVICE_NOT_A_FSOE_MASTER	1836 (0x72c)	Device is not a FSoE master.
ECERR_DEVICE_PARAM_ACCESS_ERROR	1920 (0x780)	Unknown error occurred while accessing parameter
ECERR_DEVICE_PARAM_NOT_FOUND	1921 (0x781)	Parameter was not found
ECERR_DEVICE_PARAM_NOT_INTEGER	1922 (0x782)	Parameter is a floating-point value. Integer value required.
ECERR_DEVICE_VALUE_IS_NEGATIVE	1923 (0x783)	No negative values allowed. Value specified was negative.
ECERR_DEVICE_VALUE_OUT_OF_RANGE	1924 (0x784)	Value is out of data-range
ECERR_DEVICE_VALUE_GREATER_THAN_MAX	1925 (0x785)	Value bigger than maximum
ECERR_DEVICE_VALUE_LOWER_THAN_MIN	1926 (0x786)	Value lower than minimum
ECERR_CLIENT_ERROR	2048 (0x800)	Error in Mailbox response to a previously sent mailbox command
ECERR_CLIENT_TIMEOUT	2049 (0x801)	The SDO command timed out
ECERR_CLIENT_INVALIDPARM	2050 (0x802)	An invalid value was specified
ECERR_CLIENT_INVALIDSIZE	2051 (0x803)	An invalid value for the size input was specified

Table 1-5: List of EtherCAT Error Codes

3.1.3.3 Usage

Use this FB to read drive parameters that are not supported by other function blocks. Examples would be motor temperature, drive bus voltage, Present drive limit settings, present regen loading, drive display, and fault history.

3.1.3.4 Related Functions

[DriveParamWrite](#)

3.1.3.5 Example

3.1.3.5.1 Structured Text

```
(* Read PL.KP on first AKD Drive on EtherCAT network *)
```

```
(* The code continually calls the FB (without re-executing it) until the
```

```
first execution is done, then reads the returned value from the drive and
reset the FB *)
```

```
IF ReadPropGain then
  Inst_DriveParamRead1( 1, 1001, 'PL.KP' );
End_If;

On Inst_DriveParamRead1.Done do
  Inst_DriveParamRead1( 0, 1001, 'PL.KP' );
  PositionProportionalGain := Inst_DriveParamRead1.Value; (* Reads the
returned value from the drive *)
  ReadPropGain := 0; (* Reset the FB *)
End_DO;
```

3.1.3.5.2 FBD

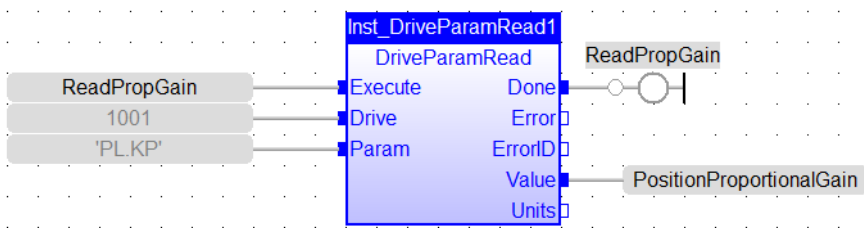

3.1.3.5.3 FFLD

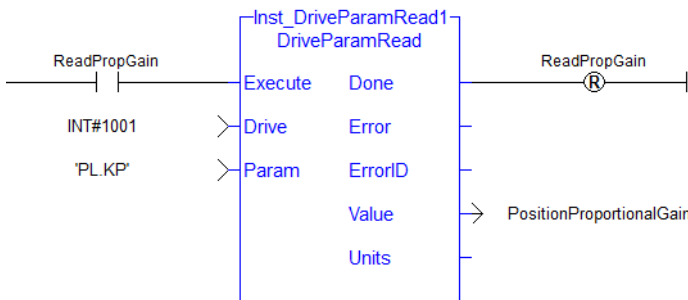

3.1.4 DriveParamStrRead

PLCopen ✓

Pipe Network ✓

3.1.4.1 Description

This function block reads a single drive parameter by sending an ASCII command to a drive. The value returned is the string response from the drive.

NOTE

This differs from [DriveParamRead](#) in that the drive response is not parsed. [DriveParamRead](#) parses the drive response and returns the numeric value of the parameter and the units found that represent that parameter. Since [DriveParamStrRead](#) returns the drive response directly, it can be used to read parameters that have string representations, such as the AKD2G's `AXIS#.FAULTMSG#` parameters.

See [EtherCAT Function Blocks That Work With Drive Parameters](#) for information about function blocks which work with drive parameters that are not supported by ML and MC function blocks.

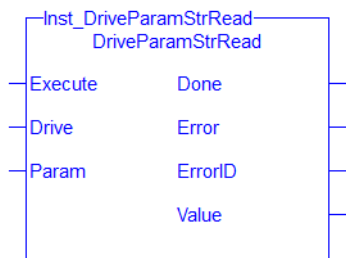

Figure 1-128: DriveParamStrRead

NOTE

This function block uses *and reserves* the EtherCAT SDO Channel. The SDO Channel will remain reserved until the done output is "true". Therefore, this FB should be called at each cycle until the done output is true. If it is not called at each cycle the rest of SDO communication (the AKD GUI Views, for example) will be blocked.

Using this FB in SFC P0 or P1 steps is not recommended as these steps are executed only once. If this FB is used in P0 or P1 then it must be used in an SFC N step to ensure the FB completes.

3.1.4.2 Arguments

3.1.4.2.1 Input

Execute	Description	Executes the Function Block
	Data type	BOOL
	Range	0, 1
	Unit	N/A
	Default	—
Drive	Description	The address of the drive from which data is read.
	Data type	INT
	Range	—
	Unit	N/A
	Default	—
Param	Description	The parameter to read.
	Data type	STRING
	Range	—
	Unit	N/A
	Default	—

3.1.4.2.2 Output

Done	Description	Indicates whether this function block has completed without error.
	Data type	BOOL
	Unit	N/A
Error	Description	Indicates whether this function block call has completed with error:
	Data type	BOOL
	Unit	N/A
ErrorID	Description	The DriveParamStrRead error result if Error is TRUE (see list of Error Codes in table below). Upon success, Error is set to zero.
	Data type	DINT
	Unit	N/A
Value	Description	The value of the drive parameter. Value is only set when the function block has successfully completed.
	Data type	STRING
	Unit	N/A

3.1.4.3 Usage

Use this FB to read drive parameters that are not supported by other function blocks. Examples would be motor temperature, drive bus voltage, Present drive limit settings, present regen loading, drive display, and fault history.

3.1.4.4 Related Functions

[DriveParamRead](#), [DriveParamWrite](#)

3.1.4.5 Example

3.1.4.5.1 Structured Text

```
(* Read AXIS1.FAULTMSG1 on first AKD2G Drive on EtherCAT
network *)

(* The code continually calls the FB (without re-executing it) until the
first execution is done, then reads the returned value from the drive and
reset the FB *)

IF ReadFaultMsg Then
  Inst_DriveParamStrRead1(True, 1001, 'AXIS1.FAULTMSG1' );
End_If;

On Inst_DriveParamStrRead1 Do
  FaultMsg := Inst_DriveParamStrRead1.Value; (* Reads the returned value
from the drive *)
  Inst_DriveParamStrRead1(False, 1001, 'AXIS1.FAULTMSG1');
```

```
ReadFaultMsg := False; (* Reset the FB *)
d_DO;
```

3.1.5 DriveParamWrite

PLCopen ✓

Pipe Network ✓

3.1.5.1 Description

This function block writes a drive parameter by sending an ASCII command to a drive.

It takes multiple cycles to complete this function block. Typically only *one* DriveParamRead or DriveParamWrite function should be active for *each axis* at one time. If executing this function block continuously or multiple times is required, add code that waits for this function block to complete (Done bit = 1) before executing it again, as shown in DriveParamRead.

See also some **stats** about the execution time [here](#).

See [EtherCAT Function Blocks That Work With Drive Parameters](#) for information about function blocks which work with drive parameters that are not supported by ML and MC function blocks.

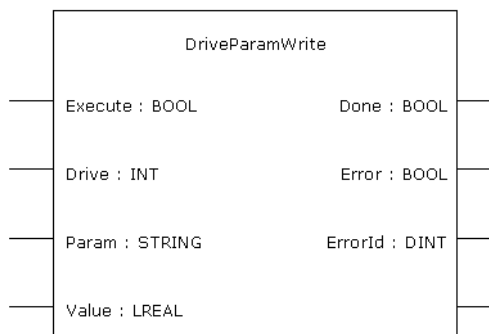

Figure 1-129: DriveParamWrite

NOTE

This function block uses *and reserves* the EtherCAT SDO Channel. The SDO Channel will remain reserved until the done output is "true". Therefore, this FB should be called at each cycle until the done output is true. If it is not called at each cycle the rest of SDO communication (the AKD GUI Views, for example) will be blocked.

Using this FB in SFC P0 or P1 steps is not recommended as these steps are executed only once. If this FB is used in P0 or P1 then it must be used in an SFC N step to ensure the FB completes.

3.1.5.2 Arguments

3.1.5.2.1 Input

Execute	Description
	On the rising edge of Execute, a drive parameter is set. The function block only handles one request at a time. If Execute is toggled quickly so that another rising edge occurs before the function block has completed, the function block does not issue a second write command.
	Data type BOOL
	Range 0, 1
	Unit N/A
	Default —

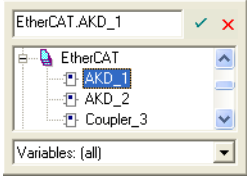
Drive	Description	The address of the drive to which data is written to. The first node usually has the value '1001'. The second node usually has the value '1002'. Alternately, you can use the members of the EtherCAT structure to specify a drive's address when you create the variable .
		
	Data type	INT
	Range	—
	Unit	N/A
	Default	—
Param	Description	The parameter to write.
	Data type	STRING
	Range	—
	Unit	N/A
	Default	—
Value	Description	The value to set the drive parameter to.
	Data type	LREAL
	Range	—
	Unit	N/A
	Default	—

3.1.5.2.2 Output

Done	Description	Indicates whether the DriveParamWrite function block has completed without error.
	Data type	BOOL
	Unit	N/A
Error	Description	Indicates whether the DriveParamWrite function block call has completed with error.
	Data type	BOOL
	Unit	N/A
ErrorID	Description	The DriveParamWrite error result if Error is TRUE (see List of EtherCAT Error Codes (→ p. 533)) Upon success, Error is set to zero.

Data type	DINT
Unit	N/A

3.1.5.3 Usage

The function block can be used to change drive parameters. Common examples include tuning parameters and changing drive limits such as peak current.

3.1.5.4 Related Functions

[DriveParamRead](#)

3.1.5.5 Example

3.1.5.5.1 Structured Text

```
(* Write 58.000 to PL.KP of first AKD Drive on EtherCAT network *)
Inst_DriveParamWrite( TRUE, 1001, 'PL.KP', 58 );
```

3.1.5.5.2 FBD

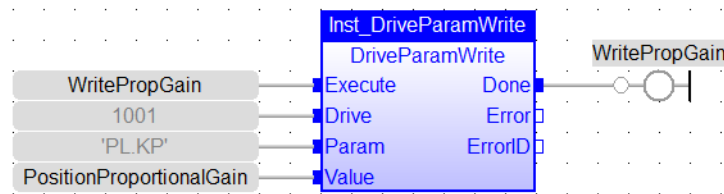

3.1.5.5.3 FFLD

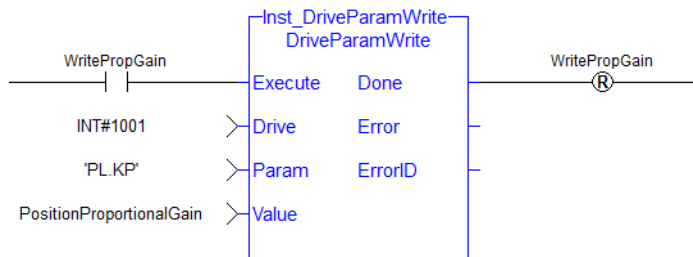

3.1.6 ECATCommErrors PLCopen ✔

3.1.6.1 Description

This function block returns a list of bad EtherCAT connections. If EtherCAT network communication is shutdown, the failed connections are based on information that was taken at the time the network was shutdown.

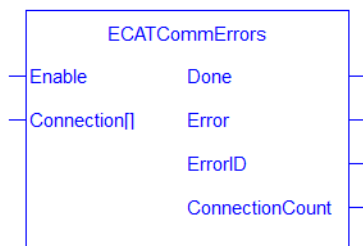

Figure 1-130: ECATCommErrors function block

ECATCommErr_ref Structure

Parameter	Type	Description
CommErrorCounter	UINT	The Communication Error Counter for this port.
ConnectedSlaveAddress	INT	The EtherCAT address of the connected device.
ConnectedSlavePortID	UINT	The port number of the connected device.
LostLinkCounter	UINT	The Lost Link Counter for this port.
SlaveAddress	INT	The EtherCAT address of the device that owns the port.
SlavePortID	UINT	The port number.

EtherCAT Port Number Defines

Define	Port
#define EC_PORT_A	0 (* Port A *)
#define EC_PORT_B	1 (* Port B *)
#define EC_PORT_C	2 (* Port C *)
#define EC_PORT_D	3 (* Port D*)

3.1.6.2 Arguments**3.1.6.2.1 Input**

Execute	Description	Read the communication errors on the rising edge
	Data type	BOOL
	Range	0,1
	Unit	N/A
	Default	—
Connection	Description	Array of bad connections. The safe size for the list is $[2 * (\text{number of devices}) - 1]$.
	Data type	ECATCommErr_ref (see ECATCommErr_ref Structure table above)
	Range	N= 0 to 2 times the number of EtherCAT devices.
	Unit	N/A
	Default	—

3.1.6.2.2 Output

Done	Description	Indicates when the function is complete
	Data type	BOOL
	Unit	N/A
Error	Description	Indicates the function failed due to an error.
	Data type	BOOL

	Unit	N/A
ErrorID	Description	The function call error result, if Error is TRUE (see Possible Error Codes and Descriptions table below). Upon success, Error is set to zero..
	Data type	DINT
	Unit	N/A
ConnectionCount	Description	The number of bad connections. Valid indices in the Connection array range from zero to ConnectionCount -1 (assuming that ConnectionCount != 0).
	Data type	UINT
	Unit	N/A

Possible Error Codes and Descriptions

Error Code	Description
ECERR_DEVICE_ERROR	The EtherCAT driver is in a bad state
ECERR_INVALID_ARRAY_SIZE	The size of the Connections is too small

NOTE

When the array size is smaller than the number of bad connections, the array is filled with the data to the extent of the size of the array and the error 'ECERR_INVALID_ARRAY_SIZE' is also set. In this scenario, the output **ConnectionCount** is set to the size of the array and it is smaller than the number of actual bad connections.

3.1.6.3 Related Functions

- [ECATDeviceStatus](#)
- [ECATMasterStatus](#)

3.1.6.4 Example

TIP

See [Checking the Connections for Errors](#): in the [EtherCAT Communication Diagnosis Steps](#) section of the Troubleshooting chapter for an example of implementing this function.

3.1.6.4.1 Structured Text

```
(*****  
Read EtherCAT communication errors.  
*****)  
commErrors( TRUE, Connection);
```

3.1.6.4.2 FBD

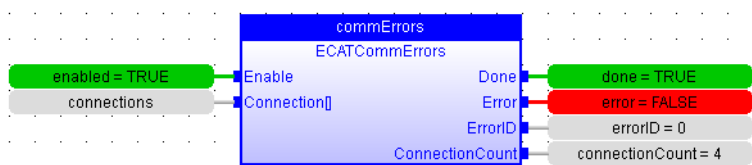

3.1.6.4.3 FFLD

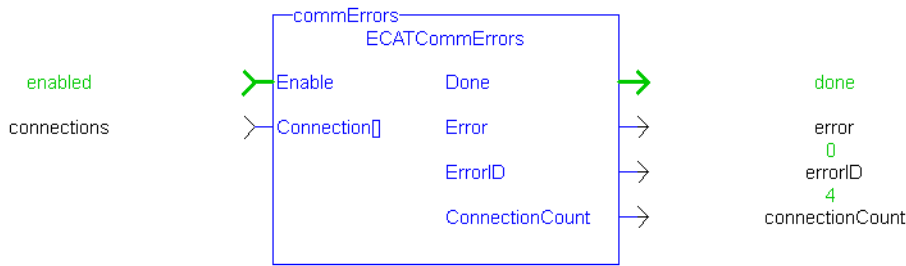

3.1.7 ECATDeviceAction



3.1.7.1 Description

This function block performs an action on an EtherCAT device. This function returns immediately, and can be called multiple times in one cycle.

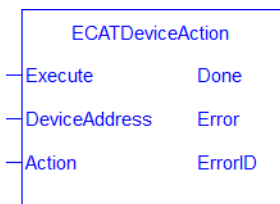

Figure 1-131: ECATDeviceAction function block

The following actions are currently supported

- DEVICE_ACTION_DISCONNECT
 - The EtherCAT master is notified to expect the node to be removed from the EtherCAT when ECATDeviceAction is called with "DEVICE_ACTION_DISCONNECT".
 - Any Axis/Axes mapped to a drive node will be automatically simulated.
 - The last position from the physical drive will be carried over to the simulation when the EtherCAT restarts.
- DEVICE_ACTION_CONNECT
 - This action connects the already disconnected node to the EtherCAT Network
 - The axis (or axes) that was acting as simulated axis becomes a normal axis when the drive node is connected.
 - The axis/axes position will come directly from the configured drive feedback. The position will not be automatically transferred from the simulated axis.

3.1.7.2 Arguments

3.1.7.2.1 Input

Execute	Description	When Execute is set to True, an action will be performed.
	Data type	BOOL
	Range	0, 1
	Unit	N/A
	Default	—

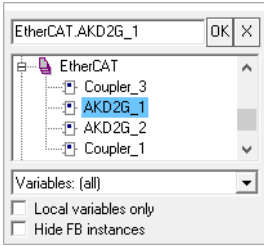
DeviceAddress	Description	The address of the device to perform an action on. The first node usually has the value '1001'. The second node usually has the value '1002'. Alternately, you can use the members of the EtherCAT structure to specify a device's address when you Create Variables .
		 <p>The screenshot shows a tree view of an EtherCAT network configuration. The root node is 'EtherCAT'. Underneath it are several nodes: 'Coupler_3', 'AKD2G_1' (which is highlighted in blue), 'AKD2G_2', and 'Coupler_1'. Below the tree view, there is a 'Variables: (all)' dropdown menu and two checkboxes: 'Local variables only' and 'Hide FB instances', both of which are currently unchecked.</p>
	Data type	INT
	Range	—
	Unit	N/A
	Default	—
Action	Description	The action to be performed. Action can be one of the following values: <ul style="list-style-type: none"> • DEVICE_ACTION_CONNECT — Connects a slave into the EtherCAT network. This action can only be executed when the motion engine is stopped. • DEVICE_ACTION_DISCONNECT — Disconnects a slave from the EtherCAT network. This action can only be executed when the motion engine is stopped.
	Data type	INT
	Range	—
	Unit	N/A
	Default	—

3.1.7.2.2 Output

Done	Description	Indicates whether the ECATDeviceAction function block completed without error.
	Data type	BOOL
	Unit	N/A
Error	Description	Indicates whether the ECATDeviceAction function block call completed with error:
	Data type	BOOL
	Unit	N/A

ErrorID	Description	The ECATDeviceAction error result if Error is TRUE (see list of Error Codes in table below). Upon success, Error is set to zero.
Data type	DINT	
Unit	N/A	

Error Code	Value dec (hex)	Description
ECERR_OK	0	The action succeeded.
ECERR_DEVICE_ACTION_IS_INVALID	1000 (0x3E8)	The specified device action is invalid.
ECERR_DEVICE_IS_DC_CLOCK_MASTER	1001 (0x3E9)	The Device is a DC Clock Master
ECERR_DEVICE_IS_IN_DC_MASTER_UPSTREAM	1002 (0x3EA)	The device is before the DC Clock Master.
ECERR_DEVICE_ACTION_MINIMUM_ONE_NODE_REQD	1003 (0x3EB)	Minimum one node is required in the EtherCAT Network.
ECERR_DEVICE_ERROR	1792 (0x700)	EtherCAT device is not accessible.
ECERR_DEVICE_NOTREADY	1799 (0x707)	Device is not in a ready state. The EtherCAT network is not in the desired state for the specified action.
ECERR_DEVICE_INVALIDADDR	1832 (0x728)	The specified EtherCAT node address is invalid.

3.1.7.3 Usage

The EtherCAT network needs to be stopped to use this function block. This can be achieved by calling ECATDeviceAction prior to calling [MLMotionStart](#) or by first calling [MLMotionStop](#) to stop the network.

3.1.7.4 Related Functions

- [MLMotionStart](#)
- [MLMotionStop](#)

Also see [Modular EtherCAT Concept](#) for information on modular machine design.

3.1.7.5 Examples

3.1.7.5.1 Structured Text

```
MLMotionStop();
MotionEngineStatus := MLMotionStatus();
On MotionEngineStatus = MLSTATUS_STOPPED Do
  Inst_ECATDeviceAction(True, EtherCAT.AKD_3, DEVICE_ACTION_DISCONNECT);
  If Inst_ECATDeviceAction.Error Then
    // Handle Error
    // Error ID value is in Inst_ECATDeviceAction.Error
  End_If;
End_Do;
```

3.1.7.5.2 FBD

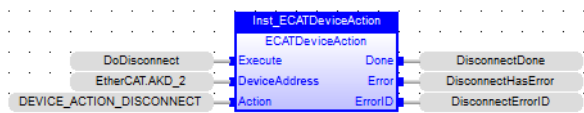

3.1.7.5.3 FFLD

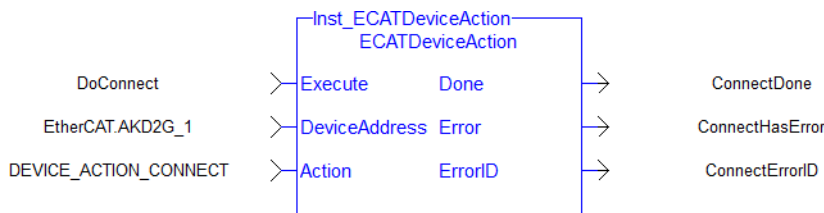

3.1.8 ECATDeviceStatus PLCopen ✓ Pipe Network ✓

3.1.8.1 Description

This function block provides the EtherCAT state and the port link status information for the EtherCAT device. If the EtherCAT network communication is not running due to a shutdown, the device status contains information that was taken at the time the network was shutdown. This function block is useful in locating the device(s) with communication errors when the [ECATWCStatus](#) function indicates there are EtherCAT communication errors.

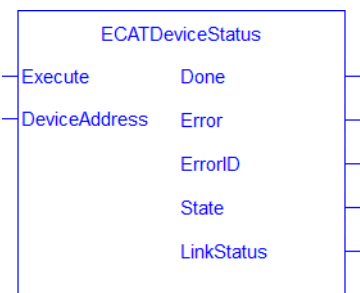

Figure 1-132: ECATDeviceStatus function block

3.1.8.2 Arguments

3.1.8.2.1 Input

Execute	Description	Read the device status on the rising edge
	Data type	BOOL
	Range	0,1
	Unit	N/A
	Default	
DeviceAddress	Description	The address of the device from which data is read. The first node usually has the value '1001'. The second node usually has the value '1002'. Alternately, you can use the members of the EtherCAT structure to specify a device's address when you create the variable.
	Data type	INT
	Range	-

Unit	N/A
Default	-

3.1.8.2.2 Output

Done	Description	Indicates when the function is complete
	Data type	BOOL
	Unit	N/A
State	Description	Indicates the EtherCAT state of the device. See State Defines below for details. <ul style="list-style-type: none"> • A value of zero indicates that there is no communication with the device and the state is unknown. • Bits 3:0 indicate the actual state of the Device. • An EC_STATE_ERROR (bit 4 set to 1) indicates the device is not in the EtherCAT Master requested State due to error conditions such as loss of communication..
	Data type	UINT
	Unit	N/A
LinkStatus	Description	Provides the physical link status of the device's ports. See LinkStatus Defines below. <ul style="list-style-type: none"> • If no communication is possible with the device, then bit 0 is set to '1'. • If a link is detected on a port (A-D), then the corresponding bit (4-7) will be set to '1'. If no link is detected then the corresponding bit will be set to '0'.
	Data type	UINT
	Unit	N/A
Error	Description	Indicates the function failed due to an error.
	Data type	BOOL
	Unit	N/A
ErrorID	Description	The function call error result, if Error is TRUE (see list of Error Codes in table below). Upon success, Error is set to zero..
	Data type	DINT
	Unit	

State Defines

```
#define EC_STATE_NO_COMMUNICATION 0 (* 0x00 = No Communication to
device *)
#define EC_STATE_INIT 1 (* 0x01 = Device in Init state
*)
#define EC_STATE_PREOP 2 (* 0x02 = Device in Pre-
```

```
operational state *)
#define EC_STATE_BOOTSTRAP 3 (* 0x03 = Device in Bootstrap
state *)
#define EC_STATE_SAFEOP 4 (* 0x04 = Device in Safe-
Operational state *)
#define EC_STATE_OP 8 (* 0x08 = Device in Operational
state *)
#define EC_STATE_ERROR 16 (* 0x10 bit 4 set to 1; Device
not in requested state error *)
```

LinkStatus Defines

```
#define EC_LINK_NO_COMMUNICATION 1 (* 0x1 = No communication to
device; bit 0 set to 1 *)
#define EC_LINK_PORT_A 16 (* 0x10 = Link detected on Port
A; bit 4 set to 1 *)
#define EC_LINK_PORT_B 32 (* 0x20 = Link detected on Port
B; bit 5 set to 1 *)
#define EC_LINK_PORT_C 64 (* 0x40 = Link detected on Port
C; bit 6 set to 1 *)
#define EC_LINK_PORT_D 128 (* 0x80 = Link detected on Port
D; bit 7 set to 1 *)
```

3.1.8.3 Related Functions

[ECATWCStatus](#), [ECATMasterStatus](#)

3.1.8.4 Example

TIP

See [Checking the Device States](#): in the [EtherCAT Communication Diagnosis Steps](#) section of the Troubleshooting chapter for an example of implementing this function.

3.1.8.4.1 Structured Text

```
(*****
(* Read AKD_1 device state and link status*)
*****)

Inst_EcDeviceStatus(TRUE,EtherCAT.AKD_1);
```

3.1.8.4.2 FBD

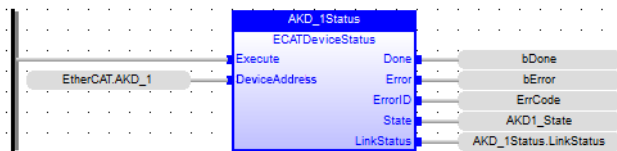

3.1.8.4.3 FFLD

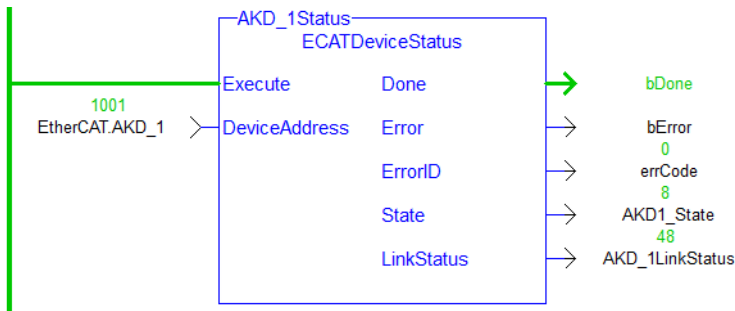

3.1.9 ECATDevReadParam PLCopen ✓ Pipe Network ✓

3.1.9.1 Description

This function block returns the EtherCAT device-specific information.

See [EtherCAT Function Blocks That Work With Drive Parameters](#) for information about function blocks which work with drive parameters that are not supported by ML and MC function blocks.

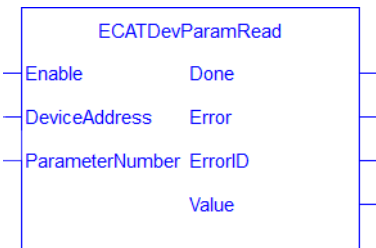

Figure 1-133: ECATDevReadParam

3.1.9.2 Arguments

3.1.9.2.1 Input

Enable	Description	Requests to read the EtherCAT device-specific parameter
	Data type	BOOL
	Range	0, 1
	Unit	N/A
	Default	—
DeviceAddress	Description	The address of the device from which data is read. The first node usually has the value '1001'. The second node usually has the value '1002'. Alternately, you can use the members of the EtherCAT structure to specify a device's address when you create the variable.
	Data type	INT
	Range	-
	Unit	N/A
	Default	—
ParameterNumber	Description	Parameter number, see table in EtherCAT Device Parameters

Data type	INT
Range	—
Unit	N/A
Default	—

3.1.9.2.2 Output

Done	Description	Indicates when the function is complete.
	Data type	BOOL
Error	Description	Indicates an invalid input.
	Data type	BOOL
ErrorID	Description	Indicates the error if Error output is set to TRUE (see List of EtherCAT Error Messages below)
	Data type	INT
Value	Description	Value of the parameter
	Data type	LREAL

List of EtherCAT Error Messages

Error Code	Value dec (hex)	Description
ECERR_OK	0	No Error
ECERR_DEVICE_ERROR	1792 (0x700)	EtherCAT device is not accessible
ECERR_DEVICE_INVALIDADDR	1832 (0x728)	EtherCAT device address is invalid
ECERR_DEVICE_PARAM_NOT_FOUND	1921 (0x781)	Parameter was not found

3.1.9.2.3 EtherCAT Device Parameters

The table below is a list of currently supported parameters read by ECATDevParamRead.

Parameter	ID	Name	R/W	Description									
DEVICE_PARAM_DEVICE_TYPE	1	Device Type	Read Only	<table border="1"> <thead> <tr> <th>Output Value</th> <th>Numerical Value</th> <th>Description</th> </tr> </thead> <tbody> <tr> <td>DEVICE_TYPE_OTHER</td> <td>0</td> <td>The EtherCAT device is not a drive.</td> </tr> <tr> <td>DEVICE_TYPE_DRIVE</td> <td>1</td> <td>The EtherCAT device is a drive.</td> </tr> </tbody> </table>	Output Value	Numerical Value	Description	DEVICE_TYPE_OTHER	0	The EtherCAT device is not a drive.	DEVICE_TYPE_DRIVE	1	The EtherCAT device is a drive.
Output Value	Numerical Value	Description											
DEVICE_TYPE_OTHER	0	The EtherCAT device is not a drive.											
DEVICE_TYPE_DRIVE	1	The EtherCAT device is a drive.											

Parameter	ID	Name	R/W	Description		
DEVICE_PARAM_DRIVE_FAMILY	2	Drive Family	Read Only	EtherCAT device drive family details.		
				Output Value	Numerical Value	Description
				DEVICE_NOT_A_DRIVE	-1	The EtherCAT device is not a drive
				DRIVE_FAMILY_OTHER	0	The drive family cannot be determined
				DRIVE_FAMILY_S300_S700	1	The device is an S300/S700 family drive
				DRIVE_FAMILY_AKD	2	The device is in the AKD2G, AKD-N, or AKD servo drive family
DRIVE_FAMILY_AKT2G_STEPPER	3	The device is an AKT2G Stepper family drive				
DEVICE_PARAM_DRIVE_GEN	3	Drive Generation	Read Only	EtherCAT drive generation details.		
				Output Value	Numerical Value	Description
				DEVICE_NOT_A_DRIVE	-1	The EtherCAT device is not a drive.
				DRIVE_GEN_UNKNOWN	0	The drive generation cannot be determined.
				DRIVE_GEN_1	1	The device is a 1 st generation drive, e.g. AKD, AKD-N, S300, S700, AKT2G-SM-L15, AKT2G-SM-L50.
DRIVE_GEN_2	2	The device is a 2 nd generation drive, e.g. AKD2G.				

3.1.9.3 Example

3.1.9.3.1 Structured Text

```
(* ECATDevReadParam ST example *)
Inst_ECATDevReadParam( TRUE, EtherCAT.AKD_2, DEVICE_PARAM_DEVICE_TYPE );
DeviceType := Inst_ECATDevReadParam.Value;

Inst_ECATDevReadParam( TRUE, EtherCAT.AKD_2, DEVICE_PARAM_DRIVE_FAMILY );
DeviceFamily := Inst_ECATDevReadParam.Value;

Inst_ECATDevReadParam( TRUE, EtherCAT.AKD_2, DEVICE_PARAM_DRIVE_GEN );
DriveGen := Inst_ECATDevReadParam.Value;
```

3.1.9.3.2 Ladder Diagram

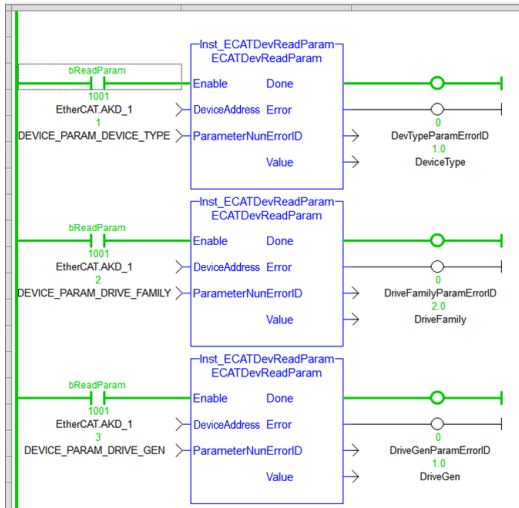

3.1.9.3.3 FBD

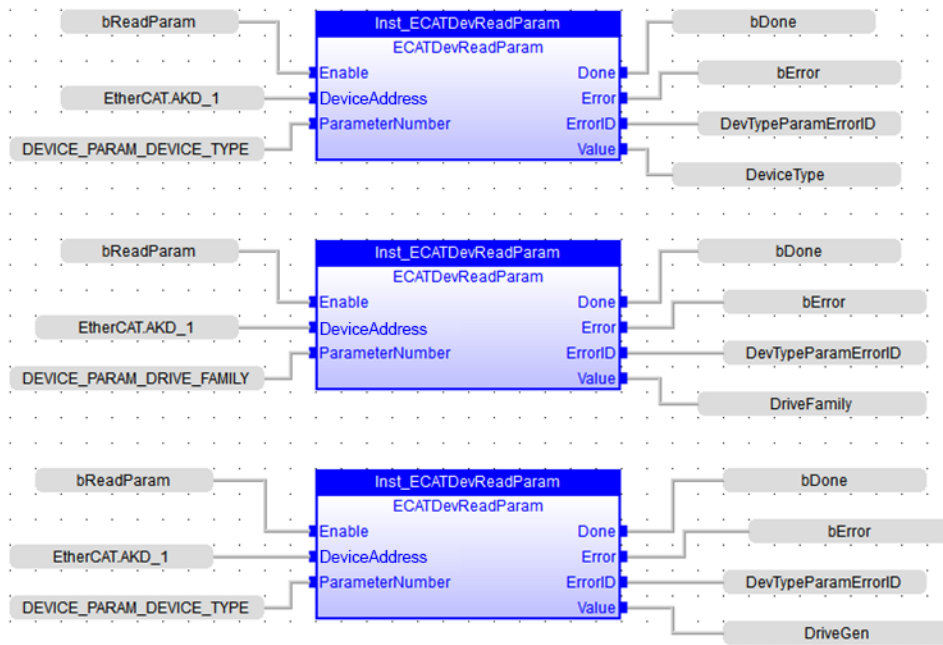

3.1.10 ECATGetObjVal

PLCopen
Pipe Network

NOTE

This function is deprecated as of KAS v2.7. The recommended best practice is to map a PLC variable to a PDO object.

3.1.11 ECATMasterStatus



3.1.11.1 Description

This function block reads the EtherCAT master state and the lost frame counter, to determine if EtherCAT is running normally.

TIP

See the [EtherCAT Communication Diagnosis Steps](#) section of the Troubleshooting chapter for more information.

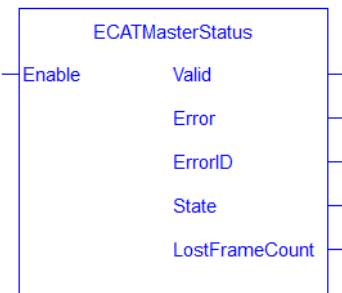

Figure 1-134: ECATMasterStatus function block

3.1.11.2 Arguments

3.1.11.2.1 Input

Enable	Description	Request to read the ECAT master state and the lost frame count. Keeps continuously reads the master state and the lost frame count as long as the Enable remains high.
	Data type	BOOL
	Range	0,1
	Unit	N/A
	Default	—

3.1.11.2.2 Output

Valid	Description	Indicates the values at the 'State' and LostFrameCount outputs are valid.
	Data type	BOOL
	Unit	N/A
Error	Description	Indicates error
	Data type	BOOL
	Unit	N/A

ErrorID	Description	Error code when when the function block failed due to error.
	Data type	DINT
	Unit	N/A
State	Description	Indicates the ECAT state of the Master. See State Defines for details
	Data type	UINT
	Unit	N/A
LostFrameCount	Description	Total cumulative number of cyclic frames sent with no-response since the ECAT started by calling the MLMotionStart. Missing return frames will generate an A38 alarm. The Counter is reset to 0 when the MLMotionStart is called.
	Data type	UDINT
	Unit	N/A

State Defines

```
#define EC_STATE_NO_COMMUNICATION 0 (* 0x00 = No Communication to device *)
#define EC_STATE_INIT 1 (* 0x01 = Device in Init state *)
#define EC_STATE_PREOP 2 (* 0x02 = Device in Pre-operational state *)
#define EC_STATE_BOOTSTRAP 3 (* 0x03 = Device in Bootstrap state *)
#define EC_STATE_SAFEOP 4 (* 0x04 = Device in Safe-Operational state *)
#define EC_STATE_OP 8 (* 0x08 = Device in Operational state *)
```

3.1.11.3 Related Functions

[ECATWCStatus](#), [ECATDeviceStatus](#).

3.1.11.4 Examples

3.1.11.4.1 Structured Text

```
// ECATMasterStatus
Inst_ECATMasterStatus( True );
MasterState := Inst_ECATMasterStatus.State;
MasterLastFrameCount := Inst_ECATMasterStatus.LostFrameCount;
```

3.1.11.4.2 FBD

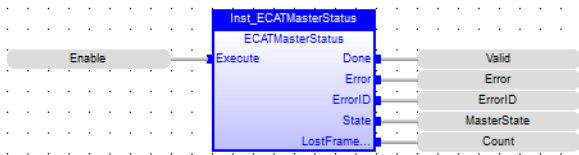

3.1.11.4.3 FFLD

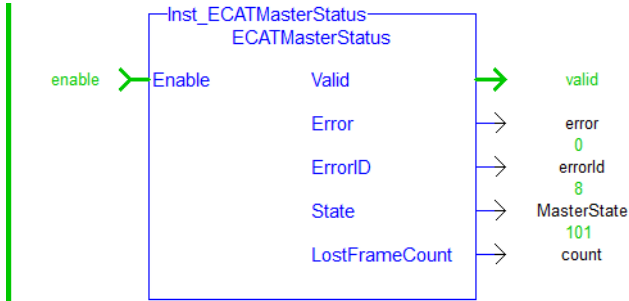

3.1.12 ECATReadData



⚠ IMPORTANT

This is a low level function and it should only be used carefully by **advanced users**.

3.1.12.1 Description

This function allows a direct access to the memory [image](#) of the EtherCAT frame which is sent or received when you need to debug your application. You access the EtherCAT image element by giving the offset in the image and the size of the element.

If you have a device other than the drive, ECATReadData is used for more than just debug. It is used to get the status of the module (e.g. Stepper I/O slice).

3.1.12.2 Arguments

3.1.12.2.1 Input

Offset	Description	Offset in bytes from the beginning of the frame
		⚠ IMPORTANT The Offset value required to access may change when the firmware for any device on the EtherCAT network is updated or whenever the EtherCAT network topology changes. When performing an update of a network device or changing the network topology, one should export the ENI file and check the Offset value needed to access the desired information.
	Data type	UINT
	Range	0- <i>size of frame</i> (maximum size of an Ethernet frame is 1500)
	Unit	bytes
	Default	—
Nbytes	Description	Number of bytes to read

	Data type	SINT
	Range	1, 2 or 4
	Unit	bytes
	Default	—
Direction	Description	Direction of the frame (true = output image, false = input image).
	Data type	BOOL
	Range	0, 1
	Unit	N/A
	Default	—

NOTE

The valid ranges for the **Value** parameter are:

For 1 byte: 0 to 255

For 2 bytes: 0 to 65535

For 4 bytes: - 2147483648 to 2147483648 (The sign bit represents the most significant bit in the data word)

3.1.12.2.2 Output

Value	Description	Value of the EtherCAT frame
	Data type	DINT
	Unit	N/A

3.1.12.3 Related Functions

[ECATGetObjVal](#)

3.1.12.4 Example**3.1.12.4.1 Structured Text**

```
// Read 4 bytes starting at offset 26 of the output image
```

```
Position := ECATReadData(26, 4, true);
```

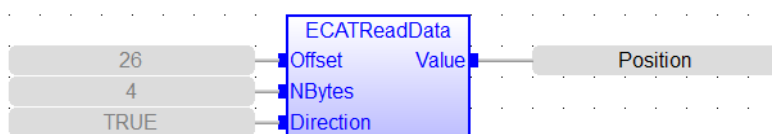
3.1.12.4.2 FBD**3.1.12.4.3 FFLD**

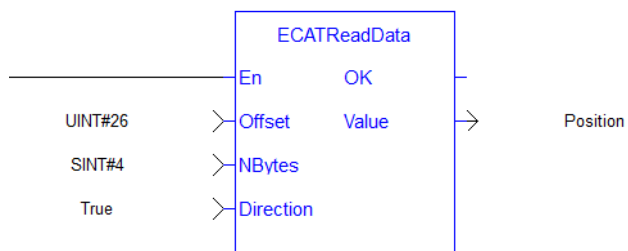

3.1.13 ECATReadSDO

PLCopen ✓

Pipe Network ✓

3.1.13.1 Description

This function block reads a 32-bit word from I/O nodes using a CANopen SDO read command. Is typically used to query the status of inputs.

See [EtherCAT Function Blocks That Work With SDOs](#) for information about function blocks which are used to work with drive or remote I/O parameters that are not supported by ML and MC function blocks.

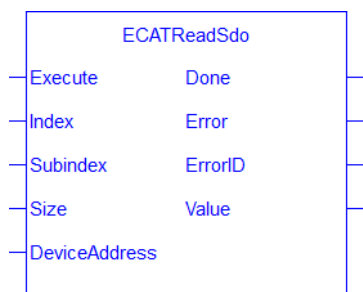

Figure 1-135: ECATReadSdo

3.1.13.1.1 State Diagram

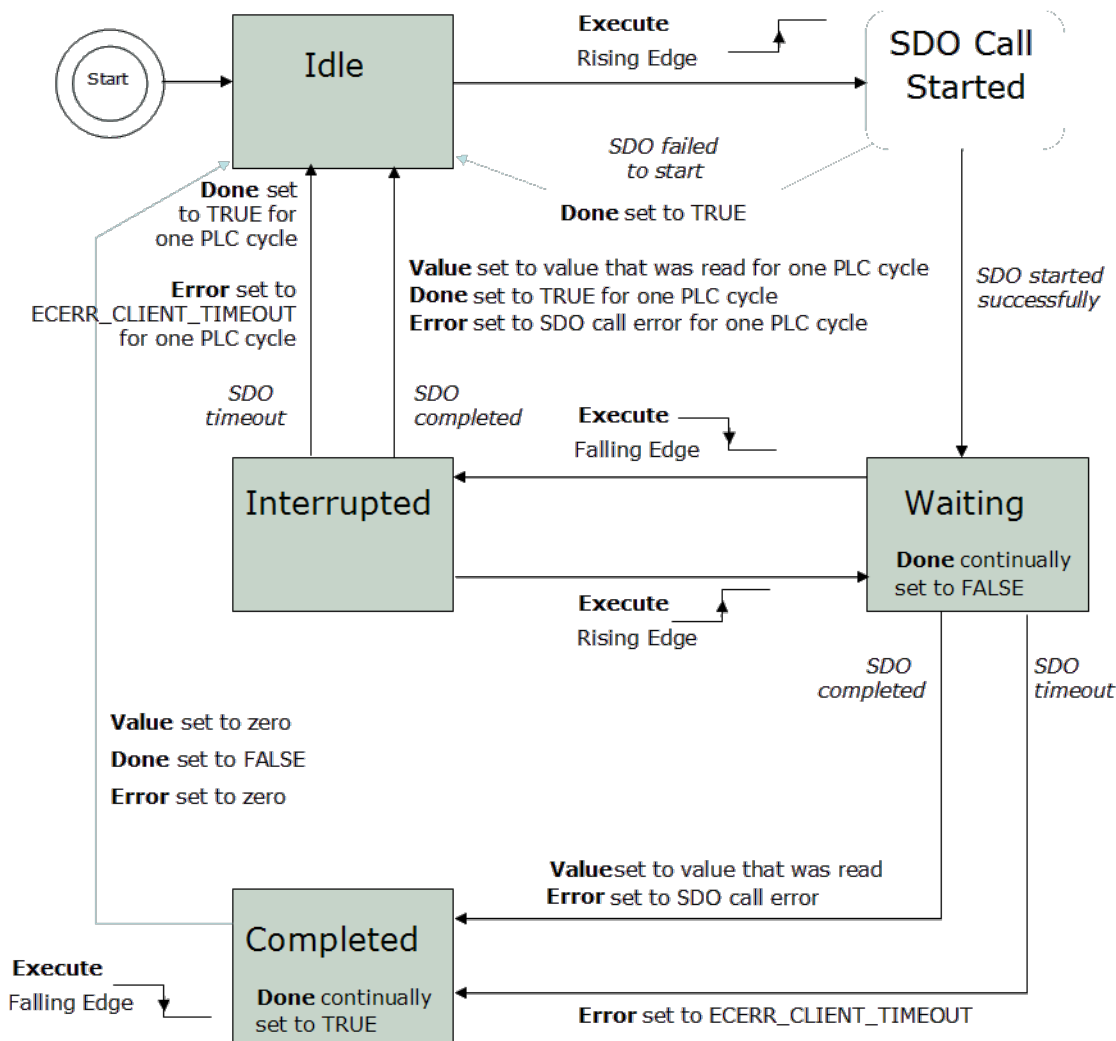

Figure 1-136: ECATReadSdo State Diagram

NOTE

This function block uses *and reserves* the EtherCAT SDO Channel. The SDO Channel will remain reserved until the done output is "true". Therefore, this FB should be called at each cycle until the done output is true. If it is not called at each cycle the rest of SDO communication (the AKD GUI Views, for example) will be blocked.

Using this FB in SFC P0 or P1 steps is not recommended as these steps are executed only once. If this FB is used in P0 or P1 then it must be used in an SFC N step to ensure the FB completes.

3.1.13.2 Arguments

3.1.13.2.1 Input

Execute	Description	On the rising edge of Execute, an SDO read command is issued. The function block only handles one SDO command at a time. If Execute is toggled quickly so that another rising edge occurs before the SDO command has completed, the function block does not issue a second SDO command.
	Data type	BOOL

	Range	0, 1
	Unit	N/A
	Default	—
Index	Description	<p>The object directory index of the data to be read.</p> <p>For more details, refer to:</p> <ul style="list-style-type: none"> • Communication SDOs • Manufacturer specific SDOs • Profile specific SDOs <p>To read/write an SDO object with an index greater than 16#7FFF (32767), the value must be entered in the form <code>any_to_int(index # in hex format)</code>. For example <code>any_to_int(16#8321)</code>.</p>
	Data type	INT
	Range	—
	Unit	N/A
	Default	—
Subindex	Description	<p>The sub-index of the object directory variable to be read.</p> <p>For more details, refer to:</p> <ul style="list-style-type: none"> • Communication SDOs • Manufacturer specific SDOs • Profile specific SDOs <p>To read/write an SDO object with an index greater than 16#7FFF (32767), the value must be entered in the form <code>any_to_int(index # in hex format)</code>. For example <code>any_to_int(16#8321)</code>.</p>
	Data type	SINT
	Range	—
	Unit	N/A
	Default	—
Size	Description	The size (number of bytes) to write.
	Data type	SINT
	Range	1 - 4
	Unit	N/A
	Default	—

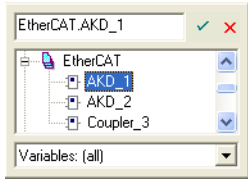
DeviceAddress	Description	<p>The EtherCAT address of the device from which data is written to. The first node usually has the value '1001'. The second node usually has the value '1002'.</p> <p>Alternately, you can use the members of the EtherCAT structure to specify a drive's address when you create the variable.</p>
		
	Data type	INT
	Range	—
	Unit	N/A
	Default	—

3.1.13.2.2 Output

Done	Description	Indicates whether the SDO call has completed without error.
	Data type	BOOL
	Unit	N/A
Error	Description	Indicates whether the SDO call has completed with error:
	Data type	BOOL
	Unit	N/A
ErrorID	Description	The SDO call error result, if Error is TRUE (see list of Error Codes in table below). Upon success, Error is set to zero.
	Data type	DINT
	Unit	N/A
Value	Description	The value of the object directory variable being read. Value is only set when an SDO read command has successfully completed.
	Data type	DINT
	Unit	N/A

Table 1-6: List of EtherCAT Error Codes

3.1.13.3 Related Functions

[ECATWriteSDO](#)

3.1.13.4 Example

3.1.13.4.1 Structured Text

```
(* Read PL.KP on first AKD Drive on EtherCAT network *)
Inst_ECATReadSdo( TRUE, 16#3542, 0, 4, 1001 );
PositionProportionalGain := Inst_ECATReadSdo.Value;
```

```
(* Read the 4 byte data in SDO index 8321h (33569 decimal), sub-index 1
on the first AKD Drive
Inst_ECATReadSdo( TRUE, any_to_int(16#8321), 1, 4, 1001 );
ParamValue := Inst_ECATReadSdo.Value;
```

3.1.13.4.2 FBD

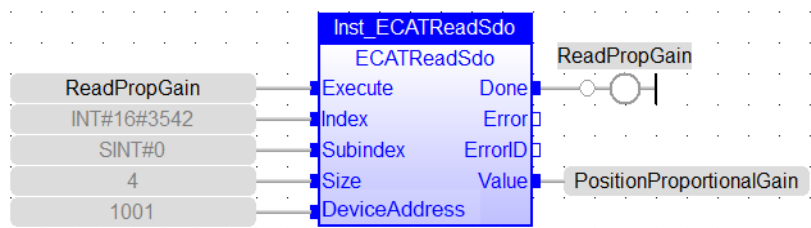

3.1.13.4.3 FFLD

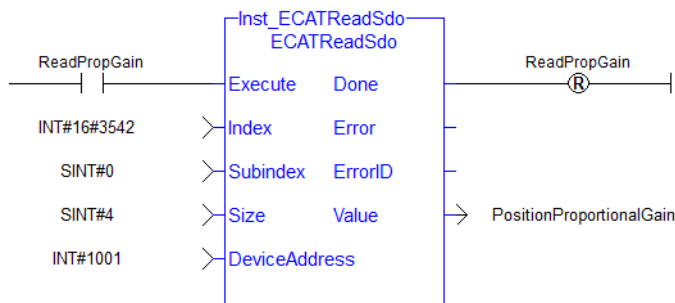

3.1.14 ECATWCStatus

PLCopen Pipe Network

3.1.14.1 Description

This function returns the current number of working counter errors for the Sync unit. The working counter errors are cleared to zero when the EtherCAT network is taken from **Init** to **OP** state.

- Value **0** means no working counter errors.
- When the value is non zero, the master will automatically reduce the count by **1** for every thousand good frames received.
- When the working counter error exceeds the **Working Counter Error Limit**, the EtherCAT network will be stopped.

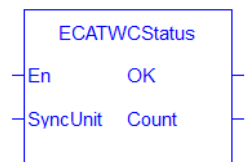

Figure 1-137: ECATWCStatus function

3.1.14.2 Arguments

3.1.14.2.1 Input

SyncUnit	Description	Sync Unit Index (for future compatibility with multiple frames)
	Data type	INT
	Range	0
	Unit	N/A
	Default	-

3.1.14.2.2 Output

Count	Description	Working Counter error
	Data type	UDINT
	Unit	N/A

3.1.14.3 Related Functions

[ECATDeviceStatus](#), [ECATMasterStatus](#)

3.1.14.4 Example



See [Checking for Working Counter Errors](#): in the [EtherCAT Communication Diagnosis Steps](#) section of the Troubleshooting chapter for an example of implementing this function.

3.1.14.4.1 Structured Text

```
(*****  
(* read Ethercat Working counter value *)  
*****)  
wcErrorCounter := ECATWCStatus( 0 );
```

3.1.14.4.2 FBD



3.1.14.4.3 FFLD

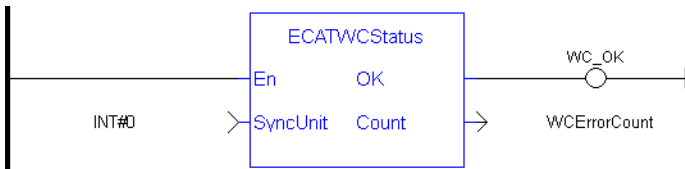

3.1.15 ECATWriteData



This is a low level function and it should only be used carefully by **advanced users**.

3.1.15.1 Description

Modify the EtherCAT process image by directly writing values in it.

If you have a device other than the drive, ECATWriteData is used for more than just debug. It is used to set the status of the module (e.g. Stepper I/O slice) in the case your project is based on an external XML file because it contains unsupported EtherCAT Device.

3.1.15.2 Arguments

3.1.15.2.1 Input

Offset	Description	Offset in bytes from the beginning of the frame
	<div style="border: 1px solid black; padding: 5px; background-color: #f0f0f0;"> <p>ⓘ IMPORTANT</p> <p>The Offset value required to access may change when the firmware for any device on the EtherCAT network is updated or whenever the EtherCAT network topology changes. When performing an update of a network device or changing the network topology, one should export the ENI file and check the Offset value needed to access the desired information.</p> </div>	
	Data type	UINT
	Range	0 - 1500
	Unit	bytes
	Default	—
Nbytes	Description	Number of bytes to write
	Data type	SINT
	Range	1, 2 or 4
	Unit	bytes
	Default	—
Value	Description	Value to be written in the image. Only the number of bytes specified by Nbytes is copied.
	Data type	DINT
	Range	[-2147483648, 2147483648]
	Unit	N/A
	Default	—

NOTE

The valid ranges for the **Value** parameter are:
 For 1 byte: 0 to 255
 For 2 bytes: 0 to 65535
 For 4 bytes: - 2147483648 to 2147483648 (The sign bit represents the most significant bit in the data word)

3.1.15.2.2 Output

Default (.Q)	Description	True if data was written
	Data type	BOOL

Unit	N/A
-------------	-----

3.1.15.3 Related Functions

[ECATReadData](#)

3.1.15.4 Example

3.1.15.4.1 Structured Text

```

//For use with Kollmorgen Thermocouple slice I/O to read in deg C
//Lookup offset by exporting ENI file after EtherCAT network is scanned
//Use offst 124 (byte) to write 0 in control word to allow temperature to
be shown on status byte

ON WriteControlOnly DO
  ECATWriteData( 124, 1, 0 );
END_DO
    
```

3.1.15.4.2 FBD

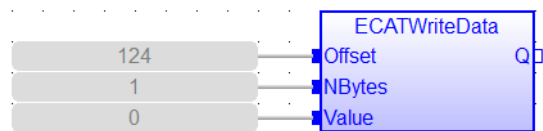

3.1.15.4.3 FFLD

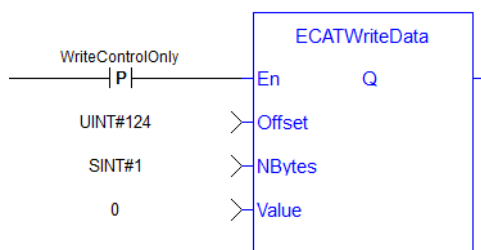

3.1.16 ECATWriteSDO

PLCopen ✓
Pipe Network ✓

3.1.16.1 Description

This function block writes a 32-bit word to I/O nodes using a CANopen SDO write command.

See [EtherCAT Function Blocks That Work With SDOs](#) for information about function blocks which are used to work with drive or remote I/O parameters that are not supported by ML and MC function blocks.

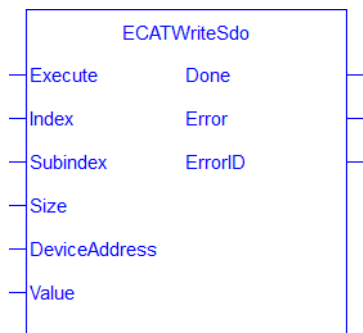

Figure 1-138: ECATWriteSdo

3.1.16.1.1 State Diagram

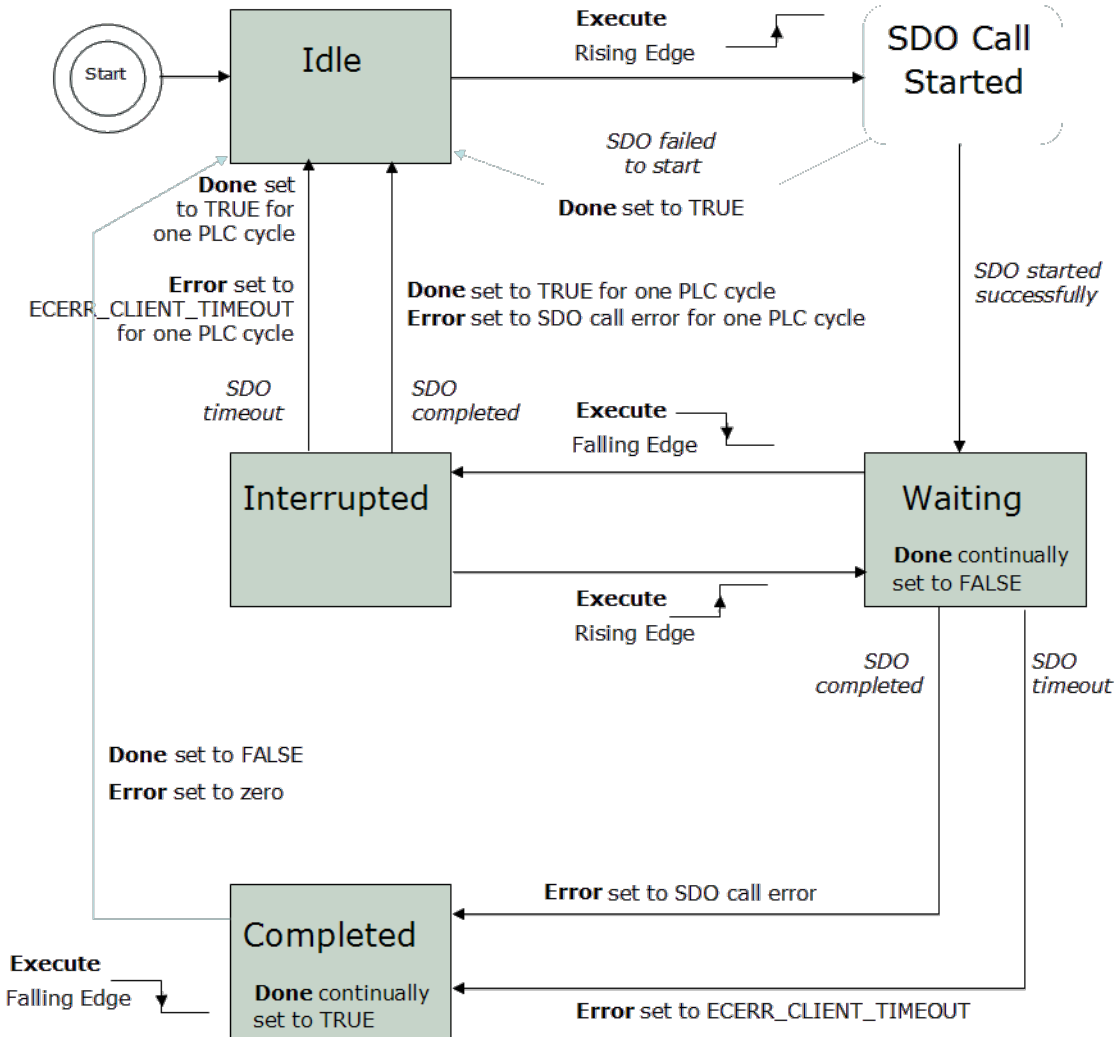

Figure 1-139: ECATWriteSdo State Diagram

NOTE

This function block uses *and reserves* the EtherCAT SDO Channel. The SDO Channel will remain reserved until the done output is "true". Therefore, this FB should be called at each cycle until the done output is true. If it is not called at each cycle the rest of SDO communication (the AKD GUI Views, for example) will be blocked.

Using this FB in SFC P0 or P1 steps is not recommended as these steps are executed only once. If this FB is used in P0 or P1 then it must be used in an SFC N step to ensure the FB completes.

3.1.16.2 Arguments

3.1.16.2.1 Input

Execute	Description	On the rising edge of Execute, an SDO write command will be issued. The function block will only handle one SDO command at a time. If Execute is toggled quickly so that another rising edge occurs before the SDO command has completed, the function block will not issue a second SDO command.
	Data type	BOOL
	Range	0, 1
	Unit	N/A
	Default	—
Index	Description	<p>The object directory index of the data to be written to.</p> <p>For more details, refer to:</p> <ul style="list-style-type: none"> • Communication SDOs • Manufacturer specific SDOs • Profile specific SDOs <p>To read/write an SDO object with an index greater than 16#7FFF (32767), the value must be entered in the form <code>any_to_int(index # in hex format)</code>. For example <code>any_to_int(16#8321)</code>.</p>
	Data type	INT
	Range	—
	Unit	N/A
	Default	—
Subindex	Description	<p>The sub-index of the object directory variable to be written to.</p> <p>For more details, refer to:</p> <ul style="list-style-type: none"> • Communication SDOs • Manufacturer specific SDOs • Profile specific SDOs <p>To read/write an SDO object with an index greater than 16#7FFF (32767), the value must be entered in the form <code>any_to_int(index # in hex format)</code>. For example <code>any_to_int(16#8321)</code>.</p>
	Data type	SINT
	Range	—
	Unit	N/A
	Default	—
Size	Description	The size (number of bytes) to write.
	Data type	SINT
	Range	1 - 4

	Unit	N/A
	Default	—
DeviceAddress	Description	<p>The EtherCAT address of the device from which data will be written to. The first node usually has the value '1001'. The second node usually has the value '1002'.</p> <p>Alternately, you can use the members of the EtherCAT structure to specify a drive's address when you create the variable.</p>
		
	Data type	INT
	Range	—
	Unit	N/A
	Default	—
Value	Description	The value to write to the object directory variable.
	Data type	DINT
	Range	[-2147483648, 2147483648]
	Unit	N/A
	Default	—

3.1.16.2.2 Output

Done	Description	Indicates whether the SDO call has completed without error.
	Data type	BOOL
	Unit	N/A
Error	Description	Indicates whether the SDO call has completed with error:
	Data type	BOOL
	Unit	N/A
ErrorID	Description	The SDO call error result, if Error is TRUE (see). Upon success, Error is set to zero.
	Data type	DINT
	Unit	N/A

Table 1-7: List of EtherCAT Error Codes

3.1.16.3 Related Functions

ECATReadSDO

3.1.16.4 Example

3.1.16.4.1 Structured Text

```
(* Write 58.000 to PL.KP of first AKD Drive on EtherCAT network *)
Inst_ECATWriteSdo( TRUE, 16#3542, 0, 4, 1001, 58000 );
```

```
(* Write a value of 246 to the 4 byte data in SDO index 8321h (33569 decimal), sub-index 1 on the first AKD Drive *)
Inst_ECATWriteSdo( TRUE, any_to_int(16#8321), 1, 4, 1001, 246 );
```

3.1.16.4.2 FBD

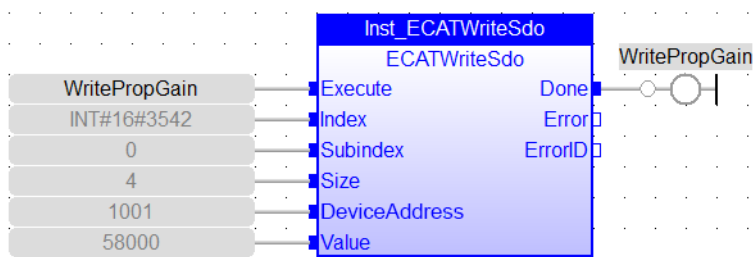

3.1.16.4.3 FFLD

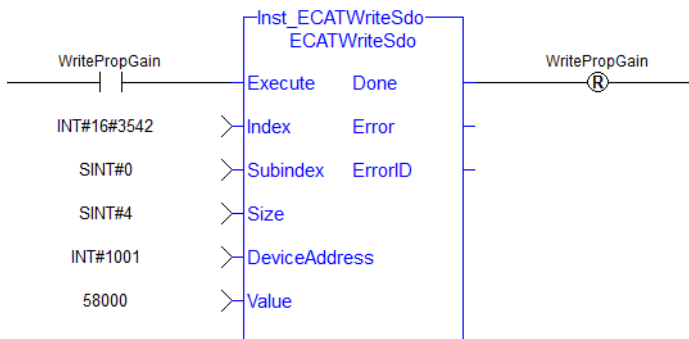

3.1.17 FSoEParamsInit

PLCopen ✓

Pipe Network ✓

3.1.17.1 Description

This function block reads the Safety parameters from the FSoE Master from the input **FSoEMasterAddress** and transfers them to the intended safety slave device using EtherCAT SDO communication.

- The function block checks the FSoE master's register for the safety parameter transfer on the rising edge of the **Execute** input.
- The function block gets the EtherCAT address of the safety slave that will receive the safety parameter if the FSoE master has any safety parameters to transfer.
- Once the address is read and validated from the FSoE master the function block reads the actual parameter from the FSoE master and writes the parameter to the safe Slave.

- The **Done** output is set to "1" when all parameters to all of the intended Safety slaves are written.
- The **Error** output will be set to "1" and the appropriate ErrorID will be set in the **ErrorID** output if any error occurred during this process.

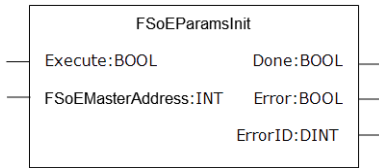

Figure 1-140: FSoEParamsInit Function Block

FSoE masters supported by this function block:

- BBH SCU-1-EC

See Also

- [Set Up a BBH SCU and an AKD2G with SMM](#)
- [AKD2G Safety Parametrization Using FSoE with SCU-1-EC and PCMM/AKD PDMM](#)
- [Troubleshooting FSoE Safety Parameters](#)

3.1.17.2 Arguments

3.1.17.2.1 Inputs

Execute	Description	On the rising edge the function block initiates safety parameter transfer from the FSoE master at address <i>FSoEMasterAddress</i> to its safety slaves.
	Data type	BOOL
	Range	False, True
	Unit	N/A
	Default	—
FSoE Master's EtherCAT device address	Description	The EtherCAT slave address of the FSoE master that will be asked to initialize safety parameters. The first EtherCAT slave usually has the value '1001'. The second slave usually has the value '1002'. Alternately, you can use the members of the EtherCAT structure to specify the EtherCAT address of the safety master.
	Data type	INT
	Range	—
	Unit	N/A
	Default	—

3.1.17.2.2 Outputs

Done	Description	Indicates whether the parameter initialization has completed without error.
	Data type	BOOL
	Unit	N/A
Error	Description	Indicates whether the parameter initialization has completed with an error:
	Data type	BOOL
	Unit	N/A
ErrorID	Description	The parameter initialization error result (see list of Error Codes in table below). Upon success, Error is set to zero.
	Data type	DINT
	Unit	N/A

Error Code	Value dec (hex)	Description
ECERR_OK	0	The SDO call succeeded
ECERR_DEVICE_ERROR	1792 (0x700)	EtherCAT device is not accessible
ECERR_DEVICE_INVALIDCMD	1794 (0x702)	Invalid mailbox command
ECERR_DEVICE_INVALIDINDEX	1795 (0x703)	An invalid value for the Index input was specified
ECERR_DEVICE_INVALIDACCESS	1796 (0x704)	Reading of the variable is not permitted
ECERR_DEVICE_INVALIDSIZE	1797 (0x705)	An invalid size for the parameter was specified
ECERR_DEVICE_INVALIDDATA	1798 (0x706)	Invalid parameter value(s) in SDO index and/or sub-index
ECERR_DEVICE_NOTREADY	1799 (0x707)	Device is not in a ready state, network is not in operational
ECERR_DEVICE_BUSY	1800 (0x708)	Device is not available to respond
ECERR_DEVICE_INVALIDCONTEXT	1801 (0x709)	Device responded with an illegal error code, indicating the command is not allowed under the present conditions
ECERR_DEVICE_NOMEMORY	1802 (0x70A)	EtherCAT mailbox is out of memory or device is out of disk space
ECERR_DEVICE_INVALIDPARM	1803 (0x70B)	EtherCAT mailbox request was not valid
ECERR_DEVICE_NOTFOUND	1804 (0x70C)	EtherCAT device not found
ECERR_DEVICE_SYNTAX	1805 (0x70D)	An unexpected error occurred

Error Code	Value dec (hex)	Description
ECERR_DEVICE_INVALIDSTATE	1810 (0x712)	The EtherCAT device is in an invalid state
ECERR_DEVICE_TIMEOUT	1817 (0x719)	The EtherCAT device failed to respond, timing out
ECERR_DEVICE_INSERTMAILBOX	1826 (0x722)	Error while inserting the mailbox command into internal FIFO
ECERR_DEVICE_INVALIDOFFSET	1827 (0x723)	An invalid value for the SubIndex input was specified
ECERR_DEVICE_UNKNOWNMAILBOXCMD	1828 (0x724)	The master sent an unknown mailbox command to the slave
ECERR_DEVICE_ACCESSDENIED	1829 (0x725)	Device responded with an invalid access error code, indicating the command is not allowed
ECERR_DEVICE_INVALIDADDR	1832 (0x728)	Can't send a mailbox command to the specified slave
ECERR_DEVICE_NOT_A_FSOE_MASTER	1836 (0x72c)	Device is not a FSoE master.
ECERR_DEVICE_PARAM_ACCESS_ERROR	1920 (0x780)	Unknown error occurred while accessing parameter
ECERR_DEVICE_PARAM_NOT_FOUND	1921 (0x781)	Parameter was not found
ECERR_DEVICE_PARAM_NOT_INTEGER	1922 (0x782)	Parameter is a floating-point value. Integer value required.
ECERR_DEVICE_VALUE_IS_NEGATIVE	1923 (0x783)	No negative values allowed. Value specified was negative.
ECERR_DEVICE_VALUE_OUT_OF_RANGE	1924 (0x784)	Value is out of data-range
ECERR_DEVICE_VALUE_GREATER_THAN_MAX	1925 (0x785)	Value bigger than maximum
ECERR_DEVICE_VALUE_LOWER_THAN_MIN	1926 (0x786)	Value lower than minimum
ECERR_CLIENT_ERROR	2048 (0x800)	Error in Mailbox response to a previously sent mailbox command
ECERR_CLIENT_TIMEOUT	2049 (0x801)	The SDO command timed out
ECERR_CLIENT_INVALIDPARM	2050 (0x802)	An invalid value was specified
ECERR_CLIENT_INVALIDSIZE	2051 (0x803)	An invalid value for the size input was specified

Table 1-8: List of EtherCAT Error Codes

3.1.17.3 Examples

3.1.17.3.1 Structured Text

```
Inst_FSoEParamsInit(True, EtherCAT.FSoE_Mst_1);
```

3.1.17.3.2 FBD

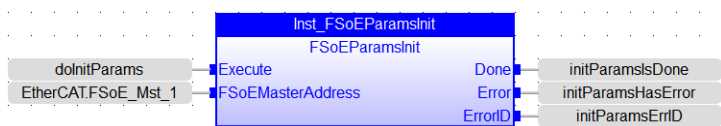

3.1.17.3.3 FFLD

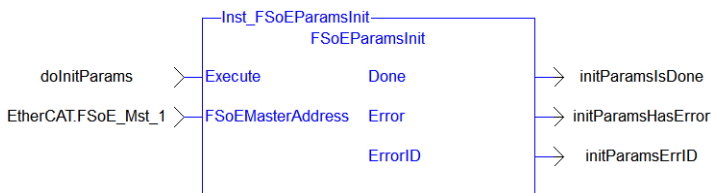

3.2 EtherNet/IP (ODVA)

Explicit messaging may be performed using the following functions.

3.2.1 eipAdapter PLCopen ✔

This function block provides information about the current state of the Scanner connection. This function block is used in a program on the Adapter side.

3.2.1.1 Inputs

Parameter	Type	Description
N/A	N/A	The function block has no Inputs. It automatically refers to the adapter in the project.

3.2.1.2 Outputs

Parameter	Type	Description
Run	BOOL	TRUE, if the EIP stack is running.
IOcnx	BOOL	TRUE, if an I/O connection is established with the Scanner.

3.2.1.3 Remarks

The servers (adapters) accessed by this block must be configured in the "Ethernet/IP Scanner" fieldbus configuration.

Only one explicit message (read or write) can be sent at one time to the same server. If another message is pending then you will get the error report 3 (busy) after calling the block to start a new exchange.

Consider [SerializeIn](#) and [SerializeOut](#) functions for extracting data from the read buffer.

3.2.1.4 Example

```

Inst_eipAdapter(); // read the Ethernet/IP adapter status

EIP_running := Inst_eipAdapter.Run; // is it running?
EIP_connected := Inst_eipAdapter.IOcnx; // and connected?
    
```

3.2.1.5 Related Function Blocks

- [eipReadAttr](#)
- [eipWriteAttr](#)

3.2.2 eipReadAttr

This function block sends an explicit message (UCMM) to an Ethernet/IP adapter, for reading a single CIP attribute.

3.2.2.1 Inputs

Parameter	Type	Description
Snd	BOOL	A rising edge on this input start the exchange. The DONE output will signal the end of exchange.
SrvIP	STRING	IP address of the server (adapter) such as configured in the "Ethernet/IP Scanner" configuration.
Class	UINT	Class identifier of the CIP object.
Inst	UINT	Instance identifier of the CIP object.
Attr	UINT	Identifier of the CIP attribute.
Data	array of UINT	Buffer where to store the received data. If the actual attribute length is greater than the size of this array, value will be truncated when read.

3.2.2.2 Outputs

Parameter	Type	Description
Done	BOOL	This output is TRUE during one cycle when the exchange is finished, whatever the exchange succeeded or failed. Warning, this output can be TRUE just after the call to block when starting a new exchange in case of invalid parameters.
RcvSize	UINT	Actual size of the CIP attribute answered by the server. If this size is greater than the size of the DATA input array, it indicates that the value was truncated.
Err	UINT	Main error report. Can be one of the following values: 0 = no error 1 = invalid input arguments 2 = system is busy (see remarks) 3 = timeout waiting for the answer (the timeout value is 3 seconds) 4 = UCMM error was returned by the server others = internal errors (reserved for technical support)
EmErr	UINT	in case of a UCMM error, this is the CIP general status error code.
EmErrExt	UINT	in case of a UCMM error, this is the CIP extended status error code.

3.2.2.3 Remarks

The servers (adapters) accessed by this block must be configured in the "Ethernet/IP Scanner" fieldbus configuration.

Only one explicit message (read or write) can be sent at one time to the same server. If another message is pending then you will get the error report 3 (busy) after calling the block to start a new exchange.

Consider [SerializeIn](#) and [SerializeOut](#) functions for extracting data from the read buffer.

3.2.2.4 Example

```

// used variables
// Inst_eipReadAttr : eipReadAttr ;
// bRead : BOOL ; (* request for READ *)
// DataRead : ARRAY [0 .. 15] OF USINT ; (* read data *)
// Server identification and CIP things
#define SRVIP '192.168.33.21'
#define CLASSID UINT#100
#define INSTID_READ UINT#1
#define ATTRID UINT#3
////////////////////////////////////
////////////////////////////////////
// requested READ command
if bRead then
  Inst_eipReadAttr (bRead, SRVIP, CLASSID, INSTID_READ, ATTRID,
DataRead);
end_if;
// READ answer here ?
if Inst_eipReadAttr.Done then
  // check answer - if OK answered data is in DataRead array
  if Inst_eipReadAttr.Err = 0 then
    printf ('READ ok - size = %lu bytes',
      any_to_dint (Inst_eipReadAttr.RcvSize));
  else
    printf ('READ Error %lu (UCMM Error %lu, %lu)',
      any_to_dint (Inst_eipReadAttr.Err),
      any_to_dint (Inst_eipReadAttr.EmErr),
      any_to_dint (Inst_eipReadAttr.EmErrExt));
  end_if;
  // reset READ command and block input
  Inst_eipReadAttr (false, SRVIP, CLASSID, INSTID_READ, ATTRID,
DataRead);
  bRead := false;
end_if;

```

3.2.2.5 Related Function Blocks

- [eipAdapter](#)
- [eipWriteAttr](#)

3.2.3 eipWriteAttr

This function block sends an explicit message (UCMM) to an Ethernet/IP adapter, for writing a single CIP attribute.

3.2.3.1 Inputs

Parameter	Type	Description
Snd	BOOL	A rising edge on this input start the exchange. The DONE output will signal the end of exchange.
SrvIP	STRING	IP address of the server (adapter) such as configured in the "Ethernet/IP Scanner" configuration.
Class	UINT	Class identifier of the CIP object.

Parameter	Type	Description
Inst	UINT	Instance identifier of the CIP object.
Attr	UINT	Identifier of the CIP attribute.
Size	UINT	Number of bytes to write. Cannot exceed 450 bytes.
Data	array of UINT	Buffer containing the data to write.

3.2.3.2 Outputs

Parameter	Type	Description
Done	BOOL	This output is TRUE during one cycle when the exchange is finished, whatever the exchange succeeded or failed. Warning, this output can be TRUE just after the call to block when starting a new exchange in case of invalid parameters.
RcvSize	UINT	Actual size of the CIP attribute answered by the server. If this size is greater than the size of the DATA input array, it indicates that the value was truncated.
Err	UINT	Main error report. Can be one of the following values: 0 = no error 1 = invalid input arguments 2 = system is busy (see remarks) 3 = timeout waiting for the answer (the timeout value is 3 seconds) 4 = UCMM error was returned by the server others = internal errors (reserved for technical support)
EmErr	UINT	in case of a UCMM error, this is the CIP general status error code.
EmErrExt	UINT	in case of a UCMM error, this is the CIP extended status error code.

3.2.3.3 Remarks

The servers (adapters) accessed by this block must be configured in the "Ethernet/IP Scanner" fieldbus configuration.

Only one explicit message (read or write) can be sent at one time to the same server. If another message is pending then you will get the error report 3 (busy) after calling the block to start a new exchange.

Consider [SerializeIn](#) and [SerializeOut](#) functions for storing data to the write buffer.

3.2.3.4 Example

```
// used variables
// Inst_eipWriteAttr : eipWriteAttr ;
// bWrite : BOOL ; (* request for WRITE *)
// DataWrite : ARRAY [0 .. 15] OF USINT; (* written data *)
// uiSizeWrite : UINT := UINT#16 ; (* number of bytes to read *)
// Server identification and CIP things
#define SRVIP '192.168.33.21'
#define CLASSID UINT#100
#define INSTID_WRITE UINT#2
#define ATTRID UINT#3
////////////////////////////////////
////////////////////////////////////
// requested WRITE command
if bWrite then
```

```

    Inst_eipWriteAttr (bWrite, SRVIP, CLASSID, INSTID_WRITE, ATTRID,
                      uiSizeWrite, DataWrite);
end_if;
// WRITE answer here ?
if Inst_eipWriteAttr.Done then
    // check answer
    if Inst_eipWriteAttr.Err = 0 then
        printf ('WRITE ok');
    else
        printf ('WRITE Error %lu - (UCMM Error %lu, %lu)',
                any_to_dint (Inst_eipWriteAttr.Err),
                any_to_dint (Inst_eipWriteAttr.EmErr),
                any_to_dint (Inst_eipWriteAttr.EmErrExt));
    end_if;
    // reset WRITE command and block input
    Inst_eipWriteAttr (false, SRVIP, CLASSID, INSTID_WRITE, ATTRID,
                      uiSizeWrite, DataWrite);

    bWrite := false;
end_if;

```

3.2.3.5 Related Function Blocks

- [eipAdapter](#)
- [eipReadAttr](#)

4 System Library

This section details the Library functions and function blocks that relate to the system. This includes:

- [Controller Functions](#)
- [File Tools Function Blocks](#)
- [TCP/IP Function Blocks](#)
- [UDP Functions for PxMM & Simulator](#)

4.1 Controller Functions

Following is the list of Library functions related to the controller.

Name	Description
GetCtrlErrors	Get a list of the active errors and alarms on the controller.
ClearCtrlErrors	Clears the list of active errors and alarms on the controller.
GetCtrlPerf	Generate a text file with performance statistics of the controller.
GetCtrlInfo	Get the serial, model, and/or part number of the controller.

Table 1-9: List of Controller Functions

4.1.1 ClearCtrlErrors



Clears the active errors and alarms on the controller. Only clearable errors will be cleared. See [Errors](#) for a list of errors and alarms that may be generated.

4.1.1.1 Arguments

4.1.1.2 Input

EN	Data Type	Enable the function
----	-----------	---------------------

4.1.1.3 Output

Q	Data Type	BOOL
---	-----------	------

NOTE

If clearable and non-clearable errors are present and this function is called, the Output Q will be turned to true but the non-clearable errors will remain.

4.1.1.4 Examples

4.1.1.4.1 FBD

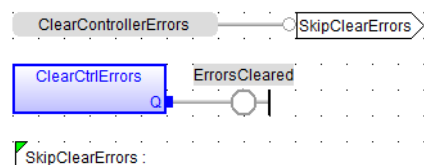

4.1.1.4.2 FFLD

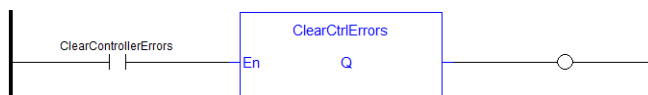

4.1.1.4.3 ST

```
//Attempt to clear active controller level errors and alarms(such as E33)
IF ClearControllerErrors THEN
ClearCtrlErrors();
END_IF;
```

4.1.2 GetCtrlErrors



Returns active errors and alarms on the controller in two arrays of hundred Booleans. Every index in the array corresponds to the error and alarm numbers in the tables. See [Errors](#) for a list of errors and alarms that may be generated.

4.1.2.1 Arguments

4.1.2.1.1 Input

EN	BOOL	Enable
ActiveError	BOOL[100]	Array of bool with the size equal to 100
ActiveAlarm	BOOL[100]	Array of bool with size equal to 100

4.1.2.1.2 Output

OK	BOOL	
Q	DINT	Status of the execution

Status meaning:

Bit 0	Value 0	No error, no alarm, no shut down
Bit 0	Value 1	There is an active error or an active alarm (i.e. there is something in the array ActiveError/ActiveAlarm)
Bit 1	Value 0	No shut down
Bit 1	Value 1	The PLC processes will be shut down. This will start 10 seconds after the error is triggered
Bit 2-15	Value 2 4 9 to 2147483648	reserved

4.1.2.2 Examples

TIP

See [Checking for existing EtherCAT Alarms and Errors](#): in the [EtherCAT Communication Diagnosis Steps](#) section of the Troubleshooting chapter for an example of implementing this function.

4.1.2.2.1 FBD

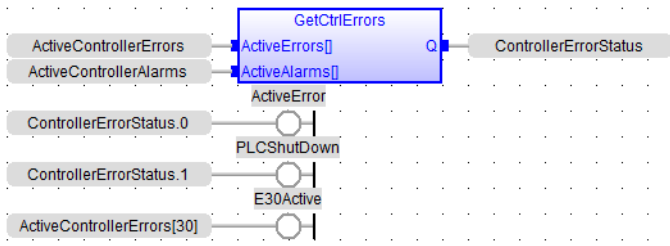

4.1.2.2.2 FFLD

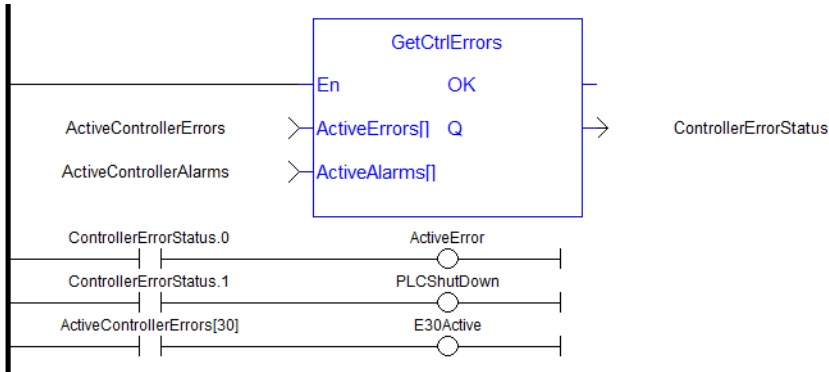

4.1.2.2.3 ST

```
//Retrieve active controller level alarm and errors.
//Check status output to see if any error or alarm is active and if PLC
is shutting down
ControllerErrorStatus:= GetCtrlErrors( ActiveControllerErrors,
ActiveControllerAlarms);
ActiveError:= ControllerErrorStatus.0;
PLCShutDown:= ControllerErrorStatus.1;
E30Active:= ActiveControllerErrors[30];
```

4.1.3 GetCtrlInfo



This function block returns a String containing the value of the control parameter requested.

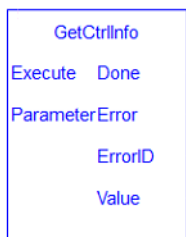

4.1.3.1 Arguments

4.1.3.1.1 Input

Execute	Description	Rising edge of enable initiates read of parameter
	Data Type	BOOL
	Range	0, 1

	Unit	N/A																					
	Default	—																					
Parameter Number	Description	Parameter number to read																					
	Data Type	INT																					
	Range	[1,6]																					
	Unit	N/A																					
	Value Description	These parameters are also Internal Defines , as shown in the table below.																					
		<table border="1"> <thead> <tr> <th>Value</th> <th>Integer Representation</th> <th>Description</th> </tr> </thead> <tbody> <tr> <td>CTRLINFO_SERIAL_NUMBER</td> <td>1</td> <td>Controller serial number</td> </tr> <tr> <td>CTRLINFO_MODEL_NUMBER</td> <td>2</td> <td>Controller model number</td> </tr> <tr> <td>CTRLINFO_PART_NUMBER</td> <td>3</td> <td>Controller part number</td> </tr> <tr> <td>CTRLINFO_CPU_CORE_COUNT</td> <td>4</td> <td>Number of CPU cores in the controller</td> </tr> <tr> <td>CTRLINFO_PROJECT_BUILD_NO</td> <td>5</td> <td>The project build number of the running application</td> </tr> <tr> <td>CTRLINFO_PROJECT_COMPILE_TIME</td> <td>6</td> <td>The project compile time of the running application</td> </tr> </tbody> </table>	Value	Integer Representation	Description	CTRLINFO_SERIAL_NUMBER	1	Controller serial number	CTRLINFO_MODEL_NUMBER	2	Controller model number	CTRLINFO_PART_NUMBER	3	Controller part number	CTRLINFO_CPU_CORE_COUNT	4	Number of CPU cores in the controller	CTRLINFO_PROJECT_BUILD_NO	5	The project build number of the running application	CTRLINFO_PROJECT_COMPILE_TIME	6	The project compile time of the running application
Value	Integer Representation	Description																					
CTRLINFO_SERIAL_NUMBER	1	Controller serial number																					
CTRLINFO_MODEL_NUMBER	2	Controller model number																					
CTRLINFO_PART_NUMBER	3	Controller part number																					
CTRLINFO_CPU_CORE_COUNT	4	Number of CPU cores in the controller																					
CTRLINFO_PROJECT_BUILD_NO	5	The project build number of the running application																					
CTRLINFO_PROJECT_COMPILE_TIME	6	The project compile time of the running application																					

4.1.3.1.2 Output

Done	Description	Indication that read completed without error
	Data Type	BOOL
Error	Description	Indication that read completed with error
	Data Type	BOOL
ErrorID	Description	Error value to indicate error condition

Data Type	INT															
	These parameters are also Internal Defines , as shown in the table below.															
	<table border="1"> <thead> <tr> <th>Value</th> <th>Integer Representation</th> <th>Description</th> </tr> </thead> <tbody> <tr> <td>CTRLINFO_ERROR_NO_ERROR</td> <td>0</td> <td>No error</td> </tr> <tr> <td>CTRLINFO_ERROR_INV_PARAMETER</td> <td>1</td> <td>Invalid parameter</td> </tr> <tr> <td>CTRLINFO_ERROR_CANT_READ_DATA</td> <td>2</td> <td>Error reading data</td> </tr> <tr> <td>CTRLINFO_ERROR_NOT_PDMM</td> <td>3</td> <td>Not valid on a non-AKD PDMM controller</td> </tr> </tbody> </table>	Value	Integer Representation	Description	CTRLINFO_ERROR_NO_ERROR	0	No error	CTRLINFO_ERROR_INV_PARAMETER	1	Invalid parameter	CTRLINFO_ERROR_CANT_READ_DATA	2	Error reading data	CTRLINFO_ERROR_NOT_PDMM	3	Not valid on a non-AKD PDMM controller
Value	Integer Representation	Description														
CTRLINFO_ERROR_NO_ERROR	0	No error														
CTRLINFO_ERROR_INV_PARAMETER	1	Invalid parameter														
CTRLINFO_ERROR_CANT_READ_DATA	2	Error reading data														
CTRLINFO_ERROR_NOT_PDMM	3	Not valid on a non-AKD PDMM controller														
Value	Description String containing data that was read.															
	Data Type STRING															

4.1.3.2 Examples

4.1.3.2.1 Structured Text

```

Inst_GetCtrlInfo( ExecuteRead, CTRLINFO_SERIAL_NUMBER);

if Inst_GetCtrlInfo.Done then
    serialNumber := Inst_GetCtrlInfo.Value;
end_if;
    
```

4.1.3.2.2 Ladder Diagram

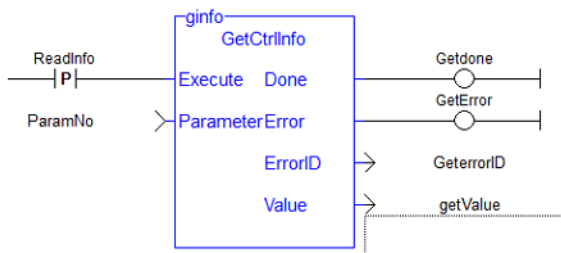

4.1.4 GetCtrlPerf

PLCopen ✓

Pipe Network ✓

4.1.4.1 Description

This function block returns controller CPU performance statistics.

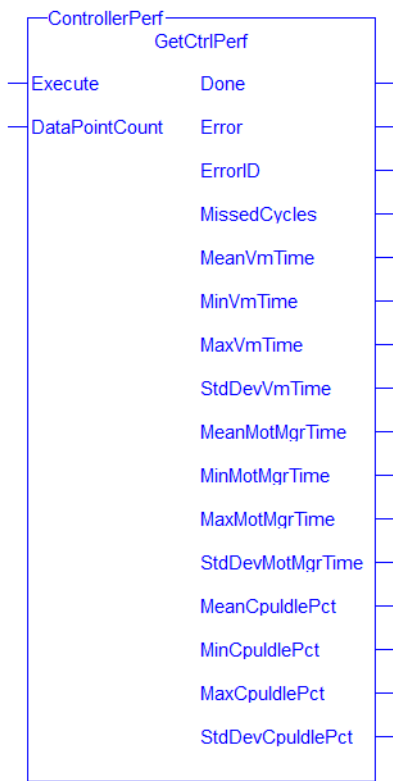

Figure 1-141: GetCtrlPerf

See also:

- [Differences Between Functions and Function Blocks](#)
- [Calling a function block](#)

4.1.4.2 Arguments

4.1.4.2.1 Input

Execute	Description	On the rising edge, request to collect the controller's performance data.
	Data type	BOOL
	Range	0,1
	Unit	N/A
	Default	—
DataPointCount	Description	The number of motion manager cycles over which performance statistics will be gathered.
	Data type	UDINT
	Range	2 - 240,000
	Unit	N/A
	Default	—

4.1.4.2.2 Output

Done	Description	If True, then the command completed successfully.
	Data type	BOOL
Error	Description	If True, an error has occurred.
	Data type	BOOL
ErrorID	Description	Indicates the error if Error output is set to TRUE. ErrorID = 0 indicates no error, ErrorID = 1 indicates an error
	Data type	INT
MissedCycles	Description	Indicates the number of missing VM cycles.
	Data type	UDINT
MeanVmTime	Description	The mean VM execution time measured in microseconds.
	Data type	LREAL
StdDevVmTime	Description	The standard deviation of the VM execution time measured in microseconds.
	Data type	LREAL
MinVmTime	Description	The minimum VM execution time measured in microseconds.
	Data type	LREAL
MaxVmTime	Description	The maximum VM execution time measured in microseconds.
	Data type	LREAL
MeanMotMgrTime	Description	The mean motion manager execution time measured in microseconds.
	Data type	LREAL
StdDevMotMgrTime	Description	The standard deviation of the motion manager execution time measured in microseconds.
	Data type	LREAL
MinMotMgrTime	Description	The minimum motion manager execution time measured in microseconds.
	Data type	LREAL
MaxMotMgrTime	Description	The maximum motion manager execution time measured in microseconds.
	Data type	LREAL

MeanCpuIdlePct	Description	<p>The mean percentage of time the controller CPU is idle. CPU idle period is measured across all CPU cores.</p> <p>TIP</p> <p>See Figure 1-7: Motion, PLC and Real Time Margin Time Calculations and Figure 1-8: Multiple Core Controller, PLC and Real Time Margin Time Calculations. to see the idle period in relationship to a PLC application execution cycle.</p>
	Data type	LREAL
StdDevCpuIdlePct	Description	<p>The standard deviation of the measurements of the time that the controller CPU is idle. CPU idle period is measured across all cpu cores.</p> <p>TIP</p> <p>See Figure 1-7: Motion, PLC and Real Time Margin Time Calculations and Figure 1-8: Multiple Core Controller, PLC and Real Time Margin Time Calculations. to see the idle period in relationship to a PLC application execution cycle.</p>
	Data type	LREAL
MinCpuIdlePct	Description	<p>The minimum measurement of the time that the controller CPU is idle. CPU idle period is measured across all cpu cores.</p> <p>TIP</p> <p>See Figure 1-7: Motion, PLC and Real Time Margin Time Calculations and Figure 1-8: Multiple Core Controller, PLC and Real Time Margin Time Calculations. to see the idle period in relationship to a PLC application execution cycle.</p>
	Data type	LREAL
MaxCpuIdlePct	Description	<p>The maximum measurement of the time that the controller CPU is idle. CPU idle period is measured across all cpu cores.</p> <p>TIP</p> <p>See Figure 1-7: Motion, PLC and Real Time Margin Time Calculations and Figure 1-8: Multiple Core Controller, PLC and Real Time Margin Time Calculations. to see the idle period in relationship to a PLC application execution cycle.</p>
	Data type	LREAL

4.1.4.3 Example

4.1.4.3.1 FBD

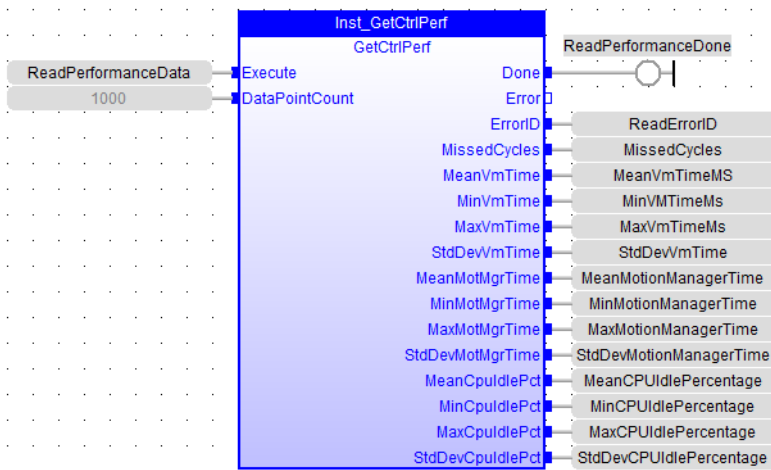

4.1.4.3.2 FFLD

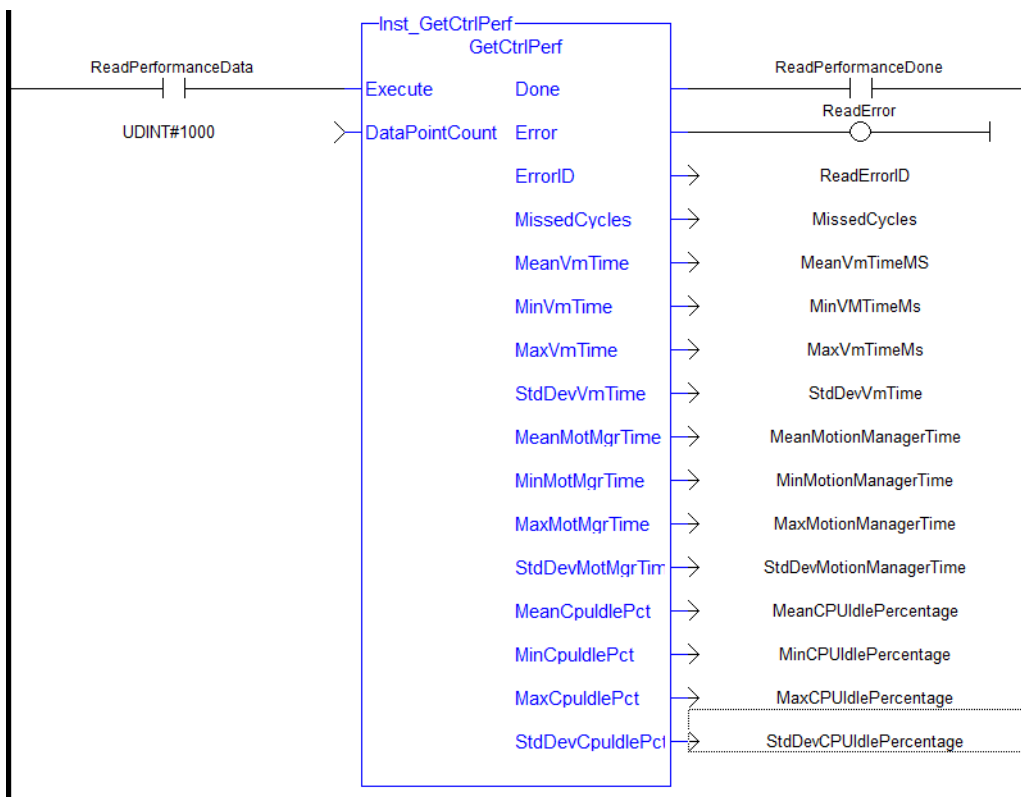

4.1.4.3.3 Structured Text

```
//Read controller performance data from last 1000 cycles (1 second at
T#1ms update rate)
Inst_GetCtrlPerf( ReadPerformanceData, 1000 );

IF Inst_GetCtrlInfo.Done THEN
MissedCycles:= Inst_GetCtrlPerf.MissedCycles;
MaxVmTimeMs:= Inst_GetCtrlPerf.MaxVmTime;
MaxMotionManagerTime:= Inst_GetCtrlPerf.MaxMotMgrTime;
MeanCPUIdlePercentage:= Inst_GetCtrlPerf.MeanCpuIdlePct;
MaxCPUIdlePercentage:= Inst_GetCtrlPerf.MaxCpuIdlePct;
END_IF;
```

4.2 File Tools Function Blocks

This section documents function blocks that can be applied to files.

Function Block	Deprecated Functions	Use
FileClose	F_CLOSE	Close an open file
FileCopy	F_COPY	Copy a file
FileDelete	F_DELETE	Remove a file
FileEOF	F_EOF	Test if the end of the file is reached in a file that is open for reading
FileExists	F_EXIST	Test if a file exists
FileOpenA	F_AOPEN	Create or open a file in append mode
FileOpenR	F_ROPEN	Open a file for reading
FileOpenW	F_WOPEN	Create or reset a file and open it for writing
FileReadBinData	FA_READ FB_READ	Read binary data from a file
FileReadLine	FM_READ	Read a string value from a text file
FileRename	F_RENAME	Rename a file
FileSeek	F_SEEK	Set the current position of a file
FileSize	F_GETSIZE	Get the size of a file
FileWriteBinData	FA_WRITE FB_WRITE	Write binary data to a file
FileWriteLine	FM_WRITE	Write a string value to a text file

4.2.1 FileClose PLCopen

4.2.1.1 Description

This function block closes an open file.

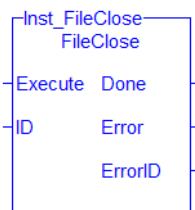

Figure 1-142: The FileCopy Function Block

4.2.1.1.1 Related Functions

[FileEOF](#), [FileOpenA](#), [FileOpenR](#), [FileOpenW](#), [FileReadLine](#), [FileReadBinData](#), [FileSeek](#), [FileWriteBinData](#), [FileWriteLine](#)

See also: [File Management](#)

4.2.1.2 Arguments

4.2.1.2.1 Input

Execute	Description
	On the rising edge request to perform closing a file.
Data Type	BOOL

	Range	0, 1
	Unit	N/A
	Default	—
ID	Description	ID of the open file.
	Data Type	UDINT
	Range	N/A
	Unit	N/A
	Default	—

4.2.1.2.2 Output

Done	Description	If TRUE, then the command completed successfully
	Data Type	BOOL
Error	Description	If TRUE, an error has occurred
	Data Type	BOOL
ErrorID	Description	Indicates the error if Error output is set to TRUE. See the table in File and TCP/IP Function Block ErrorID Output
	Data Type	DINT

4.2.1.3 Example

4.2.1.3.1 Structured Text

```
(* FileClose example *)
CASE StepCounter OF
0:
  Inst_FileClose(TRUE, MyOutputFileID);
  StepCounter := StepCounter + 1;
1:
  Inst_FileClose(TRUE, MyOutputFileID);
  IF Inst_FileClose.Done THEN
    Inst_FileClose(FALSE, 0);
    StepCounter := StepCounter + 1;
  END_IF;
END_CASE;
```

4.2.2 FileCopy

4.2.2.1 Description

This function block copies a file's contents to a new file. Please note that large files will take a noticeable amount of time to complete. For example, a 1000KB file takes approximately 0.6 seconds.

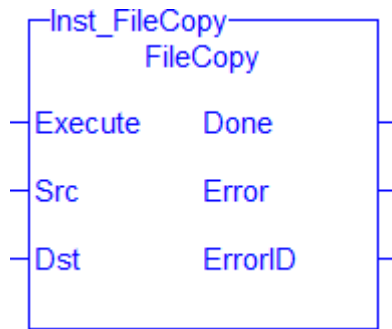

Figure 1-143: The FileCopy Function Block

4.2.2.1.1 Related Functions

[FileDelete](#), [FileRename](#), [FileExists](#), [FileSize](#)

See also: [File Management](#)

4.2.2.2 Arguments

4.2.2.2.1 Input

Execute	Description	On the rising edge request to perform copying a file
	Data Type	BOOL
	Range	0, 1
	Unit	N/A
	Default	—
Src	Description	The path to the source file
	Data Type	STRING
	Range	N/A
	Unit	N/A
	Default	—
Dst	Description	The destination path to the new file
	Data Type	STRING
	Range	N/A
	Unit	user units
	Default	—

4.2.2.2.2 Output

Done	Description	If TRUE, then the command completed successfully
	Data Type	BOOL
Error	Description	If TRUE, an error has occurred
	Data Type	BOOL

ErrorID	Description	Indicates the error if Error output is set to TRUE. See the table in File and TCP/IP Function Block ErrorID Output
	Data Type	DINT

4.2.2.3 Example

4.2.2.3.1 Structured Text

```
(* FileCopy example *)
CASE StepCounter OF
0:
  Inst_FileCopy(TRUE, 'Source.txt', 'Dest.txt');
  StepCounter := StepCounter + 1;
1:
  Inst_FileCopy(TRUE, 'Source.txt', 'Dest.txt');
  IF Inst_FileCopy.Done THEN
    Inst_FileCopy(FALSE, '', '');
    StepCounter := StepCounter + 1;
  END_IF;
END_CASE;
```

4.2.3 FileDelete PLCopen

4.2.3.1 Description

This function block removes a file from the file system.

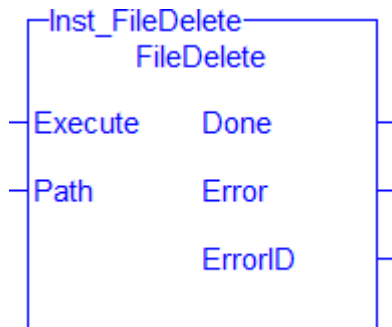

Figure 1-144: The FileDelete Function Block

4.2.3.1.1 Related Functions

[FileCopy](#), [FileRename](#), [FileExists](#), [FileSize](#)

See also: [File Management](#)

4.2.3.2 Arguments

4.2.3.2.1 Input

Execute	Description	On the rising edge request to perform deletion of a file
	Data Type	BOOL
	Range	0, 1
	Unit	N/A

	Default	—
Path	Description	The path to the file to be deleted
	Data Type	STRING
	Range	N/A
	Unit	N/A
	Default	—

4.2.3.2.2 Output

Done	Description	If TRUE, then the command completed successfully
	Data Type	BOOL
Error	Description	If TRUE, an error has occurred
	Data Type	BOOL
ErrorID	Description	Indicates the error if Error output is set to TRUE. See the table in File and TCP/IP Function Block ErrorID Output
	Data Type	DINT

4.2.3.3 Example

4.2.3.3.1 Structured Text

```
(* FileDelete example *)
CASE StepCounter OF
0:
  Inst_FileDelete(TRUE, 'Test.txt');
  StepCounter := StepCounter + 1;
1:
  Inst_FileDelete(TRUE, 'Test.txt');
  IF Inst_FileDelete.Done THEN
    Inst_FileDelete(FALSE, '');
    StepCounter := StepCounter + 1;
  END_IF;
END_CASE;
```

4.2.4 FileEOF PLCopen

4.2.4.1 Description

This function block tests if the end of a file has been encountered.

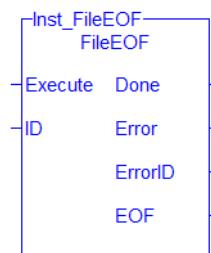

Figure 1-145: The FileCopy Function Block**4.2.4.1.1 Related Functions**

[FileClose](#), [FileOpenA](#), [FileOpenR](#), [FileOpenW](#), [FileReadLine](#), [FileReadBinData](#), [FileSeek](#), [FileWriteBinData](#), [FileWriteLine](#)

See also: [File Management](#)

4.2.4.2 Arguments**4.2.4.2.1 Input**

Execute	Description	On the rising edge test if the end of the file is reached in a file that is open for reading.
	Data Type	BOOL
	Range	0, 1
	Unit	N/A
	Default	—
ID	Description	ID of the open file.
	Data Type	UDINT
	Range	N/A
	Unit	N/A
	Default	—

4.2.4.2.2 Output

Done	Description	If TRUE, then the command completed successfully
	Data Type	BOOL
Error	Description	If TRUE, an error has occurred
	Data Type	BOOL
ErrorID	Description	Indicates the error if Error output is set to TRUE. See the table in File and TCP/IP Function Block ErrorID Output
	Data Type	DINT
EOF	Description	TRUE if the end of the file has been encountered.
	Data Type	BOOL

4.2.4.3 Example**4.2.4.3.1 Structured Text**

```
(* FileEOF example *)
CASE StepCounter OF
0:
  Inst_FileEOF(TRUE, MyInputFileID);
  StepCounter := StepCounter + 1;
1:
```

```

Inst_FileEOF(TRUE, MyInputFileID);
IF Inst_FileEOF.Done THEN
  EofReached := Inst_FileEOF.EOF;
  Inst_FileEOF(FALSE, 0);
  StepCounter := StepCounter + 1;
END_IF;
END_CASE;

```

4.2.5 FileExists

4.2.5.1 Description

This function block tests if a file exists.

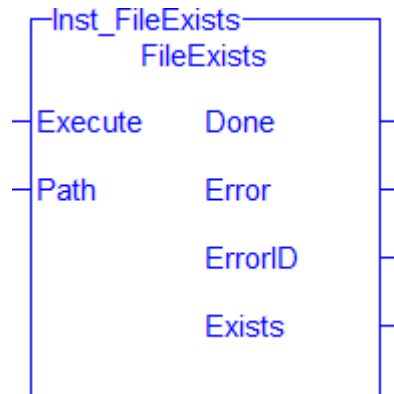

Figure 1-146: The FileExists Function Block

4.2.5.1.1 Related Functions

[FileCopy](#), [FileDelete](#), [FileRename](#), [FileSize](#)

See also: [File Management](#)

4.2.5.2 Arguments

4.2.5.2.1 Input

Execute	Description	On the rising edge test to see if a file exists
	Data Type	BOOL
	Range	0, 1
	Unit	N/A
	Default	—
Path	Description	The path to the file
	Data Type	STRING
	Range	N/A
	Unit	N/A
	Default	—

4.2.5.2.2 Output

Done	Description	If TRUE, then the command completed successfully
	Data Type	BOOL
Error	Description	If TRUE, an error has occurred
	Data Type	BOOL
ErrorID	Description	Indicates the error if Error output is set to TRUE. See the table in File and TCP/IP Function Block ErrorID Output
	Data Type	DINT
Exists	Description	The existence of the file. True: this value indicates the file exists False: this value indicates the file does not exist.
	Data Type	BOOL

4.2.5.3 Example

4.2.5.3.1 Structured Text

```
(* FileExists example *)
CASE StepCounter OF
0:
  Inst_FileExists(TRUE, 'Test.txt');
  StepCounter := StepCounter + 1;
1:
  Inst_FileExists(TRUE, 'Test.txt');
  IF Inst_FileExists.Done THEN
    TestFileExists := Inst_FileExists.Exists;
    Inst_FileExists(FALSE, '');
    StepCounter := StepCounter + 1;
  END_IF;
END_CASE;
```

4.2.6 FileOpenA PLCopen

4.2.6.1 Description

This function block opens a file in "append" mode.
Files must be closed using the [FileClose](#) function block.

NOTE
The controller allows only 32 open files at any given time.

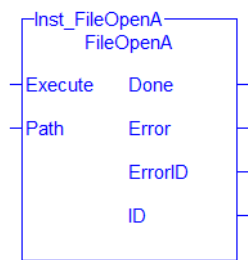

Figure 1-147: The FileOpenA function block

4.2.6.1.1 Related Functions

[FileClose](#), [FileEOF](#), [FileOpenR](#), [FileOpenW](#), [FileReadLine](#), [FileReadBinData](#), [FileSeek](#), [FileWriteBinData](#), [FileWriteLine](#)

4.2.6.2 Arguments

4.2.6.2.1 Input

Execute	Description	On the rising edge request to open a file
	Data Type	BOOL
	Range	0, 1
	Unit	n/a
	Default	—
Path	Description	The path of the file to open or create.
	Data Type	STRING
	Range	n/a
	Unit	n/a
	Default	—

4.2.6.2.2 Output

Done	Description	If TRUE, then the command completed successfully
	Data Type	BOOL
Error	Description	If TRUE, an error has occurred
	Data Type	BOOL
ErrorID	Description	Indicates the error if Error output is set to TRUE. See the table in File and TCP/IP Function Block ErrorID Output
	Data Type	DINT
ID	Description	ID of the open file.
	Data Type	UDINT

4.2.6.3 Example

4.2.6.3.1 Structured Text

```
(* FileOpenW example *)
(* Replace FileOpenW with FileOpenA or FileOpenR as needed*)
CASE StepCounter OF
0:
  Inst_FileOpenW(TRUE, 'Results.txt');
  StepCounter := StepCounter + 1;
1:
  Inst_FileOpenW(TRUE, 'Results.txt');
```

```

IF Inst_FileOpenW.Done THEN
  ResultsFileID := Inst_FileOpenW.ID;
  Inst_FileOpenW(FALSE, '');
  StepCounter := StepCounter + 1;
END_IF;
END_CASE;

```

4.2.7 FileOpenR PLCopen

4.2.7.1 Description

This function block opens a file for reading.
Files must be closed using the [FileClose](#) function block.

NOTE

The controller allows only 32 open files at any given time.

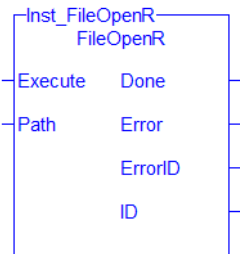

Figure 1-148: The FileOpenR function block

4.2.7.1.1 Related Functions

[FileClose](#), [FileEOF](#), [FileOpenA](#), [FileOpenW](#), [FileReadLine](#), [FileReadBinData](#), [FileSeek](#), [FileWriteBinData](#), [FileWriteLine](#)

4.2.7.2 Arguments

4.2.7.2.1 Input

Execute	Description	On the rising edge request to open a file
	Data Type	BOOL
	Range	0, 1
	Unit	n/a
	Default	—
Path	Description	The path of the file to open or create.
	Data Type	STRING
	Range	n/a
	Unit	n/a
	Default	—

4.2.7.2.2 Output

Done	Description	If TRUE, then the command completed successfully
	Data Type	BOOL
Error	Description	If TRUE, an error has occurred
	Data Type	BOOL
ErrorID	Description	Indicates the error if Error output is set to TRUE. See the table in File and TCP/IP Function Block ErrorID Output
	Data Type	DINT
ID	Description	ID of the open file.
	Data Type	UDINT

4.2.7.3 Example

4.2.7.3.1 Structured Text

```
(* FileOpenW example *)
(* Replace FileOpenW with FileOpenA or FileOpenR as needed*)
CASE StepCounter OF
0:
  Inst_FileOpenW(TRUE, 'Results.txt');
  StepCounter := StepCounter + 1;
1:
  Inst_FileOpenW(TRUE, 'Results.txt');
  IF Inst_FileOpenW.Done THEN
    ResultsFileID := Inst_FileOpenW.ID;
    Inst_FileOpenW(FALSE, '');
    StepCounter := StepCounter + 1;
  END_IF;
END_CASE;
```

4.2.8 FileOpenW

4.2.8.1 Description

This function block opens a file for writing. If a file already exists, it will be overwritten.

Files must be closed using the [FileClose](#) function block.

NOTE

The controller allows only 32 open files at any given time.

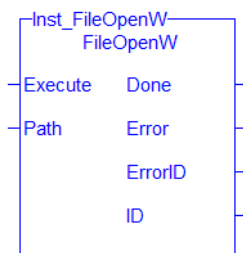

Figure 1-149: The FileOpenW function block

4.2.8.1.1 Related Functions

[FileClose](#), [FileEOF](#), [FileOpenA](#), [FileOpenR](#), [FileReadLine](#), [FileReadBinData](#), [FileSeek](#), [FileWriteBinData](#), [FileWriteLine](#)

4.2.8.2 Arguments

4.2.8.2.1 Input

Execute	Description	On the rising edge request to open a file
	Data Type	BOOL
	Range	0, 1
	Unit	n/a
	Default	—
Path	Description	The path of the file to open or create.
	Data Type	STRING
	Range	n/a
	Unit	n/a
	Default	—

4.2.8.2.2 Output

Done	Description	If TRUE, then the command completed successfully
	Data Type	BOOL
Error	Description	If TRUE, an error has occurred
	Data Type	BOOL
ErrorID	Description	Indicates the error if Error output is set to TRUE. See the table in File and TCP/IP Function Block ErrorID Output
	Data Type	DINT
ID	Description	ID of the open file.
	Data Type	UDINT

4.2.8.3 Example

4.2.8.3.1 Structured Text

```
(* FileOpenW example *)
(* Replace FileOpenW with FileOpenA or FileOpenR as needed*)
CASE StepCounter OF
0:
  Inst_FileOpenW(TRUE, 'Results.txt');
  StepCounter := StepCounter + 1;
1:
  Inst_FileOpenW(TRUE, 'Results.txt');
  IF Inst_FileOpenW.Done THEN
    ResultsFileID := Inst_FileOpenW.ID;
```



```

Inst_FileOpenW(FALSE, '');
StepCounter := StepCounter + 1;
END_IF;
END_CASE;

```

4.2.9 FileReadBinData PLCopen

4.2.9.1 Description

This function block reads binary data from a file. FileReadBinData stops reading from the file if it fills the passed **Frame** array, reads **FrameSize** bytes, or encounters the end of file, whichever comes first.

After a successful call to FileReadBinData, one may use [SerializeIn](#) to extract variable data from the binary data read from a file.

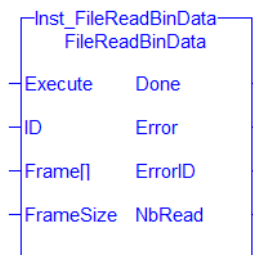

Figure 1-150: The FileReadBinData Function Block

4.2.9.1.1 Related Functions

[FileClose](#), [FileEOF](#), [FileOpenA](#), [FileOpenR](#), [FileOpenW](#), [FileReadLine](#), [FileSeek](#), [FileWriteBinData](#), [FileWriteLine](#), [SerializeIn](#)

See also: [File Management](#)

4.2.9.2 Arguments

4.2.9.2.1 Input

Execute	Description	On the rising edge read the size of a file.
	Data Type	BOOL
	Range	0, 1
	Unit	N/A
	Default	—
ID	Description	ID of the open file.
	Data Type	UDINT
	Range	N/A
	Unit	N/A
	Default	—
Frame	Description	Where the binary data will be stored

	Data Type	USINT[]
	Range	N/A
	Unit	N/A
	Default	—
FrameSize	Description	Number of bytes to store in the <i>Frame</i> array.
	Data Type	DINT
	Range	N/A
	Unit	N/A
	Default	—

4.2.9.2.2 Output

Done	Description	If TRUE, then the command completed successfully
	Data Type	BOOL
Error	Description	If TRUE, an error has occurred
	Data Type	BOOL
ErrorID	Description	Indicates the error if Error output is set to TRUE. See the table in File and TCP/IP Function Block ErrorID Output
	Data Type	DINT
NbRead	Description	The number of bytes read from the file.
	Data Type	STRING

4.2.9.3 Example

4.2.9.3.1 Structured Text

```
(* FileReadBinData example *)
CASE StepCounter OF
0:
  Inst_FileReadBinData(TRUE, MyInputFileID, InputFrame, 128);
  StepCounter := StepCounter + 1;
1:
  Inst_FileReadBinData(TRUE, MyInputFileID, InputFrame, 128);
  IF Inst_FileReadBinData.Done THEN
    BytesRead := Inst_FileReadBinData.NbRead;
    Inst_FileReadBinData(FALSE, 0, InputFrame, 0);
    StepCounter := StepCounter + 1;
  END_IF;
END_CASE;
```

4.2.10 FileReadLine

4.2.10.1 Description

This function block reads a string value from a file. FileReadLine stops reading from the file if 255 characters are read (the maximum length of the STRING type) or if a new line is encountered.

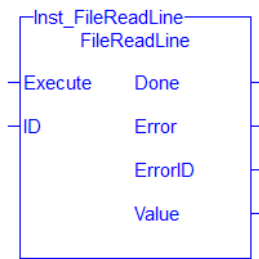

Figure 1-151: The FileReadLine Function Block

4.2.10.1.1 Related Functions

[FileClose](#), [FileEOF](#), [FileOpenA](#), [FileOpenR](#), [FileOpenW](#), [FileReadBinData](#), [FileSeek](#), [FileWriteBinData](#), [FileWriteLine](#)

See also: [File Management](#)

4.2.10.2 Arguments

4.2.10.2.1 Input

Execute	Description	On the rising edge read the size of a file.
	Data Type	BOOL
	Range	0, 1
	Unit	N/A
	Default	—
ID	Description	ID of the open file.
	Data Type	UDINT
	Range	N/A
	Unit	N/A
	Default	—

4.2.10.2.2 Output

Done	Description	If TRUE, then the command completed successfully
	Data Type	BOOL
Error	Description	If TRUE, an error has occurred
	Data Type	BOOL
ErrorID	Description	Indicates the error if Error output is set to TRUE. See the table in File and TCP/IP Function Block ErrorID Output
	Data Type	DINT
Value	Description	The string value read from the file.
	Data Type	STRING

4.2.10.3 Example

4.2.10.3.1 Structured Text

```
(* FileReadLine example *)
CASE StepCounter OF
0:
  Inst_FileReadLine(TRUE, MyInputFileID);
  StepCounter := StepCounter + 1;
1:
  Inst_FileReadLine(TRUE, MyInputFileID);
  IF Inst_FileReadLine.Done THEN
    lineText := Inst_FileReadLine.Value;
    Inst_FileReadLine(FALSE, 0);
    StepCounter := StepCounter + 1;
  END_IF;
END_CASE;
```

4.2.11 FileRename PLCopen

4.2.11.1 Description

This function block renames a file.

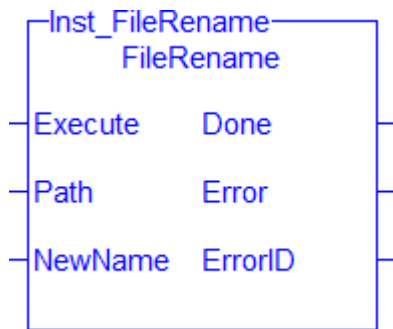

Figure 1-152: The FileRename Function Block

4.2.11.1.1 Related Functions

[FileCopy](#), [FileDelete](#), [FileExists](#), [FileSize](#)

See also: [File Management](#)

4.2.11.2 Arguments

4.2.11.2.1 Input

Execute	Description	On the rising edge request to rename a file
	Data Type	BOOL
	Range	0, 1
	Unit	N/A
	Default	—
Path	Description	The path to the file to be renamed

	Data Type	STRING
	Range	N/A
	Unit	N/A
	Default	—
NewName	Description	The new name of the file
	Data Type	STRING
	Range	N/A
	Unit	user units
	Default	—

4.2.11.2.2 Output

Done	Description	If TRUE, then the command completed successfully
	Data Type	BOOL
Error	Description	If TRUE, an error has occurred
	Data Type	BOOL
ErrorID	Description	Indicates the error if Error output is set to TRUE. See the table in File and TCP/IP Function Block ErrorID Output
	Data Type	DINT

4.2.11.3 Example

4.2.11.3.1 Structured Text

```
(* FileRename example *)
CASE StepCounter OF
0:
  Inst_FileRename(TRUE, 'Original.txt', 'Renamed.txt');
  StepCounter := StepCounter + 1;
1:
  Inst_FileRename(TRUE, 'Original.txt', 'Renamed.txt');
  IF Inst_FileRename.Done THEN
    Inst_FileRename(FALSE, '', '');
    StepCounter := StepCounter + 1;
  END_IF;
END_CASE;
```

4.2.12 FileSeek

4.2.12.1 Description

This function block sets the current position in an open file.

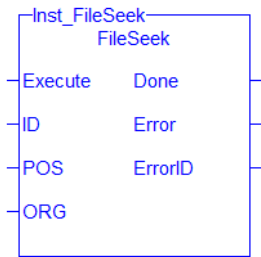

Figure 1-153: The FileCopy Function Block

4.2.12.1.1 Related Functions

[FileClose](#), [FileEOF](#), [FileOpenA](#), [FileOpenR](#), [FileOpenW](#), [FileReadLine](#), [FileReadBinData](#), [FileWriteBinData](#), [FileWriteLine](#)

See also: [File Management](#)

4.2.12.2 Arguments

4.2.12.2.1 Input

Execute	Description	On the rising edge test if the end of the file is reached in a file that is open for reading.
	Data Type	BOOL
	Range	0, 1
	Unit	N/A
	Default	—
ID	Description	ID of the open file.
	Data Type	UDINT
	Range	N/A
	Unit	N/A
	Default	—
POS	Description	Number of bytes to offset from ORG. <ul style="list-style-type: none"> • If ORG = SEEK_SET, then POS should be ≥ 0 • If ORG = SEEK_END, then POS should be ≤ 0 • If ORG = SEEK_CUR, then POS can be positive or negative
	Data Type	DINT
	Range	N/A
	Unit	N/A
	Default	—
ORG	Description	Origin of the move. <ul style="list-style-type: none"> • SEEK_SET = beginning of the file • SEEK_CUR = current position • SEEK_END = end of the file

Data Type	DINT
Range	SEEK_SET, SEEK_CUR, SEEK_END
Unit	N/A
Default	—

4.2.12.2.2 Output

Done	Description	If TRUE, then the command completed successfully
	Data Type	BOOL
Error	Description	If TRUE, an error has occurred
	Data Type	BOOL
ErrorID	Description	Indicates the error if Error output is set to TRUE. See the table in File and TCP/IP Function Block ErrorID Output
	Data Type	DINT

4.2.12.3 Example

4.2.12.3.1 Structured Text

```
(* FileSeek example *)
CASE StepCounter OF
0:
  (* Move to beginning of the file *)
  Inst_FileSeek(TRUE, MyInputFileID, 0, SEEK_SET);
  StepCounter := StepCounter + 1;
1:
  Inst_FileSeek(TRUE, MyInputFileID, 0, SEEK_SET);
  IF Inst_FileSeek.Done THEN
    Inst_FileSeek(FALSE, 0, 0, SEEK_SET);
    StepCounter := StepCounter + 1;
  END_IF;
END_CASE;
```

4.2.13 FileSize

4.2.13.1 Description

This function block renames a file.

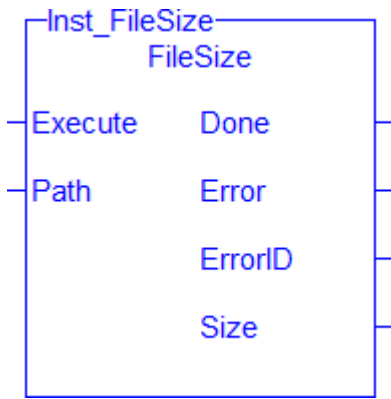

Figure 1-154: The FileSize Function Block

4.2.13.1.1 Related Functions

[FileCopy](#), [FileDelete](#), [FileRename](#), [FileExists](#)

See also: [File Management](#)

4.2.13.2 Arguments

4.2.13.2.1 Input

Execute	Description	On the rising edge read the size of a file
	Data Type	BOOL
	Range	0, 1
	Unit	N/A
	Default	—
Path	Description	The path to the file
	Data Type	STRING
	Range	N/A
	Unit	N/A
	Default	—

4.2.13.2.2 Output

Done	Description	If TRUE, then the command completed successfully
	Data Type	BOOL
Error	Description	If TRUE, an error has occurred
	Data Type	BOOL
ErrorID	Description	Indicates the error if Error output is set to TRUE. See the table in File and TCP/IP Function Block ErrorID Output
	Data Type	DINT
Size	Description	The size of the file in bytes
	Data Type	DINT

4.2.13.3 Example

4.2.13.3.1 Structured Text

```
(* FileSize example *)
CASE StepCounter OF
0:
  Inst_FileSize(TRUE, 'Test.txt');
  StepCounter := StepCounter + 1;
1:
  Inst_FileSize(TRUE, 'Test.txt');
  IF Inst_FileSize.Done THEN
    TestFileSize := Inst_FileSize.Size;
    Inst_FileSize(FALSE, '');
    StepCounter := StepCounter + 1;
  END_IF;
END_CASE;
```

4.2.14 FileWriteBinData PLCopen

4.2.14.1 Description

This function block writes binary data to a file. Before using FileWriteBinData, you may use [SerializeOut](#) to copy variable data to a binary frame.

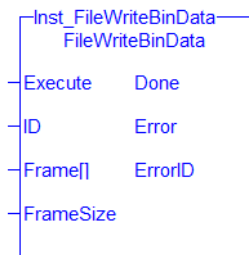

Figure 1-155: The FileWriteLine Function Block

4.2.14.1.1 Related Functions

[FileClose](#), [FileEOF](#), [FileOpenA](#), [FileOpenR](#), [FileOpenW](#), [FileReadBinData](#), [FileReadLine](#), [FileSeek](#), [FileWriteLine](#)

See also: [File Management](#)

4.2.14.2 Arguments

4.2.14.2.1 Input

Execute	Description	On the rising edge write binary data to a file.
	Data Type	BOOL
	Range	0, 1
	Unit	N/A
	Default	—
ID	Description	ID of the open file.

	Data Type	UDINT
	Range	N/A
	Unit	N/A
	Default	—
Frame	Description	The array of binary data to write
	Data Type	USINT[]
	Range	N/A
	Unit	N/A
	Default	—
FrameSize	Description	Number of bytes to write from the <i>Frame</i> array.
	Data Type	DINT
	Range	N/A
	Unit	N/A
	Default	—

4.2.14.2.2 Output

Done	Description	If TRUE, then the command completed successfully
	Data Type	BOOL
Error	Description	If TRUE, an error has occurred
	Data Type	BOOL
ErrorID	Description	Indicates the error if Error output is set to TRUE. See the table in File and TCP/IP Function Block ErrorID Output
	Data Type	DINT

4.2.14.3 Example

4.2.14.3.1 Structured Text

```
(* FileWriteBinData example *)
CASE StepCounter OF
0:
  Inst_FileWriteBinData(TRUE, MyOutputFileID, OutputFrame, 128);
  StepCounter := StepCounter + 1;
1:
  Inst_FileWriteBinData(TRUE, MyOutputFileID, OutputFrame, 128);
  IF Inst_FileWriteBinData.Done THEN
    Inst_FileWriteBinData(FALSE, 0, OutputFrame, 0);
    StepCounter := StepCounter + 1;
  END_IF;
END_CASE;
```

4.2.15 FileWriteLine PLCopen

4.2.15.1 Description

This function block writes a string value to a file. An end-of-line character is systematically written after the string value.

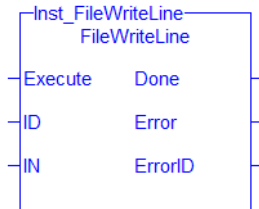

Figure 1-156: The FileWriteLine Function Block

4.2.15.1.1 String Escape Sequences

For greater formatting control over your STRING output, you may escape the STRING by prepending a \$ and use a pre-defined sequence. This is called a string escape sequence.

Escape Sequence	Result
\$\$	\$
\$'	'
\$L	linefeed
\$N	newline
\$P	page (form feed)
\$R	return
\$T	tab
\$xx	hex value

The following is an example of how STRING escape sequences can be used.

```
ID:=FileOpenW('c:\ myfile.txt');
WOK:=FileWriteLine(ID, '123456$N');
//WOK:=FileWriteLine(ID, '$N');
WOK:=FileWriteLine(ID, 'abcd$N');
WOK:=FileWriteLine(ID, 'the end');
WOK:=FileClose(ID);
```

The example outputs a file which reads:

```
123456
abcd
the end
```

4.2.15.1.2 Related Functions

[FileClose](#), [FileEOF](#), [FileOpenA](#), [FileOpenR](#), [FileOpenW](#), [FileReadBinData](#), [FileReadLine](#), [FileSeek](#), [FileWriteBinData](#)

See also: [File Management](#)

4.2.15.2 Arguments

4.2.15.2.1 Input

Execute	Description	On the rising edge write a string value to a file.
	Data Type	BOOL
	Range	0, 1
	Unit	N/A
	Default	—
ID	Description	ID of the open file.
	Data Type	UDINT
	Range	N/A
	Unit	N/A
	Default	—
IN	Description	The string value to be written.
	Data Type	STRING
	Range	N/A
	Unit	N/A
	Default	—

4.2.15.2.2 Output

Done	Description	If TRUE, then the command completed successfully
	Data Type	BOOL
Error	Description	If TRUE, an error has occurred
	Data Type	BOOL
ErrorID	Description	Indicates the error if Error output is set to TRUE. See the table in File and TCP/IP Function Block ErrorID Output
	Data Type	DINT

4.2.15.3 Example

4.2.15.3.1 Structured Text

```
(* FileWriteLine example *)
CASE StepCounter OF
0:
  Inst_FileWriteLine(TRUE, MyOutputFileID, 'Hello, world. ');
  StepCounter := StepCounter + 1;
1:
  Inst_FileWriteLine(TRUE, MyOutputFileID, 'Hello, world. ');
  IF Inst_FileWriteLine.Done THEN
    Inst_FileWriteLine(FALSE, 0, '');
    StepCounter := StepCounter + 1;
  END_IF;
END_CASE;
```

4.3 TCP/IP Function Blocks

This section documents function blocks that are used to communicate via TCP/IP.

Function Block	Description
TcpAccept	Performs the <i>accept</i> operation.
TcpBinReceive	Receives characters over a socket connection.
TcpBinSend	Sends characters over a socket.
TcpClose	Closes and releases a socket.
TcpConnect	Creates a new socket and performs the <i>connect</i> operation.
TcpIsConnected	Tests if a client socket is connected.
TcpIsValid	Tests if a socket is valid.
TcpListen	Creates a new socket by performing the <i>bind</i> and <i>listen</i> operations.
TcpReceive	Receives characters over a socket connection.
TcpSend	Sends characters over a socket.

4.3.1 TcpAccept

4.3.1.1 Description

This function block performs the **accept** operation using default TCP settings. You will have to use the [TcpClose](#) function block to release the socket returned by [TcpAccept](#).

TIP

It is possible that the socket becomes invalid if an error occurs in the TCP connection after this function block is called. You must use the [TcpIsValid](#) function block after [TcpSend](#). If the socket is no longer valid then you must close it by using the [TcpClose](#) function block.

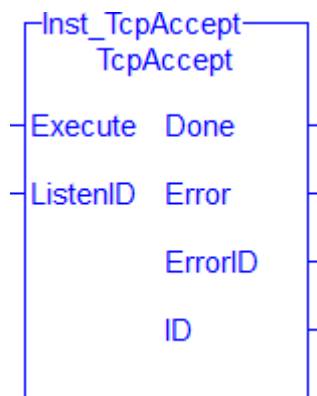

Figure 1-157: The TcpAccept function block

4.3.1.1.1 Related Functions

[TcpBinReceive](#), [TcpBinSend](#), [TcpClose](#), [TcpConnect](#), [TcpIsConnected](#), [TcpIsValid](#), [TcpListen](#), [TcpReceive](#), [TcpSend](#)

4.3.1.2 Arguments

4.3.1.2.1 Input

Execute	Description
	On the rising edge accept a new socket connection
Data Type	BOOL

	Range	0, 1
	Unit	N/A
	Default	—
ListenID	Description	The ID of a server socket returned by the TcpListen function block
	Data Type	UDINT
	Range	N/A
	Unit	N/A
	Default	—

4.3.1.2.2 Output

Done	Description	If TRUE, then the command completed successfully
	Data Type	BOOL
Error	Description	If TRUE, an error has occurred
	Data Type	BOOL
ErrorID	Description	Indicates the error if Error output is set to TRUE. See the table in File and TCP/IP Function Block ErrorID Output
	Data Type	DINT
ID	Description	ID of a new client socket accepted, or invalid ID if no new connection.
	Data Type	UDINT

4.3.1.3 Example

4.3.1.3.1 Structured Text

```
(* TcpAccept example *)
CASE StepCounter OF
0:
  Inst_TcpAccept(TRUE, MyListenID);
  StepCounter := StepCounter + 1;
1:
  Inst_TcpAccept(TRUE, MyListenID);
  IF Inst_TcpAccept.Done THEN
    MySocketID := Inst_TcpAccept.ID;
    Inst_TcpAccept(FALSE, 0);
    StepCounter := StepCounter + 1;
  END_IF;
END_CASE;
```

4.3.2 TcpBinReceive PLCopen

4.3.2.1 Description

This function block receives characters over a socket connection. It is possible that the number of characters actually received is less than the number expected. In that case, you will have to call this function again on the next cycle to receive the pending characters.

TIP

It is possible that the socket becomes invalid if an error occurs in the TCP connection after this function block is called. You must use the [TcpIsValid](#) function block after [TcpSend](#). If the socket is no longer valid then you must close it by using the [TcpClose](#) function block.

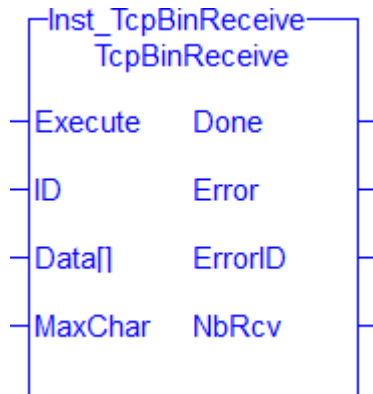

Figure 1-158: The TcpBinReceive function block

4.3.2.1.1 Related Functions

[TcpAccept](#), [TcpBinSend](#), [TcpClose](#), [TcpConnect](#), [TcpIsConnected](#), [TcpIsValid](#), [TcpListen](#), [TcpReceive](#), [TcpSend](#)

4.3.2.2 Arguments

4.3.2.2.1 Input

Execute	Description	On the rising edge request to perform copying a file
	Data Type	BOOL
	Range	0, 1
	Unit	N/A
	Default	—
ID	Description	The ID of the client socket
	Data Type	UDINT
	Range	N/A
	Unit	N/A
	Default	—
Data	Description	The array where the received data will be stored.
	Data Type	USINT[]
	Range	N/A
	Unit	N/A
	Default	—

MaxChar	Description	The maximum number of bytes to receive
	Data Type	DINT
	Range	N/A
	Unit	N/A
	Default	—

4.3.2.2.2 Output

Done	Description	If TRUE, then the command completed successfully
	Data Type	BOOL
Error	Description	If TRUE, an error has occurred
	Data Type	BOOL
ErrorID	Description	Indicates the error if Error output is set to TRUE. See the table in File and TCP/IP Function Block ErrorID Output
	Data Type	DINT
NbRcv	Description	The number of characters actually received
	Data Type	DINT

4.3.2.3 Example

4.3.2.3.1 Structured Text

```
(* TcpBinReceive example *)
CASE StepCounter OF
0:
  Inst_TcpBinReceive(TRUE, MySocketID, MydataArray, 256);
  StepCounter := StepCounter + 1;
1:
  Inst_TcpBinReceive(TRUE, MySocketID, MydataArray, 256);
  IF Inst_TcpBinReceive.Done THEN
    BytesReceived := Inst_TcpBinReceive.NbRcv;
    Inst_TcpBinReceive(FALSE, 0, MydataArray, 0);
    StepCounter := StepCounter + 1;
  END_IF;
END_CASE;
```

4.3.3 TcpBinSend

4.3.3.1 Description

This function block sends characters over a socket. It is possible that the number of characters actually sent is less than the number expected. In that case, you will need to use TcpBinSend again to send the pending characters.

 **TIP**

It is possible that the socket becomes invalid if an error occurs in the TCP connection after this function block is called. You must use the [TcpIsValid](#) function block after [TcpSend](#). If the socket is no longer valid then you must close it by using the [TcpClose](#) function block.

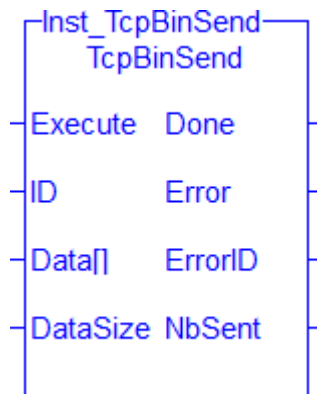

Figure 1-159: The TcpBinSendf function block

4.3.3.1.1 Related Functions

[TcpAccept](#), [TcpBinReceive](#), [TcpClose](#), [TcpConnect](#), [TcpIsConnected](#), [TcpIsValid](#), [TcpListen](#), [TcpReceive](#), [TcpSend](#)

4.3.3.2 Arguments

4.3.3.2.1 Input

Execute	Description	On the rising edge send a string over a socket connection.
	Data Type	BOOL
	Range	0, 1
	Unit	N/A
	Default	—
ID	Description	The ID of the client socket
	Data Type	UDINT
	Range	N/A
	Unit	N/A
	Default	—
Data	Description	The data array to send
	Data Type	USINT[]
	Range	N/A
	Unit	N/A
	Default	—
DataSize	Description	Number of bytes in the Data array to send.
	Data Type	DINT

Range	N/A
Unit	N/A
Default	—

4.3.3.2.2 Output

Done	Description	If TRUE, then the command completed successfully
	Data Type	BOOL
Error	Description	If TRUE, an error has occurred
	Data Type	BOOL
ErrorID	Description	Indicates the error if Error output is set to TRUE. See the table in File and TCP/IP Function Block ErrorID Output
	Data Type	DINT
NbSent	Description	The number of characters actually sent.
	Data Type	DINT

4.3.3.3 Example

4.3.3.3.1 Structured Text

```
(* TcpBinSend example *)
CASE StepCounter OF
0:
  Inst_TcpBinSend(TRUE, MySocketID, MyDataArray, 256);
  StepCounter := StepCounter + 1;
1:
  Inst_TcpBinSend(TRUE, MySocketID, MyDataArray, 256);
  IF Inst_TcpBinSend.Done THEN
    BytesSent := Inst_TcpBinSend.NbSent;
    Inst_TcpBinSend(FALSE, 0, MyDataArray, 0);
    StepCounter := StepCounter + 1;
  END_IF;
END_CASE;
```

4.3.4 TcpClose PLCopen

4.3.4.1 Description

This function block closes and releases a socket. You are responsible for closing any socket created by the [TcpListen](#), [TcpAccept](#), or [TcpConnect](#) function blocks, even if they have become invalid.

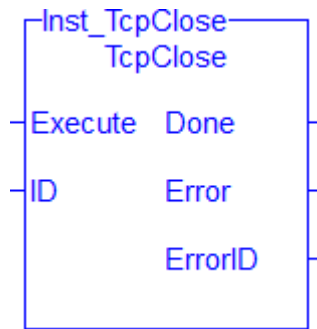

Figure 1-160: The TcpClose function block

4.3.4.1.1 Related Functions

[TcpAccept](#), [TcpBinReceive](#), [TcpBinSend](#), [TcpConnect](#), [TcpIsConnected](#), [TcpIsValid](#), [TcpListen](#), [TcpReceive](#), [TcpSend](#)

4.3.4.2 Arguments

4.3.4.2.1 Input

Execute	Description	On the rising edge close a socket.
	Data Type	BOOL
	Range	0, 1
	Unit	N/A
	Default	—
ID	Description	The ID of the client socket
	Data Type	UDINT
	Range	N/A
	Unit	N/A
	Default	—

4.3.4.2.2 Output

Done	Description	If TRUE, then the command completed successfully
	Data Type	BOOL
Error	Description	If TRUE, an error has occurred
	Data Type	BOOL
ErrorID	Description	Indicates the error if Error output is set to TRUE. See the table in File and TCP/IP Function Block ErrorID Output
	Data Type	DINT

4.3.4.3 Example

4.3.4.3.1 Structured Text

```

(* TcpClose example *)
CASE StepCounter OF
0:
  Inst_TcpClose(TRUE, MySocketID);
  StepCounter := StepCounter + 1;
1:
  Inst_TcpClose(TRUE, MySocketID);
  IF Inst_TcpClose.Done THEN
    Inst_TcpClose(FALSE, 0);
    StepCounter := StepCounter + 1;
  END_IF;
END_CASE;

```

4.3.5 TcpConnect PLCopen

4.3.5.1 Description

This function block creates a new socket and performs the **connect** operation using default TCP settings, and a specified server address and port. You will have use the [TcpClose](#) function block to release the socket returned by TcpConnect.

TIP

It is possible that the function returns a valid socket ID even if the connection to the server is not yet actually performed. After calling this function, you must use the [TcpIsConnected](#) function block to know if the connection is ready.

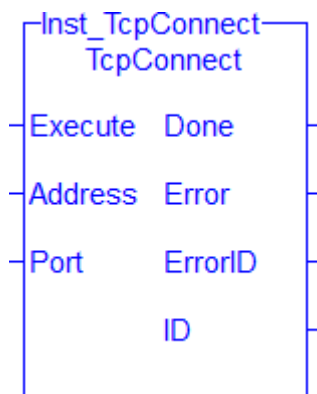

Figure 1-161: The TcpConnect function block

4.3.5.1.1 Related Functions

[TcpAccept](#), [TcpBinReceive](#), [TcpBinSend](#), [TcpClose](#), [TcpIsConnected](#), [TcpIsValid](#), [TcpListen](#), [TcpReceive](#), [TcpSend](#)

4.3.5.2 Arguments

4.3.5.2.1 Input

Execute	Description	On the rising edge request to connect a socket to a server.
	Data Type	BOOL
	Range	0, 1

	Unit	N/A
	Default	—
Address	Description	The IP Address of the remote server.
	Data Type	STRING
	Range	N/A
	Unit	N/A
	Default	—
Port	Description	The network port to use.
	Data Type	DINT
	Range	N/A
	Unit	user units
	Default	—

4.3.5.2.2 Output

Done	Description	If TRUE, then the command completed successfully
	Data Type	BOOL
Error	Description	If TRUE, an error has occurred
	Data Type	BOOL
ErrorID	Description	Indicates the error if Error output is set to TRUE. See the table in File and TCP/IP Function Block ErrorID Output
	Data Type	DINT
ID	Description	ID of the new client socket
	Data Type	UDINT

4.3.5.3 Example

4.3.5.3.1 Structured Text

```
(* TcpConnect example *)
CASE StepCounter OF
0:
  Inst_TcpConnect(TRUE, '192.168.1.1', 1234);
  StepCounter := StepCounter + 1;
1:
  Inst_TcpConnect(TRUE, '192.168.1.1', 1234);
  IF Inst_TcpConnect.Done THEN
    MySocketID := Inst_TcpConnect.ID;
    Inst_TcpConnect(FALSE, '', 0);
    StepCounter := StepCounter + 1;
  END_IF;
END_CASE;
```

4.3.6 TcpIsConnected PLCopen

4.3.6.1 Description

This function block tests if a client socket is connected.

TIP

It is possible that the socket becomes invalid if an error occurs in the TCP connection after this function block is called. You must use the [TcpIsValid](#) function block after [TcpSend](#). If the socket is no longer valid then you must close it by using the [TcpClose](#) function block.

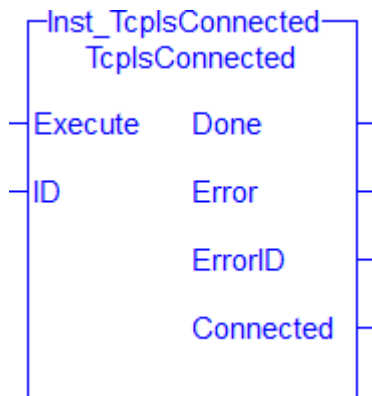

Figure 1-162: The TcpIsConnected function block

4.3.6.1.1 Related Functions

[TcpAccept](#), [TcpBinReceive](#), [TcpBinSend](#), [TcpClose](#), [TcpConnect](#), [TcpIsConnected](#), [TcpIsValid](#), [TcpListen](#), [TcpReceive](#), [TcpSend](#)

4.3.6.2 Arguments

4.3.6.2.1 Input

Execute	Description	On the rising edge test whether a socket is connected.
	Data Type	BOOL
	Range	0, 1
	Unit	N/A
	Default	—
ID	Description	ID of the client socket
	Data Type	UDINT
	Range	N/A
	Unit	N/A
	Default	—

4.3.6.2.2 Output

Done	Description	If TRUE, then the command completed successfully
	Data Type	BOOL

Error	Description	If TRUE, an error has occurred
	Data Type	BOOL
ErrorID	Description	Indicates the error if Error output is set to TRUE. See the table in File and TCP/IP Function Block ErrorID Output
	Data Type	DINT
Connected	Description	TRUE if connection is correctly established.
	Data Type	BOOL

4.3.6.3 Example

4.3.6.3.1 Structured Text

```
(* TcpIsConnected example *)
CASE StepCounter OF
0:
  Inst_TcpIsConnected(TRUE, MySocketID);
  StepCounter := StepCounter + 1;
1:
  Inst_TcpIsConnected(TRUE, MySocketID);
  IF Inst_TcpIsConnected.Done THEN
    MyTcpIsConnected := Inst_TcpIsConnected.Connected;
    Inst_TcpIsConnected(FALSE, 0);
    StepCounter := StepCounter + 1;
  END_IF;
END_CASE;
```

4.3.7 TcplsValid PLCopen

4.3.7.1 Description

This function block tests if a socket is valid.

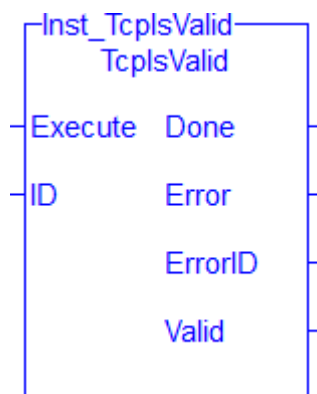

Figure 1-163: The TcplsValid function block

4.3.7.1.1 Related Functions

[TcpAccept](#), [TcpBinReceive](#), [TcpBinSend](#), [TcpClose](#), [TcpConnect](#), [TcpIsConnected](#), [TcpListen](#), [TcpReceive](#), [TcpSend](#)

4.3.7.2 Arguments

4.3.7.2.1 Input

Execute	Description	On the rising edge request to perform copying a file
	Data Type	BOOL
	Range	0, 1
	Unit	N/A
	Default	—
ID	Description	The ID of the client socket.
	Data Type	UDINT
	Range	N/A
	Unit	N/A
	Default	—

4.3.7.2.2 Output

Done	Description	If TRUE, then the command completed successfully
	Data Type	BOOL
Error	Description	If TRUE, an error has occurred
	Data Type	BOOL
ErrorID	Description	Indicates the error if Error output is set to TRUE. See the table in File and TCP/IP Function Block ErrorID Output
	Data Type	DINT
Valid	Description	TRUE if the specified socket is still valid.
	Data Type	BOOL

4.3.7.3 Example

4.3.7.3.1 Structured Text

```
(* TcpIsValid example *)
CASE StepCounter OF
0:
  Inst_TcpIsValid(TRUE, MySocketID);
  StepCounter := StepCounter + 1;
1:
  Inst_TcpIsValid(TRUE, MySocketID);
  IF Inst_TcpIsValid.Done THEN
    MyTcpIsValid := Inst_TcpIsValid.Valid;
    Inst_TcpIsValid(FALSE, 0);
    StepCounter := StepCounter + 1;
  END_IF;
END_CASE;
```

4.3.8 TcpListen

4.3.8.1 Description

This function block creates a new socket by performing the **bind** and **listen** operations using default TCP settings. You will have to use the [TcpClose](#) function block to release the socket returned by TcpListen.

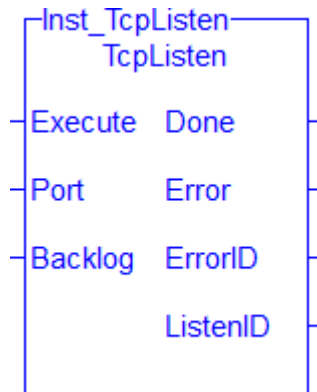

Figure 1-164: The TcpListen function block

4.3.8.1.1 Related Functions

[TcpAccept](#), [TcpBinReceive](#), [TcpBinSend](#), [TcpClose](#), [TcpConnect](#), [TcpIsConnected](#), [TcpIsValid](#), [TcpReceive](#), [TcpSend](#)

4.3.8.2 Arguments

4.3.8.2.1 Input

Execute	Description	On the rising edge listen for socket connections
	Data Type	BOOL
	Range	0, 1
	Unit	N/A
	Default	—
Port	Description	The network port to use
	Data Type	DINT
	Range	N/A
	Unit	N/A
	Default	—
Backlog	Description	The size of the queue for pending connections. If more than Backlog number of connection attempts are made prior to a TcpAccept call, then the controller may refuse the connections.
	Data Type	DINT
	Range	N/A
	Unit	N/A
	Default	—

4.3.8.2.2 Output

Done	Description	If TRUE, then the command completed successfully
	Data Type	BOOL
Error	Description	If TRUE, an error has occurred
	Data Type	BOOL
ErrorID	Description	Indicates the error if Error output is set to TRUE. See the table in File and TCP/IP Function Block ErrorID Output
	Data Type	DINT
ListenID	Description	The ID of the new listen socket
	Data Type	UDINT

4.3.8.3 Example

4.3.8.3.1 Structured Text

```
(* TcpListen example *)
CASE StepCounter OF
0:
  Inst_TcpListen(TRUE, 1234, 2);
  StepCounter := StepCounter + 1;
1:
  Inst_TcpListen(TRUE, 1234, 2);
  IF Inst_TcpListen.Done THEN
    MyListenID := Inst_TcpListen.ListenID;
    Inst_TcpListen(FALSE, 0, 0);
    StepCounter := StepCounter + 1;
  END_IF;
END_CASE;
```

4.3.9 TcpSend

4.3.9.1 Description

This function block sends characters over a socket. It is possible that the number of characters actually sent is less than the number expected. In that case, you will need to use `TcpSend` again to send the pending characters.

TIP

It is possible that the socket becomes invalid if an error occurs in the TCP connection after this function block is called. You must use the `TcpIsValid` function block after `TcpSend`. If the socket is no longer valid then you must close it by using the `TcpClose` function block.

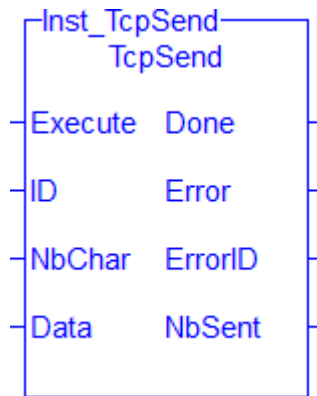

Figure 1-165: The TcpSend function block

4.3.9.1.1 Related Functions

[TcpAccept](#), [TcpBinReceive](#), [TcpBinSend](#), [TcpClose](#), [TcpConnect](#), [TcpIsConnected](#), [TcpIsValid](#), [TcpListen](#), [TcpReceive](#)

4.3.9.2 Arguments

4.3.9.2.1 Input

Execute	Description	On the rising edge send a string over a socket connection.
	Data Type	BOOL
	Range	0, 1
	Unit	N/A
	Default	—
ID	Description	The ID of the client socket.
	Data Type	UDINT
	Range	N/A
	Unit	N/A
	Default	—
NbChar	Description	The number of characters to send.
	Data Type	DINT
	Range	N/A
	Unit	N/A
	Default	—
Data	Description	The IP Address of the remote server.
	Data Type	STRING
	Range	N/A
	Unit	N/A

Default	—
----------------	---

4.3.9.2.2 Output

Done	Description	If TRUE, then the command completed successfully
	Data Type	BOOL
Error	Description	If TRUE, an error has occurred
	Data Type	BOOL
ErrorID	Description	Indicates the error if Error output is set to TRUE. See the table in File and TCP/IP Function Block ErrorID Output
	Data Type	DINT
NbSent	Description	The number of characters actually sent.
	Data Type	DINT

4.3.9.3 Example

4.3.9.3.1 Structured Text

```
(* TcpSend example *)
CASE StepCounter OF
0:
  Inst_TcpSend(TRUE, MySocketID, 5, 'Hello');
  StepCounter := StepCounter + 1;
1:
  Inst_TcpSend(TRUE, MySocketID, 5, 'Hello');
  IF Inst_TcpSend.Done THEN
    BytesSent := Inst_TcpSend.NbSent;
    Inst_TcpSend(FALSE, 0, 0, '');
    StepCounter := StepCounter + 1;
  END_IF;
END_CASE;
```

4.4 UDP Functions for PxMM & Simulator

UDP ([User Datagram Protocol](#)) is a communications protocol which allows computers to exchange messages across an IP network. The UDP functions listed below provide a KAS controller to communicate with a remote PC or another KAS controller over an Ethernet network.

When a UDP packet is sent to a broadcast address such as '255.255.255.255', the AKD PDMM or PCMM automatically converts the given broadcast address to the broadcast address of its Ethernet interface. For example if the controller's IP address is 192.168.1.10 and the subnet mask is 255.255.255.0, then the controller's Ethernet interface broadcast address is 192.168.1.255.

Function	Description
udpAddrMake	Build an address buffer for UDP functions
udpClose	Close a socket
udpCreate	Create a UDP socket
udpIsValid	Test if a socket is valid
udpRcvFrom	Receive a telegram

Function	Description
udpRcvFromArray	Receive a byte array through UDP
udpRcvFromVar	Receives the contents of a variable through UDP
udpSendTo	Send a telegram
udpSendToArray	Send a byte array through UDP
udpSendToVar	Sends the contents of a local variable through UDP

TIP

See Wikipedia for more information on the [UDP protocol](#).

4.4.1 [udpAddrMake](#) PLCopen

4.4.1.1 Description

This function builds an address buffer for UDP functions. This function is required for building an internal "UDP" address to be passed to the [udpSendTo](#) function in case of UDP client processing.

4.4.1.2 Arguments

4.4.1.2.1 Input

En	Description	Execute the function
	Data type	BOOL
	Range	[0,1]
	Unit	N/A
	Default	—
IPaddr	Description	IP address in the form XXX.XXX.XXX.XXX
	Data type	STRING
	Range	[0.0.0.0,255.255.255.255]
	Unit	N/A
	Default	—
port	Description	IP port number
	Data type	DINT
	Range	[0,+65535]
	Unit	N/A
	Default	—
add[]	Description	Buffer where to store the UDP address (filled on output)
	Data type	USINT
	Range	[0,32]
	Unit	N/A

Default —

4.4.1.2.2 Output

OK	Description	Returns true when the function successfully executes. See Function - General rules .
	Data type	BOOL
	Unit	N/A

4.4.1.3 Examples

4.4.1.3.1 Structured Text

```
bAddrMake := udpAddrMake('10.156.238.176', Server_Port, add); //server details
```

4.4.1.3.2 Ladder Diagram

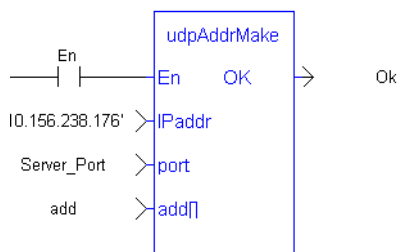

4.4.1.3.3 Function Block Diagram

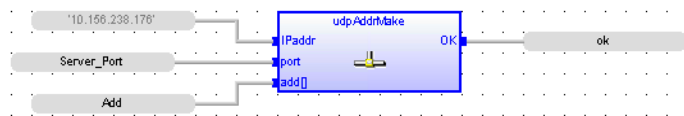

4.4.2 udpClose PLCopen ✔

4.4.2.1 Description

This function closes a socket.

4.4.2.2 Arguments

4.4.2.2.1 Input

En	Description	Execute the function
	Data type	BOOL
	Range	[0,1]
	Unit	N/A
	Default	—
sock	Description	ID of the socket
	Data type	DINT
	Range	[0,+65535]

Unit	N/A
Default	—

4.4.2.2.2 Output

OK	Description	Returns true when the function successfully executes. See Function - General rules .
	Data type	BOOL
	Unit	N/A

4.4.2.3 Examples

4.4.2.3.1 Structured Text

```
udpClose(Socket_Number); //Close socket
```

4.4.2.3.2 Ladder Diagram

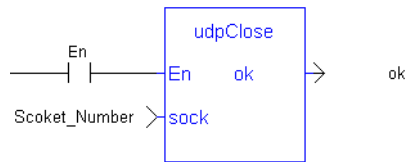

4.4.2.3.3 Function Block Diagram

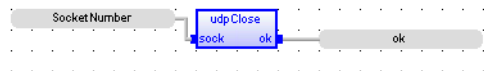

4.4.3 udpCreate PLCopen

4.4.3.1 Description

This function creates a UDP socket.

4.4.3.2 Arguments

4.4.3.2.1 Input

En	Description	Execute the function
	Data type	BOOL
	Range	[0,1]
	Unit	N/A
	Default	—
port	Description	UDP port number to be attached to the server socket or 0 for a client socket.
	Data type	DINT
	Range	[0,+65535]
	Unit	N/A
	Default	—

4.4.3.2.2 Output

OK	Description	Returns true when the function successfully executes. See Function - General rules .
	Data type	BOOL
	Unit	N/A
sock	Description	ID of the new socket

Data type	DINT
Unit	N/A

4.4.3.3 Examples

4.4.3.3.1 Structured Text

```
Socket_Number := udpCreate(Client_Port); //create a socket
```

4.4.3.3.2 Ladder Diagram

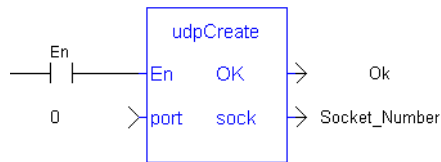

4.4.3.3.3 Function Block Diagram



4.4.4 udplsValid PLCopen ✔

4.4.4.1 Description

This function states whether a socket is valid or not.

4.4.4.2 Arguments

4.4.4.2.1 Input

En	Description	Execute the function
	Data type	BOOL
	Range	[0,1]
	Unit	N/A
	Default	—
sock	Description	ID of the socket
	Data type	DINT
	Range	[0,+65535]
	Unit	N/A
	Default	—

4.4.4.2.2 Output

OK	Description	Returns true when the function successfully executes. See Function - General rules .
	Data type	BOOL
	Unit	N/A

4.4.4.3 Examples

4.4.4.3.1 Structured Text

```
bIsValid := udpIsValid(Socket_Number); //Valid socket?
```

4.4.4.3.2 Ladder Diagram

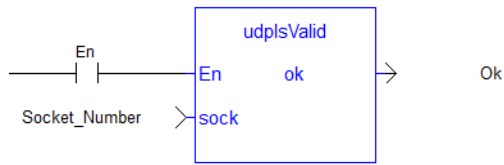

4.4.4.3.3 Function Block Diagram

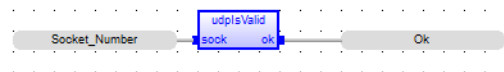

4.4.5 udpRcvFrom PLCopen

4.4.5.1 Description

This function receives a UDP telegram. If the characters are received, the function fills the ADD argument with the internal "UDP" of the sender. This buffer can then be passed to the [udpSendTo](#) function to send the answer.

4.4.5.2 Arguments

4.4.5.2.1 Input

En	Description	Execute the function
	Data type	BOOL
	Range	[0,1]
	Unit	N/A
	Default	—
sock	Description	ID of the socket
	Data type	DINT
	Range	[0,+65535]
	Unit	N/A
	Default	—
nb	Description	Maximum number of characters received
	Data type	DINT
	Range	[0,+65535]
	Unit	N/A
	Default	—

add[]	Description	Buffer containing the UDP address of the transmitter (filled on output)
	Data type	USINT
	Range	[0,32]
	Unit	N/A
	Default	—
data	Description	Buffer where to store received characters
	Data type	STRING
	Range	[0,255]
	Unit	N/A
	Default	—

4.4.5.2.2 Output

OK	Description	Returns true when the function successfully executes. See Function - General rules .
	Data type	BOOL
	Unit	N/A
Q	Description	Actual number of received characters
	Data type	DINT
	Unit	N/A

4.4.5.3 Examples

4.4.5.3.1 Structured Text

```
ReceivedBytes := udpRcvFrom(Socket_Number, 5, add, data); //Read the
position
```

4.4.5.3.2 Ladder Diagram

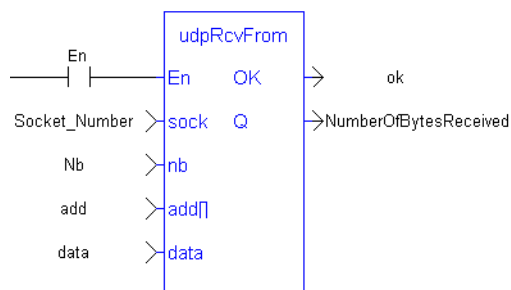

4.4.5.3.3 Function Block Diagram

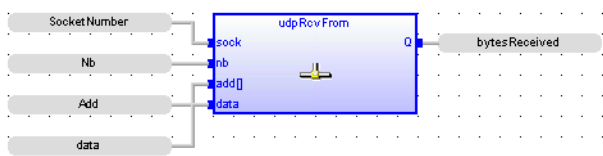

4.4.6 udpRcvFromArray PLCopen

4.4.6.1 Description

This function receives an array of bytes.

4.4.6.2 Arguments

4.4.6.2.1 Input

En	Description	Execute the function
	Data type	BOOL
	Range	[0,1]
	Unit	N/A
	Default	—
sock	Description	Socket number, return value from udpCreate
	Data type	DINT
	Range	[0,+65535]
	Unit	N/A
	Default	—
nb	Description	Number of bytes to be transferred
	Data type	DINT
	Range	[0,+65535]
	Unit	N/A
	Default	—
add[]	Description	Array which contains information about the server
	Data type	USINT
	Range	[0,32]
	Unit	N/A
	Default	—
data[]	Description	Array of bytes to be transferred
	Data type	USINT
	Range	[0,+65535]

Unit	N/A
Default	—

4.4.6.2.2 Output

OK	Description	Returns true when the function successfully executes. See Function - General rules .
	Data type	BOOL
	Unit	N/A
Q	Description	Number of bytes received
	Data type	DINT
	Unit	N/A

4.4.6.3 Examples

4.4.6.3.1 Structured Text

```
BytesReceived := udpRcvFromArray(Socket_Number, nb, add, Frame);
```

4.4.6.3.2 Ladder Diagram

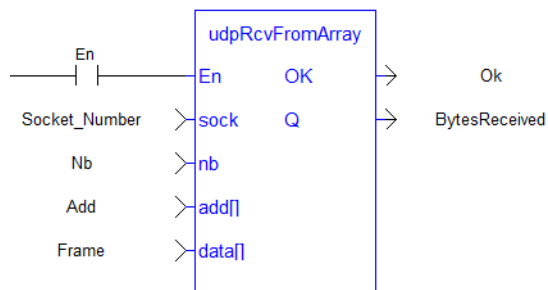

4.4.6.3.3 Function Block Diagram

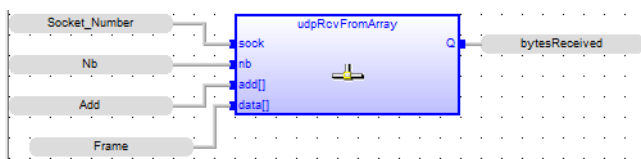

4.4.7 udpRcvFromVar PLCopen

4.4.7.1 Description

This function receives the contents a variable sent from another controller and saves it to a local variable. This allows for the exchange of data across controllers.

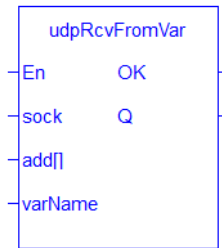

TIP

Limitations:

- Function block instance variable types are not supported.
- The following types of variables cannot be sent or received:
 - Variables defined with a UDFB.
 - The Input and Output variables defined for a sub-program.
- `udpSendToVar` and `udpRcvFromVar` will not automatically swap bytes for big vs. little endian systems.
- Send / receive between a Simulator and PDMM/PCMM is not supported.
- 3rd party stand-alone programs on x86 platforms are responsible for endian conversions for UDP telegrams from a PDMM/PCMM.

4.4.7.2 Arguments

4.4.7.2.1 Input

En	Description	Execute the function
	Data type	BOOL
	Range	[0,1]
	Unit	N/A
	Default	—
sock	Description	Socket number, return value from udpCreate
	Data type	DINT
	Range	[0,+65535]
	Unit	N/A
	Default	—
add[]	Description	Array which contains information about the sender (server) of information. This includes the sender's IP address.
	Data type	USINT
	Range	[0,32]
	Unit	N/A
	Default	—

varName	Description	The name of a PxMM variable (or array or structure) that will store data from the sender. The variable should be the same type as what is being sent. See udpSendToVar .
	Data type	STRING
	Range	
	Unit	N/A
	Default	—

4.4.7.2.2 Output

OK	Description	Returns true when the function successfully executes. See Function - General rules .
	Data type	BOOL
	Unit	N/A
Q	Description	Number of bytes received
	Data type	DINT
	Unit	N/A

4.4.7.3 Examples

4.4.7.3.1 Structured Text

```
udpRcvFromVar( Socket_Number, Add, MyUDPVar )
```

4.4.7.3.2 Ladder Diagram

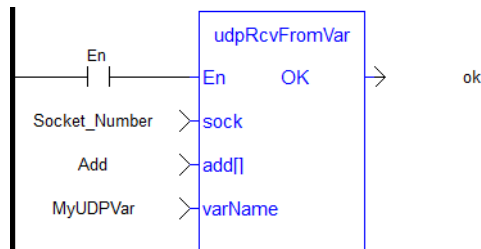

4.4.7.3.3 Function Block Diagram

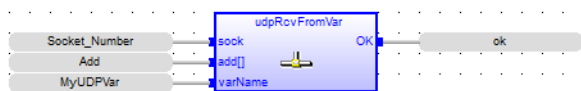

4.4.8 udpSendTo PLCopen ✔

4.4.8.1 Description

This function sends UDP data to a server.

4.4.8.2 Arguments

4.4.8.2.1 Input

En	Description	Execute the function
	Data type	BOOL
	Range	[0,1]
	Unit	N/A
	Default	—
sock	Description	ID of the client socket
	Data type	DINT
	Range	[0,+65535]
	Unit	N/A
	Default	—
nb	Description	Number of bytes of data to send
	Data type	DINT
	Range	[0,65535]
	Unit	N/A
	Default	—
add[]	Description	Buffer containing the UDP address
	Data type	USINT
	Range	[0,32]
	Unit	N/A
	Default	—
data	Description	The characters to send
	Data type	STRING
	Range	[0,255]
	Unit	N/A
	Default	—

4.4.8.2.2 Output

OK	Description	Returns true when the function successfully executes. See Function - General rules .
	Data type	BOOL
	Unit	N/A

4.4.8.3 Examples

4.4.8.3.1 Structured Text

```
bUdpSendTo := udpSendTo(Socket_Number, 5, add, '1000');
```

4.4.8.3.2 Ladder Diagram

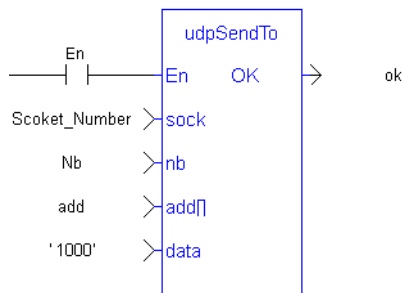

4.4.8.3.3 Function Block Diagram

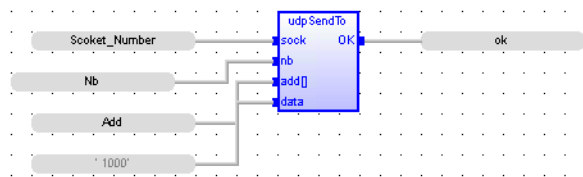

4.4.9 udpSendToArray PLCopen

4.4.9.1 Description

This function sends an array of bytes.

4.4.9.2 Arguments

4.4.9.2.1 Input

En	Description	Execute the function
	Data type	BOOL
	Range	[0,1]
	Unit	N/A
	Default	—
sock	Description	Socket number, return value from udpCreate
	Data type	DINT
	Range	[0,+65535]
	Unit	N/A
	Default	—
nb	Description	Number of bytes to be transferred
	Data type	DINT
	Range	[0,+65535]
	Unit	N/A

	Default	—
add[]	Description	Array which contains information about the server
	Data type	USINT
	Range	[0,32]
	Unit	N/A
	Default	—
data[]	Description	Array of bytes to be transferred
	Data type	USINT
	Range	[0,+65535]
	Unit	N/A
	Default	—

4.4.9.2.2 Output

OK	Description	Returns true when the function successfully executes. See Function - General rules .
	Data type	BOOL
	Unit	N/A

4.4.9.3 Examples

4.4.9.3.1 Structured Text

```
Success := udpSendToArray(Socket_Number, nb, add, Frame);
```

4.4.9.3.2 Ladder Diagram

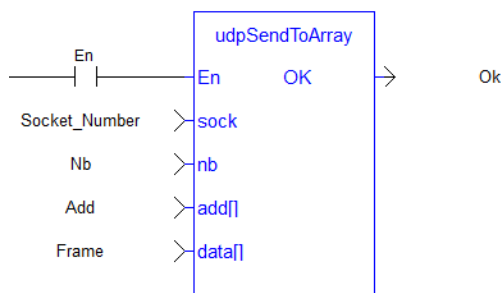

4.4.9.3.3 Function Block Diagram

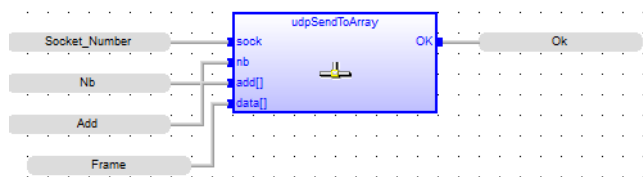

4.4.10 udpSendToVar PLCopen ✔

4.4.10.1 Description

This function sends the contents of a local variable to another controller. This allows for the exchange of data across controllers.



TIP

Limitations:

- Function block instance variable types are not supported.
- The following types of variables cannot be sent or received:
 - Variables defined with a UDFB.
 - The Input and Output variables defined for a sub-program.
- `udpSendToVar` and `udpRcvFromVar` will not automatically swap bytes for big vs. little endian systems.
- Send / receive between a Simulator and PDMM/PCMM is not supported.
- 3rd party stand-alone programs on x86 platforms are responsible for endian conversions for UDP telegrams from a PDMM/PCMM.

4.4.10.2 Arguments

4.4.10.2.1 Input

En	Description	Execute the function
	Data type	BOOL
	Range	[0,1]
	Unit	N/A
	Default	—
sock	Description	Socket number, return value from <code>udpCreate</code>
	Data type	DINT
	Range	[0,+65535]
	Unit	N/A
	Default	—
add[]	Description	Array which contains information about the sender (server) of information. This includes the sender's IP address.
	Data type	USINT
	Range	[0,32]
	Unit	N/A

	Default	—
varName	Description	The name of a variable (or array or structure) to send to the receiver. The variable should be the same type as what is expected by the receiver. See udpRcvFromVar .
	Data type	
	Range	
	Unit	N/A
	Default	—

4.4.10.2.2 Output

OK	Description	Returns true when the function successfully executes. See Function - General rules .
	Data type	BOOL
	Unit	N/A

4.4.10.3 Examples

4.4.10.3.1 Structured Text

```
udpSendToVar ( Socket_Number, Add, MyUDPVar )
```

4.4.10.3.2 Ladder Diagram

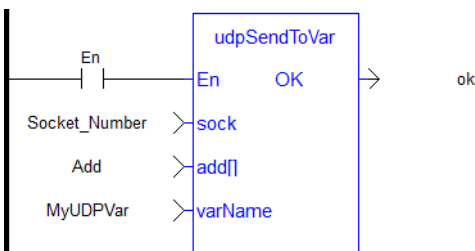

4.4.10.3.3 Function Block Diagram

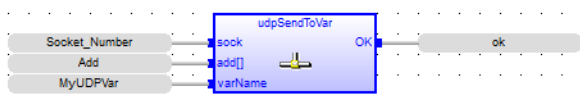

4.5 PrintMessage PLCopen ✓ Pipe Network ✓

4.5.1 Description

The PrintMessage block is used to generate a log message with any wanted strings in the [Log Messages](#) window.

4.5.1.1 About the Source

PrintMessage uses the SYSTEM message type. So, to display all messages generated by PrintMessage, go to the log configuration and select the specified level for the SYSTEM source.

4.5.1.2 About the Level

The message could be sent with a logging level from 0 to 4 that qualifies its importance. The highest level, 4, logs critical messages (available levels are: debug, informational, warning, error and Critical).

Keep in mind that only Error and Critical messages are generated by default. If you want to force the system to generate every message level, go into the log configuration and change the settings to the desired level.

ⓘ IMPORTANT

Enabling all messages can slow down the application's execution. To avoid locking up communications between the IDE and Runtime, you must never include a print statement in your program that prints to the log every update cycle.

See at the configuration settings for more details.

4.5.2 Arguments

4.5.2.1 Input

Level	Description	Level of the logged message. In other words, its importance. Keep in mind that not all messages are displayed in the log windows by default. Only Error and Critical messages are displayed by default. Change the log settings to display a lower level. PrintMessage logs SYSTEM messages.
	Data type	DINT
	Range	[0 , 4] Defines are: LEVEL_DEBUG, LEVEL_INFO, LEVEL_WARNING, LEVEL_ERROR, LEVEL_CRITICAL
	Unit	N/A
	Default	—
Message	Description	Content of the message. A string of 255 characters maximum.
	Data type	String
	Range	1 to 255 characters
	Unit	N/A
	Default	—

4.5.2.2 Output

Default (.Q)	Description	Returns true when function successfully executes
	Data type	BOOL
	Unit	N/A

4.5.3 Usage

```
PrintMessage( LEVEL_DEBUG, 'Message string to be logged' );
```

4.5.4 Example

4.5.4.1 Structured Text

```
// It's possible to create a temporary variable with the
message.

MESSAGE := CONCAT( 'MachineState=', ANY_TO_STRING(MachineState), '.
MachineSpeed=', ANY_TO_STRING(MachineSpeed) );

// Then print the message to the log window
PrintMessage( LEVEL_INFO, MESSAGE );
PrintMessage( LEVEL_WARNING, MESSAGE );
PrintMessage( LEVEL_ERROR, MESSAGE );

// Or to create the string directly in the function call:
PrintMessage( LEVEL_CRITICAL, CONCAT( 'MachineState=', ANY_TO_STRING
(MachineState), '. MachineSpeed=', ANY_TO_STRING(MachineSpeed) ) );
```

4.5.4.2 Function Block Diagram

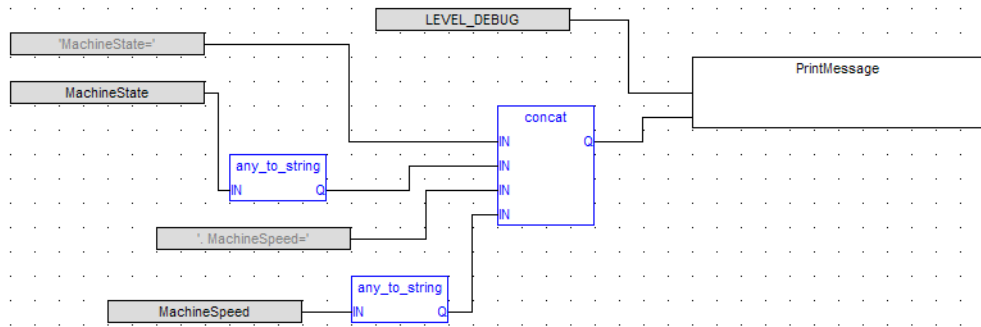

4.5.4.3 FFLD

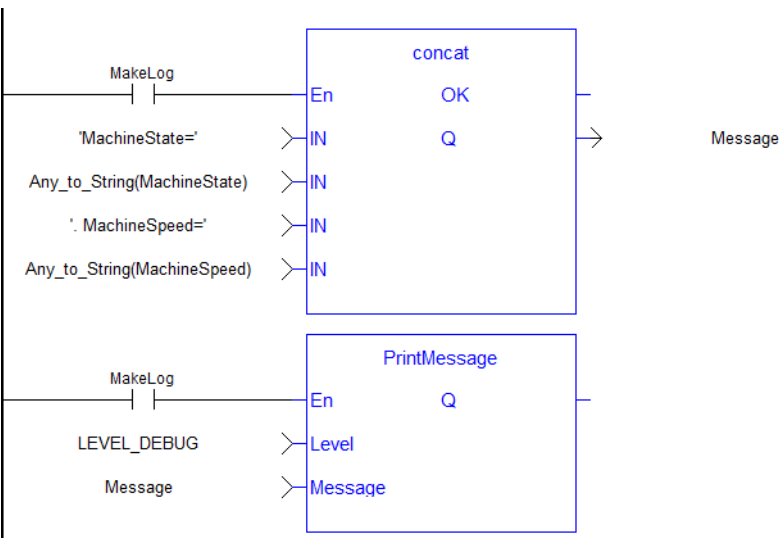

4.6 File and TCP/IP Function Block ErrorID Output

Following is the list of possible errors that could be returned at the **ErrorID** output of the [File Tools Function Blocks](#) and [TCP/IP Function Blocks](#).

File Function Block Errors

ErrorID	Description
16000	Error opening file.
16001	All PLC file handles used.
16002	File ID is invalid.
16003	File ID has been closed.
16004	Error in file stream.
16005	End of file encountered.
16006	Internal file FB error.
16007	Unknown file error.
16008	No such file or directory.
16009	Bad file descriptor.
16010	File already exists.
16011	Too many open files in the system.
16012	Text file is busy.
16013	File is too large.
16014	File system is read only.
16015	File locking deadlock.
16016	Filename is too long.
16017	File positioning error.
16018	Bad or corrupted file system detected .

TCP/IP Function Block Errors

ErrorID	Description
16100	Connection error.
16101	TCP ID has been closed.
16102	All PLC TCP handles used.
16103	TCP ID is invalid.
16104	Failed to allocate TCP/IP socket.
16105	TCP operation internal error.

5 Kollmorgen UDFBs

A Kollmorgen UDFB¹ is a pre-defined function block created by Kollmorgen to simplify certain tasks or demonstrate a particular function. A Kollmorgen UDFB must be instantiated before it may be used. The code inside a Kollmorgen UDFB can be modified by creating an unlocked copy in the subprogram section in the project tree..

5.1 How to create an instance

1. Open your PLC code
2. Select the UDFB in the [Library](#) tree
3. Drag-and-drop the UDFB in the PLC editor to create the instance of the UDFB

An instance of the UDFB has now been created in **Subprograms**.

NOTE

You cannot create the instance of the UDFB directly from the dictionary or from the PLC Editor.

¹"User Defined Function Block" UDFB can be used as a sub-function block in another program of the application. It is described using FBD, LD, ST or IL language. Input / output parameters of a UDFB (as well as private variables) are declared in the variable editor as local variables of the UDFB

5.2 Working with Kollmorgen UDFBs

By default all Kollmorgen UDFBs are protected, meaning they may not be modified or renamed. When a Kollmorgen UDFB is dropped into an instance it is not editable. There are two solutions to make it editable:

- Right click on a Kollmorgen UDFB that has been dropped into an instance (in **Subprograms**) and select **Unlock**. This creates an unlocked version of the UDFB with the name "U<sequence number><UDFB name>".

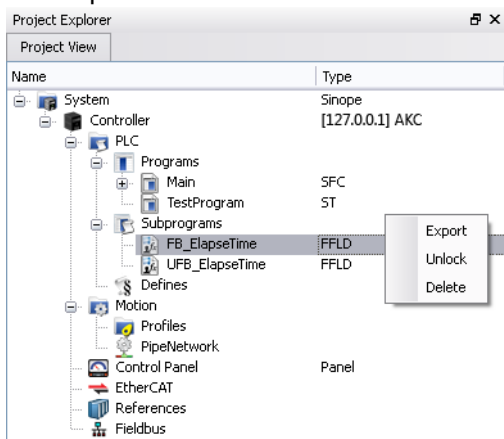

- Instead of dropping a Kollmorgen UDFB into an instance, right click on the UDFB and select **Create unlocked copy in Subprograms**. This creates an unlocked instance of the UDFB with the name "U<sequence number><Kollmorgen UDFB name>".

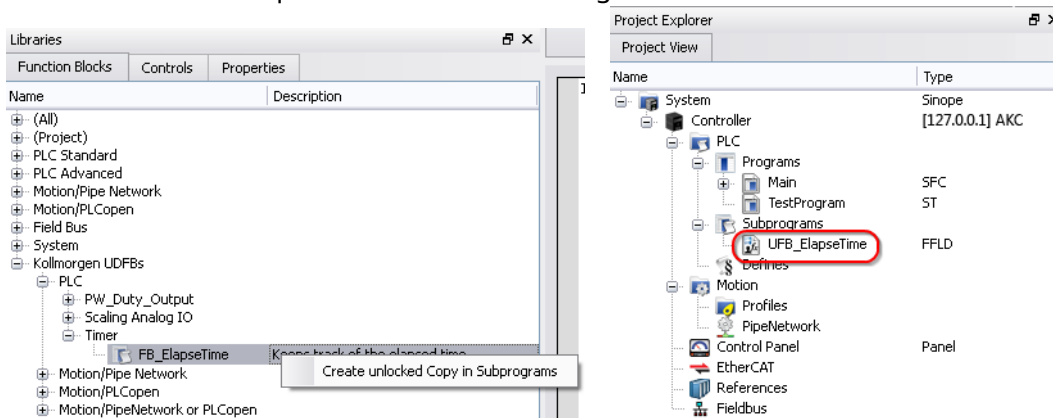

Once a Kollmorgen UDFB has been unlocked it may be renamed and exported by right-clicking on the UDFB. Renamed UDFBs must have unique names. Importing a saved UDFB will increment the UDFB's name.

TIP

In order for a UDFB to modify a structure or array based on the output, you must first define it as an input. The input is automatically set as an INOUT parameter. This is because OUTs are strictly simple types.

5.2.0.1 FB_FirstOrderDigitalFilter

5.2.0.1.1 Description

This FB is defined to filter an Analog signal.

In any control system with an analog feedback signal present there is the risk of unwanted noise and jitter that can compromise the signal integrity yielding a less desirable system.

This Kollmorgen UDFB will provide a digital first order filter of an analog feedback signal from an LVDT, tension transducer, potentiometer, encoder, resolver, or some other like device. The amount of filtering is based on a gain value and can provide no filter to full filter conditioning.

The following figure shows the function block I/O

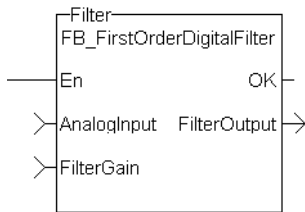

Figure 1-166: CBS First Order Digital Filter

5.2.0.1.2 Arguments

5.2.0.1.2.1 Inputs

EN	Description	Enables execution (FFLD only)
	Data type	BOOL
	Range	—
	Unit	N/A
	Default	
AnalogInput	Description	Analog Input from transducer
	Data type	INT
	Range	—
	Unit	N/A
	Default	
FilterGain	Description	Filter Gain
	Data type	REAL
	Range	[1 - 0.05]
	Unit	N/A
	Default	—

5.2.0.1.2.2 Outputs

OK	Description	Execution Complete
	Data type	BOOL
	Range	[0,1]
	Unit	
FilterOutput	Description	Filtered analog input value
	Data type	REAL

Range	[0,1]
Unit	

5.2.0.1.3 Usage

When using this UDFB, the Enable (EN) input should always be energized in order to provide the desired filtering.

- The AnalogInput input is the unfiltered “raw” analog feedback signal from an LVDT, tension transducer, potentiometer, or some other like device.
- The FilterGain defines the amount of filtering to be used. The range of the gain is from 1.0 or no filtering to 0.05 or the maximum filtering.
- The FilterOutput is the filtered analog input and is typically used as an input to some other function block or UDFB that has an analog input, for example the MCFB_GearedWebTension UDFB.
- The implementation of the digital first order filter is for PLCopen.
- The equation is defined as: $Input * Gain + Output * (1 - Gain) = Output$
- The steady state filter delay with a gain of 0.8 can be seen in the following table.

FilterGain	FilterInput	FilterOutput
0.8	0	0
	100	80
	100	96
	100	99.2
	100	99.84
	100	99.968
	100	99.9936
	100	99.99872
	100	99.999744
	100	99.9999488
	100	99.99998976
	100	99.99999795
	100	99.99999959
	100	99.99999992
	100	99.99999998
	100	100
	100	100
	100	100
	100	100
	100	100
	100	100
	100	100
	100	100

Table 1-10: Filter Input Delay Example

The range of the filter gain is between 1.00 and 0.05. From the table, for a filter gain of 0.8 there is a delay of 15 time constants with a time constant defined as the rate the UDFB is scanned or executed in the application. For example if the UDFB was executed every millisecond a gain of 0.8

would provide a filter delay of 15ms. Conversely a gain of 1.00 provides zero filtering and the output signal follows the input signal, and a gain of 0.05 provides the most filtering for 463 ms.

The numbers of filter delays for a steady state analog input at a given gain are shown in the table and graph below.

Gain	Filter Delay Tn
1.00	0
0.95	8
.90	11
.85	13
.80	15
.75	18
.70	20
.65	23
.60	26
.55	30
.50	35
.45	40
.40	47
.35	56
.30	66
.25	83
.20	107
.15	146
.10	226
.05	463

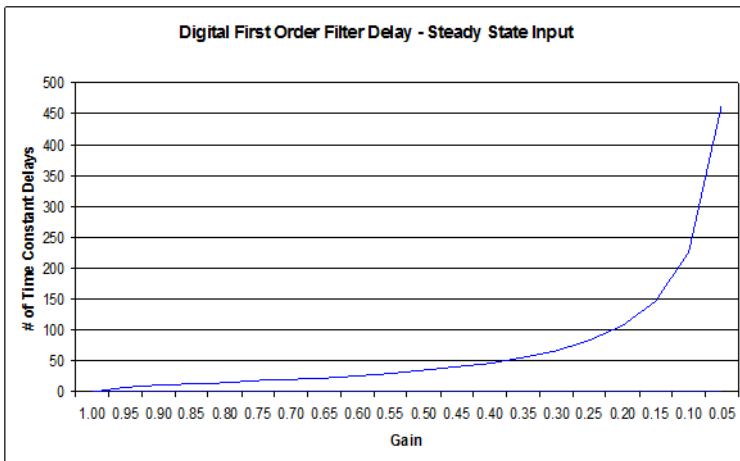

Of course a real world analog input is most always a varying feedback signal. In Table 2.3 this is shown with an initial input of 100, a gain of 0.8, and a random variability of 10%. Filter Input

Filter Input	Filter Current Output	Amount of Input Filtering	Random Filter % Variation
0	0	0	10%
100	80	-20	
97.38903813	93.9112305	-3.477807626	

Filter Input	Filter Current Output	Amount of Input Filtering	Random Filter % Variation
92.67638093	92.92335084	0.246969915	
94.12988912	93.88858146	-0.241307655	
103.0835564	101.2445614	-1.838994993	
91.16845433	93.18367575	2.015221422	
93.23936976	93.22823096	-0.011138803	
94.90272089	94.56782291	-0.334897986	
103.3070737	101.5592235	-1.747850153	
96.83149418	97.77704005	0.945545867	
96.35024002	96.63560002	0.285360007	
99.82417525	99.1864602	-0.637715045	
105.0792636	103.9007029	-1.178560685	
97.36988208	98.67604626	1.306164172	
107.82502	105.9952253	-1.829794752	
97.7886524	99.42996698	1.641314572	
108.2038024	106.4490353	-1.754767081	
91.58527607	94.55802792	2.972751845	
93.6783421	93.85427926	0.175937164	
102.8695349	101.0664838	-1.803051129	
93.95916817	95.3806313	1.421463121	
108.6579707	106.0025028	-2.655467871	
109.3425748	108.6745604	-0.668014397	
103.9066	104.8601921	0.953592077	
92.30112142	94.81293555	2.511814127	
109.4460726	106.5194452	-2.926627416	
94.88799896	97.21428821	2.326289251	
105.4738635	103.8219484	-1.651915057	
102.988167	103.1549233	0.166756284	
92.92925408	94.97438792	2.045133846	
95.58185568	95.46036213	-0.121493552	
109.414248	106.6234708	-2.790777178	
106.5661311	106.577599	0.011467953	
99.85857253	101.2023778	1.343805301	
107.865421	106.5328124	-1.332608643	
92.19683177	95.0640279	2.867196126	
104.8558146	102.8974573	-1.958357346	
104.5140236	104.1907104	-0.323313268	
104.3675014	104.3321432	-0.035358206	
109.2704266	108.2827699	-0.987656683	
101.4962729	102.8535723	1.35729941	
92.19199163	94.32430776	2.132316128	
99.13065312	98.16938405	-0.961269073	
103.5068114	102.4393259	-1.067485466	

Filter Input	Filter Current Output	Amount of Input Filtering	Random Filter % Variation
109.502983	108.0902516	-1.412731426	
99.05504822	100.8620889	1.80704068	
94.97711299	96.15410817	1.176995182	
107.1063597	104.9159094	-2.190450308	
91.12245188	93.88114339	2.758691504	
108.130314	105.2804799	-2.849834129	
104.2923832	104.4900025	0.197619344	
101.3775072	102.0000062	0.62249907	
100.5303014	100.0399168	-0.490384645	Averages

Table 1-11: Filter Input Lag Example - Random Input

5.2.0.1.4 Example

5.2.0.1.4.1 Structured Text

```
//Filter analog input signal with a gain of 0.8 to remove noise
FilteredOutput:= Inst_FB_FirstOrderDigitalFilter( AnalogInput1Value, 0.8
);
```

5.2.0.1.4.2 Ladder Diagram

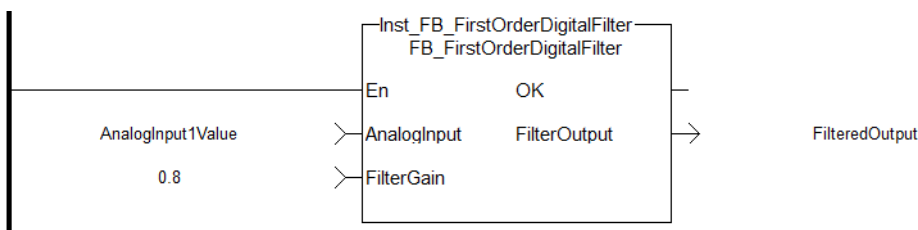

5.2.0.1.4.3 Function Block Diagram

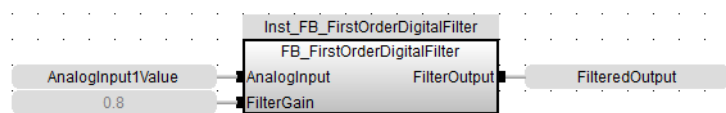

5.2.0.2 FB_PWDutyOutput

5.2.0.2.1 Description

The Pulse Width Duty Cycle function block accepts an input value between the minimum and maximum input range and converts this to a duty cycle percentage. The output is then cycled on and off over the period of the duty cycle at the duty cycle percentage.

- If it is desired to have the output ON time range from 0 to the duty cycle period, the minimum should be set to zero and the maximum to the duty cycle period.
- If the calculated duty cycle based on the input and range values is less than the minimum ON time (MinTime), the output will not come on.
- If the calculated duty cycle is between or equal to the range values the output is cycled by the duty cycle.
- If the calculated duty cycle is greater than the maximum ON time (MaxTime) the output will remain on.

The following figure shows the function block I/O

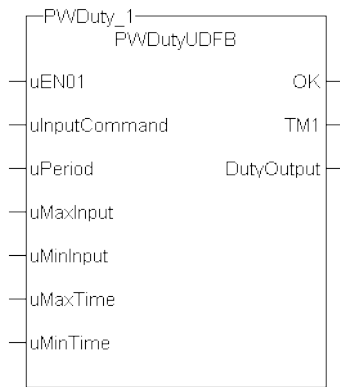

Figure 1-167: Pulse Width Duty Cycle

5.2.0.2.2 Arguments

5.2.0.2.2.1 Input

uEN01	Description	Enable for the block
	Data type	BOOL
	Range	[0 , 1]
	Unit	N/A
	Default	—
uInputCommand	Description	Signal Input (sometimes the output of a PID block).
	Data type	REAL
	Range	[0 to --]
	Unit	N/A
	Default	—
uPeriod	Description	Period of the duty cycle
	Data type	TIME
	Range	[0 , --]
	Unit	N/A
	Default	—
uMaxInput	Description	uInputCommand at or above this number that sets DutyOutput =1
	Data type	REAL
	Range	uMinInput to --
	Unit	N/A
	Default	—
uMinInput	Description	uInputCommand at or below this number set DutyOutput = 0

	Data type	REAL
	Range	0 to uMaxInput
	Unit	N/A
	Default	—
uMaxTime	Description	Maximum on time for the Output
	Data type	TIME
	Range	uMinTime to uPeriod
	Unit	N/A
	Default	—
uMinTime	Description	Minimum on-time for the PW Duty Output
	Data type	TIME
	Range	0 to uMaxTime
	Unit	N/A
	Default	—

5.2.0.2.2.2 Output

OK	Description	Function block is OK.
	Data type	BOOL
	Range	[0, 1]
TM1	Description	On-time of the Output
	Data type	TIME
	Range	0 to uPeriod
DutyOutput	Description	PW signal (switching between 0 and 1). DutyOutput is set to 0 when the function block is not active (not enabled by the first input).
	Data type	BOOL
	Range	[0, 1]

5.2.0.2.3 Usage

Flash a warning light for operators.

5.2.0.2.4 Related Functions

[Timers](#)

5.2.0.2.5 Example

5.2.0.2.5.1 Function Block Calculations

```

IF (uInputCommand - uMinInput) < 0 then      //If Command less than
MinInput turn out put off
    DutyOutput := 0;
ELSIF (uInputCommand - uMaxInput) > 0 then  //If Command greater than
MaxInput turn out put on
    DutyOutput := 1;
ELSE
    DutyCycle := (uInputCommand - uMinInput)/(uMaxInput -
uMinInput);      //Calculate Duty Cycle
    ONTimeFromInput := DutyCycle * any_to_REAL(uPeriod) ;      //Calculate
Ontime

    IF any_to_TIME(ONTimeFromInput) < uMinTime then
        DutyOutput := 0;
    ELSIF any_to_TIME(ONTimeFromInput) > uMaxTime then
        DutyOutput := 1;
    ELSE
        TM1 := any_to_TIME(ONTimeFromInput) ;
        TM0 := uPERIOD - TM1;      //Calculate offtime
        DutyOutput := Inst_blinkA( 1 , TM0 , TM1 ) ;      //Use BlinkA
function to set PW output
    END_IF ;
END_IF ;

```

5.2.0.2.5.2 Structured Text

```

Inst_FB_PWDutyOutput( PWDuty_3_Switch, PWDuty_In3, PWDuty_3_Period, PWDuty_3_MaxInput,
PWDuty_3_MinInput, PWDuty_3_MaxTime, PWDuty_3_MinTime);

```

```

PWDuty_3_OK:=Inst_FB_PWDutyOutput.OK;

```

```

PWDuty_3_Time:=Inst_FB_PWDutyOutput.TM1;

```

```

PWDuty_3_Output:=Inst_FB_PWDutyOutput.DutyOutput;

```

5.2.0.2.5.3 Ladder Diagram

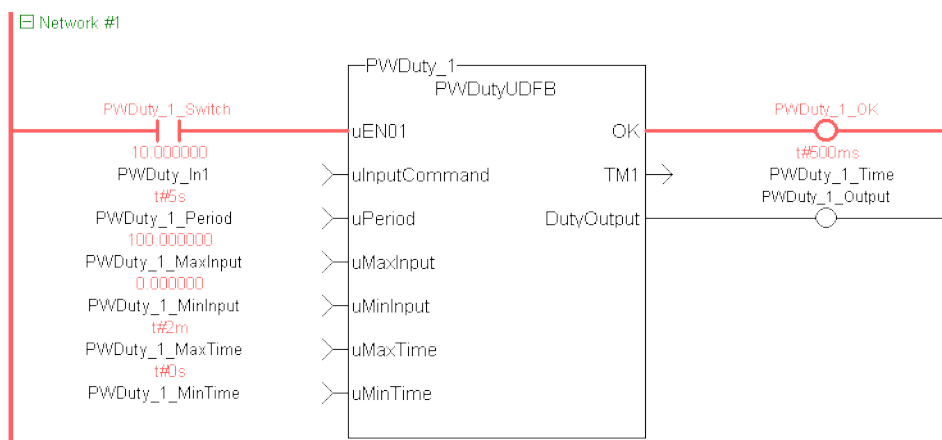

5.2.0.2.5.4 Function Block Diagram

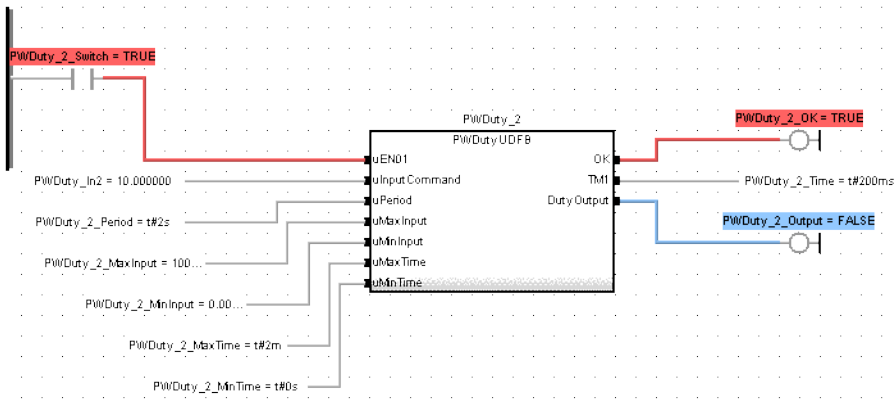

5.2.0.3 FB_ScaleInput

5.2.0.3.1 Description

Scale DINT to LREAL.

Converts un-scaled DINT values from Analog Inputs into user units of type LREAL. The input signal is converted based on a linear mapping automatically calculated by two points entered. InputMin is mapped to OutputMin, InputMax is mapped to OutputMax, and all values in between are scaled automatically. If an input value is not between the selected Min/Max, the Boolean output OutsideRange turns TRUE, and the OutputSignal is set to the corresponding OutputMin or OutputMax value.

The following figure shows the function block I/O:

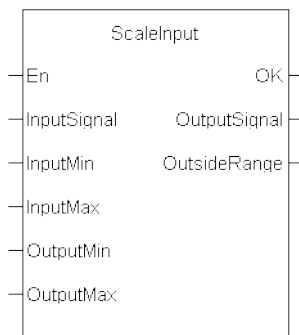

Figure 1-168: Scale Input

5.2.0.3.2 Arguments

5.2.0.3.2.1 Input

InputSignal	Description	Un-scaled input signal
	Data type	DINT
	Range	[0 , 4]
	Unit	N/A
	Default	—
InputMin	Description	Minimum value of accepted input signal range

	Data type	DINT
	Range	[0 , 4]
	Unit	N/A
	Default	—
InputMax	Description	Maximum value of accepted input signal range
	Data type	DINT
	Range	[0 , 4]
	Unit	N/A
	Default	—
OutputMin	Description	Output value mapped to the InputMin
	Data type	LREAL
	Range	[0 , 4]
	Unit	N/A
	Default	—
OutputMax	Description	Output value mapped to the InputMax
	Data type	LREAL
	Range	[0 , 4]
	Unit	N/A
	Default	—

5.2.0.3.2.2 Output

OutputSignal	Description	Scaled value of the Input Signal with type converted to LREAL. Stays within specified Min/Max output values
	Data type	LREAL
	Unit	N/A
OutsideRange	Description	True if InputSignal is outside range setup by min/max values, otherwise FALSE
	Data type	BOOL
	Unit	N/A

5.2.0.3.3 Usage

Scale an analog signal from a drive.

5.2.0.3.4 Related Functions

[UDFB ScaleOutput](#)

5.2.0.3.5 Example

5.2.0.3.5.1 Structured Text

```
//Scale an integer based analog input signal into floating point LREAL
variable
ScaleInput_1( Analog_In, Analog_In_Min, Analog_In_Max, LREAL_Out_Min,
LREAL_Out_Max );
LREAL_OutputSignal:= ScaleInput_1.OutputSignal;
Analog_Range_Err:= ScaleInput_1.OutsideRange;
```

5.2.0.3.5.2 Ladder Diagram

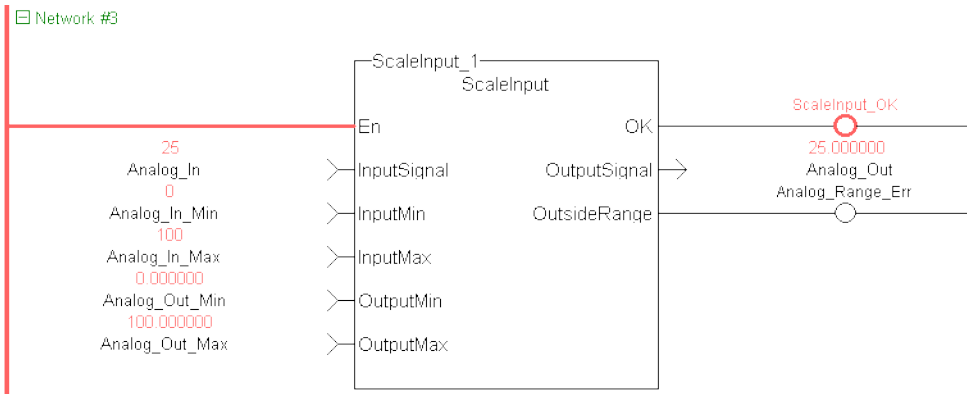

5.2.0.3.5.3 Function Block Diagram

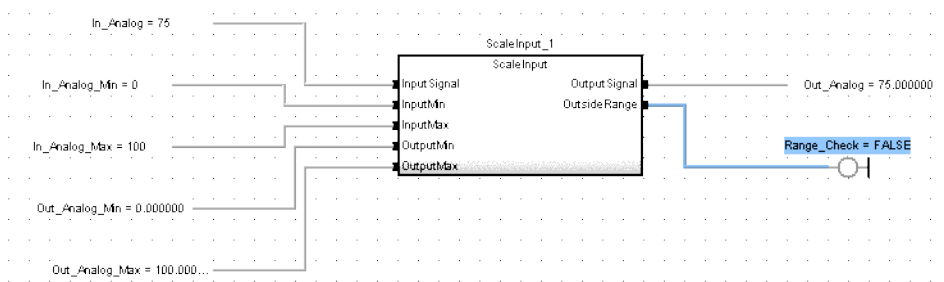

5.2.0.4 FB_ScaleOutput

5.2.0.4.1 Description

Scale LREAL to DINT .

This Kollmorgen UDFB converts un-scaled LREAL values from a PLC Program into units of type DINT that can be mapped to an analog output. The input signal is converted based on a linear mapping automatically calculated by two points entered. InputMin is mapped to OutputMin, InputMax is mapped to OutputMax, and all values in between are scaled automatically. If an input value is not between the selected Min/Max, the Boolean output OutsideRange turns TRUE, and the OutputSignal is set to the corresponding OutputMin or OutputMax value.

The following figure shows the function block I/O:

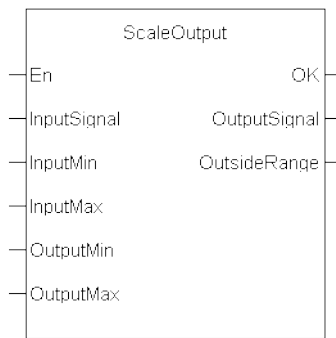

Figure 1-169: Scale Output

5.2.0.4.2 Arguments

5.2.0.4.2.1 Input

InputSignal	Description	Un-scaled input signal
	Data type	LREAL
	Range	[0 , 4]
	Unit	N/A
	Default	—
InputMin	Description	Minimum value of accepted input signal range
	Data type	LREAL
	Range	[0 , 4]
	Unit	N/A
	Default	—
InputMax	Description	Maximum value of accepted input signal range
	Data type	LREAL
	Range	[0 , 4]
	Unit	N/A
	Default	—
OutputMin	Description	Output value mapped to the InputMin
	Data type	DINT
	Range	[0 , 4]
	Unit	N/A
	Default	—
OutputMax	Description	Output value mapped to the InputMax
	Data type	DINT
	Range	[0 , 4]
	Unit	N/A
	Default	—

5.2.0.4.2.2 Output

OutputSignal	Description	Scaled value of the Input Signal with type converted to DINT. Stays within specified Min/Max output values
	Data type	DINT
	Unit	N/A
OutsideRange	Description	True if InputSignal is outside range setup by min/max values, otherwise FALSE
	Data type	BOOL
	Unit	N/A

5.2.0.4.3 Usage

Scale an analog signal to a drive.

5.2.0.4.4 Related Functions

[UDFB ScaleInput](#)

5.2.0.4.5 Example

5.2.0.4.5.1 Structured Text

```

Inst_ScaleOutput1( ScaleOutput_In2, ScaleOutput_In2_
Min,ScaleOutput_In2_Max, ScaledOutput_2_Min, ScaledOutput_2_Max
);

ScaledOutput_2:=Inst_ScaleOutput1.OutputSignal;
ScaledOutput_2_Err:=Inst_ScaleOutput1.OutsideRange;
    
```

5.2.0.4.5.2 Ladder Diagram

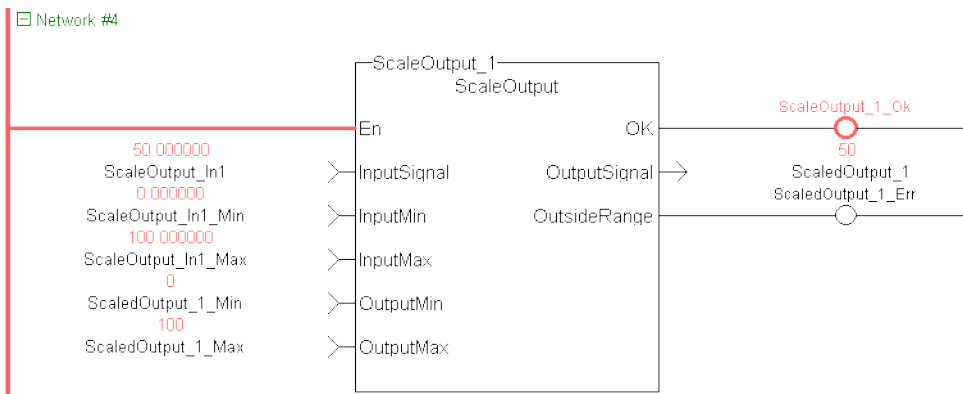

5.2.0.4.5.3 Function Block Diagram

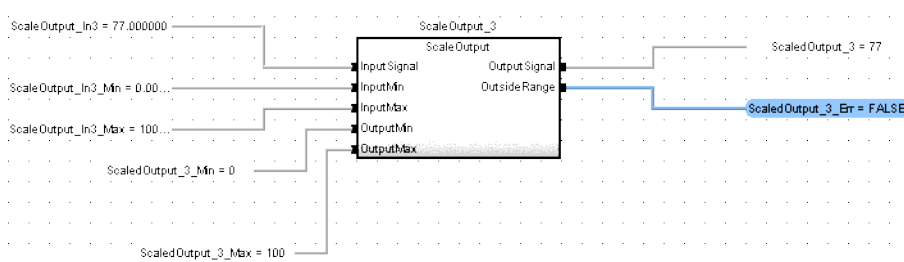

5.2.0.5 FB_ElapseTime

5.2.0.5.1 Description

This Kollmorgen UDFB keeps track of the time (oTotalOnTime) that a Boolean input variable is on. Once the iEN00 enable input is high the Kollmorgen UDFB will keep track of the total time iVariable is on. If iVariable changes to an off state while iEN00 is on, the oTotalOnTime will stop. oTotalOnTime will start to add again once iVariable changes state to high. As long as the iEN00 input is on, iVariable can change states many times. The oTotalOnTime will reflect only the total

time that iVariable has been on. While iVariable is still TRUE, oInProgress will also be TRUE and oDone will be FALSE. Once iVariable is FALSE, oInProgress will be FALSE and oDone will be TRUE.

If the iEN00 input goes off, oTotalOnTime stops counting and the Kollmorgen UDFB execution stops. To restart the timer turn iEN00 on again. This will reset oTotalOnTime to zero and counting will begin once iVariable is also on.

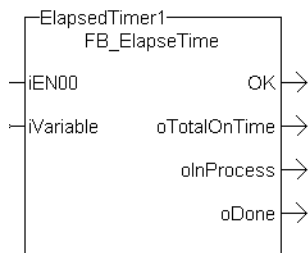

Figure 1-170: FB_ElapseTime

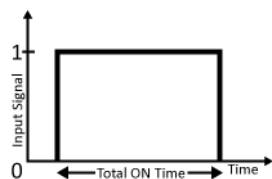

Figure 1-171: MFB_ElapseTime – Time Diagram

5.2.0.5.2 Arguments

5.2.0.5.2.1 Input

iEN00	Description	Enable for the block
	Data type	Boolean
	Range	FALSE or TRUE
	Unit	N/A
	Default	FALSE
iVariable	Description	The variable to be tracked
	Data type	Boolean
	Range	FALSE or TRUE
	Unit	N/A
	Default	FALSE

5.2.0.5.2.2 Output

OK	Description	Function Block OK. This output follows the state on iEN00 input
	Data type	Boolean
	Range	FALSE or TRUE
	Unit	N/A
oTotalOnTime	Description	The amount of time the iVariable is turned on.

	Data type	Time
	Range	0ms - 24h
	Unit	ms
oTotalOnTime	Description	The amount of time the iVariable is turned on.
	Data type	Time
	Range	0ms - 24h
	Unit	ms
oInProgress	Description	The state of block's execution whether or not it is still keeping track of time
	Data type	Boolean
	Range	FALSE or TRUE
	Unit	N/A
oDone	Description	The state of block's execution whether or not it is completed
	Data type	Boolean
	Range	FALSE or TRUE
	Unit	N/A

5.2.0.5.3 Usage

- Enable the block by setting iEN00 to TRUE
- Either manually set iVariable to TRUE or have the application set this variable to TRUE
- Once oDone returns TRUE, read the oTotalOnTime to find out how long iVariable was on.

5.2.0.5.4 Example

5.2.0.5.4.1 Structured text

```
//Keep track of total time that IncrementTimer variable is TRUE while
EnableTimer variable is true
//Timer will be reset when EnableTimer variable is false
Inst_FB_ElapseTime( EnableTimer, IncrementTimer );
TotalOnTime := Inst_FB_ElapseTime.oTotalOnTime;
```

5.2.0.5.4.2 Function Block Diagram

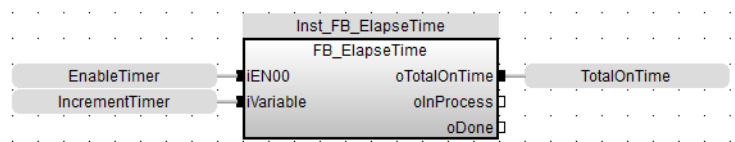

5.2.0.5.4.3 Free Form Ladder Diagram

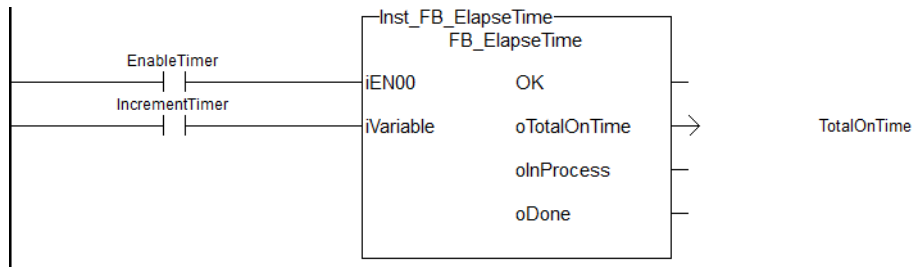

5.2.0.6 PipeNetwork_FFLD Pipe Network ✓

5.2.0.6.1 Description

This function is used to call the PNCode Function Block in FFLD POU's. It starts and initializes the Pipe Network, based on the command specified by cmdID. Internally this function calls the Function Block PNCode.

This is a special function that should only be used in Pipe Network applications that contain FFLD POU's that call PNCode. Calling this function instead of PNCode in FFLD POU's will eliminate the following compile error that occurs after modifying the Pipe Network using the Pipe Network editor.

```
Controller:PLC:Main: NW1(1,14): PNCode: Invalid block height
```

NOTE
The compile error is generated because the number of outputs on PNCode can vary. This occurs after modifying the original Pipe Network using the Pipe Network editor. The new PNCode Function Block is not automatically updated in any FFLD POU, reflecting the new outputs. You need to manually update each PNCode Function Block call in any FFLD POU to correct this problem.

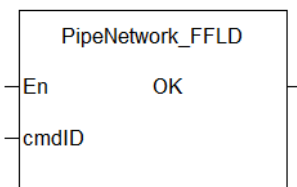

Figure 1-172: PipeNetwork_FFLD

See also: [Design Motion with Pipe Network, Initialize and Start up a Pipe Network, PLCopen 2-Axes Template with FFLD](#)

5.2.0.6.2 Arguments

5.2.0.6.2.1 Inputs

En	Description	Request to initialize the Pipe Network
	Data type	BOOL
	Range	0, 1
	Unit	N/A
	Default	—

cmdID	Description	Commands used to start and initialize the Pipe Network <ul style="list-style-type: none"> • MLPN_CREATE_OBJECTS – Create Pipe Network • MLPN_POWER_ON – Power on all axes • MLPN_POWER_OFF – Power off all axes • MLPN_ACTIVATE – Activate the pipes • MLPN_CONNECT – Connect the axes to the pipes • MLPN_DEACTIVATE – Deactivate the pipes
	Data type	DINT
	Range	N/A
	Unit	N/A
	Default	—

5.2.0.6.2.2 Outputs

OK	Description	Returns TRUE when the function has completed
	Data type	BOOL
	Unit	N/A

5.2.0.6.3 Usage

- This is a special function that should only be used in Pipe Network applications that contain FFLD POU's that call PNCode.
- To use this Function, PipeNetwork must be declared as a global variable in the dictionary.

TIP

The Pipe Network FFLD Application Template is a good example of how to use this Function. See [Pipe Network 2-Axes Template with FFLD only](#).

5.2.0.6.4 Example

5.2.0.6.4.1 FFLD

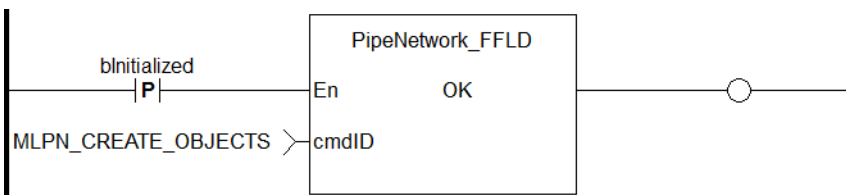

5.2.0.7 ProfilesCode_FFLD

5.2.0.7.1 Description

This function is used to call the Profiles Code Function Block in FFLD POU's. Internally this function calls the Function Block ProfilesCode.

This is a special function which should only be used in applications that contain FFLD POU's that call ProfilesCode. Calling this function instead of ProfilesCode in FFLD POU's will eliminate the following compile error that occurs after adding a new Profile to the project tree.

```
Controller:PLC:Main:NW1(1,14):ProfilesCode:Invalid block height
```

The compile error is generated because the number of outputs on ProfilesCode can vary. This occurs after adding a new profile to the project tree. The ProfilesCode Function Block is not automatically updated in any FFLD POU, reflecting the new outputs. You needed to manually update each ProfilesCode Function Block call in any FFLD POU to correct this problem. If you use this new Function instead, you no longer need to manually update each ProfilesCode Function Block in FFLD.

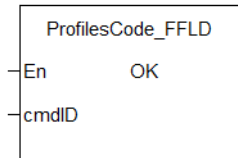

Figure 1-173: ProfilesCode_FFLD

5.2.0.7.2 Arguments

5.2.0.7.2.1 Inputs

En	Description	Request to initialize the Pipe Network
	Data type	BOOL
	Range	0,1
	Unit	N/A
	Default	—
cmdID	Description	Commands used to start and initialize the Pipe Network <ul style="list-style-type: none"> MLPR_CREATE_PROFILES - Creation and initialization of profiles.
	Data type	DINT
	Range	N/A
	Unit	N/A
	Default	—

5.2.0.7.2.2 Outputs

OK	Description	Returns TRUE when the function has completed
	Data type	BOOL
	Unit	N/A

5.2.0.7.3 Usage

- This is a special function that should only be used in applications that contain FFLD POUs that call ProfilesCode.
- To use this function, Profiles must be declared as a global variable in the dictionary.

TIP

The Pipe Network and PLCopen 2 Axis FFLD Application Templates are two examples of how to use this function. See [Pipe Network 2-Axes Template with FFLD only](#) and [PLCopen 2-Axes Template with FFLD](#).

5.2.0.7.4 Example

5.2.0.7.4.1 FFLD

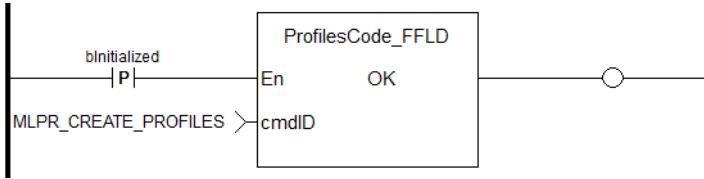

5.2.0.8 FB_TemperaturePID

5.2.0.8.1 Description

This function block provides PID temperature control with auto tuning.

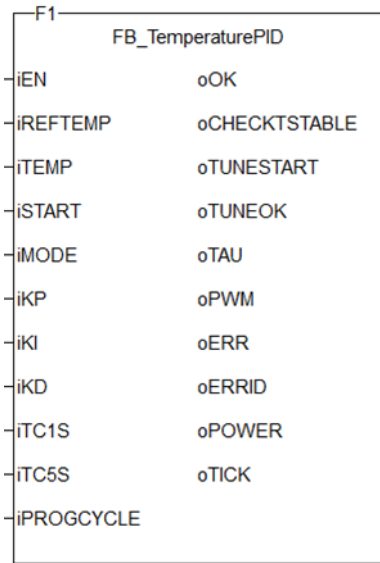

Figure 1-174: The TemperaturePID user-defined function block

5.2.0.8.2 Arguments

5.2.0.8.2.1 Inputs

iEN	BOOL	Enable function
iREFTEMP	LREAL	Reference temperature [°C]
iTEMP	LREAL	Actual temperature [°C]
iSTART	BOOL	Start PID or auto tuning
iMODE	BOOL	FALSE-automatic, TRUE-tuning
iKP	LREAL	PID Proportional Gain
iKI	LREAL	PID Integral Gain
iKD	LREAL	PID Derivative Gain
iTC1S	BOOL	Sampling Time is 1s
iTC5S	BOOL	Sampling Time is 5s
iPROGCYCLE	LREAL	Execution time of the function [ms]

5.2.0.8.2.2 Outputs

oOK	BOOL	Function enabled
oCHECKSTABLE	BOOL	TRUE when checking if ambient temperature is stable
oTUNESTART	BOOL	Tuning is started
oTUNEOK	BOOL	Tuning is completed
oTAU	LREAL	System Time Constant[s]
oPWM	BOOL	PWM command for heater
oERR	BOOL	Function error
oERRID	INT	Function ID error (in case of oERR=TRUE)
oPOWER	LREAL	% of power requested from heater (100%=full power)
oTICK	BOOL	Pulse every sampling time

5.2.0.8.3 Usage

5.2.0.8.3.1 Tuning Process

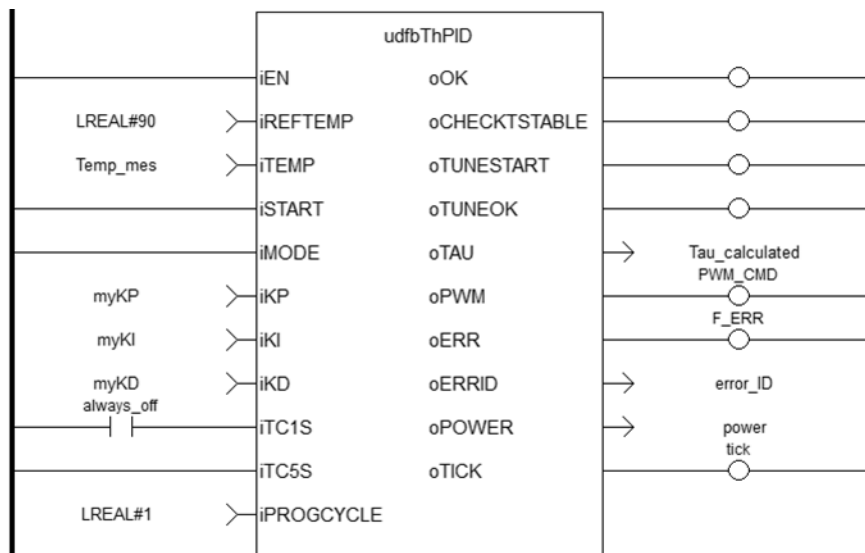

Tuning consists of three steps.

1. Check if the ambient temperature is stable: the measured **delta_temp=Tmax-Tmin** must be lower than **0.1*Tmax**.
This step takes 10 cycles ($10 \cdot iTC5s$ or $10 \cdot iTC1s$).
The tuning fails (**oERR=TRUE**, **oERRID=1**) if the ambient temperature is greater than **0.1*Tmax**, otherwise **Tamb=(Tmax+Tmin)/2**.
2. Start tuning Phase1: output **oPWM** is kept TRUE until the final measured temperature **iTEMP** gets over **iREFTEMP/2**. After that **oPWM** is kept LOW.
3. Start tuning Phase2: with **oPWM** kept LOW the temperature gets down until the final value is lower than $[(iREFTEMP/2 - Tamb) \cdot 0.368 + Tamb]$.

After, PID gains are calculated as:

```
Kp=10
Ki=0.14
delta_time = time to complete Phase2
```

$Kd = \text{SQRT}(\text{delta_time}) * 7$

The tuning is completed.

TIP

oTAU may be useful for setting the proper sampling time (1s or 5s).

5.2.0.8.3.2 Start PID Controller

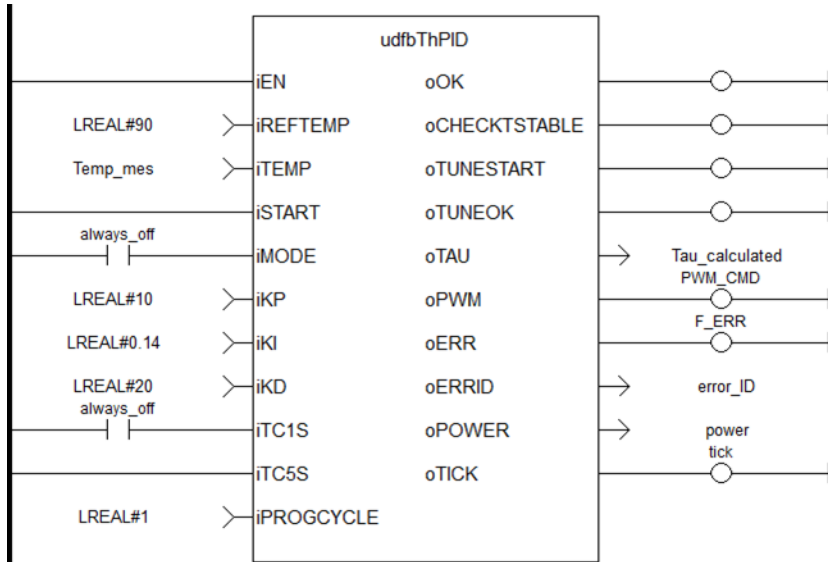

Upon starting the PID controller, the output **oPWM** is modulated 5 times within the sampling time (blue line is **oTICK**, green line is **oPWM**) and each pulse length depends on output **oPOWER** (100%=full length).

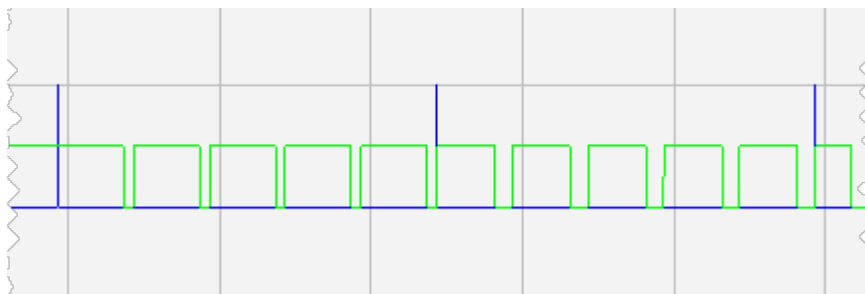

5.2.0.8.4 Example

5.2.0.8.4.1 ST

```
//Run PID function with determined proportional, integral, and derivative gains
//send PWM output to command heater
udfbThPID( TRUE, 90, Temp_mes, TRUE, FALSE, KP, KI, KD, FALSE, TRUE, 1);
Tau_Calculated := udfbThPID.oTAU;
PWM_CMD := udfbThPID.oPWM;
Power := udfbThPID.oPOWER;
Tick := udfbThPID.oTICK;
```

5.2.0.8.4.2 FBD

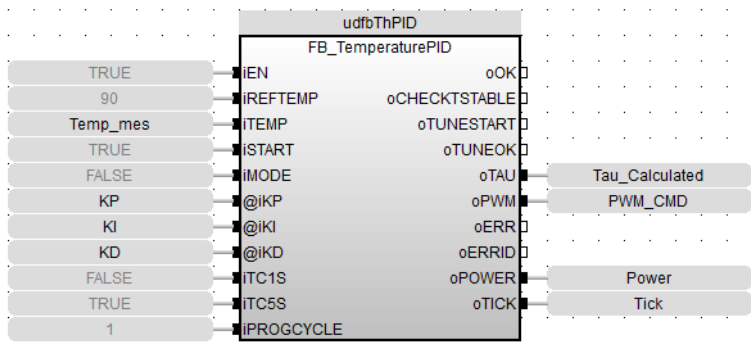

5.2.0.8.4.3 FFLD

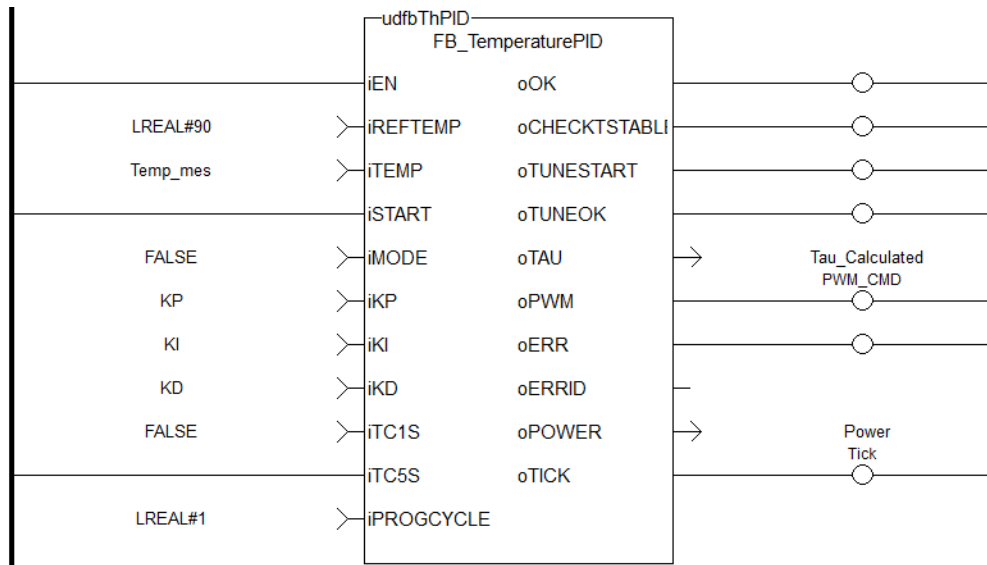

5.2.0.9 MLFB_DriveFault Pipe Network ✓

5.2.0.9.1 Description

This function block returns the fault status, fault number and fault description of the requested axis which is mapped to a Kollmorgen drive such as S300, S700, AKD, AKD2G, and AKT2G Stepper.

The FAULT output returns TRUE when the selected drive goes into a fault state. The fault number and description depend on the drive type mapped to the axis.

- If the drive is an AKD or AKD2G then the fault number is the same number as reported on the display of the AKD/AKD2G drive.
- If the drive is an AKT2G Stepper, then the fault number represents the drive status word which is a bitmask that represents the various error conditions.

NOTE
 This function blocks requires [FB_S700FltRpt](#), [MCFB_AKDFault](#), and [MCFB_AKDFaultLookup](#) subprograms imported to project to compile and function

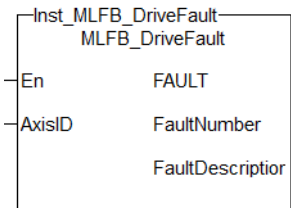

Figure 1-175: MCFB_DriveFault

5.2.0.9.2 Arguments

5.2.0.9.2.1 Input

EN	Description	ENABLES the Kollmorgen UDFB (used in FFLD editor only)
	Data type	BOOL
	Range	[0 , 1]
	Unit	N/A
	Default	—
AxisID	Description	ID of Axis block of Pipe Network
	Data type	DINT
	Range	[-2147483648, 2147483648]
	Unit	N/A
	Default	—

5.2.0.9.2.2 Output

FAULT	Description	TRUE if the selected drive currently has a Fault
	Data type	BOOL
	Range	[0 , 1]
	Unit	N/A

FaultNumber	Description	<p>If the axis is:</p> <p>S300/S700: Three-digit fault identifier. See the article S300 & S700 Errors and Warnings on KDN for a full list of fault codes.</p> <p>AKD: Three-digit fault identifier. See the AKD Fault and Warning Messages for a full list of fault codes.</p> <p>AKD2G: Four-digit fault identifier. See the AKD2G Faults and Warning Messages for a full list of fault codes.</p> <p>AKT2G Stepper: Drive Status word (bitmask). See following table.</p> <table border="1"> <thead> <tr> <th>Bit</th> <th>Description</th> <th>Cause</th> </tr> </thead> <tbody> <tr> <td>0</td> <td>Saturated</td> <td>Drive stage operates with maximum duty cycle</td> </tr> <tr> <td>1</td> <td>Over temperature</td> <td>Internal temperature is higher than 80o C</td> </tr> <tr> <td>2</td> <td>Torque overload.</td> <td>Motor current is higher than the rated current</td> </tr> <tr> <td>3</td> <td>Under voltage.</td> <td>Motor supply voltage is 20% lower than the configured nominal voltage (warning), or Motor supply voltage is less than 8 V</td> </tr> <tr> <td>4</td> <td>Over voltage.</td> <td>Motor supply voltage is 10% higher than the configured nominal voltage</td> </tr> <tr> <td>5</td> <td>Short circuit A.</td> <td>Short circuit in motor coil A</td> </tr> <tr> <td>6</td> <td>Short circuit B</td> <td>Short circuit in motor coil B</td> </tr> <tr> <td>7</td> <td>No control power</td> <td>Control voltage at the power contacts is less than 12 V</td> </tr> <tr> <td>8</td> <td>Misc. error</td> <td>Terminal initialization failed, or supply voltage is less than 8 V, or internal terminal temperature is higher than 100°C</td> </tr> <tr> <td>9</td> <td>Configuration error</td> <td>CoE change has not yet been adopted into the current configuration</td> </tr> </tbody> </table>	Bit	Description	Cause	0	Saturated	Drive stage operates with maximum duty cycle	1	Over temperature	Internal temperature is higher than 80o C	2	Torque overload.	Motor current is higher than the rated current	3	Under voltage.	Motor supply voltage is 20% lower than the configured nominal voltage (warning), or Motor supply voltage is less than 8 V	4	Over voltage.	Motor supply voltage is 10% higher than the configured nominal voltage	5	Short circuit A.	Short circuit in motor coil A	6	Short circuit B	Short circuit in motor coil B	7	No control power	Control voltage at the power contacts is less than 12 V	8	Misc. error	Terminal initialization failed, or supply voltage is less than 8 V, or internal terminal temperature is higher than 100°C	9	Configuration error	CoE change has not yet been adopted into the current configuration
	Bit	Description	Cause																																
	0	Saturated	Drive stage operates with maximum duty cycle																																
	1	Over temperature	Internal temperature is higher than 80o C																																
	2	Torque overload.	Motor current is higher than the rated current																																
	3	Under voltage.	Motor supply voltage is 20% lower than the configured nominal voltage (warning), or Motor supply voltage is less than 8 V																																
	4	Over voltage.	Motor supply voltage is 10% higher than the configured nominal voltage																																
	5	Short circuit A.	Short circuit in motor coil A																																
	6	Short circuit B	Short circuit in motor coil B																																
	7	No control power	Control voltage at the power contacts is less than 12 V																																
8	Misc. error	Terminal initialization failed, or supply voltage is less than 8 V, or internal terminal temperature is higher than 100°C																																	
9	Configuration error	CoE change has not yet been adopted into the current configuration																																	
Data type	DINT																																		
Range																																			
Unit	N/A																																		
Fault Description	Description	Description of the Fault																																	
	Dsata type	STRING																																	
	Range	N/A																																	
	Unit	N/A																																	

5.2.0.9.3 Usage

Typical usage for this UDFB is:

- Provide drive fault information that the application program uses to determine next steps such as perform a machine-controlled stop or perform an immediate disable of the servo drives.
- In the application program send output fault information from this UDFB to the HMI for review by the machine operator.

Related Functions

- [FB_S700FltRpt](#)
- [MCFB_AKDFaultLookup](#)

5.2.0.9.4 Example

5.2.0.9.4.1 Structured Text

```
//Execute and Read the Function Block
Inst_MLFB_DriveFault(PipeNetwork.AXIS1);
Axis1Fault := Inst_MLFB_DriveFault.FAULT;
Axis1FaultNumber := Inst_MLFB_DriveFault.FaultNumber;
Axis1FaultDescription := Inst_MLFB_DriveFault.FaultDescription;
```

5.2.0.9.4.2 Ladder Diagram

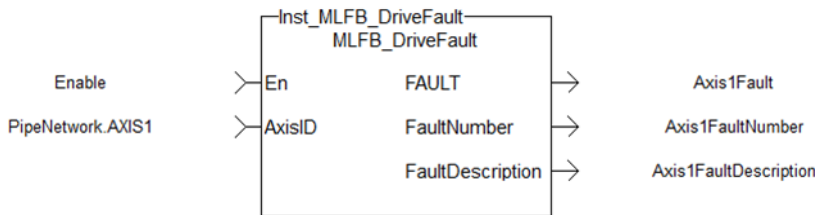

5.2.0.9.4.3 Function Block Diagram



5.2.0.10 MLFB_ECATRstart Pipe Network ✓

5.2.0.10.1 Description

This function block reinitializes the EtherCAT network and the motion engine. This function blocks also clears motion engine errors, motion bus driver errors and EtherCAT network errors before reinitializing the motion engine, if requested to do so.

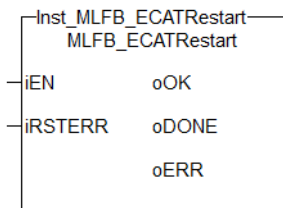

Figure 1-176: MLFB_ECATRstart

5.2.0.10.2 Arguments

5.2.0.10.2.1 Input

iEN	Description	ENABLES the Kollmorgen UDFB
	Data type	BOOL
	Range	[0, 1]
	Unit	N/A
	Default	—
iRSTERR	Description	Clears the motion engine and EtherCAT network errors in case of any faults
	Data type	BOOL
	Range	[1, 256]
	Unit	[0, 1]
	Default	—

5.2.0.10.2.2 Output

oOK	Description	Function block activated status
	Data type	BOOL
	Range	[0, 1]
	Unit	N/A
oDONE	Description	Execution Complete
	Data type	BOOL
	Range	[0, 1]
	Unit	N/A
oERR	Description	TRUE if the system initialization fails.
	Data type	BOOL
	Range	[0, 1]
	Unit	N/A

5.2.0.10.3 Usage

The typical use for this UDFB is to allow the EtherCAT and motion engines to restart without having to restart the entire project. Examples:

- EtherCAT network wire is replaced or accidentally disconnected
- Axis setup Parameters defined by CreateAxis and/or InitAxis function need to be changed while the application is running.

Related Functions

- [ClearCtrlErrors](#)
- [MLMotionInit](#)
- [MLMotionRstErr](#)
- [MLMotionStart](#)

5.2.0.10.4 Examples

5.2.0.10.4.1 Structured Text

```

Inst_MLFB_ECAtRestart( Restart, ResetErrors );
IF Inst_MLFB_ECAtRestart.oDONE THEN
    RestartComplte:=1;
End_IF;
    
```

5.2.0.10.4.2 Ladder Diagram

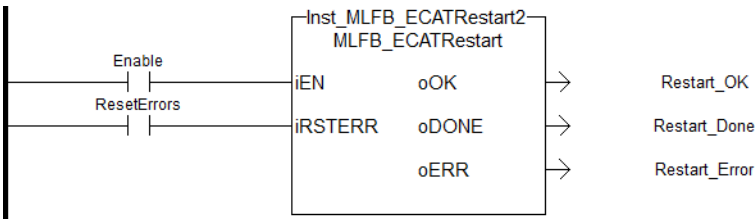

5.2.0.10.4.3 Function Block Diagram

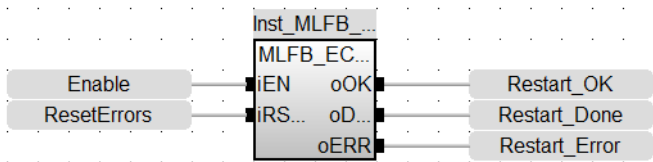

5.2.0.11 MLFB_HomeFindHomeInput Pipe Network ✓

5.2.0.11.1 Description

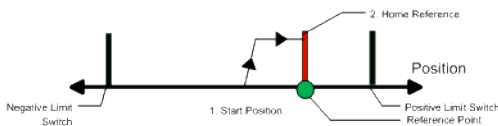

The motor starts to move according to the direction setting. The home position has been found as soon as the home-switch becomes active during a motion in direction of the direction setting. The command position of the drive will immediately be set to the position value and the motor ramps down to velocity 0. The hardware limit switches are monitored during the homing procedure. The drive behaves as follows in case that a hardware limit switch is active before the home-switch has been activated: The motor changes the direction until the home switch is crossed. The motor ramps down to zero velocity and reverses direction again after crossing the home-switch. The home-switch will now be activated according to the direction setting and the home-position has been found. The command position of the drive will immediately be set to the position value and the motor ramps down to zero velocity.

5.2.0.11.2 Arguments

5.2.0.11.2.1 Input

ibExecute	Description	Start homing, edge-triggered
	Data type	BOOL

iAxisID	Description	ID of Axis block of Pipe Network
	Data type	DINT
iPosition	Description	Reference position
	Data type	LREAL
ibDirection	Description	0=positive, 1=negative
	Data type	BOOL
iVelocity	Description	Reference speed
	Data type	LREAL
iAcceleration	Description	Reference acceleration
	Data type	LREAL
iDeceleration	Description	Reference deceleration
	Data type	LREAL
ibHomeInput	Description	Home input, high-active
	Data type	BOOL
ibPosLimitSwitch	Description	Positive limit switch, high-active
	Data type	BOOL
ibNegLimitSwitch	Description	Negative limit switch, high-active
	Data type	BOOL
iTimeout	Description	Time monitoring (T#0ms: off)
	Data type	TIME

5.2.0.11.2.2 Output

obDone	Description	Done bit												
	Data type	BOOL												
obActive	Description	Active bit												
	Data type	BOOL												
obError	Description	Error bit												
	Data type	BOOL												
oErrorID	Description	Error identifier, see list here												
		<table border="1"> <thead> <tr> <th>ErrorID</th> <th>Description</th> </tr> </thead> <tbody> <tr> <td>1</td> <td>Axis in error</td> </tr> <tr> <td>2</td> <td>Axis not enabled</td> </tr> <tr> <td>3</td> <td>Timeout expired</td> </tr> <tr> <td>4</td> <td>SDO read/write error</td> </tr> <tr> <td>5</td> <td>Input parameter out of range</td> </tr> </tbody> </table>	ErrorID	Description	1	Axis in error	2	Axis not enabled	3	Timeout expired	4	SDO read/write error	5	Input parameter out of range
ErrorID	Description													
1	Axis in error													
2	Axis not enabled													
3	Timeout expired													
4	SDO read/write error													
5	Input parameter out of range													

Data type DINT

5.2.0.11.3 Example

5.2.0.11.3.1 ST

```

//Call homing function on Axis1 with preset velocity, accel, and decel
values
//Start in negative direction, change if limit switch seen before home
switch
//after seeing home switch, set axis position to zero
Inst_MLFB_HomeFindHomeInput( StartHomeRoutine,
    PipeNetwork.AXIS1,
    0,
    TRUE,
    100,
    1000,
    1000,
    HomeDigitalInput,
    PositiveLimitSwitch,
    NegativeLimitSwitch,
    T#30s );

HomeDone := Inst_MLFB_HomeFindHomeInput.obDone;
    
```

5.2.0.11.3.2 Function Block Diagram

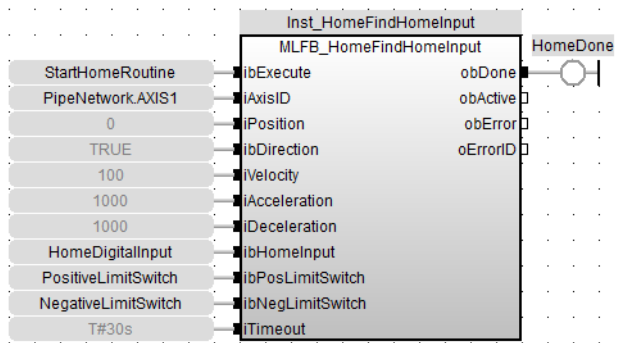

5.2.0.11.3.3 FFLD

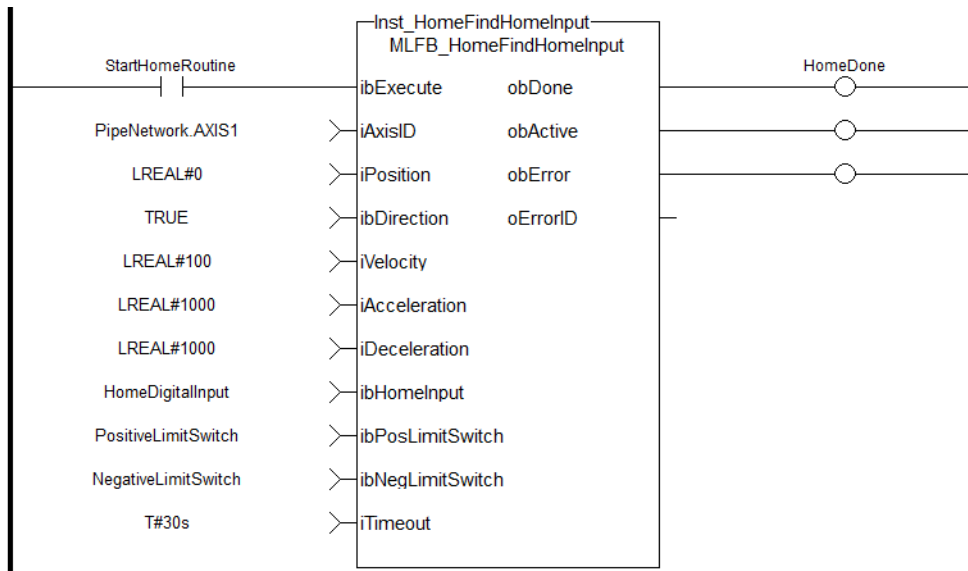

5.2.0.12 MLFB_HomeFindHomeInputThenZeroAngle Pipe Network ✓

5.2.0.12.1 Description

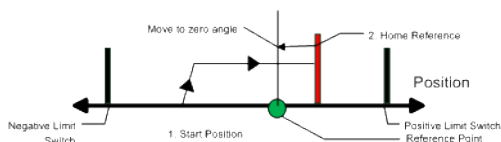

Similar to the Find Home Limit method, the find input home then find zero angle. Mode follows the same steps, but upon completion of the move, it continues to move to find the zero angle reference of the motor.

5.2.0.12.2 Arguments

5.2.0.12.2.1 Input

ibExecute	Description	Start homing, edge-triggered
	Data type	BOOL
iAxisID	Description	ID of Axis block of Pipe Network
	Data type	DINT
iPosition	Description	Reference position
	Data type	LREAL
ibDirection	Description	0=positive, 1=negative
	Data type	BOOL
iVelocity	Description	Reference speed
	Data type	LREAL
iAcceleration	Description	Reference acceleration
	Data type	LREAL
iDeceleration	Description	Reference deceleration

	Data type	LREAL
ibHomeInput	Description	Home input, high-active
	Data type	BOOL
ibPosLimitSwitch	Description	Positive limit switch, high-active
	Data type	BOOL
ibNegLimitSwitch	Description	Negative limit switch, high-active
	Data type	BOOL
iTimeout	Description	Time monitoring (T#0ms: off)
	Data type	TIME

5.2.0.12.2.2 Output

obDone	Description	Done bit												
	Data type	BOOL												
obActive	Description	Active bit												
	Data type	BOOL												
obError	Description	Error bit												
	Data type	BOOL												
oErrorID	Description	Error identifier, see list here												
		<table border="1"> <thead> <tr> <th>ErrorID</th> <th>Description</th> </tr> </thead> <tbody> <tr> <td>1</td> <td>Axis in error</td> </tr> <tr> <td>2</td> <td>Axis not enabled</td> </tr> <tr> <td>3</td> <td>Timeout expired</td> </tr> <tr> <td>4</td> <td>SDO read/write error</td> </tr> <tr> <td>5</td> <td>Input parameter out of range</td> </tr> </tbody> </table>	ErrorID	Description	1	Axis in error	2	Axis not enabled	3	Timeout expired	4	SDO read/write error	5	Input parameter out of range
ErrorID	Description													
1	Axis in error													
2	Axis not enabled													
3	Timeout expired													
4	SDO read/write error													
5	Input parameter out of range													
	Data type	DINT												

5.2.0.12.3 Example

5.2.0.12.3.1 ST

```

//Call homing function on Axis1 with preset velocity, accel, and decel
values
//Start in negative direction, change if limit switch seen before home
switch
//after seeing home switch and moving to zero angle, set axis position to
zero
Inst_MLFB_HomeFindHomeInputThenZeroAngle( StartHomeRoutine,
    PipeNetwork.AXIS1,
    0,
    TRUE,
    100,
    1000,

```

```

1000,
HomeDigitalInput,
PositiveLimitSwitch,
NegativeLimitSwitch,
T#30s );

HomeDone := Inst_MLFB_HomeFindHomeInputThenZeroAngle.obDone;
    
```

5.2.0.12.3.2 Function Block Diagram

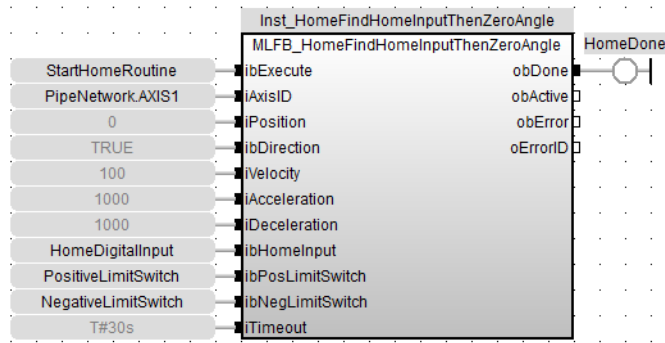

5.2.0.12.3.3 FFLD

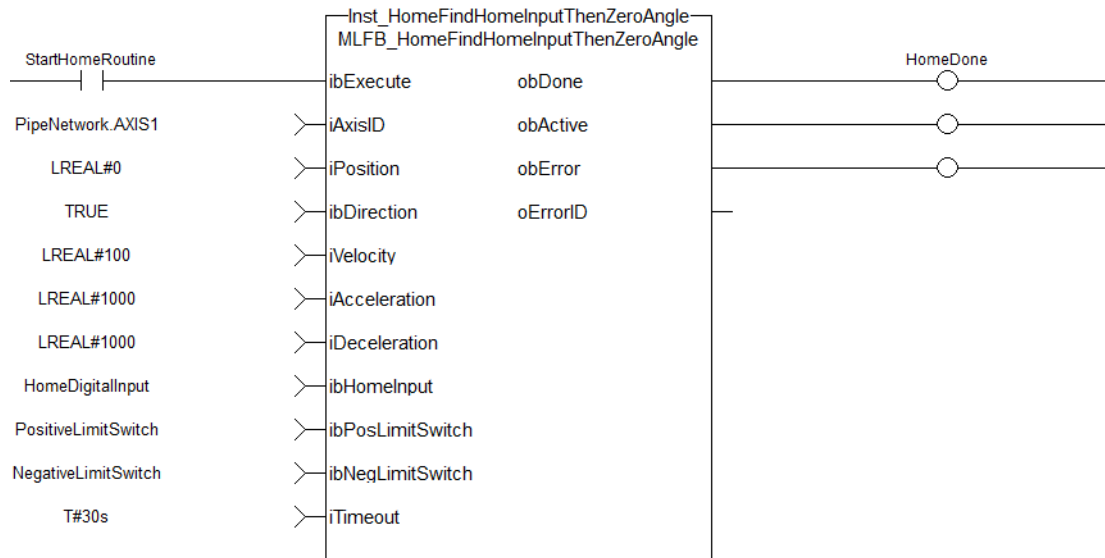

5.2.0.13 MLFB_HomeFindLimitInput Pipe Network ✓

5.2.0.13.1 Description

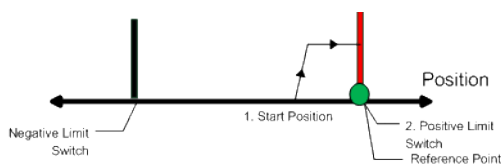

The find limit input mode moves to a limit input. This method can be used if you have a positive or negative limit switch available that you want to establish as a home reference point.

5.2.0.13.2 Arguments

5.2.0.13.2.1 Input

ibExecute	Description	Start homing, edge-triggered
	Data type	BOOL
iAxisID	Description	ID of Axis block of Pipe Network
	Data type	DINT
iPosition	Description	Reference position
	Data type	LREAL
ibDirection	Description	0=positive, 1=negative
	Data type	BOOL
iVelocity	Description	Reference speed
	Data type	LREAL
iAcceleration	Description	Reference acceleration
	Data type	LREAL
iDeceleration	Description	Reference deceleration
	Data type	LREAL
ibLimitSwitch	Description	Pos. or neg. limit switch, high-active (depends on ibDirection)
	Data type	BOOL
iTimeout	Description	Time monitoring (T#0ms: off)
	Data type	TIME

5.2.0.13.2.2 Output

obDone	Description	Done bit
	Data type	BOOL
obActive	Description	Active bit
	Data type	BOOL
obError	Description	Error bit
	Data type	BOOL
oErrorID	Description	Error identifier, see list here
	Data type	DINT

ErrorID	Description
1	Axis in error
2	Axis not enabled
3	Timeout expired
4	SDO read/write error
5	Input parameter out of range

5.2.0.13.3 Example

5.2.0.13.3.1 ST

```

//Call homing function on Axis1 with preset velocity, accel, and decel
values
//Start in negative direction and stop when axis hits limit switch or
times out
//after seeing limit switch, set axis position to zero
Inst_MLFB_HomeFindLimitInput( StartHomeRoutine,
    PipeNetwork.AXIS1,
    0,
    TRUE,
    100,
    1000,
    1000,
    HomeDigitalInput,
    T#30s );

HomeDone := Inst_MLFB_HomeFindLimitInput.obDone;
    
```

5.2.0.13.3.2 Function Block Diagram

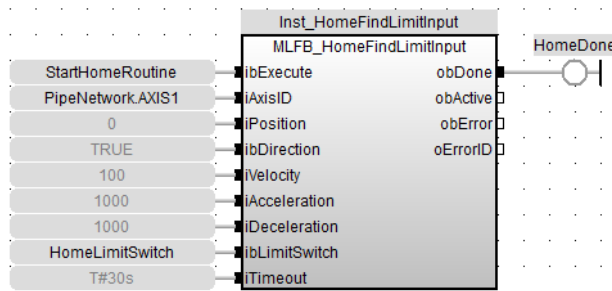

5.2.0.13.3.3 FFLD

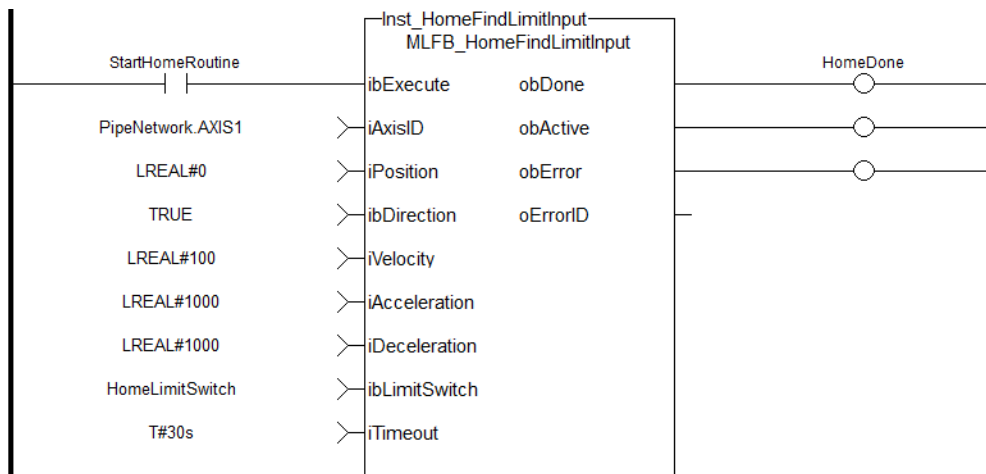

5.2.0.14 MLFB_HomeFindLimitInputThenZeroAngle Pipe Network ✓

5.2.0.14.1 Description

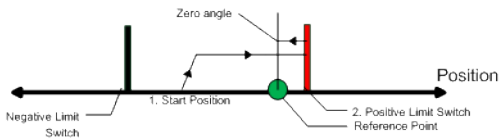

Similar to the Find Input Limit method, the find input limit then find zero angle. Mode follows the same steps, but upon completion of the move, it continues to move to find the zero angle reference of the motor.

5.2.0.14.2 Arguments

5.2.0.14.2.1 Input

ibExecute	Description Data type	Start homing, edge-triggered BOOL
iAxisID	Description Data type	ID of Axis block of Pipe Network BOOL
iPosition	Description Data type	Reference position BOOL
ibDirection	Description Data type	0=positive, 1=negative BOOL
iVelocity	Description Data type	Reference speed BOOL
iAcceleration	Description Data type	Reference acceleration BOOL
iDeceleration	Description Data type	Reference deceleration BOOL
ibLimitSwitch	Description Data type	Pos. or neg. limit switch, high-active (depends on ibDirection) BOOL
iTimeout	Description Data type	Time monitoring (T#0ms: off) BOOL

5.2.0.14.2.2 Output

obDone	Description Data type	Done bit BOOL
obActive	Description Data type	Active bit BOOL
obError	Description Data type	Error bit BOOL

Error identifier, see list here

oErrorID	Description	ErrorID Description	
		1	Axis in error
		2	Axis not enabled
		3	Timeout expired
		4	SDO read/write error
		5	Input parameter out of range
	Data type	DINT	

5.2.0.14.3 Example

5.2.0.14.3.1 ST

```

//Call homing function on Axis1 with preset velocity, accel, and decel
values
//Start in negative direction and stop when axis hits limit switch or
times out
//after seeing limit switch, moves to zero angle and set axis position to
zero
Inst_MLFB_HomeFindLimitInputThenZeroAngle( StartHomeRoutine,
PipeNetwork.AXIS1,
0,
TRUE,
100,
1000,
1000,
HomeDigitalInput,
T#30s );

HomeDone := Inst_MLFB_HomeFindLimitInputThenZeroAngle.obDone;
    
```

5.2.0.14.3.2 Function Block Diagram

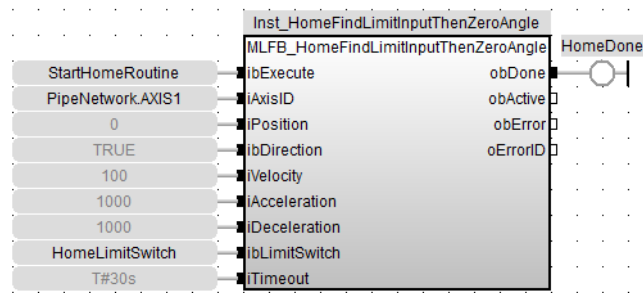

5.2.0.14.3.3 FFLD

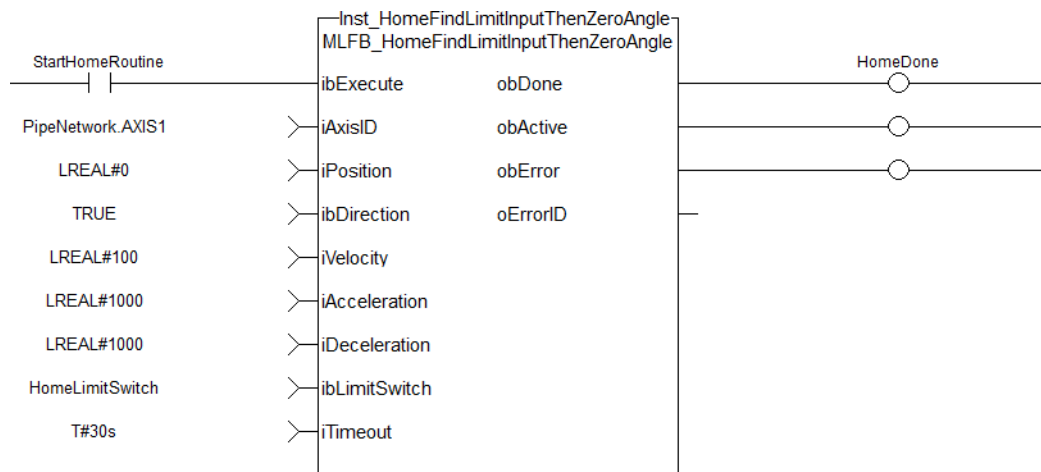

5.2.0.15 MLFB_HomeFindZeroAngle Pipe Network ✓

5.2.0.15.1 Description

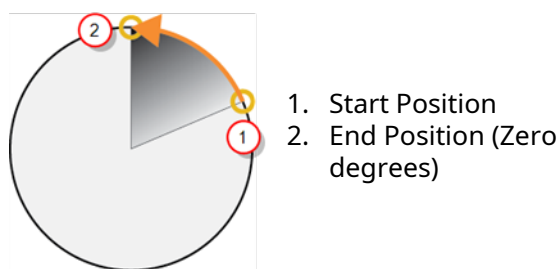

Figure 1-177: Mode to find the zero angle reference of the motor.

NOTE

This function block is only applicable to motors with Resolver or SFD feedback.

5.2.0.15.2 Arguments

5.2.0.15.2.1 Input

ibExecute	Description	Start homing, edge-triggered
	Data type	BOOL
iAxisID	Description	ID of Axis block of Pipe Network
	Data type	DINT
iPosition	Description	Reference position
	Data type	LREAL
iDirectionType	Description	0=positive, 1=negative, 2=shortest
	Data type	DINT
iVelocity	Description	Reference speed
	Data type	LREAL
iAcceleration	Description	Reference acceleration
	Data type	LREAL
iDeceleration	Description	Reference deceleration
	Data type	LREAL
iTimeout	Description	Time monitoring (T#0ms: off)
	Data type	TIME

5.2.0.15.2.2 Output

obDone	Description	Done bit
	Data type	BOOL
obActive	Description	Active bit
	Data type	BOOL
obError	Description	Error bit

	Data type	BOOL											
oErrorID	Description	Error identifier, see list here											
		<table border="1"> <thead> <tr> <th>ErrorID</th> <th>Description</th> </tr> </thead> <tbody> <tr> <td>1</td> <td>Axis in error</td> </tr> <tr> <td>2</td> <td>Axis not enabled</td> </tr> <tr> <td>3</td> <td>Timeout expired</td> </tr> <tr> <td>4</td> <td>SDO read/write error</td> </tr> <tr> <td>5</td> <td>Input parameter out of range</td> </tr> </tbody> </table>	ErrorID	Description	1	Axis in error	2	Axis not enabled	3	Timeout expired	4	SDO read/write error	5
	ErrorID	Description											
	1	Axis in error											
	2	Axis not enabled											
	3	Timeout expired											
4	SDO read/write error												
5	Input parameter out of range												
Data type	DINT												

5.2.0.15.3 Example

5.2.0.15.3.1 ST

```

//Call homing function on Axis1 with preset velocity, accel, and decel
values
//Start in negative direction and go to zero angle or time out
//after reaching zero angle set axis position to zero
Inst_MLFB_HomeFindZeroAngle( StartHomeRoutine,
PipeNetwork.AXIS1,
0,
1,
100,
1000,
1000,
T#30s );

HomeDone := Inst_MLFB_HomeFindZeroAngle.obDone;

```

5.2.0.15.3.2 Function Block Diagram

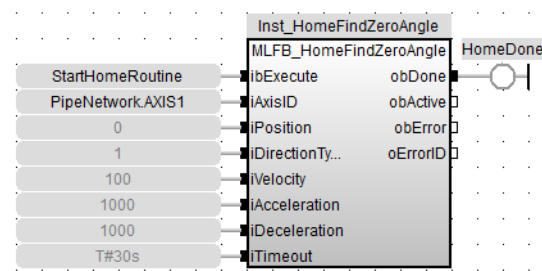

5.2.0.15.3.3 FFLD

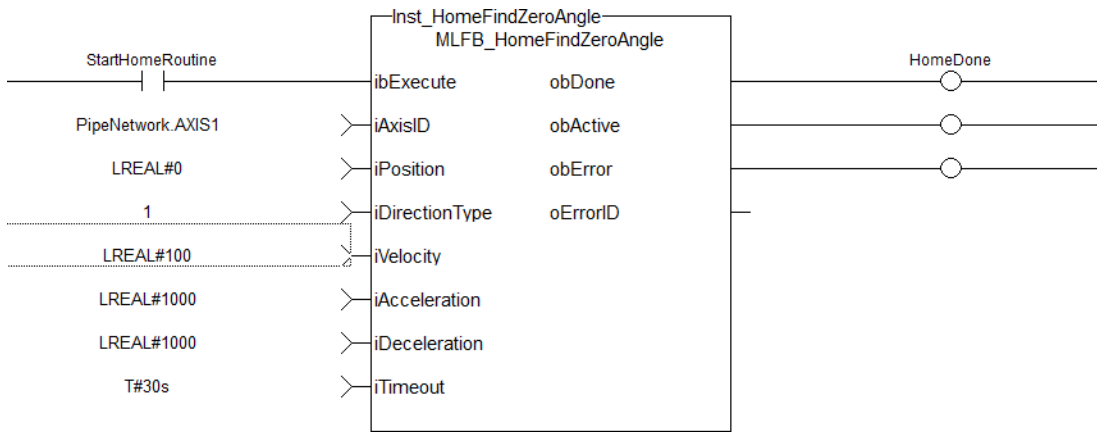

5.2.0.16 MLFB_HomeMoveUntilPosErrExceeded Pipe Network ✓

5.2.0.16.1 Description

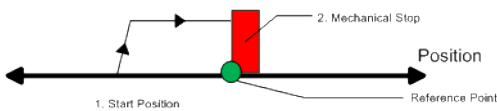

When executed, the motor will move to the hard stop with a definable peak current. When the position error exceeds, the home Position is set.

5.2.0.16.2 Arguments

5.2.0.16.2.1 Input

ibExecute	Description	Start homing, edge-triggered
	Data type	BOOL
iAxisID	Description	ID of Axis block of Pipe Network
	Data type	DINT
iPosition	Description	Reference position
	Data type	LREAL
ibDirection	Description	0=positive, 1=negative
	Data type	BOOL
iVelocity	Description	Reference speed
	Data type	LREAL
iAcceleration	Description	Reference acceleration
	Data type	LREAL
iDeceleration	Description	Reference deceleration
	Data type	LREAL
iMaxPositionError	Description	Maximum position error
	Data type	LREAL
iPeakCurrent	Description	Peak current in mA
	Data type	DINT
iTimeout	Description	Time monitoring (T#0ms: off)
	Data type	TIME

5.2.0.16.2.2 Output

obDone	Description	Done bit
	Data type	BOOL
obActive	Description	Active bit
	Data type	BOOL
obError	Description	Error bit
	Data type	BOOL

Error identifier, see list here

oErrorID	Description	ErrorID Description	
		1	Axis in error
		2	Axis not enabled
		3	Timeout expired
		4	SDO read/write error
		5	Input parameter out of range
	Data type	DINT	

5.2.0.16.3 Example

5.2.0.16.3.1 ST

```

//Call homing function on Axis1 with preset velocity, accel, and decel
values
//Start in negative direction and go until position error exceeds input
value or time out
//afterterwards set axis position to zero
//function block temporarily writes new max current value to 2 Amp while
home routine active
Inst_MLFB_HomeMoveUntilPosErrExceeded( StartHomeRoutine,
    PipeNetwork.AXIS1,
    0,
    1,
    100,
    1000,
    1000,
    MaxPosError,
    2000,
    T#30s );

HomeDone := Inst_MLFB_HomeMoveUntilPosErrExceeded.obDone;
    
```

5.2.0.16.3.2 Function Block Diagram

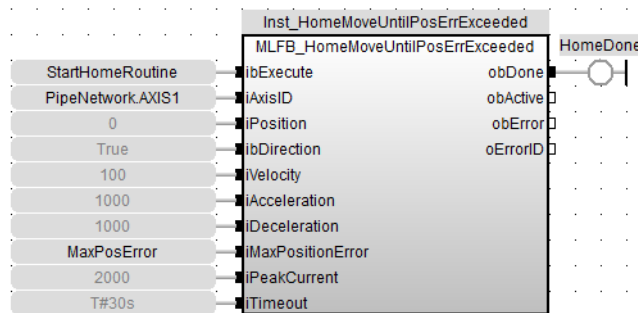

5.2.0.16.3.3 FFLD

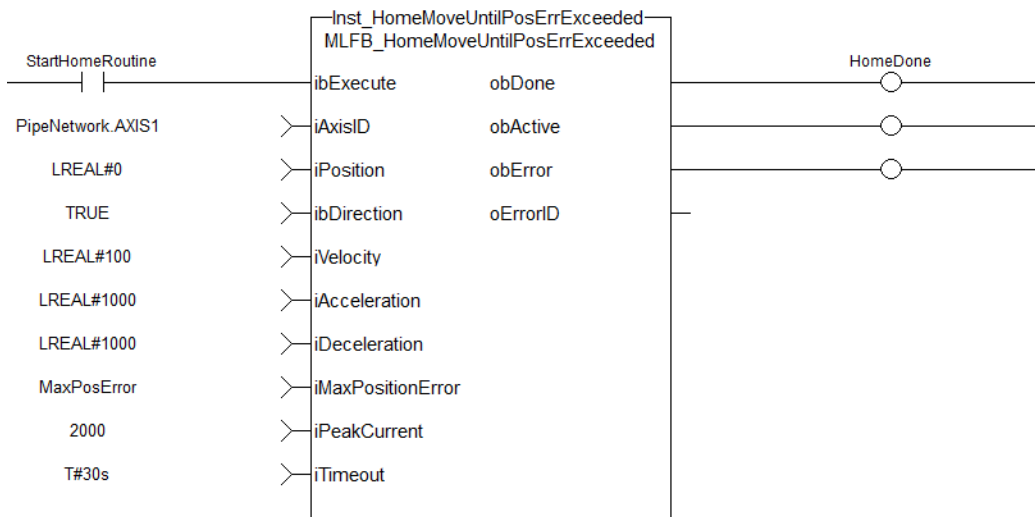

5.2.0.17 MLFB_HomeMoveUntilPosErrExceededThenZeroAngle Pipe Network ✓

5.2.0.17.1 Description

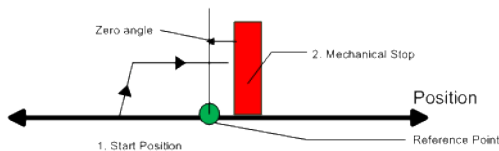

Similar to the Move Until Position Error Exceeded method, the move until position error exceeded then find zero angle. Mode follows the same steps, but upon completion of the move, it continues to move to find the zero angle reference of the motor.

5.2.0.17.2 Arguments

5.2.0.17.2.1 Input

ibExecute	Description	Start homing, edge-triggered
	Data type	BOOL
iAxisID	Description	ID of Axis block of Pipe Network
	Data type	DINT
iPosition	Description	Reference position
	Data type	LREAL
ibDirection	Description	0=positive, 1=negative
	Data type	BOOL
iVelocity	Description	Reference speed
	Data type	LREAL
iAcceleration	Description	Reference acceleration
	Data type	LREAL
iDeceleration	Description	Reference deceleration

	Data type	LREAL
iMaxPositionError	Description	Maximum position error
	Data type	LREAL
iPeakCurrent	Description	Peak current in mA
	Data type	DINT
iTimeout	Description	Time monitoring (T#0ms: off)
	Data type	TIME

5.2.0.17.2.2 Output

obDone	Description	Done bit												
	Data type	BOOL												
obActive	Description	Active bit												
	Data type	BOOL												
obError	Description	Error bit												
	Data type	BOOL												
oErrorID	Description	Error identifier, see list here												
		<table border="1"> <thead> <tr> <th>ErrorID</th> <th>Description</th> </tr> </thead> <tbody> <tr> <td>1</td> <td>Axis in error</td> </tr> <tr> <td>2</td> <td>Axis not enabled</td> </tr> <tr> <td>3</td> <td>Timeout expired</td> </tr> <tr> <td>4</td> <td>SDO read/write error</td> </tr> <tr> <td>5</td> <td>Input parameter out of range</td> </tr> </tbody> </table>	ErrorID	Description	1	Axis in error	2	Axis not enabled	3	Timeout expired	4	SDO read/write error	5	Input parameter out of range
ErrorID	Description													
1	Axis in error													
2	Axis not enabled													
3	Timeout expired													
4	SDO read/write error													
5	Input parameter out of range													
	Data type	DINT												

5.2.0.17.3 Example

5.2.0.17.3.1 ST

```
//Call homing function on Axis1 with preset velocity, accel, and decel
values
//Start in negative direction and go until position error exceeds input
value or time out
//afterterwards moves to zero angle and sets axis position to zero
//function block temporarily writes new max current value to 2 Amp while
home routine active
Inst_MLFB_HomeMoveUntilPosErrExceededThenZeroAngle( StartHomeRoutine,
PipeNetwork.AXIS1,
0,
1,
100,
1000,
1000,
MaxPosError,
```

```

2000,
T#30s );

HomeDone := Inst_MLFB_HomeMoveUntilPosErrExceededThenZeroAngle.obDone;
    
```

5.2.0.17.3.2 Function Block Diagram

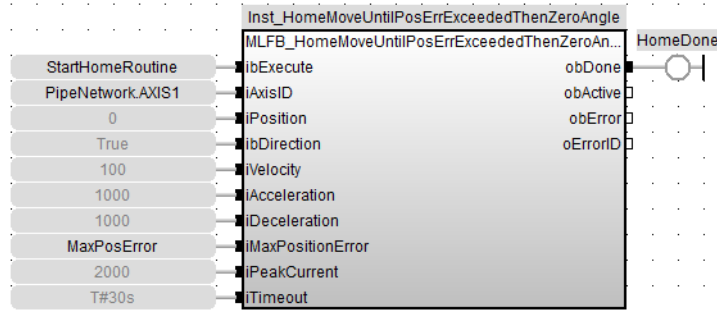

5.2.0.17.3.3 FFLD

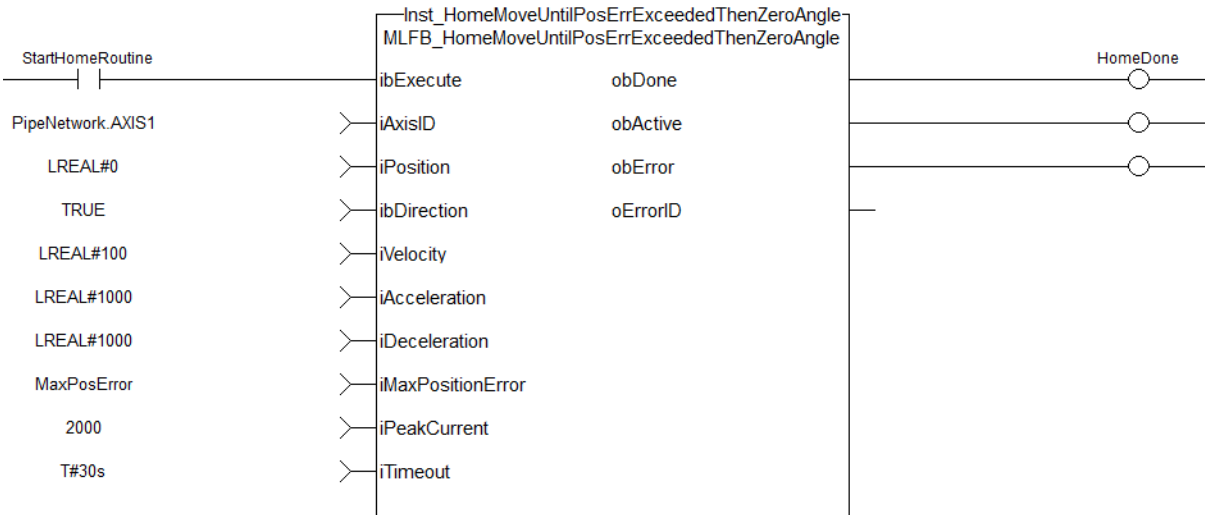

5.2.0.18 MLFB_HomeUsingCurrentPosition Pipe Network ✓

5.2.0.18.1 Description

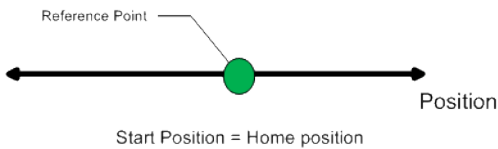

Using the current position is the most basic homing method. This method simply uses the current position of the motor as the home point reference.

You can use this parameter to set the value of the home position other than zero. This allows you to offset your home reference away from zero.

5.2.0.18.2 Arguments

5.2.0.18.2.1 Input

ibExecute	Description	Start homing, edge-triggered
	Data type	BOOL

iAxisID	Description	ID of Axis block of Pipe Network
	Data type	DINT
iPosition	Description	Reference position
	Data type	LREAL

5.2.0.18.2.2 Output

obDone	Description	Done bit
	Data type	BOOL
obActive	Description	Active bit
	Data type	BOOL
obError	Description	Error bit
	Data type	BOOL

Error identifier, see list here

oErrorID	Description	ErrorID	Description
		1	Axis in error
		2	Axis not enabled
		3	Timeout expired
		4	SDO read/write error
		5	Input parameter out of range
	Data type	DINT	

5.2.0.18.3 Example

5.2.0.18.3.1 ST

```
//No movement, set current axis position to position input in this case zero
Inst_MLFB_HomeUsingCurrentPosition( StartHomeRoutine, PipeNetwork.AXIS1,
0 );
HomeDone := Inst_MLFB_HomeUsingCurrentPosition.obDone;
```

5.2.0.18.3.2 Function Block Diagram

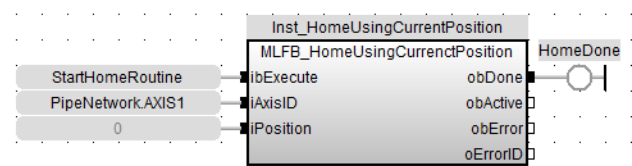

5.2.0.18.3.3 FFLD

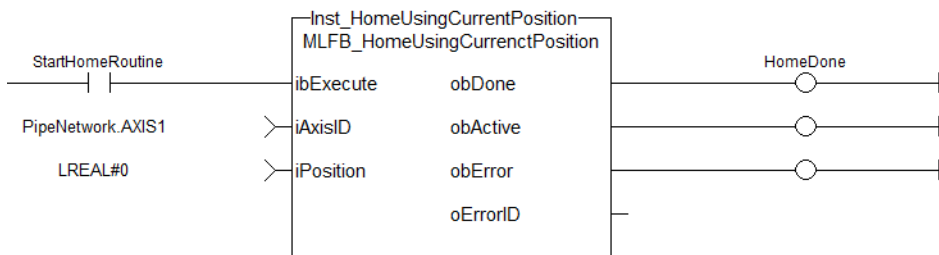

5.2.0.19 MLFB_HomeFindHomeFastInput Pipe Network ✓

5.2.0.19.1 Description

This function block performs a single-axis home to a limit switch connected to a High Speed Input. The motor starts to move according to the direction setting. The home position has been found as soon as the fast input selected is triggered on the edge selected.

An absolute move is made to the triggered position, and then the position value is set. The hardware limit switches are monitored during the homing procedure.

The drive behaves as follows in case that a hardware limit switch is active before the home-switch has been activated: The motor changes the direction until the home switch is crossed.

The following figure shows the function block I/O:

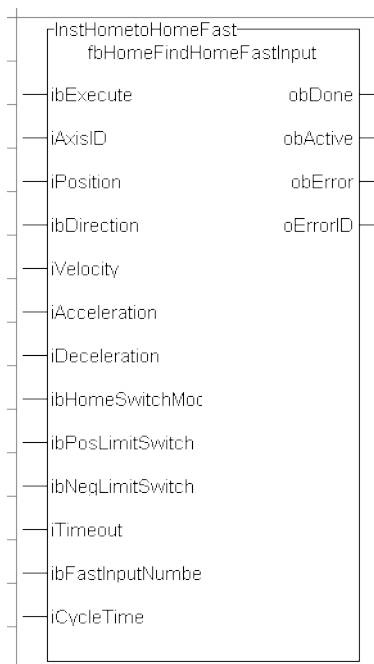

Figure 1-178: MLFB HomeFindHomeFastInput

5.2.0.19.2 Arguments

5.2.0.19.2.1 Input

ibExecute	Description	Request the homing step procedure at rising edge
	Data type	BOOL
	Range	[0 , 1]
	Unit	N/A
	Default	—
iAxisID	Description	Name of a declared instance of the AXIS_REF library function
	Data type	AXIS_REF
	Range	[1 , 256]
	Unit	N/A
	Default	—

iPosition	Description	Offset Position Applied After Home Switch is found						
	Data type	LREAL						
	Range	—						
	Unit	User unit						
	Default	—						
ibDirection	Description	Define the axis homing direction						
		<table border="1"> <thead> <tr> <th>Value</th> <th>Description</th> </tr> </thead> <tbody> <tr> <td>0</td> <td>clockwise rotation</td> </tr> <tr> <td>1</td> <td>counterclockwise rotation</td> </tr> </tbody> </table>	Value	Description	0	clockwise rotation	1	counterclockwise rotation
	Value	Description						
	0	clockwise rotation						
	1	counterclockwise rotation						
Data type	BOOL							
Range	[0 , 1]							
Unit	N/A							
Default	—							
iVelocity	Description	Commanded velocity for the homing move						
	Data type	LREAL						
	Range	—						
	Unit	User unit/sec						
	Default	—						
iAcceleration	Description	Commanded acceleration for the homing move						
	Data type	LREAL						
	Range	—						
	Unit	User unit/sec ²						
	Default	—						
iDeceleration	Description	Commanded deceleration for the homing move						
	Data type	LREAL						
	Range	—						
	Unit	User unit/sec ²						
	Default	—						
ibHomeSwitchMode	Description	Limit switch state to complete homing						
		<table border="1"> <thead> <tr> <th>Value</th> <th>Description</th> </tr> </thead> <tbody> <tr> <td>0</td> <td>Rising edge of switch</td> </tr> <tr> <td>1</td> <td>Falling edge of switch</td> </tr> </tbody> </table>	Value	Description	0	Rising edge of switch	1	Falling edge of switch
	Value	Description						
	0	Rising edge of switch						
	1	Falling edge of switch						

	Data type	BOOL						
	Range	[0 , 1]						
	Unit	N/A						
	Default	—						
ibPosLimitSwitch	Description	The positive direction limit switch input I/O point						
	Data type	BOOL						
	Range	[0 , 1]						
	Unit	N/A						
	Default	—						
ibNegLimitSwitch	Description	The negative direction limit switch input I/O point						
	Data type	BOOL						
	Range	[0 , 1]						
	Unit	N/A						
	Default	—						
iTimeout	Description	Maximum time for homing move to complete. If exceeded the homing procedure will error out. 0= no time limit						
	Data type	TIME						
	Range	—						
	Unit	sec						
	Default	—						
ibFastInputNumber	Description	Limit switch state to complete homing.						
		<table border="1"> <thead> <tr> <th>Value</th> <th>Description</th> </tr> </thead> <tbody> <tr> <td>0</td> <td>Fast Input Number 1</td> </tr> <tr> <td>1</td> <td>Fast Input Number 2</td> </tr> </tbody> </table>	Value	Description	0	Fast Input Number 1	1	Fast Input Number 2
Value	Description							
0	Fast Input Number 1							
1	Fast Input Number 2							
	Data type	BOOL						
	Range	[0 , 1]						
	Unit	N/A						
	Default	—						
iCycleTime	Description	Ethercat Cycle Time 250, 500 or 1000						
	Data type	LREAL						
	Range	—						
	Unit	microseconds						
	Default	—						

5.2.0.19.2.2 Output

obDone	Description	Indicates the move completed successfully. The Command Position has reached the endpoint												
	Data type	BOOL												
	Unit	N/A												
obActive	Description	Indicates this move is the active move												
	Data type	BOOL												
	Unit	N/A												
obError	Description	Indicates an invalid input was specified or the move was terminated due to an error												
	Data type	BOOL												
	Unit	N/A												
oErrorID	Description	Indicates the error if Error output is set to TRUE												
		<table border="1"> <thead> <tr> <th>Value</th> <th>Description</th> </tr> </thead> <tbody> <tr> <td>1</td> <td>Axis in Error State</td> </tr> <tr> <td>2</td> <td>Axis is Not Enabled</td> </tr> <tr> <td>3</td> <td>Timeout Exceeded</td> </tr> <tr> <td>4</td> <td>SDO Read/Write Error</td> </tr> <tr> <td>5</td> <td>Input Parameter out of Range</td> </tr> </tbody> </table>	Value	Description	1	Axis in Error State	2	Axis is Not Enabled	3	Timeout Exceeded	4	SDO Read/Write Error	5	Input Parameter out of Range
	Value	Description												
1	Axis in Error State													
2	Axis is Not Enabled													
3	Timeout Exceeded													
4	SDO Read/Write Error													
5	Input Parameter out of Range													
Data type	DINT													
Unit	N/A													

5.2.0.19.3 Usage

This homing procedure performs a homing function searching for sensor using only High Speed Input Switches. (A High Speed Limit Switch has 1 "Off" (or "On") area).

- Home is commanded by user in the desired homing direction at the selected Velocity
- If LimitSwitch is found 'On' on rising 'Execute', then the process is started in the opposite direction as specified, LimitSwitch is search for 'Off' (or On, depending on LimitSwitchMode setting) Edge (released), and process is restarted again in original direction. This ensures that the end conditions are always the same
- The Timeout can cause an error if exceeded

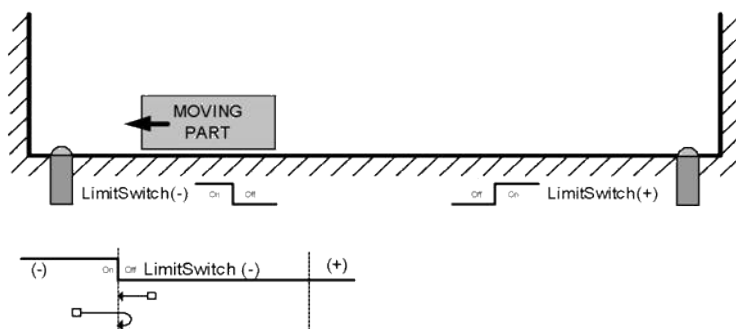

5.2.0.19.4 Related Functions

[MLFB_HomeFindHomeFastInputModulo](#)

[MLFB_HomeFindLimitFastInput](#)

[MLFB_HomeFindLimitFastInputModulo](#)

5.2.0.19.5 Example

5.2.0.19.5.1 Structured Text

```

Direction:= 0;
Position:=1000;
Velocity:=1000;
Acceleration:=10000;
Deceleration:=10000;
SwitchMode:=0;
Timeout:=T#100;
FastInputNumber:=0;
CycleTime:=1000;

inst_fbHomeFindHomeFastInput(True, Axis1, Position, Direction,
Velocity, Acceleration, Deceleration, HomeSwitchMode,
PosLimitSwitch, NegLimitSwitch, Timeout, FastInputNumber,
CycleTime);

HomeComplete :=inst_fbHomeFindHomeFastInput.Done;
HomeActive :=inst_fbHomeFindHomeFastInput.Active;
HomeError :=inst_fbHomeFindHomeFastInput.Error;
HomeErrorID :=inst_fbHomeFindHomeFastInput.ErrorID;

(* PosLimitSwitch and NegLimitSwtch are declared I/O points *)

```

5.2.0.19.5.2 Ladder Diagram

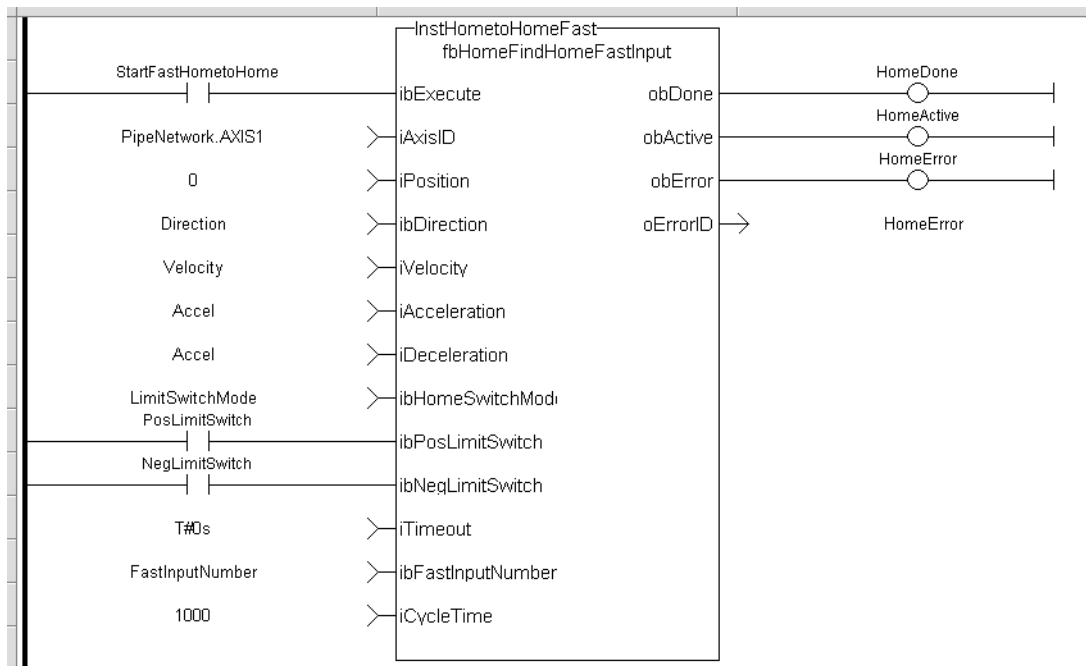

5.2.0.19.5.3 Function Block Diagram

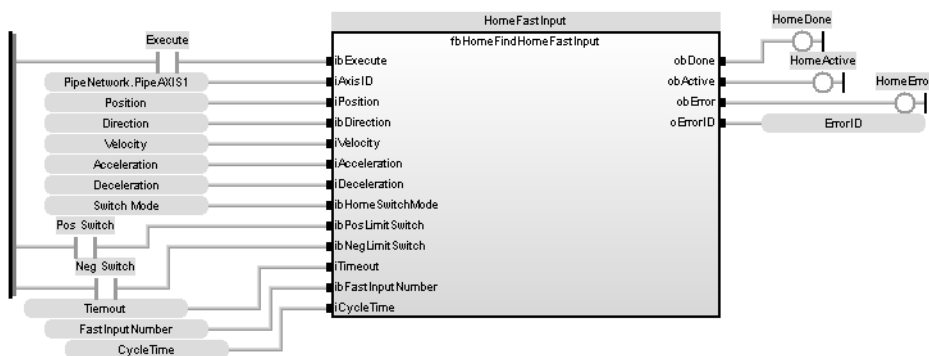

5.2.0.20 MLFB_HomeFindHomeFastInputModulo Pipe Network ✓

5.2.0.20.1 Description

This Application Specific Function function block performs a single-axis home to a limit switch connected to a High Speed Input. The motor starts to move according to the direction setting. The home position has been found as soon as the fast input selected is triggered on the edge selected.

An absolute move is made to the triggered position, and then the position value is set. The hardware limit switches are monitored during the homing procedure.

The drive behaves as follows in case that a hardware limit switch is active before the home-switch has been activated: The motor changes the direction until the home switch is crossed. This function is to be used when the axis is set-up in Modulo mode.

The following figure shows the function block I/O:

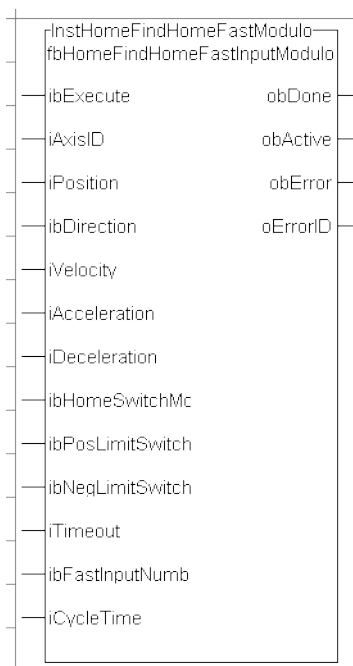

Figure 1-179: MLFB HomeFindHomeFastInputModulo

5.2.0.20.2 Arguments

5.2.0.20.2.1 Input

ibExecute	Description	Request the homing step procedure at rising edge
	Data type	BOOL
	Range	[0 , 1]
	Unit	N/A
	Default	—
iAxisID	Description	Name of a declared instance of the AXIS_REF library function
	Data type	AXIS_REF
	Range	[1 , 256]
	Unit	N/A
	Default	—
iPosition	Description	Offset Position Applied After Home Switch is found
	Data type	LREAL
	Range	—
	Unit	User unit
	Default	—

ibDirection	Description	Define the axis homing direction						
		<table border="1"> <thead> <tr> <th>Value</th> <th>Description</th> </tr> </thead> <tbody> <tr> <td>0</td> <td>clockwise rotation</td> </tr> <tr> <td>1</td> <td>counterclockwise rotation</td> </tr> </tbody> </table>	Value	Description	0	clockwise rotation	1	counterclockwise rotation
	Value	Description						
	0	clockwise rotation						
	1	counterclockwise rotation						
Data type	BOOL							
Range	[0, 1]							
Unit	N/A							
	Default	—						
iVelocity	Description	Commanded velocity for the homing move						
	Data type	LREAL						
	Range	—						
	Unit	User unit/sec						
	Default	—						
iAcceleration	Description	Commanded acceleration for the homing move						
	Data type	LREAL						
	Range	—						
	Unit	User unit/sec ²						
	Default	—						
iDeceleration	Description	Commanded deceleration for the homing move						
	Data type	LREAL						
	Range	—						
	Unit	User unit/sec ²						
	Default	—						
ibLimitSwitchMode	Description	Limit switch state to complete homing						
		<table border="1"> <thead> <tr> <th>Value</th> <th>Description</th> </tr> </thead> <tbody> <tr> <td>0</td> <td>Rising edge of switch</td> </tr> <tr> <td>1</td> <td>Falling edge of switch</td> </tr> </tbody> </table>	Value	Description	0	Rising edge of switch	1	Falling edge of switch
	Value	Description						
	0	Rising edge of switch						
	1	Falling edge of switch						
Data type	BOOL							
Range	[0, 1]							
Unit	N/A							
	Default	—						
ibPosLimitSwitch	Description	The positive direction limit switch input I/O point						

	Data type	BOOL						
	Range	[0 , 1]						
	Unit	N/A						
	Default	—						
ibNegLimitSwitch	Description	The negative direction limit switch input I/O point						
	Data type	BOOL						
	Range	[0 , 1]						
	Unit	N/A						
	Default	—						
iTimeout	Description	Maximum time for homing move to complete. If exceeded the homing procedure will error out. 0= no time limit						
	Data type	TIME						
	Range	—						
	Unit	sec						
	Default	—						
ibFastInputNumber	Description	Limit switch state to complete homing.						
		<table border="1"> <thead> <tr> <th>Value</th> <th>Description</th> </tr> </thead> <tbody> <tr> <td>0</td> <td>Fast Input Number 1</td> </tr> <tr> <td>1</td> <td>Fast Input Number 2</td> </tr> </tbody> </table>	Value	Description	0	Fast Input Number 1	1	Fast Input Number 2
Value	Description							
0	Fast Input Number 1							
1	Fast Input Number 2							
	Data type	BOOL						
	Range	[0 , 1]						
	Unit	N/A						
	Default	—						
iCycleTime	Description	Ethercat Cycle Time 250, 500 or 1000						
	Data type	LREAL						
	Range	—						
	Unit	microseconds						
	Default	—						

5.2.0.20.2.2 Output

obDone	Description	Indicates the move completed successfully. The Command Position has reached the endpoint
	Data type	BOOL

	Unit	N/A												
obActive	Description	Indicates this move is the active move												
	Data type	BOOL												
	Unit	N/A												
obError	Description	Indicates an invalid input was specified or the move was terminated due to an error												
	Data type	BOOL												
	Unit	N/A												
oErrorID	Description	Indicates the error if Error output is set to TRUE												
		<table border="1"> <thead> <tr> <th>Value</th> <th>Description</th> </tr> </thead> <tbody> <tr> <td>1</td> <td>Axis in Error State</td> </tr> <tr> <td>2</td> <td>Axis is Not Enabled</td> </tr> <tr> <td>3</td> <td>Timeout Exceeded</td> </tr> <tr> <td>4</td> <td>SDO Read/Write Error</td> </tr> <tr> <td>5</td> <td>Input Parameter out of Range</td> </tr> </tbody> </table>	Value	Description	1	Axis in Error State	2	Axis is Not Enabled	3	Timeout Exceeded	4	SDO Read/Write Error	5	Input Parameter out of Range
Value	Description													
1	Axis in Error State													
2	Axis is Not Enabled													
3	Timeout Exceeded													
4	SDO Read/Write Error													
5	Input Parameter out of Range													
	Data type	DINT												
	Unit	N/A												

5.2.0.20.3 Usage

This homing procedure performs a homing function searching for sensor using only High Speed Input Switches. (A High Speed Limit Switch has 1 "Off" (or "On") area).

- Home is commanded by user in the desired homing direction at the selected Velocity
- If LimitSwitch is found 'On' on rising 'Execute', then the process is started in the opposite direction as specified, LimitSwitch is search for 'Off' (or On, depending on LimitSwitchMode setting) Edge (released), and process is restarted again in original direction. This ensures that the end conditions are always the same
- The Timeout can cause an error if exceeded

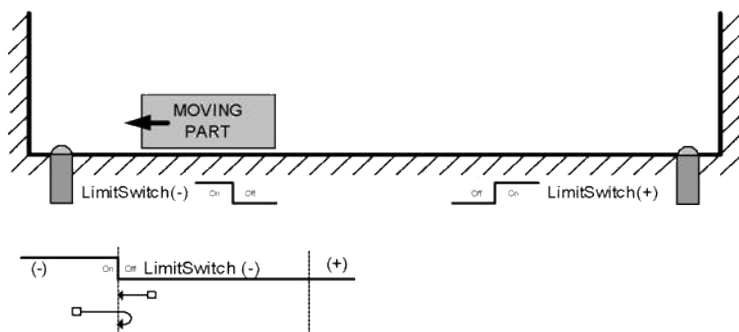

5.2.0.20.4 Related Functions

- [MLFB_HomeFindHomeFastInput](#)
- [MLFB_HomeFindLimitFastInput](#)
- [MLFB_HomeFindLimitFastInputModulo](#)

5.2.0.20.5 Example

5.2.0.20.5.1 Structured Text

```
Direction:= 0;
Position:=1000;
Velocity:=1000;
Acceleration:=10000;
Deceleration:=10000;
SwitchMode:=0;
Timeout:=T#100;
FastInputNumber:=0;
CycleTime:=1000;

inst_fbHomeFindHomeFastInputModulo(True, Axis1, Position,
Direction, Velocity, Acceleration, Deceleration, PosLimitSwitch,
NegLimitSwitch, Timeout, FastInputNumber, CycleTime);

HomeComplete :=inst_fbHomeFindHomeFastInputModulo.Done;
HomeActive :=inst_fbHomeFindHomeFastInputModulo.Active;
HomeError :=inst_fbHomeFindHomeFastInputModulo.Error;
HomeErrorID :=inst_fbHomeFindHomeFastInputModulo.ErrorID;

(* PosLimitSwitch and NegLimitSwtch are declared I/O points *)
```

5.2.0.20.5.2 Ladder Diagram

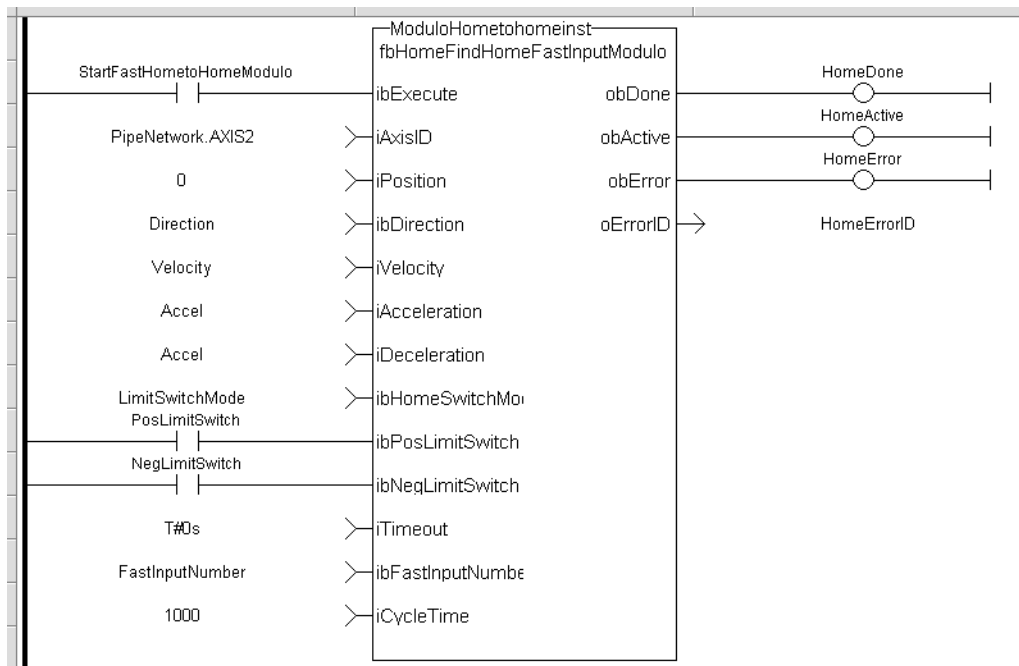

5.2.0.20.5.3 Function Block Diagram

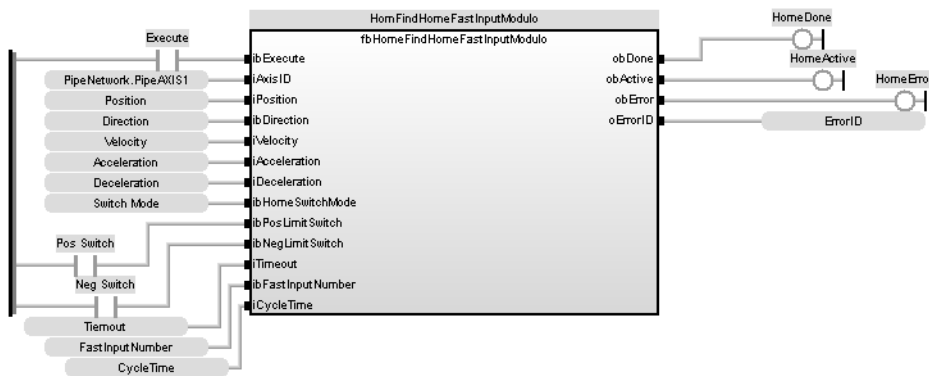

5.2.0.21 MLFB_HomeFindLimitFastInput Pipe Network ✓

5.2.0.21.1 Description

This function block performs a single-axis home to a limit switch connected to a High Speed Input. The motor starts to move according to the direction setting. The home position has been found as soon as the fast input selected is triggered on the edge selected.

An absolute move is made to the triggered position, and then the position value is set.

The following figure shows the function block I/O:

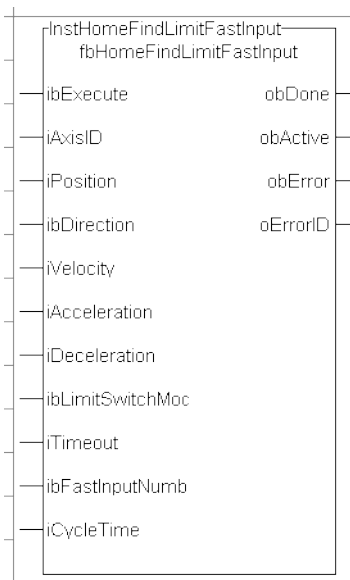

Figure 1-180: MLFB HomeFindLimitFastInput

5.2.0.21.2 Arguments

5.2.0.21.2.1 Input

ibExecute	Description	Request the homing step procedure at rising edge
	Data type	BOOL
	Range	[0 , 1]
	Unit	N/A
	Default	—
iAxisID	Description	Name of a declared instance of the AXIS_REF library function
	Data type	AXIS_REF
	Range	[1 , 256]
	Unit	N/A
	Default	—
iPosition	Description	Offset Position Applied After Home Switch is found
	Data type	LREAL
	Range	—
	Unit	User unit
	Default	—

ibDirection	Description	Define the axis homing direction						
		<table border="1"> <thead> <tr> <th>Value</th> <th>Description</th> </tr> </thead> <tbody> <tr> <td>0</td> <td>clockwise rotation</td> </tr> <tr> <td>1</td> <td>counterclockwise rotation</td> </tr> </tbody> </table>	Value	Description	0	clockwise rotation	1	counterclockwise rotation
	Value	Description						
	0	clockwise rotation						
	1	counterclockwise rotation						
Data type	BOOL							
Range	[0, 1]							
Unit	N/A							
	Default	—						
iVelocity	Description	Commanded velocity for the homing move						
	Data type	LREAL						
	Range	—						
	Unit	User unit/sec						
	Default	—						
iAcceleration	Description	Commanded acceleration for the homing move						
	Data type	LREAL						
	Range	—						
	Unit	User unit/sec ²						
	Default	—						
ibLimitSwitchMode	Description	Limit switch state to complete homing						
		<table border="1"> <thead> <tr> <th>Value</th> <th>Description</th> </tr> </thead> <tbody> <tr> <td>0</td> <td>Rising edge of switch</td> </tr> <tr> <td>1</td> <td>Falling edge of switch</td> </tr> </tbody> </table>	Value	Description	0	Rising edge of switch	1	Falling edge of switch
	Value	Description						
	0	Rising edge of switch						
	1	Falling edge of switch						
Data type	BOOL							
Range	[0, 1]							
Unit	N/A							
	Default	—						
ibFastInputNumber	Description	Limit switch state to complete homing.						
		<table border="1"> <thead> <tr> <th>Value</th> <th>Description</th> </tr> </thead> <tbody> <tr> <td>0</td> <td>Fast Input Number 1</td> </tr> <tr> <td>1</td> <td>Fast Input Number 2</td> </tr> </tbody> </table>	Value	Description	0	Fast Input Number 1	1	Fast Input Number 2
	Value	Description						
	0	Fast Input Number 1						
	1	Fast Input Number 2						
Data type	BOOL							
Range	[0, 1]							

	Unit	N/A
	Default	—
iCycleTime	Description	Ethercat Cycle Time 250, 500 or 1000
	Data type	LREAL
	Range	—
	Unit	microseconds
	Default	—

5.2.0.21.2.2 Output

obDone	Description	Indicates the move completed successfully. The Command Position has reached the endpoint	
	Data type	BOOL	
	Unit	N/A	
obActive	Description	Indicates this move is the active move	
	Data type	BOOL	
	Unit	N/A	
obError	Description	Indicates an invalid input was specified or the move was terminated due to an error	
	Data type	BOOL	
	Unit	N/A	
oErrorID	Description	Indicates the error if Error output is set to TRUE	
		Value	Description
		1	Axis in Error State
		2	Axis is Not Enabled
		3	Timeout Exceeded
		4	SDO Read/Write Error
		5	Input Parameter out of Range
	Data type	DINT	
	Unit	N/A	

5.2.0.21.3 Usage

This homing procedure performs a homing function searching for sensor using only High Speed Input Switches. (A High Speed Limit Switch has 1 “Off” (or “On”) area).

- Home is commanded by user in the desired homing direction at the selected Velocity.
- The Timeout can cause an error if exceeded

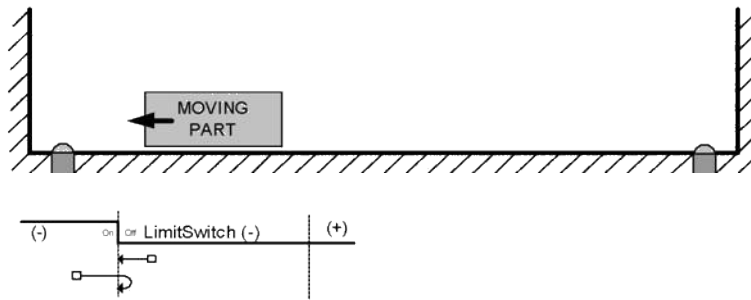

5.2.0.21.4 Related Functions

[MLFB_HomeFindHomeFastInput](#)

[MLFB_HomeFindHomeFastInputModulo](#)

[MLFB_HomeFindLimitFastInputModulo](#)

5.2.0.21.5 Example

5.2.0.21.5.1 Structured Text

```

Direction:= 0;
Position:=1000;
Velocity:=1000;
Acceleration:=10000;
Deceleration:=10000;
SwitchMode:=0;
Timeout:=T#100;
FastInputNumber:=0;
CycleTime:=1000;

```

```

inst_fbHomeFindLimitFastInput(True, Axis1, Position, Direction,
Velocity, Acceleration, Deceleration, LimitSwitchMode, Timeout,
FastInputNumber, CycleTime);

```

```

HomeComplete :=inst_fbHomeFindLimitFastInput.Done;
HomeActive :=inst_fbHomeFindLimitFastInput.Active;
HomeError :=inst_fbHomeFindLimitFastInput.Error;
HomeErrorID :=inst_fbHomeFindLimitFastInput.ErrorID;

```

5.2.0.21.5.2 Ladder Diagram

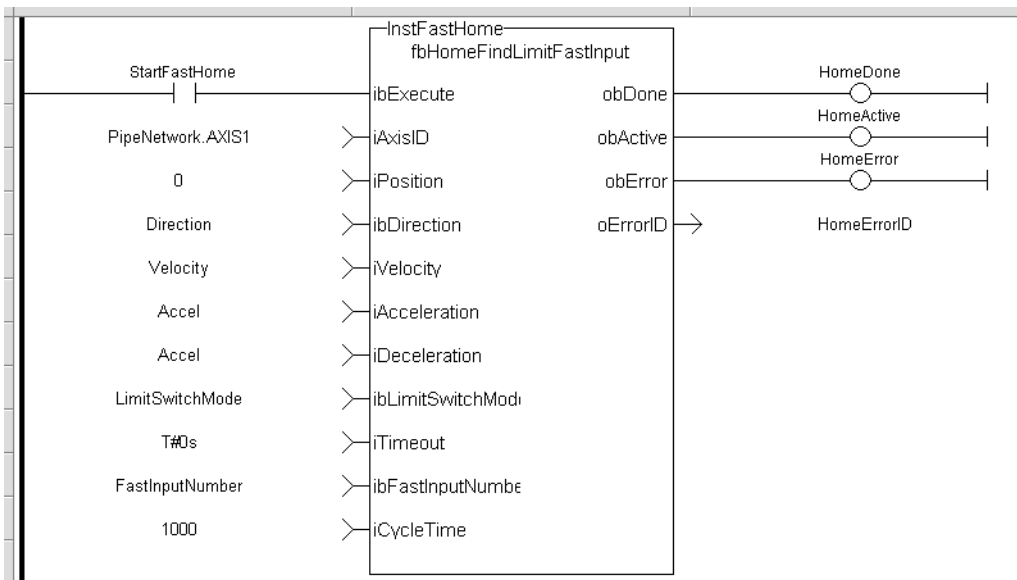

5.2.0.21.5.3 Function Block Diagram

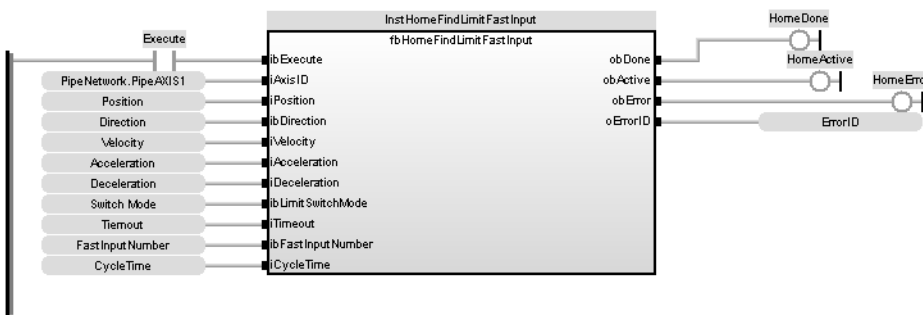

5.2.0.22 MLFB_HomeFindLimitFastInputModulo Pipe Network ✓

5.2.0.22.1 Description

This function block performs a single-axis home to a limit switch connected to a High Speed Input. The motor starts to move according to the direction setting. The home position has been found as soon as the fast input selected is triggered on the edge selected.

An absolute move is made to the triggered position, and then the position value is set. This function is to be used when the axis is set-up in Modulo mode.

The following figure shows the function block I/O:

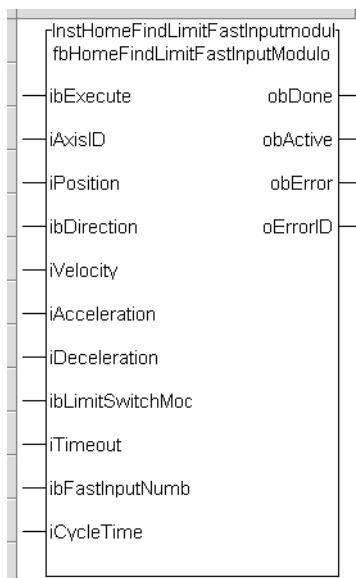

Figure 1-181: MLFB HomeFindLimitFastInputModulo

5.2.0.22.2 Arguments

5.2.0.22.2.1 Input

ibExecute	Description Data type Range Unit Default	Request the homing step procedure at rising edge BOOL [0 , 1] N/A —						
iAxisID	Description Data type Range Unit Default	Name of a declared instance of the AXIS_REF library function AXIS_REF [1 , 256] N/A —						
iPosition	Description Data type Range Unit Default	Offset Position Applied After Home Switch is found LREAL — User unit —						
ibDirection	Description Data type Range Unit Default	Define the axis homing direction <table border="1" style="width: 100%; border-collapse: collapse;"> <thead> <tr style="background-color: #002060; color: white;"> <th style="text-align: left; padding: 5px;">Value</th> <th style="text-align: left; padding: 5px;">Description</th> </tr> </thead> <tbody> <tr style="background-color: #e0e0e0;"> <td style="text-align: center; padding: 5px;">0</td> <td style="padding: 5px;">clockwise rotation</td> </tr> <tr> <td style="text-align: center; padding: 5px;">1</td> <td style="padding: 5px;">counterclockwise rotation</td> </tr> </tbody> </table> BOOL [0 , 1] N/A —	Value	Description	0	clockwise rotation	1	counterclockwise rotation
Value	Description							
0	clockwise rotation							
1	counterclockwise rotation							
iVelocity	Description Data type	Commanded velocity for the homing move LREAL						

	Range	—						
	Unit	User unit/sec						
	Default	—						
iAcceleration	Description	Commanded acceleration for the homing move						
	Data type	LREAL						
	Range	—						
	Unit	User unit/sec ²						
	Default	—						
iDeceleration	Description	Commanded deceleration for the homing move						
	Data type	LREAL						
	Range	—						
	Unit	User unit/sec ²						
	Default	—						
		Limit switch state to complete homing						
ibLimitSwitchMode	Description	<table border="1" data-bbox="643 734 1378 875"> <thead> <tr> <th>Value</th> <th>Description</th> </tr> </thead> <tbody> <tr> <td>0</td> <td>Rising edge of switch</td> </tr> <tr> <td>1</td> <td>Falling edge of switch</td> </tr> </tbody> </table>	Value	Description	0	Rising edge of switch	1	Falling edge of switch
Value	Description							
0	Rising edge of switch							
1	Falling edge of switch							
	Data type	BOOL						
	Range	[0, 1]						
	Unit	N/A						
	Default	—						
iTimeout	Description	Maximum time for homing move to complete. If exceeded the homing procedure will error out. 0= no time limit						
	Data type	TIME						
	Range	—						
	Unit	sec						
	Default	—						
		Limit switch state to complete homing.						
ibFastInputNumber	Description	<table border="1" data-bbox="643 1294 1378 1435"> <thead> <tr> <th>Value</th> <th>Description</th> </tr> </thead> <tbody> <tr> <td>0</td> <td>Fast Input Number 1</td> </tr> <tr> <td>1</td> <td>Fast Input Number 2</td> </tr> </tbody> </table>	Value	Description	0	Fast Input Number 1	1	Fast Input Number 2
Value	Description							
0	Fast Input Number 1							
1	Fast Input Number 2							
	Data type	BOOL						
	Range	[0, 1]						
	Unit	N/A						
	Default	—						
iCycleTime	Description	Ethercat Cycle Time 250, 500 or 1000						
	Data type	LREAL						
	Range	—						
	Unit	microseconds						
	Default	—						

5.2.0.22.2.2 Output

obDone	Description	Indicates the move completed successfully. The Command Position has reached the endpoint
	Data type	BOOL
	Unit	N/A

obActive	Description	Indicates this move is the active move
	Data type	BOOL
obError	Description	Indicates an invalid input was specified or the move was terminated due to an error
	Data type	BOOL
oErrorID	Description	Indicates the error if Error output is set to TRUE
	Data type	DINT
	Unit	N/A

Value	Description
1	Axis in Error State
2	Axis is Not Enabled
3	Timeout Exceeded
4	SDO Read/Write Error
5	Input Parameter out of Range

5.2.0.22.3 Usage

This homing procedure performs a homing function searching for sensor using only High Speed Input Switches. (A High Speed Limit Switch has 1 "Off" (or "On") area).

- Home is commanded by user in the desired homing direction at the selected Velocity.
- The Timeout can cause an error if exceeded

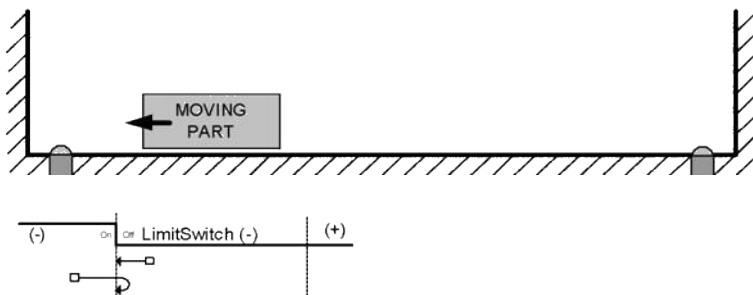

5.2.0.22.4 Related Functions

- [MLFB_HomeFindHomeFastInput](#)
- [MLFB_HomeFindHomeFastInputModulo](#)
- [MLFB_HomeFindLimitFastInput](#)

5.2.0.22.5 Example

5.2.0.22.5.1 Structured Text

```

Direction:= 0;
Position:=1000;
Velocity:=1000;
Acceleration:=10000;
Deceleration:=10000;
SwitchMode:=0;
Timeout:=T#100;
FastInputNumber:=0;
CycleTime:=1000;
    
```

```

inst_fbHomeFindLimitFastInputModulo(True, Axis1, Position,
Direction, Velocity, Acceleration, Deceleration,
LimitSwitchMode, Timeout, FastInputNumber, CycleTime);
    
```

```

HomeComplete :=inst_fbHomeFindLimitFastInputModulo.Done;
HomeActive :=inst_fbHomeFindLimitFastInputModulo.Active;
HomeError :=inst_fbHomeFindLimitFastInputModulo.Error;
HomeErrorID :=inst_fbHomeFindLimitFastInputModulo.ErrorID;
    
```

5.2.0.22.5.2 Ladder Diagram

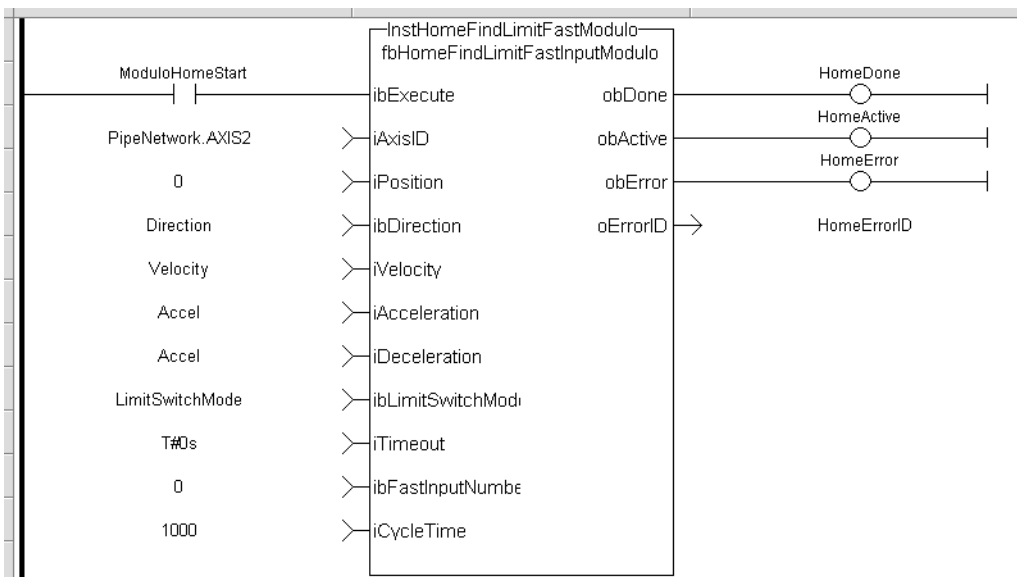

5.2.0.22.5.3 Function Block Diagram

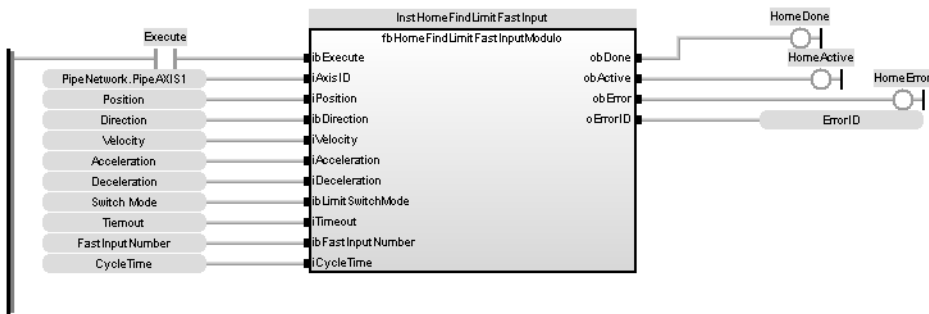

5.2.0.23 MLFB_Jog Pipe Network ✓

5.2.0.23.1 Description

This function is defined to jog an axis in the selected direction at a defined speed. The En input (FFLD editor only) must be high. Typically wired to the rail. The AxisID selects the axis to jog. The JogPlus and JogMinus inputs select the direction the motion will occur in. Only one of these inputs should be enabled at a given time. If both are selected the motion will stop. If other motion is active when the jog is requested that motion will be aborted and the jog will start.

The following figure shows the function I/O

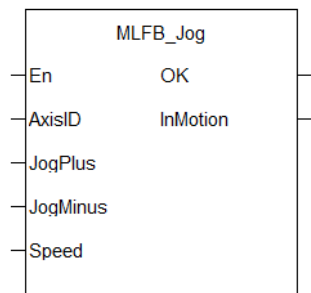

Figure 1-182: Kollmorgen UDFB Jog for PipeNetwork

5.2.0.23.2 Arguments

5.2.0.23.2.1 Input

En	Description	Enables execution (FFLD only)
	Data type	BOOL
	Range	—
	Unit	N/A
	Default	—
AxisID	Description	ID Name of the Axis
	Data type	DINT
	Range	—
	Unit	N/A
	Default	—

JogPlus	Description	Enables a Jog in the plus direction
	Data type	BOOL
	Range	[0 , 1]
	Unit	N/A
	Default	—
JogMinus	Description	Enables a Jog in the Minus direction
	Data type	BOOL
	Range	[0 , 1]
	Unit	N/A
	Default	—
Speed	Description	Rate at which the axis will move
	Data type	LREAL
	Range	—
	Unit	User unit/sec
	Default	—

5.2.0.23.2.2 Output

InMotion	Description	Jogging is active when TRUE
	Data type	BOOL
	Range	N/A

5.2.0.23.3 Usage

This function is used to command motion in a designated direction at a defined rate. This may be used where continuous motion required as in a conveyor system, or in a setup mode for manually jogging the axis. Motion will start when the JogPlus or JogMinus input is true. It will stop when the input goes false. This function is used with the Pipe Network motion engine.

5.2.0.23.4 Related Functions

[MLAxisMoveVel](#)

5.2.0.23.5 Example

5.2.0.23.5.1 Structured Text

```
//Jog Axis1 at 6000 user units a second when JogPlus or JogMinus
variables are TRUE
//Stop motion on falling edge of either variable
MLFB_Jog( PipeNetwork.AXIS1, JogPlus, JogMinus, 6000 );
```

5.2.0.23.5.2 Ladder Diagram

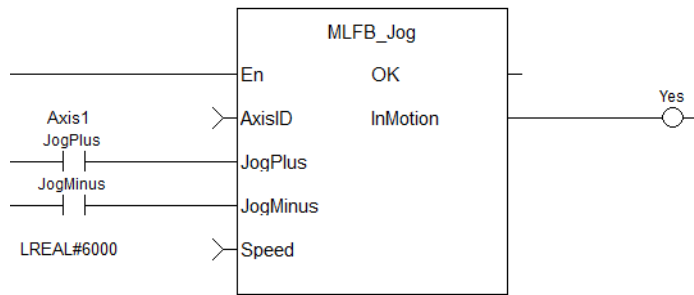

5.2.0.23.5.3 Function Block Diagram

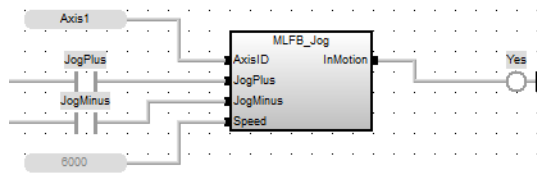

5.2.0.24 MLFB_PlsPosFw Pipe Network ✓

5.2.0.24.1 Description

This function block should be used in the command position path with ascending position. A dedicated comparator pipe block is needed. The Boolean output oPLS is set to TRUE if the position of the comparator has crossed the start position and is set to FALSE if the position has crossed the end position. The function block is executed cyclically. The modulo position is considered. The function block has the possibility to compensate a delay time of the connected device, e .g. glue nozzles.

5.2.0.24.2 Arguments

5.2.0.24.2.1 Input

ibExecute	Description Data type	Enable PLS BOOL
iDedicatedCmpID	Description Data type	ID of dedicated comparator DINT
iStartPos	Description Data type	Start position of PLS LREAL
iEndPos	Description Data type	End position of PLS LREAL
iDelayTime	Description Data type	Delay time for compensation TIME
ibForce	Description Data type	Force PLS BOOL

5.2.0.24.2.2 Output

oPLS	Description Data type	Position limit switch BOOL
------	--------------------------	-------------------------------

5.2.0.24.3 Example

5.2.0.24.4 Timing

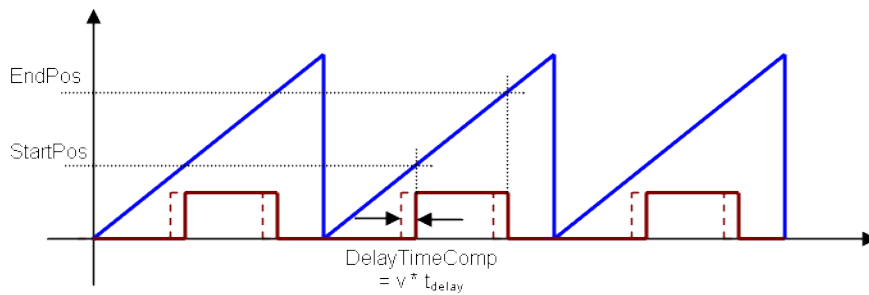

5.2.0.24.4.1 ST

```
//PLSOutput is True when chosen comparator is between 180 and 270 with a T#2ms delay
//Can also force the output to be true with ForceOutput variable
Inst_MLFB_PlsPosFw( EnablePLS, PipeNetwork.COMPARATOR, 180, 270, T#2ms,
ForceOutput );
PLSOutput := Inst_MLFB_PlsPosFw.oPLS;
```

5.2.0.24.4.2 FBD

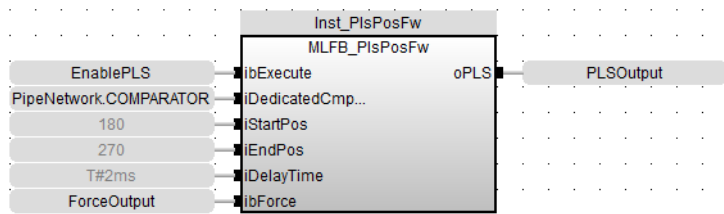

5.2.0.24.4.3 FFLD

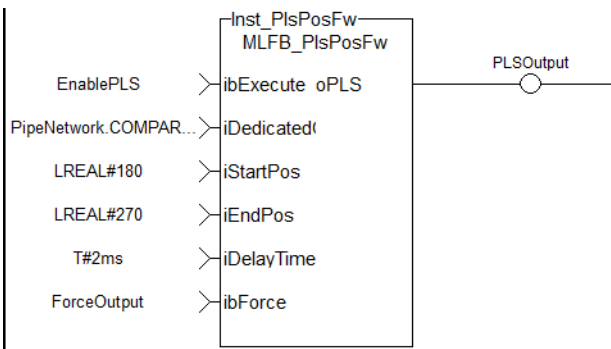

5.2.0.25 MLFB_PlsPosFwBw Pipe Network ✓

5.2.0.25.1 Description

This function block can be used in the command or actual position path, e.g. sampler pipe with noisy position, in both directions. Any modulo pipe block is needed, which can also be used for another instance of this UDFB. The Boolean output oPLS is set to TRUE if the position of the comparator has crossed the start position and is set to FALSE if the position has crossed the end position. The function block is executed cyclically. The modulo position is considered. The function block has the possibility to compensate a delay time of the connected device, e.g. glue nozzles. It is also possible to define a hysteresis for switching on and off of the PLS.

5.2.0.25.2 Arguments

5.2.0.25.2.1 Input

ibExecute	Description Data type	Enable PLS BOOL
iAnyModuloBlkID	Description Data type	Any modulo pipe network block ID DINT
iStartPos	Description Data type	Start position of PLS LREAL
iEndPos	Description Data type	End position of PLS LREAL
iDelayTime	Description Data type	Delay time for compensation TIME
iHysteresis	Description Data type	Hysteresis LREAL
ibForce	Description Data type	Force PLS BOOL

5.2.0.25.2.2 Output

oPLS	Description Data type	Position limit switch BOOL
------	--------------------------	-------------------------------

5.2.0.25.3 Example

5.2.0.25.4 Timing

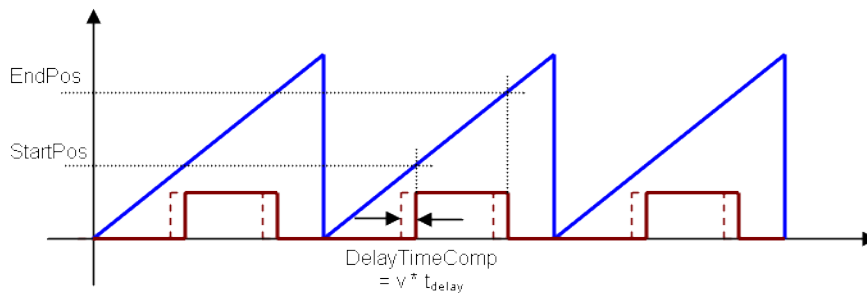

5.2.0.25.5 Hysteresis

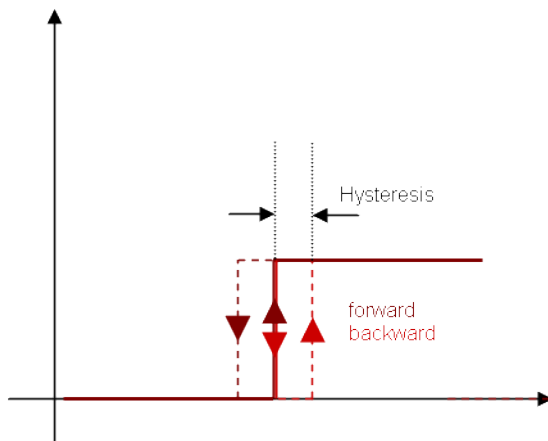

5.2.0.25.5.1 ST

```
//PLSOutput is True when chosen comparator is between 180 and 270 with a
T#2ms delay
//Can also force the output to be true with ForceOutput variable
//Hysteresis is on for 3 user units in case direction changes around
start point
Inst_MLFB_PlsPosFwBw( EnablePLS, PipeNetwork.COMPARATOR, 180, 270, T#2ms,
3, ForceOutput );
PLSOutput := Inst_MLFB_PlsPosFwBW.oPLS;
```

5.2.0.25.5.2 FBD

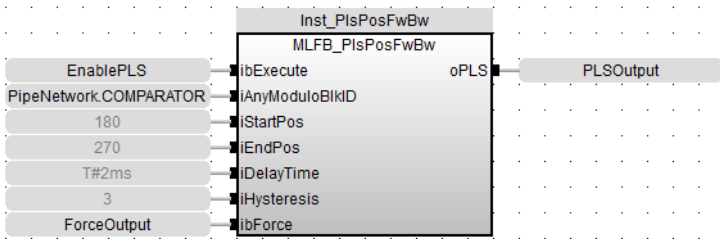

5.2.0.25.5.3 FFLD

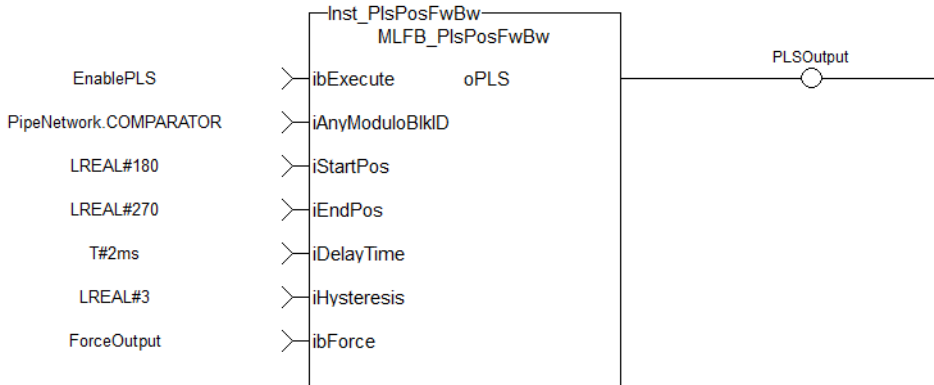

5.2.0.26 MLFB_PlsTimeFw Pipe Network ✓

5.2.0.26.1 Description

This function block should be used in the command position path with ascending position. A dedicated comparator pipe block is needed. The Boolean output oPLS is set to TRUE if the position of the comparator has crossed the start position and a timer with iOnTime is started. When the timer has expired the output is set to FALSE. The function block is executed cyclically. The modulo position is considered. The function block has the possibility to compensate a delay time of the connected device, e.g. glue nozzles.

5.2.0.26.2 Arguments

5.2.0.26.2.1 Input

ibExecute	Description	Enable PLS
	Data type	BOOL
iDedicatedCmpID	Description	ID of dedicated comparator
	Data type	DINT
iStartPos	Description	Start position of PLS

	Data type	LREAL
iOnTime	Description	Time PLS is on
	Data type	TIME
iDelayTime	Description	Delay time for compensation
	Data type	TIME
ibForce	Description	Force PLS
	Data type	BOOL

5.2.0.26.2.2 Output

oPLS	Description	Position limit switch
	Data type	BOOL

5.2.0.26.3 Example

5.2.0.26.4 Timing

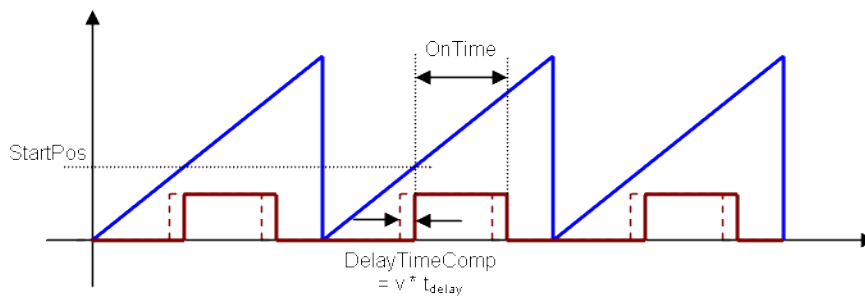

5.2.0.26.4.1 ST

```
//PLSOutput is True when chosen comparator passes 180 for 3 seconds a
T#2ms delay
//Can also force the output to be true with ForceOutput variable
Inst_MLFB_PlsTimeFw( EnablePLS, PipeNetwork.COMPARATOR, 180, T#3s, T#2ms,
ForceOutput );
PLSOutput := Inst_MLFB_PlsTimeFw.oPLS;
```

5.2.0.26.4.2 FBD

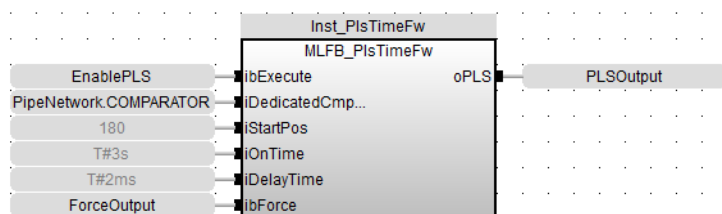

5.2.0.26.4.3 FFLD

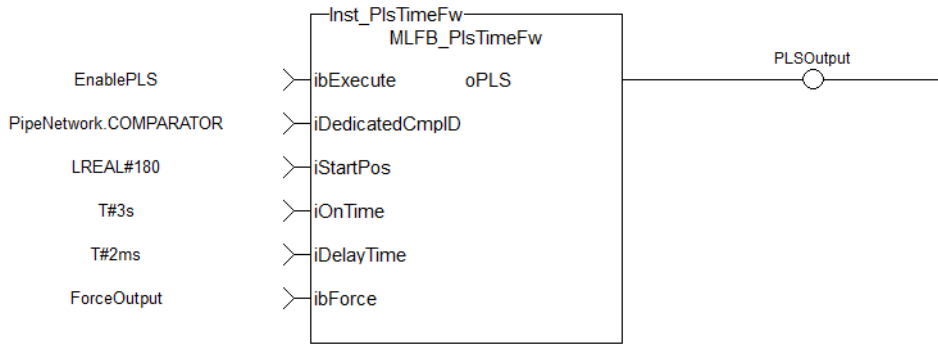

5.2.0.27 MCFB_AKDFault PLCopen

5.2.0.27.1 Description

Outputs AKD drive fault Information. The FAULT output turns TRUE when the selected drive goes into a fault state. The fault number is the same number as reported on the display of the AKD drive. This function can be used with the PLCopen Motion engines.

TIP

This function block lists the *highest priority* fault as displayed on the AKD. The [FB_AKDFltRpt](#) function block lists faults in the order they occur.

The following figure shows the function block I/O:

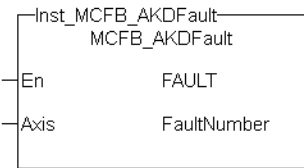

Figure 1-183: MCFB_AKDFault

5.2.0.27.2 Arguments

5.2.0.27.2.1 Input

EN	Description	ENABLES the Kollmorgen UDFB (used in FFLD editor only)
	Data type	BOOL
	Range	[0, 1]
	Unit	N/A
	Default	—
Axis	Description	Name of a declared instance of the AXIS_REF library function. For more details, About Axis Name and Number .
	Data type	AXIS_REF
	Range	[1, 256]
	Unit	N/A
	Default	—

5.2.0.27.2.2 Output

FAULT	Description	TRUE if selected drive currently has a Fault
	Data type	BOOL
	Range	[0 , 1]
	Unit	N/A
FaultNumber	Description	Three digit AKD Fault identifier
	Data type	DINT
	Range	[100 , 999]
	Unit	N/A

5.2.0.27.3 Usage

Typical usage for this UDFB are:

- Provide drive fault information that the application program uses to determine next steps such as perform a machine controlled stop or perform an immediate disable of the servo drives.
- In the application program send output fault information from this UDFB to the HMI for review by the machine operator.

Related Functions

[MCFB_AKDFaultLookup](#)

[FB_AKDFltRpt](#)

[MC_ReadStatus](#) (PLCopen Motion Engine)

5.2.0.27.4 Example

5.2.0.27.4.1 Structured Text

```

//Execute and Read the Function Block

Inst_MCFB_AKDFault( Axis1(*lib:AXIS_REF*) );
FaultDrive1 := Inst_MCFB_AKDFault.FAULT;
FaultDrive1Number := Inst_MCFB_AKDFault.FaultNumber;

FaultDrive1Description := MCFB_AKDFaultLookup( FaultDrive1Number(*DINT*)
);
    
```

5.2.0.27.4.2 Ladder Diagram

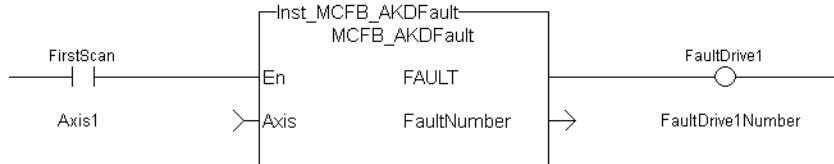

5.2.0.27.4.3 Function Block Diagram



5.2.0.28 MCFB_AKDFaultLookup PLCopen

5.2.0.28.1 Description

String message of the corresponding AKD drive fault number. The OK output turns TRUE when there is a match for the FaultNumber. The FaultDescription displays the corresponding text string. The FaultNumber is the same number as reported on the display of the AKD drive. This function can be used with the PLCopen Motion engines. The following figure shows the function I/O:

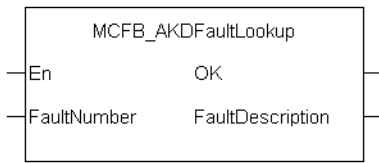

Figure 1-184: MCFB_AKDFaultLookup

5.2.0.28.2 Arguments

5.2.0.28.2.1 Input

EN	Description	ENABLES the Kollmorgen UDFB (used in FFLD editor only)
	Data type	BOOL
	Range	[0, 1]
	Unit	N/A
	Default	—
FaultNumber	Description	The AKD drive fault number
	Data type	DINT
	Range	—
	Unit	N/A
	Default	—

5.2.0.28.2.2 Output

OK	Description	TRUE if there is a match for the FaultNumber
	Data type	BOOL
	Range	[0, 1]
	Unit	N/A
FaultDescription	Description	Description of the Fault
	Data type	STRING
	Range	N/A
	Unit	N/A

5.2.0.28.3 Usage

Typical usage for this UDFB are:

- Provide drive fault information that the application program uses to determine next steps such as perform a machine controlled stop or perform an immediate disable of the servo drives.
- In the application program send output fault information from this UDFB to the HMI for review by the machine operator.

5.2.0.28.4 Related Functions

[MCFB_AKDFault](#)

[FB_AKDFltRpt](#)

[MC_ReadStatus](#) (PLCopen Motion Engine)

5.2.0.28.5 Example

5.2.0.28.5.1 Structured Text

```
//Execute and Read the Function Block

Inst_MCFB_AKDFault( Axis1(*lib:AXIS_REF*) );
FaultDrive1 := Inst_MCFB_AKDFault.FAULT;
FaultDrive1Number := Inst_MCFB_AKDFault.FaultNumber;

FaultDrive1Description := MCFB_AKDFaultLookup( FaultDrive1Number(*DINT*)
);
```

5.2.0.28.5.2 Ladder Diagram

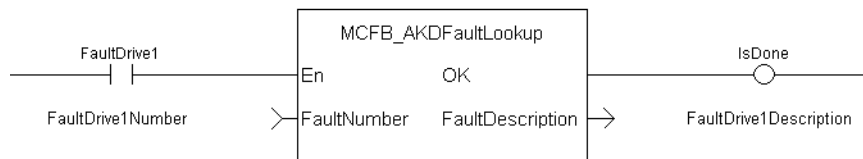

5.2.0.28.5.3 Function Block Diagram



5.2.0.29 MCFB_DriveFault PLCopen

5.2.0.29.1 Description

This function block returns the fault status, fault number and fault description of the requested axis which is mapped to a Kollmorgen drive such as S300, S700, AKD, AKD2G, and AKT2G Stepper.

The FAULT output returns TRUE when the selected drive goes into a fault state. The fault number and description depend on the drive type mapped to the axis.

- If the drive is an AKD or AKD2G then the fault number is the same number as reported on the display of the AKD/AKD2G drive.
- If the drive is an AKT2G Stepper, then the fault number represents the drive status word which is a bitmask that represents the various error conditions.

NOTE

This function blocks requires [FB_S700FltRpt](#), [MCFB_AKDFault](#), and [MCFB_AKDFaultLookup](#) subprograms imported to project to compile and function

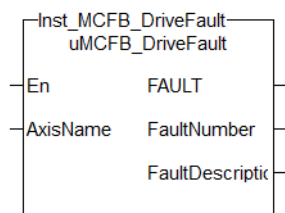

Figure 1-185: MCFB_DriveFault

5.2.0.29.2 Arguments

5.2.0.29.2.1 Input

EN	Description	ENABLES the Kollmorgen UDFB (used in FFLD editor only)
	Data type	BOOL
	Range	[0 , 1]
	Unit	N/A
	Default	—
Axis	Description	Name of a declared instance of the AXIS_REF library function. For more details see About Axis Name and Number .
	Data type	AXIS_REF Structure
	Range	[1, 256]
	Unit	N/A
	Default	—

5.2.0.29.2.2 Output

FAULT	Description	TRUE if the selected drive currently has a Fault
	Data type	BOOL
	Range	[0 , 1]
	Unit	N/A

FaultNumber	Description	<p>If the axis is:</p> <p>S300/S700: Three-digit fault identifier. See the article S300 & S700 Errors and Warnings on KDN for a full list of fault codes.</p> <p>AKD: Three-digit fault identifier. See the AKD Fault and Warning Messages for a full list of fault codes.</p> <p>AKD2G: Four-digit fault identifier. See the AKD2G Faults and Warning Messages for a full list of fault codes.</p> <p>AKT2G Stepper: Drive Status word (bitmask). See following table.</p> <table border="1"> <thead> <tr> <th>Bit</th> <th>Description</th> <th>Cause</th> </tr> </thead> <tbody> <tr> <td>0</td> <td>Saturated</td> <td>Drive stage operates with maximum duty cycle</td> </tr> <tr> <td>1</td> <td>Over temperature</td> <td>Internal temperature is higher than 80o C</td> </tr> <tr> <td>2</td> <td>Torque overload.</td> <td>Motor current is higher than the rated current</td> </tr> <tr> <td>3</td> <td>Under voltage.</td> <td>Motor supply voltage is 20% lower than the configured nominal voltage (warning), or Motor supply voltage is less than 8 V</td> </tr> <tr> <td>4</td> <td>Over voltage.</td> <td>Motor supply voltage is 10% higher than the configured nominal voltage</td> </tr> <tr> <td>5</td> <td>Short circuit A.</td> <td>Short circuit in motor coil A</td> </tr> <tr> <td>6</td> <td>Short circuit B</td> <td>Short circuit in motor coil B</td> </tr> <tr> <td>7</td> <td>No control power</td> <td>Control voltage at the power contacts is less than 12 V</td> </tr> <tr> <td>8</td> <td>Misc. error</td> <td>Terminal initialization failed, or supply voltage is less than 8 V, or internal terminal temperature is higher than 100°C</td> </tr> <tr> <td>9</td> <td>Configuration error</td> <td>CoE change has not yet been adopted into the current configuration</td> </tr> </tbody> </table>	Bit	Description	Cause	0	Saturated	Drive stage operates with maximum duty cycle	1	Over temperature	Internal temperature is higher than 80o C	2	Torque overload.	Motor current is higher than the rated current	3	Under voltage.	Motor supply voltage is 20% lower than the configured nominal voltage (warning), or Motor supply voltage is less than 8 V	4	Over voltage.	Motor supply voltage is 10% higher than the configured nominal voltage	5	Short circuit A.	Short circuit in motor coil A	6	Short circuit B	Short circuit in motor coil B	7	No control power	Control voltage at the power contacts is less than 12 V	8	Misc. error	Terminal initialization failed, or supply voltage is less than 8 V, or internal terminal temperature is higher than 100°C	9	Configuration error	CoE change has not yet been adopted into the current configuration
	Bit	Description	Cause																																
	0	Saturated	Drive stage operates with maximum duty cycle																																
	1	Over temperature	Internal temperature is higher than 80o C																																
	2	Torque overload.	Motor current is higher than the rated current																																
	3	Under voltage.	Motor supply voltage is 20% lower than the configured nominal voltage (warning), or Motor supply voltage is less than 8 V																																
	4	Over voltage.	Motor supply voltage is 10% higher than the configured nominal voltage																																
	5	Short circuit A.	Short circuit in motor coil A																																
	6	Short circuit B	Short circuit in motor coil B																																
	7	No control power	Control voltage at the power contacts is less than 12 V																																
8	Misc. error	Terminal initialization failed, or supply voltage is less than 8 V, or internal terminal temperature is higher than 100°C																																	
9	Configuration error	CoE change has not yet been adopted into the current configuration																																	
Data type	DINT																																		
Range																																			
Unit	N/A																																		
Fault Description	Description	Description of the Fault																																	
	Data type	STRING																																	
	Range	N/A																																	
	Unit	N/A																																	

5.2.0.29.3 Usage

Typical usage for this UDFB is:

- Provide drive fault information that the application program uses to determine next steps such as perform a machine-controlled stop or perform an immediate disable of the servo drives.
- In the application program send output fault information from this UDFB to the HMI for review by the machine operator.

Related Functions

- [MCFB_AKDFault](#)
- [MCFB_AKDFaultLookup](#)
- [FB_S700FltRpt](#)
- [MC_ReadStatus](#) (PLCopen Motion Engine)

5.2.0.29.4 Example

5.2.0.29.4.1 Structured Text

```
//Execute and Read the Function Block
Inst_MCFB_DriveFault( Axis1 );
Axis1Fault := Inst_MCFB_DriveFault.FAULT;
Axis1FaultNumber := Inst_MCFB_DriveFault.FaultNumber;
Axis1FaultDescription := Inst_MCFB_DriveFault.FaultDescription;
```

5.2.0.29.4.2 Ladder Diagram

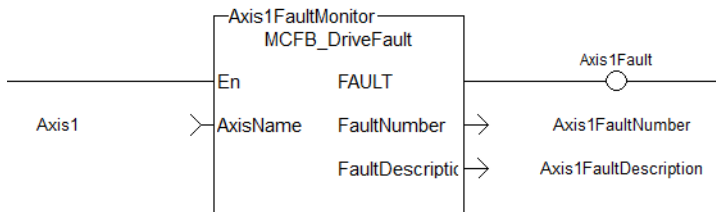

5.2.0.29.4.3 Function Block Diagram

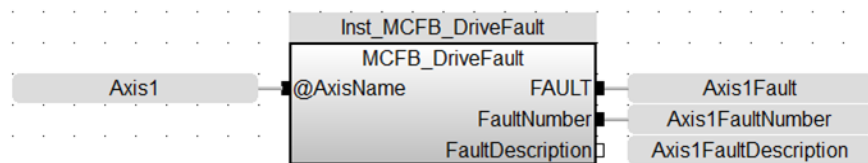

5.2.0.30 MCFB_ECATRstart PLCopen

5.2.0.30.1 Description

This function block reinitializes the EtherCAT network and the motion engine. This function blocks also clears motion engine errors, motion bus driver errors and EtherCAT network errors before reinitializing the motion engine, if requested to do so.

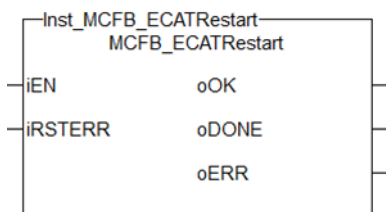

Figure 1-186: MCFB_ECAtRestart

5.2.0.30.2 Arguments

5.2.0.30.2.1 Input

iEN	Description	ENABLES the Kollmorgen UDFB
	Data type	BOOL
	Range	[0, 1]
	Unit	N/A
	Default	—
iRSTERR	Description	Clears the motion engine and EtherCAT network errors in case of any faults
	Data type	BOOL
	Range	[1, 256]
	Unit	[0, 1]
	Default	—

5.2.0.30.2.2 Output

oOK	Description	Function block activated status
	Data type	BOOL
	Range	[0, 1]
	Unit	N/A
oDONE	Description	Execution Complete
	Data type	BOOL
	Range	[0, 1]
	Unit	N/A
oERR	Description	TRUE if the system initialization fails.
	Data type	BOOL
	Range	[0, 1]
	Unit	N/A

5.2.0.30.3 Usage

The typical use for this UDFB is to allow the EtherCAT and motion engines to restart without having to restart the entire project. Examples:

- EtherCAT network wire is replaced or accidentally disconnected
- Axis setup Parameters defined by CreateAxis and/or InitAxis function need to be changed while the application is running.

Related Functions

- [MLMotionInit](#)
- [MLMotionRstErr](#)
- [MLMotionStart](#)
- [ClearCtrlErrors](#)

5.2.0.30.4 Examples

5.2.0.30.4.1 Structured Text

```

Inst_MCFB_ECAtRestart( Restart, ResetErrors );
IF Inst_MCFB_ECAtRestart.oDONE THEN
    RestartComplte:=1;
End_IF;
    
```

5.2.0.30.4.2 Ladder Diagram

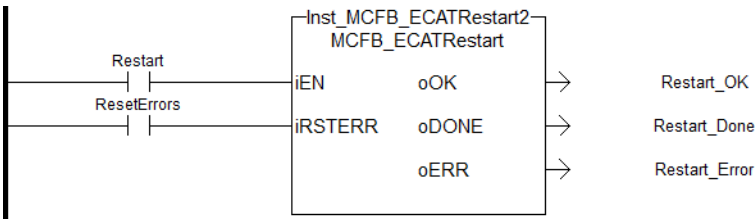

5.2.0.30.4.3 Function Block Diagram

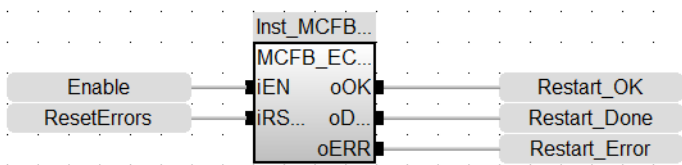

5.2.0.31 MCFB_StepAbsolutes PLCopen ✔

5.2.0.31.1 Description

This function block performs a static homing function by setting Actual Position to the position of an absolute encoder. No physical motion is performed in this mode. Equivalent to MC_SetPosition is performed with SetPosition coming from absolute encoder reading, but with the option of using the once per rev feedback value.

The following figure shows the function block I/O:

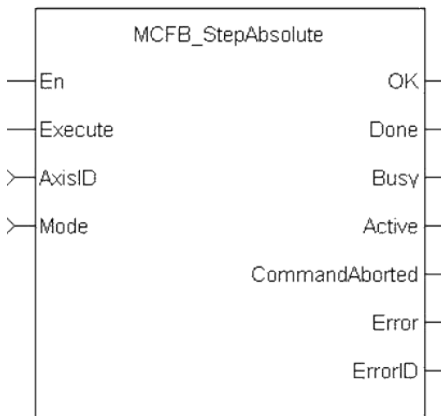

Figure 1-187: MCFB StepAbsolute

5.2.0.31.2 Arguments

5.2.0.31.2.1 Input

En	Description	Enables execution (FFLD only)						
	Data type	BOOL						
	Range	—						
	Unit	N/A						
	Default	—						
Execute	Description	Request the homing step procedure at rising edge						
	Data type	BOOL						
	Range	[0 , 1]						
	Unit	N/A						
	Default	—						
AxisID	Description	Name of a declared instance of the AXIS_REF library function						
	Data type	AXIS_REF						
	Range	[1 , 256]						
	Unit	N/A						
	Default	—						
Mode	Description	Define the actual position assignment source						
		<table border="1"> <thead> <tr> <th>Value</th> <th>Description</th> </tr> </thead> <tbody> <tr> <td>0</td> <td>use drive feedback position for actual position</td> </tr> <tr> <td>1</td> <td>use once per rev feedback position</td> </tr> </tbody> </table>	Value	Description	0	use drive feedback position for actual position	1	use once per rev feedback position
	Value	Description						
	0	use drive feedback position for actual position						
	1	use once per rev feedback position						
	Data type	BOOL						
	Range	[0 , 1]						
Unit	N/A							
Default	—							

5.2.0.31.2.2 Output

Done	Description	Indicates the move completed successfully. The Command Position has reached the endpoint
	Data type	BOOL
	Unit	N/A
Busy	Description	High from the moment the Execute input is one-shot to the time the move is ended

	Data type	BOOL				
	Unit	N/A				
Active	Description	Indicates this move is the active move				
	Data type	BOOL				
	Unit	N/A				
CommandAborted	Description	Indicates the move was aborted				
	Data type	BOOL				
	Unit	N/A				
Error	Description	Indicates an invalid input was specified or the move was terminated due to an error				
	Data type	BOOL				
	Unit	N/A				
Error	Description	Indicates an invalid input was specified or the move was terminated due to an error				
	Data type	BOOL				
	Unit	N/A				
ErrorID	Description	Indicates the error if Error output is set to TRUE				
		<table border="1"> <thead> <tr> <th>Value</th> <th>Description</th> </tr> </thead> <tbody> <tr> <td>1</td> <td>Desired SetPosition is outside of Rollover period</td> </tr> </tbody> </table>	Value	Description	1	Desired SetPosition is outside of Rollover period
Value	Description					
1	Desired SetPosition is outside of Rollover period					
	Data type	INT				
	Unit	N/A				

5.2.0.31.3 Related Functions

[MCFB_StepAbsSwitch](#)

[MCFB_StepRefPulse](#)

[MCFB_StepBlock](#)

[MCFB_StepLimitSwitch](#)

5.2.0.31.4 Example

5.2.0.31.4.1 Structured Text

```
//Write current once per rev feedback position to overall axis position
MCFB_StepAbsolute( ExecuteHome, Axis1, ModeHome );
```

5.2.0.31.4.2 Ladder Diagram

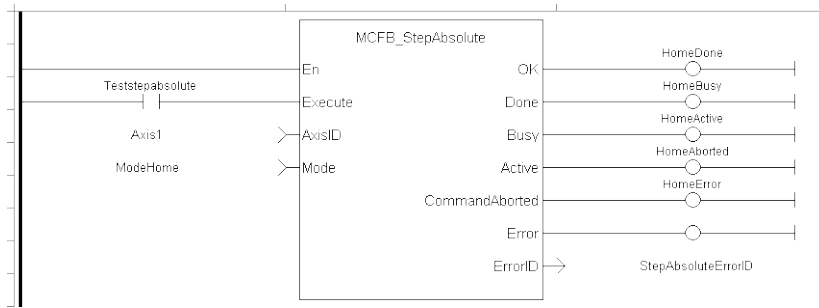

5.2.0.31.4.3 Function Block Diagram

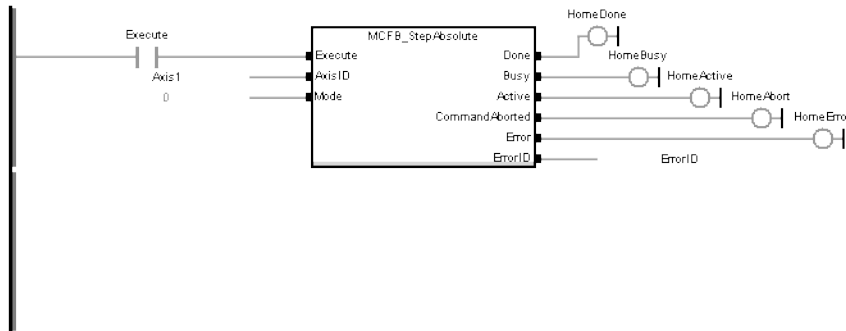

5.2.0.32 MCFB_StepAbsSwitch PLCopen

5.2.0.32.1 Description

This function block performs a homing function by searching for an absolute positioned external physical switch. (An Absolute Switch has two "Off" (or "On") areas.

The following figure shows the function block I/O:

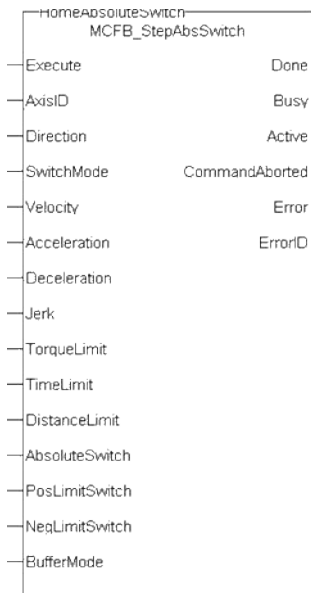

Figure 1-188: MCFB StepAbsSwitch

5.2.0.32.2 Arguments

5.2.0.32.2.1 Input

Execute	Description	Request the homing step procedure at rising edge. Outputs are reset when execute input is false.										
	Data type	BOOL										
	Range	[0 , 1]										
	Unit	N/A										
	Default	—										
AxisID	Description	Name of a declared instance of the AXIS_REF library function										
	Data type	AXIS_REF										
	Range	[1 , 256]										
	Unit	N/A										
	Default	—										
Direction	Description	Define the axis homing direction										
		<table border="1"> <thead> <tr> <th>Value</th> <th>Description</th> </tr> </thead> <tbody> <tr> <td>0</td> <td>clockwise rotation</td> </tr> <tr> <td>1</td> <td>counterclockwise rotation</td> </tr> <tr> <td>2</td> <td>clockwise if AbsoluteSwitch starts Off and negative if switch starts On</td> </tr> <tr> <td>3</td> <td>counter clockwise if AbsoluteSwitch starts On and positive if switch starts Off</td> </tr> </tbody> </table>	Value	Description	0	clockwise rotation	1	counterclockwise rotation	2	clockwise if AbsoluteSwitch starts Off and negative if switch starts On	3	counter clockwise if AbsoluteSwitch starts On and positive if switch starts Off
Value	Description											
0	clockwise rotation											
1	counterclockwise rotation											
2	clockwise if AbsoluteSwitch starts Off and negative if switch starts On											
3	counter clockwise if AbsoluteSwitch starts On and positive if switch starts Off											
	Data type	DINT										
	Range	[0 , 3]										
	Unit	N/A										
	Default	—										
SwitchMode	Description	Switch state to complete homing										
		<table border="1"> <thead> <tr> <th>Value</th> <th>Description</th> </tr> </thead> <tbody> <tr> <td>0</td> <td>switch is on</td> </tr> <tr> <td>1</td> <td>switch if off</td> </tr> <tr> <td>2</td> <td>rising edge of switch</td> </tr> <tr> <td>3</td> <td>falling edge of switch</td> </tr> </tbody> </table>	Value	Description	0	switch is on	1	switch if off	2	rising edge of switch	3	falling edge of switch
Value	Description											
0	switch is on											
1	switch if off											
2	rising edge of switch											
3	falling edge of switch											
	Data type	DINT										
	Range	[0 , 3]										
	Unit	N/A										
	Default	—										
Velocity	Description	Commanded velocity for the homing move										

	Data type	LREAL
	Range	—
	Unit	User unit/sec
	Default	—
Acceleration	Description	Commanded acceleration for the homing move
	Data type	LREAL
	Range	—
	Unit	User unit/sec ²
	Default	—
Deceleration	Description	Commanded deceleration for the homing move
	Data type	LREAL
	Range	—
	Unit	User unit/sec ²
	Default	—
Jerk	Description	Commanded jerk for the homing move (if zero, then trapezoidal acc/dec is used)
	Data type	LREAL
	Range	—
	Unit	User unit/sec ³
	Default	—
TorqueLimit	Description	Maximum torque applied for the homing move entered in thousandths of maximum torque, e.g. "250" is 250/1000, or 25%.
	Data type	LREAL
	Range	—
	Unit	User unit
	Default	—
TimeLimit	Description	Maximum time for homing move to complete. If exceeded the homing procedure will error out. 0= no time limit
	Data type	TIME
	Range	—
	Unit	sec
	Default	—

DistanceLimit	Description	Maximum distance for homing move to complete. If exceeded the homing procedure will error out. 0= no distance limit														
	Data type	LREAL														
	Range	—														
	Unit	User unit														
	Default	—														
AbsoluteSwitch	Description	The absolute switch input I/O point														
	Data type	BOOL														
	Range	[0 , 1]														
	Unit	N/A														
	Default	—														
PosLimitSwitch	Description	The positive direction limit switch input I/O point														
	Data type	BOOL														
	Range	[0 , 1]														
	Unit	N/A														
	Default	—														
NegLimitSwitch	Description	The negative direction limit switch input I/O point														
	Data type	BOOL														
	Range	[0 , 1]														
	Unit	N/A														
	Default	—														
SwitchMode	Description	Switch state to complete homing														
		<table border="1"> <thead> <tr> <th>Value</th> <th>Description</th> </tr> </thead> <tbody> <tr> <td>0</td> <td>abort</td> </tr> <tr> <td>1</td> <td>buffer</td> </tr> <tr> <td>2</td> <td>Blend to active</td> </tr> <tr> <td>3</td> <td>blend to next</td> </tr> <tr> <td>4</td> <td>blend to low velocity</td> </tr> <tr> <td>5</td> <td>blend to high velocity</td> </tr> </tbody> </table>	Value	Description	0	abort	1	buffer	2	Blend to active	3	blend to next	4	blend to low velocity	5	blend to high velocity
	Value	Description														
	0	abort														
	1	buffer														
	2	Blend to active														
	3	blend to next														
4	blend to low velocity															
5	blend to high velocity															
Data type	SINT															
Range	[0 , 5]															
Unit	N/A															
Default	—															

5.2.0.32.2.2 Output

Done	Description	Indicates the move completed successfully. The Command Position has reached the endpoint														
	Data type	BOOL														
	Unit	N/A														
Busy	Description	High from the moment the Execute input is one-shot to the time the move is ended														
	Data type	BOOL														
	Unit	N/A														
Active	Description	Indicates this move is the active move														
	Data type	BOOL														
	Unit	N/A														
CommandAborted	Description	Indicates the move was aborted														
	Data type	BOOL														
	Unit	N/A														
Error	Description	Indicates an invalid input was specified or the move was terminated due to an error														
	Data type	BOOL														
	Unit	N/A														
ErrorID	Description	Indicates the error if Error output is set to TRUE														
		<table border="1"> <thead> <tr> <th>Value</th> <th>Description</th> </tr> </thead> <tbody> <tr> <td>1</td> <td>TimeLimit exceeded</td> </tr> <tr> <td>2</td> <td>DistanceLimit exceeded</td> </tr> <tr> <td>3</td> <td>TorqueLimit exceeded</td> </tr> <tr> <td>4</td> <td>axis error stop state</td> </tr> <tr> <td>5</td> <td>axis not enabled</td> </tr> <tr> <td>6</td> <td>invalid inputs for Velocity-Acceleration-Deceleration</td> </tr> </tbody> </table>	Value	Description	1	TimeLimit exceeded	2	DistanceLimit exceeded	3	TorqueLimit exceeded	4	axis error stop state	5	axis not enabled	6	invalid inputs for Velocity-Acceleration-Deceleration
	Value	Description														
1	TimeLimit exceeded															
2	DistanceLimit exceeded															
3	TorqueLimit exceeded															
4	axis error stop state															
5	axis not enabled															
6	invalid inputs for Velocity-Acceleration-Deceleration															
Data type	INT															
Unit	N/A															

5.2.0.32.3 Usage

This physical layout has the risk that homing is started in the wrong direction (escaping the switch). To support such case, it implements a special behavior when Limit Switches are found (or the AbsSwitch itself is "On" at Execute):

- The homing is commanded in the most likely direction were the sensor can be found. In this example (-).
- The velocity is defined by the input.
- The torque is limited.
- Both Time and Distance Limits can cause an error if exceeded

- If any LimitSwitch is found during Homing (any of them), then a special process is started in the opposite direction, the AbsSwitch is searched to switch off (or On, depending on SwitchMode setting). The Edge (passed by), and homing process is restarted in the original direction and with the same conditions. This ensures that the end conditions are always same
- If the SwitchMode is either MC_SwitchNegative or MC_SwitchPositive, then the special process is also started in opposite direction depending from the switch state at 'execute'.
- The direction changes only when the specified Velocity is reached (InVelocity).
- This Function Block doesn't modify the actual position

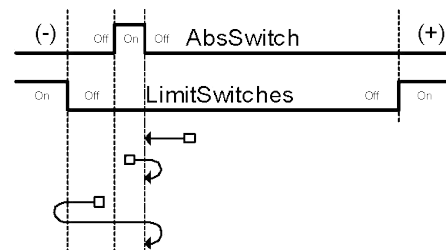
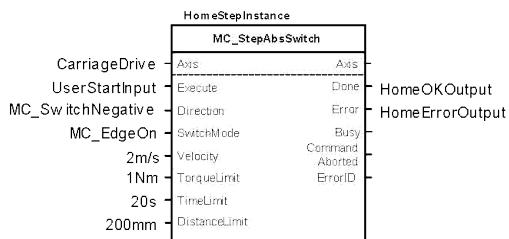
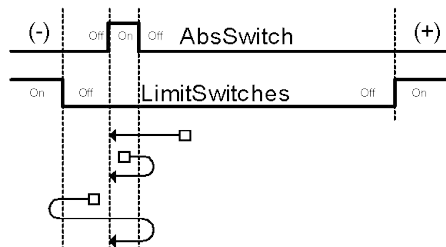
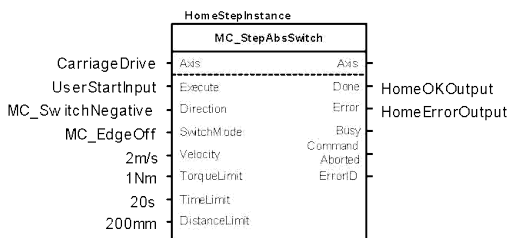
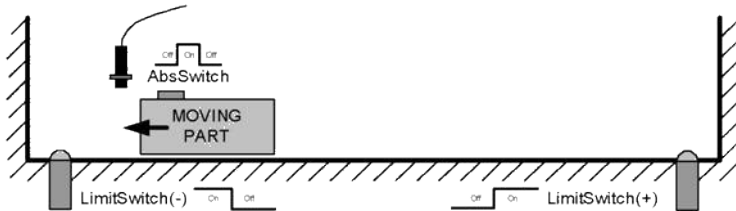

An overlapping switch configuration is also possible. This has same the behavior as working on the limit switches:

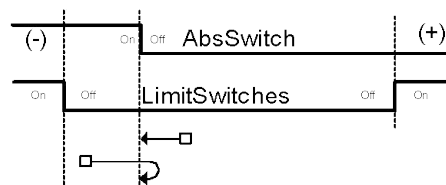
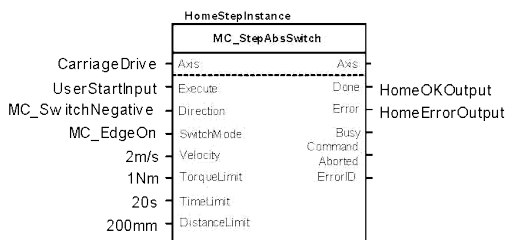

If the input Direction is set to a fixed direction (MC_Positive or MC_Negative), then the initial switch state is ignored (used for example in rotary axis where only one sense of rotation is allowed):

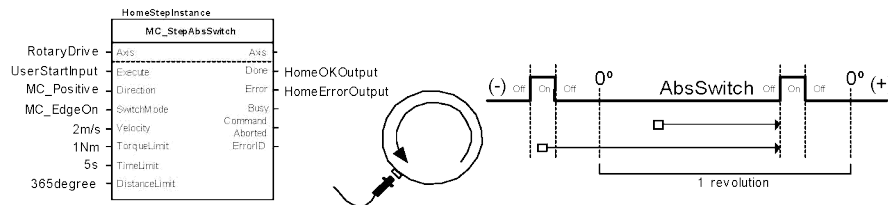

5.2.0.32.4 Related Functions

[MCFB_StepAbsolute](#)

[MCFB_StepRefPulse](#)

[MCFB_StepBlock](#)

[MCFB_StepLimitSwitch](#)

5.2.0.32.5 Example

5.2.0.32.5.1 Structured Text

```
NegativeDirection :=1;
```

```
RisingEdge :=2;
```

```
Velocity :=10000.0;
```

```
TorqueLimit :=50.0;
```

```
TimeLimit :=T#10s;
```

```
DistanceLimit :=10000.0;
```

```
Inst_MCFB_StepAbsSwitch( True, Axis1, NegativeDirection,
RisingEdge, Velocity, 1000, 1000, 0, TorqueLimit, TimeLimit,
DistanceLimit, AbsoluteSwitch, PosLimitSwitch, NegLimitSwitch, 0
);
```

```
HomeComplete :=Inst_MCFB_StepAbsSwitch.Done;
```

```
HomeBusy :=Inst_MCFB_StepAbsSwitch.Busy;
```

```
HomeActive :=Inst_MCFB_StepAbsSwitch.Active;
```

```
HomeAborted :=Inst_MCFB_StepAbsSwitch.CommandAborted;
```

```
HomeError :=Inst_MCFB_StepAbsSwitch.Error;
```

```
HomeErrorID :=Inst_MCFB_StepAbsSwitch.ErrorID;
```

```
(* AbsoluteSwitch, PosLimitSwitch, NegLimitSwitch are declared
I/O points *)
```

5.2.0.32.5.2 Ladder Diagram

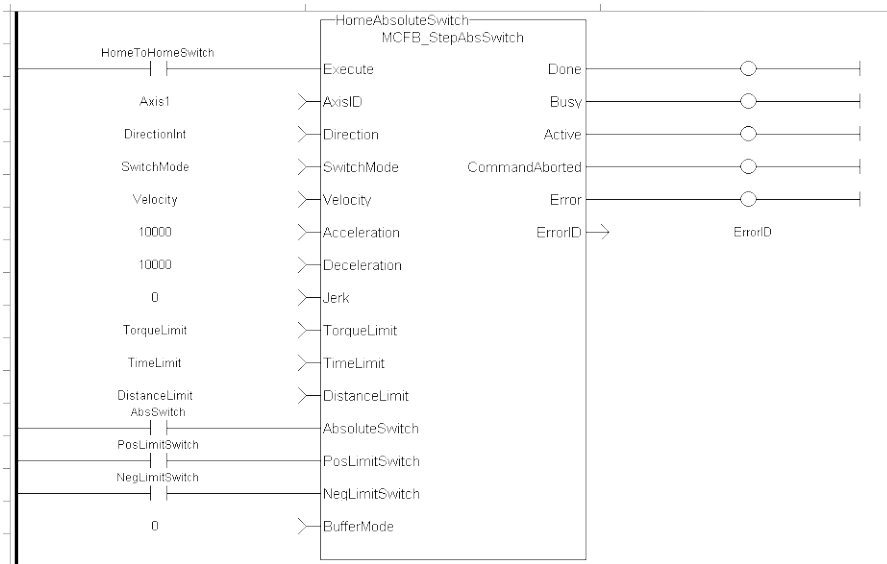

5.2.0.32.5.3 Function Block Diagram

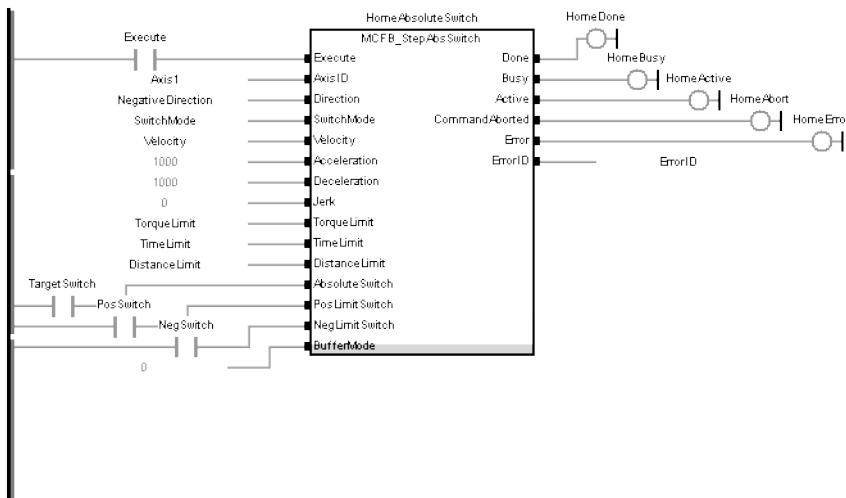

5.2.0.33 MCFB_StepBlock PLCopen

5.2.0.33.1 Description

This function block performs homing against a physical object, mechanically blocking the movement. In this mode there is no limit switch or Reference Pulse. Adequate torque limits are required for not damaging mechanics during homing process. The StepBlock condition is that we have reached the torque limit and real velocity falls below 5% of demanded.

The following figure shows the function block I/O:

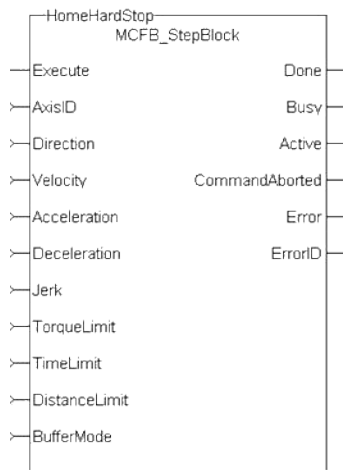

Figure 1-189: MCFB StepBlock

5.2.0.33.2 Arguments

5.2.0.33.2.1 Input

Execute	Description	Request the homing step procedure at rising edge. Outputs are reset when execute input is false.						
	Data type	BOOL						
	Range	[0 , 1]						
	Unit	N/A						
	Default	—						
AxisID	Description	Name of a declared instance of the AXIS_REF library function						
	Data type	AXIS_REF						
	Range	[1 , 256]						
	Unit	N/A						
	Default	—						
Direction	Description	Define the axis homing direction						
		<table border="1"> <thead> <tr> <th>Value</th> <th>Description</th> </tr> </thead> <tbody> <tr> <td>0</td> <td>clockwise rotation</td> </tr> <tr> <td>1</td> <td>counterclockwise rotation</td> </tr> </tbody> </table>	Value	Description	0	clockwise rotation	1	counterclockwise rotation
	Value	Description						
	0	clockwise rotation						
	1	counterclockwise rotation						
Data type	BOOL							
Range	[0 , 1]							
Default	—							
Velocity	Description	Commanded velocity for the homing move						
	Data type	LREAL						

	Range	—
	Unit	User unit/sec
	Default	—
Acceleration	Description	Commanded acceleration for the homing move
	Data type	LREAL
	Range	—
	Unit	User unit/sec ²
	Default	—
Deceleration	Description	Commanded deceleration for the homing move
	Data type	LREAL
	Range	—
	Unit	User unit/sec ²
	Default	—
Jerk	Description	Commanded jerk for the homing move (if zero, then trapezoidal acc/dec is used)
	Data type	LREAL
	Range	—
	Unit	User unit/sec ³
	Default	—
TorqueLimit	Description	Maximum torque applied for the homing move entered in thousandths of maximum torque, e.g. "250" is 250/1000, or 25%.
	Data type	LREAL
	Range	—
	Unit	User unit
	Default	—
TimeLimit	Description	Maximum time for homing move to complete. If exceeded the homing procedure will error out. 0= no time limit
	Data type	TIME
	Range	—
	Unit	sec
	Default	—

DistanceLimit	Description	Maximum distance for homing move to complete. If exceeded the homing procedure will error out. 0= no distance limit														
	Data type	LREAL														
	Range	—														
	Unit	User unit														
	Default	—														
BufferMode	Description	Define the homing move start action														
		<table border="1"> <thead> <tr> <th>Value</th> <th>Description</th> </tr> </thead> <tbody> <tr> <td>0</td> <td>abort</td> </tr> <tr> <td>1</td> <td>buffer</td> </tr> <tr> <td>2</td> <td>Blend to active</td> </tr> <tr> <td>3</td> <td>blend to next</td> </tr> <tr> <td>4</td> <td>blend to low velocity</td> </tr> <tr> <td>5</td> <td>blend to high velocity</td> </tr> </tbody> </table>	Value	Description	0	abort	1	buffer	2	Blend to active	3	blend to next	4	blend to low velocity	5	blend to high velocity
	Value	Description														
	0	abort														
	1	buffer														
	2	Blend to active														
	3	blend to next														
4	blend to low velocity															
5	blend to high velocity															
Data type	SINT															
Range	[0 , 5]															
Unit	N/A															
Default	—															

5.2.0.33.2.2 Output

Done	Description	Indicates the move completed successfully. The Command Position has reached the endpoint
	Data type	BOOL
	Unit	N/A
Busy	Description	High from the moment the Execute input is one-shot to the time the move is ended
	Data type	BOOL
	Unit	N/A
Active	Description	Indicates this move is the active move
	Data type	BOOL
	Unit	N/A
CommandAborted	Description	Indicates the move was aborted
	Data type	BOOL
	Unit	N/A

Error	Description	Indicates an invalid input was specified or the move was terminated due to an error														
	Data type	BOOL														
	Unit	N/A														
ErrorID	Description	Indicates the error if Error output is set to TRUE														
		<table border="1"> <thead> <tr> <th>Value</th> <th>Description</th> </tr> </thead> <tbody> <tr> <td>1</td> <td>TimeLimit exceeded</td> </tr> <tr> <td>2</td> <td>DistanceLimit exceeded</td> </tr> <tr> <td>3</td> <td></td> </tr> <tr> <td>4</td> <td>axis error stop state</td> </tr> <tr> <td>5</td> <td>axis not enabled</td> </tr> <tr> <td>6</td> <td>invalid inputs for Velocity-Acceleration-Deceleration</td> </tr> </tbody> </table>	Value	Description	1	TimeLimit exceeded	2	DistanceLimit exceeded	3		4	axis error stop state	5	axis not enabled	6	invalid inputs for Velocity-Acceleration-Deceleration
Value	Description															
1	TimeLimit exceeded															
2	DistanceLimit exceeded															
3																
4	axis error stop state															
5	axis not enabled															
6	invalid inputs for Velocity-Acceleration-Deceleration															
	Data type	INT														
	Unit	N/A														

5.2.0.33.3 Usage

Homing against a physical object, mechanically blocking the movement require adequate torque limits for not damaging mechanics during homing process. The StepBlock condition is that we have reached the torque limit and real velocity falls below 5% of demanded.

- Home is commanded by user in the desired homing direction at the selected Velocity
- Torque is limited.
- Time and Distance Limits can cause error if exceeded
- Process is finished when Torque is in limit condition and real velocity is below 5% of selected velocity.
- This Function Block doesn't modify actual position

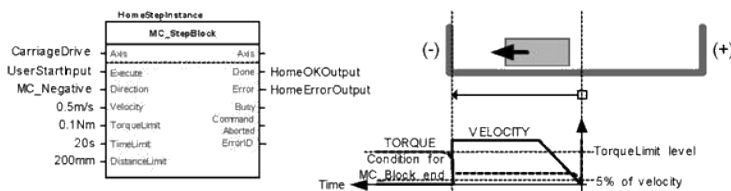
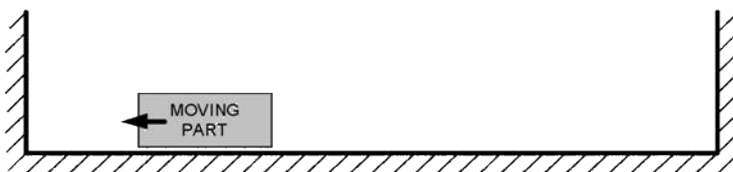

5.2.0.33.4 Related Functions

- [MCFB_StepAbsolute](#)
- [MCFB_StepRefPulse](#)
- [MCFB_StepAbsSwitch](#)
- [MCFB_StepLimitSwitch](#)

5.2.0.33.5 Example

5.2.0.33.5.1 Structured Text

```

PositiveDirection :=0;
Velocity :=10000.0;
TorqueLimit :=50.0;
TimeLimit :=T#10s;
DistanceLimit :=10000.0;

```

```

Inst_MCFB_StepBlock( True, Axis1, PositiveDirection, Velocity,
1000, 1000, 0, TorqueLimit, TimeLimit, DistanceLimit, 0 );

```

```

HomeComplete :=Inst_MCFB_StepBlock.Done;
HomeBusy :=Inst_MCFB_StepBlock.Busy;
HomeActive :=Inst_MCFB_StepBlock.Active;
HomeAborted :=Inst_MCFB_StepBlock.CommandAborted;
HomeError :=Inst_MCFB_StepBlock.Error;
HomeErrorID :=Inst_MCFB_StepBlock.ErrorID;

```

5.2.0.33.5.2 Ladder Diagram

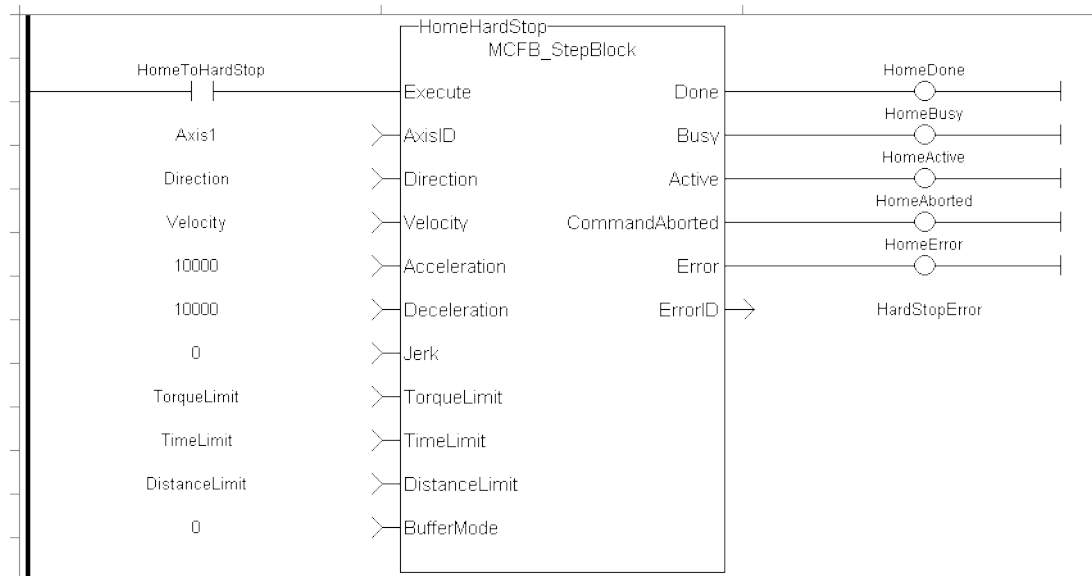

5.2.0.33.5.3 Function Block Diagram

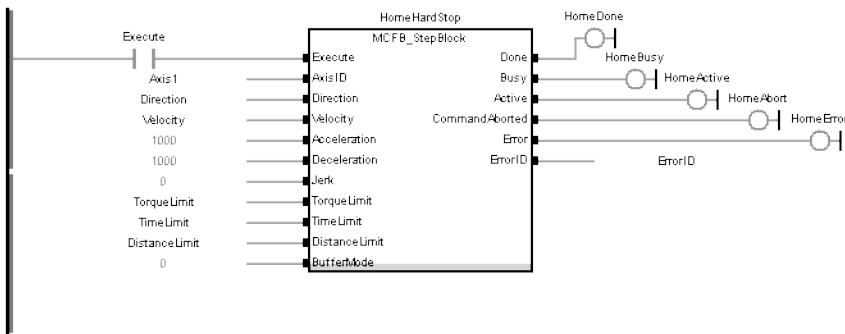

5.2.0.34 MCFB_StepLimitSwitch PLCopen

5.2.0.34.1 Description

This function block performs a single-axis home to a limit switch. In this case the limit switches (always active once moving part working area has been surpassed) are used for homing procedure.

The following figure shows the function block I/O:

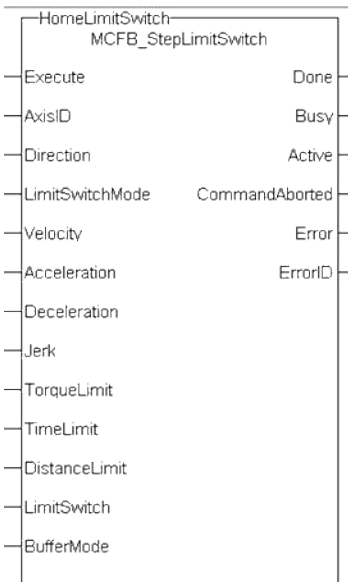

Figure 1-190: MCFB StepLimitSwitch

5.2.0.34.2 Arguments

5.2.0.34.2.1 Input

Execute	Description	Request the homing step procedure at rising edge. Outputs are reset when execute input is false.
	Data type	BOOL
	Range	[0, 1]
	Unit	N/A
	Default	—
AxisID	Description	Name of a declared instance of the AXIS_REF library function

	Data type	AXIS_REF										
	Range	[1 , 256]										
	Unit	N/A										
	Default	—										
Direction	Description	Define the axis homing direction										
		<table border="1"> <thead> <tr> <th>Value</th> <th>Description</th> </tr> </thead> <tbody> <tr> <td>0</td> <td>clockwise rotation</td> </tr> <tr> <td>1</td> <td>counterclockwise rotation</td> </tr> </tbody> </table>	Value	Description	0	clockwise rotation	1	counterclockwise rotation				
Value	Description											
0	clockwise rotation											
1	counterclockwise rotation											
	Data type	BOOL										
	Range	[0 , 1]										
	Unit	N/A										
	Default	—										
LimitSwitchMode	Description	Limit switch state to complete homing										
		<table border="1"> <thead> <tr> <th>Value</th> <th>Description</th> </tr> </thead> <tbody> <tr> <td>0</td> <td>switch is on</td> </tr> <tr> <td>1</td> <td>switch if off</td> </tr> <tr> <td>2</td> <td>rising edge of switch</td> </tr> <tr> <td>3</td> <td>falling edge of switch</td> </tr> </tbody> </table>	Value	Description	0	switch is on	1	switch if off	2	rising edge of switch	3	falling edge of switch
Value	Description											
0	switch is on											
1	switch if off											
2	rising edge of switch											
3	falling edge of switch											
	Data type	DINT										
	Range	[0 , 3]										
	Unit	N/A										
	Default	—										
Velocity	Description	Commanded velocity for the homing move										
	Data type	LREAL										
	Range	—										
	Unit	User unit/sec										
	Default	—										
Acceleration	Description	Commanded acceleration for the homing move										
	Data type	LREAL										
	Range	—										
	Unit	User unit/sec ²										
	Default	—										
Deceleration	Description	Commanded deceleration for the homing move										

	Data type	LREAL
	Range	—
	Unit	User unit/sec ²
	Default	—
Jerk	Description	Commanded jerk for the homing move (if zero, then trapezoidal acc/dec is used)
	Data type	LREAL
	Range	—
	Unit	User unit/sec ³
	Default	—
TorqueLimit	Description	Maximum torque applied for the homing move entered in thousandths of maximum torque, e.g. "250" is 250/1000, or 25%.
	Data type	LREAL
	Range	—
	Unit	User unit
	Default	—
TimeLimit	Description	Maximum time for homing move to complete. If exceeded the homing procedure will error out. 0= no time limit
	Data type	TIME
	Range	—
	Unit	sec
	Default	—
DistanceLimit	Description	Maximum distance for homing move to complete. If exceeded the homing procedure will error out. 0= no distance limit
	Data type	LREAL
	Range	—
	Unit	User unit
	Default	—
LimitSwitch	Description	The limit switch input I/O point
	Data type	BOOL
	Range	[0, 1]
	Unit	N/A

	Default	—														
BufferMode	Description	Define the homing move start action														
		<table border="1"> <thead> <tr> <th>Value</th> <th>Description</th> </tr> </thead> <tbody> <tr> <td>0</td> <td>abort</td> </tr> <tr> <td>1</td> <td>buffer</td> </tr> <tr> <td>2</td> <td>Blend to active</td> </tr> <tr> <td>3</td> <td>blend to next</td> </tr> <tr> <td>4</td> <td>blend to low velocity</td> </tr> <tr> <td>5</td> <td>blend to high velocity</td> </tr> </tbody> </table>	Value	Description	0	abort	1	buffer	2	Blend to active	3	blend to next	4	blend to low velocity	5	blend to high velocity
	Value	Description														
	0	abort														
	1	buffer														
	2	Blend to active														
	3	blend to next														
4	blend to low velocity															
5	blend to high velocity															
Data type	SINT															
Range	[0 , 5]															
Unit	N/A															
Default	—															

5.2.0.34.2.2 Output

Done	Description	Indicates the move completed successfully. The Command Position has reached the endpoint
	Data type	BOOL
	Unit	N/A
Busy	Description	High from the moment the Execute input is one-shot to the time the move is ended
	Data type	BOOL
	Unit	N/A
Active	Description	Indicates this move is the active move
	Data type	BOOL
	Unit	N/A
CommandAborted	Description	Indicates the move was aborted
	Data type	BOOL
	Unit	N/A
Error	Description	Indicates an invalid input was specified or the move was terminated due to an error
	Data type	BOOL
	Unit	N/A

ErrorID	Description	Indicates the error if Error output is set to TRUE	
		Value	Description
		1	TimeLimit exceeded
		2	DistanceLimit exceeded
		3	TorqueLimit exceeded
		4	axis error stop state
		5	axis not enabled
		6	invalid inputs for Velocity-Acceleration-Deceleration
	Data type	INT	
	Unit	N/A	

5.2.0.34.3 Usage

This homing procedure performs a homing function searching for sensor using only LimitSwitches. (A LimitSwitch has 1 "Off" (or "On") area).

- Home is commanded by user in the desired homing direction at the selected Velocity.
- If LimitSwitch is found 'On' on rising 'Execute', then the process is started in the opposite direction as specified, LimitSwitch is search for 'Off' (or On, depending on LimitSwitchMode setting) Edge (released), and process is restarted again in original direction. This ensures that the end conditions are always the same.
- The torque is limited.
- The Time and Distance Limits can cause error if exceeded
- The Direction changes only when the specified Velocity is reached, this ensures acceleration and deceleration spaces are fixed
- This Function Block doesn't modify actual position

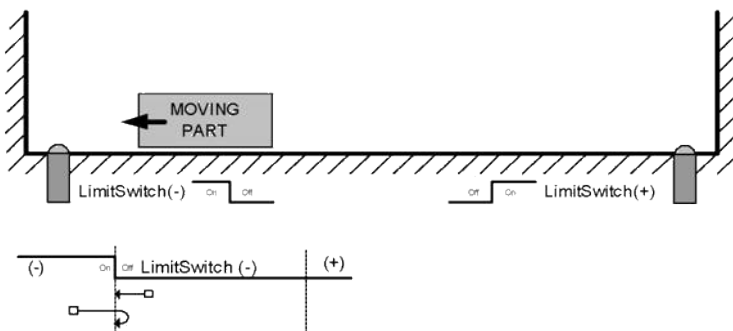

5.2.0.34.4 Related Functions

- [MCFB_StepAbsolute](#)
- [MCFB_StepRefPulse](#)
- [MCFB_StepBlock](#)
- [MCFB_StepAbsSwitch](#)

5.2.0.34.5 Example

5.2.0.34.5.1 Structured Text

```

PositiveDirection :=0;
RisingEdge :=2;
Velocity :=10000.0;
TorqueLimit :=50.0;
TimeLimit :=T#10s;
DistanceLimit :=10000.0;
    
```

```

Inst_MCFB_StepLimitSwitch( True, Axis1, PositiveDirection,
RisingEdge, Velocity, 1000, 1000, 0, TorqueLimit, TimeLimit,
DistanceLimit, LimitSwitch, 0 );
    
```

```

HomeComplete :=Inst_MCFB_StepLimitSwitch.Done;
HomeBusy :=Inst_MCFB_StepLimitSwitch.Busy;
HomeActive :=Inst_MCFB_StepLimitSwitch.Active;
HomeAborted :=Inst_MCFB_StepLimitSwitch.CommandAborted;
HomeError :=Inst_MCFB_StepLimitSwitch.Error;
HomeErrorID :=Inst_MCFB_StepLimitSwitch.ErrorID;
    
```

(* LimitSwitch is a declared I/O point *)

5.2.0.34.5.2 Ladder Diagram

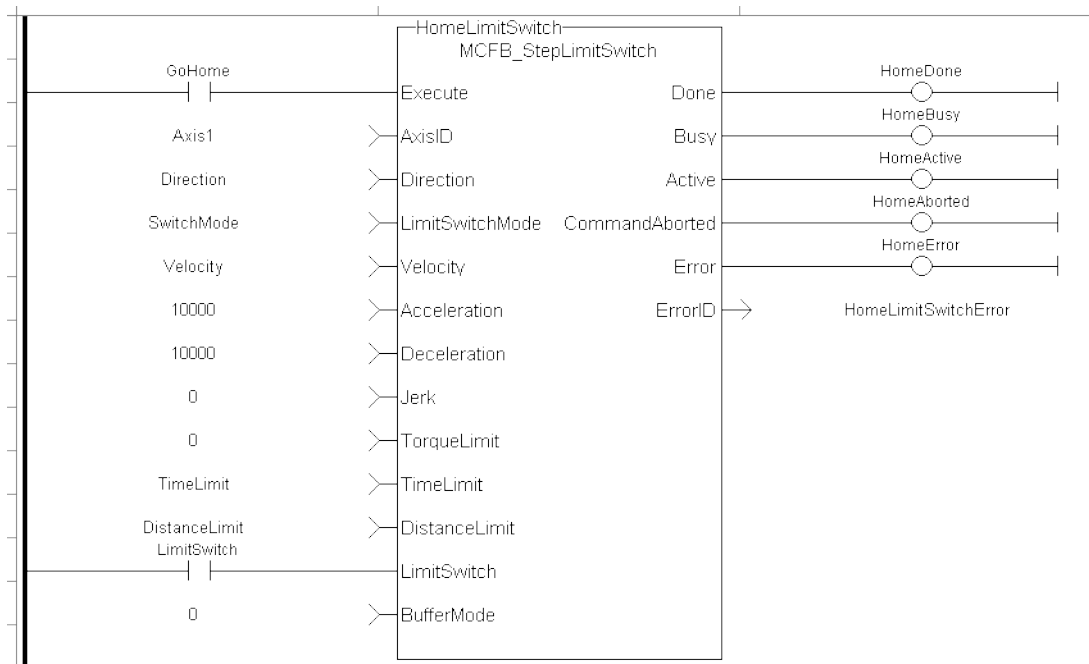

5.2.0.34.5.3 Function Block Diagram

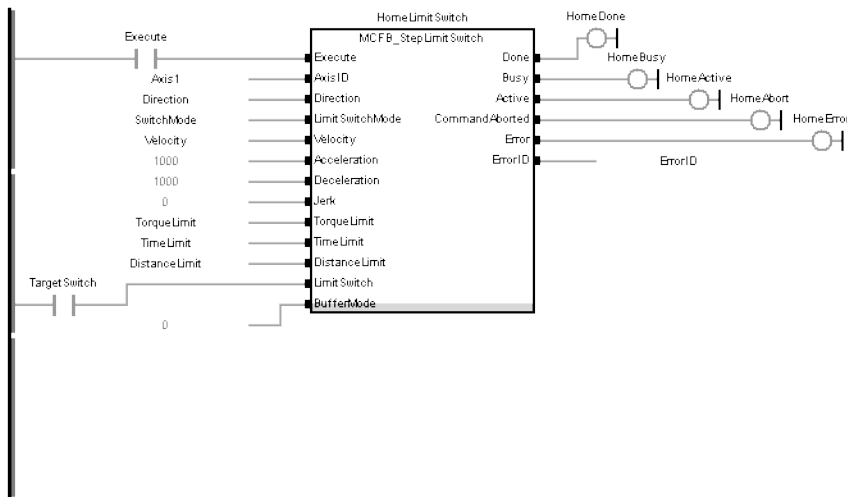

5.2.0.35 MCFB_StepRefPulse PLCopen

5.2.0.35.1 Description

This function block performs homing by searching for Zero pulse (also called Marker or reference pulse) in encoder. The reference pulse appears once per encoder revolution. The advantage in using Reference Pulse for homing is the higher accuracy and precision that can be achieved compared to traditional optical, mechanical or magnetic sensors.

The following figure shows the function block I/O:

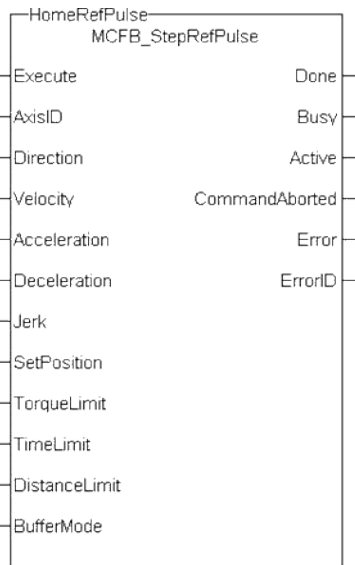

Figure 1-191: MCFB StepRefPulse

5.2.0.35.2 Arguments

5.2.0.35.2.1 Input

Execute	Description	Request the homing step procedure at rising edge
	Data type	BOOL
	Range	[0, 1]

	Unit	N/A										
	Default	—										
AxisID	Description	Name of a declared instance of the AXIS_REF library function										
	Data type	AXIS_REF										
	Range	[1 , 256]										
	Unit	N/A										
	Default	—										
Direction	Description	Define the axis homing direction										
		<table border="1"> <thead> <tr> <th>Value</th> <th>Description</th> </tr> </thead> <tbody> <tr> <td>0</td> <td>clockwise rotation</td> </tr> <tr> <td>1</td> <td>counterclockwise rotation</td> </tr> </tbody> </table>	Value	Description	0	clockwise rotation	1	counterclockwise rotation				
Value	Description											
0	clockwise rotation											
1	counterclockwise rotation											
	Data type	BOOL										
	Range	[0 , 1]										
	Unit	N/A										
	Default	—										
SwitchMode	Description	Switch state to complete homing										
		<table border="1"> <thead> <tr> <th>Value</th> <th>Description</th> </tr> </thead> <tbody> <tr> <td>0</td> <td>switch is on</td> </tr> <tr> <td>1</td> <td>switch if off</td> </tr> <tr> <td>2</td> <td>rising edge of switch</td> </tr> <tr> <td>3</td> <td>falling edge of switch</td> </tr> </tbody> </table>	Value	Description	0	switch is on	1	switch if off	2	rising edge of switch	3	falling edge of switch
Value	Description											
0	switch is on											
1	switch if off											
2	rising edge of switch											
3	falling edge of switch											
	Data type	DINT										
	Range	[0 , 3]										
	Unit	N/A										
	Default	—										
Velocity	Description	Commanded velocity for the homing move										
	Data type	LREAL										
	Range	—										
	Unit	User unit/sec										
	Default	—										
Acceleration	Description	Commanded acceleration for the homing move										
	Data type	LREAL										

	Range	—
	Unit	User unit/sec ²
	Default	—
Deceleration	Description	Commanded deceleration for the homing move
	Data type	LREAL
	Range	—
	Unit	User unit/sec ²
	Default	—
Jerk	Description	Commanded jerk for the homing move (if zero, then trapezoidal acc/dec is used)
	Data type	LREAL
	Range	—
	Unit	User unit/sec ³
	Default	—
SetPosition	Description	Value of the absolute position to be set when the homing move is done
	Data type	LREAL
	Range	—
	Unit	User unit
	Default	—
TorqueLimit	Description	Maximum torque applied for the homing move
	Data type	LREAL
	Range	—
	Unit	User unit
	Default	—
TimeLimit	Description	Maximum time for homing move to complete. If exceeded the homing procedure will error out. 0= no time limit
	Data type	TIME
	Range	—
	Unit	sec
	Default	—
DistanceLimit	Description	Maximum distance for homing move to complete. If exceeded the homing procedure will error out. 0= no distance limit

	Data type	LREAL														
	Range	—														
	Unit	User unit														
	Default	—														
BufferMode	Description	Define the homing move start action														
		<table border="1"> <thead> <tr> <th>Value</th> <th>Description</th> </tr> </thead> <tbody> <tr> <td>0</td> <td>abort</td> </tr> <tr> <td>1</td> <td>buffer</td> </tr> <tr> <td>2</td> <td>Blend to active</td> </tr> <tr> <td>3</td> <td>blend to next</td> </tr> <tr> <td>4</td> <td>blend to low velocity</td> </tr> <tr> <td>5</td> <td>blend to high velocity</td> </tr> </tbody> </table>	Value	Description	0	abort	1	buffer	2	Blend to active	3	blend to next	4	blend to low velocity	5	blend to high velocity
Value	Description															
0	abort															
1	buffer															
2	Blend to active															
3	blend to next															
4	blend to low velocity															
5	blend to high velocity															
	Data type	SINT														
	Range	[0 , 5]														
	Unit	N/A														
	Default	—														

5.2.0.35.2.2 Output

Done	Description	Indicates the move completed successfully. The Command Position has reached the endpoint
	Data type	BOOL
	Unit	N/A
Busy	Description	High from the moment the Execute input is one-shot to the time the move is ended
	Data type	BOOL
	Unit	N/A
Active	Description	Indicates this move is the active move
	Data type	BOOL
	Unit	N/A
CommandAborted	Description	Indicates the move was aborted
	Data type	BOOL
	Unit	N/A
Error	Description	Indicates an invalid input was specified or the move was terminated due to an error
	Data type	BOOL
	Unit	N/A

ErrorID	Description	Indicates the error if Error output is set to TRUE														
		<table border="1"> <thead> <tr> <th>Value</th> <th>Description</th> </tr> </thead> <tbody> <tr> <td>1</td> <td>TimeLimit exceeded</td> </tr> <tr> <td>2</td> <td>DistanceLimit exceeded</td> </tr> <tr> <td>3</td> <td>TorqueLimit exceeded</td> </tr> <tr> <td>4</td> <td>axis error stop state</td> </tr> <tr> <td>5</td> <td>axis not enabled</td> </tr> <tr> <td>6</td> <td>invalid inputs for Velocity-Acceleration-Deceleration</td> </tr> </tbody> </table>	Value	Description	1	TimeLimit exceeded	2	DistanceLimit exceeded	3	TorqueLimit exceeded	4	axis error stop state	5	axis not enabled	6	invalid inputs for Velocity-Acceleration-Deceleration
Value	Description															
1	TimeLimit exceeded															
2	DistanceLimit exceeded															
3	TorqueLimit exceeded															
4	axis error stop state															
5	axis not enabled															
6	invalid inputs for Velocity-Acceleration-Deceleration															
	Data type	INT														
	Unit	N/A														

5.2.0.35.3 Usage

This function Block performs homing by searching for Zero pulse (also called Marker or reference pulse) in encoder. The reference pulse appears once per encoder revolution.

- Home is commanded by user in the desired homing direction at the programmed velocity.
- First occurrence of the Reference Pulse, Homing is finished
- Torque is limited. Time and Distance Limits can cause error if exceeded
- This Function modifies actual position and sets to the "SetPosition" input value at the end

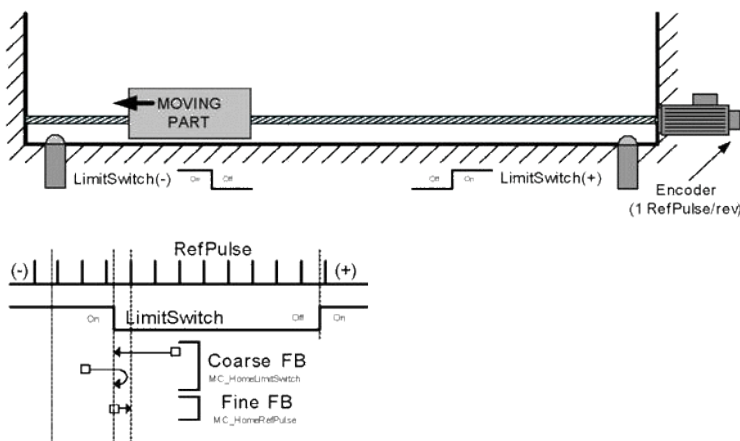

It is common that a first approach is performed against a mechanical sensor at higher velocity, and after a Reference Pulse, at a lower velocity. This is a traditional 2-Step homing (Coarse by external Switch in reverse and Fine by Reference Pulse in forward).

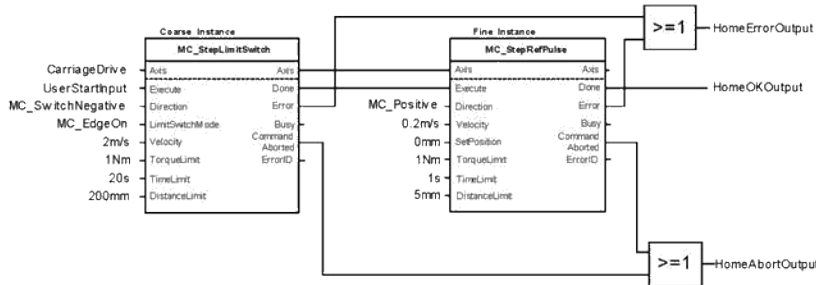

5.2.0.35.4 Related Functions

[MCFB_StepAbsolute](#)

[MCFB_StepAbsSwitch](#)

[MCFB_StepBlock](#)

[MCFB_StepLimitSwitch](#)

5.2.0.35.5 Example

5.2.0.35.5.1 Structured Text

```
PositiveDirection :=0;
Velocity :=10000.0;
SetPosition :=0.0;
TorqueLimit :=50.0;
TimeLimit :=T#10s;
DistanceLimit :=10000.0;

Inst_MCFB_StepRefPulse( True, Axis1, PositiveDirection,
Velocity, 1000, 1000, 0, SetPosition, TorqueLimit, TimeLimit,
DistanceLimit, 0 );

HomeComplete :=Inst_MCFB_StepRefPulse.Done;
HomeBusy :=Inst_MCFB_StepRefPulse.Busy;
HomeActive :=Inst_MCFB_StepRefPulse.Active;
HomeAborted :=Inst_MCFB_StepRefPulse.CommandAborted;
HomeError :=Inst_MCFB_StepRefPulse.Error;
HomeErrorID :=Inst_MCFB_StepRefPulse.ErrorID;
```

5.2.0.35.5.2 Ladder Diagram

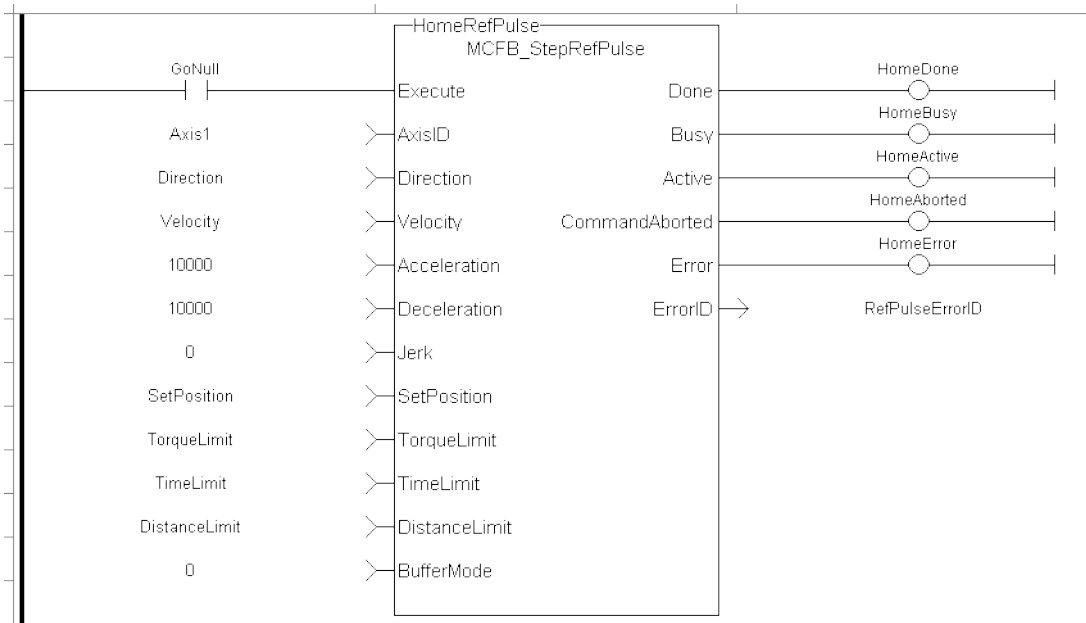

5.2.0.35.5.3 Function Block Diagram

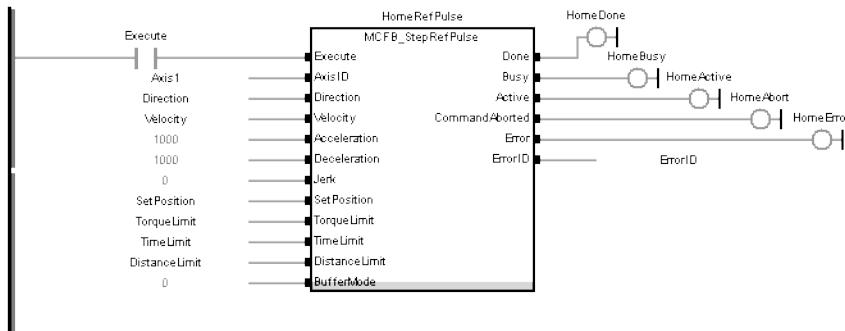

5.2.0.36 MCFB_StepAbsSwitchFastInput PLCopen ✔

5.2.0.36.1 Description

This function block performs a homing function by searching for an absolute positioned external physical switch. The switch must be connected to one of the two fast inputs on the Axis' AKD drive. (An Absolute Switch has two "Off" (or "On") areas.

The following figure shows the function block I/O:

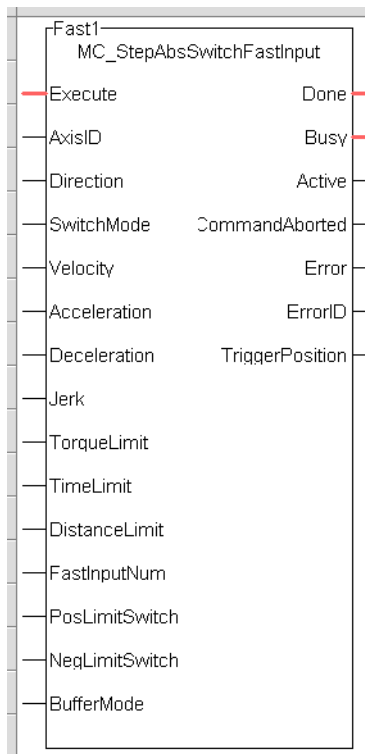

Figure 1-192: MCFB StepAbsSwitchFastInput

5.2.0.36.1.1 Input

Execute	Description	Request the homing step procedure at rising edge. Outputs are reset when execute input is false.						
	Data type	BOOL						
	Range	[0 , 1]						
	Unit	N/A						
	Default	—						
AxisID	Description	Structure for specified Axis desired to home						
	Data type	AXIS_REF						
	Range	[1 , 256]						
	Unit	N/A						
	Default	—						
Direction	Description	Define the axis homing direction						
		<table border="1"> <thead> <tr> <th>Value</th> <th>Description</th> </tr> </thead> <tbody> <tr> <td>0</td> <td>clockwise rotation</td> </tr> <tr> <td>1</td> <td>counterclockwise rotation</td> </tr> </tbody> </table>	Value	Description	0	clockwise rotation	1	counterclockwise rotation
	Value	Description						
0	clockwise rotation							
1	counterclockwise rotation							
Data type	BOOL							

	Range	[0 , 1]										
	Unit	N/A										
	Default	—										
SwitchMode	Description	Switch state to complete homing										
		<table border="1"> <thead> <tr> <th>Value</th> <th>Description</th> </tr> </thead> <tbody> <tr> <td>0</td> <td>when rising edge of sensor</td> </tr> <tr> <td>1</td> <td>when falling edge</td> </tr> <tr> <td>2</td> <td>rising edge when traveling in positive direction but falling edge in negative direction</td> </tr> <tr> <td>3</td> <td>falling edge when traveling in negative direction but rising edge in positive direction</td> </tr> </tbody> </table>	Value	Description	0	when rising edge of sensor	1	when falling edge	2	rising edge when traveling in positive direction but falling edge in negative direction	3	falling edge when traveling in negative direction but rising edge in positive direction
Value	Description											
0	when rising edge of sensor											
1	when falling edge											
2	rising edge when traveling in positive direction but falling edge in negative direction											
3	falling edge when traveling in negative direction but rising edge in positive direction											
	Data type	DINT										
	Range	[0 , 3]										
	Unit	N/A										
	Default	—										
Velocity	Description	Commanded velocity for the homing move										
	Data type	LREAL										
	Range	—										
	Unit	User unit/sec										
	Default	—										
Acceleration	Description	Commanded acceleration for the homing move										
	Data type	LREAL										
	Range	—										
	Unit	User unit/sec ²										
	Default	—										
Deceleration	Description	Commanded deceleration for the homing move										
	Data type	LREAL										
	Range	—										
	Unit	User unit/sec ²										
	Default	—										
Jerk	Description	Commanded jerk for the homing move (if zero, then trapezoidal acc/dec is used)										
	Data type	LREAL										
	Range	—										

	Unit	User unit/sec ³
	Default	—
TorqueLimit	Description	Maximum torque applied for the homing move entered in thousandths of maximum torque, e.g. "250" is 250/1000, or 25%.
	Data type	LREAL
	Range	—
	Unit	User unit
	Default	—
TimeLimit	Description	Maximum time for homing move to complete. If exceeded the homing procedure will error out. 0= no time limit
	Data type	TIME
	Range	—
	Unit	sec
	Default	—
DistanceLimit	Description	Maximum distance for homing move to complete. If exceeded the homing procedure will error out. 0= no distance limit
	Data type	LREAL
	Range	—
	Unit	User unit
	Default	—
FastInputNum	Description	0 for first fast input (X7 Pin 10), 1 for second fast input (X7 pin 9)
	Data type	BOOL
	Range	[0 , 1]
	Unit	N/A
	Default	—
PosLimitSwitch	Description	The positive direction limit switch input I/O point
	Data type	BOOL
	Range	[0 , 1]
	Unit	N/A
	Default	—
NegLimitSwitch	Description	The negative direction limit switch input I/O point

	Data type	BOOL														
	Range	[0 , 1]														
	Unit	N/A														
	Default	—														
BufferMode	Description	Define the homing move start action														
		<table border="1"> <thead> <tr> <th>Value</th> <th>Description</th> </tr> </thead> <tbody> <tr> <td>0</td> <td>abort</td> </tr> <tr> <td>1</td> <td>buffer</td> </tr> <tr> <td>2</td> <td>Blend to active</td> </tr> <tr> <td>3</td> <td>blend to next</td> </tr> <tr> <td>4</td> <td>blend to low velocity</td> </tr> <tr> <td>5</td> <td>blend to high velocity</td> </tr> </tbody> </table>	Value	Description	0	abort	1	buffer	2	Blend to active	3	blend to next	4	blend to low velocity	5	blend to high velocity
Value	Description															
0	abort															
1	buffer															
2	Blend to active															
3	blend to next															
4	blend to low velocity															
5	blend to high velocity															
	Data type	SINT														
	Range	[0 , 5]														
	Unit	N/A														
	Default	—														

5.2.0.36.1.2 Output

Done	Description	Indicates the move completed successfully. The Command Position has reached the endpoint
	Data type	BOOL
	Unit	N/A
Busy	Description	High from the moment the Execute input is one-shot to the time the move is ended
	Data type	BOOL
	Unit	N/A
Active	Description	Set when the function block is active
	Data type	BOOL
	Unit	N/A
CommandAborted	Description	Indicates the move was aborted
	Data type	BOOL
	Unit	N/A
Error	Description	Signals that an error has occurred within the function block
	Data type	BOOL
	Unit	N/A

ErrorID	Description	Indicates the error if Error output is set to TRUE														
		<table border="1"> <thead> <tr> <th>Value</th> <th>Description</th> </tr> </thead> <tbody> <tr> <td>1</td> <td>TimeLimit exceeded</td> </tr> <tr> <td>2</td> <td>DistanceLimit exceeded</td> </tr> <tr> <td>3</td> <td>TorqueLimit exceeded</td> </tr> <tr> <td>4</td> <td>axis error stop state</td> </tr> <tr> <td>5</td> <td>axis not enabled</td> </tr> <tr> <td>6</td> <td>invalid inputs for Velocity-Accel-Decel</td> </tr> </tbody> </table>	Value	Description	1	TimeLimit exceeded	2	DistanceLimit exceeded	3	TorqueLimit exceeded	4	axis error stop state	5	axis not enabled	6	invalid inputs for Velocity-Accel-Decel
	Value	Description														
	1	TimeLimit exceeded														
	2	DistanceLimit exceeded														
	3	TorqueLimit exceeded														
	4	axis error stop state														
5	axis not enabled															
6	invalid inputs for Velocity-Accel-Decel															
Data type	INT															
Unit	N/A															
TriggerPosition	Data type	LREAL														
	Range	-														
	Unit	User units														
	Default	-														

5.2.0.36.2 Usage

- The homing is commanded in the most likely direction were the sensor can be found. In this example (-).
- If any LimitSwitch is found during Homing (any of them), then a special process is started in the opposite direction, the AbsSwitch is searched to switch off (or On, depending on SwitchMode setting). The Edge (passed by), and homing process is restarted in the original direction and with the same conditions. This ensures that the end conditions are always same.

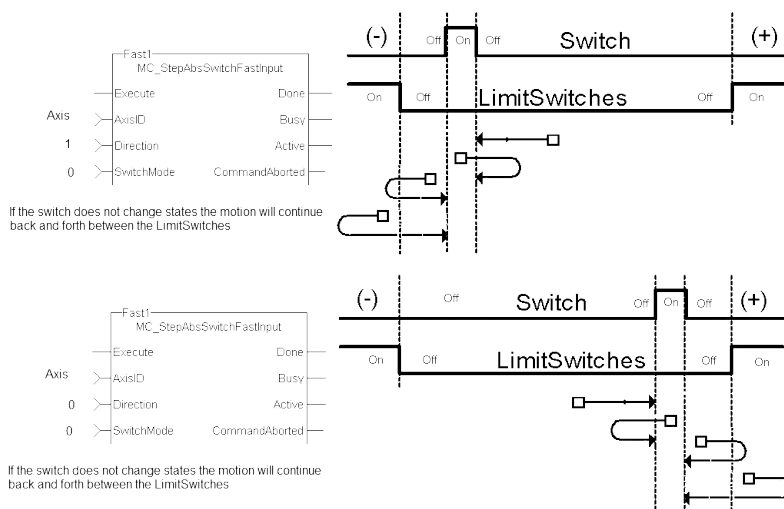

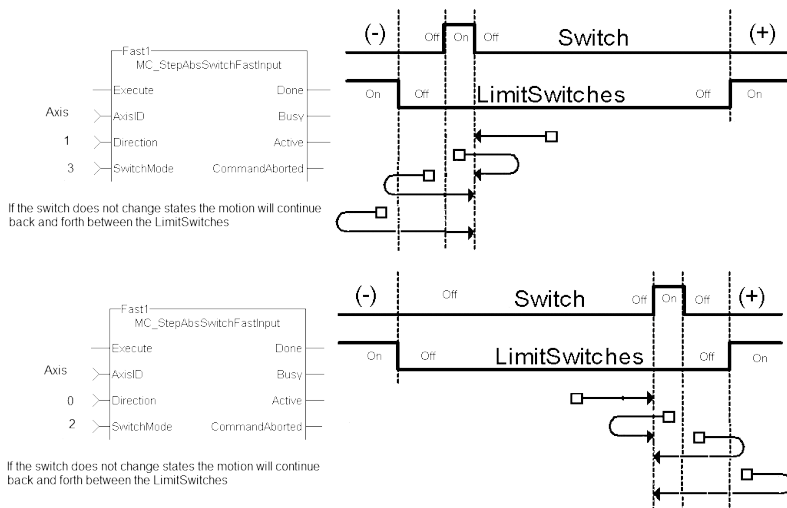

5.2.0.36.3 Related Functions

[MCFB_StepLimitSwitchFastInput](#)

5.2.0.36.4 Example

5.2.0.36.4.1 Structured Text

```

Execute_1 :=1;

(*Positive_Switch and Negative_Switch are physical hardware in
Dictionary. *)

Inst_MC_StepAbsSwitchFastInput( Execute_1, Axis1, 0, 0,
10000.0,Acceleration:=10000.0, 10000.0, 0, 0, 0, 0, Positive_
Switch , Negative_Switch , 0)

HomeComplete := Inst_MC_StepAbsSwitchFastInput.Done;
HomeBusy := Inst_MC_StepAbsSwitchFastInput.Busy;
HomeActive := Inst_MC_StepAbsSwitchFastInput.Active;
HomeAborted := Inst_MC_StepAbsSwitchFastInput.CommandAborted;
HomeError := Inst_MC_StepAbsSwitchFastInput.Error;
HomeErrorID := Inst_MC_StepAbsSwitchFastInput.ErrorID;
HomeTriggerPosition := Inst_MC_
StepAbsSwitchFastInput.TriggerPosition;
    
```

5.2.0.36.4.2 FBD

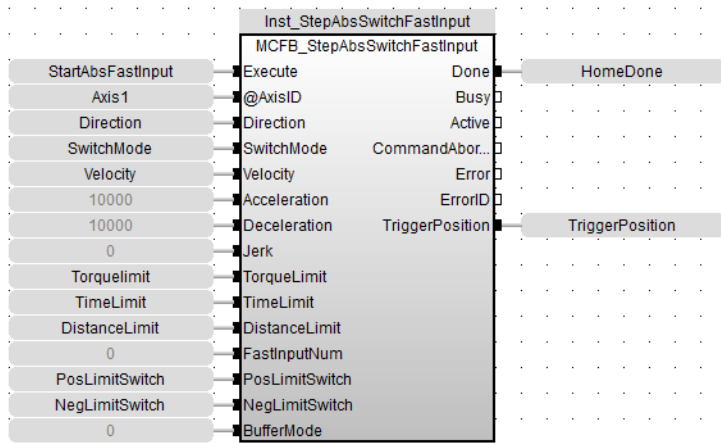

5.2.0.36.4.3 Ladder Diagram

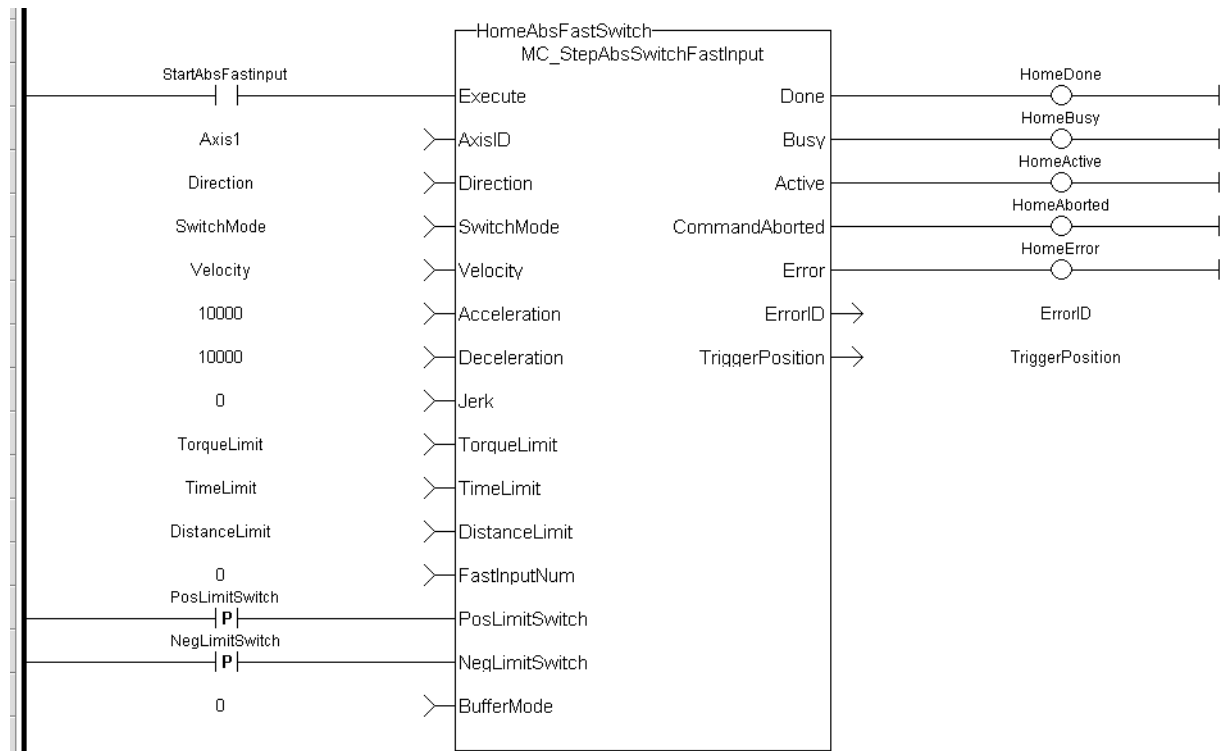

(* PosLimitSwitch, NegLimitSwitch are declared I/O points *)

5.2.0.37 MCFB_StepLimitSwitchFastInput PLCopen

5.2.0.37.1 Description

This function block performs a homing function by searching for an external physical switch. The switch must be connected to one of the two fast inputs on the Axis' AKD drive. The Axis will move and when a fast input is triggered, the triggered axis will then perform an absolute move to the latched position.

The following figure shows the function block I/O:

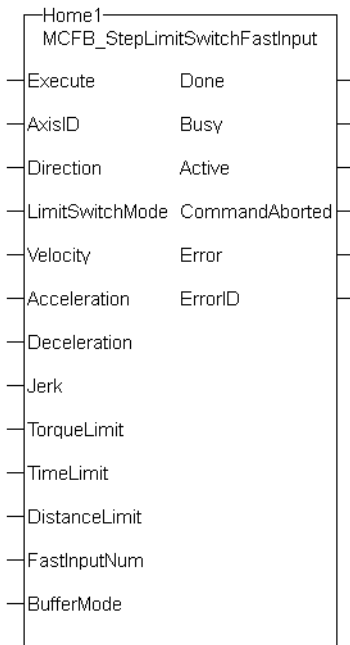

Figure 1-193: MCFB StepLimitSwitchFastInput

5.2.0.37.1.1 Input

Execute	Description	Request the homing step procedure at rising edge. Outputs are reset when execute input is false.						
	Data type	BOOL						
	Range	[0 , 1]						
	Unit	N/A						
	Default	—						
AxisID	Description	Structure for specified Axis desired to home						
	Data type	AXIS_REF						
	Range	[1 , 256]						
	Unit	N/A						
	Default	—						
Direction	Description	Define the axis homing direction						
		<table border="1"> <thead> <tr> <th>Value</th> <th>Description</th> </tr> </thead> <tbody> <tr> <td>0</td> <td>clockwise rotation</td> </tr> <tr> <td>1</td> <td>counterclockwise rotation</td> </tr> </tbody> </table>	Value	Description	0	clockwise rotation	1	counterclockwise rotation
Value	Description							
0	clockwise rotation							
1	counterclockwise rotation							
	Data type	BOOL						
	Range	[0 , 1]						
	Unit	N/A						
	Default	—						

LimitSwitchMode	Description	Limit switch state to complete homing						
		<table border="1"> <thead> <tr> <th>Value</th> <th>Description</th> </tr> </thead> <tbody> <tr> <td>0</td> <td>when rising edge of sensor</td> </tr> <tr> <td>1</td> <td>when falling edge</td> </tr> </tbody> </table>	Value	Description	0	when rising edge of sensor	1	when falling edge
	Value	Description						
	0	when rising edge of sensor						
	1	when falling edge						
Data type	DINT							
Range	[0, 1]							
Unit	N/A							
	Default	—						
Velocity	Description	Commanded velocity for the homing move						
	Data type	LREAL						
	Range	—						
	Unit	User unit/sec						
	Default	—						
Acceleration	Description	Commanded acceleration for the homing move						
	Data type	LREAL						
	Range	—						
	Unit	User unit/sec ²						
	Default	—						
Deceleration	Description	Commanded deceleration for the homing move						
	Data type	LREAL						
	Range	—						
	Unit	User unit/sec ²						
	Default	—						
Jerk	Description	Commanded jerk for the homing move (if zero, then trapezoidal acc/dec is used)						
	Data type	LREAL						
	Range	—						
	Unit	User unit/sec ³						
	Default	—						
TorqueLimit	Description	Maximum torque applied for the homing move						
	Data type	LREAL						
	Range	—						

	Unit	User unit entered in thousandths of maximum torque, e.g. "250" is 250/1000, or 25%.														
	Default	—														
TimeLimit	Description	Maximum time for homing move to complete. If exceeded the homing procedure will error out. 0= no time limit														
	Data type	TIME														
	Range	—														
	Unit	sec														
	Default	—														
DistanceLimit	Description	Maximum distance for homing move to complete. If exceeded the homing procedure will error out. 0= no distance limit														
	Data type	LREAL														
	Range	—														
	Unit	User unit														
	Default	—														
FastInputNum	Description	0 for first fast input (X7 Pin 10), 1 for second fast input (X7 pin 9)														
	Data type	BOOL														
	Range	[0 , 1]														
	Unit	N/A														
	Default	—														
BufferMode	Description	Define the homing move start action														
		<table border="1"> <thead> <tr> <th>Value</th> <th>Description</th> </tr> </thead> <tbody> <tr> <td>0</td> <td>abort</td> </tr> <tr> <td>1</td> <td>buffer</td> </tr> <tr> <td>2</td> <td>Blend to active</td> </tr> <tr> <td>3</td> <td>blend to next</td> </tr> <tr> <td>4</td> <td>blend to low velocity</td> </tr> <tr> <td>5</td> <td>blend to high velocity</td> </tr> </tbody> </table>	Value	Description	0	abort	1	buffer	2	Blend to active	3	blend to next	4	blend to low velocity	5	blend to high velocity
Value	Description															
0	abort															
1	buffer															
2	Blend to active															
3	blend to next															
4	blend to low velocity															
5	blend to high velocity															
	Data type	SINT														
	Range	[0 , 5]														
	Unit	N/A														
	Default	—														

5.2.0.37.1.2 Output

Done	Description	Indicates the move completed successfully. The Command Position has reached the endpoint														
	Data type	BOOL														
	Unit	N/A														
Busy	Description	High from the moment the Execute input is one-shot to the time the move is ended														
	Data type	BOOL														
	Unit	N/A														
Active	Description	Set when the function block is active														
	Data type	BOOL														
	Unit	N/A														
CommandAborted	Description	Indicates the move was aborted														
	Data type	BOOL														
	Unit	N/A														
Error	Description	Signals that an error has occurred within the function block														
	Data type	BOOL														
	Unit	N/A														
ErrorID	Description	Indicates the error if Error output is set to TRUE														
		<table border="1"> <thead> <tr> <th>Value</th> <th>Description</th> </tr> </thead> <tbody> <tr> <td>1</td> <td>TimeLimit exceeded</td> </tr> <tr> <td>2</td> <td>DistanceLimit exceeded</td> </tr> <tr> <td>3</td> <td>TorqueLimit exceeded</td> </tr> <tr> <td>4</td> <td>axis error stop state</td> </tr> <tr> <td>5</td> <td>axis not enabled</td> </tr> <tr> <td>6</td> <td>invalid inputs for Velocity-Accel-Decel</td> </tr> </tbody> </table>	Value	Description	1	TimeLimit exceeded	2	DistanceLimit exceeded	3	TorqueLimit exceeded	4	axis error stop state	5	axis not enabled	6	invalid inputs for Velocity-Accel-Decel
	Value	Description														
1	TimeLimit exceeded															
2	DistanceLimit exceeded															
3	TorqueLimit exceeded															
4	axis error stop state															
5	axis not enabled															
6	invalid inputs for Velocity-Accel-Decel															
Data type	INT															
Unit	N/A															

5.2.0.37.2 Usage

The homing is commanded in the most likely direction were the sensor can be found. In this example (-).

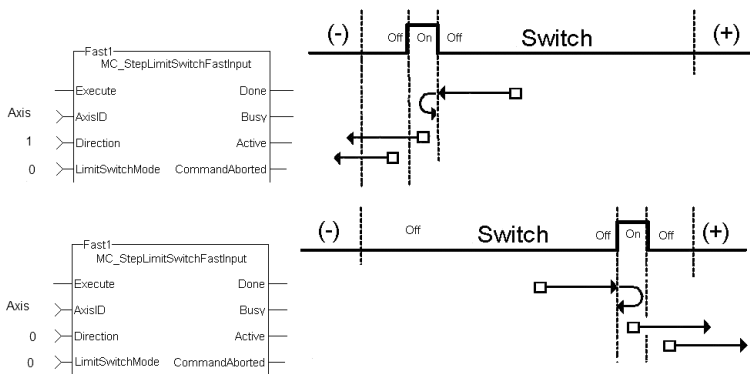

5.2.0.37.3 Related Functions

[MCFB_StepAbsSwitchFastInput](#)

5.2.0.37.4 Example

5.2.0.37.4.1 Structured Text

```
Execute_1 := 1;

Inst_MCFB_StepLimitSwitchFastInput( Execute_1, Axis1, 0, 0, 10000.0,
10000.0, 10000.0, 0, 0, 0, 0, 0, 0);

HomeComplete := Inst_MCFB_StepLimitSwitchFastInput.Done;
HomeBusy := Inst_MCFB_StepLimitSwitchFastInput.Busy;
HomeActive := Inst_MCFB_StepLimitSwitchFastInput.Active;
HomeAborted := Inst_MCFB_StepLimitSwitchFastInput.CommandAborted;
HomeError := Inst_MCFB_StepLimitSwitchFastInput.Error;
HomeErrorID := Inst_MCFB_StepLimitSwitchFastInput.ErrorID;
```

5.2.0.37.4.2 FBD

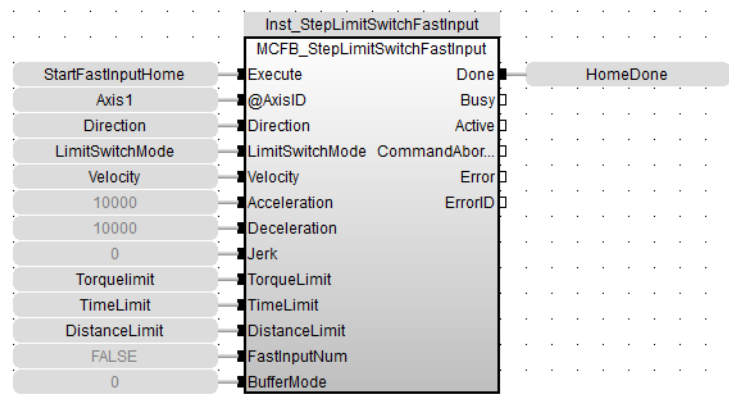

5.2.0.37.4.3 Ladder Diagram

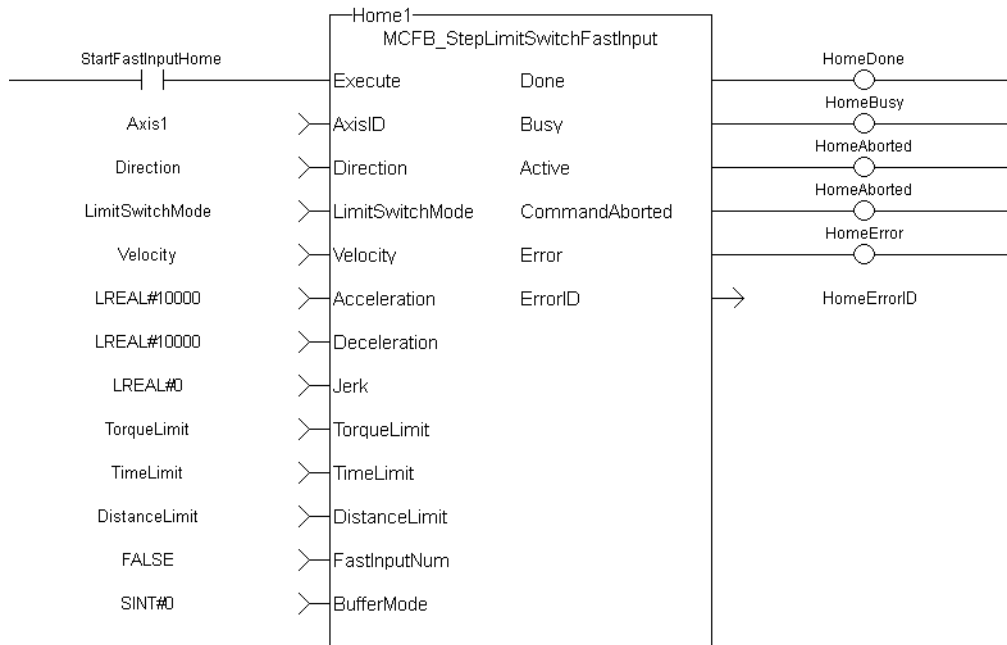

5.2.0.38 MCFB_Jog PLCopen

5.2.0.38.1 Description

This function block is defined to jog an axis in the selected direction at a defined speed. The En input (FFLD editor only) must be high. Typically wired to the rail.

The AxisID selects the axis to jog. The JogPlus and JogMinus inputs select the direction the motion will occur in. Only one of these inputs should be enabled at a given time. If both are selected the motion will stop. If other motion is active when the jog is requested that motion will be aborted and the jog will start.

The following figure shows the function block I/O

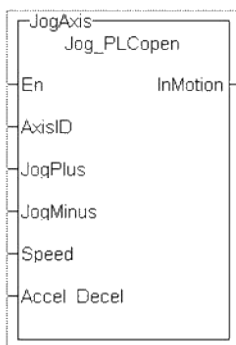

Figure 1-194: Jog for PLCopen

5.2.0.38.2 Arguments

5.2.0.38.2.1 Input

En	Description
	Enables execution (FFLD only)

	Data type	BOOL
	Range	—
	Unit	N/A
	Default	—
AxisID	Description	ID Name of the Axis
	Data type	DINT
	Range	—
	Unit	N/A
	Default	—
JogPlus	Description	Enables a Jog in the plus direction
	Data type	BOOL
	Range	[0 , 1]
	Unit	N/A
	Default	—
JogMinus	Description	Enables a Jog in the Minus direction
	Data type	BOOL
	Range	[0 , 1]
	Unit	N/A
	Default	—
Speed	Description	Rate at which the axis will move
	Data type	LREAL
	Range	—
	Unit	User unit/sec
	Default	—
Accel Decel	Description	Linear Acc/Dec rate
	Data type	LREAL
	Range	—
	Unit	User unit/sec ²
	Default	—

5.2.0.38.2.2 Output

InMotion	Description	Jogging is active when TRUE
	Data type	BOOL

Unit	N/A
-------------	-----

5.2.0.38.3 Usage

This function Block is used to command motion in a designated direction at a defined rate. This may be used where continuous motion required as in a conveyor system, or in a setup mode for manually jogging the axis. Motion will start when the JogPlus or JogMinus input is true. It will stop when the input goes false.

5.2.0.38.4 Related Functions

[MC_MoveVelocity](#)

5.2.0.38.5 Example

5.2.0.38.5.1 Structured Text

```
InMotion := Inst_Jog_PLCoPen(Axis1, Switch_1, Switch_2, 600, 10000);
```

5.2.0.38.5.2 Ladder Diagram

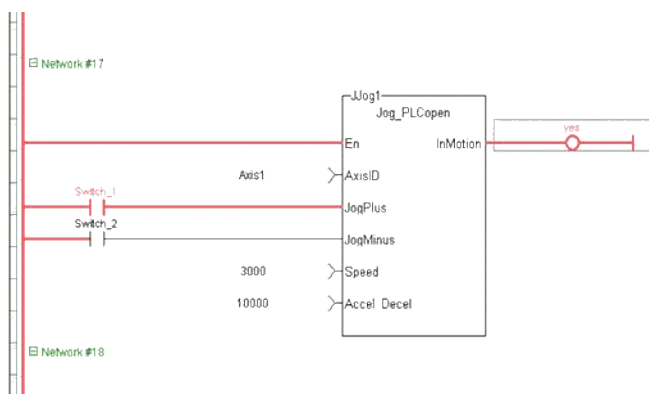

5.2.0.38.5.3 Function Block Diagram

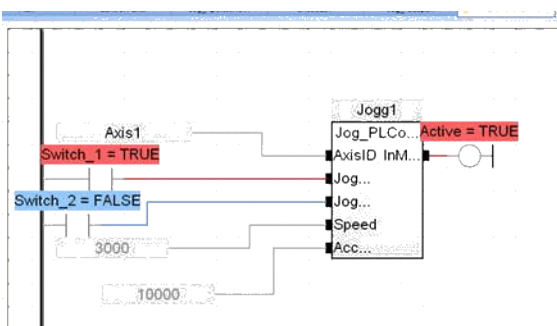

5.2.0.39 MCFB_GearedWebTension PLCoPen ✔

This Kollmorgen UDFB facilitates dancer and tension control in an electronic geared master/slave machine design. This is done by using the analog feedback from a LVDT, tension transducer, potentiometer, encoder, resolver or some other similar device. The analog feedback value is compared to a pre-determined analog set-point. The difference or error is used in a PID algorithm with the summed output driving changes to the master/slave gearing relationship. This results in the slave axis either speeding up or slowing down to maintain desired tension.

The following figure shows the function block I/O.

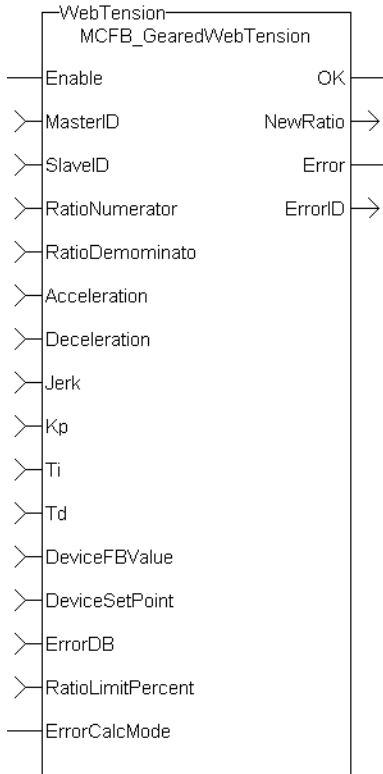

Figure 1-195: MCFB_GearedWebTension Function Block I/O

5.2.0.39.1 Arguments

5.2.0.39.1.1 Inputs

Enable	Description	Enables execution
	Data Type	BOOL
	Range	[0,1]
	Unit	N/A
	Default	-
MasterID	Description	Identifies the master axis
	Data Type	AXIS_REF
	Range	
	Unit	N/A
	Default	-
SlaveID	Description	Identifies the slave axis
	Data Type	AXIS_REF
	Range	
	Unit	N/A

	Default	-
RatioNumerator	Description	Numerator of the master/slave ratio
	Data Type	DINT
	Range	[-2147483648 to +2147483647]
	Unit	N/A
	Default	-
RatioDenominator	Description	Denominator of the master/slave ratio
	Data Type	DINT
	Range	[-2147483648 to +2147483647]
	Unit	N/A
	Default	-
Acceleration	Description	Trapezoidal: acceleration rate, S-Curve: maximum acceleration
	Data Type	LREAL
	Range	[-1.7E308 to 1.7E308 and -1.7E-308 to 1.7E-308 (14 to 15 significant digits of accuracy)]
	Unit	N/A
	Default	-
Deceleration	Description	Trapezoidal: deceleration rate, S-Curve: not used
	Data Type	LREAL
	Range	[-1.7E308 to 1.7E308 and -1.7E-308 to 1.7E-308 (14 to 15 significant digits of accuracy)]
	Unit	N/A
	Default	-
Jerk	Description	Trapezoidal: 0, S-Curve: constant jerk
	Data Type	LREAL
	Range	[-1.7E308 to 1.7E308 and -1.7E-308 to 1.7E-308 (14 to 15 significant digits of accuracy)]
	Unit	N/A
	Default	-
Kp	Description	Proportional gain
	Data Type	LREAL
	Range	[-1.7E308 to 1.7E308 and -1.7E-308 to 1.7E-308 (14 to 15 significant digits of accuracy)]

	Unit	N/A
	Default	-
Ti	Description	Integral gain
	Data Type	LREAL
	Range	[-1.7E308 to 1.7E308 and -1.7E-308 to 1.7E-308 (14 to 15 significant digits of accuracy)]
	Unit	N/A
	Default	-
Td	Description	Derivative gain
	Data Type	LREAL
	Range	[-1.7E308 to 1.7E308 and -1.7E-308 to 1.7E-308 (14 to 15 significant digits of accuracy)]
	Unit	N/A
	Default	-
DeviceFBValue	Description	Analog input
	Data Type	DINT
	Range	[-2147483648 to +2147483647]
	Unit	N/A
	Default	-
DeviceSetPoint	Description	Analog set point
	Data Type	DINT
	Range	[-2147483648 to +2147483647]
	Unit	N/A
	Default	-
ErrorDB	Description	Maximum or minimum error between DeviceFBValue and DeviceSetPoint before a change will take place.
	Data Type	LREAL
	Range	[-1.7E308 to 1.7E308 and -1.7E-308 to 1.7E-308 (14 to 15 significant digits of accuracy)]
	Unit	N/A
	Default	-
RatioLimitPercent	Description	Maximum and minimum master/slave ratio window
	Data Type	LREAL

	Range	[-1.7E308 to 1.7E308 and -1.7E-308 to 1.7E-308 (14 to 15 significant digits of accuracy)]
	Unit	N/A
	Default	-
ErrorCalcMode	Description	Not set: DeviceFBValue-DeviceSetPoint, Set: DeviceSetPoint-DeviceFBValue
	Data Type	BOOL
	Range	[0,1]
	Unit	N/A
	Default	-

5.2.0.39.1.2 Output

OK	Description	The output will have power flow after the enable input has been energized.
	Data Type	BOOL
	Range	[0,1]
	Unit	N/A
NewRatio	Description	New master/slave ratio
	Data Type	REAL
	Range	[-3.4E38 to 3.4E38 and -3.4E-38 to 3.4E-38 (6 to 7 significant digits of accuracy)]
	Unit	N/A
Error	Description	Function block error
	Data Type	BOOL
	Range	[0,1]
	Unit	N/A
ErrorID	Description	Function block error value
	Data Type	INT
	Range	[-32768 to +32767]
	Unit	N/A

5.2.0.39.2 Usage

This Kollmorgen UDFB is used in conjunction with the main ladder MC_GearIn function and it is assumed that the master/slave move is active. Internal to the Kollmorgen UDFB is another call to the MC_GearIn function therefore the MasterID, SlaveID, RatioNumerator, RatioDenominator, Acceleration, Deceleration, and Jerk inputs are the same values as the main ladder MC_GearIn function input values, both with the Buffer input of 0. This assures that the initial starting master/slave ratio will transition to the new Kollmorgen UDFB ratio smoothly.

This Kollmorgen UDFB will change the master/slave ratio that was defined by the MC_GearIn function based on the error between the analog input and the analog set-point. The magnitude of the ratio and the rate of the ratio change is defined by the Kp, Ti, Td PID gain values. The new ratio calculated is output at the NewRatio output.

The RatioLimitPercent input is the maximum and minimum theoretical new ratio that can be changed. This provides a +/- window limit around the running ratio to prevent unwanted motion in the event of a web break or analog feedback failure.

5.2.0.39.2.1 Example 1

NOTE

This example assumes that the analog feedback device is located *after* (or downstream in the process) the feedroll axis.

RatioNumerator = 1
 RatioDemominator = 2 Therefore the master/slave starting ratio is 0.5000000
 ErrorCaclMode = 0
 DeviceFBValue = 6
 DeviceSetPoint = 4 Therefore error 6 - 4 = 2
 Kp = 0.005
 Ti = 0
 Td = 0

From the equation:

New RatioDemominator = (RatioDemoninator - Kp * error)

Therefore the new RatioDenominator = (2 - 0.005*2) = 1.99

Thus the new master/slave running ratio is 1 / 1.99 = 0.502512562

Since the master/slave ratio is greater than the previous ratio the slave axis is going faster and the tension is reduced.

5.2.0.39.2.2 Example 2

NOTE

This example assumes that the analog feedback device is located *before* (or upstream in the process) the feedroll axis.

This is the same example as example 1 with the exception of the ErrorCaclMode input Boolean set.

RatioNumerator = 1
 RatioDemominator = 2 Therefore the master/slave starting ratio is 0.5000000
 ErrorCaclMode = 1
 DeviceFBValue = 6
 DeviceSetPoint = 4 Therefore error is 4 - 6 = -2
 Kp = 0.005
 Ti = 0
 Td = 0

From the equation:

New RatioDemominator = (RatioDemoninator - (Kp * error))

Therefore the new RatioDenominator = (2 + 0.005*2) = 2.01

Thus the new master/slave running ratio is 1 / 2.01 = 0.497512437

Since the master/slave ratio is less than the previous ratio the slave axis is going slower and the tension is reduced.

5.2.0.39.2.3 PID Function in KAS:

There is a PID function in KAS that could be used for the PID control section in the Kollmorgen UDFB.

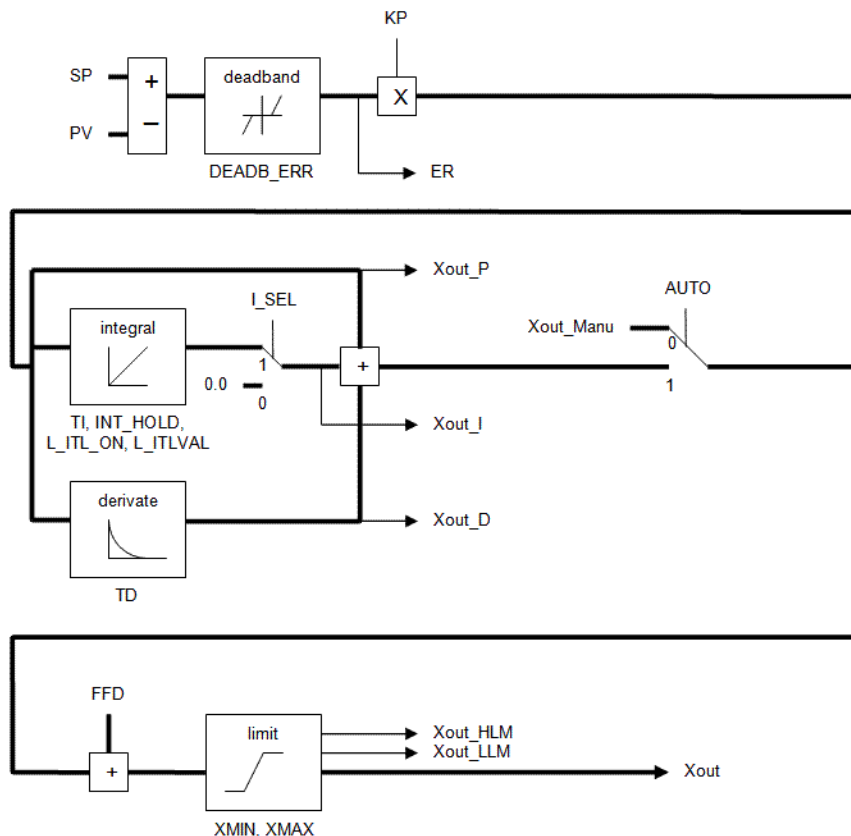

5.2.0.39.2.4 Programming tips:

The First Order Digital Filter Kollmorgen UDFB can be used to decrease excess dither on the analog input. The filtered analog value is then used at the DeviceFBValue input of the MCFB_GearedWebTension Kollmorgen UDFB .

The assumption is a MC_GearIn function block is first called in the main ladder and these initial values are then used at the inputs for the Kollmorgen UDFB. The resolution of the initial MC_GearIn the RatioNumerator and RatioDenominator inputs are directly related to the resolution of the calculated master/slave ratio (from the Kollmorgen UDFB inputs) and may need to be scaled accordingly.

5.2.0.40 Example 1

No scaling

Initial MC_GearIn input RatioNumerator = 2

Initial MC_GearIn input RatioDenominator = 1 then initial Master/Slave ratio = 2

Kollmorgen UDFB input RatioNumerator = 2

Kollmorgen UDFB input RatioDenominator = 1 then Kollmorgen UDFB Master/Slave ratio = 2

Kollmorgen UDFB input DeviceFBValue = 4

Kollmorgen UDFB input DeviceFBSetpoint = 3 then Device PID error = 1 assume $K_P = 1$, T_i and $T_d = 0$

New Kollmorgen UDFB RatioNumerator = Current RatioNumerator - PID error = $2 - 1 = 1$ then new Kollmorgen UDFB Master/Slave ratio = 1

Resolution = Master/Slave ratio:PID Error ratio = 1:1

The resolution is so coarse that a change of 1 for the error output of the PID creates a Master/Slave ratio change of 1. This results in a significant change to the slave velocity that will probably cause excess slack or web breakage.

5.2.0.41 Example 2

Scaling value = 1000

Initial MC_GearIn input RatioNumerator = 2

Initial MC_GearIn input RatioDenominator = 1 then initial Master/Slave ratio = 2

Kollmorgen UDFB input RatioNumerator = 2000

Kollmorgen UDFB input RatioDenominator = 1000 then Kollmorgen UDFB Master/Slave ratio = 2

Kollmorgen UDFB input DeviceFBValue = 4

Kollmorgen UDFB input DeviceFBSetpoint = 3 then Device PID error = 1 assume KP = 1, Ti and Td =0

New Kollmorgen UDFB RatioNumerator = Current RatioNumerator - PID error = 2000- 1 =1999
then new Kollmorgen UDFB Master/Slave ratio = 1999

Resolution = Master/Slave ratio:PID Error ratio = 2000:1

This resolution is much finer than example 1 so for a change of 1 for the error output of the PID this creates a Master/Slave ratio change of 1999. This results in a slower rate of change to the slave velocity that is more suited to good tension in a machine process.

5.2.0.41.1 Related Functions

[FB_FirstOrderDigitalFilter](#)

5.2.0.41.2 Example

5.2.0.41.2.1 Ladder Example

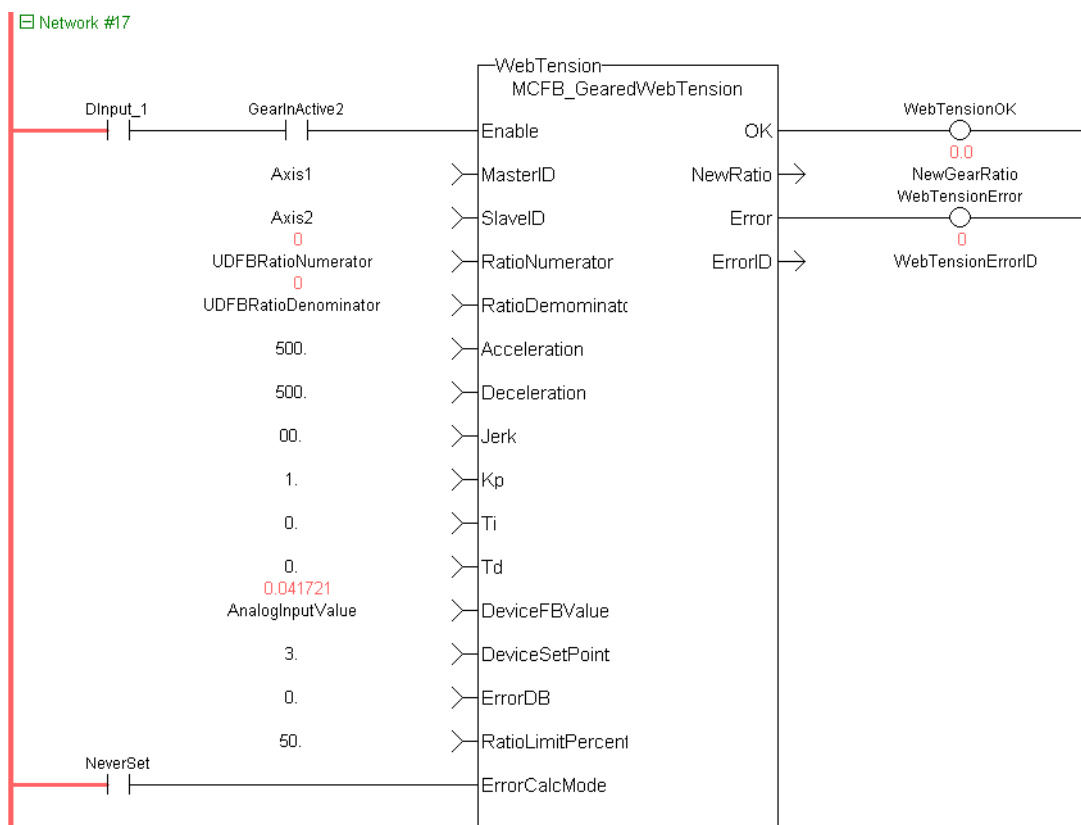

5.2.0.41.2.2 Function Block Diagram Example

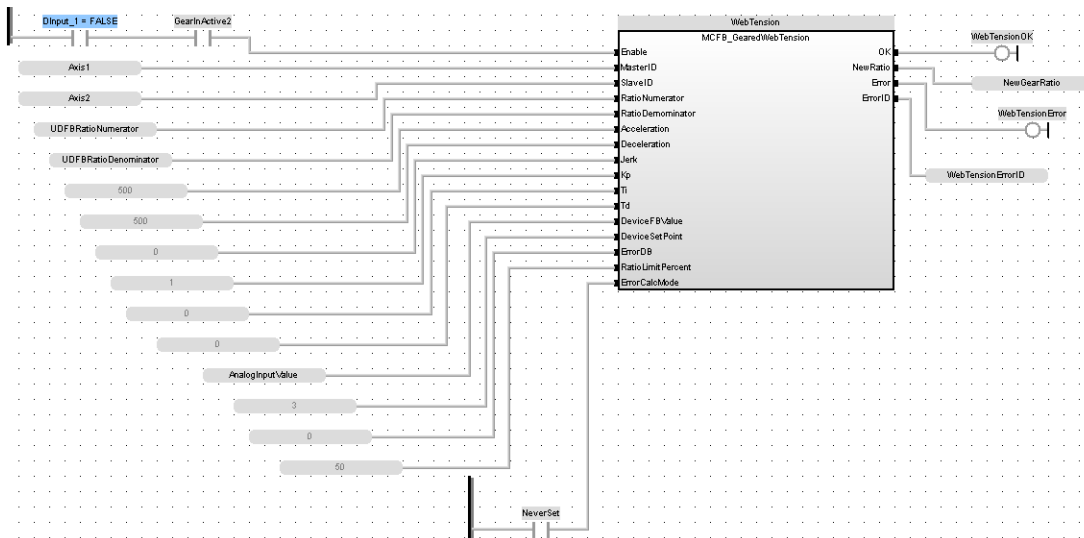

5.2.0.41.2.3 Structured Text Example

```

Inst_MCFB_GearedWebTension
(
  DInput_1 FALSE, Axis1, Axis2, UDFBRatioNumerator 0, UDFBRatioDenominator 0,
  500.0, 500.0, 0.0, 1.0, 0.0, 0.0, AnalogInputValue 0.0, 3.0, 0.0, 50.0, NeverSet FALSE);
WebTensionOk FALSE := Inst_MCFB_GearedWebTension.OK FALSE;
NewGearRatio 0.0 := Inst_MCFB_GearedWebTension.NewRatio 0.0;
WebTensionError FALSE := Inst_MCFB_GearedWebTension.Error FALSE;
WebTensionErrorID 0 := Inst_MCFB_GearedWebTension.ErrorID 0;
    
```

5.2.0.42 FB_Cylinder



5.2.0.42.1 Description

This function block can be used to control a cylinder and the Limit Switches.

There are two inputs InA and InB to set the direction of the movement and the belonging LimSwitches LsA and LsB.

If InA is set to TRUE the output DirA is set to TRUE and after a time value defined by CtrlTime the LsA has to become TRUE otherwise a fault FaultLsA appears. Just as in direction B.

If both LsA and LsB are TRUE then a Fault depending of the output is set. If both InA and InB are given (e.g. to stop the cylinder movement) no limit switch is controlled.

All faults can be reset by input iResetFault.

5.2.0.42.2 Arguments

5.2.0.42.2.1 Input

iInA	Description	Set direction A
	Data type	BOOL
iInB	Description	Set direction B
	Data type	BOOL
iLsA	Description	Limit Switch at End of direction A
	Data type	BOOL
iLsB	Description	Limit Switch at End of direction B

	Data type	BOOL
iCtrlTime	Description	Max Time till Lim.Sw. has to be reached
	Data type	TIME
iResetFault	Description	Reset Fault (Is set to FALSE by UDFB!)
	Data type	BOOL

5.2.0.42.2.2 Output

oDirA	Description	Direction A
	Data type	BOOL
oDirB	Description	Direction B
	Data type	BOOL
oFaultLsA	Description	Fault of Lim.Sw. at End direction A
	Data type	BOOL
oFaultLsB	Description	Fault of Lim.Sw. at End direction B
	Data type	BOOL

5.2.0.42.3 Usage

The signal flow is valid for both directions (A and B)

If oDirA AND oDirB are active there is no Fault Control.

The Fault can be reset by iRestFault = True.

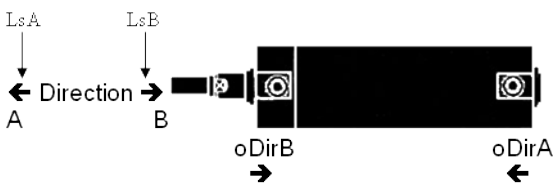

5.2.0.42.4 Example

5.2.0.42.4.1 ST

```
//Electric Cylinder with limit switch controls
Inst_FB_Cylinder( dirA, dirB, LimitSwitchA, LimitSwitchB, CtrlTime,
```



```

ResetFault );
A := Inst_FB_Cylinder.oDirA;
B := Inst_FB_Cylinder.oDirB;
FaultLimitSwitchA := Inst_FB_Cylinder.oFaultLsA;
FaultLimitSwitchB := Inst_FB_Cylinder.oFaultLsB;
    
```

5.2.0.42.4.2 Function Block Diagram

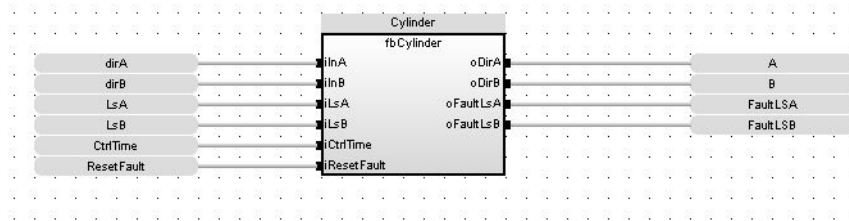

5.2.0.42.4.3 FFLD

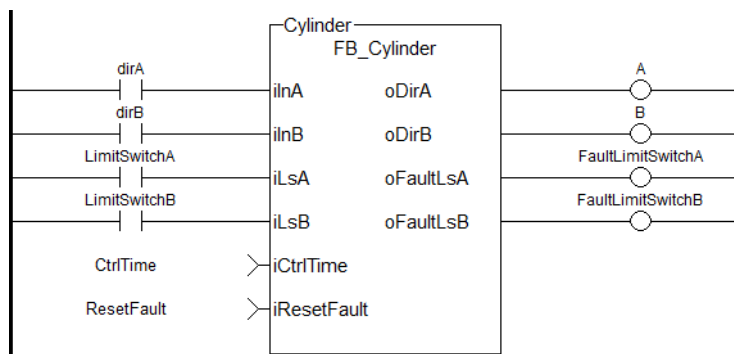

5.2.0.43 FB_AKDFitRpt



5.2.0.43.1 Description

Outputs AKD drive fault Information.

The oFAULT output turns TRUE when the selected drive goes into a fault state. This function block outputs the total number of faults in the AKD drive fault history variable (Pre-Defined Error Field Object 1003h), and the fault number and message for the last 3 drive faults.

Each fault has two outputs: the fault number and a fault message. The fault number is the same number as reported on the display of the AKD drive. The fault message provides a short description of the fault. For example if the first fault is a feedback error with a F401 displayed on the front of the drive, the output of this FB are:

- **oFirstFaultNumber** = 401
- **oFirstFaultMessage** = Failed To Set Feedback Type

The iResetfaultHistory Input resets the faults reported by the FB.

The oDriveNotUsed outputs a 1 (True) if the axis is configured to Simulated in the ProjectEthercat setup screen.

TIP

This function block lists the *earliest occurring* fault first. This may not be the same fault as is being reported on an AKD's display, which is based on priority. The [MCFB_AKDFault](#) function block may be preferred as it reports the same error as displayed on the drive.

This function Block can be used with either the PipeNetwork or PLCopen Motion engines. The following figure shows the function block I/O:

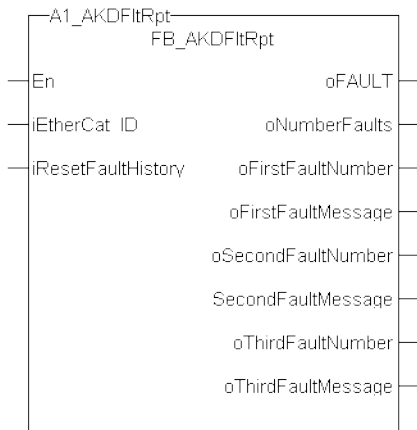

Figure 1-196: AKDFltRpt

5.2.0.43.2 Arguments

5.2.0.43.2.1 Input

EN	Description	ENABLES the Kollmorgen UDFB (used in FFLD editor only)
	Data type	BOOL
	Range	[0 , 1]
	Unit	N/A
	Default	—
iEtherCat_ID	Description	EtherCAT address desired AKD Drive ex. 1001 or AKD_1
	Data type	INT
	Range	—
	Unit	N/A
	Default	—
iRstFltHist	Description	When input is TRUE, clears all Faults saved to drives history
	Data type	BOOL
	Range	[0 , 1]
	Unit	N/A
	Default	—

5.2.0.43.2.2 Output

oFAULT	Description	TRUE if selected drive currently has a Fault
	Data type	BOOL

	Unit	N/A
oNumberFaults	Description	Number of faults saved in the Drive's history
	Data type	DINT
	Range	[0 , 10]
	Unit	N/A
oFirstFaultNumber	Description	Three digit AKD Fault identifier
	Data type	DINT
	Range	[100 , 999]
	Unit	N/A
oFirstFaultMessage	Description	Description of the Fault
	Data type	STRING
	Unit	N/A
oSecondFaultNumber	Description	Three digit AKD Fault identifier.
	Data type	DINT
	Range	[100 , 999]
	Unit	N/A
oSecondFaultMessage	Description	Description of the Fault
	Data type	STRING
	Unit	N/A
oThirdFaultNumber	Description	Three digit AKD Fault identifier
	Data type	DINT
	Range	[100 , 999]
	Unit	N/A
oThirdFaultMessage	Description	Description of the Fault
	Data type	STRING
	Unit	N/A
oDriveNotUsed	Description	Is this Drive Real (0) on Simulated (1)
	Data type	BOOL
	Unit	N/A

5.2.0.43.3 Usage

Typical usage for this UDFB are:

- Provide drive fault information that the application program uses to determine next steps such as perform a machine controlled stop or perform an immediate disable of the servo

drives.

- In the application program send output fault information from this UDFB to the HMI for review by the machine operator.

5.2.0.43.4 Related Functions

[MC_ReadStatus](#) (PLCopen Motion Engine)

[MLAxisStatus](#) (Pipe Network Motion Engine)

[MCFB_AKDFault](#)

5.2.0.43.5 Example

5.2.0.43.5.1 Structured Text

```
//Execute the Function Block
l_AKDFltRpt (1001, resetFaultHistST);

//Read Function Block Outputs
AKD1_Fault:= A1_AKDFltRpt.oFault;
AKD1_NumFault:= A1_AKDFltRpt.oNumberFaults;
AKD1_FirstFaultNumber:= A1_AKDFltRpt.oFirstFaultNumber;
AKD1_FirstFaultMessage:= A1_AKDFltRpt.oFirstFaultMessage;
AKD1_SecondFaultNumber:= A1_AKDFltRpt.oSecondFaultNumber;
AKD1_SecondFaultMessage:= A1_AKDFltRpt.oSecondFaultMessage;
AKD1_ThirdFaultNumber:= A1_AKDFltRpt.oThirdFaultNumber;
AKD1_ThirdFaultMessage:= A1_AKDFltRpt.oThirdFaultMessage;
;
```

NOTE

A1_FaultReporting is an instance of the FB_S700FltRpt function block.

5.2.0.43.5.2 Ladder Diagram

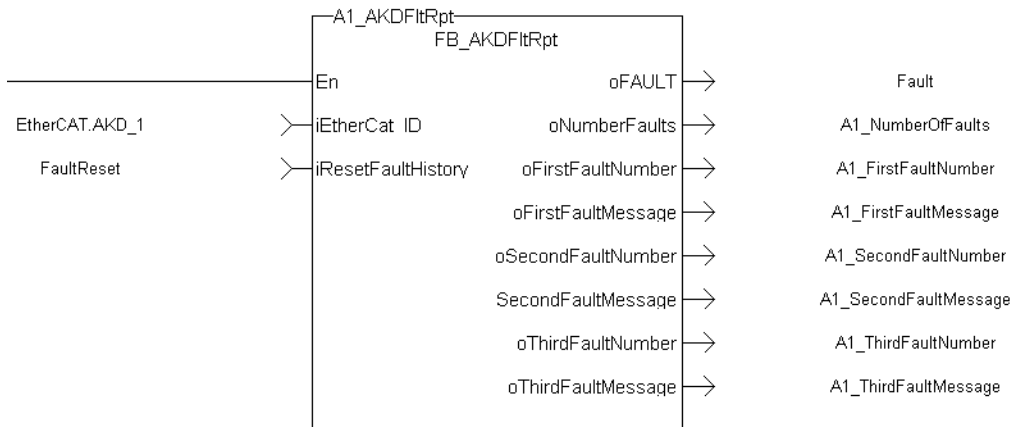

5.2.0.43.5.3 Function Block Diagram

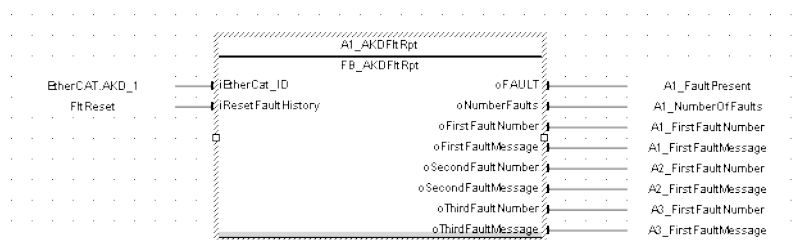

5.2.0.44 FB_S700FltRpt



5.2.0.44.1 Description

Outputs S700 drive fault Information.

The oFAULT output turns TRUE when the selected drive goes into a fault state. This function block outputs the total number of faults in the S700 drive fault history variable (FLTHIST), and the fault number and message for the last 3 drive faults.

Each fault has two outputs: the fault number and a fault message. The fault number is the same number as reported on the display of the S700 drive. The fault message provides a short description of the fault. For example if the first fault is a feedback error with a F04 is displayed on the front of the drive, the output of this FB are:

- **oFirstFaultNumber** = 04
- **oFirstFaultMessage** = Feedback Error

The iResetfaultHistory Input resets the faults reported by the FB.

The oDriveNotUsed outputs a 1 (True) if the axis is configured to Simulated in the ProjectEthercat setup screen.

This function Block can be used with either the PipeNetwork or PLCopen Motion engines.

The following figure shows the function block I/O:

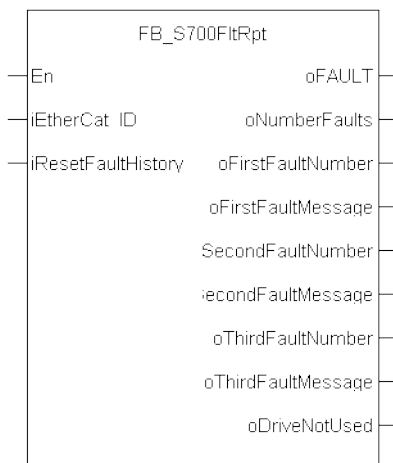

Figure 1-197: S700FltRpt

5.2.0.44.2 Arguments

5.2.0.44.2.1 Input

EN	Description	ENABLES the Kollmorgen UDFB (used in FFLD editor only)
	Data type	BOOL
	Range	[0, 1]
	Unit	N/A
	Default	—
iEtherCat_ID	Description	EtherCAT address desired AKD Drive ex. 1001 or AKD_1
	Data type	DINT
	Range	—
	Unit	N/A

	Default	—
iRstFltHist	Description	When input is TRUE, clears all Faults saved to drives history
	Data type	BOOL
	Range	[0, 1]
	Unit	N/A
	Default	—

5.2.0.44.2.2 Output

oFAULT	Description	TRUE if selected drive currently has a Fault
	Data type	BOOL
	Unit	N/A
oNumberFaults	Description	Number of faults saved in the Drive's history
	Data type	DINT
	Range	[0, 10]
	Unit	N/A
oFirstFaultNumber	Description	Two digit S700 drive Fault identifier
	Data type	DINT
	Range	[00, 32]
	Unit	N/A
oFirstFaultMessage	Description	Description of the Fault
	Data type	STRING
	Unit	N/A
oSecondFaultNumber	Description	Two digit S700 drive Fault identifier
	Data type	DINT
	Range	[00, 32]
	Unit	N/A
oSecondFaultMessage	Description	Description of the Fault
	Data type	STRING
	Unit	N/A
oThirdFaultNumber	Description	Two digit S700 drive Fault identifier
	Data type	DINT
	Range	[00, 32]
	Unit	N/A
oThirdFaultMessage	Description	Description of the Fault
	Data type	STRING
	Unit	N/A
oDriveNotUsed	Description	Is this Drive Real (0) on Simulated (1)
	Data type	BOOL
	Unit	N/A

5.2.0.44.3 Usage

Typical usage for this UDFB are:

- Provide drive fault information that the application program uses to determine next steps such as perform a machine controlled stop or perform an immediate disable of the servo drives.
- In the application program send output fault information from this UDFB to the HMI for review by the machine operator.

5.2.0.44.4 Related Functions

[MC_ReadStatus](#) (PLCopen Motion Engine)

[MLAxisStatus](#) (Pipe Network Motion Engine)

5.2.0.44.5 Example

5.2.0.44.5.1 Structured Text

```
//Execute the Function Block
A1_FaultReporting (1001, 0);

//Read Function Block Outputs
A1_Fault:= A1_FaultReporting.oFault;
A1_NumFault:= A1_FaultReporting.oNumberFaults;
A1_FirstFaultNumber:= A1_FaultReporting.oFirstFaultNumber;
A1_FirstFaultMessage:= A1_FaultReporting.oFirstFaultMessage;
A1_SecondFaultNumber:= A1_FaultReporting.oSecondFaultNumber;
A1_SecondFaultMessage:= A1_FaultReporting.oSecondFaultMessage;
A1_ThirdFaultNumber:= A1_FaultReporting.oThirdFaultNumber;
A1_ThirdFaultMessage:= A1_FaultReporting.oThirdFaultMessage;
A1_Simulated:= A1_FaultReporting.oDriveNotUsed;
```

NOTE

A1_FaultReporting is an instance of the FB_S700FltRpt function block.

5.2.0.44.5.2 Ladder Diagram

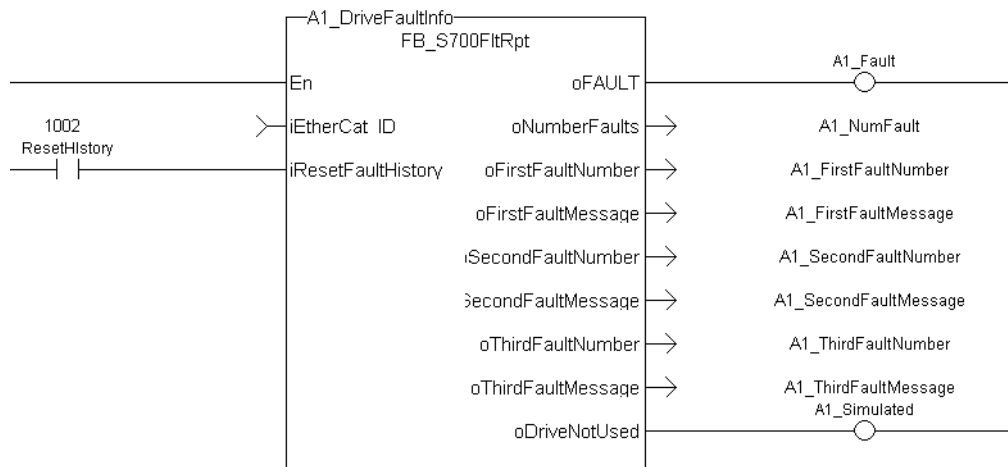

5.2.0.44.5.3 Function Block Diagram

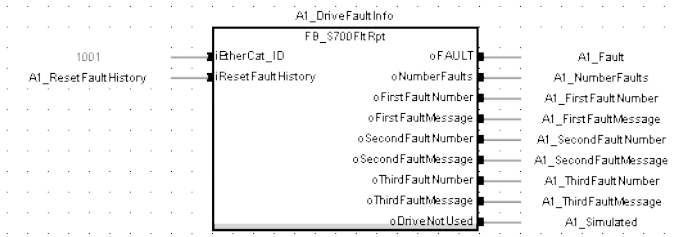

5.2.0.45 FB_AxisPlsPosModulo



5.2.0.45.1 Description

This function block can be used for any position of a modulo axis in both directions. The Boolean output oPLS is set to TRUE if the position has crossed the start position and is set to FALSE if the position has crossed the end position. The function block is executed cyclically. The function block has the possibility to compensate a delay time of the connected device, e .g. glue nozzles. It is also possible to define a hysteresis for switching on and off of the PLS.

5.2.0.45.2 Arguments

5.2.0.45.2.1 Input

ibExecute	Description	Enable PLS
	Data type	BOOL
iPosition	Description	Any position of a modulo axis
	Data type	LREAL
iModuloPosition	Description	Modulo position of axis
	Data type	LREAL
iStartPos	Description	Start position of PLS
	Data type	LREAL
iEndPos	Description	End position of PLS
	Data type	LREAL
iDelayTime	Description	Delay time for compensation
	Data type	TIME
iHysteresis	Description	Hysteresis
	Data type	LREAL
ibForce	Description	Force PLS
	Data type	BOOL

5.2.0.45.2.2 Output

oPLS	Description	Position limit switch
	Data type	BOOL

5.2.0.45.3 Example

5.2.0.45.4 Timing

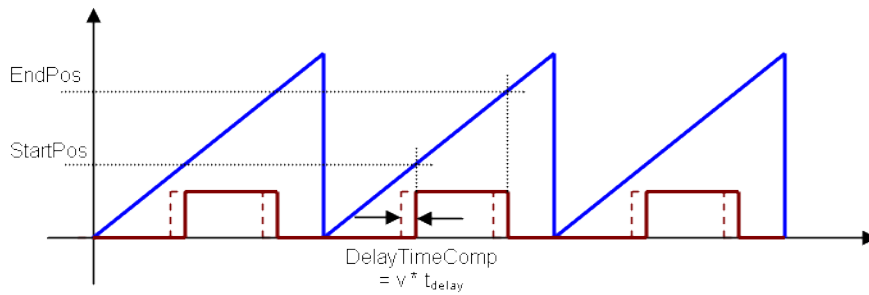

5.2.0.45.5 Hysteresis

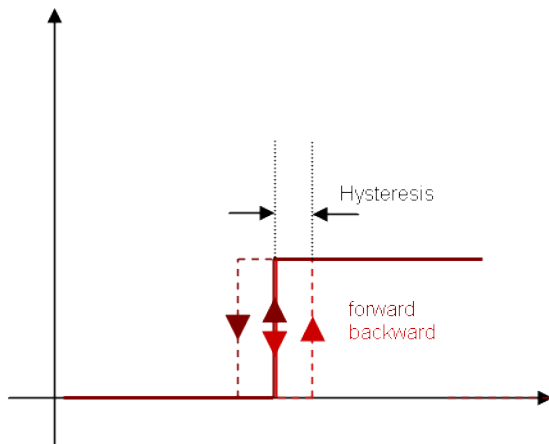

5.2.0.45.5.1 ST

```
//PLSOutput is True when position input is between 180 and 270 with a
T#2ms delay
//Can also force the output to be true with ForceOuput variable
//Hysteresis is on for 3 user units in case direction changes around
start point

Inst_FB_AxisPlsPosModulo( EnablePLS, ActualPosition, ModuloPosition, 180,
270, T#2ms, 3, ForcePLS );

PLSOutput := Inst_FB_AxisPlsPosModulo.oPLS;
```

5.2.0.45.5.2 Function Block Diagram

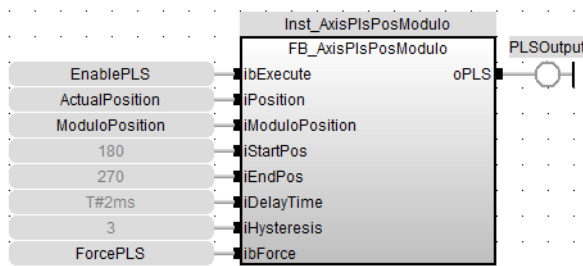

5.2.0.45.5.3 FFLD

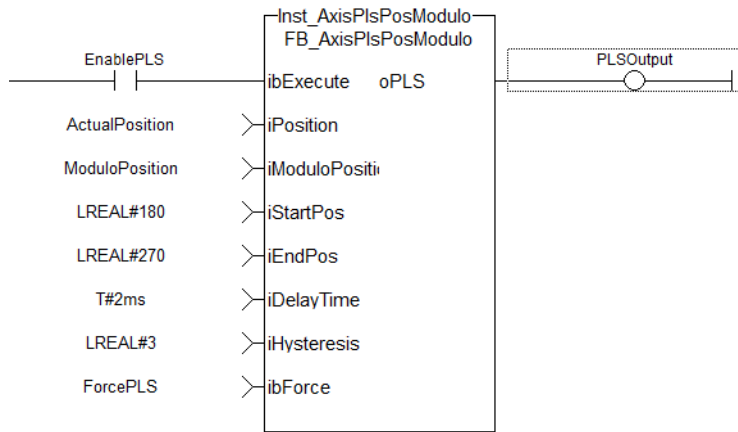

5.2.0.46 FB_AxisPlsPosNoModulo



5.2.0.46.1 Description

This function block can be used for any position of a non-modulo axis in both directions. The Boolean output oPLS is set to TRUE if the position has crossed the start position and is set to FALSE if the position has crossed the end position. The function block has the possibility to compensate a delay time of the connected device, e .g. glue nozzles. It is also possible to define a hysteresis for switching on and off of the PLS.

5.2.0.46.2 Arguments

5.2.0.46.2.1 Input

ibExecute	Description	Enable PLS
	Data type	BOOL
iPosition	Description	Any position of a none-modulo axis
	Data type	LREAL
iStartPos	Description	Start position of PLS
	Data type	LREAL
iEndPos	Description	End position of PLS
	Data type	LREAL
iDelayTime	Description	Delay time for compensation
	Data type	TIME
iHysteresis	Description	Hysteresis
	Data type	LREAL
ibForce	Description	Force PLS
	Data type	BOOL

5.2.0.46.2.2 Output

oPLS	Description	Position limit switch
-------------	--------------------	-----------------------

Data type	BOOL
------------------	------

5.2.0.46.3 Example

5.2.0.46.4 Timing

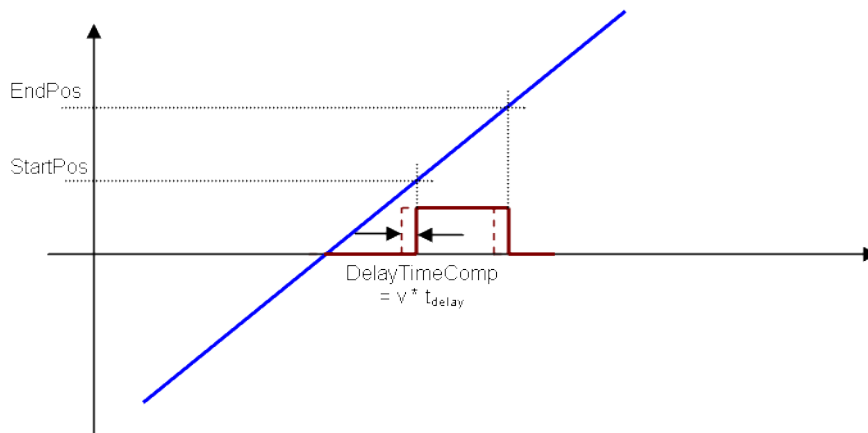

5.2.0.46.5 Hysteresis

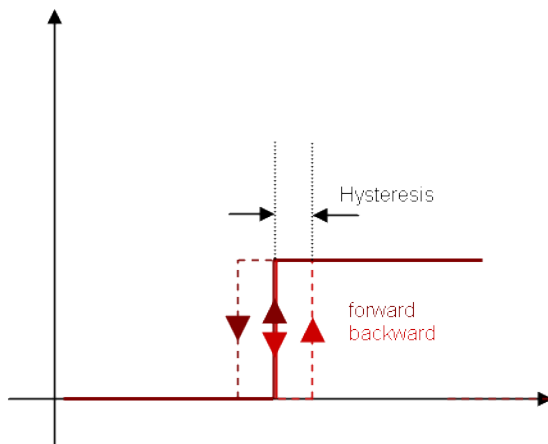

5.2.0.46.5.1 ST

```
//PLSOutput is True when position input is between 180 and 270 with a
T#2ms delay
//Can also force the output to be true with ForceOutput variable
//Hysteresis is on for 3 user units in case direction changes around
start point

Inst_FB_AxisPlsPosNoModulo( EnablePLS, ActualPosition, 180, 270, T#2ms,
3, ForcePLS );

PLSOutput := Inst_FB_AxisPlsPosNoModulo.oPLS;
```

5.2.0.46.5.2 FBD

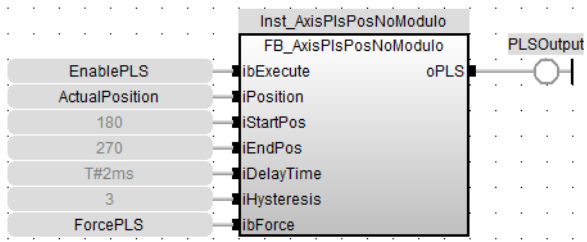

5.2.0.46.5.3 FFLD

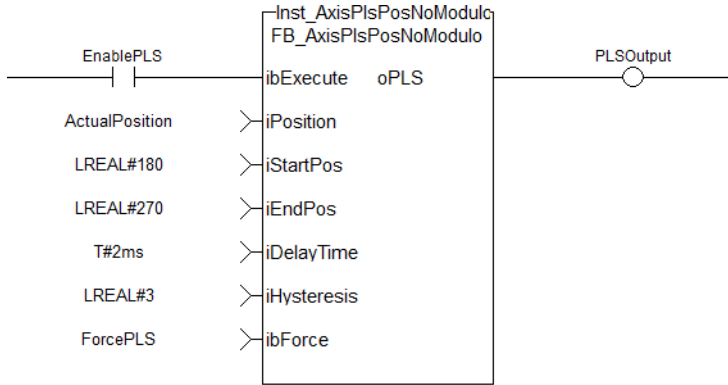

6 Index

A

Abort Camming	337
Abort Gearing	357, 361
actual position	
pipe network	111
actual velocity	296
Adapter, E/IP	571
AKDFaultLookup	
PLCopen	720, 722
AKDFltRpt	781
ASCII	528
AXIS_GROUP_REF	458
AxisPlsPosModulo	788
AxisPlsPosNoModulo	790

C

Cam	
Aborting	337
Coordinated Motion	
Group Control items	429
Info items	466
List of Function Blocks	426
Motion items	485
Reference items	523
copyrights	2
curve	
synchronizer	240
cycle	
missed	528

D

debug	
EtherCAT	554
delay compensation	256
disclaimer	2
DriveFault	
PipeNetwork	669
PLCopen	723
DriveParamRead	529
DriveParamStrRead	534
DriveParamWrite	537

E

ECAT Restart	
PLCopen	726
ECATGetObjVal	552
ECATReadData	554
ECATReadSdo	556
ECATWCStatus	560
ECATWriteData	561
ECATWriteSdo	563

ECERR_DEVICE_ERROR	541
ECERR_INVALID_ARRAY_SIZE	541
EIP	571
EtherCAT	
image	554, 561
timeout	532, 570
EtherCAT library	527
EtherCAT library function	
DriveParamRead	529
DriveParamStrRead	534
DriveParamWrite	537
ECATGetObjVal	552
ECATReadData	554
ECATReadSdo	556
ECATWCStatus	560
ECATWriteData	561
ECATWriteSdo	563
F	
falling edge	253
fast input	61, 257
fbCylinder	779
feed-forward	
torque-	146
feedback position	52, 111
FSoE	567
FSoEParamsInit	567
G	
Gear	
Aborting	357, 361
generator position	112
GetCtrlPerf	580
H	
HomeFindHomeFastInput	691
HomeFindHomeFastInputModulo	697
HomeFindHomeInput	674
HomeFindHomeInputThenZeroAngle	677
HomeFindLimitFastInput	703
HomeFindLimitFastInputModulo	708
HomeFindLimitInput	679
HomeFindLimitInputThenZeroAngle	681
HomeFindZeroAngle	683
HomeMoveUntilPosErrExceeded	686
HomeMoveUntilPosErrExceededThenZeroAngle	688
HomeUsingCurrentPosition	690
homing	379
I	
image EtherCAT	554, 561
J	
Jog	
Pipe Network	713

PLCopen	769
K	
Kollmorgen UDFB	647, 652, 660
AKDFaultLookup	720, 722
AKDFltRpt	781
AxisPlsPosModulo	788
AxisPlsPosNoModulo	790
DriveFault	669, 723
ECATRestart	672, 726
fbCylinder	779
HomeFindHomeFastInput	691
HomeFindHomeFastInputModulo	697
HomeFindHomeInput	674
HomeFindHomeInputThenZeroAngle	677
HomeFindLimitFastInput	703
HomeFindLimitFastInputModulo	708
HomeFindLimitInput	679
HomeFindLimitInputThenZeroAngle	681
HomeFindZeroAngle	683
HomeMoveUntilPosErrExceeded	686
HomeMoveUntilPosErrExceededThenZeroAngle	688
HomeUsingCurrentPosition	690
Jog	713, 769
PlsPosFw	715
PlsPosFwBw	716
PlsTimeFw	718
S700FltRpt	785
ScaleInput	656
ScaleOutput	658
StepAbsolute	728
StepAbsSwitch	731
StepAbsSwitchFastInput	756
StepBlock	738
StepLimitSwitch	744
StepLimitSwitchFastInput	763
StepRefPulse	750
TemperaturePID	666
L	
latency	262
M	
Mark-to-Machine	383
Mark-to-Mark	383
MC_AbortTrigger	284
MC_AddSuperAxis	398
MC_AxisSetDefaults	486
MC_CamIn	337
MC_CamOut	345
MC_CamResumePos	348
MC_CamStartPos	350
MC_CamTblSelect	353
MC_ClearFaults	265
MC_CreateAxesGrp	432
MC_CreatePLCAxis	266
MC_ErrorDescription	278, 402

MC_EStop	270
MC_GearIn	356
MC_GearInPos	360
MC_GearOut	367
MC_GrpDisable	435
MC_GrpEnable	437
MC_GrpHalt	489
MC_GrpReadActAcc	466
MC_GrpReadActPos	469
MC_GrpReadActVel	472
MC_GrpReadBoolPar	439
MC_GrpReadCmdPos	474
MC_GrpReadCmdVel	477
MC_GrpReadError	480
MC_GrpReadStatus	481
MC_GrpReset	444
MC_GrpSetOverride	491
MC_GrpSetPos	523
MC_GrpStop	446
MC_GrpWriteBoolPar	448
MC_Halt	308
MC_InitAxesGrp	453
MC_InitAxis	272
MC_InitAxisFeedback	274
MC_MachRegist	383
MC_MarkRegist	390
MC_MoveAbsolute	311
MC_MoveAdditive	316
MC_MoveCircAbs	493
MC_MoveCircRel	500
MC_MoveDirAbs	507
MC_MoveDirRel	509
MC_MoveLinAbs	512
MC_MoveLinRel	518
MC_MoveRelative	319
MC_MoveSuperimp	324
MC_MoveVelocity	328
MC_Phasing	369
MC_Power	276
MC_ReadActPos	293
MC_ReadActVel	295
MC_ReadAxisErr	297
MC_ReadBoolPar	299
MC_ReadParam	300
MC_ReadStatus	302
MC_Reference	375
MC_RemSuperAxis	399
MC_ResetError	280
MC_SetKinTra	458
MC_SetOverride	335
MC_SetPos	380
MC_SetPosition	383
MC_Stop	281
MC_StopRegist	396
MC_SyncSlaves	373
MC_TouchProbe	286
MC_UngroupAllAxes	460
MC_WriteBoolPar	304
MC_WriteParam	306
missing PLC cycles	528

MLAxisAbs	53
MLAxisActualPos	88
MLAxisAdd	57
MLAxisClrErrors	101
MLAxisGenStatus	92
MLAxisPowerOff	85
MLAxisPowerOn	85
MLAxisRefPos	63
MLAxisRun	83
MLAxisSetZero	113
MLCNVConECAT	142
MLPNAxisCreate	114
MLPrfGetIRatio	123
MLPrfGetORatio	125
MLPrfSetIRatio	128
MLPrfSetORatio	131
MLProfileRelease	415
MLSmpConPLCAxis	234
MLSmpConPNAxis	235
MLTrigGetPos	259
MLTrigGetTime	261
Modulo calculation, MLTrigReadPos	258
motion library	20
adder	34
Axis	51
Block	26
CAM Profile	117
Comparator	132
Convertor	142
Delay	150
Derivator	151
Gear	157
Integrator	172
Master	176
Phaser	201, 527, 529
Pipe	20
PMP	210
Sampler	230
State Machine	418
Synchronizer	240
Trigger	249
motion library function	
MC_AbortTrigger	284
MC_CamIn	337
MC_CamOut	345
MC_CamTbiSelect	353
MC_ClearFaults	265
MC_CreatePLCAxis	266
MC_EStop	270
MC_GearIn	356
MC_GearInPos	360
MC_GearOut	367
MC_Halt	308
MC_InitAxis	272
MC_InitAxisFeedback	274
MC_MachRegist	383
MC_MarkRegist	390
MC_MoveAbsolute	311
MC_MoveAdditive	316
MC_MoveRelative	319

MC_MoveSuperimp	324
MC_MoveVelocity	328
MC_Phasing	369
MC_Power	276
MC_ReadActPos	293
MC_ReadActVel	295
MC_ReadAxisErr	297
MC_ReadBoolPar	299
MC_ReadParam	300
MC_ReadStatus	302
MC_Reference	375
MC_ResetError	280
MC_SetKinTra	458
MC_SetOverride	335
MC_SetPos	380
MC_SetPosition	383
MC_Stop	281
MC_StopRegist	396
MC_SyncSlaves	373
MC_TouchProbe	286
MC_WriteBoolPar	304
MC_WriteParam	306
MLAxisAbs	53
MLAxisAdd	57
P	
phasing	
PLCopen	370
synchronizer pipe block	240
pipe position	112
PlsPosFw	715
PlsPosFwBw	716
PlsTimeFw	718
position	
actual position	111
feedback position	52, 111
generator position	112
pipe position	112
reference position	53, 112, 132
Position	
Zero Offset	112
PrintMessage	642
R	
reference position	53, 112, 132
registration	281, 383, 390
rising edge	253
robot	458, 462
S	
S-curve	221
S700FltRpt	785
ScaleInput	656
ScaleOutput	658
servo axis	272
state machine	
motion	419

stats	528-529
StepAbsolute	728
StepAbsSwitch	731
StepAbsSwitchFastInput	756
StepBlock	738
StepLimitSwitch	744
StepLimitSwitchFastInput	763
StepRefPulse	750
SuperimposedCmdPos	398-399
T	
TCP/IP	609
TCP/IP, functions	609
TemperaturePID	666
timeout	
EtherCAT	532, 570
torque feed-forward	146
trademarks	2
U	
UDFB	
INOUT	647
out	647
UDP Functions;udpAddrMake	625
UDP Functions;udpClose	627
UDP Functions;udpCreate	629
UDP Functions;udpIsValid	631
UDP Functions;udpRcvFrom	632
UDP Functions;udpRcvFromArray	634
UDP Functions;udpSendTo	637
UDP Functions;udpSendToArray	639
V	
Velocity, current	345, 367
Z	
Zero Offset	
Pipe Network	112

--- / ---

About KOLLMORGEN

Kollmorgen is a leading provider of motion systems and components for machine builders. Through world-class knowledge in motion, industry-leading quality and deep expertise in linking and integrating standard and custom products, Kollmorgen delivers breakthrough solutions that are unmatched in performance, reliability and ease-of-use, giving machine builders an irrefutable marketplace advantage.



Join the [Kollmorgen Developer Network](#) for product support. Ask the community questions, search the knowledge base for answers, get downloads, and suggest improvements.

North America KOLLMORGEN

201 West Rock Road
Radford, VA 24141, USA

Web: www.kollmorgen.com
Mail: support@kollmorgen.com
Tel.: +1 - 540 - 633 - 3545
Fax: +1 - 540 - 639 - 4162

**Europe
KOLLMORGEN Europe GmbH**
Pempelfurtstr. 1
40880 Ratingen, Germany

Web: www.kollmorgen.com
Mail: technik@kollmorgen.com
Tel.: +49 - 2102 - 9394 - 0
Fax: +49 - 2102 - 9394 - 3155

South America KOLLMORGEN

Avenida João Paulo Ablas, 2970
Jardim da Glória, Cotia - SP
CEP 06711-250, Brazil

Web: www.kollmorgen.com
Mail: contato@kollmorgen.com
Tel.: +55 11 4615-6300

China and SEA KOLLMORGEN

Room 302, Building 5, Lihpao Plaza,
88 Shenbin Road, Minhang District,
Shanghai, China.

Web: www.kollmorgen.cn
Mail: sales.china@kollmorgen.com
Tel.: +86 - 400 668 2802
Fax: +86 - 21 6248 5367