

Kollmorgen Automation Suite

KAS Reference Manual - Motion Library



Document Edition: H, September 2016

Valid for KAS Software Revision 2.11

Part Number: 959716

Keep all manuals as a product component during the life span of the product.
Pass all manuals to future users / owners of the product.

Trademarks and Copyrights

Copyrights

Copyright © 2009-2016 Kollmorgen™

Information in this document is subject to change without notice. The software package described in this document is furnished under a license agreement or non-disclosure agreement. The software may be used or copied only in accordance with the terms of those agreements.

This document is the intellectual property of Kollmorgen™ and contains proprietary and confidential information. The reproduction, modification, translation or disclosure to third parties of this document (in whole or in part) is strictly prohibited without the prior written permission of Kollmorgen™.

Trademarks

KAS and AKD are registered trademarks of [Kollmorgen™](#).

SERVOSTAR is a registered trademark of Kollmorgen™.

[Kollmorgen™](#) is part of the [Danaher Motion](#) company.

Windows® is a registered trademark of Microsoft Corporation

EnDat is a registered trademark of [Dr. Johannes Heidenhain GmbH](#).

[EtherCAT®](#) is registered trademark of [Ethercat Technology Group](#).

[PLCopen®](#) is an independent association providing efficiency in industrial automation.

INtime® is a registered trademark of [TenAsys® Corporation](#).

Codemeter is a registered trademark of [WIBU-Systems AG](#).

All product and company names are trademarks™ or registered® trademarks of their respective holders. Use of them does not imply any affiliation with or endorsement by them.

Kollmorgen Automation Suite is based on the work of:

- [AjaxFileUpload](#), software (distributed under the MPL License).
- [Apache log4net](#) library for output logging (distributed under the Apache License).
- bsdtar and libarchive2, a utility and library to create and read several different archive formats (distributed under the terms of the BSD License).
- bzip2.dll, a data compression library (distributed under the terms of the BSD License).
- [Curl](#) software library
- [DockPanel Suite](#), a docking library for .Net Windows Forms (distributed under the MIT License).
- [FileHelpers](#) library to import/export data from fixed length or delimited files.
- GCC Canadian Cross Compiler is used by the KAS IDE. The GCC Canadian Cross Compiler is distributed under the [terms](#) of the GNU General Public License (<http://www.gnu.org/licenses/gpl.html>). The GCC Canadian Cross Compiler source files, copyright notice, and readme are [available on KDN](#).
- [GNU gzip¹](#) (www.gnu.org) is used by the PDMM/PCMM (distributed under the [terms](#) of the GNU General Public License <http://www.gnu.org/licenses/gpl-2.0.html>).
- [GNU Tar²](#) (www.gnu.org) is used by the PDMM/PCMM (distributed under the [terms](#) of the GNU General Public License <http://www.gnu.org/licenses/gpl-2.0.html>).
- Icons provided by [Oxygen Team](#), (distributed under the [terms](#) of the GNU Lesser General Public License <https://www.gnu.org/licenses/lgpl.html>).
- [jQuery.Cookies](#), a Javascript library for accessing and manipulating HTTP cookies in the web browser (distributed under the MIT License).
- [jquery-csv](#), a library for parsing CSV files in javascript (distributed under the MIT license <http://www.opensource.org/licenses/mit-license.php>).

¹Copyright (C) 2007 Free Software Foundation, Inc. Copyright (C) 1993 Jean-loup Gailly. This is free software. You may redistribute copies of it under the terms of the GNU General Public License <<http://www.gnu.org/licenses/gpl.html>>. There is NO WARRANTY, to the extent permitted by law. Written by Jean-loup Gailly.

²Copyright (C) 2007 Free Software Foundation, Inc. License GPLv2+: GNU GPL version 2 or later <<http://gnu.org/licenses/gpl.html>> This is free software: you are free to change and redistribute it. There is NO WARRANTY, to the extent permitted by law. Written by John Gilmore and Jay Fenlason.

- [jQuery File Tree](#), a file browser plugin (distributed under the MIT License).
- [jQueryRotate](#), a plugin which rotates images (img html objects) by a given angle on web pages (distributed under the MIT License, <http://opensource.org/licenses/mit-license.php>).
- JsonCpp software (distributed under the MIT License –[see terms](#) see <http://jsoncpp.sourceforge.net/LICENSE> for terms).
- [LZMA SDK](#) (<http://www.7-zip.org/sdk.html>), used to compress crash dump information (available as public domain).
- [Mongoose](#) v3.7, an embedded web server library (distributed under the MIT License).
- [MVVM Light Toolkit](#) components for Model – View –ViewModel patterns with Windows Presentation Foundation (distributed under the MIT License).
- [pugixml](#), an XML and XPath parsing library (distributed under the MIT License).
- [Qwt](#) project (distributed under the terms of the GNU Lesser General Public License).
- [U-Boot](#), a universal boot loader is used by the AKD-PDMM (distributed under the [terms](#) of the GNU General Public License, <http://www.gnu.org/licenses/gpl-2.0.html>). The U-Boot source files, copyright notice, and readme are available on the distribution disk that is included with the AKD-PDMM.
- [ZedGraph](#) class library, user control, and web control for .NET (distributed under the LGPL License).
- [Zlib](#) software library
- Zlib1.dll, a data compression library (distributed under the terms of the BSD License).

All other product and brand names listed in this document may be trademarks or registered trademarks of their respective owners.

Disclaimer

The information in this document (Version G published on 9/15/2016) is believed to be accurate and reliable at the time of its release. Notwithstanding the foregoing, Kollmorgen assumes no responsibility for any damage or loss resulting from the use of this help, and expressly disclaims any liability or damages for loss of data, loss of use, and property damage of any kind, direct, incidental or consequential, in regard to or arising out of the performance or form of the materials presented herein or in any software programs that accompany this document.

All timing diagrams, whether produced by Kollmorgen or included by courtesy of the PLCopen organization, are provided with accuracy on a best-effort basis with no warranty, explicit or implied, by Kollmorgen. The user releases Kollmorgen from any liability arising out of the use of these timing diagrams.

This page intentionally left blank.

1 Table of Contents

1 Table of Contents	5
2 Motion Library	81
2.1 Motion Library / Pipe Network	82
2.1.1 Motion Library - Pipe Network	82
2.1.1.1 MLPipeAct	82
2.1.1.2.1 Description	82
2.1.1.3.2 Arguments	83
2.1.1.4.3.1 Input	83
2.1.1.5.4.2 Output	83
2.1.1.6.5.3 Return Type	83
2.1.1.7.6 Related Functions	83
2.1.1.8.7 Example	84
2.1.1.9.8.1 Structured Text	84
2.1.1.10.9.2 Ladder Diagram	84
2.1.1.11.10.3 Function Block Diagram	84
2.1.1.12 MLPipeAddBlock	84
2.1.1.13.1 Description	84
2.1.1.14.2 Arguments	85
2.1.1.15.3.1 Input	85
2.1.1.16.4.2 Output	85
2.1.1.17.5.3 Return Type	85
2.1.1.18.6 Related Functions	85
2.1.1.19.7 Example	85
2.1.1.20.8.1 Structured Text	85
2.1.1.21.9.2 Ladder Diagram	85
2.1.1.22.10.3 Function Block Diagram	86
2.1.1.23 MLPipeCreate	86
2.1.1.24.1 Description	86
2.1.1.25.2 Arguments	86
2.1.1.26.3.1 Input	86
2.1.1.27.4.2 Output	86
2.1.1.28.5 Related Functions	86
2.1.1.29.6 Example	87
2.1.1.30.7.1 Structured Text	87
2.1.1.31.8.2 Ladder Diagram	87
2.1.1.32.9.3 Function Block Diagram	87
2.1.1.33 MLPipeDeact	87
2.1.1.34.1 Description	87

2.1.1.35.2 Arguments	88
2.1.1.36.3.1 Input	88
2.1.1.37.4.2 Output	88
2.1.1.38.5.3 Return Type	88
2.1.1.39.6 Related Functions	88
2.1.1.40.7 Example	88
2.1.1.41.8.1 Structured Text	88
2.1.1.42.9.2 Ladder Diagram	88
2.1.1.43.10.3 Function Block Diagram	88
2.1.2 Motion Library - Block	88
2.1.2.1 MLBlkCreate	89
2.1.2.2.1 Description	89
2.1.2.3.2 Arguments	89
2.1.2.4.3.1 Input	89
2.1.2.5.4.2 Output	89
2.1.2.6.5 Related Functions	90
2.1.2.7.6 Example	90
2.1.2.8.7.1 Structured Text	90
2.1.2.9.8.2 Ladder Diagram	90
2.1.2.10.9.3 Function Block Diagram	90
2.1.2.11 MLBlkReadOutVal	90
2.1.2.12.1 Description	90
2.1.2.13.2 Arguments	90
2.1.2.14.3.1 Input	90
2.1.2.15.4.2 Output	91
2.1.2.16.5 Related Functions	91
2.1.2.17.6 Example	91
2.1.2.18.7.1 Structured Text	91
2.1.2.19.8.2 Ladder Diagram	91
2.1.2.20.9.3 Function Block Diagram	91
2.1.2.21 MLBlkReadModPos	91
2.1.2.22.1 Description	91
2.1.2.23.2 Arguments	91
2.1.2.24.3.1 Input	91
2.1.2.25.4.2 Output	92
2.1.2.26.5 Related Functions	92
2.1.2.27.6 Example	92
2.1.2.28.7.1 Structured Text	92
2.1.2.29.8.2 Ladder Diagram	92

2.1.2.30.9.3 Function Block Diagram	92
2.1.2.31 MLBlkIsReady	92
2.1.2.32.1 Description	92
2.1.2.33.2 Arguments	93
2.1.2.34.3.1 Input	93
2.1.2.35.4.2 Output	93
2.1.2.36.5.3 Return Type	93
2.1.2.37.6 Related Functions	93
2.1.2.38.7 Example	93
2.1.2.39.8.1 Structured Text	93
2.1.2.40.9.2 Ladder Diagram	93
2.1.2.41.10.3 Function Block Diagram	93
2.1.2.42 MLBlkWriteModPos	94
2.1.2.43.1 Description	94
2.1.2.44.2 Arguments	94
2.1.2.45.3.1 Input	94
2.1.2.46.4.2 Output	94
2.1.2.47.5.3 Return Type	94
2.1.2.48.6 Related Functions	94
2.1.2.49.7 Example	95
2.1.2.50.8.1 Structured Text	95
2.1.2.51.9.2 Ladder Diagram	95
2.1.2.52.10.3 Function Block Diagram	95
2.1.3 Motion Library - Adder	95
2.1.3.1 MLAddInit	95
2.1.3.2.1 Description	95
2.1.3.3.2 Arguments	96
2.1.3.4.3.1 Input	96
2.1.3.5.4.2 Output	97
2.1.3.6.5.3 Return Type	97
2.1.3.7.6 Related Functions	97
2.1.3.8.7 Example	97
2.1.3.9.8.1 Structured Text	97
2.1.3.10.9.2 Ladder Diagram	98
2.1.3.11.10.3 Function Block Diagram	98
2.1.3.12 MLAddReadOff1	98
2.1.3.13.1 Description	98
2.1.3.14.2 Arguments	98
2.1.3.15.3.1 Input	98

2.1.3.16.4.2 Output	98
2.1.3.17.5 Related Functions	99
2.1.3.18.6 Example	99
2.1.3.19.7.1 Structured Text	99
2.1.3.20.8.2 Ladder Diagram	99
2.1.3.21.9.3 Function Block Diagram	99
2.1.3.22 MAddReadOff2	99
2.1.3.23.1 Description	99
2.1.3.24.2 Arguments	100
2.1.3.25.3.1 Input	100
2.1.3.26.4.2 Output	100
2.1.3.27.5 Related Functions	100
2.1.3.28.6 Example	100
2.1.3.29.7.1 Structured Text	100
2.1.3.30.8.2 Ladder Diagram	100
2.1.3.31.9.3 Function Block Diagram	100
2.1.3.32 MAddReadRatio1	101
2.1.3.33.1 Description	101
2.1.3.34.2 Arguments	101
2.1.3.35.3.1 Input	101
2.1.3.36.4.2 Output	101
2.1.3.37.5 Related Functions	101
2.1.3.38.6 Example	101
2.1.3.39.7.1 Structured Text	101
2.1.3.40.8.2 Ladder Diagram	102
2.1.3.41.9.3 Function Block Diagram	102
2.1.3.42 MAddReadRatio2	102
2.1.3.43.1 Description	102
2.1.3.44.2 Arguments	102
2.1.3.45.3.1 Input	102
2.1.3.46.4.2 Output	102
2.1.3.47.5 Related Functions	102
2.1.3.48.6 Example	103
2.1.3.49.7.1 Structured Text	103
2.1.3.50.8.2 Ladder Diagram	103
2.1.3.51.9.3 Function Block Diagram	103
2.1.3.52 MAddWriteInput	103
2.1.3.53.1 Description	103
2.1.3.54.2 Arguments	103

2.1.3.55.3.1 Input	103
2.1.3.56.4.2 Output	104
2.1.3.57.5.3 Return Type	104
2.1.3.58.6 Related Functions	104
2.1.3.59.7 Example	104
2.1.3.60.8.1 Structured Text	104
2.1.3.61.9.2 Ladder Diagram	105
2.1.3.62.10.3 Function Block Diagram	105
2.1.3.63 MAddWriteOff1	105
2.1.3.64.1 Description	105
2.1.3.65.2 Arguments	105
2.1.3.66.3.1 Input	105
2.1.3.67.4.2 Output	106
2.1.3.68.5.3 Return Type	106
2.1.3.69.6 Related Functions	106
2.1.3.70.7 Example	106
2.1.3.71.8.1 Structured Text	106
2.1.3.72.9.2 Ladder Diagram	106
2.1.3.73.10.3 Function Block Diagram	106
2.1.3.74 MAddWriteOff2	107
2.1.3.75.1 Description	107
2.1.3.76.2 Arguments	107
2.1.3.77.3.1 Input	107
2.1.3.78.4.2 Output	107
2.1.3.79.5.3 Return Type	108
2.1.3.80.6 Related Functions	108
2.1.3.81.7 Example	108
2.1.3.82.8.1 Structured Text	108
2.1.3.83.9.2 Ladder Diagram	108
2.1.3.84.10.3 Function Block Diagram	108
2.1.3.85 MAddWriteRat1	108
2.1.3.86.1 Description	108
2.1.3.87.2 Arguments	109
2.1.3.88.3.1 Input	109
2.1.3.89.4.2 Output	109
2.1.3.90.5.3 Return Type	109
2.1.3.91.6 Related Functions	109
2.1.3.92.7 Example	109
2.1.3.93.8.1 Structured Text	109

2.1.3.94.9.2 Ladder Diagram	110
2.1.3.95.10.3 Function Block Diagram	110
2.1.3.96 MLAddWriteRat2	110
2.1.3.97.1 Description	110
2.1.3.98.2 Arguments	110
2.1.3.99.3.1 Input	110
2.1.3.100.4.2 Output	111
2.1.3.101.5.3 Return Type	111
2.1.3.102.6 Related Functions	111
2.1.3.103.7 Example	111
2.1.3.104.8.1 Structured Text	111
2.1.3.105.9.2 Ladder Diagram	111
2.1.3.106.10.3 Function Block Diagram	112
2.1.4 Motion Library - Axis	112
2.1.4.1 MLAxisAbs	113
2.1.4.2.1 Description	113
2.1.4.3.2 Arguments	114
2.1.4.4.3.1 Input	114
2.1.4.5 Position with Modulo On	114
2.1.4.6 Forcing the direction of rotation	114
2.1.4.7 Travel Speed Update with MLAxisAbs	115
2.1.4.8.1.1 Output	116
2.1.4.9.2 Related Functions	116
2.1.4.10.3 Example	117
2.1.4.11.4.1 Structured Text	117
2.1.4.12.5.2 Ladder Diagram	117
2.1.4.13.6.3 Function Block Diagram	117
2.1.4.14 MLAxisAdd	117
2.1.4.15.1 Description	117
2.1.4.16.2 Arguments	117
2.1.4.17.3.1 Input	117
2.1.4.18.4.2 Output	118
2.1.4.19.5 Related Functions	118
2.1.4.20.6 Example	118
2.1.4.21.7.1 Structured Text	118
2.1.4.22.8.2 Ladder Diagram	118
2.1.4.23.9.3 Function Block Diagram	118
2.1.4.24 MLAxisAddress	118
2.1.4.25.1 Description	118
2.1.4.26.2 Arguments	118

2.1.4.27.3.1 Input	118
2.1.4.28.4.2 Output	119
2.1.4.29.5 Example	119
2.1.4.30.6.1 Structured Text	119
2.1.4.31.7.2 Ladder Diagram	119
2.1.4.32.8.3 Function Block Diagram	119
2.1.4.33 MLAxisAddTq	119
2.1.4.34.1 Description	119
2.1.4.35.2 Arguments	119
2.1.4.36.3.1 Input	119
2.1.4.37.4.2 Output	120
2.1.4.38.5 Related Functions	120
2.1.4.39.6 Example	120
2.1.4.40.7.1 Structured Text	120
2.1.4.41.8.2 Ladder Diagram	120
2.1.4.42.9.3 Function Block Diagram	120
2.1.4.43 MLAxisCfgFastIn	120
2.1.4.44.1 Description	120
2.1.4.45.2 Arguments	120
2.1.4.46.3.1 Input	121
2.1.4.47.4.2 Output	121
2.1.4.48.5 Related Functions	121
2.1.4.49.6 See Also	122
2.1.4.50.7 Example	122
2.1.4.51.8.1 Structured Text	122
2.1.4.52.9.2 Ladder Diagram	122
2.1.4.53.10.3 Function Block Diagram	122
2.1.4.54 MLAxisCmdPos	122
2.1.4.55.1 Description	122
2.1.4.56.2 Arguments	122
2.1.4.57.3.1 Input	122
2.1.4.58.4.2 Output	122
2.1.4.59.5 Related Functions	123
2.1.4.60.6 Previous Function Name	123
2.1.4.61.7 Example	123
2.1.4.62.8.1 Structured Text	123
2.1.4.63.9.2 Ladder Diagram	123
2.1.4.64.10.3 Function Block Diagram	123
2.1.4.65 MLAxisCreate	123

2.1.4.66.1 Description	123
2.1.4.67.2 Arguments	123
2.1.4.68.3.1 Input	123
2.1.4.69.4.2 Output	124
2.1.4.70.5 Example	124
2.1.4.71.6.1 Structured Text	124
2.1.4.72.7.2 Ladder Diagram	124
2.1.4.73.8.3 Function Block Diagram	125
2.1.4.74 MAxisFBackPos	125
2.1.4.75.1 Description	125
2.1.4.76.2 Arguments	125
2.1.4.77.3.1 Input	125
2.1.4.78.4.2 Output	125
2.1.4.79.5 Related Functions	125
2.1.4.80.6 Example	125
2.1.4.81.7.1 Structured Text	126
2.1.4.82.8.2 Ladder Diagram	126
2.1.4.83.9.3 Function Block Diagram	126
2.1.4.84 MAxisGenEN	126
2.1.4.85.1 Description	126
2.1.4.86.2 Arguments	126
2.1.4.87.3.1 Input	126
2.1.4.88.4.2 Output	126
2.1.4.89.5 Related Functions	126
2.1.4.90.6 Example	127
2.1.4.91.7.1 Structured Text	127
2.1.4.92.8.2 Ladder Diagram	127
2.1.4.93.9.3 Function Block Diagram	127
2.1.4.94 MAxisGenIsEN	127
2.1.4.95.1 Description	127
2.1.4.96.2 Arguments	127
2.1.4.97.3.1 Input	127
2.1.4.98.4.2 Output	127
2.1.4.99.5 Related Functions	127
2.1.4.100.6 Example	127
2.1.4.101.7.1 Structured Text	128
2.1.4.102.8.2 Ladder Diagram	128
2.1.4.103.9.3 Function Block Diagram	128
2.1.4.104 MAxisGenIsRdy	128

2.1.4.105.1	Description	128
2.1.4.106.2	Arguments	128
2.1.4.107.3.1	Input	128
2.1.4.108.4.2	Output	128
2.1.4.109.5	Related Functions	128
2.1.4.110.6	Example	128
2.1.4.111.7.1	Structured Text	128
2.1.4.112.8.2	Ladder Diagram	129
2.1.4.113.9.3	Function Block Diagram	129
2.1.4.114	MLAxisGenPos	129
2.1.4.115.1	Description	129
2.1.4.116.2	Arguments	129
2.1.4.117.3.1	Input	129
2.1.4.118.4.2	Output	129
2.1.4.119.5	Related Functions	129
2.1.4.120.6	Example	130
2.1.4.121.7.1	Structured Text	130
2.1.4.122.8.2	Ladder Diagram	130
2.1.4.123.9.3	Function Block Diagram	130
2.1.4.124	MLAxisGenReadAcc	130
2.1.4.125.1	Description	130
2.1.4.126.2	Arguments	130
2.1.4.127.3.1	Input	130
2.1.4.128.4.2	Output	130
2.1.4.129.5	Related Functions	131
2.1.4.130.6	Example	131
2.1.4.131.7.1	Structured Text	131
2.1.4.132.8.2	Ladder Diagram	131
2.1.4.133.9.3	Function Block Diagram	131
2.1.4.134	MLAxisGenReadDec	131
2.1.4.135.1	Description	131
2.1.4.136.2	Arguments	131
2.1.4.137.3.1	Input	131
2.1.4.138.4.2	Output	131
2.1.4.139.5	Related Functions	132
2.1.4.140.6	Example	132
2.1.4.141.7.1	Structured Text	132
2.1.4.142.8.2	Ladder Diagram	132
2.1.4.143.9.3	Function Block Diagram	132

2.1.4.144	MLAxisGenReadSpd	132
2.1.4.145.1	Description	132
2.1.4.146.2	Arguments	132
2.1.4.147.3.1	Input	132
2.1.4.148.4.2	Output	132
2.1.4.149.5	Related Functions	133
2.1.4.150.6	Example	133
2.1.4.151.7.1	Structured Text	133
2.1.4.152.8.2	Ladder Diagram	133
2.1.4.153.9.3	Function Block Diagram	133
2.1.4.154	MLAxisGenWriteAcc	133
2.1.4.155.1	Description	133
2.1.4.156.2	Arguments	133
2.1.4.157.3.1	Input	133
2.1.4.158.4.2	Output	134
2.1.4.159.5	Related Functions	134
2.1.4.160.6	Example	134
2.1.4.161.7.1	Structured Text	134
2.1.4.162.8.2	Ladder Diagram	134
2.1.4.163.9.3	Function Block Diagram	134
2.1.4.164	MLAxisGenWriteDec	134
2.1.4.165.1	Description	134
2.1.4.166.2	Arguments	134
2.1.4.167.3.1	Input	134
2.1.4.168.4.2	Output	135
2.1.4.169.5	Related Functions	135
2.1.4.170.6	Example	135
2.1.4.171.7.1	Structured Text	135
2.1.4.172.8.2	Ladder Diagram	135
2.1.4.173.9.3	Function Block Diagram	136
2.1.4.174	MLAxisGenWriteSpd	136
2.1.4.175.1	Description	136
2.1.4.176.2	Arguments	136
2.1.4.177.3.1	Input	136
2.1.4.178.4.2	Output	136
2.1.4.179.5	Related Functions	136
2.1.4.180.6	Example	136
2.1.4.181.7.1	Structured Text	136
2.1.4.182.8.2	Ladder Diagram	137

2.1.4.183.9.3 Function Block Diagram	137
2.1.4.184 MLAxisInit	137
2.1.4.185.1 Description	137
2.1.4.186.2 Arguments	137
2.1.4.187.3.1 Input	137
2.1.4.188.4.2 Output	139
2.1.4.189.5 Example	139
2.1.4.190.6.1 Structured Text	139
2.1.4.191.7.2 Ladder Diagram	139
2.1.4.192.8.3 Function Block Diagram	139
2.1.4.193 MLAxisIsCncd	139
2.1.4.194.1 Description	139
2.1.4.195.2 Arguments	139
2.1.4.196.3.1 Input	140
2.1.4.197.4.2 Output	140
2.1.4.198.5 Example	140
2.1.4.199.6.1 Structured Text	140
2.1.4.200.7.2 Ladder Diagram	140
2.1.4.201.8.3 Function Block Diagram	140
2.1.4.202 MLAxisIsTriggered	140
2.1.4.203.1 Description	140
2.1.4.204.2 Arguments	140
2.1.4.205.3.1 Input	140
2.1.4.206.4.2 Output	141
2.1.4.207.5 Related Functions	141
2.1.4.208.6 Example	141
2.1.4.209.7.1 Structured Text	141
2.1.4.210.8.2 Ladder Diagram	141
2.1.4.211.9.3 Function Block Diagram	142
2.1.4.212 MLAxisMoveVel	142
2.1.4.213.1 Description	142
2.1.4.214.2 Arguments	142
2.1.4.215.3.1 Input	142
2.1.4.216.4.2 Output	142
2.1.4.217.5 Related Functions	142
2.1.4.218.6 Previous Function Name	143
2.1.4.219.7 Example	143
2.1.4.220.8.1 Structured Text	143
2.1.4.221.9.2 Ladder Diagram	143

2.1.4.222.10.3 Function Block Diagram	143
2.1.4.223 MAxisPipePos	143
2.1.4.224.1 Description	143
2.1.4.225.2 Arguments	143
2.1.4.226.3.1 Input	143
2.1.4.227.4.2 Output	143
2.1.4.228.5 Related Functions	144
2.1.4.229.6 Example	144
2.1.4.230.7.1 Structured Text	144
2.1.4.231.8.2 Ladder Diagram	144
2.1.4.232.9.3 Function Block Diagram	144
2.1.4.233 MAxisPower	144
2.1.4.234.1 Description	144
2.1.4.235.2 Arguments	144
2.1.4.236.3.1 Input	144
2.1.4.237.4.2 Output	145
2.1.4.238.5 Related Functions	145
2.1.4.239.6 Previous Function Name	145
2.1.4.240.7 Example	145
2.1.4.241.8.1 Structured Text	145
2.1.4.242.9.2 Ladder Diagram	145
2.1.4.243.10.3 Function Block Diagram	145
2.1.4.244 MAxisPowerDOff	146
2.1.4.245.1 Description	146
2.1.4.246.2 Arguments	146
2.1.4.247.3.1 Input	146
2.1.4.248.4.2 Output	146
2.1.4.249.5 Related Functions	146
2.1.4.250.6 Example	146
2.1.4.251.7.1 Structured Text	146
2.1.4.252.8.2 Ladder Diagram	146
2.1.4.253.9.3 Function Block Diagram	146
2.1.4.254 MAxisRatedTq	147
2.1.4.255.1 Description	147
2.1.4.256.2 Arguments	147
2.1.4.257.3.1 Input	147
2.1.4.258.4.2 Output	148
2.1.4.259.5 Related Functions	148
2.1.4.260.6 Example	148

2.1.4.261.7.1	Structured Text	148
2.1.4.262.8.2	Ladder Diagram	148
2.1.4.263.9.3	Function Block Diagram	148
2.1.4.264	MLAxisRead2ndFB	148
2.1.4.265.1	Description	148
2.1.4.266.2	Arguments	148
2.1.4.267.3.1	Input	148
2.1.4.268.4.2	Output	148
2.1.4.269.5	Related Functions	149
2.1.4.270.6	Example	149
2.1.4.271.7.1	Structured Text	149
2.1.4.272.8.2	Ladder Diagram	149
2.1.4.273.9.3	Function Block Diagram	149
2.1.4.274	MLAxisReadActPos	149
2.1.4.275.1	Description	149
2.1.4.276.2	Arguments	149
2.1.4.277.3.1	Input	149
2.1.4.278.4.2	Output	149
2.1.4.279.5	Related Functions	150
2.1.4.280.6	Previous Function Name	150
2.1.4.281.7	Example	150
2.1.4.282.8.1	Structured Text	150
2.1.4.283.9.2	Ladder Diagram	150
2.1.4.284.10.3	Function Block Diagram	150
2.1.4.285	MLAxisReadFBUnit	150
2.1.4.286.1	Description	150
2.1.4.287.2	Arguments	150
2.1.4.288.3.1	Input	150
2.1.4.289.4.2	Output	151
2.1.4.290.5	Example	151
2.1.4.291.6.1	Structured Text	151
2.1.4.292.7.2	Ladder Diagram	151
2.1.4.293.8.3	Function Block Diagram	151
2.1.4.294	MLAxisReadFEUU	151
2.1.4.295.1	Description	151
2.1.4.296.2	Arguments	151
2.1.4.297.3.1	Input	151
2.1.4.298.4.2	Output	152
2.1.4.299.5	Related Functions	152

2.1.4.300.6 Example	152
2.1.4.301.7.1 Structured Text	152
2.1.4.302.8.2 Ladder Diagram	152
2.1.4.303.9.3 Function Block Diagram	152
2.1.4.304 MAxisReadGenStatus	152
2.1.4.305.1 Description	152
2.1.4.306.2 Arguments	152
2.1.4.307.3.1 Input	152
2.1.4.308.4.2 Output	153
2.1.4.309.5 Related Functions	153
2.1.4.310.6 Previous Function Name	153
2.1.4.311.7 Example	153
2.1.4.312.8.1 Structured Text	153
2.1.4.313.9.2 Ladder Diagram	153
2.1.4.314.10.3 Function Block Diagram	153
2.1.4.315 MAxisReadModPos	153
2.1.4.316.1 Description	153
2.1.4.317.2 Arguments	154
2.1.4.318.3.1 Input	154
2.1.4.319.4.2 Output	154
2.1.4.320.5 Example	154
2.1.4.321.6.1 Structured Text	154
2.1.4.322.7.2 Ladder Diagram	154
2.1.4.323.8.3 Function Block Diagram	154
2.1.4.324 MAxisReadTq	154
2.1.4.325.1 Description	154
2.1.4.326.2 Arguments	155
2.1.4.327.3.1 Input	155
2.1.4.328.4.2 Output	155
2.1.4.329.5 Related Functions	155
2.1.4.330.6 Example	155
2.1.4.331.7.1 Structured Text	155
2.1.4.332.8.2 Ladder Diagram	155
2.1.4.333.9.3 Function Block Diagram	155
2.1.4.334 MAxisReadUUnits	156
2.1.4.335.1 Description	156
2.1.4.336.2 Arguments	156
2.1.4.337.3.1 Input	156
2.1.4.338.4.2 Output	156

2.1.4.339.5 Example	156
2.1.4.340.6.1 Structured Text	156
2.1.4.341.7.2 Ladder Diagram	156
2.1.4.342.8.3 Function Block Diagram	156
2.1.4.343 MAxisReadVel	156
2.1.4.344.1 Description	156
2.1.4.345.2 Arguments	157
2.1.4.346.3.1 Input	157
2.1.4.347.4.2 Output	157
2.1.4.348.5 Related Functions	157
2.1.4.349.6 Example	157
2.1.4.350.7.1 Structured Text	157
2.1.4.351.8.2 Ladder Diagram	157
2.1.4.352.9.3 Function Block Diagram	157
2.1.4.353 MAxisReAlgnRdy	157
2.1.4.354.1 Description	157
2.1.4.355.2 Arguments	157
2.1.4.356.3.1 Input	157
2.1.4.357.4.2 Output	158
2.1.4.358.5 Related Functions	158
2.1.4.359.6 Example	158
2.1.4.360.7.1 Structured Text	158
2.1.4.361.8.2 Ladder Diagram	158
2.1.4.362.9.3 Function Block Diagram	158
2.1.4.363 MAxisReAlign	158
2.1.4.364.1 Description	158
2.1.4.365.2 Arguments	159
2.1.4.366.3.1 Input	159
2.1.4.367.4.2 Output	159
2.1.4.368.5 Related Functions	160
2.1.4.369.6 Example	160
2.1.4.370.7.1 Structured Text	160
2.1.4.371.8.2 Ladder Diagram	160
2.1.4.372.9.3 Function Block Diagram	160
2.1.4.373 MAxisRel	160
2.1.4.374.1 Description	160
2.1.4.375.2 Arguments	160
2.1.4.376.3.1 Input	160
2.1.4.377.4.2 Output	161

2.1.4.378.5	Related Functions	161
2.1.4.379.6	Example	161
2.1.4.380.7.1	Structured Text	161
2.1.4.381.8.2	Ladder Diagram	161
2.1.4.382.9.3	Function Block Diagram	162
2.1.4.383	MLAxisResetErrors	162
2.1.4.384.1	Description	162
2.1.4.385.2	Arguments	162
2.1.4.386.3.1	Input	162
2.1.4.387.4.2	Output	162
2.1.4.388.5	Previous Function Name	162
2.1.4.389.6	Example	162
2.1.4.390.7.1	Structured Text	162
2.1.4.391.8.2	Ladder Diagram	162
2.1.4.392.9.3	Function Block Diagram	162
2.1.4.393	MLAxisRstFastIn	163
2.1.4.394.1	Description	163
2.1.4.395.2	Arguments	163
2.1.4.396.3.1	Input	163
2.1.4.397.4.2	Output	163
2.1.4.398.5	Related Functions	163
2.1.4.399.6	Example	163
2.1.4.400.7.1	Structured Text	163
2.1.4.401.8.2	Ladder Diagram	164
2.1.4.402.9.3	Function Block Diagram	164
2.1.4.403	MLAxisStatus	164
2.1.4.404.1	Description	164
2.1.4.405.2	Arguments	164
2.1.4.406.3.1	Input	164
2.1.4.407.4.2	Output	164
2.1.4.408.5	Example	165
2.1.4.409.6.1	Structured Text	165
2.1.4.410.7.2	Ladder Diagram	166
2.1.4.411.8.3	Function Block Diagram	166
2.1.4.412	MLAxisStop	166
2.1.4.413.1	Description	166
2.1.4.414.2	Arguments	166
2.1.4.415.3.1	Input	166
2.1.4.416.4.2	Output	167

2.1.4.417.5	Related Functions	168
2.1.4.418.6	Example	168
2.1.4.419.7.1	Structured Text	168
2.1.4.420.8.2	Ladder Diagram	168
2.1.4.421.9.3	Function Block Diagram	168
2.1.4.422	MLAxisTimeStamp	168
2.1.4.423.1	Description	168
2.1.4.424.2	Arguments	168
2.1.4.425.3.1	Input	168
2.1.4.426.4.2	Output	169
2.1.4.427.5	Related Functions	169
2.1.4.428.6	Example	169
2.1.4.429.7.1	Structured Text	169
2.1.4.430.8.2	Ladder Diagram	170
2.1.4.431.9.3	Function Block Diagram	170
2.1.4.432	MLAxisWriteModPos	170
2.1.4.433.1	Description	170
2.1.4.434.2	Arguments	170
2.1.4.435.3.1	Input	170
2.1.4.436.4.2	Output	170
2.1.4.437.5	Example	170
2.1.4.438.6.1	Structured Text	170
2.1.4.439.7.2	Ladder Diagram	170
2.1.4.440.8.3	Function Block Diagram	171
2.1.4.441	MLAxisWritePipPos	171
2.1.4.442.1	Description	171
2.1.4.443.2	Arguments	171
2.1.4.444.3.1	Input	171
2.1.4.445.4.2	Output	171
2.1.4.446.5	Related Functions	171
2.1.4.447.6	Example	171
2.1.4.448.7.1	Structured Text	171
2.1.4.449.8.2	Ladder Diagram	171
2.1.4.450.9.3	Function Block Diagram	172
2.1.4.451	MLAxisWritePos	172
2.1.4.452.1	Description	172
2.1.4.453.2	Arguments	173
2.1.4.454.3.1	Input	173
2.1.4.455.4.2	Output	174

2.1.4.456.5	Previous Function Name	174
2.1.4.457.6	Example	174
2.1.4.458.7.1	Structured Text	174
2.1.4.459.8.2	Ladder Diagram	174
2.1.4.460.9.3	Function Block Diagram	174
2.1.4.461	MLAxisWriteUUnits	174
2.1.4.462.1	Description	174
2.1.4.463.2	Arguments	174
2.1.4.464.3.1	Input	174
2.1.4.465.4.2	Output	174
2.1.4.466.5	Example	175
2.1.4.467.6.1	Structured Text	175
2.1.4.468.7.2	Ladder Diagram	175
2.1.4.469.8.3	Function Block Diagram	175
2.1.4.470	Usage Example of Axis Functions	175
2.1.5	Motion Library - Cam Profile	176
2.1.5.1	MLCamInit	177
2.1.5.2.1	Description	177
2.1.5.3.2	Arguments	177
2.1.5.4.3.1	Input	177
2.1.5.5.4.2	Output	178
2.1.5.6.5.3	Return Type	178
2.1.5.7.6	Related Functions	178
2.1.5.8.7	Example	178
2.1.5.9.8.1	Structured Text	178
2.1.5.10.9.2	Ladder Diagram	178
2.1.5.11.10.3	Function Block Diagram	179
2.1.5.12	MLCamSwitch	179
2.1.5.13.1	Description	179
2.1.5.14.2	Arguments	179
2.1.5.15.3.1	Input	179
2.1.5.16.4.2	Output	179
2.1.5.17.5.3	Return Type	179
2.1.5.18.6	Related Functions	179
2.1.5.19.7	Example	180
2.1.5.20.8.1	Structured Text	180
2.1.5.21.9.2	Ladder Diagram	180
2.1.5.22.10.3	Function Block Diagram	180
2.1.5.23	MLPrfReadIOffset	180
2.1.5.24.1	Description	180

2.1.5.25.2 Arguments	180
2.1.5.26.3.1 Input	180
2.1.5.27.4.2 Output	181
2.1.5.28.5 Related Functions	181
2.1.5.29.6 Example	181
2.1.5.30.7.1 Structured Text	181
2.1.5.31.8.2 Ladder Diagram	181
2.1.5.32.9.3 Function Block Diagram	181
2.1.5.33 MLPfReadIScale	181
2.1.5.34.1 Description	181
2.1.5.35.2 Arguments	182
2.1.5.36.3.1 Input	182
2.1.5.37.4.2 Output	182
2.1.5.38.5 Related Functions	182
2.1.5.39.6 Previous Function Name	182
2.1.5.40.7 Example	182
2.1.5.41.8.1 Structured Text	182
2.1.5.42.9.2 Ladder Diagram	182
2.1.5.43.10.3 Function Block Diagram	183
2.1.5.44 MLPfReadOOffset	183
2.1.5.45.1 Description	183
2.1.5.46.2 Arguments	183
2.1.5.47.3.1 Input	183
2.1.5.48.4.2 Output	183
2.1.5.49.5 Related Functions	183
2.1.5.50.6 Example	183
2.1.5.51.7.1 Structured Text	183
2.1.5.52.8.2 Ladder Diagram	184
2.1.5.53.9.3 Function Block Diagram	184
2.1.5.54 MLPfReadOScale	184
2.1.5.55.1 Description	184
2.1.5.56.2 Arguments	184
2.1.5.57.3.1 Input	184
2.1.5.58.4.2 Output	184
2.1.5.59.5 Related Functions	185
2.1.5.60.6 Previous Function Name	185
2.1.5.61.7 Example	185
2.1.5.62.8.1 Structured Text	185
2.1.5.63.9.2 Ladder Diagram	185

2.1.5.64.10.3 Function Block Diagram	185
2.1.5.65 MLPfWriteIOffset	185
2.1.5.66.1 Description	185
2.1.5.67.2 Arguments	186
2.1.5.68.3.1 Input	186
2.1.5.69.4.2 Output	186
2.1.5.70.5.3 Return Type	186
2.1.5.71.6 Related Functions	186
2.1.5.72.7 Example	186
2.1.5.73.8.1 Structured Text	186
2.1.5.74.9.2 Ladder Diagram	186
2.1.5.75.10.3 Function Block Diagram	186
2.1.5.76 MLPfWriteIScale	186
2.1.5.77.1 Description	187
2.1.5.78.2 Arguments	187
2.1.5.79.3.1 Input	187
2.1.5.80.4.2 Output	187
2.1.5.81.5.3 Return Type	187
2.1.5.82.6 Related Functions	187
2.1.5.83.7 Previous Function Name	187
2.1.5.84.8 Example	187
2.1.5.85.9.1 Structured Text	187
2.1.5.86.10.2 Ladder Diagram	188
2.1.5.87.11.3 Function Block Diagram	188
2.1.5.88 MLPfWriteOOffset	188
2.1.5.89.1 Description	188
2.1.5.90.2 Arguments	188
2.1.5.91.3.1 Input	188
2.1.5.92.4.2 Output	189
2.1.5.93.5.3 Return Type	189
2.1.5.94.6 Related Functions	189
2.1.5.95.7 Example	189
2.1.5.96.8.1 Structured Text	189
2.1.5.97.9.2 Ladder Diagram	189
2.1.5.98.10.3 Function Block Diagram	189
2.1.5.99 MLPfWriteOScale	189
2.1.5.100.1 Description	189
2.1.5.101.2 Arguments	190
2.1.5.102.3.1 Input	190

2.1.5.103.4.2	Output	190
2.1.5.104.5.3	Return Type	190
2.1.5.105.6	Related Functions	190
2.1.5.106.7	Previous Function Name	190
2.1.5.107.8	Example	190
2.1.5.108.9.1	Structured Text	190
2.1.5.109.10.2	Ladder Diagram	191
2.1.5.110.11.3	Function Block Diagram	191
2.1.6	Motion Library - Comparator	191
2.1.6.1	MLCompCheck	191
2.1.6.2.1	Description	191
2.1.6.3.2	Arguments	192
2.1.6.4.3.1	Input	192
2.1.6.5.4.2	Output	192
2.1.6.6.5.3	Return Type	192
2.1.6.7.6	Related Functions	192
2.1.6.8.7	Example	192
2.1.6.9.8.1	Structured Text	192
2.1.6.10.9.2	Ladder Diagram	193
2.1.6.11.10.3	Function Block Diagram	193
2.1.6.12	MLComplnit	193
2.1.6.13.1	Description	193
2.1.6.14.2	Arguments	193
2.1.6.15.3.1	Input	193
2.1.6.16.4.2	Output	194
2.1.6.17.5.3	Return Type	194
2.1.6.18.6	Related Functions	194
2.1.6.19.7	Example	194
2.1.6.20.8.1	Structured Text	194
2.1.6.21.9.2	Ladder Diagram	195
2.1.6.22.10.3	Function Block Diagram	195
2.1.6.23	MLCompReadRef	195
2.1.6.24.1	Description	195
2.1.6.25.2	Arguments	195
2.1.6.26.3.1	Input	195
2.1.6.27.4.2	Output	195
2.1.6.28.5	Related Functions	196
2.1.6.29.6	Example	196
2.1.6.30.7.1	Structured Text	196

2.1.6.31.8.2 Ladder Diagram	196
2.1.6.32.9.3 Function Block Diagram	196
2.1.6.33 MLCompReset	196
2.1.6.34.1 Description	196
2.1.6.35.2 Arguments	196
2.1.6.36.3.1 Input	196
2.1.6.37.4.2 Output	196
2.1.6.38.5.3 Return Type	197
2.1.6.39.6 Related Functions	197
2.1.6.40.7 Example	197
2.1.6.41.8.1 Structured Text	197
2.1.6.42.9.2 Ladder Diagram	197
2.1.6.43.10.3 Function Block Diagram	197
2.1.6.44 MLCompWriteRef	197
2.1.6.45.1 Description	197
2.1.6.46.2 Arguments	198
2.1.6.47.3.1 Input	198
2.1.6.48.4.2 Output	198
2.1.6.49.5.3 Return Type	199
2.1.6.50.6 Related Functions	199
2.1.6.51.7 Example	199
2.1.6.52.8.1 Structured Text	199
2.1.6.53.9.2 Ladder Diagram	199
2.1.6.54.10.3 Function Block Diagram	199
2.1.6.55 Usage example of Comparator Functions	199
2.1.7 Motion Library - Convertor	201
2.1.7.1 MLCNVConnect	201
2.1.7.2.1 Description	201
2.1.7.3.2 Arguments	202
2.1.7.4.3.1 Input	202
2.1.7.5.4.2 Output	202
2.1.7.6.5.3 Return Type	202
2.1.7.7.6 Related Functions	203
2.1.7.8.7 Example	203
2.1.7.9.8.1 Structured Text	203
2.1.7.10.9.2 Ladder Diagram	203
2.1.7.11.10.3 Function Block Diagram	203
2.1.7.12 MLCNVConnectEx	203
2.1.7.13.1 Description	203
2.1.7.14.2 Arguments	203

2.1.7.15.3.1	Input	203
2.1.7.16.4.2	Output	205
2.1.7.17.5.3	Return Type	205
2.1.7.18.6	Related Functions	205
2.1.7.19.7	Example	205
2.1.7.20.8.1	Structured Text	205
2.1.7.21.9.2	Ladder Diagram	205
2.1.7.22.10.3	Function Block Diagram	205
2.1.7.23	MLCNVConECAT	205
2.1.7.24.1	Description	205
2.1.7.25.2	Arguments	206
2.1.7.26.3.1	Input	206
2.1.7.27.4.2	Output	207
2.1.7.28.5	Related Functions	207
2.1.7.29.6	Example	207
2.1.7.30.7.1	Structured Text	207
2.1.7.31.8.2	Ladder Diagram	207
2.1.7.32.9.3	Function Block Diagram	207
2.1.7.33	MLCNVDisconnect	207
2.1.7.34.1	Description	207
2.1.7.35.2	Arguments	207
2.1.7.36.3.1	Input	207
2.1.7.37.4.2	Output	208
2.1.7.38.5.3	Return Type	208
2.1.7.39.6	Related Functions	208
2.1.7.40.7	Example	208
2.1.7.41.8.1	Structured Text	208
2.1.7.42.9.2	Ladder Diagram	208
2.1.7.43.10.3	Function Block Diagram	208
2.1.7.44	MLCNVInit	208
2.1.7.45.1	Description	208
2.1.7.46.2	Arguments	209
2.1.7.47.3.1	Input	209
2.1.7.48.4.2	Output	209
2.1.7.49.5.3	Return Type	209
2.1.7.50.6	Related Functions	209
2.1.7.51.7	Example	209
2.1.7.52.8.1	Structured Text	209
2.1.7.53.9.2	Ladder Diagram	209

2.1.7.54.10.3 Function Block Diagram	210
2.1.8 Motion Library - Delay	210
2.1.8.1 MLDelayInit	210
2.1.8.2.1 Description	210
2.1.8.3.2 Arguments	210
2.1.8.4.3.1 Input	210
2.1.8.5.4.2 Example	210
2.1.8.6.5.3 Structured Text	210
2.1.8.7.6.4 Ladder Diagram	211
2.1.8.8.7.5 Function Block Diagram	211
2.1.9 Motion Library - Derivator	211
2.1.9.1 MLDerInit	211
2.1.9.2.1 Description	211
2.1.9.3.2 Arguments	212
2.1.9.4.3.1 Input	212
2.1.9.5.4.2 Output	212
2.1.9.6.5.3 Return Type	212
2.1.9.7.6 Related Functions	212
2.1.9.8.7 Example	212
2.1.9.9.8.1 Structured Text	213
2.1.9.10.9.2 Ladder Diagram	213
2.1.9.11.10.3 Function Block Diagram	213
2.1.9.12 MLDerReadInModPos	213
2.1.9.13.1 Description	213
2.1.9.14.2 Arguments	214
2.1.9.15.3.1 Input	214
2.1.9.16.4.2 Output	214
2.1.9.17.5 Related Functions	214
2.1.9.18.6 Example	214
2.1.9.19.7.1 Structured Text	214
2.1.9.20.8.2 Ladder Diagram	214
2.1.9.21.9.3 Function Block Diagram	214
2.1.9.22 MLDerWriteInModPos	215
2.1.9.23.1 Description	215
2.1.9.24.2 Arguments	215
2.1.9.25.3.1 Input	215
2.1.9.26.4.2 Output	216
2.1.9.27.5.3 Return Type	216
2.1.9.28.6 Related Functions	216
2.1.9.29.7 Example	216

2.1.9.30.8.1	Structured Text	216
2.1.9.31.9.2	Ladder Diagram	216
2.1.9.32.10.3	Function Block Diagram	216
2.1.10	Motion Library - Gear	216
2.1.10.1	Usage example of Gear Functions	217
2.1.10.2	MLGearInit	219
2.1.10.3.1	Description	219
2.1.10.4.2	Arguments	219
2.1.10.5.3.1	Input	219
2.1.10.6.4.2	Output	221
2.1.10.7.5.3	Return Type	221
2.1.10.8.6	Related Functions	221
2.1.10.9.7	Example	221
2.1.10.10.8.1	Structured Text	221
2.1.10.11.9.2	Ladder Diagram	221
2.1.10.12.10.3	Function Block Diagram	222
2.1.10.13	MLGearReadOffset	222
2.1.10.14.1	Description	222
2.1.10.15.2	Arguments	222
2.1.10.16.3.1	Input	222
2.1.10.17.4.2	Output	222
2.1.10.18.5	Related Functions	223
2.1.10.19.6	Example	223
2.1.10.20.7.1	Structured Text	223
2.1.10.21.8.2	Ladder Diagram	223
2.1.10.22.9.3	Function Block Diagram	223
2.1.10.23	MLGearReadOffSlp	223
2.1.10.24.1	Description	223
2.1.10.25.2	Arguments	223
2.1.10.26.3.1	Input	223
2.1.10.27.4.2	Output	223
2.1.10.28.5	Related Functions	224
2.1.10.29.6	Example	224
2.1.10.30.7.1	Structured Text	224
2.1.10.31.8.2	Ladder Diagram	224
2.1.10.32.9.3	Function Block Diagram	224
2.1.10.33	MLGearReadRatio	224
2.1.10.34.1	Description	224
2.1.10.35.2	Arguments	224
2.1.10.36.3.1	Input	224

2.1.10.37.4.2 Output	225
2.1.10.38.5 Related Functions	225
2.1.10.39.6 Example	225
2.1.10.40.7.1 Structured Text	225
2.1.10.41.8.2 Ladder Diagram	225
2.1.10.42.9.3 Function Block Diagram	225
2.1.10.43 MLGearReadRatSlp	225
2.1.10.44.1 Description	225
2.1.10.45.2 Arguments	225
2.1.10.46.3.1 Input	225
2.1.10.47.4.2 Output	226
2.1.10.48.5 Related Functions	226
2.1.10.49.6 Example	226
2.1.10.50.7.1 Structured Text	226
2.1.10.51.8.2 Ladder Diagram	226
2.1.10.52.9.3 Function Block Diagram	226
2.1.10.53 MLGearWriteOff	226
2.1.10.54.1 Description	226
2.1.10.55.2 Arguments	226
2.1.10.56.3.1 Input	226
2.1.10.57.4.2 Output	227
2.1.10.58.5.3 Return Type	227
2.1.10.59.6 Related Functions	227
2.1.10.60.7 Example	227
2.1.10.61.8.1 Structured Text	227
2.1.10.62.9.2 Ladder Diagram	227
2.1.10.63.10.3 Function Block Diagram	228
2.1.10.64 MLGearWriteOSlp	228
2.1.10.65.1 Description	228
2.1.10.66.2 Arguments	228
2.1.10.67.3.1 Input	228
2.1.10.68.4.2 Output	228
2.1.10.69.5.3 Return Type	229
2.1.10.70.6 Related Functions	229
2.1.10.71.7 Example	229
2.1.10.72.8.1 Structured Text	229
2.1.10.73.9.2 Ladder Diagram	229
2.1.10.74.10.3 Function Block Diagram	229
2.1.10.75 MLGearWriteRatio	229

2.1.10.76.1 Description	229
2.1.10.77.2 Arguments	229
2.1.10.78.3.1 Input	229
2.1.10.79.4.2 Output	230
2.1.10.80.5.3 Return Type	230
2.1.10.81.6 Related Functions	230
2.1.10.82.7 Example	230
2.1.10.83.8.1 Structured Text	230
2.1.10.84.9.2 Ladder Diagram	230
2.1.10.85.10.3 Function Block Diagram	230
2.1.10.86 MLGearWriteRatSlp	231
2.1.10.87.1 Description	231
2.1.10.88.2 Arguments	231
2.1.10.89.3.1 Input	231
2.1.10.90.4.2 Output	231
2.1.10.91.5.3 Return Type	232
2.1.10.92.6 Related Functions	232
2.1.10.93.7 Example	232
2.1.10.94.8.1 Structured Text	232
2.1.10.95.9.2 Ladder Diagram	232
2.1.10.96.10.3 Function Block Diagram	232
2.1.10.97.11.4 RatioSlope Offset	232
2.1.11 Motion Library - Integrator	233
2.1.11.1 MLIntInit	233
2.1.11.2.1 Description	233
2.1.11.3.2 Arguments	233
2.1.11.4.3.1 Input	233
2.1.11.5.4.2 Output	234
2.1.11.6.5.3 Return Type	234
2.1.11.7.6 Related Functions	234
2.1.11.8.7 Example	234
2.1.11.9.8.1 Structured Text	234
2.1.11.10.9.2 Ladder Diagram	234
2.1.11.11.10.3 Function Block Diagram	235
2.1.11.12 MLIntWriteOutVal	235
2.1.11.13.1 Description	235
2.1.11.14.2 Arguments	235
2.1.11.15.3.1 Input	235
2.1.11.16.4.2 Output	235

2.1.11.17.5.3 Return Type	236
2.1.11.18.6 Related Functions	236
2.1.11.19.7 Example	236
2.1.11.20.8.1 Structured Text	236
2.1.11.21.9.2 Ladder Diagram	236
2.1.11.22.10.3 Function Block Diagram	236
2.1.12 Motion Library - Master	236
2.1.12.1 Usage example of Master Functions	237
2.1.12.2 MLMstAbs	238
2.1.12.3.1 Description	238
2.1.12.4.2 Arguments	238
2.1.12.5.3.1 Input	238
2.1.12.6.4.2 Output	239
2.1.12.7.5 Related Functions	240
2.1.12.8.6 Examples	240
2.1.12.9.7.1 Structured Text	240
2.1.12.10.8.2 Ladder Diagram	240
2.1.12.11.9.3 Function Block Diagram	240
2.1.12.12 MLMstAdd	240
2.1.12.13.1 Description	240
2.1.12.14.2 Arguments	240
2.1.12.15.3.1 Input	240
2.1.12.16.4.2 Output	241
2.1.12.17.5 Related Functions	241
2.1.12.18.6 Example	241
2.1.12.19.7.1 Structured Text	241
2.1.12.20.8.2 Ladder Diagram	241
2.1.12.21.9.3 Function Block Diagram	242
2.1.12.22 MLMstForcePos	242
2.1.12.23.1 Description	242
2.1.12.24.2 Arguments	242
2.1.12.25.3.1 Input	242
2.1.12.26.4.2 Output	242
2.1.12.27.5 Related Functions	243
2.1.12.28.6 Example	243
2.1.12.29.7.1 Structured Text	243
2.1.12.30.8.2 Ladder Diagram	243
2.1.12.31.9.3 Function Block Diagram	243
2.1.12.32 MLMstInit	243
2.1.12.33.1 Description	243

2.1.12.34.2 Arguments	243
2.1.12.35.3.1 Input	243
2.1.12.36.4.2 Output	245
2.1.12.37.5 Example	245
2.1.12.38.6.1 Structured Text	245
2.1.12.39.7.2 Ladder Diagram	245
2.1.12.40.8.3 Function Block Diagram	246
2.1.12.41 MLMstReadAccel	246
2.1.12.42.1 Description	246
2.1.12.43.2 Arguments	246
2.1.12.44.3.1 Input	246
2.1.12.45.4.2 Output	246
2.1.12.46.5 Related Functions	247
2.1.12.47.6 Example	247
2.1.12.48.7.1 Structured Text	247
2.1.12.49.8.2 Ladder Diagram	247
2.1.12.50 Function Block Diagram	247
2.1.12.51 MLMstReadDecel	247
2.1.12.52.1 Description	247
2.1.12.53.2 Arguments	247
2.1.12.54.3.1 Input	247
2.1.12.55.4.2 Output	248
2.1.12.56.5 Example	248
2.1.12.57.6.1 Structured Text	248
2.1.12.58.7.2 Ladder Diagram	248
2.1.12.59.8.3 Function Block Diagram	248
2.1.12.60 MLMstReadInitPos	248
2.1.12.61.1 Description	248
2.1.12.62.2 Arguments	249
2.1.12.63.3.1 Input	249
2.1.12.64.4.2 Output	249
2.1.12.65.5 Example	249
2.1.12.66.6.1 Structured Text	249
2.1.12.67.7.2 Ladder Diagram	249
2.1.12.68.8.3 Function Block Diagram	249
2.1.12.69 MLMstReadSpeed	250
2.1.12.70.1 Description	250
2.1.12.71.2 Arguments	250
2.1.12.72.3.1 Input	250

2.1.12.73.4.2 Output	250
2.1.12.74.5 Related Functions	250
2.1.12.75.6 Example	250
2.1.12.76.7.1 Structured Text	250
2.1.12.77.8.2 Ladder Diagram	251
2.1.12.78.9.3 Function Block Diagram	251
2.1.12.79 MLMstRel	251
2.1.12.80.1 Description	251
2.1.12.81.2 Arguments	251
2.1.12.82.3.1 Input	251
2.1.12.83.4.2 Output	252
2.1.12.84.5 Related Functions	252
2.1.12.85.6 Example	252
2.1.12.86.7.1 Structured Text	252
2.1.12.87.8.2 Ladder Diagram	252
2.1.12.88.9.3 Function Block Diagram	252
2.1.12.89 MLMstRun	252
2.1.12.90.1 Description	252
2.1.12.91.2 Arguments	252
2.1.12.92.3.1 Input	252
2.1.12.93.4.2 Output	253
2.1.12.94.5 Related Functions	253
2.1.12.95.6 Example	253
2.1.12.96.7.1 Structured Text	253
2.1.12.97.8.2 Ladder Diagram	253
2.1.12.98.9.3 Function Block Diagram	253
2.1.12.99 MLMstStatus	254
2.1.12.100.1 Description	254
2.1.12.101.2 Arguments	254
2.1.12.102.3.1 Input	254
2.1.12.103.4.2 Output	255
2.1.12.104.5 Example	255
2.1.12.105.6.1 Structured Text	255
2.1.12.106.7.2 Ladder Diagram	255
2.1.12.107.8.3 Function Block Diagram	255
2.1.12.108 MLMstWriteAccel	255
2.1.12.109.1 Description	255
2.1.12.110.2 Arguments	255
2.1.12.111.3.1 Input	255

2.1.12.112.4.2 Output	256
2.1.12.113.5 Related Functions	256
2.1.12.114.6 Example	256
2.1.12.115.7.1 Structured Text	256
2.1.12.116.8.2 Ladder Diagram	256
2.1.12.117.9.3 Function Block Diagram	257
2.1.12.118 MLMstWriteDecel	257
2.1.12.119.1 Description	257
2.1.12.120.2 Arguments	257
2.1.12.121.3.1 Input	257
2.1.12.122.4.2 Output	257
2.1.12.123.5 Related Functions	257
2.1.12.124.6 Example	257
2.1.12.125.7.1 Structured Text	258
2.1.12.126.8.2 Ladder Diagram	258
2.1.12.127.9.3 Function Block Diagram	258
2.1.12.128 MLMstWriteInitPos	258
2.1.12.129.1 Description	258
2.1.12.130.2 Arguments	258
2.1.12.131.3.1 Input	258
2.1.12.132.4.2 Output	259
2.1.12.133.5 Example	259
2.1.12.134.6.1 Structured Text	259
2.1.12.135.7.2 Ladder Diagram	259
2.1.12.136.8.3 Function Block Diagram	259
2.1.12.137 MLMstWriteSpeed	259
2.1.12.138.1 Description	259
2.1.12.139.2 Arguments	259
2.1.12.140.3.1 Input	259
2.1.12.141.4.2 Output	260
2.1.12.142.5 Related Functions	260
2.1.12.143.6 Example	260
2.1.12.144.7.1 Structured Text	260
2.1.12.145.8.2 Ladder Diagram	260
2.1.12.146.9.3 Function Block Diagram	260
2.1.13 Motion Library - Phaser	261
2.1.13.1 Usage example of Phaser Functions	261
2.1.13.2 MLPhalnit	262
2.1.13.3.1 Description	262
2.1.13.4.2 Arguments	262

2.1.13.5.3.1 Input	262
2.1.13.6.4.2 Output	263
2.1.13.7.5 Related Functions	263
2.1.13.8.6 Example	264
2.1.13.9.7.1 Structured Text	264
2.1.13.10.8.2 Ladder Diagram	264
2.1.13.11.9.3 Function Block Diagram	264
2.1.13.12 MLPhaReadActPhase	264
2.1.13.13.1 Description	264
2.1.13.14.2 Arguments	264
2.1.13.15.3.1 Input	264
2.1.13.16.4.2 Output	265
2.1.13.17.5 Related Functions	265
2.1.13.18.6 Example	265
2.1.13.19.7.1 Structured Text	265
2.1.13.20.8.2 Ladder Diagram	265
2.1.13.21.9.3 Function Block Diagram	265
2.1.13.22 MLPhaReadPhase	265
2.1.13.23.1 Description	265
2.1.13.24.2 Arguments	265
2.1.13.25.3.1 Input	265
2.1.13.26.4.2 Output	265
2.1.13.27.5 Example	266
2.1.13.28.6.1 Structured Text	266
2.1.13.29.7.2 Ladder Diagram	266
2.1.13.30.8.3 Function Block Diagram	266
2.1.13.31 MLPhaReadSlope	266
2.1.13.32.1 Description	266
2.1.13.33.2 Arguments	266
2.1.13.34.3.1 Input	266
2.1.13.35.4.2 Output	266
2.1.13.36.5 Related Functions	266
2.1.13.37.6 Example	267
2.1.13.38.7.1 Structured Text	267
2.1.13.39.8.2 Ladder Diagram	267
2.1.13.40.9.3 Function Block Diagram	267
2.1.13.41 MLPhaWritePhase	267
2.1.13.42.1 Description	267
2.1.13.43.2 Arguments	267

2.1.13.44.3.1 Input	267
2.1.13.45.4.2 Output	267
2.1.13.46.5 Related Functions	268
2.1.13.47.6 Example	268
2.1.13.48.7.1 Structured Text	268
2.1.13.49.8.2 Ladder Diagram	268
2.1.13.50.9.3 Function Block Diagram	268
2.1.13.51 MLPHaWriteSlope	268
2.1.13.52.1 Description	268
2.1.13.53.2 Arguments	268
2.1.13.54.3.1 Input	268
2.1.13.55.4.2 Output	269
2.1.13.56.5 Related Functions	269
2.1.13.57.6 Example	269
2.1.13.58.7.1 Structured Text	269
2.1.13.59.8.2 Ladder Diagram	269
2.1.13.60.9.3 Function Block Diagram	269
2.1.14 Motion Library - PMP	269
2.1.14.1 MLPmpAbs	270
2.1.14.2.1 Description	270
2.1.14.3.2 Arguments	270
2.1.14.4.3.1 Input	270
2.1.14.5.4.2 Output	271
2.1.14.6.5 Related Functions	271
2.1.14.7.6 Example	271
2.1.14.8.7.1 Structured Text	271
2.1.14.9.8.2 Ladder Diagram	271
2.1.14.10.9.3 Function Block Diagram	271
2.1.14.11 MLPmpForcePos	271
2.1.14.12.1 Description	271
2.1.14.13.2 Arguments	271
2.1.14.14.3.1 Input	271
2.1.14.15.4.2 Output	272
2.1.14.16.5 Related Functions	272
2.1.14.17.6 Example	272
2.1.14.18.7.1 Structured Text	272
2.1.14.19.8.2 Ladder Diagram	272
2.1.14.20.9.3 Function Block Diagram	273
2.1.14.21 MLPmplnit	273

2.1.14.22.1 Description	273
2.1.14.23.2 Arguments	273
2.1.14.24.3.1 Input	273
2.1.14.25.4.2 Output	275
2.1.14.26.5 Related Functions	275
2.1.14.27.6 Example	275
2.1.14.28.7.1 Structured Text	275
2.1.14.29.8.2 Ladder Diagram	275
2.1.14.30.9.3 Function Block Diagram	276
2.1.14.31 MLPmpReadAccel	276
2.1.14.32.1 Description	276
2.1.14.33.2 Arguments	276
2.1.14.34.3.1 Input	276
2.1.14.35.4.2 Output	276
2.1.14.36.5 Related Functions	276
2.1.14.37.6 Example	276
2.1.14.38.7.1 Structured Text	276
2.1.14.39.8.2 Ladder Diagram	277
2.1.14.40.9.3 Function Block Diagram	277
2.1.14.41 MLPmpReadFstSpd	277
2.1.14.42.1 Descriptions	277
2.1.14.43.2 Arguments	277
2.1.14.44.3.1 Input	277
2.1.14.45.4.2 Output	277
2.1.14.46.5 Related Functions	277
2.1.14.47.6 Example	278
2.1.14.48.7.1 Structured Text	278
2.1.14.49.8.2 Ladder Diagram	278
2.1.14.50.9.3 Function Block Diagram	278
2.1.14.51 MLPmpReadInitPos	278
2.1.14.52.1 Description	278
2.1.14.53.2 Arguments	278
2.1.14.54.3.1 Input	278
2.1.14.55.4.2 Output	278
2.1.14.56.5 Related Functions	278
2.1.14.57.6 Example	278
2.1.14.58.7.1 Structured Text	278
2.1.14.59.8.2 Ladder Diagram	279
2.1.14.60.9.3 Function Block Diagram	279

2.1.14.61 MLPmpReadJerk	279
2.1.14.62.1 Description	279
2.1.14.63.2 Arguments	279
2.1.14.64.3.1 Input	279
2.1.14.65.4.2 Output	279
2.1.14.66.5 Example	279
2.1.14.67.6.1 Structured Text	279
2.1.14.68.7.2 Ladder Diagram	279
2.1.14.69.8.3 Function Block Diagram	280
2.1.14.70 MLPmpReadLstSpd	280
2.1.14.71.1 Description	280
2.1.14.72.2 Arguments	280
2.1.14.73.3.1 Input	280
2.1.14.74.4.2 Output	280
2.1.14.75.5 Related Functions	280
2.1.14.76.6 Example	280
2.1.14.77.7.1 Structured Text	280
2.1.14.78.8.2 Ladder Diagram	280
2.1.14.79.9.3 Function Block Diagram	281
2.1.14.80 MLPmpRel	281
2.1.14.81.1 Description	281
2.1.14.82.2 Arguments	281
2.1.14.83.3.1 Input	281
2.1.14.84.4.2 Output	282
2.1.14.85.5 Related Functions	282
2.1.14.86.6 Example	282
2.1.14.87.7.1 Structured Text	282
2.1.14.88.8.2 Ladder Diagram	282
2.1.14.89.9.3 Function Block Diagram	282
2.1.14.90 MLPmpRun	283
2.1.14.91.1 Description	283
2.1.14.92.2 Arguments	283
2.1.14.93.3.1 Input	283
2.1.14.94.4.2 Output	283
2.1.14.95.5 Related Functions	283
2.1.14.96.6 Example	284
2.1.14.97.7.1 Structured Text	284
2.1.14.98.8.2 Ladder Diagram	284
2.1.14.99.9.3 Function Block Diagram	284

2.1.14.100 MLPmpStatus	284
2.1.14.101.1 Description	284
2.1.14.102.2 Arguments	284
2.1.14.103.3.1 Input	284
2.1.14.104.4.2 Output	284
2.1.14.105.5 Example	285
2.1.14.106.6.1 Structured Text	285
2.1.14.107.7.2 Ladder Diagram	285
2.1.14.108.8.3 Function Block Diagram	285
2.1.14.109 MLPmpWriteAccel	285
2.1.14.110.1 Description	285
2.1.14.111.2 Arguments	285
2.1.14.112.3.1 Input	285
2.1.14.113.4.2 Output	286
2.1.14.114.5 Related Functions	286
2.1.14.115.6 Example	286
2.1.14.116.7.1 Structured Text	286
2.1.14.117.8.2 Ladder Diagram	286
2.1.14.118.9.3 Function Block Diagram	286
2.1.14.119 MLPmpWriteFstSpd	287
2.1.14.120.1 Description	287
2.1.14.121.2 Arguments	287
2.1.14.122.3.1 Input	287
2.1.14.123.4.2 Output	287
2.1.14.124.5 Related Functions	287
2.1.14.125.6 Example	287
2.1.14.126.7.1 Structured Text	287
2.1.14.127.8.2 Ladder Diagram	288
2.1.14.128.9.3 Function Block Diagram	288
2.1.14.129 MLPmpWriteJerk	288
2.1.14.130.1 Description	288
2.1.14.131.2 Arguments	288
2.1.14.132.3.1 Input	288
2.1.14.133.4.2 Output	288
2.1.14.134.5 Related Functions	288
2.1.14.135.6 Example	289
2.1.14.136.7.1 Structured Text	289
2.1.14.137.8.2 Ladder Diagram	289
2.1.14.138.9.3 Function Block Diagram	289

2.1.14.139 MLPmpWriteLstSpd	289
2.1.14.140.1 Description	289
2.1.14.141.2 Arguments	289
2.1.14.142.3.1 Input	289
2.1.14.143.4.2 Output	290
2.1.14.144.5 Related Functions	290
2.1.14.145.6 Example	290
2.1.14.146.7.1 Structured Text	290
2.1.14.147.8.2 Ladder Diagram	290
2.1.14.148.9.3 Function Block Diagram	290
2.1.15 Motion Library - Sampler	290
2.1.15.1 MLSmpConnect	291
2.1.15.2.1 Description	291
2.1.15.3.2.1 Related Function Blocks	291
2.1.15.4.3 Arguments	291
2.1.15.5.4.1 Input	291
2.1.15.6.5.2 Output	291
2.1.15.7.6.3 Return Type	291
2.1.15.8.7 Example	292
2.1.15.9.8.1 Structured Text	292
2.1.15.10.9.2 Ladder Diagram	292
2.1.15.11.10.3 Function Block Diagram	292
2.1.15.12 MLSmpConECAT	292
2.1.15.13.1 Description	292
2.1.15.14.2.1 Related Function Blocks	292
2.1.15.15.3 Arguments	292
2.1.15.16.4.1 Input	292
2.1.15.17.5.2 Output	293
2.1.15.18.6.3 Return Type	293
2.1.15.19.7 Example	293
2.1.15.20.8.1 Structured Text	293
2.1.15.21.9.2 Ladder Diagram	294
2.1.15.22.10.3 Function Block Diagram	294
2.1.15.23 MLSmpConnectEx	294
2.1.15.24.1 Description	294
2.1.15.25 MLSmplnit	294
2.1.15.26.1 Description	294
2.1.15.27.2.1 Related Function Blocks	295
2.1.15.28.3 Arguments	295

2.1.15.29.4.1 Input	295
2.1.15.30.5.2 Output	296
2.1.15.31.6 Example	296
2.1.15.32.7.1 Structured Text	296
2.1.15.33.8.2 Ladder Diagram	296
2.1.15.34.9.3 Function Block Diagram	296
2.1.15.35 MLSmpConPLCAxis	297
2.1.15.36.1 Description	297
2.1.15.37.2 Arguments	297
2.1.15.38.3.1 Input	297
2.1.15.39.4.2 Output	298
2.1.15.40.5.3 Return Type	298
2.1.15.41.6 Example	298
2.1.15.42.7.1 Structured Text	298
2.1.15.43.8.2 Ladder Diagram	298
2.1.15.44.9.3 Function Block Diagram	298
2.1.15.45 MLSmpConPNAxis	298
2.1.15.46.1 Description	298
2.1.15.47.2 Arguments	299
2.1.15.48.3.1 Input	299
2.1.15.49.4.2 Output	299
2.1.15.50.5.3 Return Type	299
2.1.15.51.6 Example	300
2.1.15.52.7.1 Structured Text	300
2.1.15.53.8.2 Ladder Diagram	300
2.1.15.54.9.3 Function Block Diagram	300
2.1.16 Motion Library - Synchronizer	300
2.1.16.1 MLSyncInit	300
2.1.16.2.1 Description	300
2.1.16.3.2 Arguments	300
2.1.16.4.3.1 Input	300
2.1.16.5.4.2 Output	301
2.1.16.6.5 Related Functions	301
2.1.16.7.6 Example	301
2.1.16.8.7.1 Structured Text	301
2.1.16.9.8.2 Ladder Diagram	302
2.1.16.10.9.3 Function Block Diagram	302
2.1.16.11 MLSyncReadDeltaS	302
2.1.16.12.1 Description	302

2.1.16.13.2 Arguments	303
2.1.16.14.3.1 Input	303
2.1.16.15.4.2 Output	303
2.1.16.16.5 Related Functions	303
2.1.16.17.6 Example	303
2.1.16.18.7.1 Structured Text	303
2.1.16.19.8.2 Ladder Diagram	303
2.1.16.20.9.3 Function Block Diagram	304
2.1.16.21 MLSyncStart	304
2.1.16.22.1 Description	304
2.1.16.23.2 Arguments	304
2.1.16.24.3.1 Input	304
2.1.16.25.4.2 Output	304
2.1.16.26.5 Example	305
2.1.16.27.6.1 Structured Text	305
2.1.16.28.7.2 Ladder Diagram	305
2.1.16.29.8.3 Function Block Diagram	305
2.1.16.30 MLSyncStop	305
2.1.16.31.1 Description	305
2.1.16.32.2 Arguments	305
2.1.16.33.3.1 Input	305
2.1.16.34.4.2 Output	306
2.1.16.35.5 Example	306
2.1.16.36.6.1 Structured Text	306
2.1.16.37.7.2 Ladder Diagram	306
2.1.16.38.8.3 Function Block Diagram	306
2.1.16.39 MLSyncWriteDeltaS	306
2.1.16.40.1 Description	306
2.1.16.41.2 Arguments	307
2.1.16.42.3.1 Input	307
2.1.16.43.4.2 Output	308
2.1.16.44.5 Example	308
2.1.16.45.6.1 Structured Text	308
2.1.16.46.7.2 Ladder Diagram	308
2.1.16.47.8.3 Function Block Diagram	308
2.1.16.48 Usage example of Synchronizer Functions	308
2.1.17 Motion Library - Trigger	309
2.1.17.1 MLTrigClearFlag	310
2.1.17.2.1 Description	310
2.1.17.3.2 Arguments	310

2.1.17.4.3.1 Input	310
2.1.17.5.4.2 Output	310
2.1.17.6.5.3 Return Type	310
2.1.17.7.6 Related Functions	310
2.1.17.8 See Also	310
2.1.17.9.1 Example	311
2.1.17.10.2.1 Structured Text	311
2.1.17.11.3.2 Ladder Diagram	311
2.1.17.12.4.3 Function Block Diagram	311
2.1.17.13 MLTrigInit	311
2.1.17.14.1 Description	311
2.1.17.15.2 Arguments	311
2.1.17.16.3.1 Input	311
2.1.17.17.4.2 Output	312
2.1.17.18.5.3 Return Type	312
2.1.17.19.6 Related Functions	312
2.1.17.20 See Also	313
2.1.17.21.1 Example	313
2.1.17.22.2.1 Structured Text	313
2.1.17.23.3.2 Ladder Diagram	313
2.1.17.24.4.3 Function Block Diagram	313
2.1.17.25 MLTrigsTriggered	313
2.1.17.26.1 Description	313
2.1.17.27.2 Arguments	314
2.1.17.28.3.1 Input	314
2.1.17.29.4.2 Output	314
2.1.17.30.5.3 Return Type	314
2.1.17.31.6 Related Functions	314
2.1.17.32 See Also	315
2.1.17.33.1 Example	315
2.1.17.34.2.1 Ladder Diagram	315
2.1.17.35.3.2 Function Block Diagram	315
2.1.17.36 MLTrigReadDelay	315
2.1.17.37.1 Description	315
2.1.17.38.2.1 Input	315
2.1.17.39.3.2 Output	316
2.1.17.40.4 Related Functions	316
2.1.17.41 See Also	316
2.1.17.42 MLTrigReadPos	316

2.1.17.43.1 Description	316
2.1.17.44.2 Arguments	317
2.1.17.45.3.1 Input	317
2.1.17.46.4.2 Output	317
2.1.17.47.5 Related Functions	317
2.1.17.48 See Also	317
2.1.17.49.1 Previous Function Name	318
2.1.17.50.2 Example	318
2.1.17.51.3.1 Structured Text	318
2.1.17.52.4.2 Ladder Diagram	318
2.1.17.53.5.3 Function Block Diagram	318
2.1.17.54 MLTrigReadTime	318
2.1.17.55.1 Description	318
2.1.17.56.2 Arguments	319
2.1.17.57.3.1 Input	319
2.1.17.58.4.2 Output	319
2.1.17.59.5 Related Functions	319
2.1.17.60 See Also	319
2.1.17.61.1 Previous Function Name	320
2.1.17.62.2 Example	320
2.1.17.63.3.1 Ladder Diagram	320
2.1.17.64.4.2 Function Block Diagram	320
2.1.17.65 MLTrigSetEdge	320
2.1.17.66.1 Description	320
2.1.17.67.2 Arguments	320
2.1.17.68.3.1 Input	320
2.1.17.69.4.2 Output	321
2.1.17.70.5.3 Return Type	321
2.1.17.71 See Also	321
2.1.17.72.1 Examples	321
2.1.17.73.2.1 Function Block Diagram	321
2.1.17.74.3.2 Ladder Diagram	321
2.1.17.75.4.3 Structured Text	321
2.1.17.76 MLTrigWriteDelay	321
2.1.17.77.1 Description	322
2.1.17.78.2.1 Input	322
2.1.17.79.3.2 Output	322
2.1.17.80.4.3 Return Type	322
2.1.17.81.5 Related Functions	322

2.1.17.82 See Also	322
2.1.17.83 Usage example of Trigger Functions	322
2.2 Motion Library / PLCopen	324
2.2.1 Control Functions	325
2.2.1.1 MC_ClearFaults	325
2.2.1.2.1 Description	325
2.2.1.3.2 Arguments	326
2.2.1.4.3.1 Input	326
2.2.1.5.4.2 Output	326
2.2.1.6.5 Usage	326
2.2.1.7.6 Related Functions	326
2.2.1.8.7 Example	326
2.2.1.9.8.1 Structured Text	326
2.2.1.10.9.2 Function Block Diagram	327
2.2.1.11.10.3 Ladder Diagram	327
2.2.1.12 MC_CreateAxis	327
2.2.1.13.1 Description	327
2.2.1.14.2 Arguments	327
2.2.1.15.3.1 Input	327
2.2.1.16.4.2 Output	329
2.2.1.17.5 Example	329
2.2.1.18.6.1 Structured Text	329
2.2.1.19.7.2 Function Block Diagram	330
2.2.1.20.8.3 Ladder Diagram	330
2.2.1.21 MC_EStop	330
2.2.1.22.1 Description	330
2.2.1.23.2 Arguments	330
2.2.1.24.3.1 Input	331
2.2.1.25.4.2 Output	331
2.2.1.26.5 Usage	331
2.2.1.27.6 Related Functions	331
2.2.1.28.7 Example	331
2.2.1.29.8.1 Structured Text	331
2.2.1.30.9.2 Function Block Diagram	331
2.2.1.31.10.3 Ladder Diagram	332
2.2.1.32 MC_InitAxis	332
2.2.1.33.1 Description	332
2.2.1.34.2 Arguments	332
2.2.1.35.3.1 Input	332
2.2.1.36.4.2 Output	334

2.2.1.37.5 Example	334
2.2.1.38.6.1 Structured Text	334
2.2.1.39.7.2 Function Block Diagram	334
2.2.1.40.8.3 Ladder Diagram	334
2.2.1.41 MC_Power	335
2.2.1.42.1 Description	335
2.2.1.43.2 Arguments	335
2.2.1.44.3.1 Input	335
2.2.1.45.4.2 Output	336
2.2.1.46.5 Example	337
2.2.1.47.6.1 Structured Text	337
2.2.1.48.7.2 Ladder Diagram	337
2.2.1.49 MC_ErrorDescription	337
2.2.1.50.1 Arguments	337
2.2.1.51.2.1 Inputs	337
2.2.1.52.3.2 Outputs	338
2.2.1.53.4 Examples	338
2.2.1.54.5.1 Structured Text	338
2.2.1.55.6.2 IL	338
2.2.1.56.7.3 Function Block	338
2.2.1.57.8.4 Ladder Diagram	339
2.2.1.58 MC_ResetError	339
2.2.1.59.1 Description	339
2.2.1.60.2 Arguments	339
2.2.1.61.3.1 Input	339
2.2.1.62.4.2 Output	339
2.2.1.63.5 Example	340
2.2.1.64.6.1 Structured Text	340
2.2.1.65.7.2 Ladder Diagram	340
2.2.1.66 MC_Stop	340
2.2.1.67.1 Description	340
2.2.1.68.2 Time Diagram	340
2.2.1.69.3 Arguments	341
2.2.1.70.4.1 Input	341
2.2.1.71.5.2 Output	342
2.2.1.72.6 Example	342
2.2.1.73.7.1 Structured Text	342
2.2.1.74.8.2 Ladder Diagram	342
2.2.2 I/O Functions	343

2.2.2.1 MC_AbortTrigger	343
2.2.2.2.1 Description	343
2.2.2.3.2 Arguments	343
2.2.2.4.3.1 Input	343
2.2.2.5.4.2 Output	344
2.2.2.6.5 Usage	344
2.2.2.7.6 Related Functions	344
2.2.2.8.7 Example	345
2.2.2.9.8.1 Structured Text	345
2.2.2.10.9.2 Ladder Diagram	345
2.2.2.11 MC_TouchProbe	345
2.2.2.12.1 Description	345
2.2.2.13.2 Arguments	346
2.2.2.14.3.1 Input	347
2.2.2.15.4.2 Output	348
2.2.2.16.5 Usage	349
2.2.2.17.6 Limitations	349
2.2.2.18.7 Related Functions	349
2.2.2.19.8 See Also	349
2.2.2.20.9 Example	349
2.2.2.21.10.1 Structured Text	349
2.2.2.22.11.2 Ladder Diagram	350
2.2.3 Information Functions	350
2.2.3.1 MC_ReadActPos	350
2.2.3.2.1 Description	350
2.2.3.3.2 Arguments	350
2.2.3.4.3.1 Input	350
2.2.3.5.4.2 Output	351
2.2.3.6.5 Example	351
2.2.3.7.6.1 Structured Text	351
2.2.3.8.7.2 Ladder Diagram	352
2.2.3.9 MC_ReadActVel	352
2.2.3.10.1 Description	352
2.2.3.11.2 Arguments	352
2.2.3.12.3.1 Input	352
2.2.3.13.4.2 Output	352
2.2.3.14.5 Example	353
2.2.3.15.6.1 Structured Text	353
2.2.3.16.7.2 Ladder Diagram	353

2.2.3.17 MC_ReadAxisErr	353
2.2.3.18.1 Description	353
2.2.3.19.2 Arguments	353
2.2.3.20.3.1 Input	353
2.2.3.21.4.2 Output	354
2.2.3.22.5 Example	355
2.2.3.23.6.1 Structured Text	355
2.2.3.24.7.2 Ladder Diagram	355
2.2.3.25 MC_ReadBoolPar	355
2.2.3.26.1 Description	355
2.2.3.27.2 Arguments	355
2.2.3.28.3.1 Input	355
2.2.3.29.4.2 Output	356
2.2.3.30.5 Example	356
2.2.3.31.6.1 Structured Text	356
2.2.3.32.7.2 Ladder Diagram	356
2.2.3.33 MC_ReadParam	357
2.2.3.34.1 Description	357
2.2.3.35.2 Arguments	357
2.2.3.36.3.1 Input	357
2.2.3.37.4.2 Output	357
2.2.3.38.5 Example	358
2.2.3.39.6.1 Structured Text	358
2.2.3.40.7.2 Ladder Diagram	358
2.2.3.41 MC_ReadStatus	358
2.2.3.42.1 Description	358
2.2.3.43.2 Arguments	359
2.2.3.44.3.1 Input	359
2.2.3.45.4.2 Output	359
2.2.3.46.5 Example	360
2.2.3.47.6.1 Structured Text	360
2.2.3.48.7.2 Ladder Diagram	360
2.2.3.49 MC_WriteBoolPar	361
2.2.3.50.1 Description	361
2.2.3.51.2 Arguments	361
2.2.3.52.3.1 Input	361
2.2.3.53.4.2 Output	362
2.2.3.54.5 Example	362
2.2.3.55.6.1 Structured Text	362

2.2.3.56.7.2 Ladder Diagram	362
2.2.3.57 MC_WriteParam	363
2.2.3.58.1 Description	363
2.2.3.59.2 Arguments	363
2.2.3.60.3.1 Input	363
2.2.3.61.4.2 Output	364
2.2.3.62.5 Example	364
2.2.3.63.6.1 Structured Text	364
2.2.3.64.7.2 Ladder Diagram	364
2.2.4 PLCOpenMotion Functions	364
2.2.4.1 MC_Halt	364
2.2.4.2.1 Description	364
2.2.4.3.2 Time Diagram	365
2.2.4.4.3 Arguments	365
2.2.4.5.4.1 Input	365
2.2.4.6.5.2 Output	366
2.2.4.7.6 Example	367
2.2.4.8.7.1 Structured Text	367
2.2.4.9.8.2 Ladder Diagram	367
2.2.4.10 MC_MoveAbsolute	368
2.2.4.11.1 Description	368
2.2.4.12.2 Time Diagram	368
2.2.4.13.3 Arguments	369
2.2.4.14.4.1 Input	369
2.2.4.15.5.2 Output	372
2.2.4.16.6 Example	372
2.2.4.17.7.1 Structured Text	372
2.2.4.18.8.2 Ladder Diagram	372
2.2.4.19 MC_MoveAdditive	373
2.2.4.20.1 Description	373
2.2.4.21.2 Time Diagram	373
2.2.4.22.3 Arguments	374
2.2.4.23.4.1 Input	374
2.2.4.24.5.2 Output	375
2.2.4.25.6 Example	376
2.2.4.26.7.1 Structured Text	376
2.2.4.27.8.2 Ladder Diagram	376
2.2.4.28 MC_MoveRelative	376
2.2.4.29.1 Description	376

2.2.4.30.2	Time Diagram	377
2.2.4.31.3	Arguments	378
2.2.4.32.4.1	Input	378
2.2.4.33.5.2	Output	380
2.2.4.34.6	Example	380
2.2.4.35.7.1	Structured Text	380
2.2.4.36.8.2	Ladder Diagram	381
2.2.4.37	MC_MoveSuperimp	381
2.2.4.38.1	Description	381
2.2.4.39.2	Time Diagram	381
2.2.4.40.3	Arguments	382
2.2.4.41.4.1	Input	382
2.2.4.42.5.2	Output	384
2.2.4.43.6	Example	384
2.2.4.44.7.1	Structured Text	384
2.2.4.45.8.2	Ladder Diagram	384
2.2.4.46	MC_MoveVelocity	385
2.2.4.47.1	Description	385
2.2.4.48.2	Time Diagram	385
2.2.4.49.3	Arguments	386
2.2.4.50.4.1	Input	386
2.2.4.51.5.2	Output	387
2.2.4.52.6	Example	388
2.2.4.53.7.1	Structured Text	388
2.2.4.54.8.2	Ladder Diagram	388
2.2.4.55	MC_SetOverride	388
2.2.4.56.1	Description	388
2.2.4.57.2	Arguments	389
2.2.4.58.3.1	Input	389
2.2.4.59.4.2	Output	389
2.2.4.60.5	Example	390
2.2.4.61.6.1	Structured Text	390
2.2.4.62.7.2	Ladder Diagram	390
2.2.5	Profile Functions	390
2.2.5.1	MC_CamIn	390
2.2.5.2.1	Description	390
2.2.5.3.2	Arguments	391
2.2.5.4.3.1	Input	391
2.2.5.5.4.2	Output	393

2.2.5.6.5 Usage	394
2.2.5.7.6 Related Functions	394
2.2.5.8.7 Examples	394
2.2.5.9.8.1 Structured Text	394
2.2.5.10.9.2 Ladder Diagram	394
2.2.5.11.10.3 Example 1	395
2.2.5.12.11.4 Example 2	396
2.2.5.13.12.5 Example 3	396
2.2.5.14 MC_CamOut	397
2.2.5.15.1 Description	397
2.2.5.16.2 Arguments	397
2.2.5.17.3.1 Input	397
2.2.5.18.4.2 Output	398
2.2.5.19.5 Usage	399
2.2.5.20.6 Related Functions	399
2.2.5.21.7 Example	399
2.2.5.22.8.1 Structured Text	399
2.2.5.23.9.2 Ladder Diagram	400
2.2.5.24 MC_CamResumePos	400
2.2.5.25.1 Description	400
2.2.5.26.2 Related Functions	400
2.2.5.27.3 Arguments	400
2.2.5.28.4.1 Inputs	400
2.2.5.29.5.2 Outputs	401
2.2.5.30.6 Examples	402
2.2.5.31.7.1 ST	402
2.2.5.32.8.2 IL	402
2.2.5.33.9.3 FBD	402
2.2.5.34.10.4 FFLD	402
2.2.5.35 MC_CamStartPos	402
2.2.5.36.1 Description	403
2.2.5.37.2 Arguments	403
2.2.5.38.3.1 Inputs	403
2.2.5.39.4.2 Outputs	404
2.2.5.40.5 Examples	405
2.2.5.41.6.1 ST	405
2.2.5.42.7.2 IL	405
2.2.5.43.8.3 FBD	405
2.2.5.44.9.4 FFLD	405

2.2.5.45 MC_CamTblSelect	406
2.2.5.46.1 Description	406
2.2.5.47.2 Arguments	406
2.2.5.48.3.1 Input	406
2.2.5.49.4.2 Output	407
2.2.5.50.5 Usage	408
2.2.5.51.6 Related Functions	408
2.2.5.52.7 Example	408
2.2.5.53.8.1 Structured Text	408
2.2.5.54.9.2 Ladder Diagram	408
2.2.5.55 MC_GearIn	409
2.2.5.56.1 Description	409
2.2.5.57.2 Time Diagram	410
2.2.5.58.3 Arguments	410
2.2.5.59.4.1 Input	410
2.2.5.60.5.2 Output	412
2.2.5.61.6 Example	412
2.2.5.62.7.1 Structured Text	412
2.2.5.63.8.2 Ladder Diagram	412
2.2.5.64 MC_GearInPos	413
2.2.5.65.1 Description	413
2.2.5.66.2 Time Diagram	414
2.2.5.67.3 Arguments	414
2.2.5.68.4.1 Input	414
2.2.5.69.5.2 Output	417
2.2.5.70.6 Example	418
2.2.5.71.7.1 Example Description	418
2.2.5.72.8.2 Structured Text	418
2.2.5.73.9.3 Ladder Diagram	419
2.2.5.74 MC_GearOut	419
2.2.5.75.1 Description	419
2.2.5.76.2 Arguments	420
2.2.5.77.3.1 Input	420
2.2.5.78.4.2 Output	421
2.2.5.79.5 Example	421
2.2.5.80.6.1 Structured Text	421
2.2.5.81.7.2 Ladder Diagram	421
2.2.5.82 MC_Phasing	422
2.2.5.83.1 Description	422

2.2.5.84.2 Arguments	422
2.2.5.85.3.1 Input	422
2.2.5.86.4.2 Output	424
2.2.5.87.5 Example	424
2.2.5.88.6.1 Structured Text	424
2.2.5.89.7.2 Ladder Diagram	425
2.2.5.90 MC_SyncSlaves	425
2.2.5.91.1 Description	425
2.2.5.92.2 Arguments	425
2.2.5.93.3.1 Input	425
2.2.5.94.4.2 Output	426
2.2.5.95.5 Usage	426
2.2.5.96.6 Related Functions	426
2.2.5.97.7 Example	427
2.2.5.98.8.1 Structured Text	427
2.2.5.99.9.2 Ladder Diagram	427
2.2.6 Reference Functions	427
2.2.6.1 MC_Reference	427
2.2.6.2.1 Description	427
2.2.6.3.2 Arguments	428
2.2.6.4.3.1 Input	428
2.2.6.5.4.2 Output	430
2.2.6.6.5 Usage	431
2.2.6.7.6 Related Functions	432
2.2.6.8.7 Example	432
2.2.6.9.8.1 Structured Text	432
2.2.6.10.9.2 Ladder Diagram	432
2.2.6.11 MC_SetPos	432
2.2.6.12.1 Description	432
2.2.6.13.2 Arguments	433
2.2.6.14.3.1 Inputs	433
2.2.6.15.4.2 Outputs	434
2.2.6.16.5 Example	434
2.2.6.17.6.1 Structured Text	434
2.2.6.18.7.2 Ladder Diagram	434
2.2.6.19 MC_SetPosition	435
2.2.6.20.1 Description	435
2.2.7 Registration Function Blocks	435
2.2.7.1 MC_MachRegist	435
2.2.7.2 Description	435

2.2.7.3.1 Arguments	436
2.2.7.4.2.1 Input	436
2.2.7.5.3.2 Outputs	440
2.2.7.6.4 Related Functions	440
2.2.7.7.5 Examples	441
2.2.7.8.6.1 Function Block	441
2.2.7.9.7.2 Instruction List	441
2.2.7.10.8.3 Ladder Diagram	441
2.2.7.11.9.4 Structured Text	441
2.2.7.12 MC_MarkRegist	441
2.2.7.13.1 Description	441
2.2.7.14.2 Arguments	443
2.2.7.15.3.1 Input	443
2.2.7.16.4.2 Outputs	446
2.2.7.17.5 Related Functions	446
2.2.7.18.6 Examples	446
2.2.7.19.7.1 Function Block	446
2.2.7.20.8.2 Instruction List	447
2.2.7.21.9.3 Ladder Diagram	447
2.2.7.22.10.4 Structured Text	447
2.2.7.23 MC_StopRegist	447
2.2.7.24.1 Description	447
2.2.7.25.2 Arguments	447
2.2.7.26.3.1 Input	447
2.2.7.27.4.2 Outputs	448
2.2.7.28.5 Related Functions	448
2.2.7.29.6 Examples	448
2.2.7.30.7.1 Function Block	448
2.2.7.31.8.2 Ladder Diagram	449
2.2.7.32.9.3 Structured Text	449
2.2.8 Superimposed Axes	449
2.2.8.1 MC_AddSuperAxis	449
2.2.8.2.1 Inputs	449
2.2.8.3.2 Outputs	450
2.2.8.4.3 Examples	450
2.2.8.5.4.1 Structured Text	450
2.2.8.6.5.2 Function Block Diagram	450
2.2.8.7.6.3 Ladder Diagram	450
2.2.8.8.7 Related Functions	450

2.2.8.9 MC_RemSuperAxis	451
2.2.8.10.1 Inputs	451
2.2.8.11.2 Outputs	451
2.2.8.12.3 Examples	451
2.2.8.13.4.1 Structured Text	451
2.2.8.14.5.2 Function Block Diagram	452
2.2.8.15.6.3 Ladder Diagram	452
2.2.8.16.7 Related Functions	452
2.3 MotionLibrary- Common	452
2.3.1 Motion Library - Common - Info	453
2.3.1.1 MC_ErrorDescription	453
2.3.1.2.1 Arguments	453
2.3.1.3.2.1 Inputs	453
2.3.1.4.3.2 Outputs	454
2.3.1.5.4 Examples	454
2.3.1.6.5.1 Structured Text	454
2.3.1.7.6.2 IL	454
2.3.1.8.7.3 Function Block	454
2.3.1.9.8.4 Ladder Diagram	454
2.3.2 Motion Library - Common - Profiles	454
2.3.2.1 MLProfileBuild	455
2.3.2.2.1 Description	455
2.3.2.3.2.1 CamProps_Ref Structure	455
2.3.2.4.3.2 CamData_Ref Structure	455
2.3.2.5.4 Arguments	456
2.3.2.6.5.1 Input	456
2.3.2.7.6.2 Output	458
2.3.2.8.7 Error Codes	459
2.3.2.9.8 Related Functions	460
2.3.2.10.9 Example of How to Use MLProfileBuild	460
2.3.2.11.10 Example of Building a Parabolic Cam Profile	462
2.3.2.12.11 Code Examples	462
2.3.2.13 MLProfileCreate	463
2.3.2.14.1 Description	463
2.3.2.15.2 Arguments	464
2.3.2.16.3.1 Input	464
2.3.2.17.4.2 Output	464
2.3.2.18.5 Related Functions	464
2.3.2.19.6 Example	464
2.3.2.20.7.1 Structured Text	464

2.3.2.21.8.2 Ladder Diagram	464
2.3.2.22.9.3 Function Block Diagram	464
2.3.2.23 MLProfileInit	464
2.3.2.24.1 Description	464
2.3.2.25.2 Arguments	465
2.3.2.26.3.1 Input	465
2.3.2.27.4.2 Output	466
2.3.2.28.5.3 Return Type	466
2.3.2.29.6 Related Functions	466
2.3.2.30.7 Example	466
2.3.2.31.8.1 Structured Text	466
2.3.2.32.9.2 Ladder Diagram	467
2.3.2.33.10.3 Function Block Diagram	467
2.3.2.34 MLProfileRelease	467
2.3.2.35.1 Arguments	467
2.3.2.36.2.1 Input	468
2.3.2.37.3.2 Output	468
2.3.2.38.4 Error Codes	468
2.3.2.39.5 Related Functions	469
2.3.2.40.6 Example	469
2.3.2.41.7.1 Structured Text	469
2.3.2.42.8.2 Ladder Diagram	469
2.3.2.43.9.3 Function Block Diagram	469
2.3.3 Motion Library	469
2.3.3.1 State Machine	470
2.3.3.2 MLMotionCycleTime	470
2.3.3.3.1 Arguments	470
2.3.3.4.2.1 Input	470
2.3.3.5.3.2 Output	470
2.3.3.6.4 Example	471
2.3.3.7.5.1 Structured Text	471
2.3.3.8.6.2 Ladder Diagram	471
2.3.3.9.7.3 Function Block Diagram	471
2.3.3.10 MLMotionInit	471
2.3.3.11.1 Description	471
2.3.3.12.2 Parameter	471
2.3.3.13.3 Return Type	471
2.3.3.14.4 Example	471
2.3.3.15.5.1 ST	471
2.3.3.16.6.2 FBD	472

2.3.3.17.7.3 FFLD	472
2.3.3.18 MLMotionRstErr	473
2.3.3.19.1 Description	473
2.3.3.20.2 Return Type	473
2.3.3.21.3 Example	473
2.3.3.22.4.1 ST	473
2.3.3.23.5.2 FBD	474
2.3.3.24.6.3 FFLD	474
2.3.3.25 MLMotionStart	474
2.3.3.26.1 Description	474
2.3.3.27.2 Return Type	474
2.3.3.28.3 Example	474
2.3.3.29.4.1 ST	474
2.3.3.30.5.2 FBD	475
2.3.3.31.6.3 FFLD	475
2.3.3.32 MLMotionStatus	475
2.3.3.33.1 Description	475
2.3.3.34.2 Parameter	476
2.3.3.35.3 Return Type	476
2.3.3.36.4 Example	476
2.3.3.37.5.1 ST	476
2.3.3.38.6.2 FBD	476
2.3.3.39.7.3 FFLD	476
2.3.3.40 MLMotionStop	477
2.3.3.41.1 Description	477
2.3.3.42.2 Return Type	477
2.3.3.43.3 Example	477
2.3.3.44.4.1 ST	477
2.3.3.45.5.2 FBD	477
2.3.3.46.6.3 FFLD	477
2.3.3.47 MLMotionSysTime	478
2.3.3.48.1 Description	478
2.3.3.49.2 Return Type	478
2.3.3.50.3 Units	478
2.3.3.51.4 Example	478
2.3.3.52.5.1 ST	478
2.3.3.53.6.2 FBD	478
2.3.3.54.7.3 FFLD	478
2.3.4 Coordinated Motion Function Blocks	478

2.3.4.1 Coordinated Motion Group Control Library	480
2.3.4.2.1 MC_AddAxisToGrp	481
2.3.4.3.2.1 Description	481
2.3.5 Related Functions	481
2.3.5.1.1.1 Arguments	482
2.3.6 Input	482
2.3.7 Output	483
2.3.7.1.1.1 Example	483
2.3.8 Structured Text	483
2.3.9 IL	483
2.3.10 FBD	483
2.3.11 Ladder Diagram	483
2.3.11.1.1 MC_CreateAxesGrp	483
2.3.11.2.2.1 Description	483
2.3.12 Related Function Blocks	484
2.3.12.1.1.1 Arguments	484
2.3.12.2.2.2 Input	484
2.3.12.3.3.3 Output	485
2.3.12.4.4.4 Example	486
2.3.13 Structured Text	486
2.3.14 Instruction List	486
2.3.15 Function Block Diagram	486
2.3.16 Ladder Diagram	486
2.3.16.1.1 MC_GrpDisable	486
2.3.16.2.2.1 Description	486
2.3.17 Related Functions	487
2.3.17.1.1.1 Arguments	487
2.3.18 Input	487
2.3.19 Output	487
2.3.19.1.1.1 Example	488
2.3.20 ST	488
2.3.21 IL	488
2.3.22 FBD	488
2.3.23 FFLD	488
2.3.23.1.1 MC_GrpEnable	488
2.3.23.2.2.1 Description	488
2.3.24 Related Functions	489
2.3.24.1.1.1 Arguments	489
2.3.25 Input	489
2.3.26 Output	489
2.3.26.1.1.1 Example	489

2.3.27 Structured Text	489
2.3.28 IL	489
2.3.29 FBD	490
2.3.30 FFLD	490
2.3.30.1.1 MC_GrpReadBoolPar	490
2.3.30.2.2.1 Description	490
2.3.31 Related Function Blocks	490
2.3.31.1.1.1 Arguments	490
2.3.32 Input	491
2.3.33 Output	491
2.3.33.1.1.1 Example	492
2.3.34 ST	492
2.3.35 IL	492
2.3.36 FBD	492
2.3.37 FFLD	492
2.3.37.1.1 MC_GrpReset	492
2.3.37.2.2.1 Description	492
2.3.38 Related Functions	493
2.3.38.1.1.1 Arguments	493
2.3.39 Input	493
2.3.40 Output	493
2.3.40.1.1.1 Example	494
2.3.41 ST	494
2.3.42 FBD	494
2.3.43 IL	494
2.3.44 FFLD	494
2.3.44.1.1 MC_GrpStop	494
2.3.44.2.2.1 Description	494
2.3.45 Related Functions	495
2.3.45.1.1.1 Arguments	495
2.3.46 Input	495
2.3.47 Output	496
2.3.47.1.1.1 Example	496
2.3.48 Structured Text	496
2.3.49 IL	496
2.3.50 FBD	496
2.3.51 FFLD	497
2.3.51.1.1 MC_GrpWriteBoolPar	497
2.3.51.2.2.1 Description	497
2.3.52 Related Function Blocks	497
2.3.52.1.1.1 Arguments	497
2.3.53 Input	497

2.3.54 Output	498
2.3.54.1.1.1 Example	499
2.3.55 ST	499
2.3.56 IL	499
2.3.57 FBD	499
2.3.58 FFLD	499
2.3.58.1.1 MC_InitAxesGrp	499
2.3.58.2.2.1 Description	499
2.3.59 Related Function Blocks	500
2.3.59.1.1.1 Arguments	500
2.3.60 Inputs	500
2.3.61 Outputs	501
2.3.61.1.1.1 Example	501
2.3.62 Structured Text	501
2.3.63 IL	502
2.3.64 FBD	502
2.3.65 FFLD	502
2.3.65.1.1 MC_RemAxisFromGrp	502
2.3.65.2.2.1 Description	502
2.3.66 Related Functions	502
2.3.66.1.1.1 Arguments	503
2.3.67 Input	503
2.3.68 Output	503
2.3.68.1.1.1 Example	503
2.3.69 ST	504
2.3.70 IL	504
2.3.71 FBD	504
2.3.72 FFLD	504
2.3.72.1.1 MC_UngroupAllAxes	504
2.3.72.2.2.1 Description	504
2.3.73 Related Functions	504
2.3.73.1.1.1 Arguments	505
2.3.74 Input	505
2.3.75 Output	505
2.3.75.1.1.1 Examples	505
2.3.76 ST	505
2.3.77 IL	505
2.3.78 FBD	506
2.3.79 FFLD	506
2.3.79.1 Coordinated Motion Info Library	506
2.3.79.2.1 MC_GrpReadActAcc	506
2.3.79.3.2.1 Description	506

2.3.80 Related Functions	507
2.3.80.1.1.1 Arguments	507
2.3.81 Input	507
2.3.82 Output	508
2.3.82.1.1.1 Example	508
2.3.83 Structured Text	508
2.3.84 IL	508
2.3.85 FBD	509
2.3.86 Ladder Diagram	509
2.3.86.1.1 MC_GrpReadActPos	509
2.3.86.2.2.1 Description	509
2.3.87 Related Functions	509
2.3.87.1.1.1 Arguments	510
2.3.88 Input	510
2.3.89 Output	510
2.3.89.1.1.1 Example	511
2.3.90 Structured Text	511
2.3.91 IL	511
2.3.92 FBD	511
2.3.93 Ladder Diagram	511
2.3.93.1.1 MC_GrpReadActVel	511
2.3.93.2.2.1 Description	511
2.3.94 Related Functions	512
2.3.94.1.1.1 Arguments	512
2.3.95 Input	512
2.3.96 Output	513
2.3.96.1.1.1 Example	513
2.3.97 Structured Text	513
2.3.98 IL	514
2.3.99 FBD	514
2.3.100 FFLD	514
2.3.100.1.1 MC_GrpReadCmdPos	514
2.3.100.2.2.1 Description	514
2.3.101 Related Function Blocks	515
2.3.101.1.1.1 Arguments	515
2.3.102 Input	515
2.3.103 Output	516
2.3.103.1.1.1 Example	516
2.3.104 Structured Text	516
2.3.105 IL	516
2.3.106 FBD	516
2.3.107 FFLD	517

2.3.107.1.1 MC_GrpReadCmdVel	517
2.3.107.2.2.1 Description	517
2.3.108 Related Function Blocks	517
2.3.108.1.1.1 Arguments	517
2.3.109 Input	517
2.3.110 Output	518
2.3.110.1.1.1 Example	519
2.3.111 Structured Text	519
2.3.112 IL	519
2.3.113 FBD	519
2.3.114 FFLD	519
2.3.114.1.1 MC_GrpReadError	519
2.3.114.2.2.1 Description	519
2.3.115 Related Functions	520
2.3.115.1.1.1 Arguments	520
2.3.116 Input	520
2.3.117 Output	520
2.3.117.1.1.1 Examples	520
2.3.118 Structured Text	520
2.3.119 FBD	521
2.3.120 FFLD	521
2.3.120.1.1 MC_GrpReadStatus	521
2.3.120.2.2.1 Description	521
2.3.121 Related Functions	521
2.3.121.1.1.1 Arguments	521
2.3.121.2.2.2 Input	521
2.3.121.3.3.3 Output	522
2.3.121.4.4.4 Example	523
2.3.122 Structured Text	523
2.3.123 IL	524
2.3.124 FBD	524
2.3.125 FFLD	524
2.3.125.1 Coordinated Motion Motion Library	525
2.3.125.2.1 MC_AxisSetDefaults	525
2.3.125.3.2.1 Description	525
2.3.126 Related Functions	525
2.3.126.1.1.1 Arguments	526
2.3.127 Input	526
2.3.128 Output	527
2.3.128.1.1.1 Example	527
2.3.129 Structured Text	527
2.3.130 Instruction List	527

2.3.131 Function Block Diagram	528
2.3.132 Ladder Diagram	528
2.3.132.1.1 MC_GrpHalt	528
2.3.132.2.2.1 Description	528
2.3.133 Related Functions	528
2.3.133.1.1.1 Arguments	529
2.3.134 Input	529
2.3.135 Output	529
2.3.135.1.1.1 Example	530
2.3.136 Structured Text	530
2.3.137 IL	530
2.3.138 FBD	530
2.3.139 FFLD	530
2.3.139.1.1 MC_GrpSetOverride	531
2.3.139.2.2.1 Description	531
2.3.140 Related Functions	531
2.3.140.1.1.1 Arguments	531
2.3.141 Input	531
2.3.142 Output	532
2.3.142.1.1.1 Example	532
2.3.143 ST	532
2.3.144 IL	532
2.3.145 FBD	532
2.3.146 FFLD	533
2.3.146.1.1 MC_MoveCircAbs	533
2.3.146.2.2.1 Description	533
2.3.147 Related Functions	534
2.3.147.1.1.1 Arguments	534
2.3.148 Input	534
2.3.149 Output	538
2.3.149.1.1.1 Example	539
2.3.150 ST	539
2.3.151 IL	539
2.3.152 FBD	539
2.3.153 FFLD	539
2.3.153.1.1 MC_MoveCircRel	540
2.3.153.2.2.1 Description	540
2.3.154 Related Functions	541
2.3.154.1.1.1 Arguments	541
2.3.155 Input	541
2.3.156 Output	545
2.3.156.1.1.1 Example	546

2.3.157 ST	546
2.3.158 IL	546
2.3.159 FBD	546
2.3.160 FFLD	546
2.3.160.1.1 MC_MoveDirAbs	547
2.3.160.2.2.1 Description	547
2.3.161 Related Functions	547
2.3.161.1.1.1 Arguments	548
2.3.162 Input	548
2.3.163 Output	549
2.3.163.1.1.1 Example	549
2.3.164 Structure Text	549
2.3.165 IL	549
2.3.166 Function Block Diagram	549
2.3.167 Ladder Diagram	550
2.3.167.1.1 MC_MoveDirRel	550
2.3.167.2.2.1 Description	550
2.3.168 Related Functions	550
2.3.168.1.1.1 Arguments	550
2.3.169 Input	550
2.3.170 Output	552
2.3.170.1.1.1 Example	552
2.3.171 Structure Text	552
2.3.172 IL	552
2.3.173 Function Block Diagram	552
2.3.174 Ladder Diagram	553
2.3.174.1.1 MC_MoveLinAbs	553
2.3.174.2.2.1 Description	553
2.3.175 Related Functions	553
2.3.175.1.1.1 Arguments	553
2.3.176 Input	553
2.3.177 Output	557
2.3.177.1.1.1 Example	557
2.3.178 Structured Text	557
2.3.179 IL	557
2.3.180 FBD	558
2.3.181 FFLD	558
2.3.181.1.1 MC_MoveLinRel	558
2.3.181.2.2.1 Description	558
2.3.182 Related Functions	559
2.3.182.1.1.1 Arguments	559
2.3.183 Input	559

2.3.184 Output	562
2.3.184.1.1.1 Example	563
2.3.185 Structured Text	563
2.3.186 IL	563
2.3.187 FBD	563
2.3.188 FFLD	563
2.3.188.1 Coordinated Motion Reference Library	564
2.3.188.2.1 MC_GrpSetPos	564
2.3.188.3.2.1 Description	564
2.3.189 Related Functions	564
2.3.189.1.1.1 Arguments	564
2.3.190 Input	564
2.3.191 Output	566
2.3.191.1.1.1 Example	566
2.3.192 ST	566
2.3.193 FBD	566
2.3.194 IL	566
2.3.195 FFLD	567
3 Fieldbus Library	568
3.1 EtherCAT Library	569
3.1.1 EtherCAT Library - Drive	569
3.1.1.1.1 Execution Time	570
3.1.1.2.2.1 Reason	570
3.1.1.3.3.2 Result	570
3.1.1.4.4.3 Solution	570
3.1.1.5 DriveParamRead	570
3.1.1.6.1 Description	570
3.1.1.7.2 Arguments	571
3.1.1.8.3.1 Input	571
3.1.1.9.4.2 Output	572
3.1.1.10.5 Usage	574
3.1.1.11.6 Related Functions	574
3.1.1.12.7 Example	574
3.1.1.13.8.1 Structured Text	574
3.1.1.14.9.2 FBD	574
3.1.1.15.10.3 FFLD	574
3.1.1.16 DriveParamWrite	575
3.1.1.17.1 Description	575
3.1.1.18.2 Arguments	575
3.1.1.19.3.1 Input	575
3.1.1.20.4.2 Output	576

3.1.1.21.5 Usage	577
3.1.1.22.6 Related Functions	577
3.1.1.23.7 Example	577
3.1.1.24.8.1 Structured Text	577
3.1.1.25.9.2 FBD	577
3.1.1.26.10.3 FFLD	577
3.1.2 EtherCAT Library - SDO	577
3.1.2.1 ECATReadSDO	578
3.1.2.2.1 Description	578
3.1.2.3.2.1 State Diagram	578
3.1.2.4.3 Arguments	579
3.1.2.5.4.1 Input	579
3.1.2.6.5.2 Output	581
3.1.2.7.6 Related Functions	581
3.1.2.8.7 Example	582
3.1.2.9.8.1 Structured Text	582
3.1.2.10.9.2 FBD	582
3.1.2.11.10.3 FFLD	582
3.1.2.12 ECATWriteSDO	582
3.1.2.13.1 Description	582
3.1.2.14.2.1 State Diagram	583
3.1.2.15.3 Arguments	583
3.1.2.16.4.1 Input	583
3.1.2.17.5.2 Output	585
3.1.2.18.6 Related Functions	586
3.1.2.19.7 Example	586
3.1.2.20.8.1 Structured Text	586
3.1.2.21.9.2 FBD	586
3.1.2.22.10.3 FFLD	586
3.1.3 EtherCAT Library - Debug	586
3.1.3.1 ECATReadData	586
3.1.3.2.1 Description	586
3.1.3.3.2 Arguments	587
3.1.3.4.3.1 Input	587
3.1.3.5.4.2 Output	587
3.1.3.6.5 Related Functions	587
3.1.3.7.6 Example	588
3.1.3.8.7.1 Structured Text	588
3.1.3.9.8.2 FBD	588
3.1.3.10.9.3 FFLD	588

3.1.3.11 ECATWriteData	588
3.1.3.12.1 Description	588
3.1.3.13.2 Arguments	588
3.1.3.14.3.1 Input	588
3.1.3.15.4.2 Output	589
3.1.3.16.5 Related Functions	589
3.1.3.17.6 Example	589
3.1.3.18.7.1 Structured Text	589
3.1.3.19.8.2 FBD	589
3.1.3.20.9.3 FFLD	590
3.1.3.21 ECATGetObjVal	590
3.1.4 EtherCAT Library - Status	590
3.1.4.1 ECATGetStatus	590
3.1.4.2.1 Description	590
3.1.4.3.2 Arguments	590
3.1.4.4.3.1 Input	590
3.1.4.5.4.2 Output	590
3.1.4.6.5 Related Functions	590
3.1.4.7.6 Example	591
3.1.4.8.7.1 Structured Text	591
3.1.4.9.8.2 FBD	591
3.1.4.10.9.3 FFLD	591
3.1.4.11 ECATSetControl	591
3.1.4.12.1 Description	591
3.1.4.13.2 Arguments	591
3.1.4.14.3.1 Input	591
3.1.4.15.4.2 Output	592
3.1.4.16.5 Related Functions	592
3.2 Profibus Library	592
4 System Library	594
4.1 PrintMessage	595
4.1.1 Description	595
4.1.1.1 About the Source	595
4.1.1.2 About the Level	595
4.1.2 Arguments	595
4.1.2.1 Input	595
4.1.2.2 Output	596
4.1.3 Usage	596
4.1.4 Example	596
4.1.4.1 Structured Text	596
4.1.4.2 Function Block Diagram	596
4.1.4.3 FFLD	597

4.2 GetCtrlErrors	597
4.2.1 Arguments	597
4.2.1.1 Input	597
4.2.1.2 Output	597
4.2.2 Examples	598
4.2.2.1 FBD	598
4.2.2.2 FFLD	598
4.2.2.3 ST	598
4.3 ClearCtrlErrors	598
4.3.1 Arguments	599
4.3.2 Input	599
4.3.3 Output	599
4.3.4 Examples	599
4.3.4.1 FBD	599
4.3.4.2 FFLD	599
4.3.4.3 ST	599
4.4 GetCtrlInfo	599
4.4.1 Arguments	599
4.4.1.1 Input	600
4.4.1.2 Output	600
4.4.2 Examples	601
4.4.2.1 Structured Text	601
4.4.2.2 Ladder Diagram	601
4.5 GetCtrlPerf	601
4.5.1 Description	601
4.5.2 Arguments	602
4.5.2.1 Input	602
4.5.2.2 Output	602
4.5.3 Example	604
4.5.3.1 FBD	604
4.5.3.2 FFLD	604
4.5.3.3 Structured Text	605
5 Kollmorgen UDFBs	606
5.1 How to create an instance	609
5.2 Working with Kollmorgen UDFBs	610
5.2.1 FB_FirstOrderDigitalFilter	611
5.2.1.1 Description	611
5.2.1.2 Arguments	612
5.2.1.3.1 Inputs	612
5.2.1.4.2 Outputs	612
5.2.1.5 Usage	613
5.2.1.6 Example	616
5.2.1.7.1 Structured Text	616
5.2.1.8.2 Ladder Diagram	616
5.2.1.9.3 Function Block Diagram	617
5.2.2 FB_PWDutyOutput	617

5.2.2.1	Description	617
5.2.2.2	Arguments	617
5.2.2.3.1	Input	617
5.2.2.4.2	Output	618
5.2.2.5	Usage	618
5.2.2.6	Related Functions	618
5.2.2.7	Example	618
5.2.2.8.1	Structured Text	618
5.2.2.9.2	Ladder Diagram	619
5.2.2.10.3	Function Block Diagram	619
5.2.2.11	FB_ScaleInput	619
5.2.2.12.1	Description	619
5.2.2.13.2	Arguments	620
5.2.2.14.3.1	Input	620
5.2.2.15.4.2	Output	621
5.2.2.16.5	Usage	621
5.2.2.17.6	Related Functions	621
5.2.2.18.7	Example	621
5.2.2.19.8.1	Structured Text	621
5.2.2.20.9.2	Ladder Diagram	621
5.2.2.21.10.3	Function Block Diagram	622
5.2.2.22	FB_ScaleOutput	622
5.2.2.23.1	Description	622
5.2.2.24.2	Arguments	622
5.2.2.25.3.1	Input	622
5.2.2.26.4.2	Output	623
5.2.2.27.5	Usage	623
5.2.2.28.6	Related Functions	623
5.2.2.29.7	Example	623
5.2.2.30.8.1	Structured Text	623
5.2.2.31.9.2	Ladder Diagram	624
5.2.2.32.10.3	Function Block Diagram	624
5.2.3	FB_ElapseTime	624
5.2.3.1	Description	624
5.2.3.2	Arguments	625
5.2.3.3.1	Input	625
5.2.3.4.2	Output	625
5.2.3.5	Usage	626
5.2.3.6	Example	626
5.2.3.7.1	Structured text	626

5.2.3.8.2	Function Block Diagram	626
5.2.3.9.3	Free Form Ladder Diagram	626
5.2.4	PipeNetwork_FFLD	627
5.2.4.1	Description	627
5.2.4.2	Arguments	627
5.2.4.3.1	Inputs	627
5.2.4.4.2	Outputs	628
5.2.4.5	Usage	628
5.2.4.6	Example	628
5.2.4.7.1	FFLD	628
5.2.5	ProfilesCode_FFLD	628
5.2.5.1	Description	628
5.2.5.2	Arguments	629
5.2.5.3.1	Inputs	629
5.2.5.4.2	Outputs	629
5.2.5.5	Usage	629
5.2.5.6	Example	630
5.2.5.7.1	FFLD	630
5.2.6	FB_TemperaturePID	630
5.2.6.1	Description	630
5.2.6.2	Arguments	630
5.2.6.3.1	Inputs	630
5.2.6.4.2	Outputs	631
5.2.6.5	Usage	631
5.2.6.6.1	Tuning Process	631
5.2.6.7.2	Start PID Controller	632
5.2.6.8	Example	632
5.2.6.9.1	ST	632
5.2.6.10.2	FBD	633
5.2.6.11.3	FFLD	633
5.2.6.12	MLFB_HomeFindHomeInput	633
5.2.6.13.1	Description	633
5.2.6.14.2	Arguments	634
5.2.6.15.3.1	Input	634
5.2.6.16.4.2	Output	634
5.2.6.17.5	Example	635
5.2.6.18.6.1	ST	635
5.2.6.19.7.2	Function Block Diagram	635
5.2.6.20.8.3	FFLD	635
5.2.6.21	MLFB_HomeFindHomeInputThenZeroAngle	636
5.2.6.22.1	Description	636

5.2.6.23.2 Arguments	636
5.2.6.24.3.1 Input	636
5.2.6.25.4.2 Output	637
5.2.6.26.5 Example	637
5.2.6.27.6.1 ST	637
5.2.6.28.7.2 Function Block Diagram	637
5.2.6.29.8.3 FFLD	638
5.2.6.30 MLFB_HomeFindLimitInput	638
5.2.6.31.1 Description	638
5.2.6.32.2 Arguments	638
5.2.6.33.3.1 Input	638
5.2.6.34.4.2 Output	639
5.2.6.35.5 Example	639
5.2.6.36.6.1 ST	639
5.2.6.37.7.2 Function Block Diagram	639
5.2.6.38.8.3 FFLD	640
5.2.6.39 MLFB_HomeFindLimitInputThenZeroAngle	640
5.2.6.40.1 Description	640
5.2.6.41.2 Arguments	640
5.2.6.42.3.1 Input	640
5.2.6.43.4.2 Output	641
5.2.6.44.5 Example	641
5.2.6.45.6.1 ST	641
5.2.6.46.7.2 Function Block Diagram	641
5.2.6.47.8.3 FFLD	642
5.2.6.48 MLFB_HomeFindZeroAngle	642
5.2.6.49.1 Description	642
5.2.6.50.2 Arguments	642
5.2.6.51.3.1 Input	642
5.2.6.52.4.2 Output	643
5.2.6.53.5 Example	643
5.2.6.54.6.1 ST	643
5.2.6.55.7.2 Function Block Diagram	644
5.2.6.56.8.3 FFLD	644
5.2.6.57 MLFB_HomeMoveUntilPosErrExceeded	644
5.2.6.58.1 Description	644
5.2.6.59.2 Arguments	644
5.2.6.60.3.1 Input	644
5.2.6.61.4.2 Output	645

5.2.6.62.5 Example	645
5.2.6.63.6.1 ST	645
5.2.6.64.7.2 Function Block Diagram	646
5.2.6.65.8.3 FFLD	646
5.2.6.66 MLFB_HomeMoveUntilPosErrExceededThenZeroAngle	646
5.2.6.67.1 Description	646
5.2.6.68.2 Arguments	647
5.2.6.69.3.1 Input	647
5.2.6.70.4.2 Output	647
5.2.6.71.5 Example	647
5.2.6.72.6.1 ST	647
5.2.6.73.7.2 Function Block Diagram	648
5.2.6.74.8.3 FFLD	648
5.2.6.75 MLFB_HomeUsingCurrentPosition	648
5.2.6.76.1 Description	648
5.2.6.77.2 Arguments	649
5.2.6.78.3.1 Input	649
5.2.6.79.4.2 Output	649
5.2.6.80.5 Example	649
5.2.6.81.6.1 ST	649
5.2.6.82.7.2 Function Block Diagram	649
5.2.6.83.8.3 FFLD	650
5.2.6.84 MLFB_HomeFindHomeFastInput	650
5.2.6.85.1 Description	650
5.2.6.86.2 Arguments	651
5.2.6.87.3.1 Input	651
5.2.6.88.4.2 Output	652
5.2.6.89.5 Usage	653
5.2.6.90.6 Related Functions	653
5.2.6.91.7 Example	653
5.2.6.92.8.1 Structured Text	653
5.2.6.93.9.2 Ladder Diagram	654
5.2.6.94.10.3 Function Block Diagram	655
5.2.6.95 MLFB_HomeFindHomeFastInputModulo	655
5.2.6.96.1 Description	655
5.2.6.97.2 Arguments	655
5.2.6.98.3.1 Input	656
5.2.6.99.4.2 Output	657
5.2.6.100.5 Usage	658

5.2.6.101.6	Related Functions	658
5.2.6.102.7	Example	658
5.2.6.103.8.1	Structured Text	658
5.2.6.104.9.2	Ladder Diagram	659
5.2.6.105.10.3	Function Block Diagram	660
5.2.6.106	MLFB_HomeFindLimitFastInput	660
5.2.6.107.1	Description	660
5.2.6.108.2	Arguments	661
5.2.6.109.3.1	Input	661
5.2.6.110.4.2	Output	662
5.2.6.111.5	Usage	663
5.2.6.112.6	Related Functions	663
5.2.6.113.7	Example	663
5.2.6.114.8.1	Structured Text	663
5.2.6.115.9.2	Ladder Diagram	664
5.2.6.116.10.3	Function Block Diagram	664
5.2.6.117	MLFB_HomeFindLimitFastInputModulo	665
5.2.6.118.1	Description	665
5.2.6.119.2	Arguments	665
5.2.6.120.3.1	Input	665
5.2.6.121.4.2	Output	667
5.2.6.122.5	Usage	667
5.2.6.123.6	Related Functions	668
5.2.6.124.7	Example	668
5.2.6.125.8.1	Structured Text	668
5.2.6.126.9.2	Ladder Diagram	668
5.2.6.127.10.3	Function Block Diagram	669
5.2.7	Jog for Pipe Network	669
5.2.7.1	Description	669
5.2.7.2	Arguments	670
5.2.7.3.1	Input	670
5.2.7.4.2	Output	670
5.2.7.5	Usage	671
5.2.7.6	Related Functions	671
5.2.7.7	Example	671
5.2.7.8.1	Structured Text	671
5.2.7.9.2	Ladder Diagram	671
5.2.7.10.3	Function Block Diagram	671
5.2.7.11	MLFB_PlsPosFw	671
5.2.7.12.1	Description	671

5.2.7.13.2 Arguments	672
5.2.7.14.3.1 Input	672
5.2.7.15.4.2 Output	672
5.2.7.16.5 Example	672
5.2.7.17.6 Timing	672
5.2.7.18.7.1 ST	672
5.2.7.19.8.2 FBD	672
5.2.7.20.9.3 FFLD	673
5.2.7.21 MLFB_PlsPosFwBw	673
5.2.7.22.1 Description	673
5.2.7.23.2 Arguments	673
5.2.7.24.3.1 Input	673
5.2.7.25.4.2 Output	673
5.2.7.26.5 Example	674
5.2.7.27.6 Timing	674
5.2.7.28.7 Hysteresis	674
5.2.7.29.8.1 ST	674
5.2.7.30.9.2 FBD	674
5.2.7.31.10.3 FFLD	674
5.2.7.32 MLFB_PlsTimeFw	675
5.2.7.33.1 Description	675
5.2.7.34.2 Arguments	675
5.2.7.35.3.1 Input	675
5.2.7.36.4.2 Output	675
5.2.7.37.5 Example	675
5.2.7.38.6 Timing	675
5.2.7.39.7.1 ST	676
5.2.7.40.8.2 FBD	676
5.2.7.41.9.3 FFLD	676
5.2.7.42 MCFB_StepAbsolutes	676
5.2.7.43.1 Description	676
5.2.7.44.2 Arguments	677
5.2.7.45.3.1 Input	677
5.2.7.46.4.2 Output	678
5.2.7.47.5 Related Functions	678
5.2.7.48.6 Example	679
5.2.7.49.7.1 Structured Text	679
5.2.7.50.8.2 Ladder Diagram	679
5.2.7.51.9.3 Function Block Diagram	679

5.2.7.52 MCFB_StepAbsSwitch	679
5.2.7.53.1 Description	679
5.2.7.54.2 Arguments	680
5.2.7.55.3.1 Input	680
5.2.7.56.4.2 Output	683
5.2.7.57.5 Usage	684
5.2.7.58.6 Related Functions	685
5.2.7.59.7 Example	685
5.2.7.60.8.1 Structured Text	685
5.2.7.61.9.2 Ladder Diagram	686
5.2.7.62.10.3 Function Block Diagram	686
5.2.7.63 MCFB_StepBlock	687
5.2.7.64.1 Description	687
5.2.7.65.2 Arguments	687
5.2.7.66.3.1 Input	687
5.2.7.67.4.2 Output	689
5.2.7.68.5 Usage	690
5.2.7.69.6 Related Functions	690
5.2.7.70.7 Example	690
5.2.7.71.8.1 Structured Text	690
5.2.7.72.9.2 Ladder Diagram	691
5.2.7.73.10.3 Function Block Diagram	691
5.2.7.74 MCFB_StepLimitSwitch	692
5.2.7.75.1 Description	692
5.2.7.76.2 Arguments	692
5.2.7.77.3.1 Input	692
5.2.7.78.4.2 Output	694
5.2.7.79.5 Usage	695
5.2.7.80.6 Related Functions	695
5.2.7.81.7 Example	695
5.2.7.82.8.1 Structured Text	695
5.2.7.83.9.2 Ladder Diagram	696
5.2.7.84.10.3 Function Block Diagram	697
5.2.7.85 MCFB_StepRefPulse	697
5.2.7.86.1 Description	697
5.2.7.87.2 Arguments	697
5.2.7.88.3.1 Input	697
5.2.7.89.4.2 Output	699
5.2.7.90.5 Usage	700

5.2.7.91.6	Related Functions	701
5.2.7.92.7	Example	701
5.2.7.93.8.1	Structured Text	701
5.2.7.94.9.2	Ladder Diagram	701
5.2.7.95.10.3	Function Block Diagram	702
5.2.7.96	MCFB_StepAbsSwitchFastInput	702
5.2.7.97.1	Description	702
5.2.7.98.2.1	Input	703
5.2.7.99.3.2	Output	706
5.2.7.100.4	Usage	707
5.2.7.101.5	Related Functions	708
5.2.7.102.6	Example	708
5.2.7.103.7.1	Structured Text	708
5.2.7.104.8.2	FBD	709
5.2.7.105.9.3	Ladder Diagram	709
5.2.7.106	MCFB_StepLimitSwitchFastInput	710
5.2.7.107.1	Description	710
5.2.7.108.2.1	Input	711
5.2.7.109.3.2	Output	714
5.2.7.110.4	Usage	715
5.2.7.111.5	Related Functions	715
5.2.7.112.6	Example	715
5.2.7.113.7.1	Structured Text	715
5.2.7.114.8.2	FBD	715
5.2.7.115.9.3	Ladder Diagram	716
5.2.8	Jog for PLCopen	716
5.2.8.1	Description	716
5.2.8.2	Arguments	717
5.2.8.3.1	Input	717
5.2.8.4.2	Output	718
5.2.8.5	Usage	718
5.2.8.6	Related Functions	718
5.2.8.7	Example	718
5.2.8.8.1	Structured Text	718
5.2.8.9.2	Ladder Diagram	718
5.2.8.10.3	Function Block Diagram	718
5.2.9	MCFB_GearedWebTension	719
5.2.9.1	Arguments	719
5.2.9.2.1	Inputs	719
5.2.9.3.2	Output	722

5.2.9.4 Usage	723
5.2.9.5.1 Example 1	723
5.2.9.6.2 Example 2	723
5.2.9.7.3 PID Function in KAS:	724
5.2.9.8.4 Programming tips:	725
5.2.9.9.5.1 Example 1	725
5.2.9.10.6.2 Example 2	726
5.2.9.11 Related Functions	726
5.2.9.12 Example	726
5.2.9.13.1 Ladder Example	726
5.2.9.14.2 Function Block Diagram Example	727
5.2.9.15.3 Structured Text Example	727
5.2.10 FB_FirstOrderDigitalFilter	727
5.2.10.1 Description	727
5.2.10.2 Arguments	727
5.2.10.3.1 Inputs	727
5.2.10.4.2 Outputs	728
5.2.10.5 Usage	728
5.2.10.6 Example	732
5.2.10.7.1 Structured Text	732
5.2.10.8.2 Ladder Diagram	732
5.2.10.9.3 Function Block Diagram	732
5.2.11 MCFB_AKDFault	732
5.2.11.1 Description	732
5.2.11.2 Arguments	732
5.2.11.3.1 Input	732
5.2.11.4.2 Output	733
5.2.11.5 Usage	733
5.2.11.6 Example	733
5.2.11.7.1 Structured Text	733
5.2.11.8.2 Ladder Diagram	734
5.2.11.9.3 Function Block Diagram	734
5.2.12 MCFB_AKDFaultLookup	734
5.2.12.1 Description	734
5.2.12.2 Arguments	734
5.2.12.3.1 Input	734
5.2.12.4.2 Output	735
5.2.12.5 Usage	735
5.2.12.6 Related Functions	735
5.2.12.7 Example	735
5.2.12.8.1 Structured Text	735

5.2.12.9.2 Ladder Diagram	735
5.2.12.10.3 Function Block Diagram	735
5.2.13 FB_Cylinder	736
5.2.13.1 Description	736
5.2.13.2 Arguments	736
5.2.13.3.1 Input	736
5.2.13.4.2 Output	736
5.2.13.5 Usage	737
5.2.13.6 Example	737
5.2.13.7.1 ST	737
5.2.13.8.2 Function Block Diagram	737
5.2.13.9.3 FFLD	737
5.2.13.10 FB_AKDFltRpt	738
5.2.13.11.1 Description	738
5.2.13.12.2 Arguments	739
5.2.13.13.3.1 Input	739
5.2.13.14.4.2 Output	739
5.2.13.15.5 Usage	740
5.2.13.16.6 Related Functions	740
5.2.13.17.7 Example	740
5.2.13.18.8.1 Structured Text	740
5.2.13.19.9.2 Ladder Diagram	741
5.2.13.20.10.3 Function Block Diagram	741
5.2.13.21 FB_S700FltRpt	742
5.2.13.22.1 Description	742
5.2.13.23.2 Arguments	742
5.2.13.24.3.1 Input	742
5.2.13.25.4.2 Output	743
5.2.13.26.5 Usage	743
5.2.13.27.6 Related Functions	743
5.2.13.28.7 Example	744
5.2.13.29.8.1 Structured Text	744
5.2.13.30.9.2 Ladder Diagram	744
5.2.13.31.10.3 Function Block Diagram	744
5.2.13.32 FB_AxisPlsPosModulo	745
5.2.13.33.1 Description	745
5.2.13.34.2 Arguments	745
5.2.13.35.3.1 Input	745
5.2.13.36.4.2 Output	745
5.2.13.37.5 Example	746

5.2.13.38.6 Timing	746
5.2.13.39.7 Hysteresis	746
5.2.13.40.8.1 ST	746
5.2.13.41.9.2 Function Block Diagram	746
5.2.13.42.10.3 FFLD	747
5.2.13.43 FB_AxisPlsPosNoModulo	747
5.2.13.44.1 Description	747
5.2.13.45.2 Arguments	747
5.2.13.46.3.1 Input	747
5.2.13.47.4.2 Output	748
5.2.13.48.5 Example	748
5.2.13.49.6 Timing	748
5.2.13.50.7 Hysteresis	748
5.2.13.51.8.1 ST	748
5.2.13.52.9.2 FBD	749
5.2.13.53.10.3 FFLD	749
6 Index	750

2 Motion Library

2.1 Motion Library / Pipe Network	82
2.2 Motion Library / PLCopen	324
2.3 MotionLibrary- Common	452

This chapter covers the Motion Library (for **Pipe Network** and **PLCopen**) in the function blocks tab of the Library toolbox.

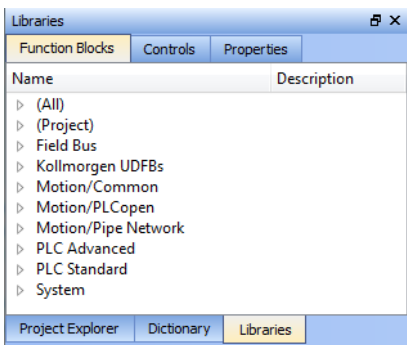

KAS function library contains ML function blocks that are used to integrate motion in a PLC program. ML function blocks can be used in 4 of the IEC 61131-3 languages: ST, FBD, FFLD and IL.

Regarding SFC programs, ML function blocks (like any other function blocks from the library) are used as part of a stepstep or transitiontransition which are defined with ST, FBD, FFLD or IL languages.

2.1 Motion Library / Pipe Network

The KAS IDE function library contains ML function blocks that are used to integrate motion from a Pipe Network in a PLC program. ML Function blocks are of the following types:

Function	Description
Motion	Prepare the physical motion part: init, reset, start, stop
Pipe Network	Manage the Pipe Network: create/activate
Block	Manage the blocks: create/activate
Pipe Block	Manage each specific Pipe Block: read/write parameters...

Table 1-1: List of Pipe Network FB

⚠ IMPORTANT

Pipe Network code is generated automatically by the compiler, you should not try to modify it.

2.1.1 Motion Library - Pipe Network

Name	Description	Return type
MLPipeAct	Activates a pipe	BOOL
MLPipeAddBlock	Adds a Pipe Block to a pipe	BOOL
MLPipeCreate	Creates a new pipe object	None
MLPipeDeact	Deactivates a pipe	BOOL

2.1.1.1 MLPipeAct Pipe Network ✓

2.1.1.2.1 Description

Activates a pipe. A Pipe contains an Input Pipe Block (Master, PMP, or Sampler), a Converter Output Pipe Block, and any Transformation Pipe Block that can be in between. The figure below shows two Pipes, both with the same Master Input Pipe Block. The first ends with the first converter, and has a Gear Pipe Block to transform the input values from the Master. The second pipe ends with the second converter, and has a CAM Pipe Block to modify the input values from the Master.

Once a Pipe is activated then history on the values in the Pipe's Blocks are saved and updated each program cycle. A Converter object connected to a destination Axis object cannot send updated position values unless its Pipe is activated.

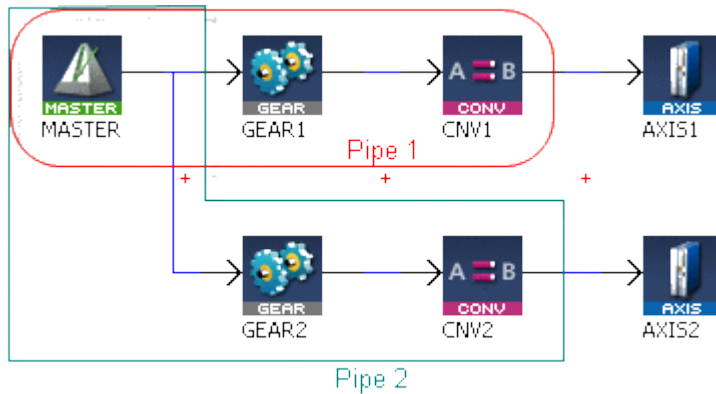

Figure 1-1: MLPipeAct

NOTE

All Pipes in the Pipe Network can be activated at once with the command `PipeNetwork(MLPN_ACTIVATE)`. This calls automatically generated code with `MLPipeAct` commands for each Pipe object. Therefore, in a multi-pipe program only one command can be used to activate Pipes instead of writing code for each Pipe separately.

2.1.1.3.2 Arguments

2.1.1.4.3.1 Input

PipeID	Description	ID number of a created Pipe object
	Data type	DINT
	Range	[-2147483648, 2147483648]
	Unit	n/a
	Default	—

2.1.1.5.4.2 Output

Default (.Q)	Description	Returns TRUE if the Pipe is activated
	Data type	BOOL
	Unit	n/a

2.1.1.6.5.3 Return Type

BOOL

2.1.1.7.6 Related Functions

[MLPipeDeact](#)

"MLCNVConnect" (→ p. 201)

[PipeNetwork\(MLPN_ACTIVATE\)](#)

[MLPipeAddBlock](#)

2.1.1.8.7 Example

2.1.1.9.8.1 Structured Text

```
//Activate a Pipe
MLPipeAct( PipeAXIS1 );
```

2.1.1.10.9.2 Ladder Diagram

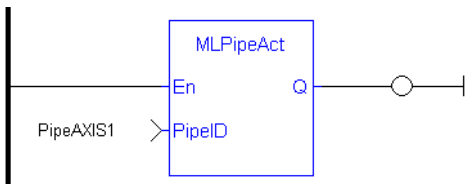

2.1.1.11.10.3 Function Block Diagram

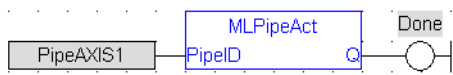

2.1.1.12 MLPipeAddBlock Pipe Network ✓

2.1.1.13.1 Description

Add a Pipe Block to a pipe. A Pipe contains an Input Pipe Block (Master, PMP, or Sampler), a Converter Output Pipe Block, and any Transformation Pipe Block that can be in between.

The figure below shows two Pipes, both with the same Master Input Pipe Block. If a user were to create the Pipe 1 below without using the Graphical Engine, they would use the following commands once a Pipe and the Pipe Blocks have been created.

```
MLPipeAddBlock( PipeAXIS1, MASTER);
MLPipeAddBlock( PipeAXIS1, MyGear);
MLPipeAddBlock( PipeAXIS1, CNV1);
```

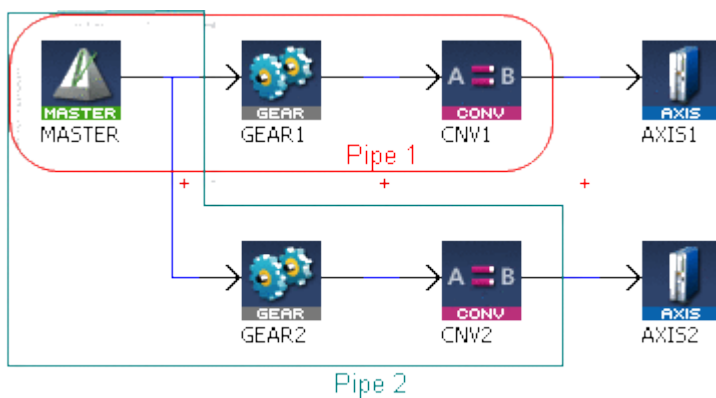

Figure 1-2: MLPipeAddBlock

NOTE

All Blocks in the Pipe Network are added to a Pipe automatically. Code with MLPipeAddBlock commands are automatically generated and called in a program with PipeNetwork(MLPN_CREATE_OBJECTS).

Therefore, when using the Pipe Network graphical engine to create Pipe Blocks the user does not have to manually add MLPipeAddBlock commands to the Project.

2.1.1.14.2 Arguments

2.1.1.15.3.1 Input

PipeID	Description	ID number of a created Pipe
	Data type	DINT
	Range	[-2147483648, 2147483648]
	Unit	n/a
	Default	—
BlockID	Description	ID number of a created Pipe object to add to the selected Pipe
	Data type	DINT
	Range	[-2147483648, 2147483648]
	Unit	n/a
	Default	—

2.1.1.16.4.2 Output

Default (.Q)	Description	Returns TRUE if the Pipe Block is added to the Pipe
	Data type	BOOL
	Unit	n/a

2.1.1.17.5.3 Return Type

BOOL

2.1.1.18.6 Related Functions

[PipeNetwork\(MLPN_CREATE_OBJECTS\)](#)

[MLPipeAct](#)

[MLPipeCreate](#)

[MLPipeDeact](#)

2.1.1.19.7 Example

2.1.1.20.8.1 Structured Text

```
//Add a block to a pipe
MLPipeAddBlock( PipeAXIS1, MyGear );
```

2.1.1.21.9.2 Ladder Diagram

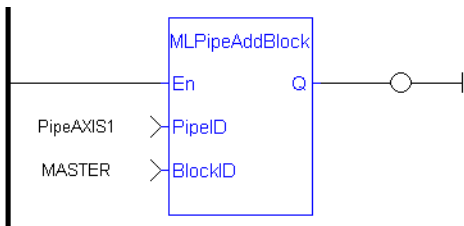

2.1.1.22.10.3 Function Block Diagram

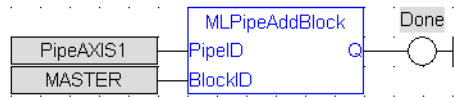

2.1.1.23 MLPipeCreate Pipe Network ✓

2.1.1.24.1 Description

Create a new pipe object. A Pipe contains an Input Pipe Block (Master, PMP, or Sampler), a Converter Output Pipe Block, and any Transformation Pipe Block that can be in between. The figure below shows two Pipes, both with the same Master Input Pipe Block.

NOTE

Pipes are normally created in the Pipe Network using the graphical engine. Then you do not have to add MLPipeCreate function blocks to their programs. Pipes are created graphically, and the code with MLPipeCreate commands are automatically generated and called in a program with PipeNetwork(MLPN_CREATE_OBJECTS).

2.1.1.25.2 Arguments

2.1.1.26.3.1 Input

Name	Description	Desired name for the newly created Pipe
	Data type	String
	Range	—
	Unit	n/a
	Default	—

2.1.1.27.4.2 Output

ID	Description	Assigned ID number of the created Pipe
	Data type	DINT
	Unit	n/a
	Default	—

2.1.1.28.5 Related Functions

[PipeNetwork\(MLPN_CREATE_OBJECTS\)](#)

[MLPipeAddBlock](#)

[MLPipeAct](#)

[MLPipeDeact](#)

2.1.1.29.6 Example

2.1.1.30.7.1 Structured Text

```
//Create a new pipe
PipeAXIS1 := MLPipeCreate( 'PipeAXIS1' );
```

2.1.1.31.8.2 Ladder Diagram

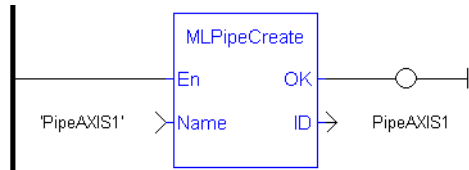

2.1.1.32.9.3 Function Block Diagram



2.1.1.33 MLPipeDeact Pipe Network ✓

2.1.1.34.1 Description

Deactivates a pipe. A Pipe contains an Input Pipe Block (Master, PMP, or Sampler), a Converter Output Pipe Block, and any Transformation Pipe Block that can be in between. The figure below shows two Pipes, both with the same Master Input Pipe Block. The first ends with the first converter, and has a Gear Pipe Block to transform the input values from the Master. The second pipe ends with the second converter, and has a CAM Pipe Block to modify the input values from the Master.

Once a Pipe is activated then history on the values in the Pipe's Blocks are lost and no longer updated. A Converter object connected to a destination Axis object cannot send updated position values once its Pipe is deactivated.

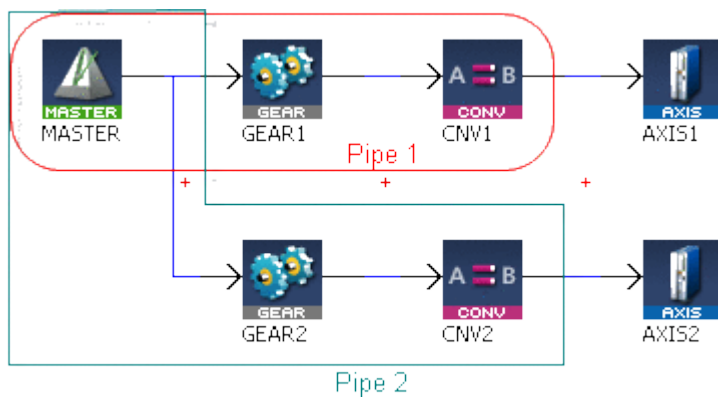

Figure 1-3: MLPipeDeact

NOTE

All Pipes in the Pipe Network can be deactivated at once with the command PipeNetwork(MLPN_DEACTIVATE). This calls automatically generated code with MLPipeDeact commands for each Pipe object. Therefore, in a multi-pipe program only one command can be used to deactivate Pipes instead of writing code for each Pipe separately.

2.1.1.35.2 Arguments

2.1.1.36.3.1 Input

PipeID	Description	ID number of a created Pipe object
	Data type	DINT
	Range	[-2147483648, 2147483648]
	Unit	n/a
	Default	—

2.1.1.37.4.2 Output

Default (.Q)	Description	Returns TRUE if the Pipe is deactivated
	Data type	BOOL
	Unit	n/a

2.1.1.38.5.3 Return Type

BOOL

2.1.1.39.6 Related Functions

[MLPipeAct](#)

"MLCNVDisconnect" (→ p. 207)

[PipeNetwork\(MLPN_DEACTIVATE\)](#)

[MLPipeAddBlock](#)

2.1.1.40.7 Example

2.1.1.41.8.1 Structured Text

```
//Deactivate a Pipe
MLPipeDeact( PipeAXIS1 );
```

2.1.1.42.9.2 Ladder Diagram

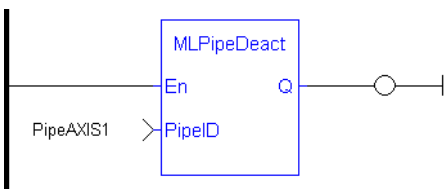

2.1.1.43.10.3 Function Block Diagram



2.1.2 Motion Library - Block

Name	Description	Return type
"MLBikCreate" (→ p. 89)	Creates a new Pipe Block object	None
"MLBikIsReady" (→ p. 92)	Checks if a Pipe Block currently has a function running	BOOL
"MLBikReadModPos" (→ p. 91)	Gets the value of the period of a block in user units	None
"MLBikReadOutVal" (→ p. 90)	Gets the output value of a selected Pipe Block	None
"MLBikWriteModPos" (→ p. 94)	Sets the value of the period of a block in user units	BOOL

2.1.2.1 MLBikCreate

2.1.2.2.1 Description

Creates a new Pipe Block object. Before a Pipe Block is Initialized the block needs to be created and assigned an ID number. MLBikCreate function block is automatically called if a Block is added to the Pipe Network.

NOTE

Pipe Blocks are normally created in the Pipe Network using the graphical engine. Then you do not have to add MLBikCreate function blocks to their programs. Blocks are created graphically, and the code with MLBikCreate commands are automatically generated and called in a program with Pipe Network(MLPN_CREATE_OBJECTS).

TIP

This function must be called or executed before "MLMotionStart" (→ p. 474) is called.

2.1.2.3.2 Arguments

2.1.2.4.3.1 Input

Name	Description	Desired name for the newly created Pipe Block
	Data type	String
	Range	—
	Unit	n/a
	Default	—
Type	Description	Type of Pipe Block to create (ex. MASTER, GEAR, PHASER, etc.)
	Data type	String
	Range	—
	Unit	n/a
	Default	—

2.1.2.5.4.2 Output

ID	Description	Assigned ID number of the created Block
	Data type	DINT
	Unit	n/a
	Default	—

2.1.2.6.5 Related Functions

[PipeNetwork\(MLPN_CREATE_OBJECTS\)](#)

[MLAxisInit](#)

2.1.2.7.6 Example

2.1.2.8.7.1 Structured Text

```
//Create a new GEAR Pipe Block named "MyGear"
MyGear := MLBlkCreate( 'MyGear', 'GEAR' );
```

2.1.2.9.8.2 Ladder Diagram

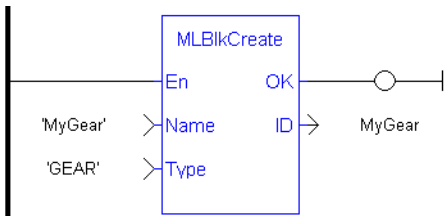

2.1.2.10.9.3 Function Block Diagram

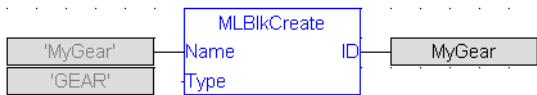

2.1.2.11 MLBlkReadOutVal Pipe Network ✓

2.1.2.12.1 Description

Get the output value a selected Pipe Block.

2.1.2.13.2 Arguments

2.1.2.14.3.1 Input

ID	Description	ID number of a created Pipe Block
	Data type	DINT
	Range	[-2147483648, 2147483648]
	Unit	n/a
	Default	—

2.1.2.15.4.2 Output

Value	Description	Current output value of the selected Pipe Block
	Data type	LREAL
	Unit	n/a
	Default	—

2.1.2.16.5 Related Functions

[MLBlkReadModPos](#)

[MLBlkCreate](#)

2.1.2.17.6 Example

2.1.2.18.7.1 Structured Text

```
//Save the output of a Gear Pipe Block
BlockOutput := MLBlkReadOutVal( PipeNetwork.MyGear );
```

2.1.2.19.8.2 Ladder Diagram

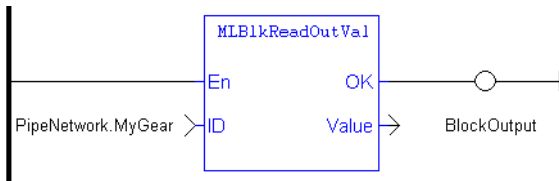

2.1.2.20.9.3 Function Block Diagram

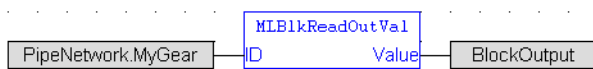

2.1.2.21 MLBlkReadModPos Pipe Network ✓

2.1.2.22.1 Description

Get the value of the period of a block in user units. The output value of a block is reset each time it reaches its period value.

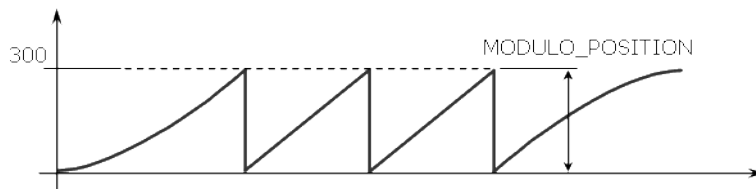

Figure 1-4: MLBlkReadModPos

2.1.2.23.2 Arguments

2.1.2.24.3.1 Input

ID	Description	ID number of a created Pipe Block
	Data type	DINT
	Range	[-2147483648, 2147483648]
	Unit	n/a
	Default	—

2.1.2.25.4.2 Output

ModuloPosition	Description	Current Period Value for selected Pipe Block
	Data type	LREAL
	Unit	User unit
	Default	—

2.1.2.26.5 Related Functions

[MLBlkWriteModPos](#)

[MLBlkCreate](#)

[MLBlkReadOutVal](#)

2.1.2.27.6 Example

2.1.2.28.7.1 Structured Text

```
//Return and save the Period of a Pipe Block
GearPeriod := MLBlkReadModPos ( PipeNetwork.MyGear );
```

2.1.2.29.8.2 Ladder Diagram



2.1.2.30.9.3 Function Block Diagram

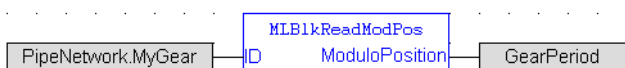

2.1.2.31 MLBlkIsReady Pipe Network ✓

2.1.2.32.1 Description

Check if a block is ready. Returns FALSE if the selected Pipe Block has a function running. Returns TRUE if no function of a specified Pipe Block is running.

NOTE

Same return value as the .Q output of a specific function itself

2.1.2.33.2 Arguments**2.1.2.34.3.1 Input**

ID	Description	ID number of a created Pipe Block
	Data type	DINT
	Range	[-2147483648, 2147483648]
	Unit	n/a
	Default	—

2.1.2.35.4.2 Output

Default (.Q)	Description	Returns TRUE if no function of a specified Pipe Block is running.
	Data type	BOOL
	Unit	n/a

2.1.2.36.5.3 Return Type

BOOL

2.1.2.37.6 Related Functions

[MLBlkReadOutVal](#)

[MLBlkReadModPos](#)

2.1.2.38.7 Example**2.1.2.39.8.1 Structured Text**

```
//Check if the MST Pipe Block named "MASTER" has a function
running
IsReady := MLBlkIsReady( PipeNetwork.MASTER );
```

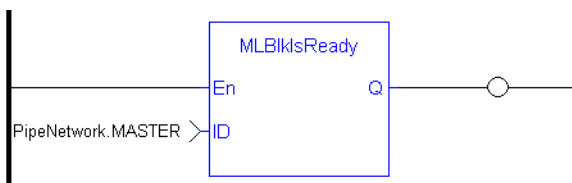
2.1.2.40.9.2 Ladder Diagram**2.1.2.41.10.3 Function Block Diagram**

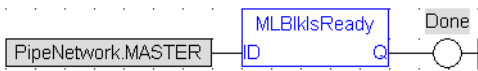

2.1.2.42 MLBikWriteModPos Pipe Network ✓

2.1.2.43.1 Description

Set the value of the period of a block in user units. The output value of a block is reset each time it reaches its period value.

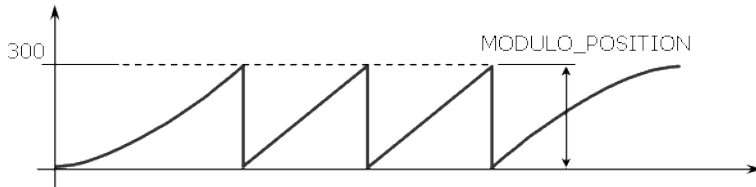

Figure 1-5: MLBikReadModPos

2.1.2.44.2 Arguments

2.1.2.45.3.1 Input

ID	Description	ID number of a created Pipe Block
	Data type	DINT
	Range	[-2147483648, 2147483648]
	Unit	n/a
	Default	—
ModuloPosition	Description	Desired new Period Value for selected Pipe Block
	Data type	LREAL
	Range	—
	Unit	User unit
	Default	—

2.1.2.46.4.2 Output

Default (.Q)	Description	Returns TRUE if the function block executes
	Data type	BOOL
	Unit	n/a

2.1.2.47.5.3 Return Type

BOOL

2.1.2.48.6 Related Functions

[MLBikReadModPos](#)

[MLBikCreate](#)

[MLBikReadOutVal](#)

2.1.2.49.7 Example

2.1.2.50.8.1 Structured Text

```
//Set the Period of a Pipe Block to 300
MLBlkWriteModPos( PipeNetwork.MyGear, 300 );
```

2.1.2.51.9.2 Ladder Diagram

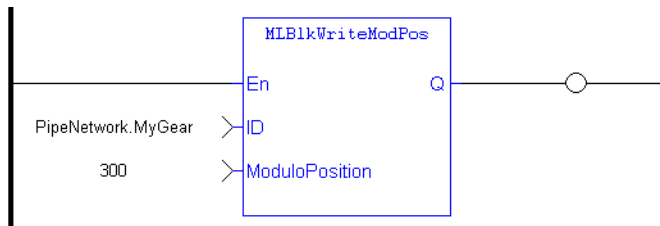

2.1.2.52.10.3 Function Block Diagram

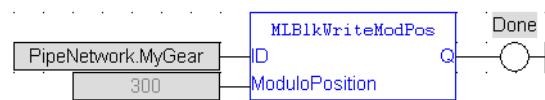

2.1.3 Motion Library - Adder

Name	Description	Return type
MLAddInit	Initializes an Adder Pipe Block with user-defined settings	BOOL
MLAddReadOff1	Returns the offset value of the first entry of an Adder block	None
MLAddReadOff2	Returns the offset value of the second entry of an Adder block	None
MLAddReadRatio1	Returns the ratio value of the first entry of an Adder block	None
MLAddReadRatio2	Returns the ratio value of the second entry of an Adder block	None
MLAddWriteInput	Sets the source of an input of an adder Pipe Block	BOOL
MLAddWriteOff1	Sets the offset value of the first entry of the Adder block	BOOL
MLAddWriteOff2	Sets the offset value of the second entry of the Adder block	BOOL
MLAddWriteRat1	Sets the ratio value of the first entry of the Adder block	BOOL
MLAddWriteRat2	Sets the ratio value of the second entry of the Adder block	BOOL

2.1.3.1 MLAddInit Pipe Network ✓

2.1.3.2.1 Description

Initializes an Adder Pipe Block for use in a PLC Program. Function block is automatically called if an Adder Block is added to the Pipe Network, with user-defined settings entered in the Pipe Blocks Properties screen.

The Pipe Block is assigned ratios and offsets for both inputs. After an Adder block is initialized, the inputs still need to be selected using the MLAddWriteInput function block or graphically using the Pipe Network.

$$\text{Adder Block Output} = \text{Ratio1} * \text{Input1} + \text{Offset1} + \text{Ratio2} * \text{Input2} + \text{Offset2}$$

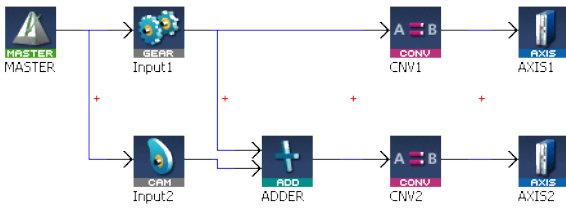

Figure 1-6: MLAddInit

NOTE

Adder objects are normally created in the Pipe Network using the graphical engine. Then you do not have to add MLAddInit function blocks to their programs. Parameters are entered directly in pop-up windows, and the code is then automatically added to the current project.

2.1.3.3.2 Arguments

2.1.3.4.3.1 Input

BlockID	Description	ID number of a created Pipe Block
	Data type	DINT
	Range	[-2147483648, 2147483648]
	Unit	n/a
	Default	—
Ratio1	Description	Sets the Ratio value of the first entry of an Adder object
	Data type	LREAL
	Range	—
	Unit	n/a
	Default	—
Offset1	Description	Sets the Offset value of the first entry of an Adder object
	Data type	LREAL
	Range	—
	Unit	n/a
	Default	—

Ratio2	Description	Sets the Ratio value of the second entry of an Adder object
	Data type	LREAL
	Range	—
	Unit	n/a
	Default	—
Offset2	Description	Sets the Offset value of the second entry of an Adder object
	Data type	LREAL
	Range	—
	Unit	n/a
	Default	—

2.1.3.5.4.2 Output

Default (.Q)	Description	Returns TRUE if the Adder Pipe Block is initialized
	Data type	BOOL
	Unit	n/a

2.1.3.6.5.3 Return Type

BOOL

2.1.3.7.6 Related Functions

[MLBlkCreate](#)

[MLAddWriteInput](#)

[MLAddReadOff1](#)

[MLAddReadRatio1](#)

2.1.3.8.7 Example

2.1.3.9.8.1 Structured Text

```
//Create and Initiate a Trigger object
MyAdder := MLBlkCreate( 'MyAdder', 'ADDER' );
MLAddInit( MyAdder, 1.0, 0.0, 1.0, 0.0 );
```

2.1.3.10.9.2 Ladder Diagram

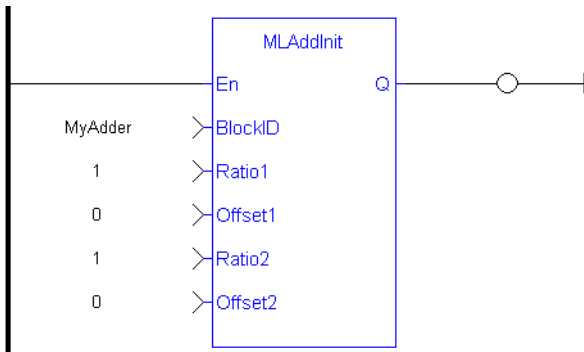

2.1.3.11.10.3 Function Block Diagram

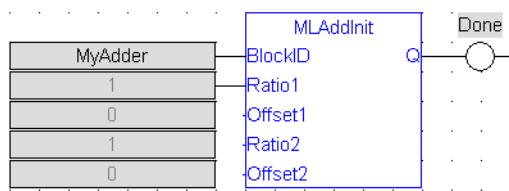

2.1.3.12 MAddReadOff1 Pipe Network ✓

2.1.3.13.1 Description

Returns the offset value of the first entry of an Adder block. Can change the offset value with MAddWriteOff1 function block. Offset1 shifts the value of the first input to the block before its added to the second input.

$$\text{Adder Block Output} = \text{Ratio1} * \text{Input1} + \text{Offset1} + \text{Ratio2} * \text{Input2} + \text{Offset2}$$

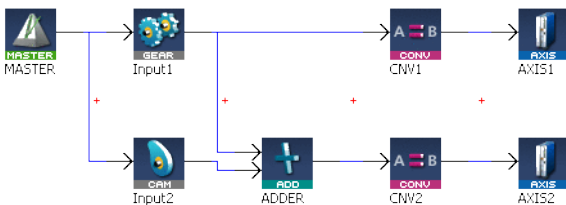

Figure 1-7: MAddReadOff1

2.1.3.14.2 Arguments

2.1.3.15.3.1 Input

BlockID	Description	ID number of an initiated Adder object
	Data type	DINT
	Range	[-2147483648, 2147483648]
	Unit	n/a
	Default	—

2.1.3.16.4.2 Output

Offset	Description	Returns the offset value of the first entry of an Adder object
	Data type	LREAL
	Unit	n/a

2.1.3.17.5 Related Functions

[MLAddWriteOff1](#)

[MLAddReadOff2](#)

[MLAddReadRatio1](#)

[MLAddWriteRat1](#)

2.1.3.18.6 Example

2.1.3.19.7.1 Structured Text

```
//Save the offset value of first entry to the Adder block
AdderOffset := MLAddReadOff1( PipeNetwork.MyAdder );
```

2.1.3.20.8.2 Ladder Diagram

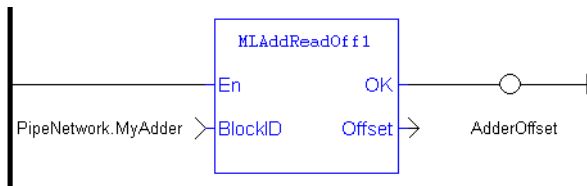

2.1.3.21.9.3 Function Block Diagram

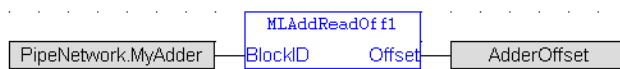

2.1.3.22 MLAddReadOff2 Pipe Network ✓

2.1.3.23.1 Description

Returns the offset value of the second entry of an Adder block. Can change the offset value with MLAddWriteOff2 function block. Offset2 shifts the value of the second input to the block before its added to the first input.

$$\text{Adder Block Output} = \text{Ratio1} * \text{Input1} + \text{Offset1} + \text{Ratio2} * \text{Input2} + \text{Offset2}$$

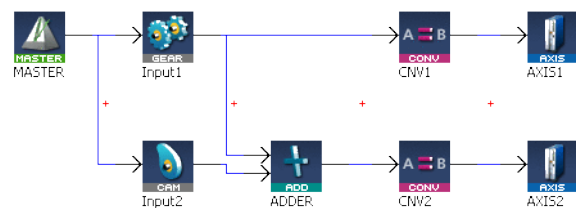

Figure 1-8: MlAddReadOff2

2.1.3.24.2 Arguments

2.1.3.25.3.1 Input

BlockID	Description	ID number of an initiated Adder object
	Data type	DINT
	Range	[-2147483648, 2147483648]
	Unit	n/a
	Default	—

2.1.3.26.4.2 Output

Offset	Description	Returns the offset value of the second entry of an Adder object
	Data type	LREAL
	Unit	n/a

2.1.3.27.5 Related Functions

[MlAddWriteOff2](#)

[MlAddReadOff1](#)

[MlAddReadRatio2](#)

[MlAddWriteRat2](#)

2.1.3.28.6 Example

2.1.3.29.7.1 Structured Text

```
//Save the offset value of second entry to the Adder block
AdderOffset := MlAddReadOff2( PipeNetwork.MyAdder );
```

2.1.3.30.8.2 Ladder Diagram

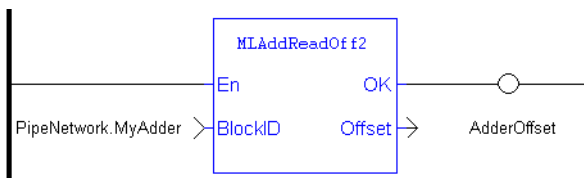

2.1.3.31.9.3 Function Block Diagram



2.1.3.32 MLAddReadRatio1 Pipe Network ✓

2.1.3.33.1 Description

Returns the ratio value of the first entry of an Adder block. Can change the ratio value with MLAddWriteRat1 function block. Ratio1 amplifies the value of the first input to the block before its added to the second input.

Adder Block Output = Ratio1*Input1 + Offset1 + Ratio2*Input2 + Offset2

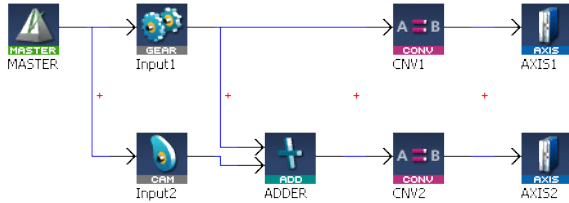

Figure 1-9: MLAddReadRatio1

2.1.3.34.2 Arguments

2.1.3.35.3.1 Input

BlockID	Description	ID number of an initiated Adder object
	Data type	DINT
	Range	[-2147483648, 2147483648]
	Unit	n/a
	Default	—

2.1.3.36.4.2 Output

Ratio	Description	Returns the Ratio value of the first entry of an Adder object
	Data type	LREAL
	Unit	n/a

2.1.3.37.5 Related Functions

[MLAddWriteRat1](#)

[MLAddReadRatio2](#)

[MLAddReadOff1](#)

[MLAddReadOff2](#)

2.1.3.38.6 Example

2.1.3.39.7.1 Structured Text

```
//Save the ratio value of first entry to the Adder block
AdderRatio := MLAddReadRatio1( PipeNetwork.MyAdder );
```

2.1.3.40.8.2 Ladder Diagram

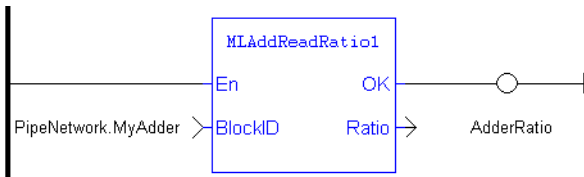

2.1.3.41.9.3 Function Block Diagram



2.1.3.42 MLAddReadRatio2 Pipe Network ✓

2.1.3.43.1 Description

Returns the ratio value of the second entry of an Adder block. Can change the ratio value with MLAddWriteRat2 function block. Ratio2 amplifies the value of the second input to the block before its added to the first input.

$$\text{Adder Block Output} = \text{Ratio1} * \text{Input1} + \text{Offset1} + \text{Ratio2} * \text{Input2} + \text{Offset2}$$

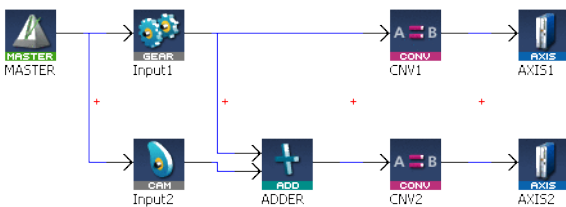

Figure 1-10: MLAddReadRatio2

2.1.3.44.2 Arguments

2.1.3.45.3.1 Input

BlockID	Description	ID number of an initiated Adder object
	Data type	DINT
	Range	[-2147483648, 2147483648]
	Unit	n/a
	Default	—

2.1.3.46.4.2 Output

Ratio	Description	Returns the Ratio value of the second entry of an Adder object
	Data type	LREAL
	Unit	n/a

2.1.3.47.5 Related Functions

[MLAddWriteRat2](#)

[MLAddReadRatio1](#)

[MLAddReadOff1](#)

[MLAddReadOff2](#)

2.1.3.48.6 Example

2.1.3.49.7.1 Structured Text

```
//Save the ratio value of second entry to the Adder block
AdderRatio := MLAddReadRatio2( PipeNetwork.MyAdder );
```

2.1.3.50.8.2 Ladder Diagram

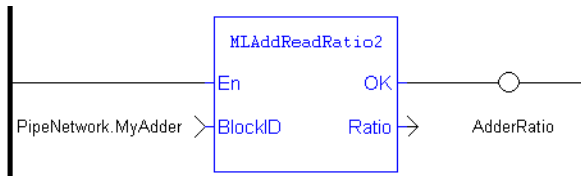

2.1.3.51.9.3 Function Block Diagram



2.1.3.52 MLAddWriteInput Pipe Network ✓

2.1.3.53.1 Description

Sets the source of an input of an adder Pipe Block. Function block is automatically called if an Adder Block is connected to other blocks in the Pipe Network.

$$\text{Adder Block Output} = \text{Ratio1} * \text{Input1} + \text{Offset1} + \text{Ratio2} * \text{Input2} + \text{Offset2}$$

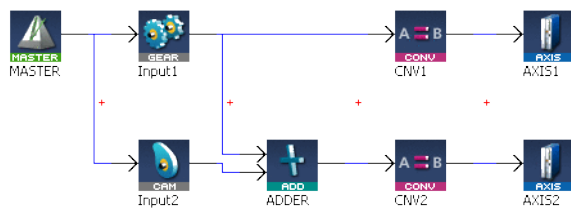

Figure 1-11: MLAddWriteInput

NOTE

Adder objects are normally created in the Pipe Network using the graphical engine. Then you do not have to add MLAddWriteInput function blocks to their programs. Blocks are connected with lines in the Pipe Network, and the code is then automatically added to the current project.

2.1.3.54.2 Arguments

2.1.3.55.3.1 Input

BlockID	Description
	ID number of an initiated Adder object

	Data type	DINT
	Range	[-2147483648, 2147483648]
	Unit	n/a
	Default	—
InputID	Description	Select first or second input to the Adder object
	Data type	DINT
	Range	[1, 2]
	Unit	n/a
	Default	—
InputBlockID	Description	ID number of an initiated Pipe Block which is an input to the Adder object
	Data type	DINT
	Range	[-2147483648, 2147483648]
	Unit	n/a
	Default	—

2.1.3.56.4.2 Output

Default (.Q)	Description	Returns TRUE if the input to the Adder object is set
	Data type	BOOL
	Unit	n/a

2.1.3.57.5.3 Return Type

BOOL

2.1.3.58.6 Related Functions

[MLBlkCreate](#)

[MLAddInit](#)

[MLAddReadOff1](#)

[MLAddReadRatio1](#)

2.1.3.59.7 Example

2.1.3.60.8.1 Structured Text

```
//Set the first input of an Adder pipeblock to be connected to
the output of GEAR1 pipeblock
MLAddWriteInput( PipeNetwork.ADDER, 1, PipeNetwork.GEAR1 );
```

2.1.3.61.9.2 Ladder Diagram

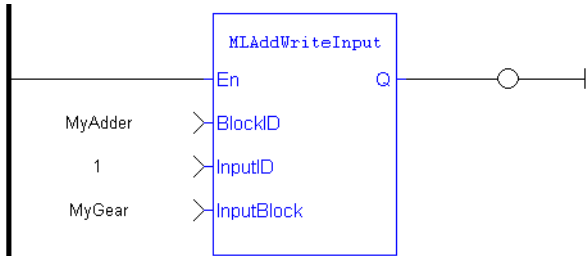

2.1.3.62.10.3 Function Block Diagram

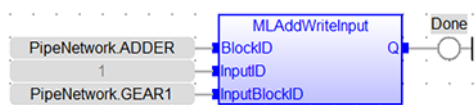

2.1.3.63 MLAddWriteOff1 Pipe Network ✓

2.1.3.64.1 Description

Set the offset value of the first entry of the Adder block. Offset1 shifts the value of the first input to the block before its added to the second input.

$$\text{Adder Block Output} = \text{Ratio1} * \text{Input1} + \text{Offset1} + \text{Ratio2} * \text{Input2} + \text{Offset2}$$

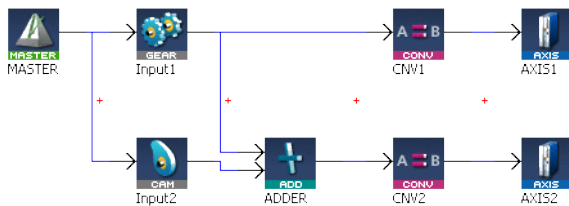

Figure 1-12: MLAddWriteOff1

⚠ IMPORTANT

Changes made to the Offset of an Adder block are executed immediately and can cause an axis position to jump.

2.1.3.65.2 Arguments

2.1.3.66.3.1 Input

BlockID	Description	ID number of an initiated Adder object
	Data type	DINT
	Range	[-2147483648, 2147483648]
	Unit	n/a
	Default	—

Offset	Description	Desired new value for the Adder Object's Offset1
	Data type	LREAL
	Range	—
	Unit	n/a
	Default	—

2.1.3.67.4.2 Output

Default (.Q)	Description	Returns TRUE if the Offset value for input one is set
	Data type	BOOL
	Unit	n/a

2.1.3.68.5.3 Return Type

BOOL

2.1.3.69.6 Related Functions

[MLAddReadOff1](#)

[MLAddWriteOff2](#)

[MLAddReadRatio1](#)

[MLAddWriteRat1](#)

2.1.3.70.7 Example

2.1.3.71.8.1 Structured Text

```
//Change the offset value of first entry to the Adder block to
10
MLAddWriteOff1( PipeNetwork.MyAdder, 10 );
```

2.1.3.72.9.2 Ladder Diagram

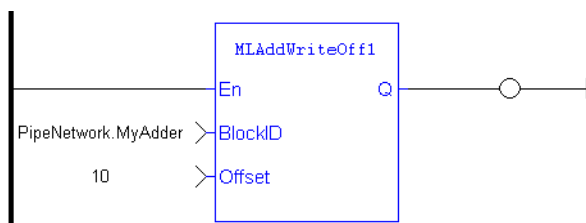

2.1.3.73.10.3 Function Block Diagram

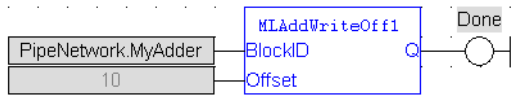

2.1.3.74 MLAddWriteOff2 Pipe Network ✓

2.1.3.75.1 Description

Set the offset value of the second entry of the Adder block. Offset2 shifts the value of the second input to the block before its added to the first input.

$$\text{Adder Block Output} = \text{Ratio1} * \text{Input1} + \text{Offset1} + \text{Ratio2} * \text{Input2} + \text{Offset2}$$

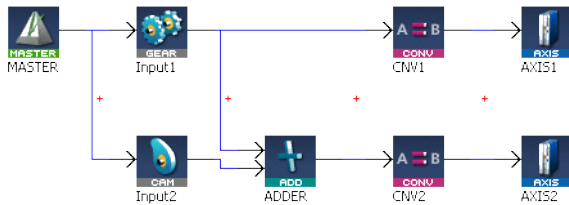

Figure 1-13: MLAddWriteOff2

⚠ IMPORTANT

Changes made to the Offset of an Adder block are executed immediately and can cause an axis position to jump.

2.1.3.76.2 Arguments

2.1.3.77.3.1 Input

BlockID	Description	ID number of an initiated Adder object
	Data type	DINT
	Range	[-2147483648, 2147483648]
	Unit	n/a
	Default	—
Offset	Description	Desired new value for the Adder Object's Offset2
	Data type	LREAL
	Range	—
	Unit	n/a
	Default	—

2.1.3.78.4.2 Output

Default (.Q)	Description	Returns TRUE if the Offset value for input two is set
---------------------	--------------------	---

Data type	BOOL
Unit	n/a

2.1.3.79.5.3 Return Type

BOOL

2.1.3.80.6 Related Functions

[MLAddReadOff2](#)

[MLAddWriteOff1](#)

[MLAddReadRatio2](#)

[MLAddWriteRat2](#)

2.1.3.81.7 Example

2.1.3.82.8.1 Structured Text

```
//Change the offset value of second entry to the Adder block to 10
MLAddWriteOff2( PipeNetwork.MyAdder, 10 );
```

2.1.3.83.9.2 Ladder Diagram

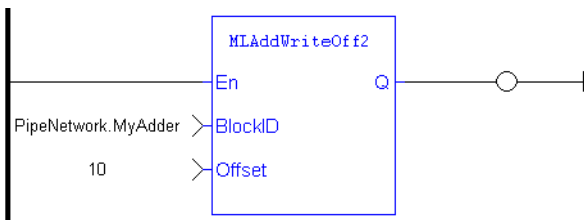

2.1.3.84.10.3 Function Block Diagram

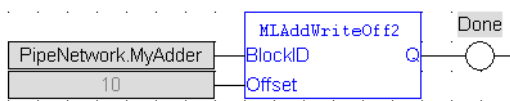

2.1.3.85 MLAddWriteRat1 Pipe Network ✓

2.1.3.86.1 Description

Set the ratio value of the first entry of the Adder block. Ratio1 amplifies the value of the first input to the block before its added to the second input.

$$\text{Adder Block Output} = \text{Ratio1} * \text{Input1} + \text{Offset1} + \text{Ratio2} * \text{Input2} + \text{Offset2}$$

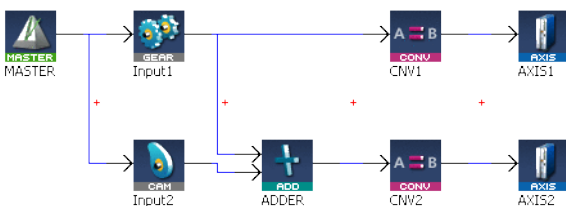

Figure 1-14: MAddWriteRat1

ⓘ IMPORTANT

Changes made to the Ratio of an Adder block are executed immediately and can cause an axis position to jump.

2.1.3.87.2 Arguments**2.1.3.88.3.1 Input**

BlockID	Description	ID number of an initiated Adder object
	Data type	DINT
	Range	[-2147483648, 2147483648]
	Unit	n/a
	Default	—
Ratio	Description	Desired new value for the Adder Object's Ratio1
	Data type	LREAL
	Range	—
	Unit	n/a
	Default	—

2.1.3.89.4.2 Output

Default (.Q)	Description	Returns TRUE if the Ratio value for input one is set
	Data type	BOOL
	Unit	n/a

2.1.3.90.5.3 Return Type

BOOL

2.1.3.91.6 Related Functions

[MAddReadRatio1](#)

[MAddWriteRat2](#)

[MAddReadOff1](#)

[MAddWriteOff1](#)

2.1.3.92.7 Example**2.1.3.93.8.1 Structured Text**

```
//Change the ratio value of first entry to the Adder block to 2
MLAddWriteRat1( PipeNetwork.MyAdder, 2 );
```

2.1.3.94.9.2 Ladder Diagram

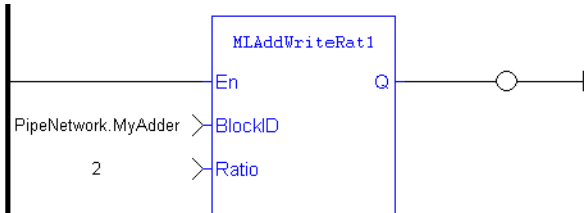

2.1.3.95.10.3 Function Block Diagram

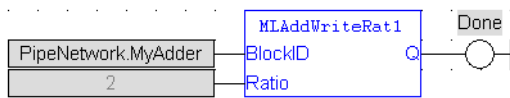

2.1.3.96 MLAddWriteRat2 Pipe Network ✓

2.1.3.97.1 Description

Set the ratio value of the second entry of the Adder block. Ratio2 amplifies the value of the second input to the block before its added to the first input.

$$\text{Adder Block Output} = \text{Ratio1} * \text{Input1} + \text{Offset1} + \text{Ratio2} * \text{Input2} + \text{Offset2}$$

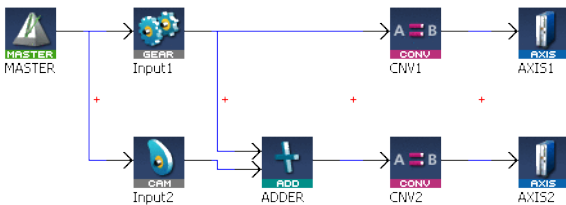

Figure 1-15: MLAddWriteRat2\

! IMPORTANT

Changes made to the Ratio of an Adder block are executed immediately and can cause an axis position to jump.

2.1.3.98.2 Arguments

2.1.3.99.3.1 Input

BlockID	Description	ID number of an initiated Adder object
	Data type	DINT
	Range	[-2147483648, 2147483648]
	Unit	n/a

	Default	—
Ratio	Description	Desired new value for the Adder Object's Ratio2
	Data type	LREAL
	Range	—
	Unit	n/a
	Default	—

2.1.3.100.4.2 Output

Default (.Q)	Description	Returns TRUE if the Ratio value for input two is set
	Data type	BOOL
	Unit	n/a

2.1.3.101.5.3 Return Type

BOOL

2.1.3.102.6 Related Functions

[MLAddReadRatio2](#)

[MLAddWriteRat1](#)

[MLAddReadOff2](#)

[MLAddWriteOff2](#)

2.1.3.103.7 Example

2.1.3.104.8.1 Structured Text

```
//Change the ratio value of second entry to the Adder block to
2
MLAddWriteRat2 ( PipeNetwork.MyAdder, 2 );
```

2.1.3.105.9.2 Ladder Diagram

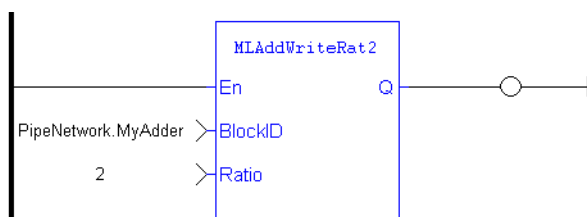

2.1.3.106.10.3 Function Block Diagram

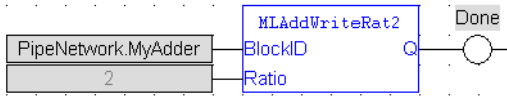

2.1.4 Motion Library - Axis

TIP

- For an Axis function example, see "Usage Example of Axis Functions" on page 175

Function sorted by types:

Power Stage	Motion Control	Inquiry Functions	Position setting
MLAxisPower	MLAxisAbs	MLAxisGenPos	
MLAxisPowerDOff	MLAxisAdd	MLAxisPipePos	MLAxisReAlign
	MLAxisMoveVel	MLAxisCmdPos	
	MLAxisRel	MLAxisReadActPos	
	MLAxisStop	MLAxisFBackPos	
		MLAxisStatus	
		MLAxisReadGenStatus	
		MLAxisGenIsRdy	
		MLAxisTimeStamp	

Functions sorted in alphabetical order:

Name	Description	Return type
MLAxisAbs	Performs a move to an absolute position	BOOL
MLAxisAdd	Performs an additive move relative for a specified distance from the endpoint of the previous move	BOOL
MLAxisAddress	Returns the motion bus address of the axis	DINT
MLAxisAddTq	Sets additive torque	BOOL
MLAxisCfgFastIn	Initializes the Fast Input capability for the axis	BOOL
MLAxisCmdPos	Returns the reference position of the axis	None
MLAxisCreate	Creates a new axis object	None
MLAxisFBackPos	Returns the feedback position of the axis	None
MLAxisGenEN	Enables or disables the internal TMP generator of the axis	BOOL
MLAxisGenIsEN	Checks if the internal TMP generator of the axis is enabled	BOOL
MLAxisGenIsRdy	Checks if an axis is ready	BOOL
MLAxisGenPos	Returns the generator position of the axis	None
MLAxisGenReadAcc	Gets the acceleration of the internal generator of an axis	None
MLAxisGenReadDec	Gets the deceleration of the internal generator of an axis	None
MLAxisGenReadSpd	Gets the speed of the internal generator of an axis	None
MLAxisGenWriteAcc	Sets the acceleration of the internal generator of an axis	BOOL

Name	Description	Return type
MLAxisGenWriteDec	Sets the deceleration of the internal generator of an axis	BOOL
MLAxisGenWriteSpd	Sets the speed of the internal generator of an axis	BOOL
MLAxisInit	Initializes an axis object	BOOL
MLAxisIsCnctd	Checks if a pipe is currently connected to the axis	BOOL
MLAxisIsTriggered	Checks if the axis got a trigger event	BOOL
MLAxisMoveVel	Jogs at the specified speed	BOOL
MLAxisPipePos	Returns the pipe position of the axis	None
MLAxisPower	Powers up the axis. Enables Axis Servo Drive.	BOOL
MLAxisPowerDOff	Returns the adjustment of position done by the last power on to avoid bumps	None
MLAxisRatedTq	Sets rated motor torque	BOOL
MLAxisRead2ndFB	Read secondary feedback	None
MLAxisReadActPos	Returns the actual position of the axis	None
MLAxisReadFBUnit	Gets the feedback units per revolution value of the axis	None
MLAxisReadFEUU	Read following error in user units	None
MLAxisReadGenStatus	Returns the status of the internal generator of the axis	DINT
MLAxisReadModPos	Get the value period of the axis	None
MLAxisReadTq	Read actual torque	None
MLAxisReadUUnits	Get the user units per revolution value of the axis	None
MLAxisReadVel	Read actual velocity	None
MLAxisReAlignRdy	Checks if an axis is ready. Returns TRUE if the internal realignment axis is ready.	BOOL
MLAxisReAlign	Realigns the actual position with the reference position by moving the axis by the specified delta position	BOOL
MLAxisRel	Performs a relative move for a specified distance from the current position	BOOL
MLAxisResetErrors	Clears errors of the specified axis	BOOL
MLAxisRstFastIn	Resets the Fast Input	BOOL
MLAxisStatus	Returns the status of the axis	DINT
MLAxisStop	Stop with the specified deceleration	None
MLAxisTimeStamp	Returns the timestamp of the triggered axis	DINT
MLAxisWriteModPos	Sets the value period of the axis	BOOL
MLAxisWritePipPos	Forces the pipe position internal value. This function is working only when no pipe is connected.	BOOL
MLAxisWritePos	Sets the logical zero position of an axis	BOOL
MLAxisWriteUUnits	Sets the user units per revolution value of the axis	BOOL

2.1.4.1 MLAxisAbs Pipe Network

2.1.4.2.1 Description

Performs a move to an absolute position. Returns TRUE if the function succeeded.

2.1.4.3.2 Arguments

2.1.4.4.3.1 Input

ID	Description	ID name of the Axis Block
	Data type	DINT
	Range	[-2147483648, 2147483648]
	Unit	n/a
	Default	—
Position	Description	Sets the value of the absolute destination position. When the Modulo is turned on, see more explanations below.
	Data type	LREAL
	Range	—
	Unit	User unit
	Default	—

2.1.4.5 Position with Modulo On

When the Modulo is turned on, the Axis Block moves to the targeted position during the corresponding period, calculated as follows:

- If the Position input is between 0 and the Modulo Position, then the Axis Block moves within the **current** period (no position rollover).
- If the Position input is greater than the Modulo Position, then the Axis Block moves during one of the **next** period (positive position rollover).

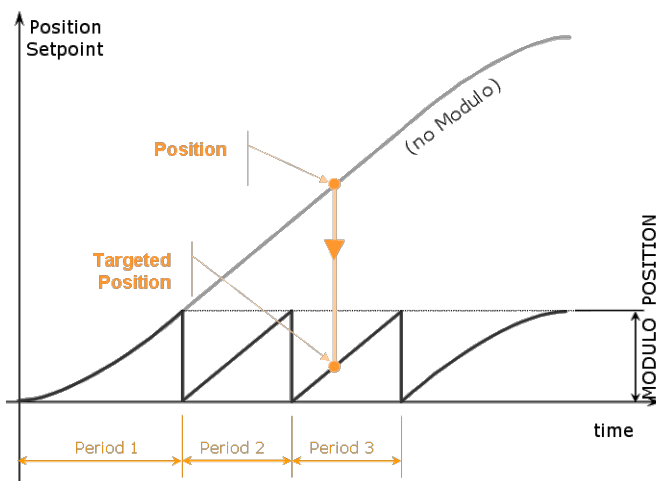

The Axis Block works similarly for negative positions: if the Position input is less than zero, then the Axis Block moves during one of the **previous** period (negative position rollover).

2.1.4.6 Forcing the direction of rotation

In some applications, the direction of rotation for the axis is forced in one direction only. As a consequence, the motor movement goes to the next or previous modulo in the following situations:

- If the **End Position** is less than the **Start Position** and the direction of rotation for the axis is forced to be clockwise (the red point shows when the modulo position is reached)

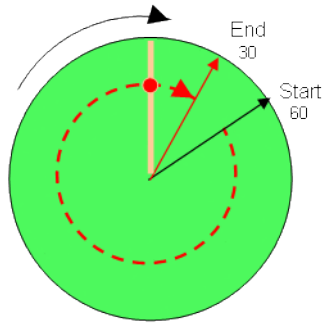

(see an example in row#2 of the table below)

- If the **End Position** is greater than the **Start Position** and the direction of rotation for the axis is forced to be counter clockwise

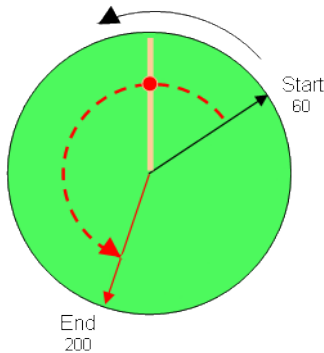

(see an example in row#4 of the table below)

Examples

Start Position	End Position	Direction of rotation	Cross Modulo	Position Input to MLAxisAbs (1)	RelativeDistance Moved (2)
60	200	clockwise	No	200	140 (i.e. 200 - 60 + 0)
60	30	clockwise	Yes	390	330 (i.e. 30 - 60 + 360)
60	30	counter clockwise	No	30	-30 (i.e. 30 - 60 - 0)
60	200	counter clockwise	Yes	-160	-220 (i.e. 200 - 60 - 360)

With:

(1) **Position Input** = End Position (+ Modulo * *Direction of rotation*)

(2) **Relative Distance Moved** = End Position - Start Position (+ Modulo * *Direction of rotation*)

Where:

Direction of rotation = 1 when clockwise and -1 when anti-clockwise

2.1.4.7 Travel Speed Update with MLAxisAbs

The travel speed of the generator can be updated using the function block "MLAxisGenWriteSpd" (→ p. 136). Depending on the state of the generator, this speed is directly reflected on the current move or a future move.

- If MLAxisAbs is not currently being executed, the new travel speed will be applied for the trajectory calculation for a future MLAxisAbs command.

- If MLAxisAbs is currently being executed and a new MLAxisAbs with the same target position is called, the new travel speed will be taken into account only if the current state of the TMP profile is the constant velocity or acceleration. If the axis was decelerating to stop at the goal position the new travel speed will not be taken into account.
- If a MLAxisAbs is currently being executed and a new MLAxisAbs with a different target position is called, the new travel speed is taken into account.

Following are several examples.

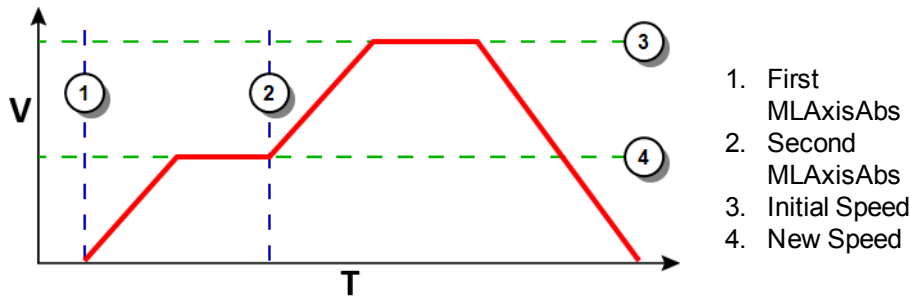

Figure 1-16: Initial speed is smaller than the new speed

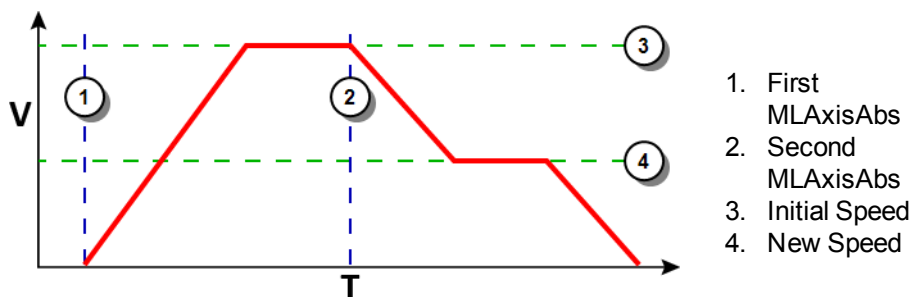

Figure 1-17: Initial speed is bigger than the new speed

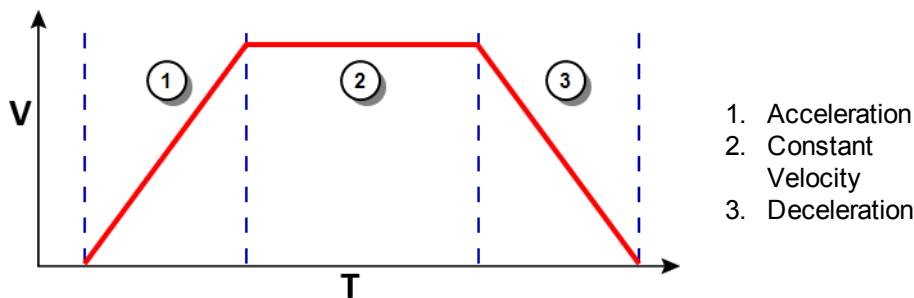

Figure 1-18: The speed update is taken into account only if the second MLAxisAbs is triggered during acceleration or constant velocity

2.1.4.8.1.1 Output

Default (.Q)	Description	Returns true when function successfully executes
	Data type	BOOL
	Unit	n/a

2.1.4.9.2 Related Functions

[MLAxisGenWriteSpd](#)

[MLAxisGenWriteDec](#)

[MLAxisGenWriteAcc](#)**2.1.4.10.3 Example**

See "Usage Example of Axis Functions" (→ p. 175) for additional examples.

2.1.4.11.4.1 Structured Text

```
MLAxisAbs ( PipeNetwork.Axis1, 2000 ) ;
```

2.1.4.12.5.2 Ladder Diagram**2.1.4.13.6.3 Function Block Diagram****2.1.4.14 MLAxisAdd** Pipe Network ✓**2.1.4.15.1 Description**

A selected Axis performs a move for a specified distance relative to the endpoint of the previous move. The DeltaPosition input is signed so that the move can be in the positive or negative direction, and the Axis moves this distance in user units. The travel speed, acceleration, deceleration, and User Units of the move are values inherited from the selected Axis. The default settings are entered when an Axis is created and initiated, and can be changed with other MLAxis commands such as [MLAxisGenWriteSpd](#), [MLAxisGenWriteAcc](#), and [MLAxisWriteUUnits](#).

2.1.4.16.2 Arguments**2.1.4.17.3.1 Input**

ID	Description	ID Name of the Axis block
	Data type	DINT
	Range	—
	Unit	n/a
	Default	—
DeltaPosition	Description	Sets the Axis Delta Position to add to the endpoint of the previous move
	Data type	LREAL

Range	—
Unit	User unit
Default	—

2.1.4.18.4.2 Output

Default (.Q)	Description	Returns true when function successfully executes, after the motion profile is complete
	Data type	BOOL
	Unit	n/a

2.1.4.19.5 Related Functions

[MLAxisGenWriteAcc](#)

[MLAxisGenWriteDec](#)

[MLAxisGenWriteSpd](#)

2.1.4.20.6 Example

2.1.4.21.7.1 Structured Text

```
MLAxisAdd(PipeNetwork.Axis1, LREAL#750.0 ) ;
```

2.1.4.22.8.2 Ladder Diagram

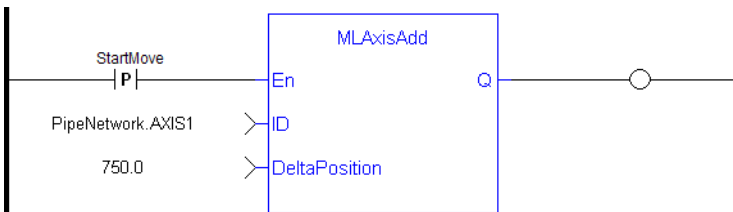

NOTE
You must use a [pulse contact](#) to start the FB

2.1.4.23.9.3 Function Block Diagram

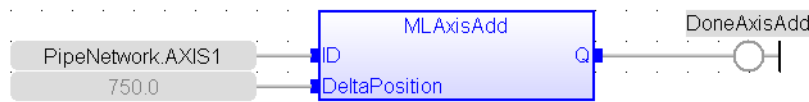

2.1.4.24 MLAxisAddress Pipe Network ✓

2.1.4.25.1 Description

Returns the motion bus address of the axis

2.1.4.26.2 Arguments

2.1.4.27.3.1 Input

ID	Description	ID name of the Axis Block
	Data type	DINT
	Range	—
	Unit	n/a
	Default	—

2.1.4.28.4.2 Output

OK	Description	Returns true when function successfully executes
	Data type	BOOL
	Unit	n/a
Default (.Q)	Description	Returns the motion bus address of the axis
	Data type	DINT
	Unit	n/a

2.1.4.29.5 Example

2.1.4.30.6.1 Structured Text

```
Axis1_Address := MAxisAddress (PipeNetwork.AXIS1);
```

2.1.4.31.7.2 Ladder Diagram

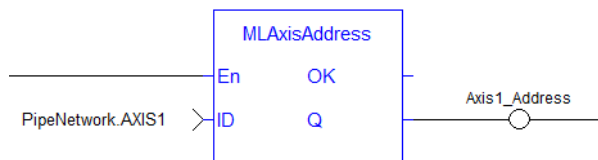

2.1.4.32.8.3 Function Block Diagram



2.1.4.33 MAxisAddTq Pipe Network ✓

2.1.4.34.1 Description

Allows the application to set the additive torque value to the drive output (Torque feed-forward). This function is only active after the "MAxisRatedTq" (→ p. 147) function has been invoked. Using the PDO, it also requires IL.KBUSFF value to be set to 1 in the drive.

2.1.4.35.2 Arguments

2.1.4.36.3.1 Input

ID	Description	Pipe network identifier of the axis block
-----------	--------------------	---

	Data type	DINT
	Range	—
	Unit	n/a
	Default	—
Torque	Description	Requested additive torque value in N.m (Newton meter).
	Data type	LREAL
	Unit	Rated torque units as used in the drive (i.e. rated motor continuous torque x the Torque factor).

2.1.4.37.4.2 Output

Default (.Q)	Description	Returns true when function successfully executes
	Data type	BOOL
	Unit	n/a

2.1.4.38.5 Related Functions

"MLAxisRatedTq" (→ p. 147)

2.1.4.39.6 Example

2.1.4.40.7.1 Structured Text

```
MLAxisAddTq(PipeNetwork.Axis1, LREAL#10 ) ;
```

2.1.4.41.8.2 Ladder Diagram

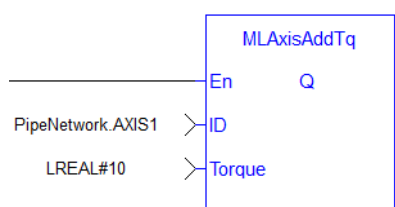

2.1.4.42.9.3 Function Block Diagram

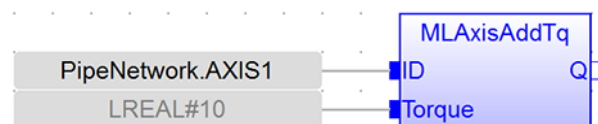

2.1.4.43 MLAxisCfgFastIn Pipe Network ✓

2.1.4.44.1 Description

Configures the Fast Input for the axis by writing the expected settings in the Latch Control Word. Fast input can be armed on falling or rising edge.

2.1.4.45.2 Arguments

2.1.4.46.3.1 Input

En	Description	Enables execution
	Data type	BOOL
	Unit	n/a
	Default	-
AxisID	Description	ID name of the Axis Block
	Data type	DINT
	Range	—
	Unit	n/a
	Default	—
InputID	Description	ID of the FastInput of an axis, (ie IN1 and IN2 on S300) 0 = Capture Engine 0 1 = Capture Engine 1 Range is [0, 1] For information on configuring the capture engines, refer to AKD Capture Engine Configuration.
	Data type	DINT
	Range	[0, 1]
	Unit	n/a
	Default	—
Mode	Description	Configures the Fast Inputs as 0= Disabled, 1=Rising Edge, 2=Falling edge
	Data type	DINT
	Range	[0, 2]
	Unit	n/a
	Default	—

2.1.4.47.4.2 Output

Q	Description	Returns true when the function successfully executes. Returns false if the fast input could not be configured due to an invalid PDO mapping in the .XML file.
	Data type	BOOL
	Unit	n/a

2.1.4.48.5 Related Functions

[MLAxisIsTriggered](#)

[MLAxisRstFastIn](#)

2.1.4.49.6 See Also

- Fast Inputs with Pipe Network Motion
- Fast Inputs with PLCOpen
- Fast Homing Example with the Pipe Network Motion Engine Axis Pipe Block
- Fast Homing Example with the PLCOpen Motion Engine
- Pipe Network Registration and Fast Homing
- Registration Position Capture Example with Pipe Network Trigger Block

2.1.4.50.7 Example

2.1.4.51.8.1 Structured Text

```
MLAxisCfgFastIn ( PipeNetwork.Axis1, 0, 1 ) ;
```

2.1.4.52.9.2 Ladder Diagram

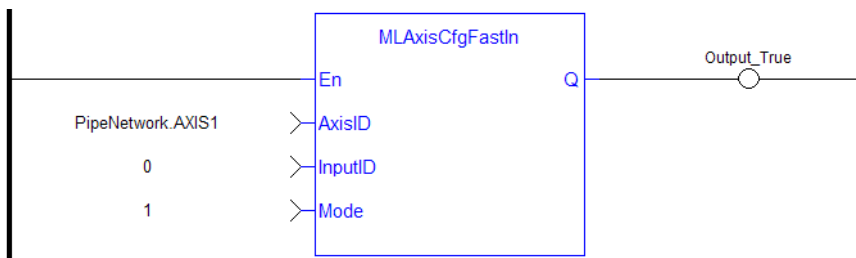

2.1.4.53.10.3 Function Block Diagram



See also "Fast inputs" for more details.

2.1.4.54 MLAxisCmdPos Pipe Network ✓

2.1.4.55.1 Description

Returns the reference position of the axis.

2.1.4.56.2 Arguments

2.1.4.57.3.1 Input

ID	Description	ID Name of the Axis block
	Data type	DINT
	Range	—
	Unit	n/a
	Default	—

2.1.4.58.4.2 Output

OK	Description	Returns true when function successfully executes
	Data type	BOOL
	Unit	n/a
Position	Description	Returns the Axis reference position
	Data type	LREAL
	Unit	User unit

2.1.4.59.5 Related Functions

[MLAxisReadActPos](#)

[MLAxisFBackPos](#)

[MLAxisGenPos](#)

[MLAxisPipePos](#)

[MLAxisWritePipPos](#)

2.1.4.60.6 Previous Function Name

MLAxisRefPos

2.1.4.61.7 Example

2.1.4.62.8.1 Structured Text

```
Axis1_ReferencePosition := MLAxisCmdPos (PipeNetwork.AXIS1);
```

2.1.4.63.9.2 Ladder Diagram

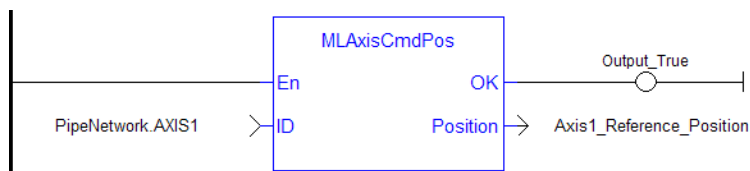

2.1.4.64.10.3 Function Block Diagram



2.1.4.65 MLAxisCreate Pipe Network ✓

2.1.4.66.1 Description

Creates a new axis object. Returns the ID of the newly created axis object or 0 if the function failed

TIP

This function must be called or executed before "MLMotionStart" (→ p. 474) is called.

2.1.4.67.2 Arguments

2.1.4.68.3.1 Input

Name	Description	Name of the created Axis
	Data type	STRING
	Range	—
	Unit	n/a
	Default	—
DriverName	Description	Is the Motion bus driver name or Simulated
	Data type	STRING
	Range	—
	Unit	n/a
	Default	—
Address	Description	Axis motion bus address
	Data type	DINT
	Range	—
	Unit	n/a
	Default	—
ID	Description	ID name of the Axis Block
	Data type	DINT
	Range	—
	Unit	n/a
	Default	—

2.1.4.69.4.2 Output

OK	Description	Returns true when function successfully executes
	Data type	BOOL
	Unit	n/a

2.1.4.70.5 Example

2.1.4.71.6.1 Structured Text

```
PipeNetwork.AXIS1 := MLCAxisCreate('AXIS1', 'SercosDriver',
1001);
```

2.1.4.72.7.2 Ladder Diagram

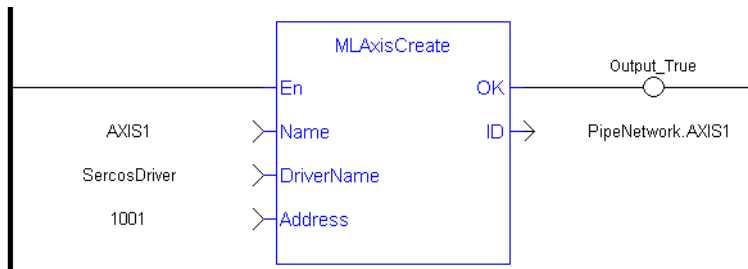

2.1.4.73.8.3 Function Block Diagram

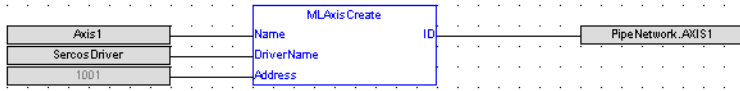

2.1.4.74 MAxisFBackPos Pipe Network ✓

2.1.4.75.1 Description

Returns the Feedback Position of the axis

2.1.4.76.2 Arguments

2.1.4.77.3.1 Input

ID	Description	ID name of the Axis Block
	Data type	DINT
	Range	—
	Unit	n/a
	Default	—

2.1.4.78.4.2 Output

OK	Description	Returns true when function successfully executes
	Data type	BOOL
	Unit	n/a
Position	Description	Returns the Feedback Position of the axis
	Data type	LREAL
	Unit	User unit

2.1.4.79.5 Related Functions

[MLAxisReadActPos](#)

[MLAxisGenPos](#)

[MLAxisPipePos](#)

[MLAxisCmdPos](#)

[MLAxisWritePipPos](#)

2.1.4.80.6 Example

2.1.4.81.7.1 Structured Text

```
Axis1_Position := MAxisFBackPos( PipeNetwork.Axis1 ) ;
```

2.1.4.82.8.2 Ladder Diagram



2.1.4.83.9.3 Function Block Diagram

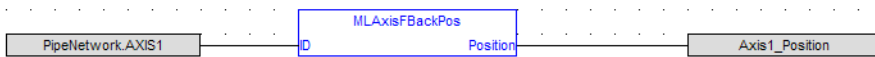

2.1.4.84 MAxisGenEN Pipe Network ✓

2.1.4.85.1 Description

Enables or disables the internal TMP generator of the axis.

2.1.4.86.2 Arguments

2.1.4.87.3.1 Input

ID	Description	ID Name of the Axis block
	Data type	DINT
	Range	—
	Unit	n/a
	Default	—
Enable	Description	Boolean switch to activate the generator
	Data type	BOOL
	Range	0, 1
	Unit	n/a
	Default	—

2.1.4.88.4.2 Output

Default (.Q)	Description	Returns true when function successfully executes
	Data type	BOOL
	Unit	n/a

2.1.4.89.5 Related Functions

[MLAxisGenIsEN](#)**2.1.4.90.6 Example****2.1.4.91.7.1 Structured Text**

```
MLAxisGenEN( PipeNetwork.Axis1, true) ;
```

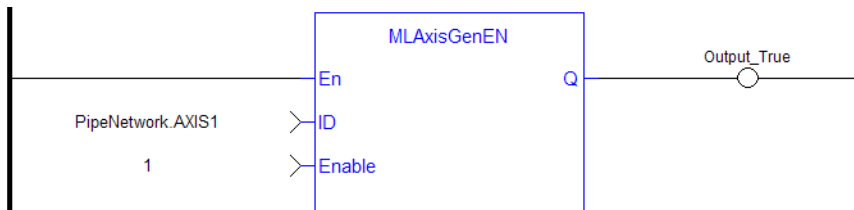
2.1.4.92.8.2 Ladder Diagram**2.1.4.93.9.3 Function Block Diagram****2.1.4.94 MLAxisGenIsEN** Pipe Network ✓**2.1.4.95.1 Description**

Check if the internal TMP generator of the axis is enable. Returns TRUE if the internal generator is enabled.

2.1.4.96.2 Arguments**2.1.4.97.3.1 Input**

ID	Description	ID Name of the Axis block
	Data type	DINT
	Range	—
	Unit	n/a
	Default	—

2.1.4.98.4.2 Output

Default (.Q)	Description	Returns true when function successfully executes
	Data type	BOOL
	Unit	n/a

2.1.4.99.5 Related Functions[MLAxisGenIsRdy](#)**2.1.4.100.6 Example**

2.1.4.101.7.1 Structured Text

```
MLAxisGenIsEN(PipeNetwork.Axis1 ) ;
```

2.1.4.102.8.2 Ladder Diagram

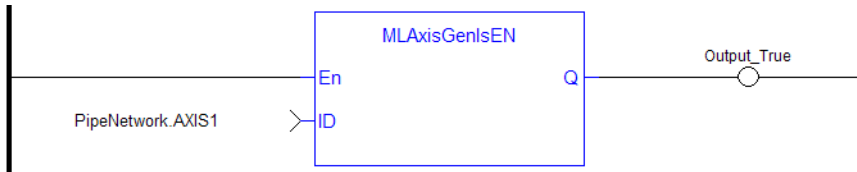

2.1.4.103.9.3 Function Block Diagram



2.1.4.104 MLAxisGenIsRdy Pipe Network ✓

2.1.4.105.1 Description

Check if an axis is ready. Returns TRUE if the internal generator axis is ready.

2.1.4.106.2 Arguments

2.1.4.107.3.1 Input

ID	Description	ID Name of the Axis block
	Data type	DINT
	Range	—
	Unit	n/a
	Default	—

2.1.4.108.4.2 Output

Default (.Q)	Description	Returns true when function successfully executes
	Data type	BOOL
	Unit	n/a

2.1.4.109.5 Related Functions

[MLAxisGenIsEN](#)

[MLAxisStatus](#)

2.1.4.110.6 Example

See "Usage Example of Axis Functions" (→ p. 175) for additional examples.

2.1.4.111.7.1 Structured Text

```
MLAxisGenIsRdy (PipeNetwork.Axis1 );
```

2.1.4.112.8.2 Ladder Diagram



2.1.4.113.9.3 Function Block Diagram



2.1.4.114 MLAxisGenPos Pipe Network ✓

2.1.4.115.1 Description

Returns the generator position of the axis Returns TRUE if the internal generator axis is ready.

2.1.4.116.2 Arguments

2.1.4.117.3.1 Input

ID	Description	ID Name of the Axis block
	Data type	DINT
	Range	—
	Unit	n/a
	Default	—

2.1.4.118.4.2 Output

Default (.Q)	Description	Returns true when function successfully executes
	Data type	BOOL
	Unit	n/a
Position	Description	Returns Axis generator position value
	Data type	LREAL
	Unit	User unit

2.1.4.119.5 Related Functions

[MLAxisReadActPos](#)

[MLAxisFBackPos](#)

[MLAxisPipePos](#)

[MLAxisCmdPos](#)

[MLAxisWritePipPos](#)

2.1.4.120.6 Example

2.1.4.121.7.1 Structured Text

```
Axis1_Generator_Position := MLAxisGenPos (PipeNetwork.Axis1 ) ;
```

2.1.4.122.8.2 Ladder Diagram



2.1.4.123.9.3 Function Block Diagram



2.1.4.124 MLAxisGenReadAcc Pipe Network ✓

2.1.4.125.1 Description

Get the acceleration of the internal generator of an axis.

2.1.4.126.2 Arguments

2.1.4.127.3.1 Input

AxisID	Description	ID Name of the Axis block
	Data type	DINT
	Range	—
	Unit	n/a
	Default	—

2.1.4.128.4.2 Output

OK	Description	Returns true when function successfully executes
	Data type	BOOL
	Unit	n/a
Acceleration	Description	Returns Axis Acceleration value
	Data type	LREAL

Unit [User unit/sec²](#)

2.1.4.129.5 Related Functions

[MLAxisGenReadDec](#)

[MLAxisGenReadSpd](#)

2.1.4.130.6 Example

2.1.4.131.7.1 Structured Text

```
Axis1_Acceleration := MLAxisGenReadAcc ( PipeNetwork.Axis1 );
```

2.1.4.132.8.2 Ladder Diagram



2.1.4.133.9.3 Function Block Diagram



2.1.4.134 MLAxisGenReadDec Pipe Network ✓

2.1.4.135.1 Description

Get the Deceleration of the internal generator of an axis.

2.1.4.136.2 Arguments

2.1.4.137.3.1 Input

AxisID	Description	ID Name of the Axis block
	Data type	DINT
	Range	—
	Unit	n/a
	Default	—

2.1.4.138.4.2 Output

OK	Description	
	Data type	BOOL
	Unit	n/a

Deceleration	Description	Returns Axis Deceleration value
	Data type	LREAL
	Unit	<u>User unit</u> /sec ²

2.1.4.139.5 Related Functions

[MLAxisGenReadAcc](#)

[MLAxisGenReadSpd](#)

2.1.4.140.6 Example

2.1.4.141.7.1 Structured Text

```
Axis1_Deceleration := MLAxisGenReadDec ( PipeNetwork.Axis1 );
```

2.1.4.142.8.2 Ladder Diagram



2.1.4.143.9.3 Function Block Diagram

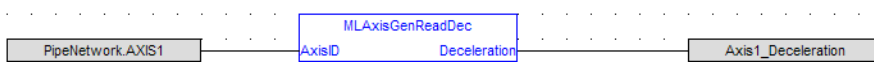

2.1.4.144 MLAxisGenReadSpd Pipe Network ✓

2.1.4.145.1 Description

Get the speed of the internal generator of an axis.

2.1.4.146.2 Arguments

2.1.4.147.3.1 Input

AxisID	Description	ID Name of the Axis block
	Data type	DINT
	Range	—
	Unit	n/a
	Default	—

2.1.4.148.4.2 Output

OK	Description
-----------	--------------------

	Data type	BOOL
	Unit	n/a
Speed	Description	Returns Axis Speed value
	Data type	LREAL
	Unit	User unit/sec

2.1.4.149.5 Related Functions

[MLAxisGenReadDec](#)

[MLAxisGenReadAcc](#)

2.1.4.150.6 Example

2.1.4.151.7.1 Structured Text

```
Axis1_Speed := MLAxisGenReadSpd( PipeNetwork.Axis1 ) ;
```

2.1.4.152.8.2 Ladder Diagram



2.1.4.153.9.3 Function Block Diagram



2.1.4.154 MLAxisGenWriteAcc Pipe Network ✓

2.1.4.155.1 Description

Set the acceleration of the internal generator of an axis Returns TRUE if the internal generator axis is ready.

2.1.4.156.2 Arguments

2.1.4.157.3.1 Input

AxisID	Description	ID Name of the Axis block
	Data type	DINT
	Range	—
	Unit	n/a
	Default	—

Acceleration	Description	Sets the generator Acceleration value
	Data type	LREAL
	Range	—
	Unit	User unit /sec ²
	Default	—

2.1.4.158.4.2 Output

Default (.Q)	Description	Returns true when function successfully executes
	Data type	BOOL
	Unit	n/a

2.1.4.159.5 Related Functions

[MLAxisGenWriteDec](#)

[MLAxisGenWriteSpd](#)

2.1.4.160.6 Example

2.1.4.161.7.1 Structured Text

```
MLAxisGenWriteAcc(PipeNetwork.Axis1, 100000 ) ;
```

2.1.4.162.8.2 Ladder Diagram

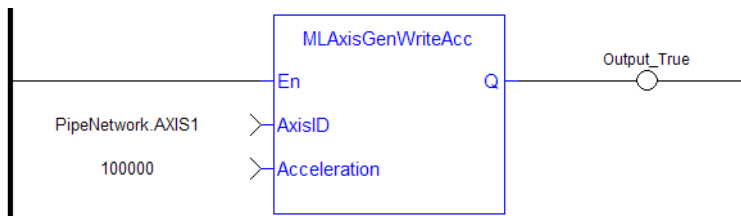

2.1.4.163.9.3 Function Block Diagram



2.1.4.164 MLAxisGenWriteDec Pipe Network ✓

2.1.4.165.1 Description

Set the Deceleration of the internal generator of an axis Returns TRUE if the internal generator axis is ready.

2.1.4.166.2 Arguments

2.1.4.167.3.1 Input

AxisID	Description	ID Name of the Axis block
	Data type	DINT
	Range	—
	Unit	n/a
	Default	—
Deceleration	Description	<p>Sets the generator Deceleration value.</p> <p>The axis deceleration rate is limited such that the velocity cannot change by more than the value of the declared velocity limit in a single iteration.</p> <p>The Pipe Network Axis block uses the TRAVEL_SPEED parameter to scale this limit. The maximum deceleration is therefore affected by the Pipe Network Axis Block parameter “TRAVEL_SPEED”, as well as the axis update rate.</p>
	Data type	LREAL
	Range	—
	Unit	User unit/sec²
	Default	—

2.1.4.168.4.2 Output

Default (.Q)	Description	Returns true when function successfully executes
	Data type	BOOL
	Unit	n/a

2.1.4.169.5 Related Functions

[MLAxisGenWriteAcc](#)

[MLAxisGenWriteSpd](#)

2.1.4.170.6 Example

2.1.4.171.7.1 Structured Text

```
MLAxisGenWriteDec(PipeNetwork.Axis1, 100000 ) ;
```

2.1.4.172.8.2 Ladder Diagram

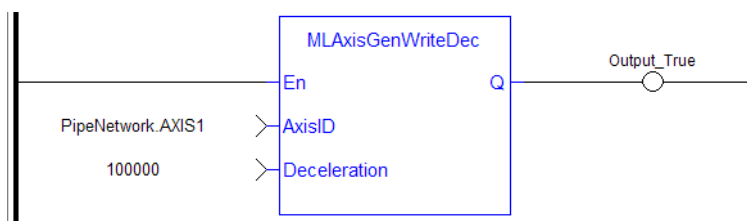

2.1.4.173.9.3 Function Block Diagram



2.1.4.174 MLAxisGenWriteSpd Pipe Network ✓

2.1.4.175.1 Description

Set the speed of the internal generator of an axis. Returns TRUE if the function succeeded. This function does not generate any motion.

2.1.4.176.2 Arguments

2.1.4.177.3.1 Input

AxisID	Description	ID Name of the Axis block
	Data type	DINT
	Range	—
	Unit	n/a
	Default	—
Speed	Description	Sets the generator Speed value
	Data type	LREAL
	Range	—
	Unit	User unit
	Default	—

2.1.4.178.4.2 Output

Default (.Q)	Description	Returns true when function successfully executes
	Data type	BOOL
	Unit	n/a

2.1.4.179.5 Related Functions

[MLAxisGenWriteAcc](#)

[MLAxisGenWriteDec](#)

2.1.4.180.6 Example

2.1.4.181.7.1 Structured Text

```
MLAxisGenWriteSpd(PipeNetwork.Axis1, 500 ) ;
```

2.1.4.182.8.2 Ladder Diagram

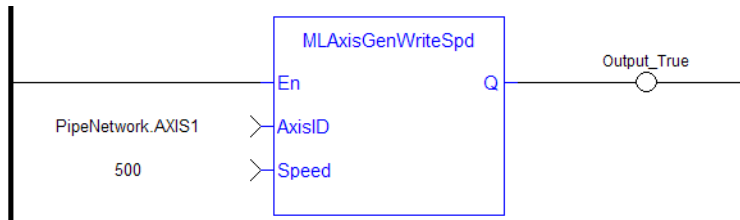

2.1.4.183.9.3 Function Block Diagram



2.1.4.184 MLAxisInit Pipe Network ✓

2.1.4.185.1 Description

Initializes an axis object. Returns TRUE if the function succeeded

2.1.4.186.2 Arguments

2.1.4.187.3.1 Input

AxisID	Description	ID Name of the Axis block
	Data type	DINT
	Range	—
	Unit	n/a
	Default	—
ModuloPosition	Description	Value of the period of a cyclic system expressed in user units. The parameter is defined to correctly manage the periodicity (modulo) of the input values
	Data type	LREAL
	Range	—
	Unit	User unit
	Default	—
UserUnitPerTurn	Description	Define the unit which is equivalent to one revolution of the physical motor
	Data type	LREAL
	Range	—
	Unit	n/a
	Default	—

FeedbackUnitPerTurn	Description	
	Data type	DINT
	Range	—
	Unit	n/a
	Default	—
Speed	Description	Sets the Axis Speed
	Data type	LREAL
	Range	—
	Unit	User unit
	Default	—
Acceleration	Description	Sets the Axis Acceleration value
	Data type	LREAL
	Range	—
	Unit	User unit /sec ²
	Default	—
Deceleration	Description	Sets the Axis Deceleration value
	Data type	LREAL
	Range	—
	Unit	User unit /sec ²
	Default	—
InitialPosition	Description	Initial position value expressed in user logical units. Used only at the pipe activation to initialize the position starting point
	Data type	LREAL
	Range	—
	Unit	User unit
	Default	—
Modulo	Description	Define the mode which can be Modulo (True) or not (False)
	Data type	BOOL
	Range	0, 1

Unit	n/a
Default	—

2.1.4.188.4.2 Output

Default (.Q)	Description	Returns true when function successfully executes
	Data type	BOOL
	Unit	n/a

2.1.4.189.5 Example

2.1.4.190.6.1 Structured Text

```
MLAxisInit( PipeNetwork.Axis1, 360.0, 360.0, SHL(1,20), 500.0,
100000.0, 100000.0, 0.0, true ) ;
```

2.1.4.191.7.2 Ladder Diagram

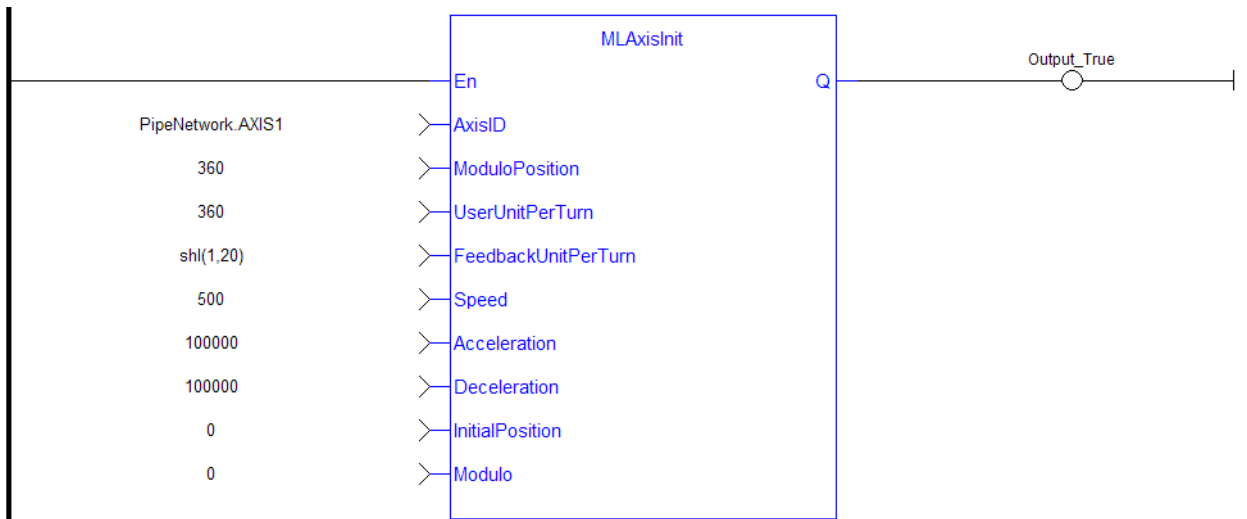

2.1.4.192.8.3 Function Block Diagram

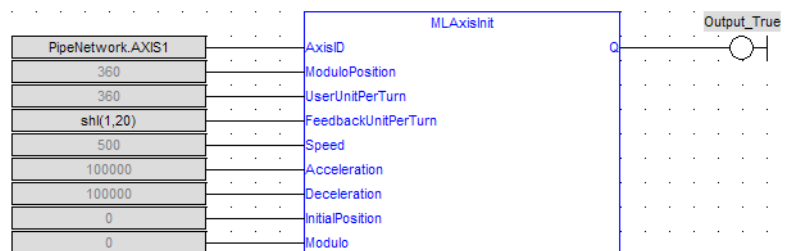

2.1.4.193 MLAxisIsCnctd Pipe Network ✓

2.1.4.194.1 Description

Check if a pipe is currently connected to the axis. Returns TRUE if a pipe is connected.

2.1.4.195.2 Arguments

2.1.4.196.3.1 Input

ID	Description	ID Name of the Axis block
	Data type	DINT
	Range	—
	Unit	n/a
	Default	—

2.1.4.197.4.2 Output

Default (.Q)	Description	Returns true when function successfully executes
	Data type	BOOL
	Unit	n/a

2.1.4.198.5 Example

2.1.4.199.6.1 Structured Text

```
MLAxisIsCnctd (PipeNetwork.Axis1 ) ;
```

2.1.4.200.7.2 Ladder Diagram

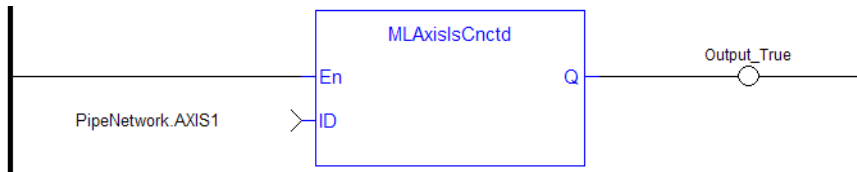

2.1.4.201.8.3 Function Block Diagram



2.1.4.202 MLAxisIsTriggered Pipe Network ✓

2.1.4.203.1 Description

Checks if the axis got a trigger event. Returns TRUE if the Fast Input event has been **triggered** and not yet been reset. MLAxisCfgFastIn

2.1.4.204.2 Arguments

2.1.4.205.3.1 Input

ID	Description	ID Name of the Axis block
	Data type	DINT

	Range	—
	Unit	n/a
	Default	—
InputID	Description	ID of the triggered Fast input of an axis (ie IN1 and IN2 on S300) 0 = Capture Engine 0 1 = Capture Engine 1 Range is [0, 1] For information on configuring the capture engines, refer to AKD Capture Engine Configuration.
	Data type	DINT
	Range	—
	Unit	n/a
	Default	—
edge	Description	Configures the Inputs as 0= Disabled, 1=Rising Edge, 2=Falling edge
	Data type	DINT
	Range	—
	Unit	n/a
	Default	—

2.1.4.206.4.2 Output

Default (.Q)	Description	Returns true when function successfully executes
	Data type	BOOL
	Unit	n/a

2.1.4.207.5 Related Functions

[MLAxisRstFastIn](#)

2.1.4.208.6 Example

2.1.4.209.7.1 Structured Text

```
MLAxisIsTriggered (PipeNetwork.Axis1, 0,1 ) ;
```

2.1.4.210.8.2 Ladder Diagram

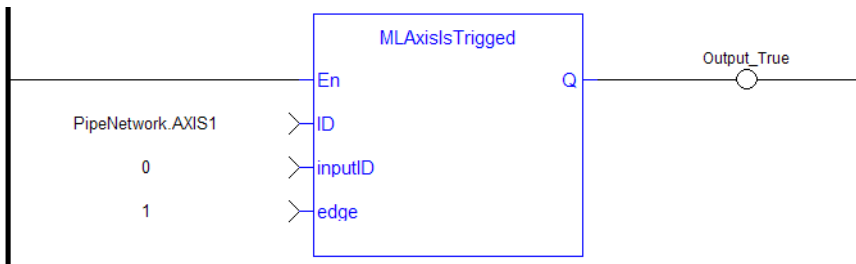

2.1.4.211.9.3 Function Block Diagram



2.1.4.212 MAxisMoveVel Pipe Network ✓

2.1.4.213.1 Description

Jog at the specified speed. Returns TRUE if the function succeeded

2.1.4.214.2 Arguments

2.1.4.215.3.1 Input

ID	Description	ID Name of the Axis block
	Data type	DINT
	Range	—
	Unit	n/a
	Default	—
Speed	Description	Sets the Axis Speed
	Data type	LREAL
	Range	—
	Unit	User unit /sec
	Default	—

2.1.4.216.4.2 Output

Default (.Q)	Description	Returns true when function successfully executes, after the motion has reached jog speed
	Data type	BOOL
	Unit	n/a

2.1.4.217.5 Related Functions

[MAxisGenWriteSpd](#)

[MLAxisGenWriteDec](#)

[MLAxisGenWriteAcc](#)

2.1.4.218.6 Previous Function Name

MLAxisRun

2.1.4.219.7 Example

See "Usage Example of Axis Functions" (→ p. 175) for additional examples.

2.1.4.220.8.1 Structured Text

```
MLAxisMoveVel (PipeNetwork.Axis1, 500 ) ;
```

2.1.4.221.9.2 Ladder Diagram

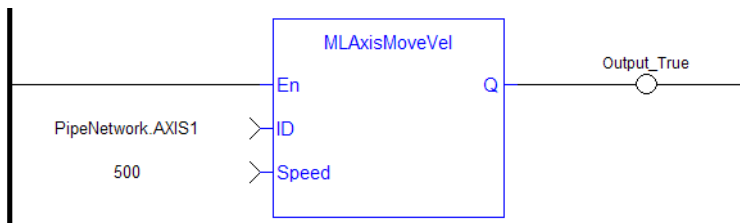

2.1.4.222.10.3 Function Block Diagram



2.1.4.223 MLAxisPipePos Pipe Network ✓

2.1.4.224.1 Description

Returns the pipe position of the axis.

2.1.4.225.2 Arguments

2.1.4.226.3.1 Input

ID	Description	ID Name of the Axis block
	Data type	DINT
	Range	[-2147483648, 2147483648]
	Unit	n/a
	Default	—

2.1.4.227.4.2 Output

OK	Description	Returns true when function successfully executes
-----------	--------------------	--

	Data type	BOOL
	Unit	n/a
Position	Description	
	Data type	LREAL
	Range	—
	Unit	User unit

2.1.4.228.5 Related Functions

[MLAxisReadActPos](#)

[MLAxisFBackPos](#)

[MLAxisGenPos](#)

[MLAxisCmdPos](#)

[MLAxisWritePipPos](#)

2.1.4.229.6 Example

2.1.4.230.7.1 Structured Text

```
Axis1_Pipe_Position := MLAxisPipePos (PipeNetwork.Axis1 ) ;
```

2.1.4.231.8.2 Ladder Diagram



2.1.4.232.9.3 Function Block Diagram

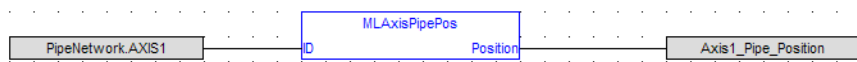

2.1.4.233 MLAxisPower Pipe Network ✓

2.1.4.234.1 Description

Powers up or down the axis. Enable or disabled Axis Servo Drive.

When the axis is powered up, the **ReferencePosition** is modified to equal the **ActualPosition**. For that, KAS updates the **GeneratorPosition**.

2.1.4.235.2 Arguments

2.1.4.236.3.1 Input

ID	Description	ID Name of the Axis block
-----------	--------------------	---------------------------

	Data type	DINT
	Range	—
	Unit	n/a
	Default	—
On	Description	Flag to power up (True) or down (False) the Axis
	Data type	BOOL
	Range	0, 1
	Unit	n/a
	Default	—

2.1.4.237.4.2 Output

Default (.Q)	Description	Returns true when function successfully executes
	Data type	BOOL
	Unit	n/a

2.1.4.238.5 Related Functions

[MLAxisPowerDOff](#)

2.1.4.239.6 Previous Function Name

MLAxisPowerOn

MLAxisPowerOff

2.1.4.240.7 Example

2.1.4.241.8.1 Structured Text

```
(* If Power_OnOff is TRUE then power in ON, otherwise OFF*)
MLAxisPower( PipeNetwork.Axis1, Power_OnOff) ;
```

2.1.4.242.9.2 Ladder Diagram

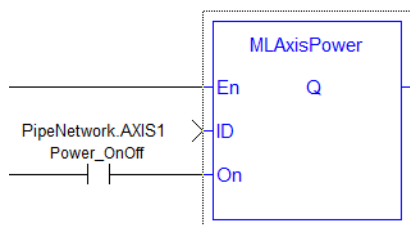

2.1.4.243.10.3 Function Block Diagram



2.1.4.244 MLAxisPowerDOff Pipe Network ✓

2.1.4.245.1 Description

Returns the adjustment of position done by the last power on to avoid bumps

2.1.4.246.2 Arguments

2.1.4.247.3.1 Input

ID	Description	ID Name of the Axis block
	Data type	DINT
	Range	—
	Unit	n/a
	Default	—

2.1.4.248.4.2 Output

Default (.Q)	Description	Returns true when function successfully executes
	Data type	BOOL
	Unit	n/a
PowerONDeltaOffset	Description	
	Data type	LREAL
	Unit	User unit

2.1.4.249.5 Related Functions

[MLAxisPower](#)

2.1.4.250.6 Example

2.1.4.251.7.1 Structured Text

```
Axis1_Power_On_Delta_Offset := MLAxisPowerDOff
(PipeNetwork.Axis1 ) ;
```

2.1.4.252.8.2 Ladder Diagram



2.1.4.253.9.3 Function Block Diagram

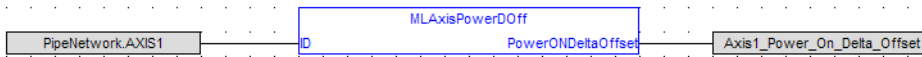

2.1.4.254 MLAxisRatedTq Pipe Network ✓

2.1.4.255.1 Description

Allows conversion of drive torque values from rated torque units (1000 = rated motor continuous torque) to N.m (Newton meter).

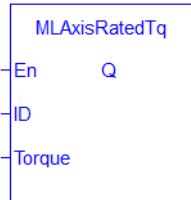

2.1.4.256.2 Arguments

2.1.4.257.3.1 Input

ID	Description	Pipe network identifier of the axis block
	Data type	DINT
	Range	—
	Unit	n/a
	Default	—
Torque	Description	<p>Actual torque applied by the drive associated to the axis</p> <p>Rated torque = Nominal Drive Current * Torque factor = DRV.ICONT * MOTOR.KT</p> <p>About SDO</p> <p>DRV.ICONT is obtained by SDO parameter: index 5083h (sub-index 0)</p> <p>MOTOR.KT is obtained by SDO parameter: index 3593h (sub-index 0)</p> <p>For more details, refer to:</p> <ul style="list-style-type: none"> • Communication SDOs • Manufacturer specific SDOs • Profile specific SDOs <p>To read/write an SDO object with an index greater than 16#7FFF (32767), the value must be entered in the form <code>any_to_int(index # in hex format)</code>. For example <code>any_to_int(16#8321)</code>.</p> <p>The actual units of DRV.ICONT and MOTOR.KT are 1/1000 of the actual values if obtained by SDO. So the formula, if using the SDO values, is:</p> <p>Rated Torque = Torque = (SDO(DRV.ICONT)/1000) * (SDO(MOTOR.KT)/1000)</p>

Data type	LREAL
Unit	N.m (Newton meter)

2.1.4.258.4.2 Output

Default (.Q)	Description	Returns true when function successfully executes
	Data type	BOOL
	Unit	n/a

2.1.4.259.5 Related Functions

[MLAxisReadTq](#)

2.1.4.260.6 Example

2.1.4.261.7.1 Structured Text

```
MLAxisRatedTq(PipeNetwork.Axis1, Axis1_Torque ) ;
```

2.1.4.262.8.2 Ladder Diagram

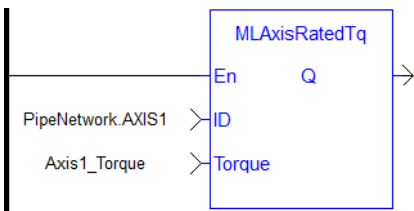

2.1.4.263.9.3 Function Block Diagram

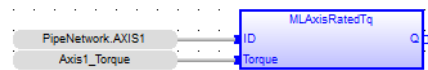

2.1.4.264 MLAxisRead2ndFB Pipe Network ✓

2.1.4.265.1 Description

Return the position given by the secondary feedback device of the drive mapped to the specified axis.

2.1.4.266.2 Arguments

2.1.4.267.3.1 Input

ID	Description	Pipe network identifier of the axis block
	Data type	DINT
	Range	—
	Unit	n/a
	Default	—

2.1.4.268.4.2 Output

Position	Description	Position value returned by the secondary feedback
	Data type	LREAL
	Unit	User unit

2.1.4.269.5 Related Functions

[MLAxisReadActPos](#)

2.1.4.270.6 Example

2.1.4.271.7.1 Structured Text

```
Axis1_Position := MLAxisRead2ndFB ( PipeNetwork.Axis1 ) ;
```

2.1.4.272.8.2 Ladder Diagram



2.1.4.273.9.3 Function Block Diagram



2.1.4.274 MLAxisReadActPos Pipe Network ✓

2.1.4.275.1 Description

Returns the Actual Position of the axis

2.1.4.276.2 Arguments

2.1.4.277.3.1 Input

ID	Description	ID name of the Axis Block
	Data type	DINT
	Range	—
	Unit	n/a
	Default	—

2.1.4.278.4.2 Output

Default (.Q)	Description	Returns true when function successfully executes
	Data type	BOOL

	Unit	n/a
Position	Description	Returns the absolute position of the axis
	Data type	LREAL
	Unit	User unit

2.1.4.279.5 Related Functions

[MLAxisFBackPos](#)

[MLAxisGenPos](#)

[MLAxisPipePos](#)

[MLAxisCmdPos](#)

[MLAxisWritePipPos](#)

2.1.4.280.6 Previous Function Name

MLAxisActualPos

2.1.4.281.7 Example

2.1.4.282.8.1 Structured Text

```
Axis1_Position := MLAxisReadActPos( PipeNetwork.Axis1 ) ;
```

2.1.4.283.9.2 Ladder Diagram

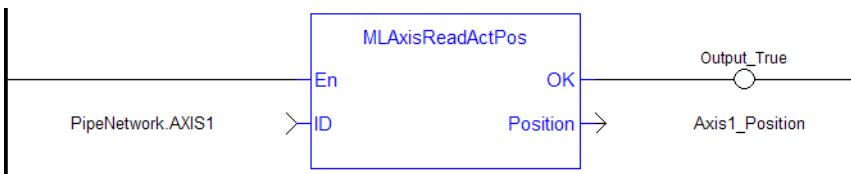

2.1.4.284.10.3 Function Block Diagram



2.1.4.285 MLAxisReadFBUnit Pipe Network ✓

2.1.4.286.1 Description

Get the feedback units per revolution value of the axis

2.1.4.287.2 Arguments

2.1.4.288.3.1 Input

AxisID	Description	ID Name of the Axis block
	Data type	DINT
	Range	—

Unit	n/a
Default	—

2.1.4.289.4.2 Output

OK	Description	Returns true when function successfully executes
	Data type	BOOL
	Unit	n/a
FBUUnitsPerRev	Description	Returns the Axis Feedback Units per revolution
	Data type	LREAL
	Unit	n/a

2.1.4.290.5 Example

2.1.4.291.6.1 Structured Text

```
Axis1_Feedback_Units := MAxisReadFBUnit (PipeNetwork.Axis1 ) ;
```

2.1.4.292.7.2 Ladder Diagram



2.1.4.293.8.3 Function Block Diagram

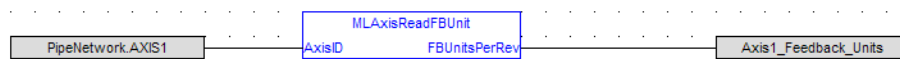

2.1.4.294 MAxisReadFEUU Pipe Network ✓

2.1.4.295.1 Description

Return the difference between the reference position and the actual position of the drive mapped to the specified axis

2.1.4.296.2 Arguments

2.1.4.297.3.1 Input

ID	Description	Pipe network identifier of the axis block
	Data type	DINT
	Range	—
	Unit	n/a

Default	—
----------------	---

2.1.4.298.4.2 Output

Error	Description	Difference between the reference position and the actual position of the drive associated to the axis
	Data type	LREAL
	Unit	User unit

2.1.4.299.5 Related Functions

[MLAxisReadActPos](#)

[ECATGetStatus](#)

2.1.4.300.6 Example

2.1.4.301.7.1 Structured Text

```
Axis1_Error := MLAxisReadFEUU(PipeNetwork.Axis1 ) ;
```

2.1.4.302.8.2 Ladder Diagram

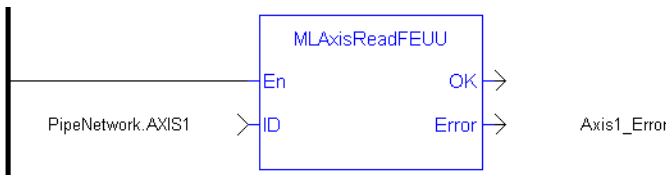

2.1.4.303.9.3 Function Block Diagram



2.1.4.304 MLAxisReadGenStatus Pipe Network ✓

2.1.4.305.1 Description

Returns the status of the internal generator of the axis.

0	RUN mode (acceleration)
1	RUNNING or STOPPED
2	MOVE: Changing move destination
3	MOVE: Changing move destination
4	MOVE: Acceleration
5	MOVE: Constant speed (travel speed)
6	MOVE: Deceleration
7	MOVE: Single step (micro movement)

2.1.4.306.2 Arguments

2.1.4.307.3.1 Input

ID	Description	ID Name of the Axis block
	Data type	DINT
	Range	—
	Unit	n/a
	Default	—

2.1.4.308.4.2 Output

OK	Description	Returns true when function successfully executes
	Data type	BOOL
	Unit	n/a
Default (.Q)	Description	Shows the status of the internal generator based on the table at the top of this topic
	Data type	DINT
	Unit	n/a

2.1.4.309.5 Related Functions

[MLAxisGenIsRdy](#)

[MLAxisStatus](#)

2.1.4.310.6 Previous Function Name

MLAxisGenStatus

2.1.4.311.7 Example

2.1.4.312.8.1 Structured Text

```
MLAxisReadGenStatus (PipeNetwork.Axis1 ) ;
```

2.1.4.313.9.2 Ladder Diagram



2.1.4.314.10.3 Function Block Diagram



2.1.4.315 MLAxisReadModPos Pipe Network ✓

2.1.4.316.1 Description

Get the value period of the axis.

2.1.4.317.2 Arguments

2.1.4.318.3.1 Input

AxisID	Description	ID Name of the Axis block
	Data type	DINT
	Range	—
	Unit	n/a
	Default	—

2.1.4.319.4.2 Output

OK	Description	Returns true when function successfully executes
	Data type	BOOL
	Unit	n/a
ModuloPosition	Description	Returns the Axis Value Period
	Data type	LREAL
	Unit	User unit

2.1.4.320.5 Example

2.1.4.321.6.1 Structured Text

```
Axis1_Value_Period := MAxisReadModPos (PipeNetwork.Axis1 ) ;
```

2.1.4.322.7.2 Ladder Diagram



2.1.4.323.8.3 Function Block Diagram



2.1.4.324 MAxisReadTq Pipe Network ✓

2.1.4.325.1 Description

Return the actual torque applied by the drive which is mapped to the specified axis.



2.1.4.326.2 Arguments

2.1.4.327.3.1 Input

ID	Description	Pipe network identifier of the axis block
	Data type	DINT
	Range	—
	Unit	n/a
	Default	—

2.1.4.328.4.2 Output

Torque	Description	Actual torque applied by the drive associated to the axis in N.m (Newton meter). If you have not previously invoked the "MLAxisRatedTq" (→ p. 147) function, the Output value is rated motor continuous torque (where 1000.0 = rated torque)
	Data type	LREAL
	Unit	N.m (Newton meter)

2.1.4.329.5 Related Functions

[MLAxisRatedTq](#)

[MLAxisReadActPos](#)

[MLAxisReadVel](#)

2.1.4.330.6 Example

2.1.4.331.7.1 Structured Text

```
Axis1_Torque := MLAxisReadTq(PipeNetwork.Axis1 ) ;
```

2.1.4.332.8.2 Ladder Diagram

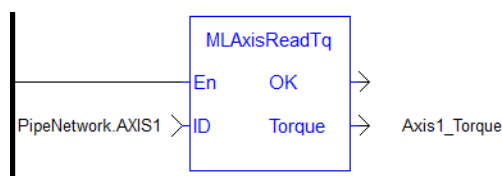

2.1.4.333.9.3 Function Block Diagram



2.1.4.334 MLAxisReadUUnits Pipe Network ✓

2.1.4.335.1 Description

Get the User units per revolution value of the axis

2.1.4.336.2 Arguments

2.1.4.337.3.1 Input

AxisID	Description	ID Name of the Axis block
	Data type	DINT
	Range	—
	Unit	n/a
	Default	—

2.1.4.338.4.2 Output

OK	Description	Returns true when function successfully executes
	Data type	BOOL
	Unit	n/a
UserUnitsPerRev	Description	Returns the Axis User Units per revolution
	Data type	LREAL
	Unit	n/a

2.1.4.339.5 Example

2.1.4.340.6.1 Structured Text

```
Axis1_User_Units := MLAxisReadUUnits (PipeNetwork.Axis1 ) ;
```

2.1.4.341.7.2 Ladder Diagram



2.1.4.342.8.3 Function Block Diagram

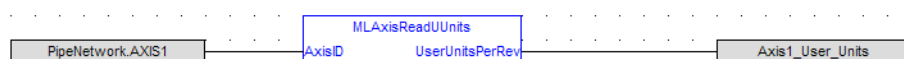

2.1.4.343 MLAxisReadVel Pipe Network ✓

2.1.4.344.1 Description

Return the actual velocity of the axis as calculated internally by the drive mapped to it, based on the data provided by the feedback device of the drive.

2.1.4.345.2 Arguments

2.1.4.346.3.1 Input

ID	Description	Pipe network identifier of the axis block
	Data type	DINT
	Range	—
	Unit	n/a
	Default	—

2.1.4.347.4.2 Output

Velocity	Description	Actual velocity returned by the drive associated to the axis
	Data type	LREAL
	Unit	User unit/sec

2.1.4.348.5 Related Functions

[MLAxisReadActPos](#)

[MLAxisReadTq](#)

2.1.4.349.6 Example

2.1.4.350.7.1 Structured Text

```
Axis1_Velocity := MLAxisReadVel(PipeNetwork.Axis1 ) ;
```

2.1.4.351.8.2 Ladder Diagram

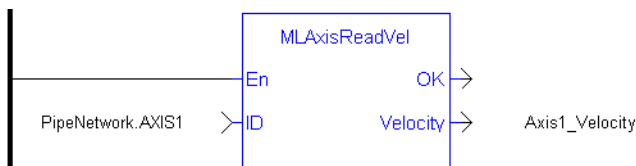

2.1.4.352.9.3 Function Block Diagram



2.1.4.353 MLAxisReAlgnRdy Pipe Network ✓

2.1.4.354.1 Description

Check if an axis is ready. Returns TRUE if the internal realignment axis is ready.

2.1.4.355.2 Arguments

2.1.4.356.3.1 Input

ID	Description	ID Name of the Axis block
	Data type	DINT
	Range	—
	Unit	n/a
	Default	—

2.1.4.357.4.2 Output

Default (.Q)	Description	Returns true when function successfully executes
	Data type	BOOL
	Unit	n/a

2.1.4.358.5 Related Functions

[MLAxisReAlign](#)

2.1.4.359.6 Example

2.1.4.360.7.1 Structured Text

```
MLAxisReAlignRdy (PipeNetwork.Axis1 ) ;
```

2.1.4.361.8.2 Ladder Diagram

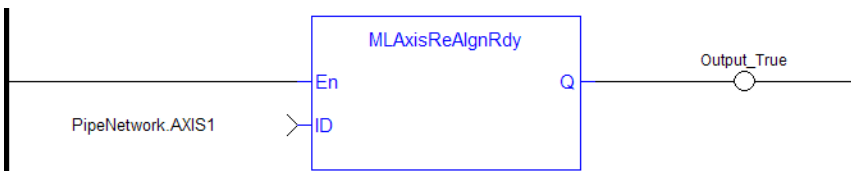

2.1.4.362.9.3 Function Block Diagram

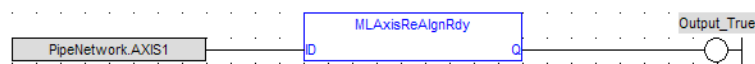

2.1.4.363 MLAxisReAlign Pipe Network ✓

2.1.4.364.1 Description

When stopping the drive a motion profile is applied to decelerate. During the deceleration, the Reference position changes. Calling MLAxisReAlign realigns the actual position with the reference position by moving the axis by the specified delta position, which is typically calculated by the application code. After a [MLAxisStop](#) is executed, a MLAxisReAlign is required for the Pipe Position to be used again.

The function returns TRUE if it succeeds.

NOTE

The realign function do not work properly if the [MLAxisStop](#) function is continuously executed via its Start input

2.1.4.365.2 Arguments

2.1.4.366.3.1 Input

ID	Description	ID Name of the Axis block
	Data type	DINT
	Range	—
	Unit	n/a
	Default	—
Acceleration	Description	Sets the Realign Acceleration
	Data type	LREAL
	Range	—
	Unit	User unit /sec ²
	Default	—
Deceleration	Description	Sets the Realign Deceleration rate
	Data type	LREAL
	Range	—
	Unit	User unit /sec ²
	Default	—
Speed	Description	Sets the Axis Speed
	Data type	LREAL
	Range	—
	Unit	User unit /sec
	Default	—
DeltaPos	Description	Sets the Axis Delta Position, or the relative distance to be moved
	Data type	LREAL
	Range	—
	Unit	User unit
	Default	—

2.1.4.367.4.2 Output

Default (.Q)	Description	Returns true when function successfully executes
---------------------	--------------------	--

Data type	BOOL
Unit	n/a

2.1.4.368.5 Related Functions

[MLAxisReAlgnRdy](#)

2.1.4.369.6 Example

2.1.4.370.7.1 Structured Text

```
MLAxisReAlign(PipeNetwork.Axis1, 100000, 100000, 500, 20 ) ;
```

2.1.4.371.8.2 Ladder Diagram

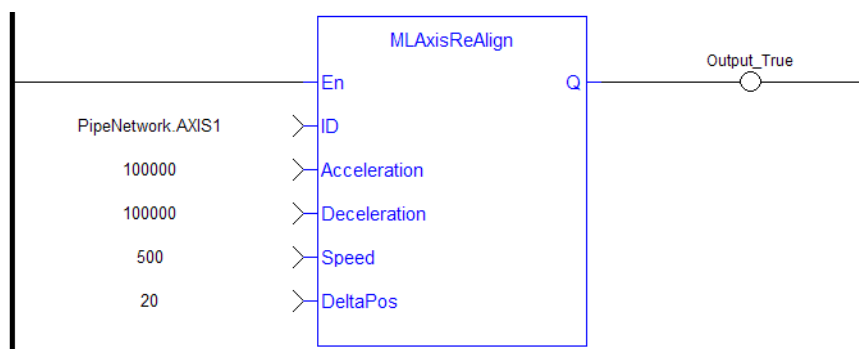

2.1.4.372.9.3 Function Block Diagram

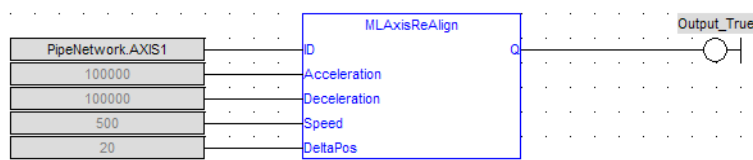

2.1.4.373 MLAxisRel Pipe Network ✓

2.1.4.374.1 Description

A selected Axis performs a move for a specified distance relative to the current position. The DeltaPosition input is signed so that the move can be in the positive or negative direction, and the Axis moves this distance in user units. The travel speed, acceleration, deceleration, and User Units of the move are values inherited from the selected Axis. The default settings are entered when an Axis is created and initiated, and can be changed with other MLAxis commands such as [MLAxisGenWriteSpd](#), [MLAxisGenWriteAcc](#), and [MLAxisWriteUUnits](#).

NOTE

If you wish to know when a move has completed, we recommend using [MLAxisGenIsRdy](#). The output of MLAxisRel can occur before moves have finished.

2.1.4.375.2 Arguments

2.1.4.376.3.1 Input

ID	Description	ID Name of the Axis block
	Data type	DINT
	Range	—
	Unit	n/a
	Default	—
DeltaPosition	Description	Sets the Axis Delta Position, or the relative distance to be moved
	Data type	LREAL
	Range	—
	Unit	User unit
	Default	—

2.1.4.377.4.2 Output

Default (.Q)	Description	Returns true when function successfully executes. This occurs immediately after the function is called; the function does not wait for the motion profile to be completed.
	Data type	BOOL
	Unit	n/a

2.1.4.378.5 Related Functions

[MLAxisGenWriteAcc](#)

[MLAxisGenWriteDec](#)

[MLAxisGenWriteSpd](#)

2.1.4.379.6 Example

See "Usage Example of Axis Functions" (→ p. 175) for additional examples.

2.1.4.380.7.1 Structured Text

```
MLAxisRel(PipeNetwork.Axis1, 2500 ) ;
```

2.1.4.381.8.2 Ladder Diagram

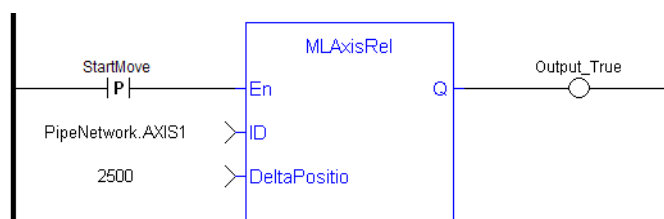

NOTE

You must use a [pulse contact](#) to start the FB

2.1.4.382.9.3 Function Block Diagram

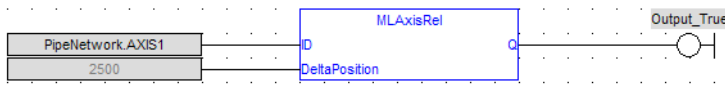

2.1.4.383 MLAxisResetErrors Pipe Network ✓

2.1.4.384.1 Description

Clears errors of the specified axis

2.1.4.385.2 Arguments

2.1.4.386.3.1 Input

ID	Description	ID name of the Axis Block
	Data type	DINT
	Range	—
	Unit	n/a
	Default	—

2.1.4.387.4.2 Output

Default (.Q)	Description	Returns true when function successfully executes
	Data type	BOOL
	Unit	n/a

2.1.4.388.5 Previous Function Name

MLAxisClrErrors

2.1.4.389.6 Example

2.1.4.390.7.1 Structured Text

```
MLAxisResetErrors( PipeNetwork.Axis1 ) ;
```

2.1.4.391.8.2 Ladder Diagram

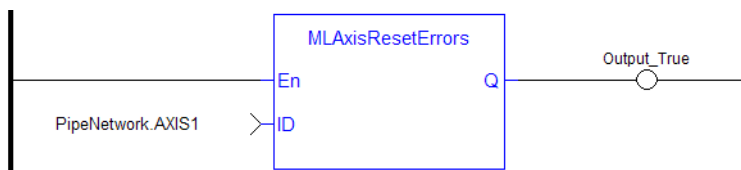

2.1.4.392.9.3 Function Block Diagram



2.1.4.393 MLAxisRstFastIn Pipe Network ✓

2.1.4.394.1 Description

Write in the Latch Control Word to reset the Fast Input.

2.1.4.395.2 Arguments

2.1.4.396.3.1 Input

AxisID	Description	ID Name of the Axis block
	Data type	DINT
	Range	—
	Unit	n/a
	Default	—
InputID	Description	ID name of the Fast input to be reset on an axis, (ie IN1 and IN2 on S300) 0 = Capture Engine 0 1 = Capture Engine 1 Range is [0, 1] For information on configuring the capture engines, refer to AKD Capture Engine Configuration.
	Data type	DINT
	Range	—
	Unit	n/a
	Default	—

2.1.4.397.4.2 Output

Default (.Q)	Description	Returns true when function successfully executes
	Data type	BOOL
	Unit	n/a

2.1.4.398.5 Related Functions

[MLAxisCfgFastIn](#)

[MLAxisIsTriggered](#)

2.1.4.399.6 Example

2.1.4.400.7.1 Structured Text

```
MLAxisRstFastIn (PipeNetwork.Axis1, 0 ) ;
```

2.1.4.401.8.2 Ladder Diagram



2.1.4.402.9.3 Function Block Diagram



2.1.4.403 MLAxisStatus Pipe Network ✓

2.1.4.404.1 Description

Returns the status of the axis.

2.1.4.405.2 Arguments

2.1.4.406.3.1 Input

ID	Description	ID Name of the Axis block
	Data type	DINT
	Range	—
	Unit	n/a
	Default	—

2.1.4.407.4.2 Output

OK	Description	Returns true when function successfully executes
	Data type	BOOL
	Unit	n/a

Default (.Q)	Description	Returns the status of the axis																												
		<table border="1"> <thead> <tr> <th>Bit</th> <th>Description</th> </tr> </thead> <tbody> <tr> <td>0</td> <td>Initialized (1 if initialized)</td> </tr> <tr> <td>1</td> <td>Power (1 if power is on) Is linked to bit 1 (Switched on) of the Status Word For more information on the status machine</td> </tr> <tr> <td>2</td> <td>Enabled (1 if enabled) Is linked to bit 0 (Ready to switch on) of the Status Word</td> </tr> <tr> <td>3</td> <td>Found (1 if found on the network). EtherCAT state is Pre-Operational, see State Machine.</td> </tr> <tr> <td>4</td> <td>Configured (1 if configured) EtherCAT state is Safe-Operational, see State Machine.</td> </tr> <tr> <td>5</td> <td>Running (1 if running) EtherCAT state is Operational, see State Machine.</td> </tr> <tr> <td>6</td> <td>Error (1 if in error)</td> </tr> <tr> <td>7</td> <td>Simulated (1 if working with a simulated axis)</td> </tr> <tr> <td>8</td> <td>Connected (1 if a pipe is connected)</td> </tr> <tr> <td>9</td> <td>Warning (1 if the drive signals a warning)</td> </tr> <tr> <td>10</td> <td>Stopping (1 if the drive is performing a Stop)</td> </tr> <tr> <td>11</td> <td>Stopped (1 if the drive has finished the Stop)</td> </tr> <tr> <td>12 to 31</td> <td>Reserved</td> </tr> </tbody> </table>	Bit	Description	0	Initialized (1 if initialized)	1	Power (1 if power is on) Is linked to bit 1 (Switched on) of the Status Word For more information on the status machine	2	Enabled (1 if enabled) Is linked to bit 0 (Ready to switch on) of the Status Word	3	Found (1 if found on the network). EtherCAT state is Pre-Operational, see State Machine.	4	Configured (1 if configured) EtherCAT state is Safe-Operational, see State Machine.	5	Running (1 if running) EtherCAT state is Operational, see State Machine.	6	Error (1 if in error)	7	Simulated (1 if working with a simulated axis)	8	Connected (1 if a pipe is connected)	9	Warning (1 if the drive signals a warning)	10	Stopping (1 if the drive is performing a Stop)	11	Stopped (1 if the drive has finished the Stop)	12 to 31	Reserved
Bit	Description																													
0	Initialized (1 if initialized)																													
1	Power (1 if power is on) Is linked to bit 1 (Switched on) of the Status Word For more information on the status machine																													
2	Enabled (1 if enabled) Is linked to bit 0 (Ready to switch on) of the Status Word																													
3	Found (1 if found on the network). EtherCAT state is Pre-Operational, see State Machine.																													
4	Configured (1 if configured) EtherCAT state is Safe-Operational, see State Machine.																													
5	Running (1 if running) EtherCAT state is Operational, see State Machine.																													
6	Error (1 if in error)																													
7	Simulated (1 if working with a simulated axis)																													
8	Connected (1 if a pipe is connected)																													
9	Warning (1 if the drive signals a warning)																													
10	Stopping (1 if the drive is performing a Stop)																													
11	Stopped (1 if the drive has finished the Stop)																													
12 to 31	Reserved																													
	Data type	DINT																												
	Unit	n/a																												

2.1.4.408.5 Example

2.1.4.409.6.1 Structured Text

```
AxisStatus := MAxisStatus(PipeNetwork.AXI_A1_Axis) ;
IF AxisStatus.11 THEN
    MAxisStop(PipeNetwork.AXI_A1_Axis, FALSE, DEF_A1_StopDec) ;
END_IF;
```

```
AxisStatus := MAxisStatus(PipeNetwork.AXIS1);
If AxisStatus.0 Then
    (*Axis is initialized*)
ElsIf AxisStatus.1 Then
    (*Axis' power is ON*)
ElsIf AxisStatus.2 Then
    (*Axis is READY to be enabled*)
End_If;
```

2.1.4.410.7.2 Ladder Diagram

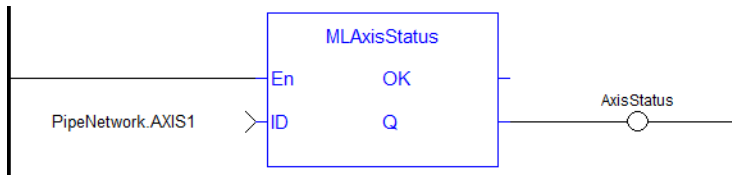

2.1.4.411.8.3 Function Block Diagram



2.1.4.412 MLAxisStop Pipe Network ✓

2.1.4.413.1 Description

Stop with the specified deceleration.

After stopping the drive, you need to restart the motion by realigning the actual position with the reference position

The purpose of the MLAxisStop Command is not to remove the input source, but to stop the drive from continuing to move.

When the stop occurs, the master keeps moving and the axis starts ignoring the Pipe Position value and begins a controlled stop based on the input parameters. Also at that point, any Axis Block level profile (issued from FB like MLAxisAbs, MLAxisRel...) are aborted. When the stop is complete, it is up to the application to decide how to move the axis, master, or both to a position where they can be realigned, and the master restarted.

The [realign](#) function is used to move the axis to a restart position in order to enable synchronized machine motion to start again. Once the realign function is successfully completed, the Pipe Position is again summed with the Generator Position to create the Reference Position.

2.1.4.414.2 Arguments

2.1.4.415.3.1 Input

ID	Description	ID Name of the Axis block
	Data type	DINT
	Range	—
	Unit	n/a
	Default	—
Start	Description	
	Data type	BOOL
	Range	0, 1
	Unit	n/a
	Default	—
Deceleration	Description	

Data type	LREAL
Range	—
Unit	User unit /sec ²
Default	—

2.1.4.416.4.2 Output

Default (.Q)	Description	Comes true when the Axis is completely stopped.
	Data type	BOOL
	Unit	n/a
PipePos	Description	Corresponds to the Pipe Position input to the axis at the time the stop is triggered.
	Data type	LREAL
	Unit	User unit
GenPos	Description	Corresponds to the Generator Position input to the axis at the time the stop is triggered.
	Data type	LREAL
	Unit	User unit
RealignPos	Description	Realign Position is the Reference Position at which the stop is triggered. The Realign Position is obtained by converting the last value sent to the drive from drive interface units into user units. The Realign Position is useful if you want to return to the point at which the trajectory was abandoned, or in case you need to realign the master to the slave.
	Data type	LREAL
	Unit	User unit
StopPos	Description	Corresponds to the last Reference Position sent to the drive at the time when the Axis is completely stopped. It is functionally different than the Actual Position because that position is the drive position converted to user units. The correct delta for the realign move to get in sync with the trajectory in order to realign the slave to the master is the current Reference Position minus the Stop Position for the realign move. After stopping, if the axis is disabled and the motor position is manually altered, this distance must be taken into account when performing the realign.
	Data type	LREAL
	Unit	User unit

2.1.4.417.5 Related Functions

[MLAxisReAlign](#)

2.1.4.418.6 Example

2.1.4.419.7.1 Structured Text

```

Inst_MLAxisStop(PipeNetwork.AXIS1, bStop, 200000);
If Inst_MLAxisStop.Done Then
    Axis1_PipePosition      := Inst_MLAxisStop.PipePos;
    Axis1_GeneratorPosition := Inst_MLAxisStop.GenPos;
    Axis1_RealignPosition  := Inst_MLAxisStop.RealignPos;
    Axis1_StopPosition     := Inst_MLAxisStop.StopPos;
End_if;
    
```

2.1.4.420.8.2 Ladder Diagram

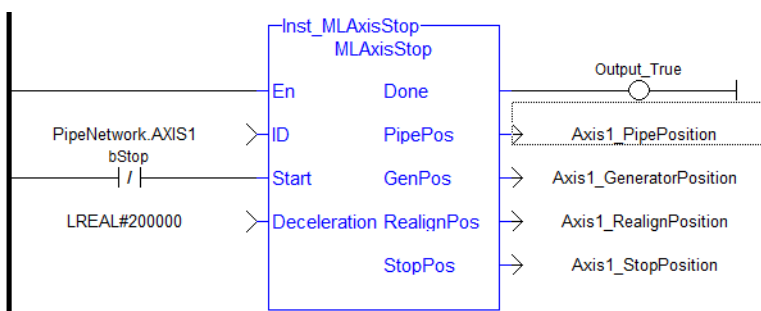

2.1.4.421.9.3 Function Block Diagram



2.1.4.422 MLAxisTimeStamp Pipe Network ✓

2.1.4.423.1 Description

Returns the timestamp of the triggered axis.

2.1.4.424.2 Arguments

2.1.4.425.3.1 Input

En	Description	Enables execution
	Data type	BOOL
	Unit	n/a
	Default	—
ID	Description	ID Name of the Axis block

	Data type	DINT
	Range	—
	Unit	n/a
	Default	—
InputID	Description	ID of the triggered Fast input of an axis, 0=first , 1=second (ie IN1 and IN2 on S300)
	Data type	DINT
	Range	[0, 1]
	Unit	n/a
	Default	—
edge	Description	Configures the Inputs as 0= Disabled, 1=Rising Edge, 2=Falling edge
	Data type	DINT
	Range	[0, 2]
	Unit	n/a
	Default	—

2.1.4.426.4.2 Output

OK	Description	Returns true when function successfully executes.
	Data type	BOOL
	Unit	n/a
Q	Description	Returns the time stamp value. This value is explained in How to interpret the timestamp.
	Data type	DINT
	Unit	microseconds

2.1.4.427.5 Related Functions

[MLAxisCfgFastIn](#)

[MLAxisRstFastIn](#)

[MLAxisIsTriggered](#)

2.1.4.428.6 Example

2.1.4.429.7.1 Structured Text

```
MLAxisTimeStamp (PipeNetwork.Axis1, 0, 1 ) ;
```

2.1.4.430.8.2 Ladder Diagram

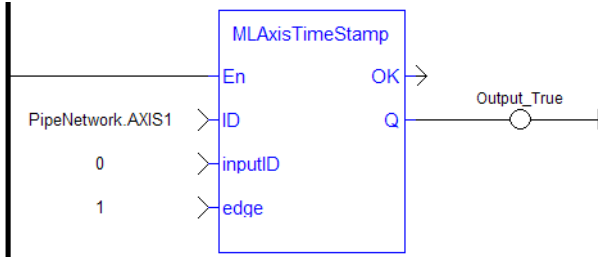

2.1.4.431.9.3 Function Block Diagram

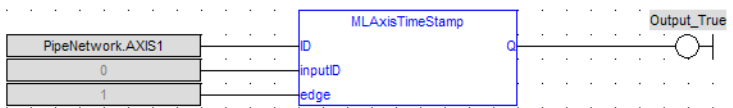

2.1.4.432 MLAxisWriteModPos Pipe Network ✓

2.1.4.433.1 Description

Set the value period of the axis. Returns TRUE if the function succeeded.

2.1.4.434.2 Arguments

2.1.4.435.3.1 Input

AxisID	Description Data type Range Unit Default	ID Name of the Axis block DINT — n/a —
ModuloPosition	Description Data type Range Unit Default	Sets the Axis Period Value when Mode is set to Modulo. LREAL — User unit —

2.1.4.436.4.2 Output

Default (.Q)	Description Data type Unit	Returns true when function successfully executes BOOL n/a
--------------	----------------------------------	---

2.1.4.437.5 Example

2.1.4.438.6.1 Structured Text

```
MLAxisWriteModPos (PipeNetwork.Axis1, 360) ) ;
```

2.1.4.439.7.2 Ladder Diagram

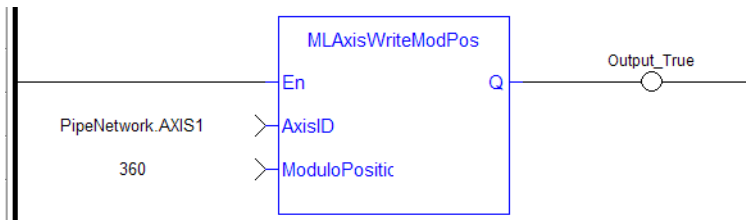

2.1.4.440.8.3 Function Block Diagram



2.1.4.441 MAxisWritePipPos Pipe Network ✓

2.1.4.442.1 Description

Force the pipe position internal value. This function is working only when no pipe is connected.

2.1.4.443.2 Arguments

2.1.4.444.3.1 Input

AxisID	Description Data type Range Unit Default	ID Name of the Axis block DINT — n/a —
PipePosition	Description Data type Range Unit Default	Sets the Axis Pipe Position LREAL — User unit —

2.1.4.445.4.2 Output

Default (.Q)	Description Data type Unit	Returns true when function successfully executes BOOL n/a
--------------	----------------------------------	---

2.1.4.446.5 Related Functions

[MLAxisReadActPos](#)

[MLAxisFBackPos](#)

[MLAxisGenPos](#)

[MLAxisPipePos](#)

[MLAxisCmdPos](#)

2.1.4.447.6 Example

2.1.4.448.7.1 Structured Text

```
MLAxisWritePipPos(PipeNetwork.Axis1, 3000 ) ;
```

2.1.4.449.8.2 Ladder Diagram

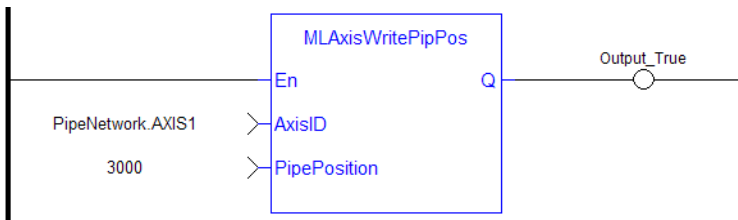

2.1.4.450.9.3 Function Block Diagram



2.1.4.451 MLAxisWritePos Pipe Network ✓

2.1.4.452.1 Description

Used to set a position offset at the Axis when the Pipe Network:

- Pipe Position and Pipe Offset are set to zero
- Generator Position is set to equal to Zero Position
- Then Reference Position equals Pipe Position + Generator Position

About associated data on Positions

The following data are illustrated in the figure below.

NOTE

All positions are in user units with Modulo applied if active, unless specified.

Position / Offset	Description
ActualPosition	<p>Actual refers to the actual position of the underlying Drive. It is the current position of the drive in user units. It is the sum of the feedback value (Position actual value) returned from the communication link to the drive, the Power ON Delta Offset, and any zero-offset due to an MLWritePos function ("MLAxisWritePipPos" (→ p. 171), "MLAxisWritePos" (→ p. 172)). Normally the value of power on delta offset is zero.</p> <div style="border: 1px solid gray; padding: 5px; margin-top: 10px;"> $\text{ActualPos} := \text{FeedbackPos} + \text{ZeroOffset}$ </div>
CurrentPosition	<p>Current position is the actual command value being sent to the drive. It is an unsigned 32-bit integer value (fraction = zero). When in the power on condition this value is the command value that represents the target value in the communication link (Position demand value). It is not in user units, but in Drive units of 2**20 units per revolution of the drive.</p> <div style="border: 1px solid gray; padding: 5px; margin-top: 10px;"> $\text{CurrentPos} := \text{ReferencePosition} + \text{ZeroOffset}$ </div>
FeedbackPosition	<p>Feedback Position is the "Position actual value" read from the drive. FeedbackPos relates to the TxPDO value of 'Actual position value'</p>

Position / Offset	Description
GeneratorPosition	Generator position is the summation of all previous commands to the Axis internal trapezoidal motion generator. It is also a collector of uncompensated motion due to "MLAxisWritePos" (→ p. 172)() being used to modify actual position via the zero offset value and the adjustment in commanded value to insure no steps in the Current position command. It also accumulates changes in pipe position due to activate and deactivation of the pipe and convertor output to pipe position of the axis.
MotorPosition	Motor position relates to the RxPDO value of 'Position demand value' $\text{MotorPosition} = \text{CurrentPos} + \text{PowerOnDeltaOffset}$
PipePosition	The output of the convertor block is written into the PipePosition value whenever the convertor block is connected to the axis and the pipe is active.
Power ON Delta Offset	A change was made a long time ago to allow absolute feedback to be passed into the axis rather than always starting at zero actual position. Units are in Drive units of $2^{**}20$ units per revolution. On Drive Power On this value is set to be the difference between the " ActualPosition value" and the "Position demand value" last sent to the drive. It is then added to the Current position value when the "Position demand value" is updated. It is read in User Units without periodicity applied.
ReferencePosition	Reference position is the summation of PipePosition and GeneratorPosition . $\text{ReferencePosition} = \text{Pipe Position} + \text{Generator Position}$
Zero Offset	Affected by the "MLAxisWritePos" (→ p. 172)() function to adjust the actual position to the desired value of the command by setting zero offset to the difference between the desired and actual position, and applying the change to modify the generator position so that the reference position tracks the change in reference.

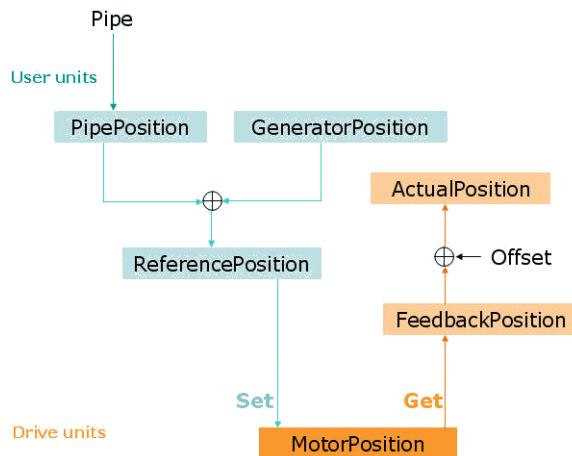

2.1.4.453.2 Arguments

2.1.4.454.3.1 Input

ID	Description	ID Name of the Axis block
	Data type	DINT
	Range	—
	Unit	n/a
	Default	—

Position	Description	Position offset.
	Data type	LREAL
	Range	—
	Unit	User unit
	Default	—

2.1.4.455.4.2 Output

Default (.Q)	Description	Returns true when function successfully executes
	Data type	BOOL
	Unit	n/a

2.1.4.456.5 Previous Function Name

MLAxisSetZero

2.1.4.457.6 Example

2.1.4.458.7.1 Structured Text

```
MLAxisWritePos ( PipeNetwork.Axis1, 0 ) ;
```

2.1.4.459.8.2 Ladder Diagram

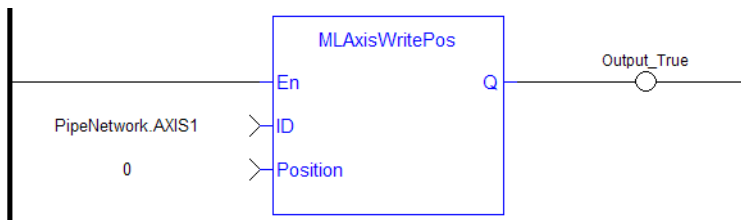

2.1.4.460.9.3 Function Block Diagram



2.1.4.461 MLAxisWriteUUnits Pipe Network ✓

2.1.4.462.1 Description

Set the user units per revolution value of the axis. Returns TRUE if the function succeeded. User units are user-defined position units used within the KAS application Selected units must be as natural as possible and must make sense for the machine It must be related to the final moving object (e.g. the driven belt rather than the axis shaft) The same unit must be used for all related axes for simplicity reasons Speeds are defined in [user units / second] and accelerations in [user units / second²]

2.1.4.463.2 Arguments

2.1.4.464.3.1 Input

AxisID	Description	ID Name of the Axis block
	Data type	DINT
	Range	—
	Unit	n/a
	Default	—

2.1.4.465.4.2 Output

Default (.Q)	Description Data type Unit	Returns true when function successfully executes BOOL n/a
UserUnitsPerRev	Description Data type Unit	Sets the Axis User Units per revolution LREAL n/a

2.1.4.466.5 Example

2.1.4.467.6.1 Structured Text

```
MLAxisWriteUUnits(PipeNetwork.Axis1, 360 ) ;
```

2.1.4.468.7.2 Ladder Diagram

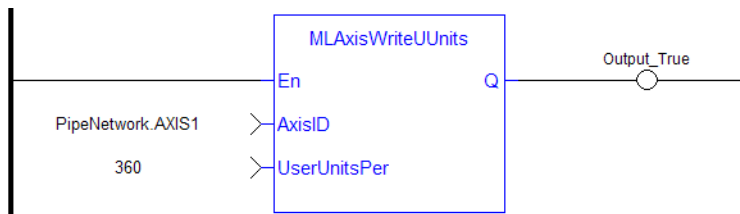

2.1.4.469.8.3 Function Block Diagram

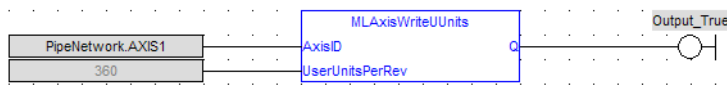

2.1.4.470 Usage Example of Axis Functions

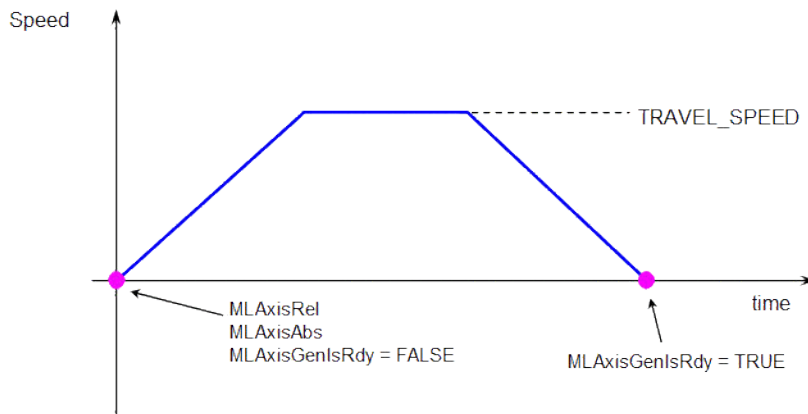

MLAxisMoveVel(Speed) starts to run the axis. Then **MLAxisGenIsRdy** returns TRUE when the Speed is reached.

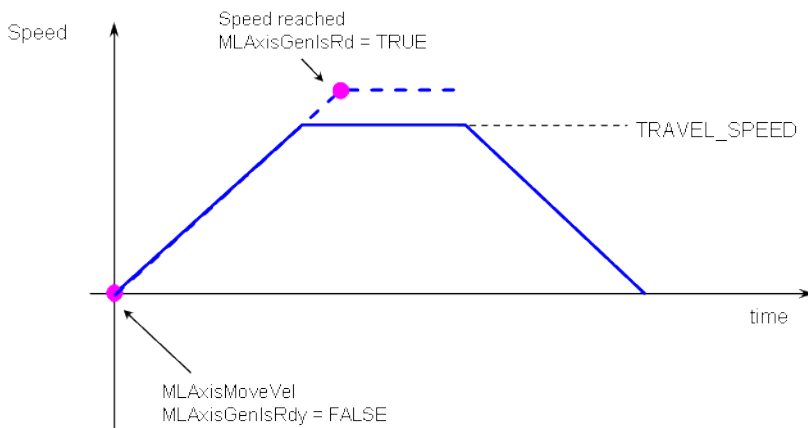

MLAxisMoveVel(0.0) reduces the speed down to 0. Then **MLAxisGenIsRdy** returns TRUE once the axis is ready.

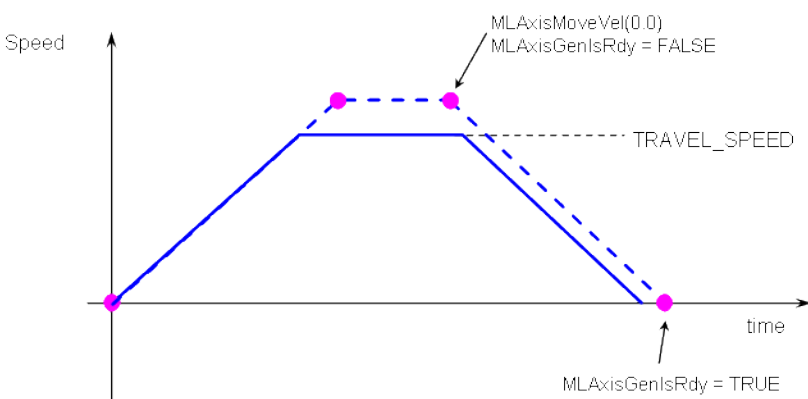

Figure 1-19: Axis Functions Usage

2.1.5 Motion Library - Cam Profile

Name	Description	Return type
"MLCamInit" (→ p. 177)	Initializes a cam Pipe Block with user-defined settings	BOOL
"MLCamSwitch" (→ p. 179)	Switches profiles of the selected cam object	BOOL
"MLPrfReadIOffset" (→ p. 180)	Returns the Input Offset value of a selected cam profile	None
"MLPrfReadIScale" (→ p. 181)	Returns the Input Ratio value of a selected cam profile	None
"MLPrfReadOOffset" (→ p. 183)	Returns the Output Offset value of a selected cam profile	None
"MLPrfReadOScale" (→ p. 184)	Returns the Output Ratio value of a selected cam profile	None
"MLPrfWriteIOffset" (→ p. 185)	Sets the Input Offset value of a selected cam profile	BOOL
"MLPrfWriteIScale" (→ p. 186)	Sets the Input Ratio value of a selected cam profile	BOOL
"MLPrfWriteOOffset" (→ p. 188)	Sets the Output Offset value of a selected cam profile	BOOL

Name	Description	Return type
"MLPrfWriteOScale" (→ p. 189)	Sets the Output Ratio value of a selected cam profile	BOOL
"MLProfileBuild" (→ p. 455)	Builds a cam profile from application data	See "Output" (→ p. 458)
"MLProfileCreate" (→ p. 463)	Creates a new cam profile object	None
"MLProfileInit" (→ p. 464)	Initializes a previously created cam profile object	BOOL
"MLProfileRelease" (→ p. 467)	Removes a Profile so the Profile ID may be used by a different or new Profile.	See "Output" (→ p. 468)

2.1.5.1 MLCamInit

2.1.5.2.1 Description

Initializes a Cam Pipe Block for use in a PLC Program. Function block is automatically called if a Cam Block is added to the Pipe Network, with user-defined settings then entered in the Pipe Blocks Properties screen.

The Cam Pipe Block is used to generate motion profiles of any shape. These profiles are created and initiated separately and the shape is modified with the Cam Editor. With the Editor profiles can be changed graphically or by manually changing values in a numeric table relating input and output values with specific slopes. The Cam Editor software tool provides the capability to visualize, analyze, edit, and smooth profiles.

With the PipeNetwork (PN) Cam block:

- the Cam block's profile is in reference to the input positions coming into the PN Cam block (Master Absolute)
- the PN Cam block output positions are in reference to PN Cam block's output position at the end of the last cam cycle (Slave Relative)

Profile switching can be done on the fly, without losing synchronization and without dead time. In addition, the offsets and ratios of Cam Profiles can be changed on the fly. See Cam Profile Switching for more information.

NOTE

CAM objects are normally created in the Pipe Network using the graphical engine. Then you do not have to add MLCamInit function blocks to their programs. Parameters are entered directly in pop-up windows, and the code is then automatically added to the current project.

2.1.5.3.2 Arguments

2.1.5.4.3.1 Input

BlockID	Description	ID number of a created Pipe Block
	Data type	DINT
	Range	[-2147483648, 2147483648]
	Unit	n/a
	Default	CAM

ProfileName	Description	Name of the current profile assigned to the cam. It must be a declared profile object
	Data type	STRING
	Range	—
	Unit	n/a
	Default	—
ModuloPosition	Description	Value of the period of the cam output values expressed in user units, for a cyclic system
	Data type	LREAL
	Range	—
	Unit	User unit
	Default	360.0

2.1.5.5.4.2 Output

Default (.Q)	Description	Returns TRUE if the CAM Pipe Block is initialized
	Data type	BOOL
	Unit	n/a

2.1.5.6.5.3 Return Type

BOOL

2.1.5.7.6 Related Functions

"MLProfileCreate" (→ p. 463)

"MLProfileInit" (→ p. 464)

2.1.5.8.7 Example

2.1.5.9.8.1 Structured Text

```
//Initialize a Pipe Network block named "CAM" with a profile
named "Profile_A", set the cam modulo position to 360
CAM := MlBlkCreate( 'CAM', 'CAM' );
MLCamInit( CAM, 'Profile_A', 360.0 );
```

2.1.5.10.9.2 Ladder Diagram

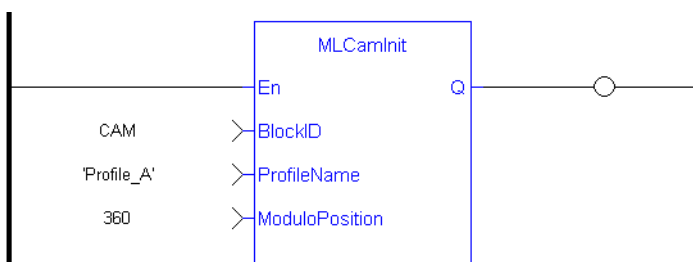

2.1.5.11.10.3 Function Block Diagram

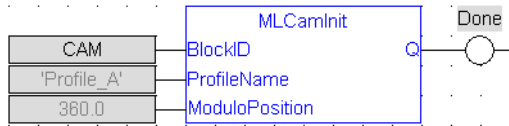

2.1.5.12 MLCamSwitch Pipe Network ✓

2.1.5.13.1 Description

Switches the CAM Profile in a selected CAM object. Can be used in combination with a comparator to check that profiles are switched at a time where the input and output values of both the old and new profiles are equal, so an Axis receives continuous position values and does not jump.

These profiles are created and initiated separately and the shape is created with the CAM Editor. With the Editor profiles can be changed graphically or by manually changing values in a numeric table relating input and output values with specific slopes. The Cam Editor software tool provides the capability to visualize, analyze, edit, and smooth profiles.

See Cam Profile Switching for more information.

2.1.5.14.2 Arguments

2.1.5.15.3.1 Input

BlockID	Description	ID number of an initialized CAM Pipe Block
	Data type	DINT
	Range	[-2147483648, 2147483648]
	Unit	n/a
	Default	—
ProfileID	Description	Name of the new CAM profile which is assigned to the CAM Pipe Block. It must be a declared profile object.
	Data type	DINT
	Range	[-2147483648, 2147483648]
	Unit	n/a
	Default	—

2.1.5.16.4.2 Output

Default (.Q)	Description	Returns TRUE if the CAM Profile is changed
	Data type	BOOL
	Unit	n/a

2.1.5.17.5.3 Return Type

BOOL

2.1.5.18.6 Related Functions

"MLProfileCreate" (→ p. 463)

"MLProfileInit" (→ p. 464)

"MLPrfWriteOffset" (→ p. 185)

"MLPrfWriteOScale" (→ p. 189)

2.1.5.19.7 Example

2.1.5.20.8.1 Structured Text

```
//Switch CAM Profile
MLCamSwitch(PipeNetwork.CAM, Profiles.Profile_B);
```

2.1.5.21.9.2 Ladder Diagram

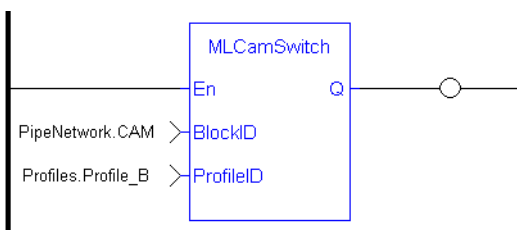

2.1.5.22.10.3 Function Block Diagram

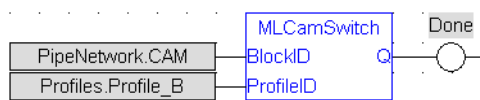

2.1.5.23 MLPrfReadOffset Pipe Network ✓

2.1.5.24.1 Description

Returns the Input Offset value of a selected CAM Profile. Offsets can be changed on the fly to modify the CAM Profile while maintaining its shape. A change in input offset is equivalent to shifting the CAM Profile on the x or Input Axis.

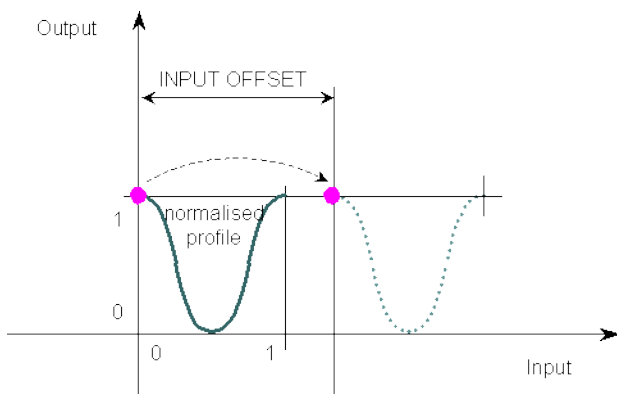

Figure 1-20: MLPrfReadOffset

2.1.5.25.2 Arguments

2.1.5.26.3.1 Input

	Description	Name of an initialized CAM Profile
	Data type	DINT
ProfileID	Range	[-2147483648, 2147483648]
	Unit	n/a
	Default	—

2.1.5.27.4.2 Output

OK	Description	Returns true when function successfully executes
	Data type	BOOL
Offset	Description	Returns the Input Offset of the selected CAM Profile
	Data type	LREAL
	Unit	n/a

2.1.5.28.5 Related Functions

"MLPrfWriteIOffset" (→ p. 185)

"MLProfileCreate" (→ p. 463)

"MLProfileInit" (→ p. 464)

2.1.5.29.6 Example

2.1.5.30.7.1 Structured Text

```
//Save value of input offset
CamOffset := MLPrfReadIOffset( Profiles.Profile_A );
```

2.1.5.31.8.2 Ladder Diagram

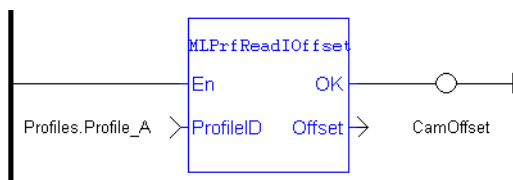

2.1.5.32.9.3 Function Block Diagram

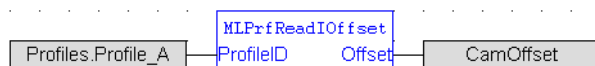

2.1.5.33 MLPrfReadIScale Pipe Network ✓

2.1.5.34.1 Description

Returns the Input Ratio value of a selected CAM Profile. Ratios can be changed on the fly to modify the CAM Profile while maintaining its basic shape. A change in input ratio is equivalent to stretching the CAM Profile on the X (or Input) Axis. A negative value is not allowed.

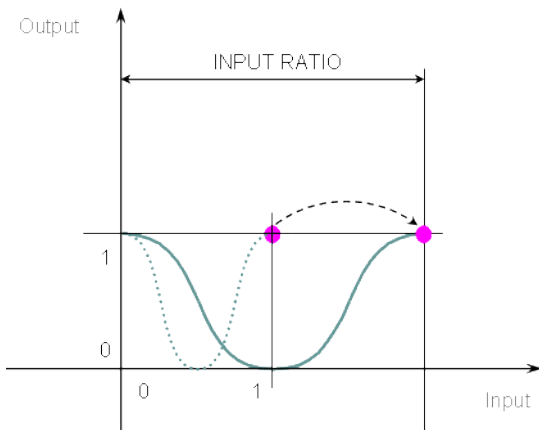

Figure 1-21: MLPrfReadIScale

2.1.5.35.2 Arguments

2.1.5.36.3.1 Input

	Description	ID number of an initialized CAM Profile
	Data type	DINT
ProfileID	Range	[-2147483648, 2147483648]
	Unit	n/a
	Default	—

2.1.5.37.4.2 Output

	Description	Returns the Input Ratio of the selected CAM Profile
Ratio	Data type	LREAL
	Unit	n/a

2.1.5.38.5 Related Functions

- "MLPrfWriteIScale" (→ p. 186)
- "MLProfileCreate" (→ p. 463)
- "MLProfileInit" (→ p. 464)

2.1.5.39.6 Previous Function Name

MLPrfGetIRatio

2.1.5.40.7 Example

2.1.5.41.8.1 Structured Text

```
//Save value of input ratio
CamRatio := MLPrfReadIScale( Profiles.Profile_A );
```

2.1.5.42.9.2 Ladder Diagram

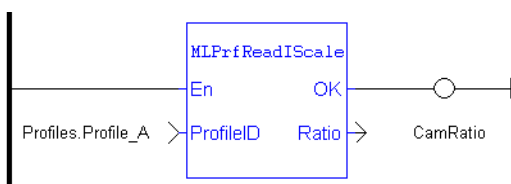

2.1.5.43.10.3 Function Block Diagram



2.1.5.44 MLPrfReadOOffset Pipe Network ✓

2.1.5.45.1 Description

Returns the Output Offset value of a selected CAM Profile. Offsets can be changed on the fly to modify the CAM Profile while maintaining its shape. A change in output offset is equivalent to shifting the CAM Profile on the Y (or Output) Axis.

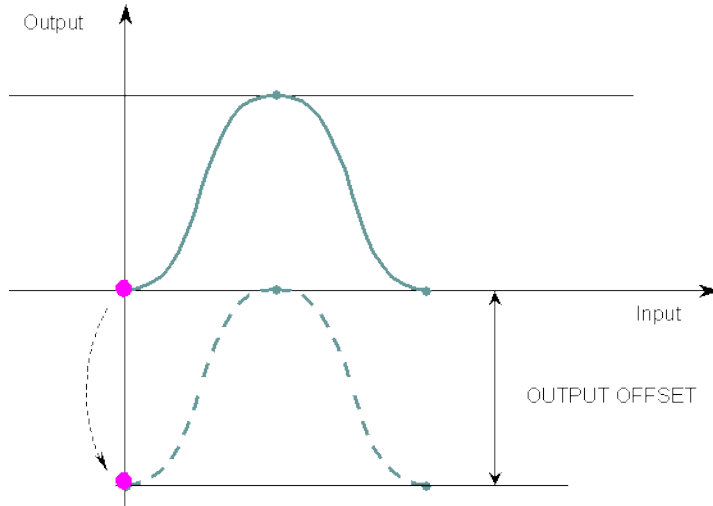

Figure 1-22: MLPrfReadOOffset

2.1.5.46.2 Arguments

2.1.5.47.3.1 Input

ProfileID	Description	ID number of an initialized CAM Profile
	Data type	DINT
	Range	[-2147483648, 2147483648]
	Unit	n/a
	Default	—

2.1.5.48.4.2 Output

Offset	Description	Returns the Output Offset of the selected CAM Profile
	Data type	LREAL
	Unit	n/a

2.1.5.49.5 Related Functions

"MLPrfWriteOOffset" (→ p. 188)

"MLProfileCreate" (→ p. 463)

"MLProfileInit" (→ p. 464)

2.1.5.50.6 Example

2.1.5.51.7.1 Structured Text

```
//Save value of output offset
CamOffset := MLPrfReadOffset( Profiles.Profile_A );
```

2.1.5.52.8.2 Ladder Diagram

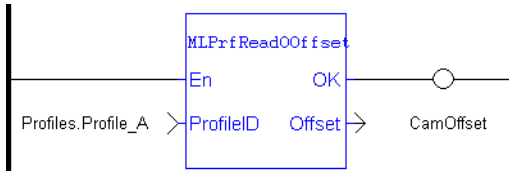

2.1.5.53.9.3 Function Block Diagram



2.1.5.54 MLPrfReadOScale Pipe Network ✓

2.1.5.55.1 Description

Returns the Output Ratio value of a selected CAM Profile. Ratios can be changed on the fly to modify the CAM Profile while maintaining its basic shape. A change in output ratio is equivalent to stretching, and flipping if negative, the CAM Profile on the Y (or Output) Axis.

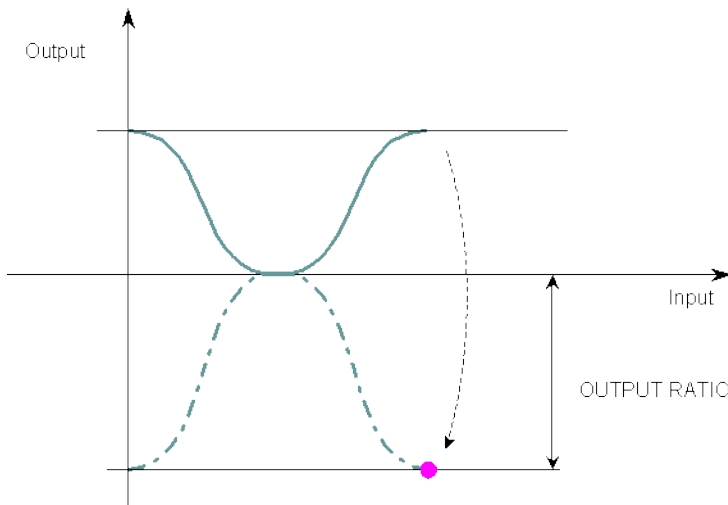

Figure 1-23: MLPrfReadOScale

2.1.5.56.2 Arguments

2.1.5.57.3.1 Input

	Description	ID number of an initialized CAM Profile
	Data type	DINT
ProfileID	Range	[-2147483648, 2147483648]
	Unit	n/a
	Default	—

2.1.5.58.4.2 Output

Ratio	Description	Returns the Output Ratio of the selected CAM Profile
	Data type	LREAL
	Unit	n/a

2.1.5.59.5 Related Functions

"MLPrfWriteOScale" (→ p. 189)

"MLProfileCreate" (→ p. 463)

"MLProfileInit" (→ p. 464)

2.1.5.60.6 Previous Function Name

MLPrfGetORatio

2.1.5.61.7 Example

2.1.5.62.8.1 Structured Text

```
//Save value of output ratio
CamRatio := MLPrfReadOScale( Profiles.Profile_A );
```

2.1.5.63.9.2 Ladder Diagram

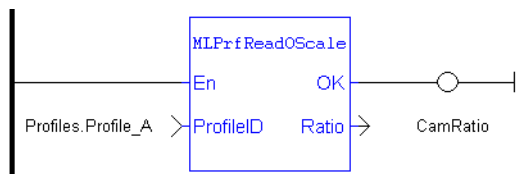

2.1.5.64.10.3 Function Block Diagram

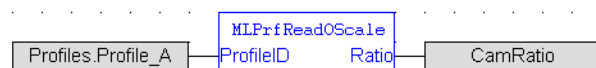

2.1.5.65 MLPrfWriteOffset Pipe Network ✓

2.1.5.66.1 Description

Set the Input Offset value of a selected CAM Profile. Offsets are changed on the fly to modify the CAM Profile while maintaining its shape. A change in input offset is equivalent to shifting the CAM Profile on the X (or Input) Axis.

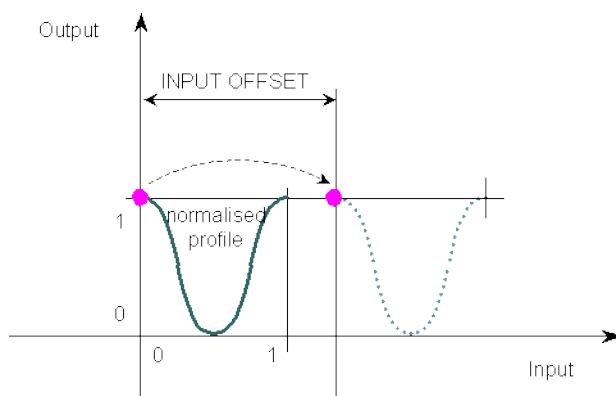

Figure 1-24: MLPrfWriteOffset

2.1.5.67.2 Arguments

2.1.5.68.3.1 Input

ProfileID	Description	ID number of an initialized CAM Profile
	Data type	DINT
	Range	[-2147483648, 2147483648]
	Unit	n/a
	Default	—
Offset	Description	Desired new value of Input Offset
	Data type	LREAL
	Range	—
	Unit	n/a
	Default	—

2.1.5.69.4.2 Output

Default (.Q)	Description	Returns TRUE if the Input Offset is changed to the new value
	Data type	BOOL
	Unit	n/a

2.1.5.70.5.3 Return Type

BOOL

2.1.5.71.6 Related Functions

"MLPrfReadIOffset" (→ p. 180)

"MLProfileCreate" (→ p. 463)

"MLProfileInit" (→ p. 464)

2.1.5.72.7 Example

2.1.5.73.8.1 Structured Text

```
//Change the value of input offset
MLPrfWriteIOffset( Profiles.Profile_A , 45 );
```

2.1.5.74.9.2 Ladder Diagram

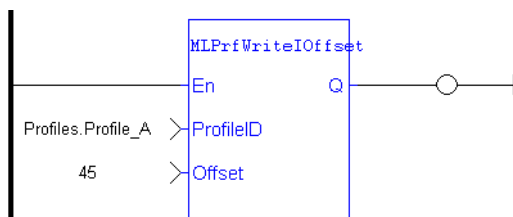

2.1.5.75.10.3 Function Block Diagram

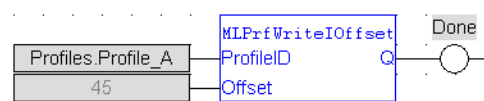

2.1.5.76 MLPrfWriteScale Pipe Network ✓

2.1.5.77.1 Description

Set the Input Ratio value of a selected CAM Profile. Ratios are changed on the fly to modify the CAM Profile while maintaining its basic shape. A change in input ratio is equivalent to stretching the CAM Profile on the X (or Input) Axis.

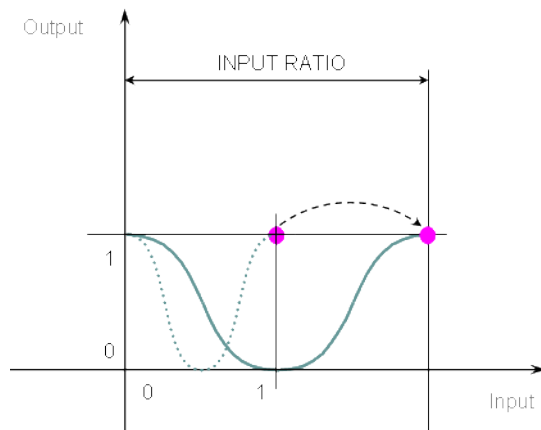

Figure 1-25: MLPrfWriteIScale

2.1.5.78.2 Arguments

2.1.5.79.3.1 Input

ProfileID	Description	ID number of initialized CAM Profile
	Data type	DINT
	Range	[-2147483648, 2147483648]
	Unit	n/a
	Default	—
Ratio	Description	Desired new value for Input Ratio
	Data type	LREAL
	Range	Positive
	Unit	n/a
	Default	—

2.1.5.80.4.2 Output

Default (.Q)	Description	Returns TRUE if the Input Ratio is changed
	Data type	BOOL
	Unit	n/a

2.1.5.81.5.3 Return Type

BOOL

2.1.5.82.6 Related Functions

"MLPrfReadIScale" (→ p. 181)

"MLProfileCreate" (→ p. 463)

"MLProfileInit" (→ p. 464)

2.1.5.83.7 Previous Function Name

MLPrfSetIRatio

2.1.5.84.8 Example

2.1.5.85.9.1 Structured Text

```
//Change value of input ratio
MLPrfWriteIScale( Profiles.Profile_A, 360 );
```

2.1.5.86.10.2 Ladder Diagram

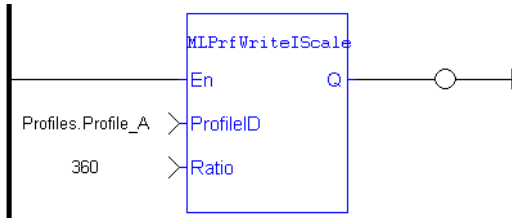

2.1.5.87.11.3 Function Block Diagram

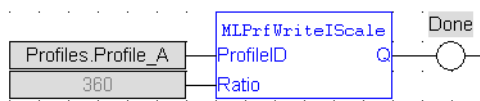

2.1.5.88 MLPrfWriteOOffset Pipe Network ✓

2.1.5.89.1 Description

Changes the Output Offset value of a selected CAM Profile. Offsets are changed on the fly to modify the CAM Profile while maintaining its shape. A change in output offset is equivalent to shifting the CAM Profile on the Y (or Output) Axis.

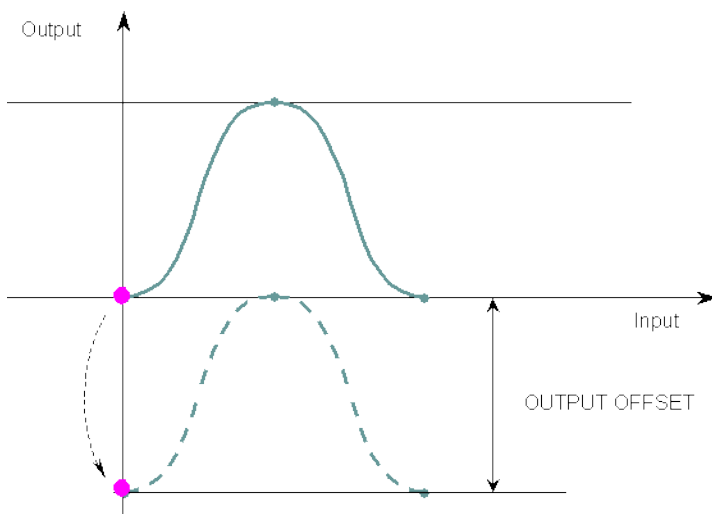

Figure 1-26: MLPrfWriteOOffset

2.1.5.90.2 Arguments

2.1.5.91.3.1 Input

ProfileID	Description Data type Range Unit Default	ID number of an initialized CAM Profile DINT [-2147483648, 2147483648] n/a —
-----------	--	--

	Description	Desired new value of Output Offset
	Data type	LREAL
Offset	Range	—
	Unit	n/a
	Default	—

2.1.5.92.4.2 Output

	Description	Returns TRUE if the Output Offset value is changed
Default (.Q)	Data type	BOOL
	Unit	n/a

2.1.5.93.5.3 Return Type

BOOL

2.1.5.94.6 Related Functions

"MLPrfReadOOffset" (→ p. 183)

"MLProfileCreate" (→ p. 463)

"MLProfileInit" (→ p. 464)

2.1.5.95.7 Example

2.1.5.96.8.1 Structured Text

```
//Change value of output offset
MLPrfWriteOOffset( Profiles.Profile_A , 45 );
```

2.1.5.97.9.2 Ladder Diagram

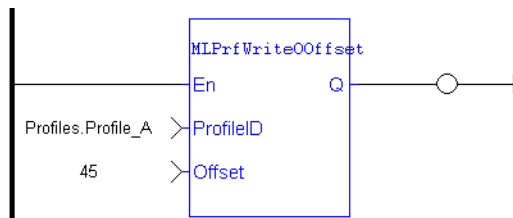

2.1.5.98.10.3 Function Block Diagram

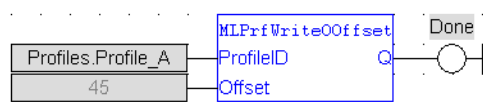

2.1.5.99 MLPrfWriteOScale Pipe Network ✓

2.1.5.100.1 Description

Set the Output Ratio value of a selected CAM Profile. Ratios are changed on the fly to modify the CAM Profile while maintaining its basic shape. A change in output ratio is equivalent to stretching, and flipping if negative (as shown on figure below), the CAM Profile on the Y (or Output) Axis.

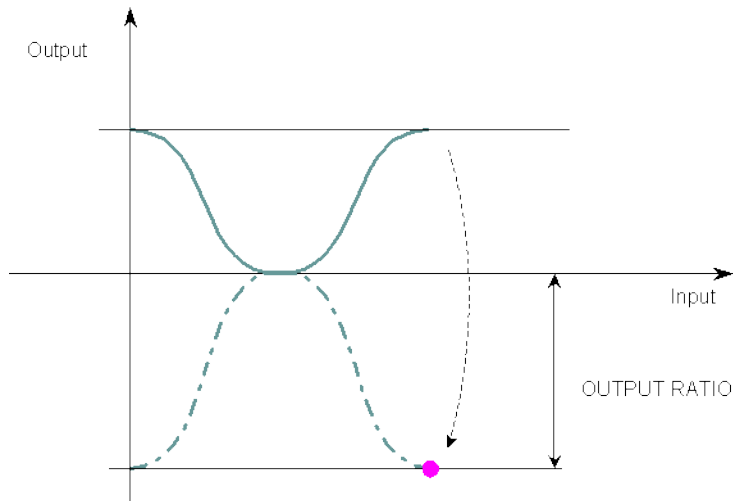

Figure 1-27: MLPfWriteOScale

2.1.5.101.2 Arguments

2.1.5.102.3.1 Input

ProfileID	Description	ID number of an initialized CAM Profile
	Data type	DINT
	Range	[-2147483648, 2147483648]
	Unit	n/a
Ratio	Description	Desired new value of Output Ratio
	Data type	LREAL
	Range	—
	Unit	n/a
	Default	—

2.1.5.103.4.2 Output

Default (.Q)	Description	Returns TRUE if the Output Ratio is changed
	Data type	BOOL
	Unit	n/a

2.1.5.104.5.3 Return Type

BOOL

2.1.5.105.6 Related Functions

"MLPrfReadOScale" (→ p. 184)

"MLProfileCreate" (→ p. 463)

"MLProfileInit" (→ p. 464)

2.1.5.106.7 Previous Function Name

MLPrfSetORatio

2.1.5.107.8 Example

2.1.5.108.9.1 Structured Text

```
//Change value of output ratio
MLPrfWriteOScale( Profiles.Profile_A , -180 );
```

2.1.5.109.10.2 Ladder Diagram

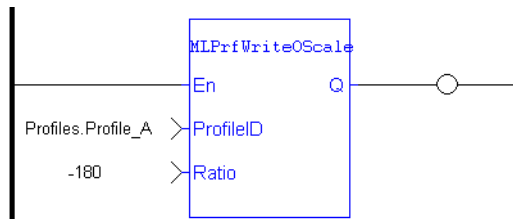

2.1.5.110.11.3 Function Block Diagram

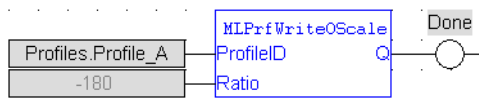

2.1.6 Motion Library - Comparator

TIP

- For a Comparator function example, see "Usage example of Comparator Functions" (→ p. 199)

Name	Description	Return type
MLCompCheck	Checks if the reference of a comparator Pipe Block has been crossed. Returns TRUE if the reference has been crossed	BOOL
MLCompInit	Initializes a comparator Pipe Block with user-defined settings	BOOL
MLCompReadRef	Returns the reference position of a comparator block	None
MLCompReset	Clears the Transition Flag of a comparator Pipe Block	BOOL
MLCompWriteRef	Sets the reference position of a comparator block	BOOL

2.1.6.1 MLCompCheck Pipe Network ✓

2.1.6.2.1 Description

Check if the reference of a comparator Pipe Block has been crossed. Returns the Transition Flag of a comparator object, which turns TRUE if the input position to the comparator is greater or equal to the reference. The Comparator Transition Flag stays TRUE until it is reset.

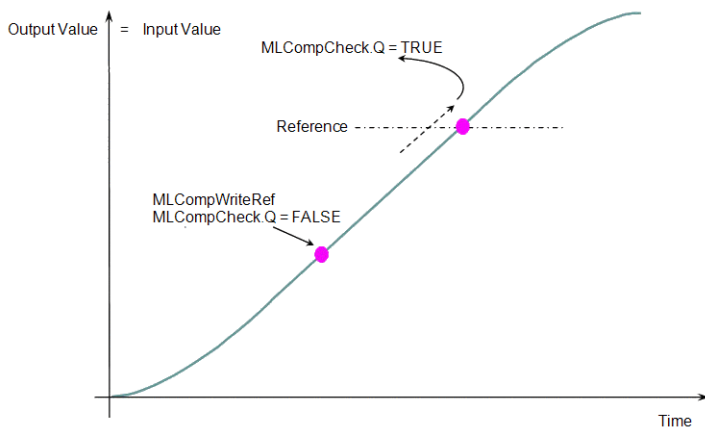

Figure 1-28: MLCompCheck

2.1.6.3.2 Arguments

2.1.6.4.3.1 Input

BlockID	Description	ID number of an initiated Comparator object
	Data type	DINT
	Range	[-2147483648, 2147483648]
	Unit	n/a
	Default	—

2.1.6.5.4.2 Output

Default (.Q)	Description	Returns TRUE if reference position of the Comparator object has been crossed
	Data type	BOOL
	Unit	n/a

2.1.6.6.5.3 Return Type

BOOL

2.1.6.7.6 Related Functions

[MLCompReset](#)

[MLCompWriteRef](#)

[MLCompReadRef](#)

2.1.6.8.7 Example

2.1.6.9.8.1 Structured Text

```
//Check if Comparator Reference has been reached
bCrossed := MLCmpCheck( PipeNetwork.MyComp );
```

2.1.6.10.9.2 Ladder Diagram

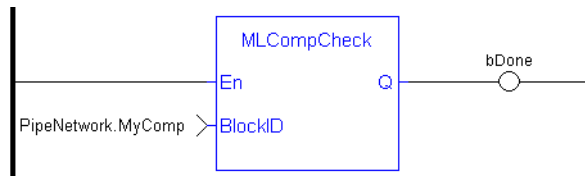

2.1.6.11.10.3 Function Block Diagram

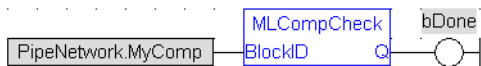

2.1.6.12 MLComplnit Pipe Network ✓

2.1.6.13.1 Description

Initializes a comparator Pipe Block for use in a PLC Program. Function block is automatically called if a Comparator Block is added to the Pipe Network, with user-defined settings entered in the Pipe Blocks Properties screen.

The Transition Flag of a comparator object turns TRUE if the input position to the comparator is greater or equal to the reference. The Comparator Transition Flag stays TRUE until it is reset.

If the input ThroughZero is set to TRUE, system must cross zero and then the reference position before the Transition Flag is set. If ThroughZero is FALSE, Transition Flag is set immediately if the input pipe position is greater or equal to the Reference value.

NOTE

Comparator objects are normally created in the Pipe Network using the graphical engine. Then you do not have to add MLComplnit function blocks to their programs. Parameters are entered directly in pop-up windows, and the code is then automatically added to the current project.

2.1.6.14.2 Arguments

2.1.6.15.3.1 Input

BlockID	Description	ID number of a created Comparator Pipe Block
	Data type	DINT
	Range	[-2147483648, 2147483648]
	Unit	n/a
	Default	—
ModuloPosition	Description	Value of the period of a cyclic system

	Data type	LREAL
	Range	—
	Unit	User unit
	Default	—
ThroughZero	Description	When TRUE, system must cross zero and then the reference position before the Transition Flag is set. If FALSE, Transition Flag is set immediately if the input pipe position is greater then or equal to the Reference value.
	Data type	BOOL
	Range	0, 1
	Unit	n/a
	Default	—
Reference	Description	Set the reference position in the new Comparator object
	Data type	LREAL
	Range	—
	Unit	User unit
	Default	—

2.1.6.16.4.2 Output

Default (.Q)	Description	Returns TRUE when function starts to execute
	Data type	BOOL
	Unit	n/a

2.1.6.17.5.3 Return Type

BOOL

2.1.6.18.6 Related Functions

[MLBlkCreate](#)

[MLCompCheck](#)

[MLCompReset](#)

[MLCompWriteRef](#)

2.1.6.19.7 Example

2.1.6.20.8.1 Structured Text

```
//Initiate a created Comparator Block named "MyComp" to:
//  Modulo of 360
//  Require the input position to first cross 0 before the
```

```
//      MLCompCheck output is triggered
//      Input compared position to 45
MyComp := MlBlkCreate( 'MyComp', 'COMPARATOR' );
MLCompInit( MyComp, 360.0, TRUE, 45.0 );
```

2.1.6.21.9.2 Ladder Diagram

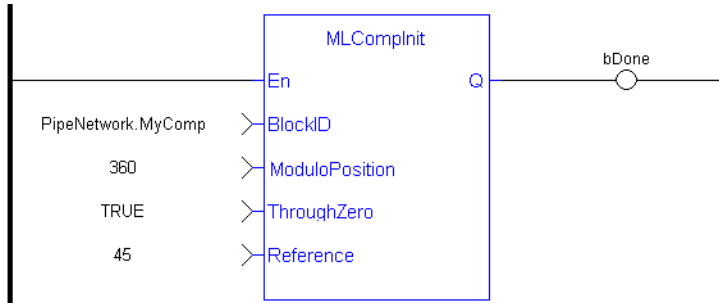

2.1.6.22.10.3 Function Block Diagram

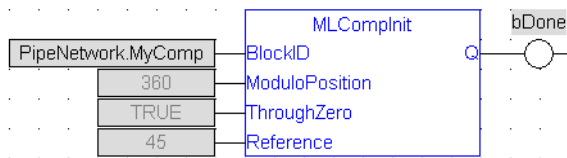

2.1.6.23 MLCompReadRef Pipe Network ✓

2.1.6.24.1 Description

Returns the reference position of a comparator block. The Transition Flag of a comparator object turns TRUE if the input position to the comparator is greater or equal to the reference. The Comparator Transition Flag stays TRUE until it is reset.

2.1.6.25.2 Arguments

2.1.6.26.3.1 Input

BlockID	Description	ID number of an initiated Comparator object
	Data type	DINT
	Range	[-2147483648, 2147483648]
	Unit	n/a
	Default	—

2.1.6.27.4.2 Output

Reference	Description	Returns the current reference position of the Comparator object
	Data type	LREAL
	Unit	User unit

2.1.6.28.5 Related Functions

[MLCompWriteRef](#)

[MLCompReset](#)

[MLCompCheck](#)

2.1.6.29.6 Example

2.1.6.30.7.1 Structured Text

```
//Return the Comparator Reference value
CompRef := MLCompReadRef( PipeNetwork.MyComp );
```

2.1.6.31.8.2 Ladder Diagram

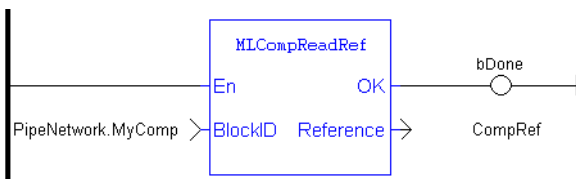

2.1.6.32.9.3 Function Block Diagram



2.1.6.33 MLCompReset Pipe Network ✓

2.1.6.34.1 Description

Clear the Transition Flag of a comparator Pipe Block. The Transition Flag of a comparator object turns TRUE if the input position to the comparator is greater or equal to the reference. The Comparator Transition Flag stays TRUE until it is reset.

2.1.6.35.2 Arguments

2.1.6.36.3.1 Input

BlockID	Description	ID number of an initiated Comparator object
	Data type	DINT
	Range	[-2147483648, 2147483648]
	Unit	n/a
	Default	—

2.1.6.37.4.2 Output

Default (.Q)	Description	Returns TRUE when function starts to execute
---------------------	--------------------	--

Data type	BOOL
Unit	n/a

2.1.6.38.5.3 Return Type

BOOL

2.1.6.39.6 Related Functions

[MLCompCheck](#)

[MLCompReadRef](#)

[MLCompWriteRef](#)

2.1.6.40.7 Example

2.1.6.41.8.1 Structured Text

```
//Clear the Transition Flag of a Comparator object
MLCompReset ( PipeNetwork.MyComp );
```

2.1.6.42.9.2 Ladder Diagram

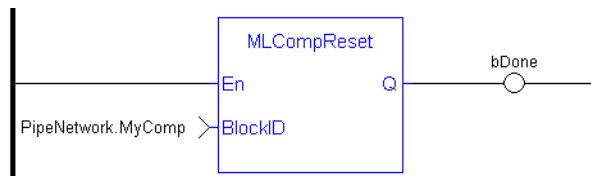

2.1.6.43.10.3 Function Block Diagram



2.1.6.44 MLCompWriteRef Pipe Network ✓

2.1.6.45.1 Description

Set the reference position of a comparator block. The Transition Flag of a comparator object turns TRUE if the input position to the comparator is greater or equal to the reference. The Comparator Transition Flag stays TRUE until it is reset.

If the input ThroughZero is set to TRUE, system must cross zero and then the reference position before the Transition Flag is set. If ThroughZero is FALSE, Transition Flag is set immediately if the input pipe position is greater then or equal to the Reference value.

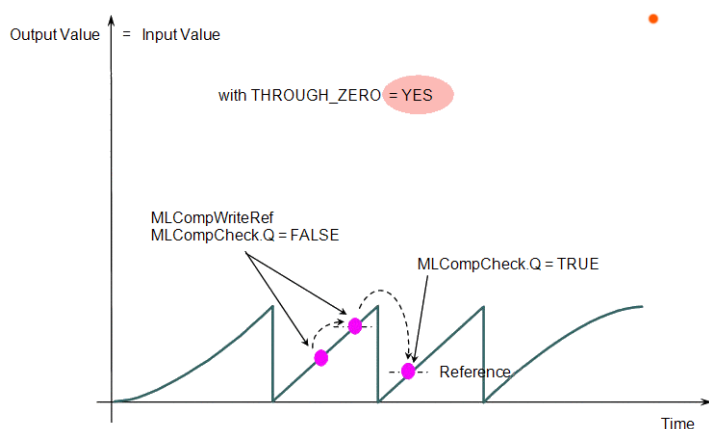

Figure 1-29: MLCompWriteRef

2.1.6.46.2 Arguments

2.1.6.47.3.1 Input

BlockID	Description	ID number of an initiated Comparator object
	Data type	DINT
	Range	[-2147483648, 2147483648]
	Unit	n/a
	Default	—
ThroughZero	Description	When TRUE, system must cross zero and then the reference position before the Transition Flag is set. If FALSE, Transition Flag is set immediately if the input pipe position is greater then or equal to the Reference value.
	Data type	BOOL
	Range	0, 1
	Unit	n/a
	Default	—
Reference	Description	New reference position to set in the selected Comparator object
	Data type	LREAL
	Range	—
	Unit	User unit
	Default	—

2.1.6.48.4.2 Output

Default (.Q)	Description	Returns TRUE when function starts to execute
	Data type	BOOL

Unit

n/a

2.1.6.49.5.3 Return Type

BOOL

2.1.6.50.6 Related Functions[MLCompCheck](#)[MLCompReadRef](#)[MLCompReset](#)**2.1.6.51.7 Example****2.1.6.52.8.1 Structured Text**

```
//Set the Comparator Reference value
MLCompWriteRef( PipeNetwork.MyComp , TRUE , 45 );
```

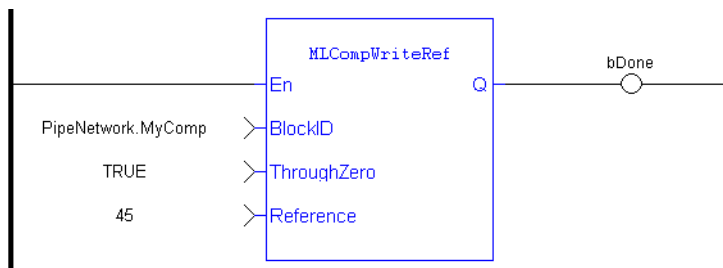
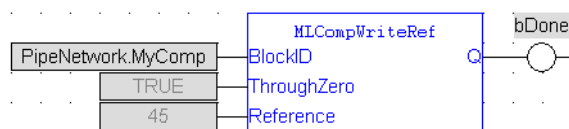
2.1.6.53.9.2 Ladder Diagram**2.1.6.54.10.3 Function Block Diagram****2.1.6.55 Usage example of Comparator Functions**

When you call the **MLCompWriteRef** function, the output for **MLCompCheck** becomes True as soon as the input value reaches the reference.

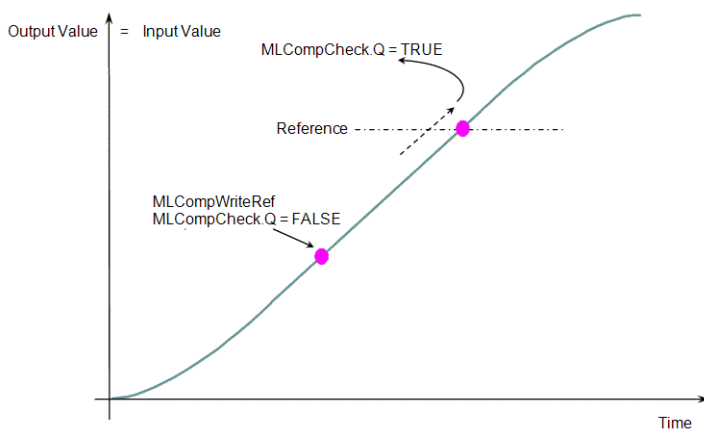
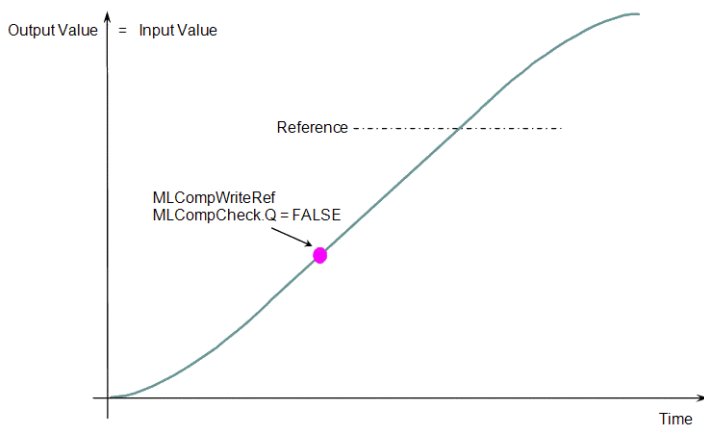

The same function can also be called for a cyclic input value.

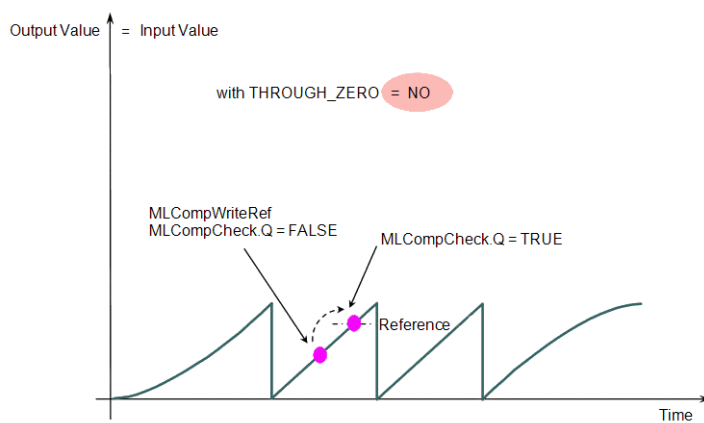
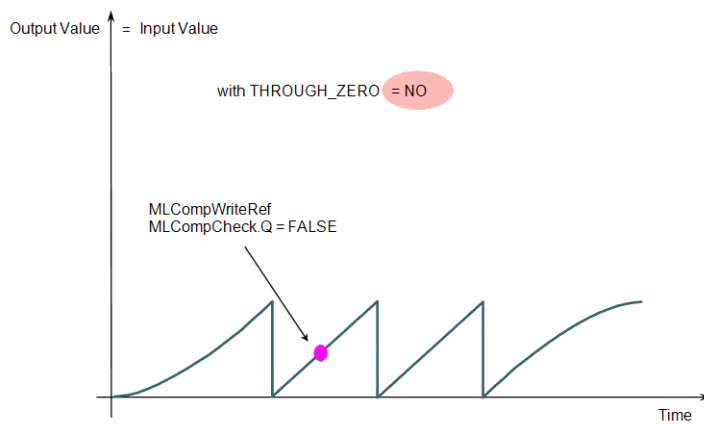

When the THROUGH_ZERO parameter is set to YES, the output for MLCompCheck becomes True as soon as the input value reaches the reference, but not before it has passed through zero.

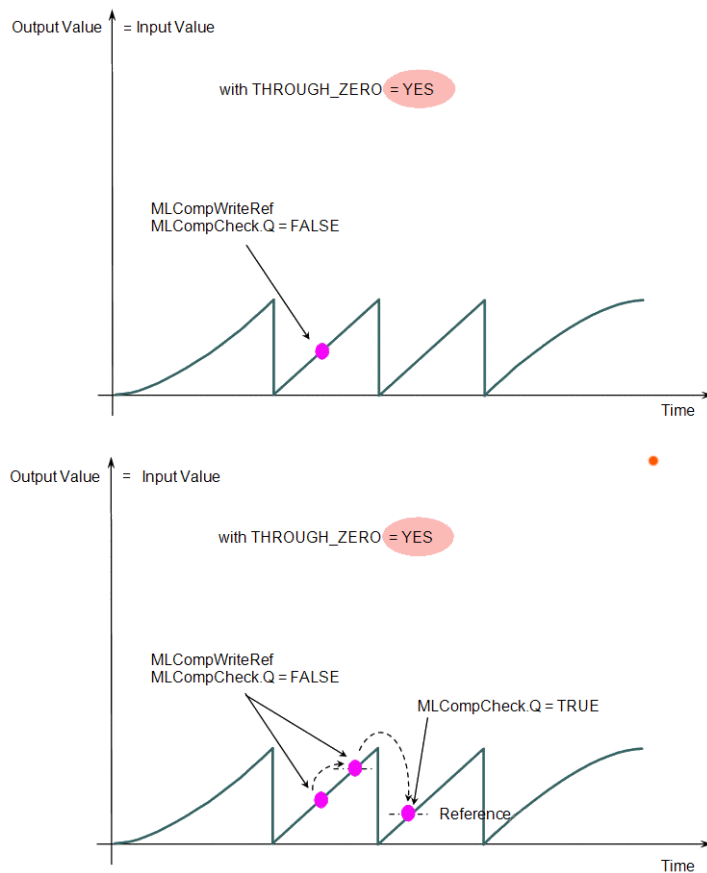

Figure 1-30: Comparator Functions Usage

2.1.7 Motion Library - Convertor

Name	Description	Return type
"MLCNVConnect" (→ p. 201)	Connects a converter Pipe Block to the specified axis	BOOL
"MLCNVConnectEx" (→ p. 203)	Connects an extra converter Pipe Block to the specified axis. This function connects the output of a pipe to an axis data other than the control position.	BOOL
"MLCNVDisconnect" (→ p. 207)	Disconnects a converter Pipe Block from its associated axis	BOOL
"MLCNVInit" (→ p. 208)	Initializes a converter Pipe Block in Position or Speed mode	BOOL

2.1.7.1 MLCNVConnect

2.1.7.2.1 Description

Connect a converter Pipe Block to the specified axis. When using the Pipe Network for coordinated motion, Pipe Blocks have to be Activated, Connected, and then Powered On before move commands work.

The Converter block changes the incoming flow of values to continuous position output with no periodicity. If a converter block is not connected to an Axis, it does not send position output values to its assigned Axis. Every pipe branch must end in a converter, whether or not it is connected to a destination Axis object, as seen in Figure 1 below.

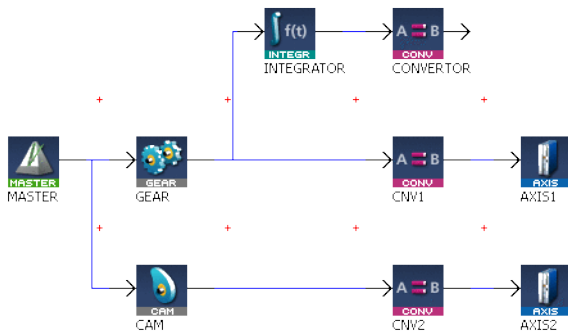

Figure 1-31: MLCNVConnect

NOTE

All converters in the Pipe Network can be connected at once with the command PipeNetwork(MLPN_Connect). This calls automatically generated code with MLCNVConnect commands for each Converter block. Therefore, in a multi-axis program only one command can be used to connect Pipe Blocks instead of writing code for each Axis separately.

TIP

The converter block has the ability to control the analog output on the AKD. See for information on the parameters.

2.1.7.3.2 Arguments

2.1.7.4.3.1 Input

BlockID	Description	ID number of an initiated Converter object
	Data type	DINT
	Range	[-2147483648, 2147483648]
	Unit	n/a
	Default	—
AxisID	Description	ID number of an initiated Axis object
	Data type	DINT
	Range	[-2147483648, 2147483648]
	Unit	n/a
	Default	—

2.1.7.5.4.2 Output

Default (.Q)	Description	Returns TRUE if the converter is connected to the Axis object
	Data type	BOOL
	Unit	n/a

2.1.7.6.5.3 Return Type

BOOL

2.1.7.7.6 Related Functions

"MLCNVConnectEx" (→ p. 203)

"MLCNVDisconnect" (→ p. 207)

"MLCNVInit" (→ p. 208)

2.1.7.8.7 Example

2.1.7.9.8.1 Structured Text

```
//Connect a converter Pipe Block named "CNV1" to Pipe Block
AXIS1
MLCNVConnect( PipeNetwork.CNV1, AXIS1 );
```

2.1.7.10.9.2 Ladder Diagram

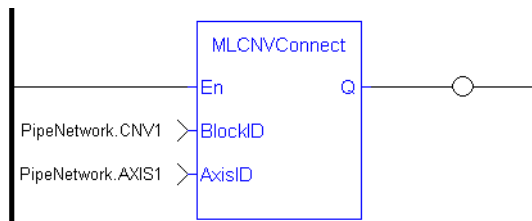

2.1.7.11.10.3 Function Block Diagram

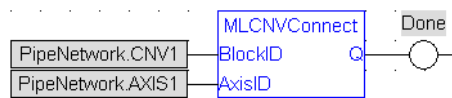

2.1.7.12 MLCNVConnectEx

2.1.7.13.1 Description

Connect a converter Pipe Block to the specified axis. This function connects the output of a pipe to an axis data other than the control position. With this function, several converter Pipe Blocks can connect to the same axis and acts on different data.

Normally a Converter block sends position values to an Axis. However, some cases exist that require additional information such as torque feed-forward (IDN 3056) that needs to be provided by a second converter.

NOTE

This FB does not work when you choose to [simulate](#) the device. In such a case, the FB continuously generates error messages displayed in the Controller log window.

NOTE

Need to add 16#8000 to desired IDN number for ValueID input. 8000 in hexadecimal signals a vendor-specific IDN value.

2.1.7.14.2 Arguments

2.1.7.15.3.1 Input

BlockID	Description
	ID number of an initiated Converter object
	Data type
	DINT

	Range	[-2147483648, 2147483648]
	Unit	n/a
	Default	—
AxisID	Description	ID number of an initiated Axis object
	Data type	DINT
	Range	[-2147483648, 2147483648]
	Unit	n/a
	Default	—
ValueID	Description	<p>Specify the following constant:</p> <ul style="list-style-type: none"> • <code>EC_ADDITIVE_TORQUE_VALUE</code> (for torque feed-forward) • EC_ANALOG_OUTPUT (for control of Analog Output: AKD parameter: "AOUT.VALUEU") <p>If the Analog Output is mapped to a PLC variable, the connection to the analog output by <code>EC_ANALOG_OUTPUT</code> will not work as the output value will be overwritten by the PLC mapped variable data. In order to function properly the AOUT.MODE must be set to "User Mode (mode = 0)".</p> <p>See the TIP below for more information.</p>
	Data type	DINT
	Range	[-2147483648, 2147483648]
	Unit	n/a
	Default	—
ValueInfo	Description	This value is ignored and must be set to zero
	Data type	DINT
	Range	[-2147483648, 2147483648]
	Unit	n/a
	Default	—

TIP

The PDO values will be overwritten by Mapped PLC variables including a possible link to the mapping of variables or the section on `MLParamWrite()` warning indicating that the function block write of Analog output will be overwritten by the `MLCnvConnectEx` function.

Precedence rules:

1. A PLC variable mapped to Analog Output takes precedence.
2. If `MLCNVConnect` assigns a Pipe output to Analog Output it will take precedence over a `DriveParamWrite` function call.

3. DriveParamWrite will modify the Analog Output but get overwritten by the higher precedent options if they are present.

2.1.7.16.4.2 Output

Default (.Q)	Description	Returns TRUE if the converter is connected to the Axis object
	Data type	BOOL
	Unit	n/a

2.1.7.17.5.3 Return Type

BOOL

2.1.7.18.6 Related Functions

"MLCNVConnect" (→ p. 201)

"MLCNVDisconnect" (→ p. 207)

"MLCNVInit" (→ p. 208)

2.1.7.19.7 Example

2.1.7.20.8.1 Structured Text

```
//Connect a converter Pipe Block named "CNV1" to the pipe block
named AXIS1, And send feed-forward (EC_ADDITIVE_TORQUE_VALUE) to
the drive
MLCNVConnectEx( PipeNetwork.CNV1, PipeNetwork.AXIS1, EC_
ADDITIVE_TORQUE_VALUE, 0 );
```

2.1.7.21.9.2 Ladder Diagram

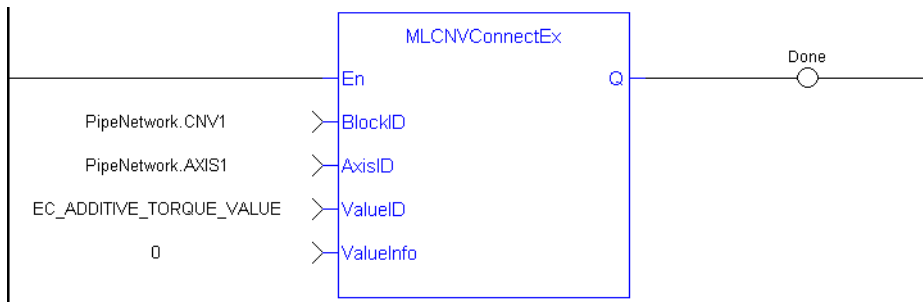

2.1.7.22.10.3 Function Block Diagram

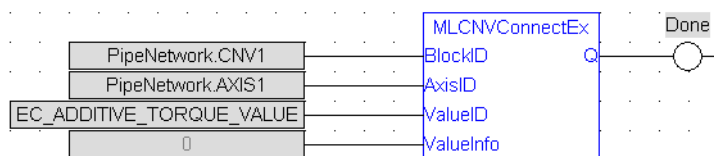

2.1.7.23 MLCNVConECAT

2.1.7.24.1 Description

This function will connect the output of a pipe convertor block to an EtherCAT Output (Rx) PDO object. The output value of the convertor block will then be written to the PDO object every update of the convertor block. The pipe block is specified by the BlockID input and the PDO object is specified by the DeviceAddr, Index, and SubIndex inputs.

2.1.7.25.2 Arguments

2.1.7.26.3.1 Input

BlockID	Description	The convertor block whose output value will be written to the PDO object. For example: PipeNetwork:CNV1
	Data type	DINT
	Range	n/a
	Unit	n/a
	Default	—
DeviceAddr	Description	The device address of the PDO object to be written. EtherCAT devices are numbered in order with the first device being 1001, the second 1002, etc.
	Data type	INT
	Range	n/a
	Unit	n/a
	Default	—
Index	Description	The index of the PDO object to be written. The index can be determined from the table located in the “PDO Selection/Mapping” tab of the EtherCAT device page. (In Project Explorer, under EtherCAT, select the device, then select the PDO Selection/Mapping tab.)
	Data type	UINT
	Range	n/a
	Unit	n/a
	Default	—
SubIndex	Description	The sub index of the PDO object to be written. The sub index can be determined from the table located in the “PDO Selection/Mapping” tab of the EtherCAT device page. (In Project Explorer, under EtherCAT, select the device, then select the PDO Selection/Mapping tab.)
	Data type	USINT
	Range	n/a
	Unit	n/a
	Default	—

2.1.7.27.4.2 Output

Default (.Q)	Description	Returns TRUE if this function has successfully connected the output of the pipe convertor block to the EtherCAT Output (Rx) PDO Object.
	Data type	BOOL
	Unit	n/a

2.1.7.28.5 Related Functions

"MLCNVDisconnect" (→ p. 207)

"MLCNVInit" (→ p. 208)

2.1.7.29.6 Example

2.1.7.30.7.1 Structured Text

```
//Connect a converter Pipe Block named "CNV2" to PDO 16#60B2
(Accel FF) on ECAT address 1002.
MLCNVConECAT( PipeNetwork.CNV2, 1002, 16#60B2, 0 );
```

2.1.7.31.8.2 Ladder Diagram

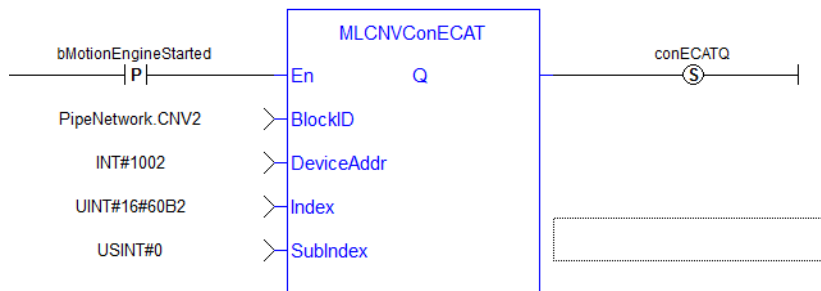

2.1.7.32.9.3 Function Block Diagram

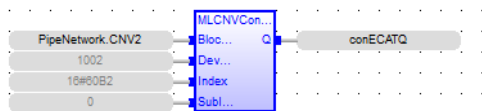

2.1.7.33 MLCNVDisconnect

2.1.7.34.1 Description

Disconnect a converter Pipe Block from its associated axis.

If a converter block is not connected to an Axis, it does not send position output values to its assigned Axis. Can disconnect one or multiple Axis from the Pipe Network and still send single-axis motion commands. Axis can be disconnected while the Pipe Positions are reset to different values or if coordinated motion is only not needed with every axis in the project in a certain state.

2.1.7.35.2 Arguments

2.1.7.36.3.1 Input

BlockID	Description	ID number of an initiated Converter object
----------------	--------------------	--

Data type	DINT
Range	[-2147483648, 2147483648]
Unit	n/a
Default	—

2.1.7.37.4.2 Output

Default (.Q)	Description	Returns TRUE if the converter is disconnected from the Axis object
	Data type	BOOL
	Unit	n/a

2.1.7.38.5.3 Return Type

BOOL

2.1.7.39.6 Related Functions

"MLCNVConnect" (→ p. 201)

"MLCNVInit" (→ p. 208)

2.1.7.40.7 Example

2.1.7.41.8.1 Structured Text

```
//Disconnect a converter Pipe Block name " CNV1" from its
present connection
MLCNVDisconnect( PipeNetwork.CNV1);
```

2.1.7.42.9.2 Ladder Diagram

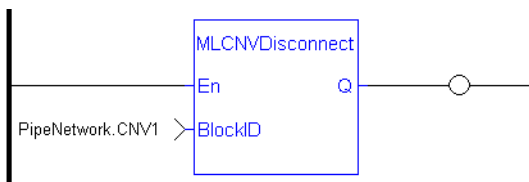

2.1.7.43.10.3 Function Block Diagram

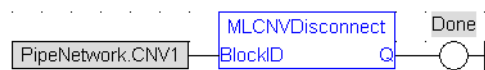

2.1.7.44 MLCNVInit

2.1.7.45.1 Description

Initializes a converter Pipe Block. Function block is automatically called if a Converter Block is added to the Pipe Network, with the input mode (position or speed) entered in the Pipe Blocks Properties screen. The Converter block changes the incoming flow of speed or position values to continuous position output with no periodicity.

NOTE

Converter objects are normally created in the Pipe Network using the graphical engine. Then you do not have to add MLCNVInit function blocks to their programs. Parameters are entered directly in pop-up windows, and the code is then automatically added to the current project.

2.1.7.46.2 Arguments**2.1.7.47.3.1 Input**

BlockID	Description	ID number of a created Pipe Block
	Data type	DINT
	Range	[-2147483648, 2147483648]
	Unit	n/a
	Default	—
Mode	Description	1 for Position mode, 2 for Speed mode. Determines the type of input to the Converter Object.
	Data type	DINT
	Range	[1, 2]
	Unit	n/a
	Default	—

2.1.7.48.4.2 Output

Default (.Q)	Description	Returns TRUE if the Converter Pipe Block is initialized
	Data type	BOOL
	Unit	n/a

2.1.7.49.5.3 Return Type

BOOL

2.1.7.50.6 Related Functions

[MLBlkCreate](#)

"MLCNVConnect" (→ p. 201)

2.1.7.51.7 Example**2.1.7.52.8.1 Structured Text**

```
// Initiate a created convertor block named "CNV1"
CNV1 := MLBlkCreate( 'CNV1', 'CONVERTOR' );
MLCNVInit( CNV1, 1 );
```

2.1.7.53.9.2 Ladder Diagram

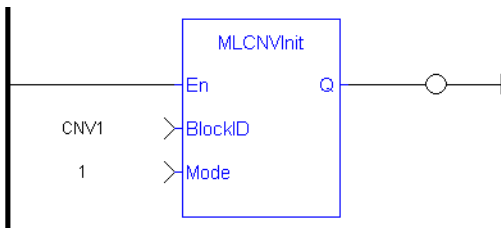

2.1.7.54.10.3 Function Block Diagram

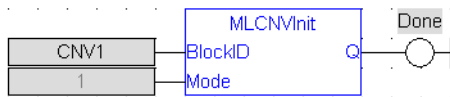

2.1.8 Motion Library - Delay

Name	Description	Return type
"MLDelayInit" (→ p. 210)	Initializes a delay object	BOOL

2.1.8.1 MLDelayInit Pipe Network ✓

2.1.8.2.1 Description

Initializes a delay object. Returns TRUE if the function succeeded. This FB is automatically created in the compiled code of a Pipe Network. It is included in the MLPN_CREATE_OBJECT (created in ST) which is typically executed in a project as part of the startup sequence of the Pipe Network.

2.1.8.3.2 Arguments

2.1.8.4.3.1 Input

BlockID	Description	ID number of a created Pipe Block
	Data type	DINT
	Range	[-2147483648, 2147483648]
	Unit	n/a
	Default	—
CycleDelay	Description	Number of delay cycles
	Data type	DINT
	Range	[0, 9]
	Unit	Cycle
	Default	0

2.1.8.5.4.2 Example

2.1.8.6.5.3 Structured Text

```
MLDelayInit(PipeNetwork.DELAY1, 2 );
```

2.1.8.7.6.4 Ladder Diagram

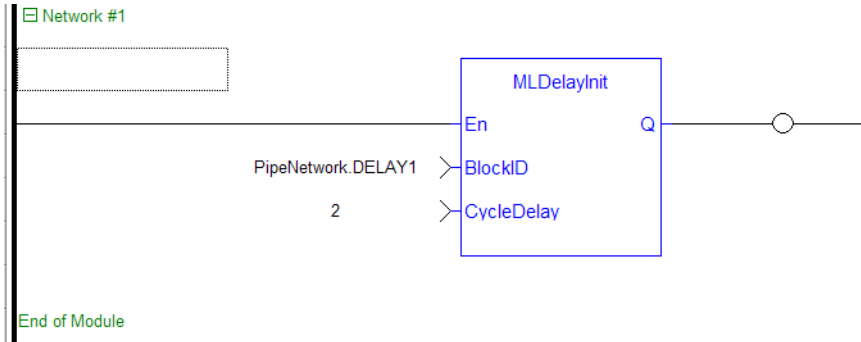

2.1.8.8.7.5 Function Block Diagram



2.1.9 Motion Library - Derivator

Name	Description	Return type
MLDerInit	Initializes a derivator object	BOOL
MLDerReadInModPos	Returns the input MODULO_POSITION of the Derivator block	None
MLDerWriteInModPos	Sets the input MODULO_POSITION of the Derivator block	BOOL

2.1.9.1 MLDerInit Pipe Network ✓

2.1.9.2.1 Description

Initializes an derivator object. Function block is automatically called if a Derivator Block is added to the Pipe Network, with user-defined settings entered in the Pipe Blocks Properties screen. Input ModuloPosition is defined to manage the periodicity (modulo) of the input values.

NOTE

Derivator objects are normally created in the Pipe Network using the graphical engine. Then you do not have to add MLDerInit function blocks to their programs. Parameters are entered directly in pop-up windows, and the code is then automatically added to the current project.

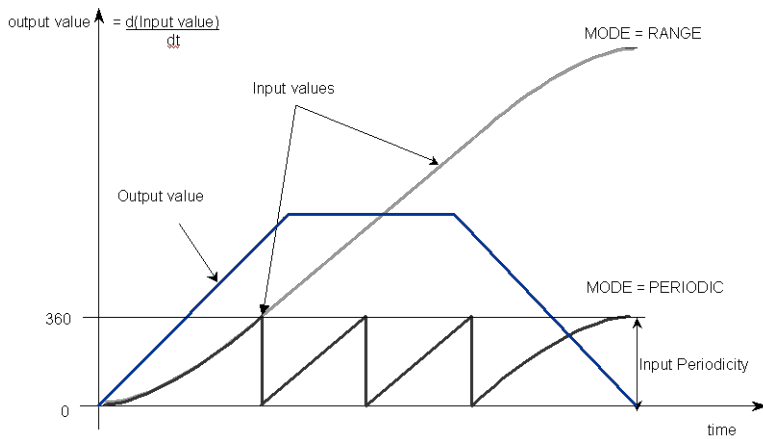

Figure 1-32: MLDerInIt

2.1.9.3.2 Arguments

2.1.9.4.3.1 Input

BlockID	Description	ID number of a created Pipe Block
	Data type	DINT
	Range	[-2147483648, 2147483648]
	Unit	n/a
	Default	—
ModuloPosition	Description	Input ModuloPosition of Derivator object
	Data type	LREAL
	Range	—
	Unit	User unit
	Default	360.0

2.1.9.5.4.2 Output

Default (.Q)	Description	Returns TRUE if the Derivator object is initialized
	Data type	BOOL
	Unit	n/a

2.1.9.6.5.3 Return Type

BOOL

2.1.9.7.6 Related Functions

[MLBlkCreate](#)

[MLDerReadInModPos](#)

[MLDerWriteInModPos](#)

2.1.9.8.7 Example

2.1.9.9.8.1 Structured Text

```
//Create and Initiate a Derivator object
MyDerivator := MlBlkCreate( 'MyDerivator', 'DERIVATOR' );
MLDerInit( MyDerivator, 360.0 );
```

2.1.9.10.9.2 Ladder Diagram

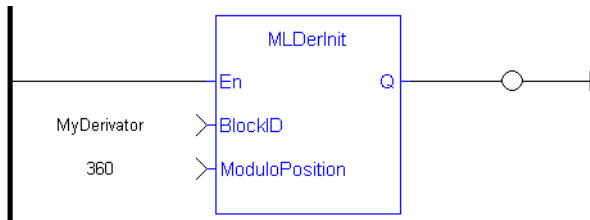

2.1.9.11.10.3 Function Block Diagram

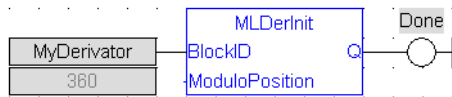

2.1.9.12 MLDerReadInModPos Pipe Network ✓

2.1.9.13.1 Description

Returns the Input ModuloPosition of the derivator block. Input ModuloPosition is defined to manage the periodicity (modulo) of the input values.

For example, if the input value increases each millisecond by one degree then the output value is 1000 degrees per second. Now lets imagine that the input value skips suddenly from 359 to 0

- If Input ModuloPosition = 360, the output continues to indicate 1000 degrees per second, indicating that rollover into the next period has been properly handled

- If Input ModuloPosition = 1000, the output then indicates 359,000 degrees per second, indicating that the input has incorrectly interpreted roll-over as a 359 degree move in one millisecond

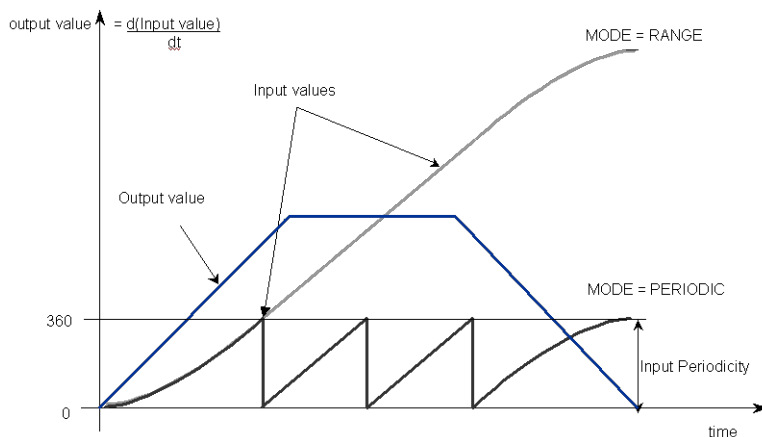

Figure 1-33: MLDerReadInModPos

NOTE

The first calculation of a Derivator Pipe Block just after the pipe installation indicates zero regardless of the initial input value.

2.1.9.14.2 Arguments

2.1.9.15.3.1 Input

ID	Description	ID number of an initiated Derivator object
	Data type	DINT
	Range	[-2147483648, 2147483648]
	Unit	n/a
	Default	—

2.1.9.16.4.2 Output

ModuloPosition	Description	Current Input ModuloPosition of the selected Derivator object
	Data type	LREAL
	Unit	User unit
	Default	—

2.1.9.17.5 Related Functions

[MLDerWriteInModPos](#)

[MLDerInit](#)

2.1.9.18.6 Example

2.1.9.19.7.1 Structured Text

```
//save the current input MODULO_POSITION of a Derivator object
DerInputPeriod := MLDerReadInModPos ( PipeNetwork.MyDerivator
);
```

2.1.9.20.8.2 Ladder Diagram

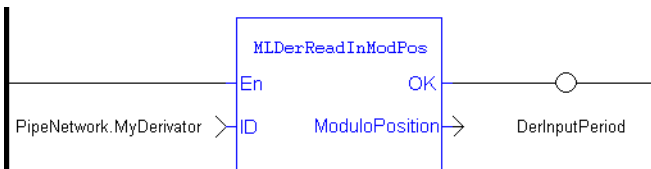

2.1.9.21.9.3 Function Block Diagram

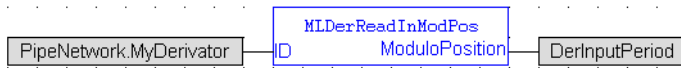

2.1.9.22 MLDerWriteInModPos Pipe Network ✓

2.1.9.23.1 Description

Sets the Input ModuloPosition of the Derivator block. Input ModuloPosition is defined to manage the periodicity (modulo) of the input values.

For example, if the input value increases each millisecond by one degree then the output value is 1000 degrees per second. Now lets imagine that the input value skips suddenly from 359 to 0

-If Input ModuloPosition = 360, the output continues to indicate 1000 degrees per second, indicating that rollover into the next period has been properly handled

-If Input ModuloPosition = 1000, the output then indicates 359,000 degrees per second, indicating that the input has incorrectly interpreted roll-over as a 359 degree move in one millisecond

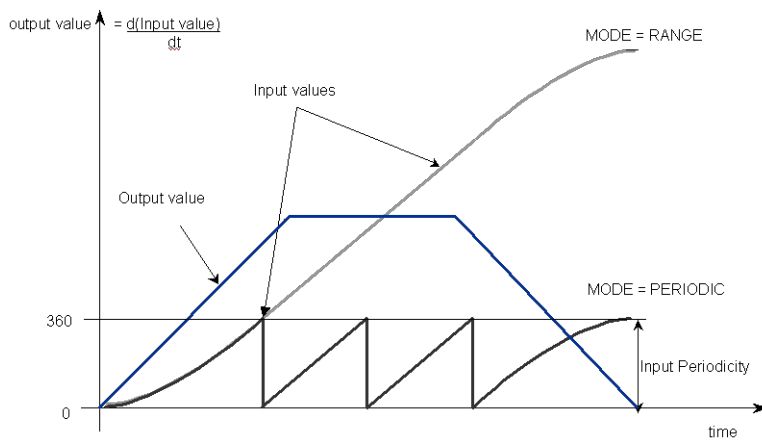

Figure 1-34: MLDerWriteInModPos

NOTE
The first calculation of a Derivator Pipe Block just after the pipe installation indicates zero regardless of the initial input value.

2.1.9.24.2 Arguments

2.1.9.25.3.1 Input

ID	Description	ID number of an initiated Derivator object
	Data type	DINT
	Range	[-2147483648, 2147483648]
	Unit	n/a
	Default	—
ModuloPosition	Description	Desired new value of Input ModuloPosition of the selected Derivator object
	Data type	LREAL
	Range	—

Unit	User unit
Default	—

2.1.9.26.4.2 Output

Default (.Q)	Description	Returns TRUE if the Input ModuloPosition value is changed
	Data type	BOOL
	Unit	n/a

2.1.9.27.5.3 Return Type

BOOL

2.1.9.28.6 Related Functions

[MLDerReadInModPos](#)

[MLDerInIt](#)

2.1.9.29.7 Example

2.1.9.30.8.1 Structured Text

```
//change the input MODULO_POSITION of a Derivator object to 720
MLDerWriteInModPos ( PipeNetwork.MyDerivator, 720 );
```

2.1.9.31.9.2 Ladder Diagram

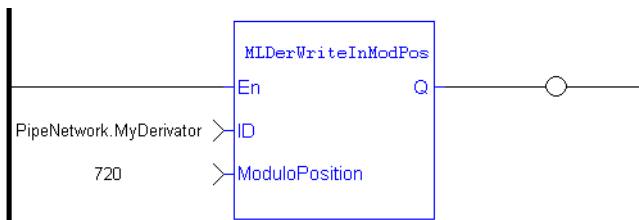

2.1.9.32.10.3 Function Block Diagram

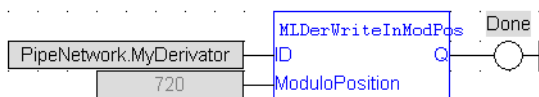

2.1.10 Motion Library - Gear

Name	Description	Return type
"MLGearInIt" (→ p. 219)	Initializes a Gear Pipe Block with user-defined settings	BOOL
"MLGearReadOffset" (→ p. 222)	Returns the offset value of selected Gear Block	None

Name	Description	Return type
"MLGearReadOffSlp" (→ p. 223)	Returns the Offset Slope value of selected Gear Block	None
"MLGearReadRatio" (→ p. 224)	Returns the ratio value of a gear block	None
"MLGearReadRatSlp" (→ p. 225)	Returns the ratio slope value of a gear block	None
"MLGearWriteOff" (→ p. 226)	Sets the Offset value of a selected Gear Pipe Block	BOOL
"MLGearWriteOSlp" (→ p. 228)	Sets the Offset Slope value of a selected Gear Pipe Block	BOOL
"MLGearWriteRatio" (→ p. 229)	Sets the Ratio value of a selected Gear Pipe Block	BOOL
"MLGearWriteRatSlp" (→ p. 231)	Sets the Ratio Slope value of a selected Gear Pipe Block	BOOL

2.1.10.1 Usage example of Gear Functions

The output value starts with offset = 0 and gain = 1 (blue line)

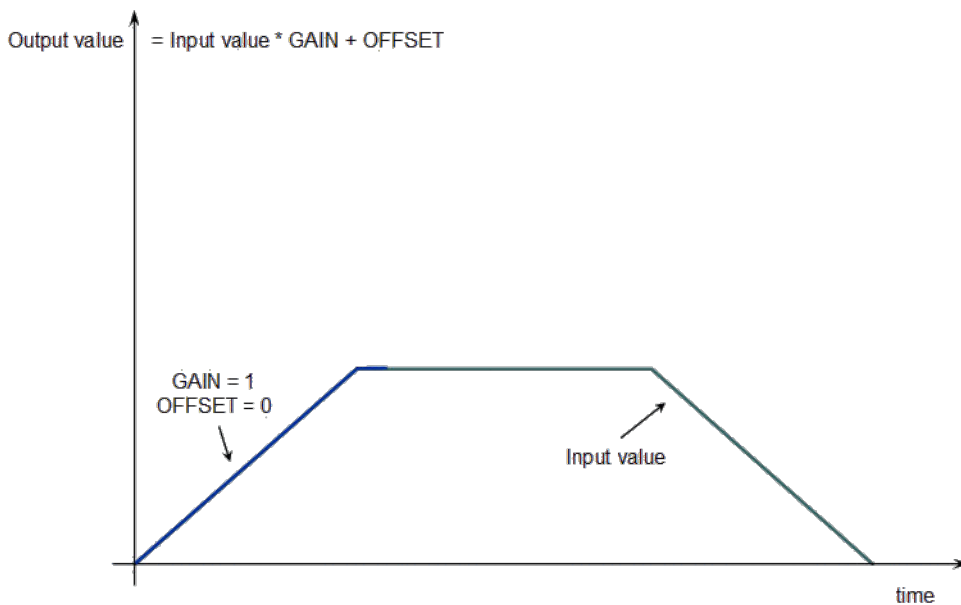

You can call the **MLGearWriteOff** function to modify the Offset (where Offset_Slope is set with the **MLGearWriteOSlp** function).

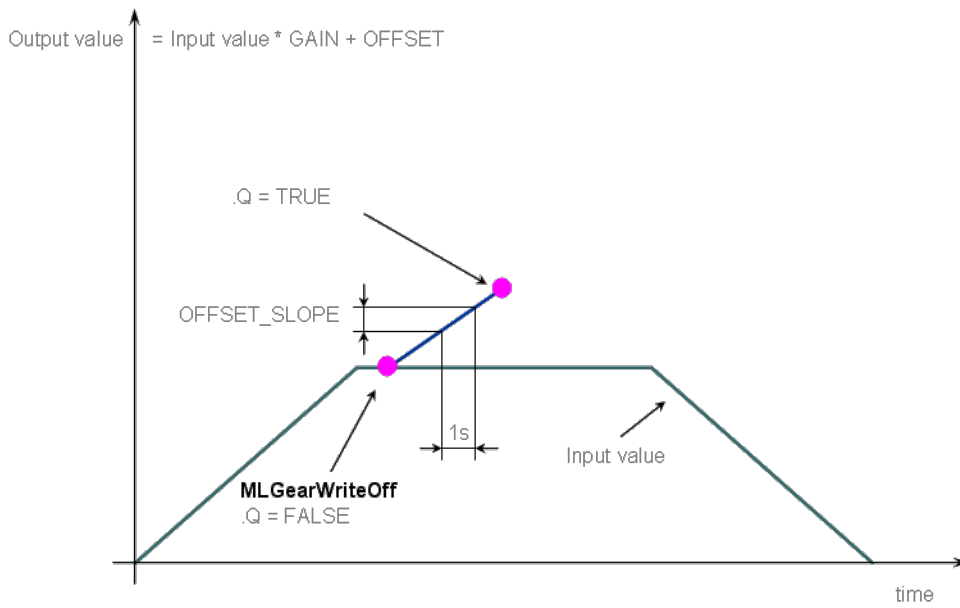

After setting the Offset (Q=TRUE in the previous figure), you can call the **MLGearWriteRatio** function to modify the gear Ratio (where Gain_Slope is set with the **MLGearWriteRatSlp** function).

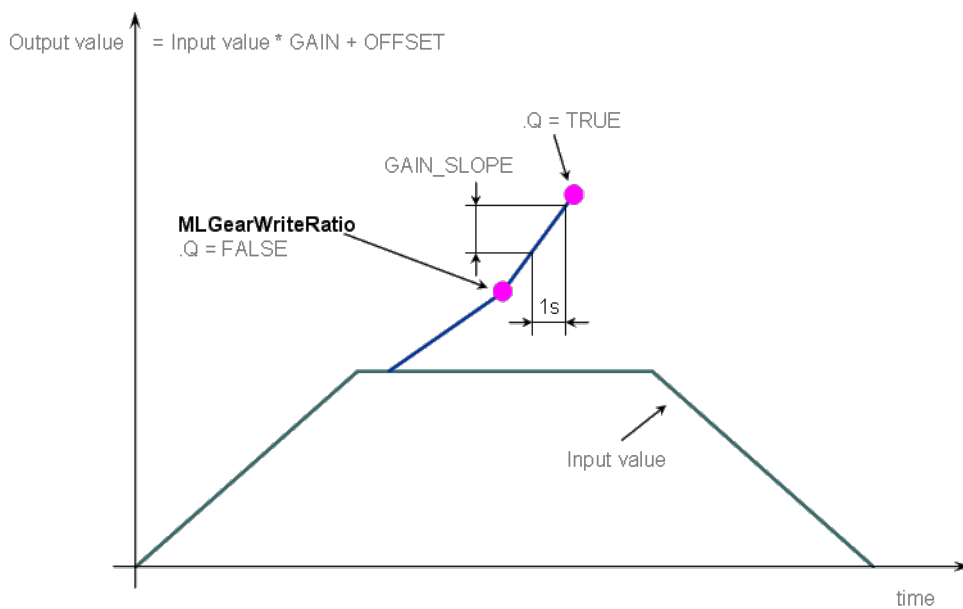

The output value is finally adapted with the gear offset and ratio (blue line).

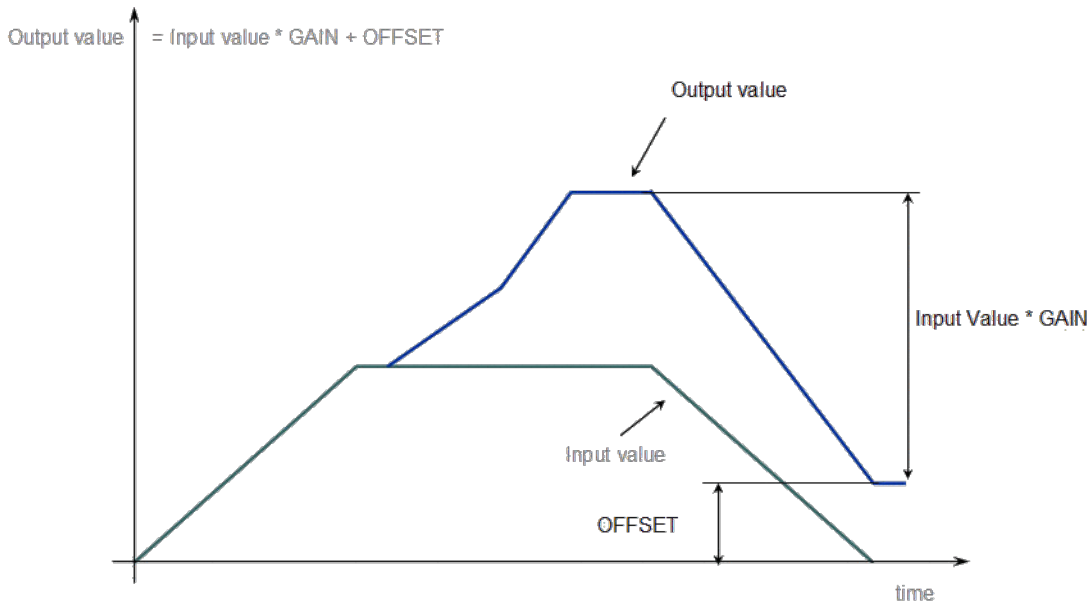

Figure 1-35: Gear Functions Usage

2.1.10.2 MLGearInit Pipe Network ✓

2.1.10.3.1 Description

Initializes a Gear Pipe Block for use in a PLC Program. Function block is automatically called if a Gear Block is added to the Pipe Network, with user-defined settings entered in the Pipe Blocks Properties screen.

The Pipe Block is assigned a **Name**, **Ratio**, **Offset**, and **Slopes** for changes in Ratio and Offset values. You can also choose between Modulo or Not modulo mode. Slopes set the limit at which step changes in Ratio and Offset are implemented.

The output of a Gear Block = Input value * Ratio + Offset

NOTE

Be sure to set $\text{RatioSlope} < (\text{Ratio} * \text{EtherCAT Update Rate})$. The Gear block will make a jump (without a ramp) from one gear to the next when the RatioSlope is greater than the Ratio change factor multiplied by the update rate scale factor.

TIP

Gear objects are normally created in the Pipe Network using the graphical engine. Then you do not have to add MLGearInit function blocks to their programs. Parameters are entered directly in pop-up windows, and the code is then automatically added to the current project.

2.1.10.4.2 Arguments

2.1.10.5.3.1 Input

BlockID	Description	ID number of a created Pipe Block
	Data type	DINT
	Range	[-2147483648, 2147483648]
	Unit	n/a

	Default	GEAR
Ratio	Description	Ratio of new Gear Pipe Block. Values lower than 1.0 can be entered, but require a leading zero (for example 0.8 instead of .8)
	Data type	LREAL
	Range	—
	Unit	n/a
	Default	1.0
Offset	Description	Offset of new Gear Pipe Block. Values lower than 1.0 can be entered, but require a leading zero (for example 0.8 instead of .8)
	Data type	LREAL
	Range	—
	Unit	n/a
	Default	0.0
UseUserRatioSlope	Description	FALSE to use the maximum Slope, causing an instantaneous gear change within one cycle. TRUE to use user-defined RatioSlope
	Data type	BOOL
	Range	0, 1
	Unit	n/a
	Default	FALSE
RatioSlope	Description	User-defined limit at which step changes in Ratio are implemented. Values lower than 1.0 can be entered, but require a leading zero (for example 0.8 instead of .8)
	Data type	LREAL
	Range	—
	Unit	1/sec
	Default	0.0
UseUserOffsetSlope	Description	FALSE to use the maximum Slope, causing an instantaneous gear change within one cycle. TRUE to use user-defined OffsetSlope
	Data type	BOOL
	Range	0, 1
	Unit	n/a

	Default	FALSE
OffsetSlope	Description	User-defined limit at which step changes in Offset are implemented. Values lower than 1.0 can be entered, but require a leading zero (for example 0.8 instead of .8)
	Data type	LREAL
	Range	—
	Unit	User unit/sec
	Default	0.0
Modulo	Description	TRUE when mode is modulo. Modulo mode adapts the output values according to the ModuloPosition (modulo)
	Data type	BOOL
	Range	0, 1
	Unit	n/a
	Default	FALSE

2.1.10.6.4.2 Output

Default (.Q)	Description	Returns TRUE if the Gear Pipe Block is initialized
	Data type	BOOL
	Unit	n/a

2.1.10.7.5.3 Return Type

BOOL

2.1.10.8.6 Related Functions

[MLBlkCreate](#)

"MLGearWriteRatio" (→ p. 229)

2.1.10.9.7 Example

2.1.10.10.8.1 Structured Text

```
//Initialize a Gear Pipe Block named GEAR1 with:
// Ratio = 1, Offset = 0, User Ratio Slope OFF, User Ratio
// Slope = 0, Offset Slope = 0, and no Modulo
GEAR1 := MLBlkCreate( 'GEAR1', 'GEAR' );
MLGearInit( GEAR1, 1.0, 0.0, false, 0.0, false, 0.0, false);
```

2.1.10.11.9.2 Ladder Diagram

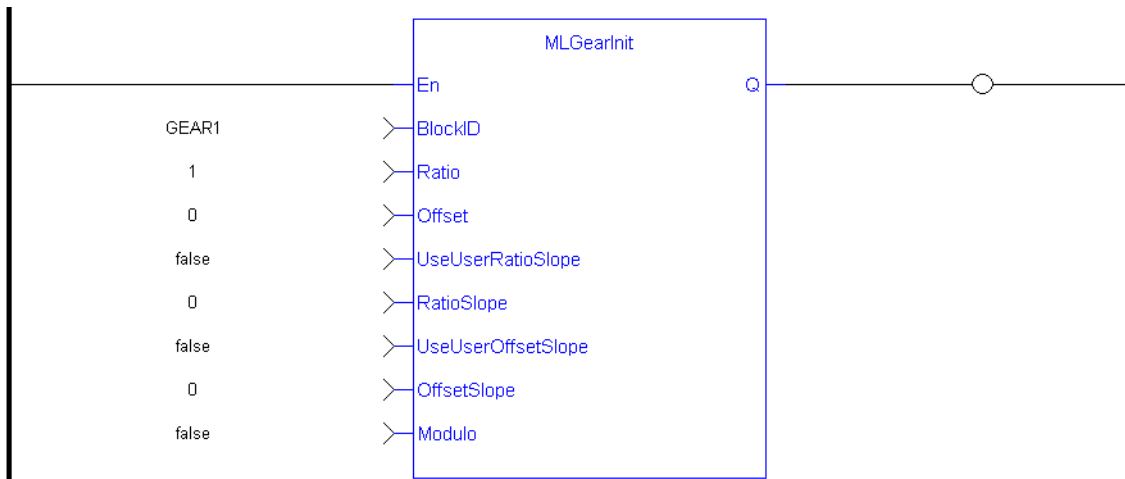

2.1.10.12.10.3 Function Block Diagram

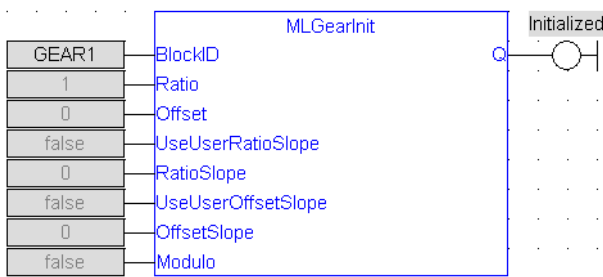

2.1.10.13 MLGearReadOffset Pipe Network ✓

2.1.10.14.1 Description

Returns the Offset value of a selected Gear Block from the Pipe Network.

The output of a Gear Block = Input value * Ratio + Offset

2.1.10.15.2 Arguments

2.1.10.16.3.1 Input

BlockID	Description	ID number of an initiated an initialized Gear object
	Data type	DINT
	Range	[-2147483648, 2147483648]
	Unit	n/a
	Default	—

2.1.10.17.4.2 Output

Offset	Description	The offset value currently assigned to the selected Gear Pipe Block
	Data type	LREAL

Unit	User unit
-------------	-----------

2.1.10.18.5 Related Functions

"MLGearWriteOff" (→ p. 226)

"MLGearInit" (→ p. 219)

2.1.10.19.6 Example

2.1.10.20.7.1 Structured Text

```
//Find the Offset value of Gear1 Pipe Block
Gear1Offset := MLGearReadOffset( PipeNetwork.GEAR1 );
```

2.1.10.21.8.2 Ladder Diagram

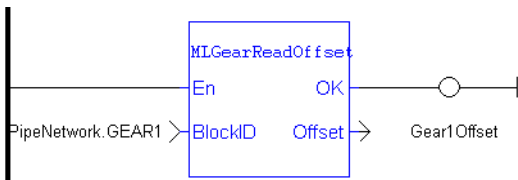

2.1.10.22.9.3 Function Block Diagram



2.1.10.23 MLGearReadOffSlp Pipe Network ✓

2.1.10.24.1 Description

Returns the Offset Slope value of a selected Gear Block from the Pipe Network. Offset Slope sets the limit in User Units per Second at which step changes in offset are implemented. The default value when creating a Gear Block is OFFSET_SLOPE_MAX or infinite.

2.1.10.25.2 Arguments

2.1.10.26.3.1 Input

BlockID	Description	ID number of an initiated an initialized Gear object
	Data type	DINT
	Range	[-2147483648, 2147483648]
	Unit	n/a
	Default	—

2.1.10.27.4.2 Output

Slope	Description	The offset slope value currently assigned to the selected Gear Pipe Block, which may be a different sign than what is programmed with MLGearWriteOSlp.
	Data type	LREAL
	Unit	User unit/sec

2.1.10.28.5 Related Functions

"MLGearWriteOSlp" (→ p. 228)

"MLGearInit" (→ p. 219)

2.1.10.29.6 Example

2.1.10.30.7.1 Structured Text

```
//Find the Offset Slope value of Gear1 Pipe Block
Gear1OffsetSlope := MLGearReadOffSlp(PipeNetwork.GEAR1);
```

2.1.10.31.8.2 Ladder Diagram

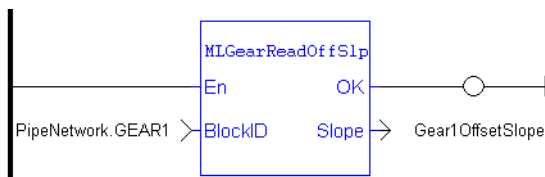

2.1.10.32.9.3 Function Block Diagram



2.1.10.33 MLGearReadRatio Pipe Network ✓

2.1.10.34.1 Description

Returns the Ratio value of a selected Gear Block from the Pipe Network.

The output of a Gear Block = Input value * Ratio + Offset

2.1.10.35.2 Arguments

2.1.10.36.3.1 Input

BlockID	Description	ID number of an initialized Gear Pipe Block
	Data type	DINT
	Range	[-2147483648, 2147483648]
	Unit	n/a

Default	—
----------------	---

2.1.10.37.4.2 Output

Ratio	Description	The Ratio value currently assigned to the selected Gear Pipe Block
	Data type	LREAL
	Unit	n/a

2.1.10.38.5 Related Functions

"MLGearWriteRatio" (→ p. 229)

"MLGearInit" (→ p. 219)

2.1.10.39.6 Example

2.1.10.40.7.1 Structured Text

```
//Find the Ratio value of Gear1 Pipe Block
Gear1Ratio := MLGearReadRatio(PipeNetwork.GEAR1);
```

2.1.10.41.8.2 Ladder Diagram

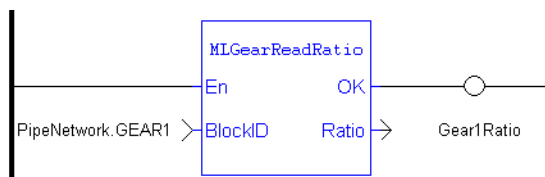

2.1.10.42.9.3 Function Block Diagram

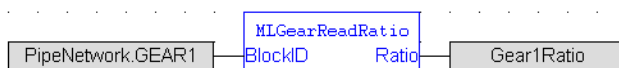

2.1.10.43 MLGearReadRatSlp Pipe Network ✓

2.1.10.44.1 Description

Returns the Ratio Slope value of a selected Gear Block from the Pipe Network. Ratio Slope sets the limit in 1/Seconds (or s^{-1}) at which step changes in Ratio are implemented.

2.1.10.45.2 Arguments

2.1.10.46.3.1 Input

BlockID	Description	ID number of an initialized Gear Pipe Block
	Data type	DINT
	Range	[-2147483648, 2147483648]

Unit	n/a
Default	—

2.1.10.47.4.2 Output

Slope	Description	The Ratio Slope value currently assigned to the selected Gear Pipe Block, , which may be a different sign than what is programmed with MLGearWriteRatSlp.
	Data type	LREAL
	Unit	1/sec (or s ⁻¹)

2.1.10.48.5 Related Functions

"MLGearWriteRatSlp" (→ p. 231)

"MLGearInit" (→ p. 219)

2.1.10.49.6 Example

2.1.10.50.7.1 Structured Text

```
//Find the Ratio Slope value of Gear1 Pipe Block
Gear1RatioSlope := MLGearReadRatSlp(PipeNetwork.GEAR1);
```

2.1.10.51.8.2 Ladder Diagram

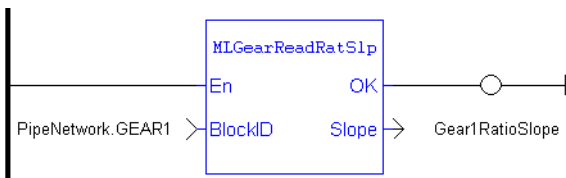

2.1.10.52.9.3 Function Block Diagram



2.1.10.53 MLGearWriteOff Pipe Network ✓

2.1.10.54.1 Description

Sets the Offset value of a selected Gear Pipe Block.

The output of a Gear Block = Input value * Ratio + Offset

TIP

Values lower than 1.0 can be entered, but require a leading zero (for example 0.8 instead of .8)

2.1.10.55.2 Arguments

2.1.10.56.3.1 Input

BlockID	Description	ID number of an initialized Gear Pipe Block
	Data type	DINT
	Range	[-2147483648, 2147483648]
	Unit	n/a
	Default	—
Offset	Description	New Offset value to be assigned to selected Gear Pipe Block. Values lower than 1.0 can be entered, but require a leading zero (for example 0.8 instead of .8)
	Data type	LREAL
	Range	—
	Unit	User unit
	Default	—

2.1.10.57.4.2 Output

Default (.Q)	Description	Returns TRUE if Offset value is changed in the selected Gear Pipe Block
	Data type	BOOL
	Unit	n/a

2.1.10.58.5.3 Return Type

BOOL

2.1.10.59.6 Related Functions

"MLGearReadOffset" (→ p. 222)

"MLGearInit" (→ p. 219)

2.1.10.60.7 Example

2.1.10.61.8.1 Structured Text

```
//Set the Offset value of Gear1 Pipe Block to 5 User Units
MLGearWriteOff(PipeNetwork.GEAR1, 5.0);
```

2.1.10.62.9.2 Ladder Diagram

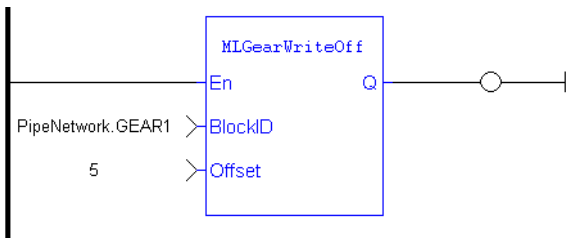

2.1.10.63.10.3 Function Block Diagram

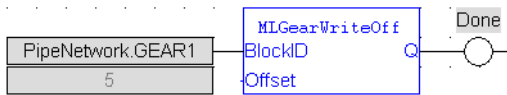

2.1.10.64 MLGearWriteOSlp Pipe Network ✓

2.1.10.65.1 Description

Sets the Offset Slope value of a selected Gear Pipe Block. Offset Slope sets the limit in User Units per Second at which step changes in offset are implemented. The default value when creating a Gear Block is OFFSET_SLOPE_MAX or infinite.

TIP

Values lower than 1.0 can be entered, but require a leading zero (for example 0.8 instead of .8)

2.1.10.66.2 Arguments

2.1.10.67.3.1 Input

BlockID	Description	ID number of an initialized Gear Pipe Block
	Data type	DINT
	Range	[-2147483648, 2147483648]
	Unit	n/a
	Default	—
Slope	Description	New Offset Slope value to be assigned to selected Gear Pipe Block. Values lower than 1.0 can be entered, but require a leading zero (for example 0.8 instead of .8)
	Data type	LREAL
	Range	—
	Unit	User unit/sec
	Default	—

2.1.10.68.4.2 Output

Default (.Q)	Description	Returns TRUE if Offset Slope value is changed in the selected Gear Pipe Block
---------------------	--------------------	---

Data type	BOOL
Unit	n/a

2.1.10.69.5.3 Return Type

BOOL

2.1.10.70.6 Related Functions

"MLGearReadOffSlp" (→ p. 223)

"MLGearInit" (→ p. 219)

2.1.10.71.7 Example

2.1.10.72.8.1 Structured Text

```
//Set the Offset Slope value of Gear1 Pipe Block to 100
MLGearWriteOSlp(PipeNetwork.GEAR1, 100.0);
```

2.1.10.73.9.2 Ladder Diagram

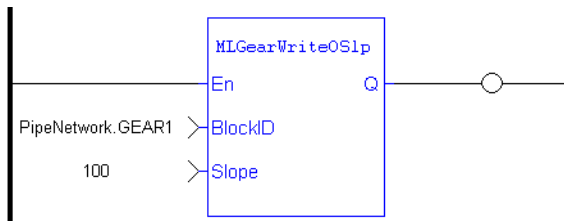

2.1.10.74.10.3 Function Block Diagram

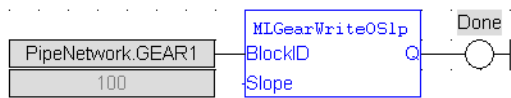

2.1.10.75 MLGearWriteRatio Pipe Network ✓

2.1.10.76.1 Description

Set the Ratio value of a selected Gear Pipe Block.

The output of a Gear Block = Input value * Ratio + Offset

TIP

Values lower than 1.0 can be entered, but require a leading zero (for example 0.8 instead of .8)

2.1.10.77.2 Arguments

2.1.10.78.3.1 Input

BlockID	Description	ID number of an initialized Gear Pipe Block
	Data type	DINT

	Range	[-2147483648, 2147483648]
	Unit	n/a
	Default	—
Ratio	Description	New Ratio value to be assigned to selected Gear Pipe Block. Values lower than 1.0 can be entered, but require a leading zero (for example 0.8 instead of .8)
	Data type	LREAL
	Range	—
	Unit	n/a
	Default	—

2.1.10.79.4.2 Output

Default (.Q)	Description	Returns TRUE if Ratio value is changed in the selected Gear Pipe Block
	Data type	BOOL
	Unit	n/a

2.1.10.80.5.3 Return Type

BOOL

2.1.10.81.6 Related Functions

"MLGearReadRatio" (→ p. 224)

"MLGearInit" (→ p. 219)

2.1.10.82.7 Example

2.1.10.83.8.1 Structured Text

```
//Set the Ratio value of Gear1 Pipe Block to 5
MLGearWriteRatio(PipeNetwork.GEAR1, 5.0);
```

2.1.10.84.9.2 Ladder Diagram

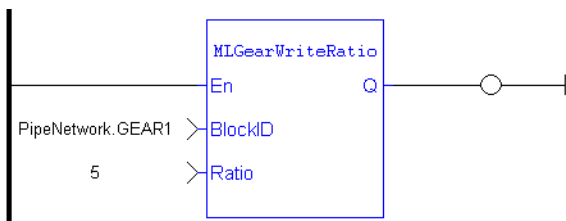

2.1.10.85.10.3 Function Block Diagram

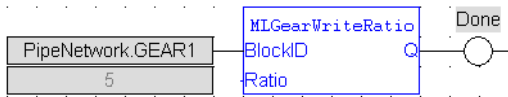

2.1.10.86 MLGearWriteRatSlp Pipe Network ✓

2.1.10.87.1 Description

Set the Ratio Slope value of a selected Gear Pipe Block. Ratio Slope sets the limit at which step changes in ratio are implemented.

NOTE

Be sure to set $\text{RatioSlope} < (\text{Ratio} * \text{EtherCAT Update Rate})$. The Gear block will make a jump (without a ramp) from one gear to the next when the RatioSlope is greater than the Ratio change factor multiplied by the update rate scale factor.

TIP

Values lower than 1.0 can be entered, but require a leading zero (for example 0.8 instead of .8)

NOTE

The GEAR block output will add a position offset to the GEAR block input when using a RatioSlope. See "RatioSlope Offset" (→ p. 232) in the Examples below.

2.1.10.88.2 Arguments

2.1.10.89.3.1 Input

BlockID	Description	ID number of an initialized Gear Pipe Block
	Data type	DINT
	Range	[-2147483648, 2147483648]
	Unit	n/a
	Default	—
Slope	Description	New Ratio Slope value to be assigned to selected Gear Pipe Block. Values lower than 1.0 can be entered, but require a leading zero (for example 0.8 instead of .8)
	Data type	LREAL
	Range	—
	Unit	1/sec
	Default	—

2.1.10.90.4.2 Output

Default (.Q)	Description	Returns TRUE if Ratio Slope value is changed in the selected Gear Pipe Block
	Data type	BOOL

Unit	n/a
-------------	-----

2.1.10.91.5.3 Return Type

BOOL

2.1.10.92.6 Related Functions

"MLGearReadOffSlp" (→ p. 223)

"MLGearInit" (→ p. 219)

2.1.10.93.7 Example

2.1.10.94.8.1 Structured Text

```
//Set the Ratio Slope value of Gear1 Pipe Block to 100
MLGearWriteRatSlp(PipeNetwork.GEAR1, 100.0);
```

2.1.10.95.9.2 Ladder Diagram

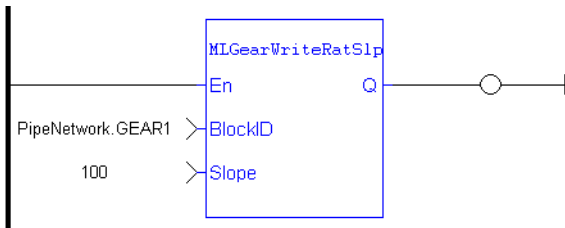

2.1.10.96.10.3 Function Block Diagram

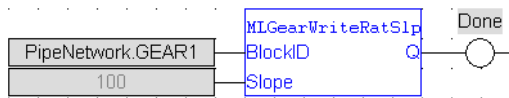

2.1.10.97.11.4 RatioSlope Offset

If MLGearWriteRatSlp is set as `MLGearWriteRatSlp(PipeNetwork.GEAR1 12 , Gear1RatioSlope 500.0)`; to generate a ramp (instead of a step) when going from a gear ratio of 1 to 2, then there will be a position offset when the gear ratio settles as 2. In the image below the ratio goes from 1.0 to 2.0; Green is PN Gear Block Output and Red is Gearbox Input.

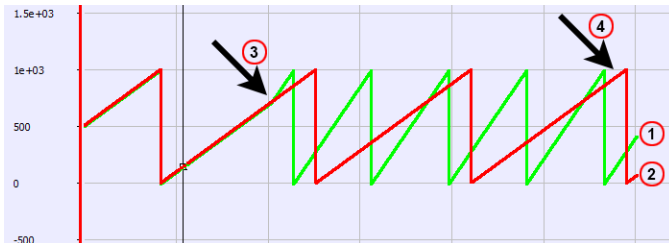

1. Green line: PN Gear Block Output
2. Red line: PN Gearbox Input
3. When the ratio is changed
4. Phase difference

If MLGearWriteRatSlp is set without a ramp,

```
MLGearWriteRatSlp( PipeNetwork.GEAR1 12 , Gear1RatioSlope 1e+301 );
```

, then there will not be an offset.

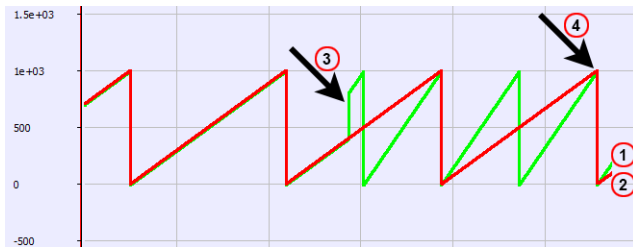

1. Green line: PN Gear Block Output
2. Red line: PN Gearbox Input
3. When the ratio changes
4. Synched

2.1.11 Motion Library - Integrator

Name	Description	Return type
MLIntInit	Initializes an integrator object	BOOL
MLIntWriteOutVal	Sets the output value of an integrator object	BOOL

2.1.11.1 MLIntInit Pipe Network ✓

2.1.11.2.1 Description

Initializes an integrator object. Function block is automatically called if an Integrator Block is added to the Pipe Network, with user-defined settings entered in the Pipe Blocks Properties screen.

Integrator object can operate in Modulo or not modulo mode. While in Modulo mode, the output values are adapted according to the entered ModuloPosition value.

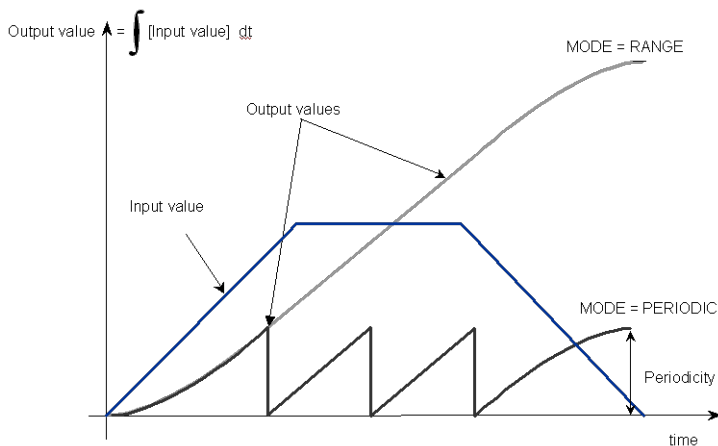

Figure 1-36: MLIntInit

NOTE

Integrator objects are normally created in the Pipe Network using the graphical engine. Then you do not have to add MLIntInit function blocks to their programs. Parameters are entered directly in pop-up windows, and the code is then automatically added to the current project.

2.1.11.3.2 Arguments

2.1.11.4.3.1 Input

BlockID	Description	ID number of a created Pipe Block
	Data type	DINT
	Range	[-2147483648, 2147483648]
	Unit	n/a

	Default	—
ModuloPosition	Description	Output ModuloPosition of Integrator object
	Data type	LREAL
	Range	—
	Unit	User unit
	Default	360.0
Modulo	Description	TRUE when mode is modulo. Modulo mode adapts the output values according to the ModuloPosition (modulo)
	Data type	BOOL
	Range	0, 1
	Unit	n/a
	Default	TRUE

2.1.11.5.4.2 Output

Default (.Q)	Description	Returns TRUE if the Integrator object is initialized
	Data type	BOOL
	Unit	n/a

2.1.11.6.5.3 Return Type

BOOL

2.1.11.7.6 Related Functions

[MLBlkCreate](#)

[MLIntWriteOutVal](#)

2.1.11.8.7 Example

2.1.11.9.8.1 Structured Text

```
//Initiate an Integrator Pipe Block named "MyIntegrator" with a
Modulo of 360
MLIntInit(MyIntegrator, 360.0, true );
```

2.1.11.10.9.2 Ladder Diagram

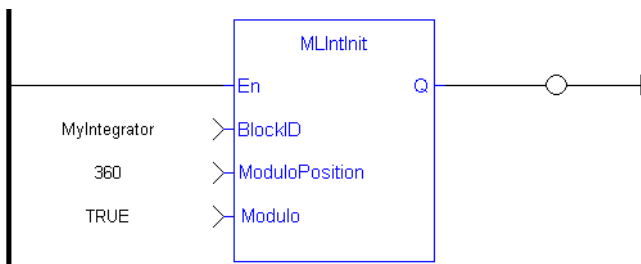

2.1.11.11.10.3 Function Block Diagram

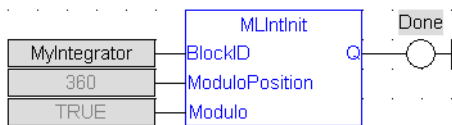

2.1.11.12 MLIntWriteOutVal Pipe Network ✓

2.1.11.13.1 Description

Sets the output value of an integrator object. This function can force the output to an entered value not dependent on the input value from the Pipe Network.

NOTE
Output value can jump to another value instantly after the function is executed if the Pipe Network is running.

2.1.11.14.2 Arguments

2.1.11.15.3.1 Input

BlockID	Description	ID number of an initiated Integrator object
	Data type	DINT
	Range	[-2147483648, 2147483648]
	Unit	n/a
	Default	—
Value	Description	Desired new output value of the selected Integrator object
	Data type	LREAL
	Range	—
	Unit	User unit
	Default	—

2.1.11.16.4.2 Output

Default (.Q)	Description	Returns TRUE if the output value if the Integrator object is changed
---------------------	--------------------	--

Data type	BOOL
Unit	n/a

2.1.11.17.5.3 Return Type

BOOL

2.1.11.18.6 Related Functions

[MLIntInit](#)

2.1.11.19.7 Example

2.1.11.20.8.1 Structured Text

```
//change the output value of an integrator object to 35
MLIntWriteOutVal ( PipeNetwork.MyIntegrator, 35.0 );
```

2.1.11.21.9.2 Ladder Diagram

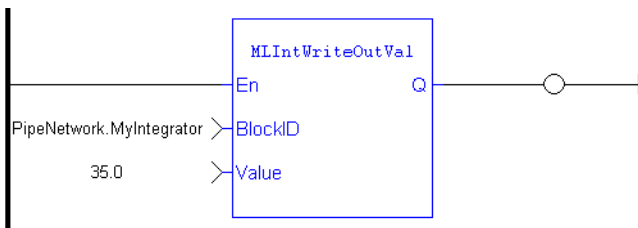

2.1.11.22.10.3 Function Block Diagram

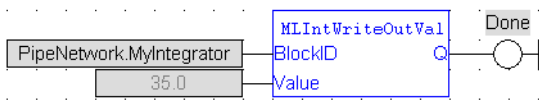

2.1.12 Motion Library - Master

TIP

- For an example of Master Functions, see "Usage example of Master Functions" (→ p. 237)

Functions sorted by types:

Motion Control	Inquiry Functions	Position setting
"MLMstInit" (→ p. 243)	"MLMstReadAccel" (→ p. 246)	"MLMstAbs" (→ p. 238)
"MLMstRun" (→ p. 252)	"MLMstReadDecel" (→ p. 247)	"MLMstAdd" (→ p. 240)
"MLMstWriteAccel" (→ p. 255)	"MLMstReadInitPos" (→ p. 248)	"MLMstForcePos" (→ p. 242)
"MLMstWriteDecel" (→ p. 257)	"MLMstReadSpeed" (→ p. 250)	"MLMstRel" (→ p. 251)
"MLMstWriteSpeed" (→ p. 259)	"MLMstStatus" (→ p. 254)	

Functions sorted in alphabetical order:

Name	Description	Return type
"MLMstAbs" (→ p. 238)	Does an absolute move	BOOL
"MLMstAdd" (→ p. 240)	Does an additive move relative for a specified distance from the endpoint of the previous move	BOOL
"MLMstForcePos" (→ p. 242)	Forces the specified position. Possible only when the block is not moving.	BOOL
"MLMstInit" (→ p. 243)	Initializes a master object (TMP generator)	BOOL
"MLMstReadAccel" (→ p. 246)	Gets the present acceleration value of a master block	None
"MLMstReadDecel" (→ p. 247)	Gets the present deceleration value of a master block	None
"MLMstReadInitPos" (→ p. 248)	Gets the initial position of a master block	None
"MLMstReadSpeed" (→ p. 250)	Gets the speed of a master block	None
"MLMstRel" (→ p. 251)	Does an Relative move for a specified distance from the current position	BOOL
"MLMstRun" (→ p. 252)	Jogs at the specified speed. Returns TRUE if the function succeeded	BOOL
"MLMstStatus" (→ p. 254)	Returns the status of the generator	DINT
"MLMstWriteAccel" (→ p. 255)	Sets the acceleration of a master block	BOOL
"MLMstWriteDecel" (→ p. 257)	Sets the deceleration of a master block	BOOL
MLMstWriteInitPos	Sets the initial position of a master block	BOOL
"MLMstWriteSpeed" (→ p. 259)	Sets the speed of a master block	BOOL

2.1.12.1 Usage example of Master Functions

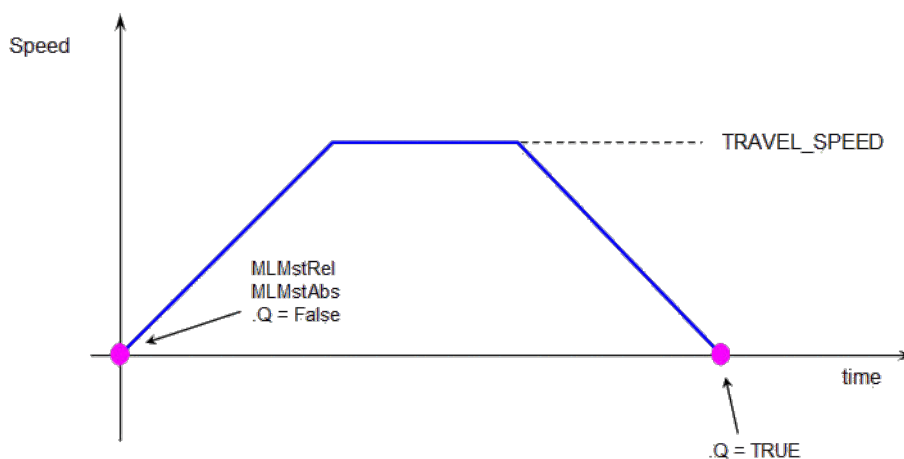

MLMstRun(0.0) reduce the speed down to 0.

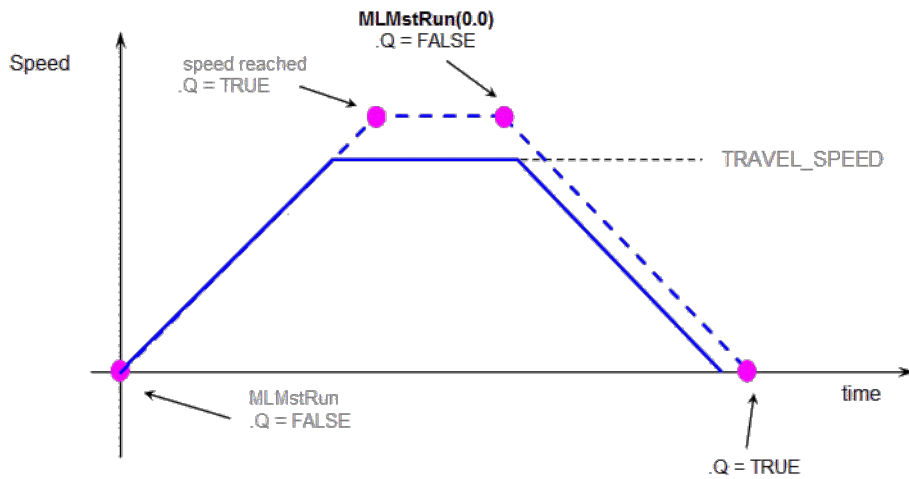

Figure 1-37: Master Functions Usage

2.1.12.2 MLMstAbs Pipe Network ✓

2.1.12.3.1 Description

Performs a move to an absolute position. Returns TRUE if the function succeeded.

2.1.12.4.2 Arguments

2.1.12.5.3.1 Input

BlockID	Description	ID name of the Master Block
	Data type	DINT
	Range	[-2147483648, 2147483648]
	Unit	n/a
	Default	—

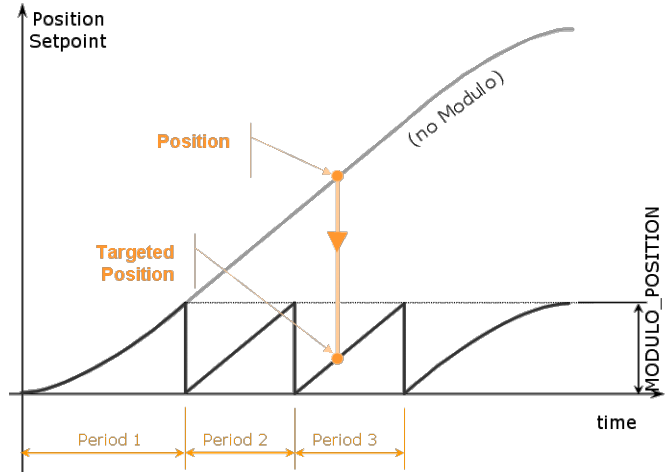
Position	<p>Description</p> <p>Sets the value of the absolute destination position. When the Modulo is turned on, the Master Block moves to the targeted position during the corresponding period, calculated as follows:</p> <ul style="list-style-type: none"> • If the Position input is between 0 and the Modulo Position, then the Master Block moves within the current period (no position rollover). • If the Position input is greater than the Modulo Position, then the Master Block moves during one of the next period (positive position rollover).  <p>The Master Block works similarly for negative positions: if the Position input is less than zero, then the Master Block moves during one of the previous period (negative position rollover).</p>
Data type	LREAL
Range	—
Unit	User unit
Default	—

2.1.12.6.4.2 Output

Default (.Q)	Description
	Returns true when function successfully executes
	Data type
	BOOL
	Unit
	n/a

TIP

To reduce the load on the CPU, call MLMstAbs only once for each move. This can be achieved by adding a control variable, which is illustrated below.

```
// Master: modulo is on and modulo range is 0 - 360 with
// rollover at 360
If Not MoveStarted Then
    Position := 500;
```

```

    MLMstAbs( PipeNetwork.MASTER, Position);
    MovesStarted := TRUE;
End_if;

```

NOTE

Perform one of the following to prevent undesired axis movement if modulo is turned on.

- Verify that the **Position** value is within the modulo range.
- If the **Position** value is outside of the modulo range, call MLMstAbs function only once. See the **TIP** above for an example of how to do this.

2.1.12.7.5 Related Functions

"MLMstWriteSpeed" (→ p. 259)

"MLMstWriteDecel" (→ p. 257)

2.1.12.8.6 Examples

2.1.12.9.7.1 Structured Text

```

//Make an absolute positon move with a Master block called
"MASTER" to position 1000.0
MLMstAbs( PipeNetwork.MASTER, 1000.0 );

```

2.1.12.10.8.2 Ladder Diagram

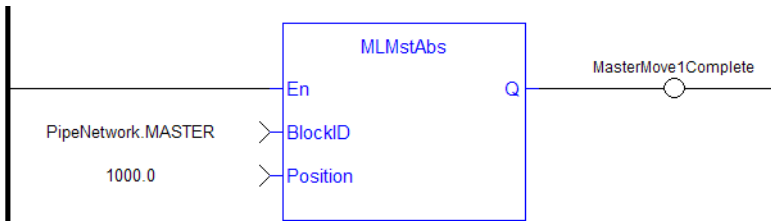

2.1.12.11.9.3 Function Block Diagram



2.1.12.12 MLMstAdd Pipe Network ✓

2.1.12.13.1 Description

Performs a move for a specified distance relative to the endpoint of the previous move. Returns TRUE if the function succeeded.

2.1.12.14.2 Arguments

2.1.12.15.3.1 Input

EN	Description	Enables FB to be executed
	Data type	BOOL

	Range	0, 1
	Unit	n/a
	Default	—
Block ID	Description	ID name of the Master Block
	Data type	DINT
	Range	[-2147483648, 2147483648]
	Unit	n/a
	Default	—
DeltaPos	Description	Relative distance to move
	Data type	LREAL
	Range	—
	Unit	User unit
	Default	—

2.1.12.16.4.2 Output

Default (.Q)	Description	Returns true when function successfully executes
	Data type	BOOL
	Unit	n/a

2.1.12.17.5 Related Functions

"MLMstWriteSpeed" (→ p. 259)

"MLMstWriteDecel" (→ p. 257)

2.1.12.18.6 Example

2.1.12.19.7.1 Structured Text

```
//At the endpoint of the previous move, with the Master pipe
block named "MASTER", make a move of 750.0
MLMstAdd( PipeNetwork.MASTER, 750.0 );
```

2.1.12.20.8.2 Ladder Diagram

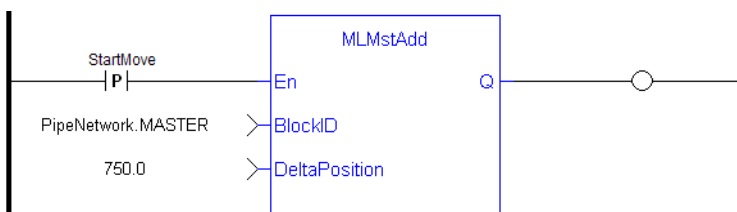

NOTE

You must use a [pulse contact](#) to start the FB

2.1.12.21.9.3 Function Block Diagram

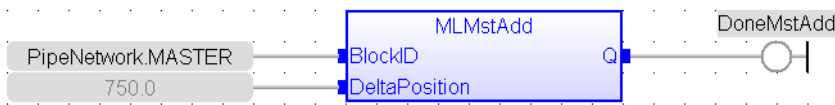

2.1.12.22 MLMstForcePos Pipe Network ✓

2.1.12.23.1 Description

Forces the position of a Master Block to a specified position. This block can only be executed when motion is not occurring. It can be used to force the master starting position to the desired values from which to start motion.

2.1.12.24.2 Arguments

2.1.12.25.3.1 Input

EN	Description	Enables FB to be executed
	Data type	BOOL
	Range	0, 1
	Unit	n/a
	Default	—
Block ID	Description	ID name of the Master Block
	Data type	DINT
	Range	[-2147483648, 2147483648]
	Unit	n/a
	Default	—
Position	Description	Defines the Master starting position when the motion starts
	Data type	LREAL
	Range	—
	Unit	User unit
	Default	—

2.1.12.26.4.2 Output

Default (.Q)	Description	Returns true when function successfully executes
	Data type	BOOL
	Unit	n/a

2.1.12.27.5 Related Functions

"MLMstReadInitPos" (→ p. 248)

2.1.12.28.6 Example

2.1.12.29.7.1 Structured Text

```
//Reset the output position of the Master Pipe Block named
"Master" to 2500.0
MLMstForcePos(PipeNetwork.Master, 2500.0);
```

2.1.12.30.8.2 Ladder Diagram

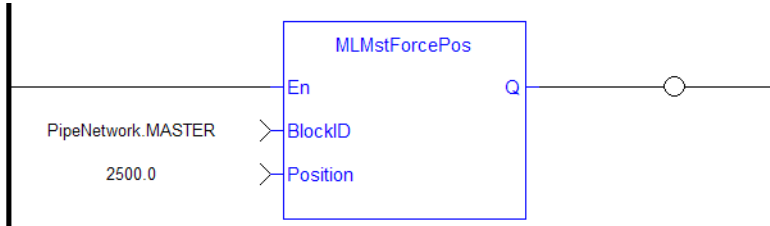

NOTE

You must use a [pulse contact](#) to start the FB

2.1.12.31.9.3 Function Block Diagram

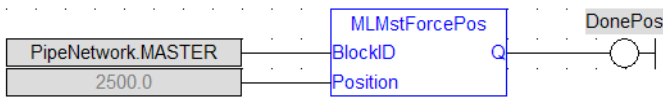

2.1.12.32 MLMstInit Pipe Network ✓

2.1.12.33.1 Description

Initializes a Master TMP (trapezoidal motion profile) generator block. This function is automatically created when the MLMaster Block is included in the Pipe Network Editor. Based on the parameters defined in the pipe block (see figure below), the Inputs for this function are initialized by default.

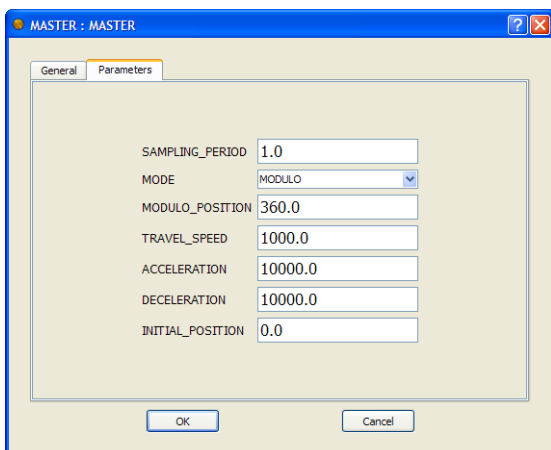

Figure 1-38: TMP Initialization

2.1.12.34.2 Arguments

2.1.12.35.3.1 Input

Block ID	Description	ID name of the Master Block
	Data type	DINT
	Range	[-2147483648, 2147483648]
	Unit	n/a
	Default	—
ModuloPosition	Description	Modulo Position for cyclic motion systems expressed in user logical units (Position Rollover Value)
	Data type	LREAL
	Range	—
	Unit	User unit
	Default	—
Period	Description	Sampling period of the generator expressed according to the update cycle (e.g. 2.0 means the sampling is done once every 2 cycles)
	Data type	LREAL
	Range	—
	Unit	User unit
	Default	—
Speed	Description	Travel speed value expressed in user logical units per second. The travel speed value is used to set the constant speed part of the trapezoidal motion profile
	Data type	LREAL
	Range	—
	Unit	User unit sec
	Default	—
Acceleration	Description	Acceleration value expressed in user logical units per second squared. The acceleration value is always used to generate the first part of the trapezoidal motion profile
	Data type	LREAL
	Range	—
	Unit	User unit /sec ²
	Default	—

Deceleration	Description	Deceleration value expressed in user logical units per second squared. The deceleration value is always used to generate the last part of the trapezoidal motion profile
	Data type	LREAL
	Range	—
	Unit	User unit /sec ²
	Default	—
Initial Position	Description	Initial position value expressed in user logical units. Used only at the pipe activation to initialize the position starting point
	Data type	LREAL
	Range	—
	Unit	User unit
	Default	—
Modulo	Description	The available modes are Modulo (True) or No modulo (False)
	Data type	BOOL
	Range	0, 1
	Unit	n/a
	Default	—

2.1.12.36.4.2 Output

Default (.Q)	Description	Returns true when function successfully executes
	Data type	BOOL
	Unit	n/a

2.1.12.37.5 Example

2.1.12.38.6.1 Structured Text

```
//Initialize a Master Pipe Block named "MASTER" to a Modulo of
360, motion generator sample period of 1, Speed of 1000.0, Accel
and Decel of 10000.0, Initial position of 0.0,
MLMstInit( PipeNetwork.MASTER, 360.0, 1.0, 1000.0, 10000.0,
10000.0, 0.0, true );
```

2.1.12.39.7.2 Ladder Diagram

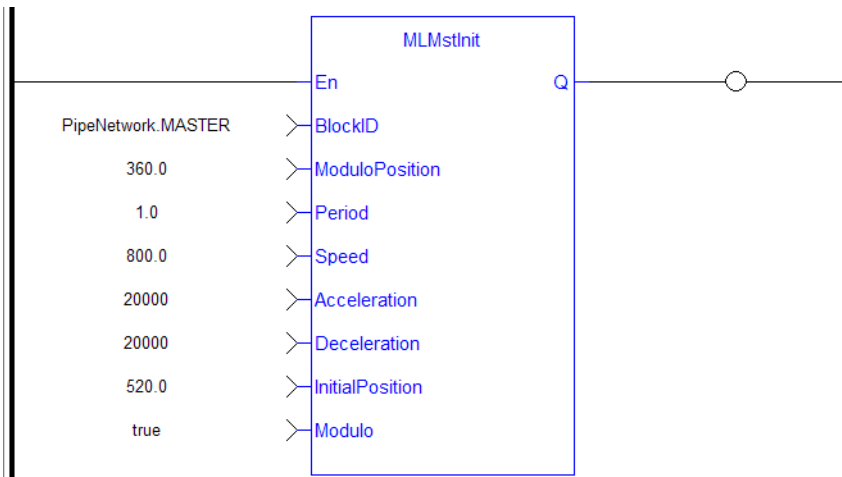

2.1.12.40.8.3 Function Block Diagram

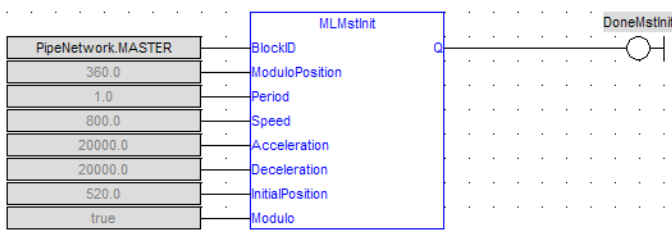

2.1.12.41 MLMstReadAccel Pipe Network ✓

2.1.12.42.1 Description

Get the presently used value for acceleration of a master block.

2.1.12.43.2 Arguments

2.1.12.44.3.1 Input

EN	Description	Enables FB to be executed
	Data type	BOOL
	Range	0, 1
	Unit	n/a
	Default	—
	Description	ID name of the Master Block
	Data type	DINT
	Range	[-2147483648, 2147483648]
	Unit	n/a
	Default	—

2.1.12.45.4.2 Output

OK	Description	Returns true when function successfully executes
	Data type	BOOL
	Unit	n/a
Acceleration	Description	Returns Acceleration value
	Data type	LREAL
	Unit	User unit /sec ²

2.1.12.46.5 Related Functions

"MLMstReadSpeed" (→ p. 250)

"MLMstReadDecel" (→ p. 247)

2.1.12.47.6 Example

2.1.12.48.7.1 Structured Text

```
// Read the present acceleration of a Pipe Block named
"MASTER"
MLMstReadAccel( PipeNetwork.MASTER );
```

2.1.12.49.8.2 Ladder Diagram

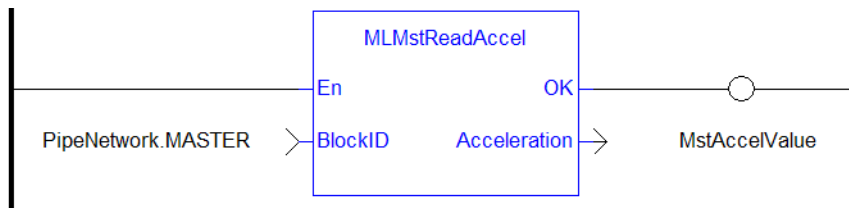

2.1.12.50 Function Block Diagram

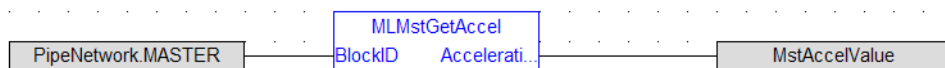

2.1.12.51 MLMstReadDecel Pipe Network ✓

2.1.12.52.1 Description

Get the presently used value for deceleration of a master block.

2.1.12.53.2 Arguments

2.1.12.54.3.1 Input

EN	Description	Enables FB to be executed
	Data type	BOOL
	Range	0, 1

	Unit	n/a
	Default	—
Block ID	Description	ID name of the Master Block
	Data type	DINT
	Range	[-2147483648, 2147483648]
	Unit	n/a
	Default	—

2.1.12.55.4.2 Output

OK	Description	Returns true when function successfully executes
	Data type	BOOL
	Unit	n/a
Deceleration	Description	Returns Deceleration value
	Data type	LREAL
	Unit	User unit /sec ²

2.1.12.56.5 Example

2.1.12.57.6.1 Structured Text

```
// Read the present deceleration of a Pipe Block named "MASTER"
MLMstReadDecel( PipeNetwork.MASTER );
```

2.1.12.58.7.2 Ladder Diagram

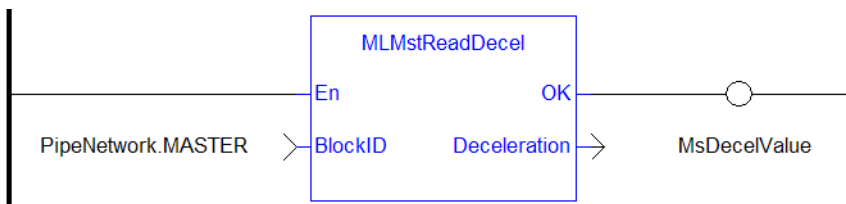

2.1.12.59.8.3 Function Block Diagram

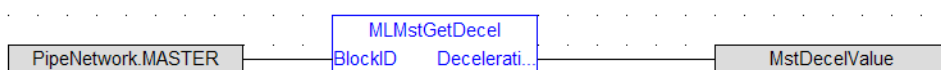

2.1.12.60 MLMstReadInitPos Pipe Network ✓

2.1.12.61.1 Description

Get the presently used value for initial position of a master block.

2.1.12.62.2 Arguments

2.1.12.63.3.1 Input

EN	Description	Enables FB to be executed
	Data type	BOOL
	Range	0, 1
	Unit	n/a
	Default	—
Block ID	Description	PipeNetwork Block
	Data type	DINT
	Range	[-2147483648, 2147483648]
	Unit	n/a
	Default	—

2.1.12.64.4.2 Output

OK	Description	Returns true when function successfully executes
	Data type	BOOL
	Unit	n/a
Position	Description	Returns Initial Position
	Data type	LREAL
	Unit	User unit

2.1.12.65.5 Example

2.1.12.66.6.1 Structured Text

```
MstInitPos := MLMstReadInitPos ( PipeNetwork.MASTER );
```

2.1.12.67.7.2 Ladder Diagram

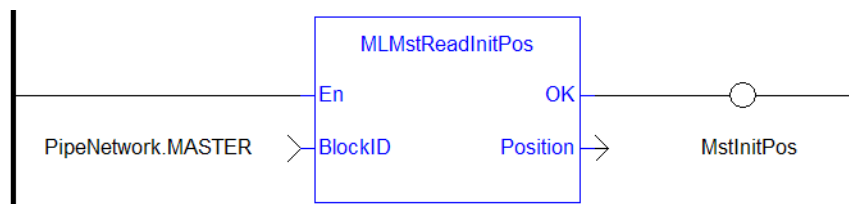

2.1.12.68.8.3 Function Block Diagram

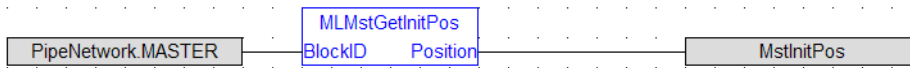

2.1.12.69 MLMstReadSpeed Pipe Network ✓

2.1.12.70.1 Description

Get the presently used value for speed of a master block.

2.1.12.71.2 Arguments

2.1.12.72.3.1 Input

EN	Description	Enables FB to be executed
	Data type	BOOL
	Range	0, 1
	Unit	n/a
	Default	—
Block ID	Description	ID name of the Master Block
	Data type	DINT
	Range	[-2147483648, 2147483648]
	Unit	n/a
	Default	—

2.1.12.73.4.2 Output

OK	Description	Returns true when function successfully executes
	Data type	BOOL
	Unit	n/a
Speed	Description	Returns current Speed
	Data type	LREAL
	Unit	User unit /sec

2.1.12.74.5 Related Functions

"MLMstReadAccel" (→ p. 246)

"MLMstReadDecel" (→ p. 247)

2.1.12.75.6 Example

2.1.12.76.7.1 Structured Text

```
MstSpeed := MLMstReadSpeed( PipeNetwork.MASTER );
```

2.1.12.77.8.2 Ladder Diagram

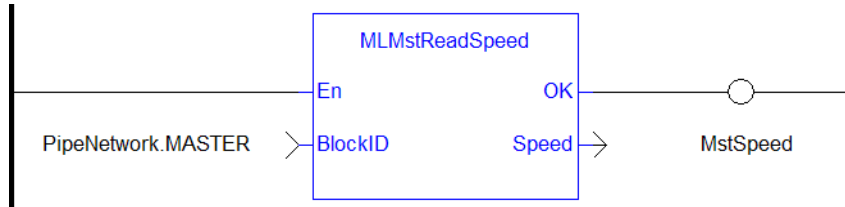

2.1.12.78.9.3 Function Block Diagram

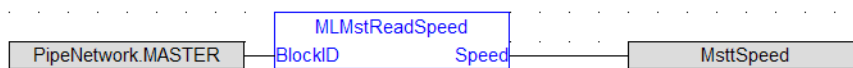

2.1.12.79 MLMstRel Pipe Network ✓

2.1.12.80.1 Description

Performs a move for a specified distance relative to the current position. Returns TRUE if the function succeeded.

2.1.12.81.2 Arguments

2.1.12.82.3.1 Input

EN	Description	Enables FB to be executed
	Data type	BOOL
	Range	0, 1
	Unit	n/a
	Default	—
Block ID	Description	ID name of the Master Block
	Data type	DINT
	Range	[-2147483648, 2147483648]
	Unit	n/a
	Default	—
DeltaPos	Description	Relative distance to move
	Data type	LREAL
	Range	—
	Unit	User unit

Default	—
----------------	---

2.1.12.83.4.2 Output

Default (.Q)	Description	Returns true when function successfully executes
	Data type	BOOL
	Unit	n/a

2.1.12.84.5 Related Functions

"MLMstWriteSpeed" (→ p. 259)

"MLMstWriteDecel" (→ p. 257)

2.1.12.85.6 Example

2.1.12.86.7.1 Structured Text

```
MLMstRel ( PipeNetwork.MASTER, 750.0 );
```

2.1.12.87.8.2 Ladder Diagram

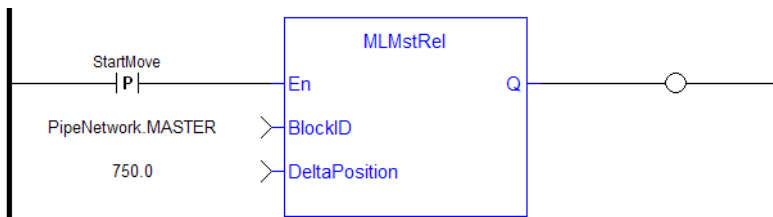

NOTE
You must use a [pulse contact](#) to start the FB

2.1.12.88.9.3 Function Block Diagram



2.1.12.89 MLMstRun Pipe Network ✓

2.1.12.90.1 Description

Jog at the specified speed. Returns TRUE if the function succeeded.

2.1.12.91.2 Arguments

2.1.12.92.3.1 Input

EN	Description	Enables FB to be executed
	Data type	BOOL
	Range	0, 1

	Unit	n/a
	Default	—
Block ID	Description	ID name of the Master Block
	Data type	DINT
	Range	[-2147483648, 2147483648]
	Unit	n/a
	Default	—
Speed	Description	Speed to jog motor
	Data type	LREAL
	Range	—
	Unit	User unit /sec
	Default	—

2.1.12.93.4.2 Output

Default (.Q)	Description	Returns true when function successfully executes
	Data type	BOOL
	Unit	n/a

2.1.12.94.5 Related Functions

"MLMstWriteSpeed" (→ p. 259)

"MLMstWriteDecel" (→ p. 257)

2.1.12.95.6 Example

2.1.12.96.7.1 Structured Text

```
MLMstRun ( PipeNetwork.MASTER, 1250.0 );
```

2.1.12.97.8.2 Ladder Diagram

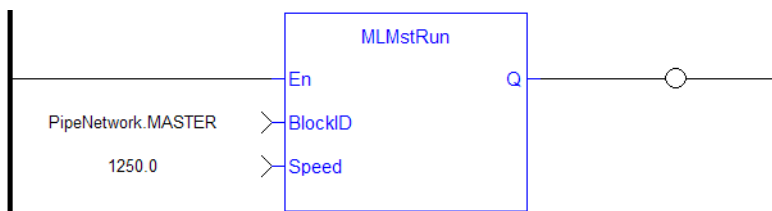

2.1.12.98.9.3 Function Block Diagram

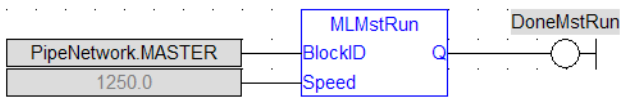

2.1.12.99 MLMstStatus Pipe Network ✓

2.1.12.100.1 Description

The value returned is the state being executed by the TMP generator as it processes the various motion commands. Some states are transitory, others are stable until the next event takes place. The following terms are relevant to the returned values.

Term	Definition
Running	Speed is non-zero
Stopped	Speed is zero
Positioning	A target position has been programmed with a relative, additive or absolute command.

Status	Definition
0	(New speed programmed) is entered when a jog move (MLMstRun) is commanded and the current speed is not at the commanded speed.
1	(Stable state Running or Stopped) is entered when a jog move (MLMstRun) is commanded and the current speed is at the commanded speed. (Stable state Running or Stopped) is entered when a position move is programmed and motion is completed.
2	(Speed change) is entered when the current speed is greater than the commanded speed.
3	(Speed reversal while positioning) is entered when a position move is programmed and the distance to go requires a speed reversal.
4	(Acceleration while positioning) current speed is below the travel speed
5	(Constant Speed while positioning) is entered when a positioning move is commanded and the current speed is at the commanded speed.
6	(Deceleration while positioning) is entered when a positioning move is commanded and the current speed is changing to achieve the target position at zero speed.
7	(Micro step) is entered when a small change in position is required and the current speed is zero.

2.1.12.101.2 Arguments

2.1.12.102.3.1 Input

EN	Description	Enables FB to be executed
	Data type	BOOL
	Range	0, 1
	Unit	n/a
	Default	—
Block ID	Description	ID name of the Master Block
	Data type	DINT
	Range	[-2147483648, 2147483648]

Unit	n/a
Default	—

2.1.12.103.4.2 Output

OK	Description	Returns true when function successfully executes
	Data type	BOOL
	Unit	n/a
Default (.Q)	Description	Returns the status of the generator
	Data type	DINT
	Unit	n/a

2.1.12.104.5 Example

2.1.12.105.6.1 Structured Text

```
MasterStatus := MLMstStatus( PipeNetwork.MASTER );
```

2.1.12.106.7.2 Ladder Diagram

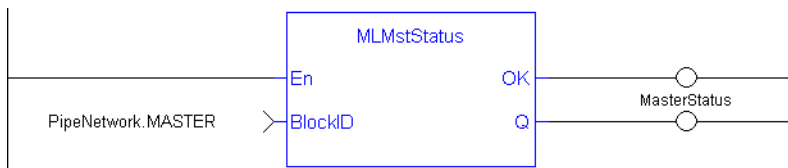

2.1.12.107.8.3 Function Block Diagram

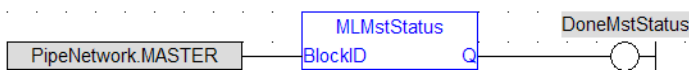

2.1.12.108 MLMstWriteAccel Pipe Network ✓

2.1.12.109.1 Description

Set the acceleration of a master block. Returns TRUE if the function succeeded.

2.1.12.110.2 Arguments

2.1.12.111.3.1 Input

EN	Description	Enables FB to be executed
	Data type	BOOL
	Range	0, 1
	Unit	n/a

	Default	—
Block ID	Description	ID name of the Master Block
	Data type	DINT
	Range	[-2147483648, 2147483648]
	Unit	n/a
	Default	—
Acceleration	Description	Acceleration value expressed in user logical units per second squared
	Data type	LREAL
	Range	—
	Unit	User unit /sec ²
	Default	—

2.1.12.112.4.2 Output

Default (.Q)	Description	Returns true when function successfully executes
	Data type	BOOL
	Unit	n/a

2.1.12.113.5 Related Functions

"MLMstAbs" (→ p. 238)

"MLMstRel" (→ p. 251)

"MLMstWriteSpeed" (→ p. 259)

"MLMstWriteDecel" (→ p. 257)

2.1.12.114.6 Example

2.1.12.115.7.1 Structured Text

```
MLMstWriteAccel( PipeNetwork.MASTER, 40000.0 );
```

2.1.12.116.8.2 Ladder Diagram

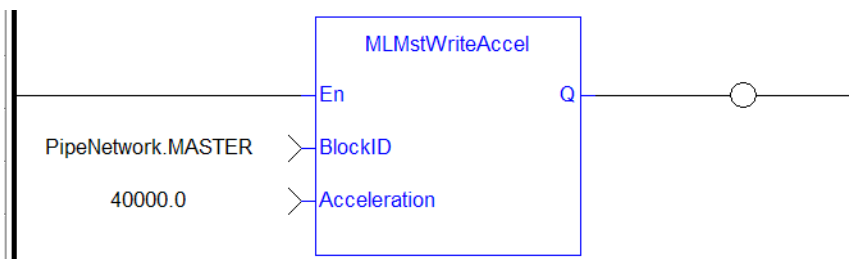

2.1.12.117.9.3 Function Block Diagram

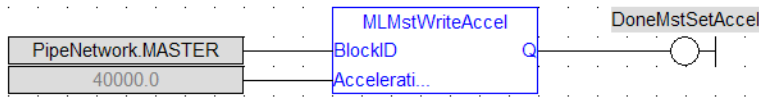

2.1.12.118 MLMstWriteDecel Pipe Network ✓

2.1.12.119.1 Description

Set the deceleration of a master block. Returns TRUE if the function succeeded.

2.1.12.120.2 Arguments

2.1.12.121.3.1 Input

EN	Description	Enables FB to be executed
	Data type	BOOL
	Range	0, 1
	Unit	n/a
	Default	—
Block ID	Description	ID name of the Master Block
	Data type	DINT
	Range	[-2147483648, 2147483648]
	Unit	n/a
	Default	—
Deceleration	Description	Deceleration value
	Data type	LREAL
	Range	—
	Unit	<u>User unit</u> /sec ²
	Default	—

2.1.12.122.4.2 Output

Default (.Q)	Description	Returns true when function successfully executes
	Data type	BOOL
	Unit	n/a

2.1.12.123.5 Related Functions

"MLMstWriteSpeed" (→ p. 259)

2.1.12.124.6 Example

2.1.12.125.7.1 Structured Text

```
MLMstWriteDecel ( PipeNetwork.MASTER, 40000.0 );
```

2.1.12.126.8.2 Ladder Diagram

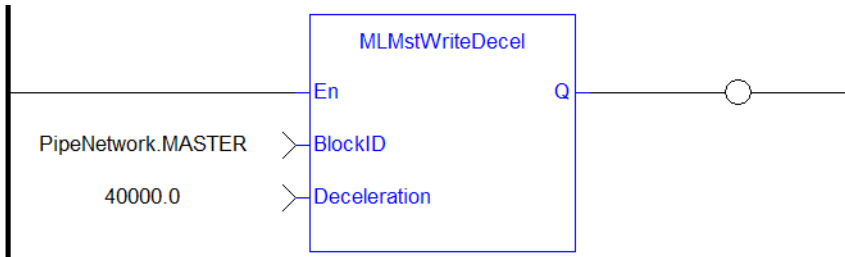

2.1.12.127.9.3 Function Block Diagram

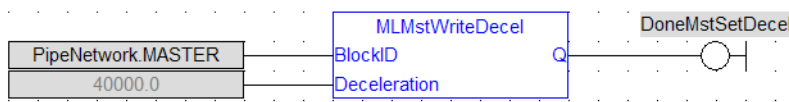

2.1.12.128 MLMstWriteInitPos Pipe Network ✓

2.1.12.129.1 Description

Set the initial position of a master block. Returns TRUE if the function succeeded.

2.1.12.130.2 Arguments

2.1.12.131.3.1 Input

EN	Description	Enables FB to be executed
	Data type	BOOL
	Range	0, 1
	Unit	n/a
	Default	—
Block ID	Description	ID name of the Master Block
	Data type	DINT
	Range	[-2147483648, 2147483648]
	Unit	n/a
	Default	—
Position	Description	Initial position
	Data type	LREAL
	Range	—

Unit	User unit
Default	—

2.1.12.132.4.2 Output

Default (.Q)	Description	Returns true when function successfully executes
	Data type	BOOL
	Unit	n/a

2.1.12.133.5 Example

2.1.12.134.6.1 Structured Text

```
MLMstWriteInitPos( PipeNetwork.MASTER, 120.0 );
```

2.1.12.135.7.2 Ladder Diagram

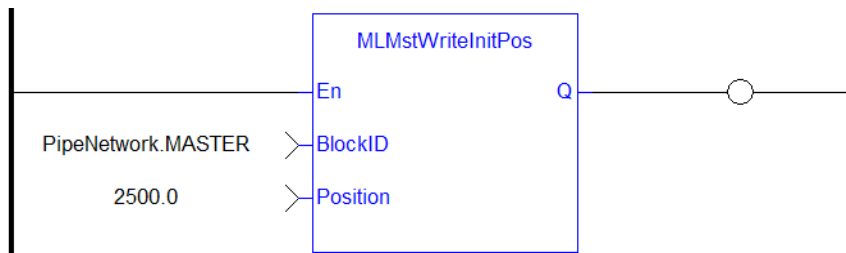

2.1.12.136.8.3 Function Block Diagram



2.1.12.137 MLMstWriteSpeed Pipe Network ✓

2.1.12.138.1 Description

Set the speed of motion for the [MLMstAbs](#) and [MLMstRel](#) blocks. Returns TRUE if the function succeeded. This function does not generate any motion.

2.1.12.139.2 Arguments

2.1.12.140.3.1 Input

EN	Description	Enables FB to be executed
	Data type	BOOL
	Range	0, 1
	Unit	n/a
	Default	—

Block ID	Description	ID name of the Master Block
	Data type	DINT
	Range	[-2147483648, 2147483648]
	Unit	n/a
	Default	—
Speed	Description	Speed of the motion
	Data type	LREAL
	Range	—
	Unit	User unit /sec
	Default	—

2.1.12.141.4.2 Output

Default (.Q)	Description	Returns true when function successfully executes
	Data type	BOOL
	Unit	n/a

2.1.12.142.5 Related Functions

"MLMstWriteDecel" (→ p. 257)

2.1.12.143.6 Example

2.1.12.144.7.1 Structured Text

```
MLMstWriteSpeed( PipeNetwork.MASTER, 400.0 );
```

2.1.12.145.8.2 Ladder Diagram

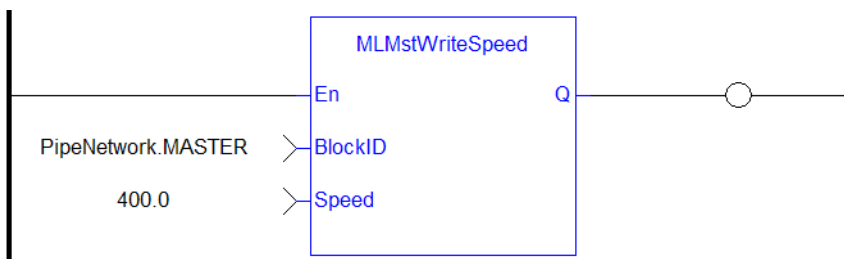

2.1.12.146.9.3 Function Block Diagram



2.1.13 Motion Library - Phaser

TIP

- For an example of Phaser functions, see "Usage example of Phaser Functions" (→ p. 261)

Names	Description	Return type
"MLPhaInit" (→ p. 262)	Initializes a phaser Pipe Block	BOOL
"MLPhaReadPhase" (→ p. 265)	Gets the phase value of a phaser block	None
"MLPhaReadSlope" (→ p. 266)	Gets the phase slope value of a phaser block	None
"MLPhaWritePhase" (→ p. 267)	Sets the phase value of a phaser block	BOOL
"MLPhaWriteSlope" (→ p. 268)	Sets the phase slope value of a phaser block	BOOL
"MLPhaReadActPhase" (→ p. 264)	Get the actual phase value of a phaser block.	LREAL

TIP

There is a delay when using an external encoder. The delay is five cycles (2 cycles to read the encoder from the AKD via EtherCAT, 1 cycle for computing, 2 cycles for sending the new position set point to the AKD). This lag error is speed proportional (5 cycles * speed). A Phaser block can be used to compensate for this lag.

When executing, the phaser block is in one of three states: **Standby**, **Changing phase**, or **Applying phase**.

Standby	Entered when the Block is initialized. Exits to the State "Changing Phase" when the Phase value is changed via the "MLPhaWritePhase" (→ p. 267) command
Changing Phase	Entered when a new value is programmed, and exits to "Applying phase" state when the programmed phase offset is reached. The current Phase offset value is slewed to the new phase offset by the amount of the slew value.
Applying Phase	Entered when the programmed Phase value is reached. Exits to the Changing phase state whenever a new value is programmed via the "MLPhaWritePhase" (→ p. 267) function changes the Phase Offset target.

2.1.13.1 Usage example of Phaser Functions

You can call "MLPhaWritePhase" (→ p. 267) function to modify the Phase value..

You can call "MLPhaWriteSlope" (→ p. 268) to modify the rate of change of phase, or slope, applied when the Phase value is changed.

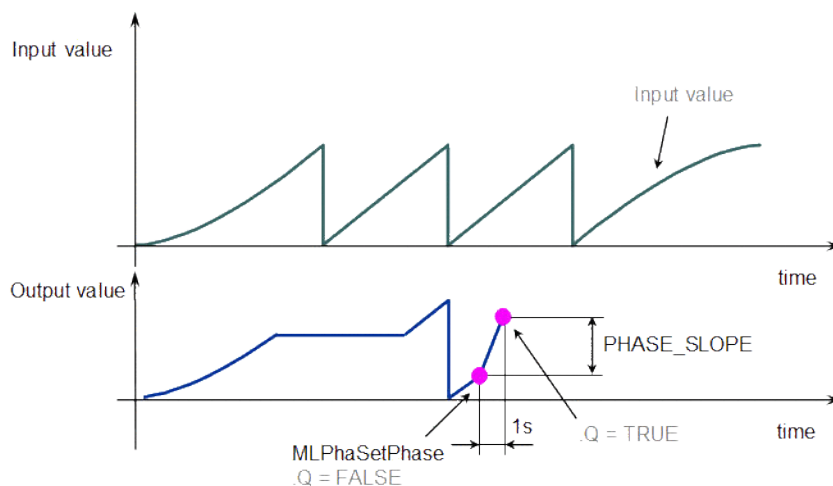

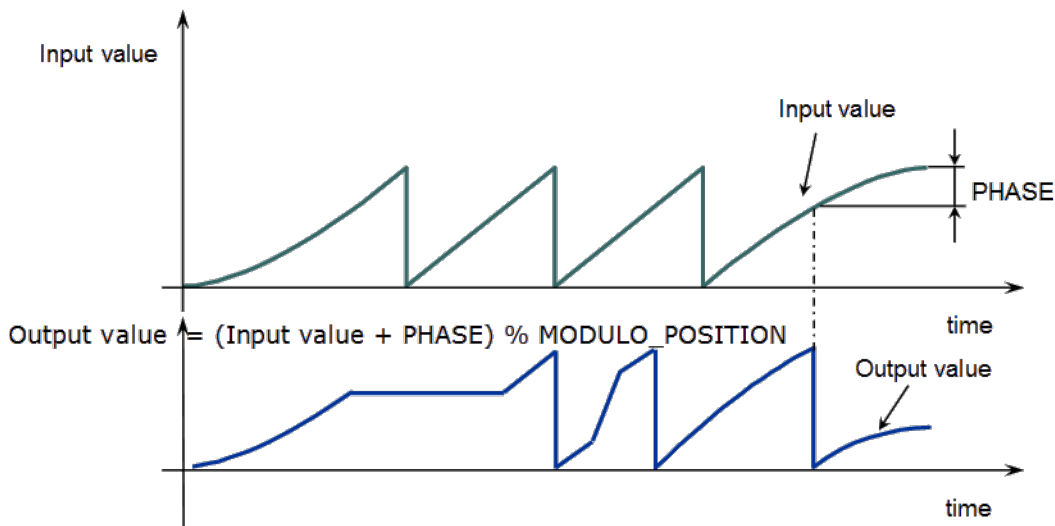

Figure 1-39: Phaser Functions Usage

NOTE

% MODULO_POSITION is in the equation to take into account the modulo (periodicity) of the value.

2.1.13.2 MLPhalnit Pipe Network ✓

2.1.13.3.1 Description

Initializes a phaser Pipe Block. Returns TRUE if the function succeeded.

This function block is automatically called by the Function PipeNetwork(MLPN_CREATE_OBJECTS) if a Phaser Block is added to the Pipe Network, with user-defined settings entered in the Pipe Blocks Properties screen.

The Phaser Pipe Block is assigned a Name, OUTPUT_PERIOD, PHASE, PHASE_SLOPE_TYPE, and STANDBY_VALUE.

2.1.13.4.2 Arguments

2.1.13.5.3.1 Input

BlockID	Description	ID Name of a Phaser function block in the Pipe Network
	Data type	DINT
	Range	[-2147483648, 2147483648]
	Unit	n/a
	Default	—
ModuloPosition	Description	Rollover Position of the Phaser block
	Data type	LREAL
	Range	—
	Unit	User unit
	Default	360.0

Phase	Description	Amount of Phase adjustment
	Data type	LREAL
	Range	—
	Unit	n/a
	Default	0.0
UseUserSlope	Description	Setting determines if Max Slope or user-defined slope is used
	Data type	BOOL
	Range	0, 1
	Unit	n/a
	Default	Max Slope
PhaseSlope	Description	User-defined slope for making the phase adjustment
	Data type	LREAL
	Range	—
	Unit	User unit/sec
	Default	0.0
StandbyValue	Description	This value is output from the Phaser Block, when the pipe is active, until the "MLPhaWritePhase" (→ p. 267) function is executed.
	Data type	LREAL
	Range	—
	Unit	n/a
	Default	0.0

2.1.13.6.4.2 Output

Default (.Q)	Description	Returns True if the function block is successfully executing
	Data type	BOOL
	Unit	n/a

2.1.13.7.5 Related Functions

"MLPhaReadPhase" (→ p. 265)

"MLPhaReadSlope" (→ p. 266)

MLPhalnit

"MLPhaWritePhase" (→ p. 267)

2.1.13.8.6 Example

2.1.13.9.7.1 Structured Text

```
//Initialize a Phaser Pipe Block named "PhaseAdjust" to a
Modulo of 720, phase offset value of 30, use the Max Slope
MLPhaInit( PipeNetwork.PhaseAdjust , 720, 30, false, 30 , 10 );
```

2.1.13.10.8.2 Ladder Diagram

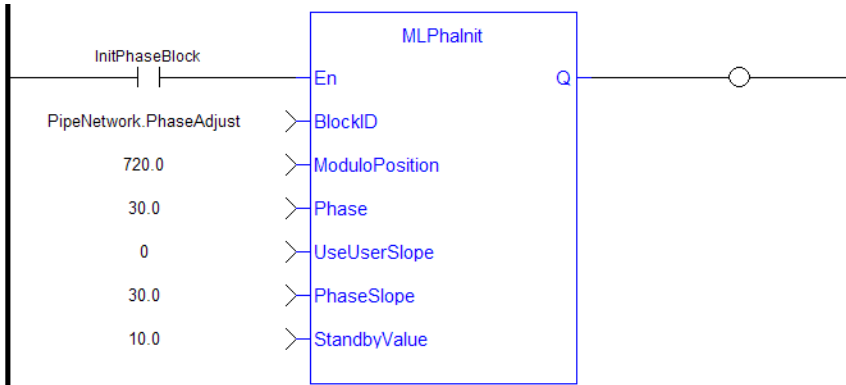

2.1.13.11.9.3 Function Block Diagram

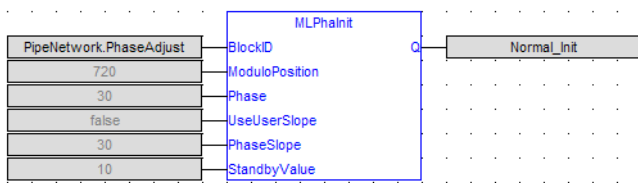

2.1.13.12 MLPhaReadActPhase Pipe Network ✓

2.1.13.13.1 Description

Get the actual phase value of a phaser block.

If a "PHASE_SLOPE_USER" (refer to "MLPhaReadSlope" (→ p. 266) and "MLPhaWriteSlope" (→ p. 268)) value is being used, the new phase (refer to "MLPhaWritePhase" (→ p. 267)) isn't set immediately; the phase will be ramped with the slope value from the old phase value to the new phase value. MLPhaReadActPhase returns this ramping value.

"MLPhaReadPhase" (→ p. 265) returns the new value and this also when the phaser is still ramping. If using max slope means no ramping MLPhaReadActPhase and MLPhaReadPhase return always the same value.

2.1.13.14.2 Arguments

2.1.13.15.3.1 Input

Enable	Description
	Data type
	Range
	Unit
	Default

BlockID	Description	ID Name of a Phaser function block in the Pipe Network
	Data type	DINT
	Range	[-2147483648, 2147483648]
	Unit	n/a
	Default	—

2.1.13.16.4.2 Output

OK	Description	
	Data type	
	Unit	
Phase	Description	
	Data type	LREAL
	Unit	

2.1.13.17.5 Related Functions

MLPhaReadPhase, MLPhaWritePhase, MLPhaReadSlope, MLPhaWriteSlope

2.1.13.18.6 Example

2.1.13.19.7.1 Structured Text

2.1.13.20.8.2 Ladder Diagram

2.1.13.21.9.3 Function Block Diagram

2.1.13.22 MLPhaReadPhase

2.1.13.23.1 Description

Get the phase value of a phaser block.

2.1.13.24.2 Arguments

2.1.13.25.3.1 Input

BlockID	Description	ID Name of a Phaser function block in the Pipe Network
	Data type	DINT
	Range	[-2147483648, 2147483648]
	Unit	n/a
	Default	—

2.1.13.26.4.2 Output

Phase	Data type	LREAL
-------	------------------	-------

2.1.13.27.5 Example

2.1.13.28.6.1 Structured Text

```
PresentPhase := MLPhaReadPhase ( PipeNetwork.PhaseAdjust );
```

2.1.13.29.7.2 Ladder Diagram



2.1.13.30.8.3 Function Block Diagram

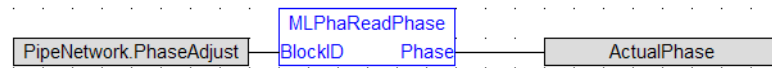

2.1.13.31 MLPhaReadSlope Pipe Network ✓

2.1.13.32.1 Description

Get the phase slope value of a phaser block.

2.1.13.33.2 Arguments

2.1.13.34.3.1 Input

BlockID	Description	ID Name of a Phaser function block in the Pipe Network
	Data type	DINT
	Range	[-2147483648, 2147483648]
	Unit	n/a
	Default	—

2.1.13.35.4.2 Output

Slope	Description	Present Slope value
	Data type	LREAL
	Unit	User unit/sec
	Default	Value defined in the setup of a Phaser Block within a Pipe Network. Depending on the phase slope type setting, it is the VALUE in "PHASE_SLOPE_USER", "PHASE" or the max slope.

2.1.13.36.5 Related Functions

MLPhaReadSlope

2.1.13.37.6 Example

2.1.13.38.7.1 Structured Text

```
PresentSlope :=MLPhaReadSlope( PipeNetwork.PhaseAdjust );
```

2.1.13.39.8.2 Ladder Diagram



2.1.13.40.9.3 Function Block Diagram



2.1.13.41 MLPhaWritePhase Pipe Network ✓

2.1.13.42.1 Description

Set the phase value of a phaser block.

2.1.13.43.2 Arguments

2.1.13.44.3.1 Input

BlockID	Description	ID Name of a Phaser function block in the Pipe Network
	Data type	DINT
	Range	[-2147483648, 2147483648]
	Unit	n/a
	Default	—
Phase	Description	Phase value
	Data type	LREAL
	Range	—
	Unit	User unit/sec
	Default	Value defined in the setup of a phaser Block within a Pipe Network. It is in the "PHASE" field in the parameter tab

2.1.13.45.4.2 Output

Default (.Q)	Description	Returns True if the function block is successfully executing
---------------------	--------------------	--

Data type	BOOL
Unit	n/a

2.1.13.46.5 Related Functions

"MLPhaReadPhase" (→ p. 265)

2.1.13.47.6 Example

2.1.13.48.7.1 Structured Text

```
MLPhaWritePhase ( PipeNetwork.PhaseAdjust , 30 );
```

2.1.13.49.8.2 Ladder Diagram



2.1.13.50.9.3 Function Block Diagram

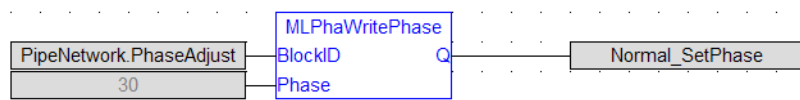

2.1.13.51 MLPhaWriteSlope Pipe Network ✓

2.1.13.52.1 Description

Set the phase value of a phaser block. Returns TRUE if the function succeeded.

2.1.13.53.2 Arguments

2.1.13.54.3.1 Input

BlockID	Description	ID Name of a Phaser function block in the Pipe Network
	Data type	DINT
	Range	[-2147483648, 2147483648]
	Unit	n/a
	Default	—
	Description	Set slope of phase adjust
	Data type	LREAL

Range	—
Unit	User unit/sec
Default	Value defined in the setup of a Phaser Block within a Pipe Network. Depending on the phase slope type setting, it is the VALUE in "PHASE_SLOPE_USER", "PHASE" or the max slope.

2.1.13.55.4.2 Output

Default (.Q)	Description	Returns True if the function block is successfully executing
	Data type	BOOL
	Unit	n/a

2.1.13.56.5 Related Functions

"MLPhaReadSlope" (→ p. 266)

2.1.13.57.6 Example

2.1.13.58.7.1 Structured Text

```
MLPhaWriteSlope ( PipeNetwork.PhaseAdjust , 10 );
```

2.1.13.59.8.2 Ladder Diagram

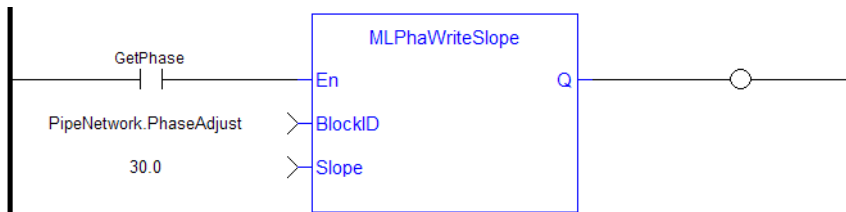

2.1.13.60.9.3 Function Block Diagram

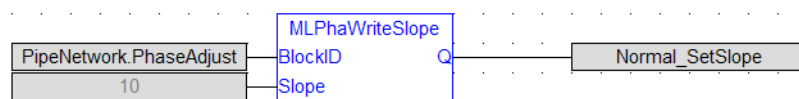

2.1.14 Motion Library - PMP

Name	Description	Return type
"MLPmpAbs" (→ p. 270)	Moves to an Absolute Position	BOOL
"MLPmpForcePos" (→ p. 271)	Forces the specified position. Possible only when the block is not moving.	BOOL
"MLPmpInit" (→ p. 273)	Initializes a PMP object (Parabolic Motion Profile generator) with user-defined settings	BOOL

Name	Description	Return type
"MLPmpReadAccel" (→ p. 276)	Gets the Acceleration parameter of a PMP block	None
"MLPmpReadFstSpd" (→ p. 277)	Gets the FirstTravelSpeed parameter of a PMP block	None
"MLPmpReadInitPos" (→ p. 278)	Gets the InitialPosition parameter of a PMP block	None
"MLPmpReadJerk" (→ p. 279)	Gets the Jerk parameter of a PMP block	None
"MLPmpReadLstSpd" (→ p. 280)	Gets the LastTravelSpeed parameter of a PMP block	None
"MLPmpRel" (→ p. 281)	Does two subsequent relative moves	BOOL
"MLPmpRun" (→ p. 283)	Jog the generator at the specified speed	BOOL
"MLPmpStatus" (→ p. 284)	Returns the status of the PMP block generator	None
"MLPmpWriteAccel" (→ p. 285)	Sets the acceleration parameter of a PMP block	BOOL
"MLPmpWriteFstSpd" (→ p. 287)	Sets the FirstTravelSpeed parameter of a PMP block	BOOL
"MLPmpWriteJerk" (→ p. 288)	Sets the jerk parameter of a PMP block	BOOL
"MLPmpWriteLstSpd" (→ p. 289)	Sets the LastTravelSpeed parameter of a PMP block	BOOL

2.1.14.1 MLPmpAbs

2.1.14.2.1 Description

Move to an Absolute Position using a parabolic acceleration profile. The FIRST_TRAVEL_SPEED is used as the velocity for the motion. JERK determines the level of parabolic acceleration. Returns TRUE if the function succeeded.

2.1.14.3.2 Arguments

2.1.14.4.3.1 Input

BlockID	Description	ID Name of the PMP function block in the Pipe Network
	Data type	DINT
	Range	[-2147483648, 2147483648]
	Unit	n/a
	Default	—
Position	Description	Absolute Position of motor/load to be at after this FB is complete
	Data type	LREAL
	Range	—

Unit	User unit
Default	—

2.1.14.5.4.2 Output

Default (.Q)	Description	Returns True if the function block is successfully executing
	Data type	BOOL
	Unit	n/a

2.1.14.6.5 Related Functions

"MLPmpWriteAccel" (→ p. 285)

"MLPmpWriteJerk" (→ p. 288)

"MLPmpWriteFstSpd" (→ p. 287)

2.1.14.7.6 Example

2.1.14.8.7.1 Structured Text

```
MLPmpAbs ( PipeNetwork.PmpMaster, 1000.0 ) ;
```

2.1.14.9.8.2 Ladder Diagram

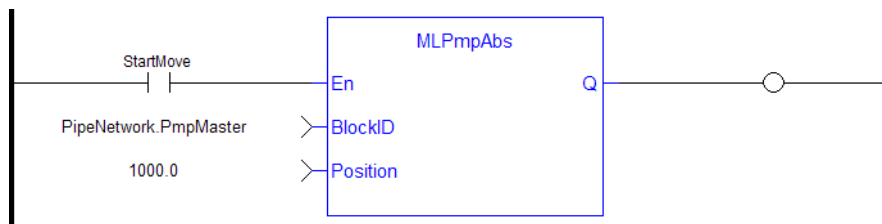

2.1.14.10.9.3 Function Block Diagram

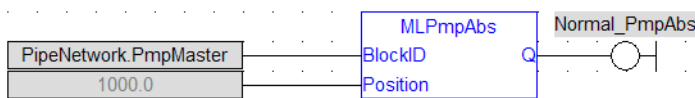

2.1.14.11 MLPmpForcePos Pipe Network ✓

2.1.14.12.1 Description

Forces the position of a PMP Block to a specified position. This block can only be executed when motion is not occurring. It can be used to force the PMP starting position to the desired values from which to start motion.

2.1.14.13.2 Arguments

2.1.14.14.3.1 Input

EN	Description	Enables FB to be executed
-----------	--------------------	---------------------------

	Data type	BOOL
	Range	0, 1
	Unit	n/a
	Default	—
Block ID	Description	ID name of the PMP Block
	Data type	DINT
	Range	[-2147483648, 2147483648]
	Unit	n/a
	Default	—
Position	Description	Defines the PMP starting position when the motion starts
	Data type	LREAL
	Range	—
	Unit	User unit
	Default	—

2.1.14.15.4.2 Output

Default (.Q)	Description	Returns true when function successfully executes
	Data type	BOOL
	Unit	n/a

2.1.14.16.5 Related Functions

"MLPmpReadInitPos" (→ p. 278)

2.1.14.17.6 Example

2.1.14.18.7.1 Structured Text

```
MLPmpForcePos ( PipeNetwork.PMP, 2500.0 );
```

2.1.14.19.8.2 Ladder Diagram

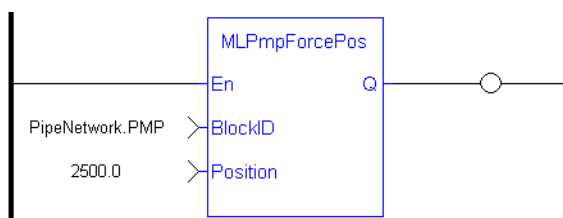

NOTE

You must use a [pulse contact](#) to start the FB

2.1.14.20.9.3 Function Block Diagram



2.1.14.21 MLPmpInit Pipe Network ✓

2.1.14.22.1 Description

Initializes a Pmp Block for use in a PLC Program. This function block is automatically called by the Function PipeNetwork(MLPN_CREATE_OBJECTS) if a Pmp Block is added to the Pipe Network, with user-defined settings entered in the Pipe Blocks Properties screen.

The Pmp Pipe Block is assigned a Name, SAMPLING_PERIOD, MODULO_POSITION, FIRST_TRAVEL_SPEED, LAST_TRAVEL_SPEED, ACCELERATION, JERK, and INITIAL Position. Some of these parameters can be changes in an application program using other MLPmp function blocks

A MLPmpRel function block is used to make a bi directional motion. First movement in one direction, then a return motion back to the initial position. A MLPmpAbs function block is use to move one direction to an absolute position.

NOTE

Pmp objects are normally created in the Pipe Network using the graphical engine. Then you do not have to add MLPmpInit function blocks to their programs. Parameters are entered directly in pop-up windows, and the code is then automatically added to the current project.

2.1.14.23.2 Arguments

2.1.14.24.3.1 Input

BlockID	Description	ID Name of a PMP function block in the Pipe Network
	Data type	DINT
	Range	[-2147483648, 2147483648]
	Unit	n/a
	Default	—
ModuloPosition	Description	Modulo Position for cyclic motion systems expressed in user logical units (Position Rollover Value)
	Data type	LREAL
	Range	—
	Unit	User unit
	Default	360.0
Period	Description	Sampling period of the generator expressed according to the update cycle (e.g. 2.0 means the sampling is done once every 2 cycles)

	Data type	LREAL
	Range	—
	Unit	User unit
	Default	1.0
FirstTravelSpeed	Description	First Travel Speed of the motion
	Data type	LREAL
	Range	—
	Unit	User unit/sec
	Default	100.0
LastTravelSpeed	Description	Last Travel Speed of the motion
	Data type	LREAL
	Range	—
	Unit	User unit/sec
	Default	100.0
Acceleration	Description	Acceleration of the Pmp block motion
	Data type	LREAL
	Range	—
	Unit	User unit/sec ²
	Default	1000.0
Jerk	Description	Jerk
	Data type	LREAL
	Range	—
	Unit	User unit/sec ³
	Default	0
InitialPosition	Description	Initial Position of the Pmp block when the Pipe Network is start up
	Data type	LREAL
	Range	—
	Unit	User unit
	Default	0

Modulo	Description	The available modes are Modulo (True) or No modulo (False)
	Data type	BOOL
	Range	0, 1
	Unit	n/a
	Default	—

2.1.14.25.4.2 Output

Default (.Q)	Description	Returns True if the function block is successfully executing
	Data type	BOOL
	Unit	n/a

2.1.14.26.5 Related Functions

"MLPmpReadAccel" (→ p. 276)

"MLPmpReadFstSpd" (→ p. 277)

"MLPmpReadInitPos" (→ p. 278)

"MLPmpReadJerk" (→ p. 279)

"MLPmpReadLstSpd" (→ p. 280)

2.1.14.27.6 Example

2.1.14.28.7.1 Structured Text

```
//Initialize a PMP Pipe Block named "PMP" to a modulo roll over
of 360, motion generator sample period of 1, First Travel Speed
of 800.0, Second Travel Speed of 20000.0, Accel of 20000.0, Jerk
of 520.0, Initial position of 0.0
MLPmpInit( PipeNetwork.Pmp , 360.0, 1.0, 800.0, 20000.0,
20000.0, 520.0, 0, true ) ;
```

2.1.14.29.8.2 Ladder Diagram

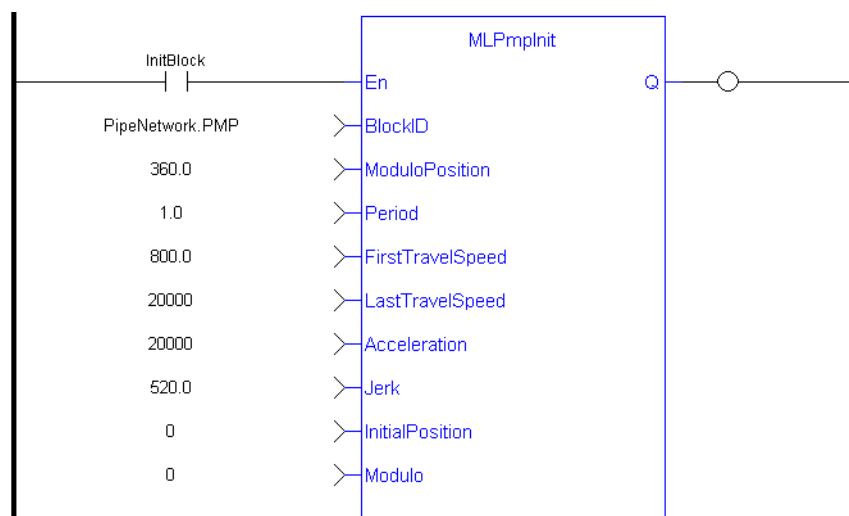

2.1.14.30.9.3 Function Block Diagram

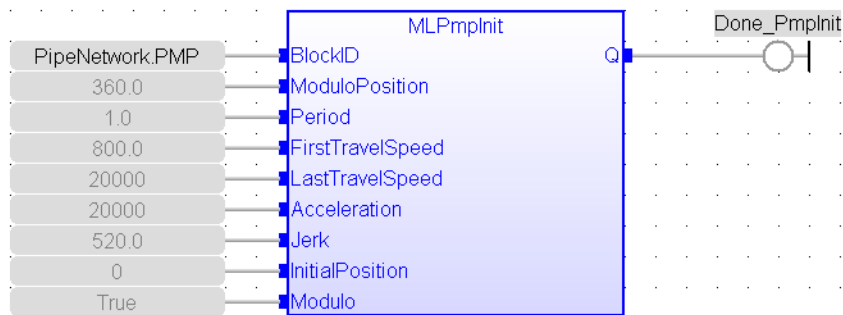

2.1.14.31 MLPmpReadAccel Pipe Network ✓

2.1.14.32.1 Description

Get the Acceleration parameter of a PMP block used in both the MLPmpAbs and MLPmpRel function block.

2.1.14.33.2 Arguments

2.1.14.34.3.1 Input

BlockID	Description	ID Name of the PMP function block in the Pipe Network
	Data type	DINT
	Range	[-2147483648, 2147483648]
	Unit	n/a
	Default	—

2.1.14.35.4.2 Output

Acceleration	Description	Present Acceleration of the PMP PipeNetwork Function Block
	Data type	LREAL
	Unit	User unit/sec ²
	Default	Value defined PMP Block when creating a Pipe Network. It is in the "ACCELERATION" field in the parameter tab.

2.1.14.36.5 Related Functions

"MLPmpReadFstSpd" (→ p. 277)

"MLPmpReadInitPos" (→ p. 278)

"MLPmpReadJerk" (→ p. 279)

"MLPmpReadLstSpd" (→ p. 280)

2.1.14.37.6 Example

2.1.14.38.7.1 Structured Text

```
PmpAccelValue := MLPmpReadAccel ( PipeNetwork.PmpMaster ) ;
```

2.1.14.39.8.2 Ladder Diagram

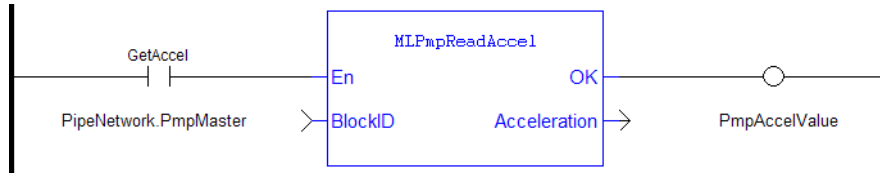

2.1.14.40.9.3 Function Block Diagram



2.1.14.41 MLPmpReadFstSpd Pipe Network ✓

2.1.14.42.1 Descriptions

Get the FirstTravelSpeed parameter of a PMP block. This parameter is used as the first of 2 speeds in an MLPmpRel Motion Block. It is also used as the speed in an MLPmpAbs Motion Block.

2.1.14.43.2 Arguments

2.1.14.44.3.1 Input

BlockID	Description	ID Name of a PMP function block in the Pipe Network
	Data type	DINT
	Range	[-2147483648, 2147483648]
	Unit	n/a
	Default	—

2.1.14.45.4.2 Output

FirstTravelSpeed	Description	Present first travel velocity of the PMP PipeNetwork Function Block
	Data type	LREAL
	Unit	User unit/sec
	Default	Value defined in the setup of a PMP Block within a Pipe Network. It is in the "FIRST_TRAVEL_SPEED" field in the parameter tab

2.1.14.46.5 Related Functions

"MLPmpReadAccel" (→ p. 276)

MLPmpReadFstSpd

"MLPmpReadInitPos" (→ p. 278)

"MLPmpReadJerk" (→ p. 279)

"MLPmpReadLstSpd" (→ p. 280)

"MLPmpWriteLstSpd" (→ p. 289)

2.1.14.47.6 Example

2.1.14.48.7.1 Structured Text

```
FirstSpeedValue := MLPmpReadFstSpd( PipeNetwork.PmpMaster ) ;
```

2.1.14.49.8.2 Ladder Diagram

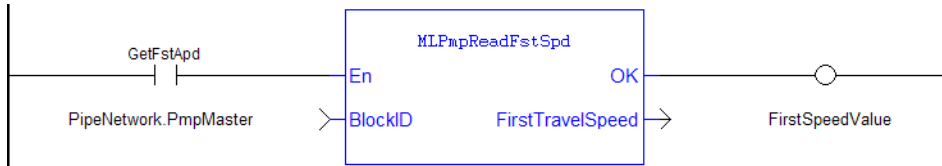

2.1.14.50.9.3 Function Block Diagram



2.1.14.51 MLPmpReadInitPos Pipe Network ✓

2.1.14.52.1 Description

Get the Initial Position parameter of a PMP block. This value is the position the Pmpblock starts at when the Pipe Network is enabled. This position can be set when adding a Pmp Block to a Pipe Network and defining the parameters for that block.

2.1.14.53.2 Arguments

2.1.14.54.3.1 Input

BlockID	Description	ID Name of a PMP function block in the Pipe Network
	Data type	DINT
	Range	[-2147483648, 2147483648]
	Unit	n/a
	Default	—

2.1.14.55.4.2 Output

InitialPosition	Description	Present Initial Position of the PMP PipeNetwork Function Block
	Data type	LREAL
	Unit	User unit
	Default	Value defined in the setup of a PMP Block within a Pipe Network. It is in the "INITIAL_POSITION" field in the parameter tab.

2.1.14.56.5 Related Functions

"MLPmpInIt" (→ p. 273)

2.1.14.57.6 Example

2.1.14.58.7.1 Structured Text

```
PmpInitPos := MLPmpReadInitPos ( PipeNetwork.PmpMaster ) ;
```

2.1.14.59.8.2 Ladder Diagram

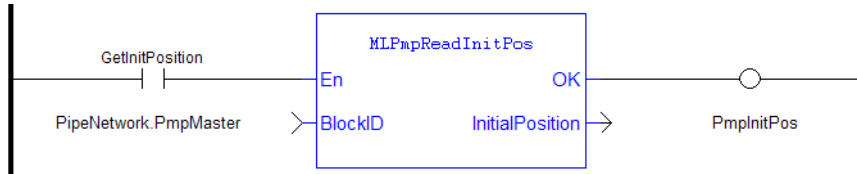

2.1.14.60.9.3 Function Block Diagram

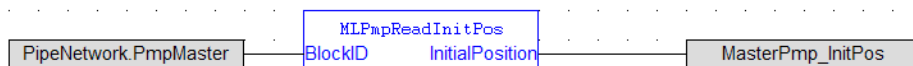

2.1.14.61 MLPmpReadJerk Pipe Network ✓

2.1.14.62.1 Description

Get the Jerk parameter of a PMP block used in both the MLPmpAbs and MLPmpRel function block.

2.1.14.63.2 Arguments

2.1.14.64.3.1 Input

BlockID	Description	ID Name of a PMP function block in the Pipe Network
	Data type	DINT
	Range	[-2147483648, 2147483648]
	Unit	n/a
	Default	—

2.1.14.65.4.2 Output

Jerk	Description	Jerk of the PMP PipeNetwork Function Block
	Data type	LREAL
	Unit	User unit/sec ³
	Default	Value defined in the setup of a PMP Block within a Pipe Network. It is in the “JERK” field in the parameter tab.

2.1.14.66.5 Example

2.1.14.67.6.1 Structured Text

```
PmpJerkValue := MLPmpReadJerk ( PipeNetwork.PmpMaster ) ;
```

2.1.14.68.7.2 Ladder Diagram

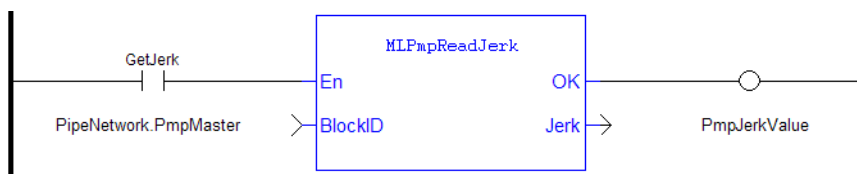

2.1.14.69.8.3 Function Block Diagram



2.1.14.70 MLPmpReadLstSpd Pipe Network ✓

2.1.14.71.1 Description

Get the LastTravelSpeed parameter of a PMP block used in the MLPmpRel function block.

2.1.14.72.2 Arguments

2.1.14.73.3.1 Input

BlockID	Description	ID Name of a PMP function block in the Pipe Network
	Data type	DINT
	Range	[-2147483648, 2147483648]
	Unit	n/a
	Default	—

2.1.14.74.4.2 Output

LastTravelSpeed	Description	Last Travel Speed of the PMP PipeNetwork Function Block
	Data type	LREAL
	Unit	User unit/sec
	Default	Value defined in the setup of a PMP Block within a Pipe Network. It is in the "LAST_TRAVEL_SPEED" field in the parameter tab.

2.1.14.75.5 Related Functions

"MLPmpReadAccel" (→ p. 276)

"MLPmpReadFstSpd" (→ p. 277)

"MLPmpReadInitPos" (→ p. 278)

"MLPmpReadJerk" (→ p. 279)

2.1.14.76.6 Example

2.1.14.77.7.1 Structured Text

```
PmpLastSpeed := MLPmpReadLstSpd( PipeNetwork.PmpMaster ) ;
```

2.1.14.78.8.2 Ladder Diagram

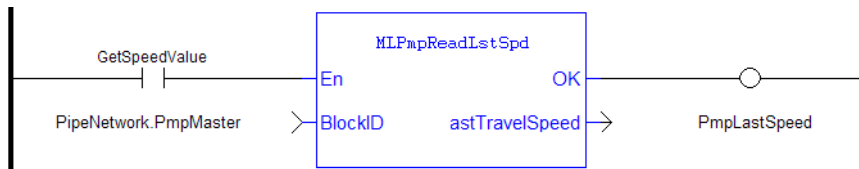

2.1.14.79.9.3 Function Block Diagram



2.1.14.80 MLPmpRel Pipe Network ✓

2.1.14.81.1 Description

This function is used to perform two subsequent relative moves. Using the MLPmpRel function block, the PMP Generator is capable of producing forward-backward motions with a non-stop, jerk-free transition through zero speed (see Figure below). This feature is frequently useful for linear axes which must move back and forward without any pause at one end.

This function can also be used to do a single relative move, ending in zero speed, by setting the **DeltaSecond** argument to zero (0.0). If it is done, for the controlling speed to be the first move, the “Last_Travel_Speed” parameter has to be set equal to or greater than the “First_Travel_Speed” parameter.

In general, the slower of the two “Speeds” is utilized to optimize the S-curve behavior for the move whether it is a 2 or 1 delta move.

If the DeltaSecond argument is non-zero, it must have the opposite sign than the sign of the DeltaFirst argument.

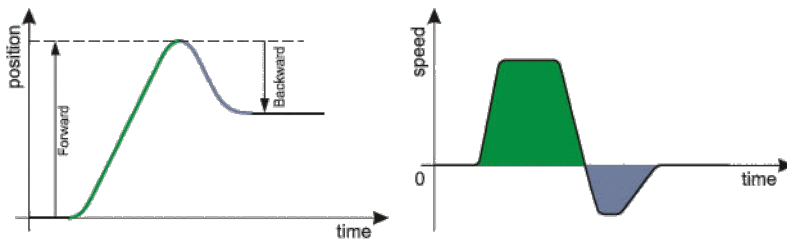

Figure 1-40: PMP Generator Forward & Backward Motion Profile

2.1.14.82.2 Arguments

2.1.14.83.3.1 Input

BlockID	Description	ID Name of the PMP function block in the Pipe Network
	Data type	DINT
	Range	[-2147483648, 2147483648]
	Unit	n/a
	Default	—
DeltaFirst	Description	Length of first Move
	Data type	LREAL
	Range	—

	Unit	User unit
	Default	Value defined in the setup of a PMP Block within a Pipe Network. It is the "FIRST_TRAVEL_SPEED" field in the parameter tab.
DeltaSecond	Description	Length of second (return) Move
	Data type	LREAL
	Range	—
	Unit	User unit
	Default	Value defined in the setup of a PMP Block within a Pipe Network. It is the "LAST_TRAVEL_SPEED" field in the parameter tab.

2.1.14.84.4.2 Output

Default (.Q)	Description	Returns True if the MLPmIRel successfully completed
	Data type	BOOL
	Unit	n/a

2.1.14.85.5 Related Functions

"MLPmpWriteAccel" (→ p. 285)

"MLPmpWriteFstSpd" (→ p. 287)

"MLPmpWriteJerk" (→ p. 288)

"MLPmpWriteLstSpd" (→ p. 289)

2.1.14.86.6 Example

2.1.14.87.7.1 Structured Text

```
//Execute a Relative move on a PMP Block name "PmpMaster" with a
First Travel Speed of 750.0, Second Travel Speed of -500,
MLPmpRel( PipeNetwork.PmpMaster, 750 , -500);
```

2.1.14.88.8.2 Ladder Diagram

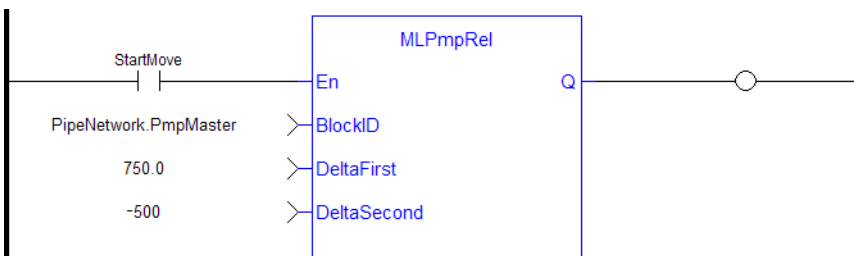

2.1.14.89.9.3 Function Block Diagram



2.1.14.90 MLPmpRun Pipe Network ✓

2.1.14.91.1 Description

Jog the generator at the requested speed.

2.1.14.92.2 Arguments

2.1.14.93.3.1 Input

EN	Description	Enables FB to be executed. Is only recognized if the PMP generator is Idle or at constant velocity as determined from the "MLPmpStatus" (→ p. 284) function.
	Data type	BOOL
	Range	0, 1
	Unit	n/a
	Default	—
BlockID	Description	ID Name of the PMP function block in the Pipe Network
	Data type	DINT
	Range	[-2147483648, 2147483648]
	Unit	n/a
	Default	—
Speed	Description	The desired rate at which to Jog. If the speed is 0.0 User Units / second the PMP block decelerates to zero speed and switches to the Idle state (0).
	Data type	LREAL
	Range	—
	Unit	User unit/sec
	Default	—

2.1.14.94.4.2 Output

Default (.Q)	Description	Returns True if the MLPmpRun successfully completed.
	Data type	BOOL
	Unit	n/a

2.1.14.95.5 Related Functions

"MLPmpStatus" (→ p. 284)

2.1.14.96.6 Example

2.1.14.97.7.1 Structured Text

```
//Execute a Relative move on a PMP Block name "PmpMaster" with a
Jog speed of 1000.0
MLPmpRun( PipeNetwork.PmpMaster, 1000.0 ) ;
```

2.1.14.98.8.2 Ladder Diagram

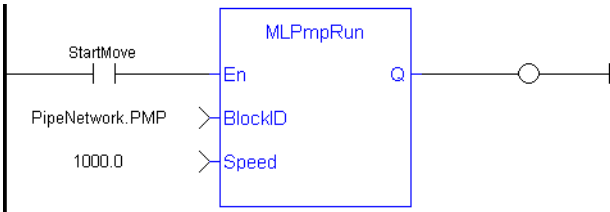

2.1.14.99.9.3 Function Block Diagram



2.1.14.100 MLPmpStatus Pipe Network ✓

2.1.14.101.1 Description

Returns the status of the PMP block generator.

2.1.14.102.2 Arguments

2.1.14.103.3.1 Input

EN	Description Data type Range Unit Default	Enables FB to be executed. BOOL 0, 1 n/a —
BlockID	Description Data type Range Unit Default	ID Name of the PMP function block in the Pipe Network DINT [-2147483648, 2147483648] n/a —

2.1.14.104.4.2 Output

OK	Description Data type Unit	Returns true when function successfully executes BOOL n/a
----	----------------------------------	---

Returns the status of the PMP block generator

Default (.Q)	Description	Value	Description
		0	Indicates that the PMP block is idle. No command is currently running in the generator. It can be used to determine that a previous move is complete.
		1	Indicates that the PMP block is either accelerating to a position or speed, or is decelerating to a position or speed.
		2	Indicates that the PMP block is running at a constant speed.
	Data type	DINT	
	Unit	n/a	

2.1.14.105.5 Example

2.1.14.106.6.1 Structured Text

```
PMP_Status := MLPmpStatus ( PipeNetwork.PmpMaster ) ;
Done :=TRUE;
```

2.1.14.107.7.2 Ladder Diagram

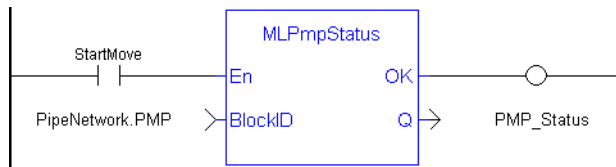

2.1.14.108.8.3 Function Block Diagram



2.1.14.109 MLPmpWriteAccel Pipe Network ✓

2.1.14.110.1 Description

Set the acceleration parameter of a PMP block. Returns TRUE if the function succeeded.

Acceleration can also be set when adding a Pmp Block to a Pipe Network and defining the parameters for that block.

2.1.14.111.2 Arguments

2.1.14.112.3.1 Input

BlockID	Description	ID Name of the PMP function block in the Pipe Network
	Data type	DINT
	Range	[-2147483648, 2147483648]

	Unit	n/a
	Default	—
Acceleration	Description	Acceleration Value
	Data type	LREAL
	Range	> 0
	Unit	User unit/sec ²
	Default	Value defined in the setup of a PMP Block within a Pipe Network. It is the "ACCELERATION" field the parameter tab.

2.1.14.113.4.2 Output

Default (.Q)	Description	Returns True if the function block is successfully executing
	Data type	BOOL
	Unit	n/a

2.1.14.114.5 Related Functions

"MLPmpAbs" (→ p. 270)

"MLPmpRel" (→ p. 281)

"MLPmpWriteFstSpd" (→ p. 287)

"MLPmpWriteJerk" (→ p. 288)

"MLPmpWriteLstSpd" (→ p. 289)

2.1.14.115.6 Example

2.1.14.116.7.1 Structured Text

```
MLPmpWriteAccel( PipeNetwork.PmpMaster, 40000.0 ) ;
```

2.1.14.117.8.2 Ladder Diagram

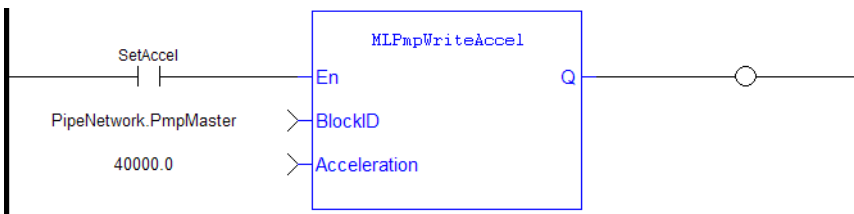

2.1.14.118.9.3 Function Block Diagram

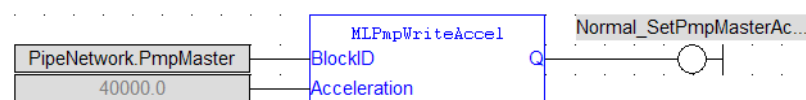

2.1.14.119 MLPmpWriteFstSpd **2.1.14.120.1 Description**

Set the FirstTravelSpeed parameter of a PMP block. Returns TRUE if the function succeeded. FirstTravelSpeed can also be set when adding a Pmp Block to a Pipe Network and defining the parameters for that block.

2.1.14.121.2 Arguments**2.1.14.122.3.1 Input**

BlockID	Description	ID Name of the PMP function block in the Pipe Network
	Data type	DINT
	Range	[-2147483648, 2147483648]
	Unit	n/a
	Default	—
First Travel Speed	Description	First Travel Speed Value
	Data type	LREAL
	Range	> 0
	Unit	User unit/sec
	Default	Value defined in the setup of a PMP Block within a Pipe Network. It is the "FIRST_TRAVEL_SPEED" field in the parameter tab.

2.1.14.123.4.2 Output

Default (.Q)	Description	Returns True if the function block is successfully executing
	Data type	BOOL
	Unit	n/a

2.1.14.124.5 Related Functions

"MLPmpAbs" (→ p. 270)

"MLPmpRel" (→ p. 281)

"MLPmpWriteAccel" (→ p. 285)

"MLPmpWriteJerk" (→ p. 288)

"MLPmpWriteLstSpd" (→ p. 289)

2.1.14.125.6 Example**2.1.14.126.7.1 Structured Text**

```
MLPmpWriteFstSpd( PipeNetwork.PmpMaster, 300.0 ) ;
```

2.1.14.127.8.2 Ladder Diagram

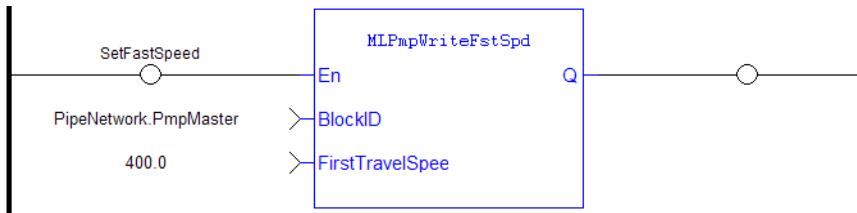

2.1.14.128.9.3 Function Block Diagram

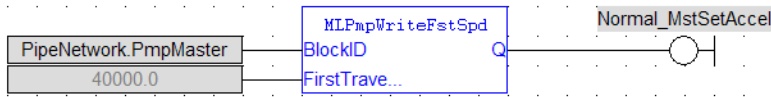

2.1.14.129 MLPmpWriteJerk Pipe Network ✓

2.1.14.130.1 Description

Set the jerk parameter of a PMP block. Returns TRUE if the function succeeded. Jerk can also be set when adding a Pmp Block to a Pipe Network and defining the parameters for that block.

2.1.14.131.2 Arguments

2.1.14.132.3.1 Input

BlockID	Description	ID Name of the PMP function block in the Pipe Network
	Data type	DINT
	Range	[-2147483648, 2147483648]
	Unit	n/a
	Default	—
Jerk	Description	Jerk Value
	Data type	LREAL
	Range	> 0
	Unit	User unit/sec ³
	Default	Value defined in the setup of a PMP Block within a Pipe Network. It is the "JERK" field in the parameter tab.

2.1.14.133.4.2 Output

Default (.Q)	Description	Returns True if the function block is successfully executing
	Data type	BOOL
	Unit	n/a

2.1.14.134.5 Related Functions

"MLPmpAbs" (→ p. 270)

"MLPmpReadJerk" (→ p. 279)

"MLPmpRel" (→ p. 281)

"MLPmpWriteAccel" (→ p. 285)

"MLPmpWriteFstSpd" (→ p. 287)

"MLPmpWriteLstSpd" (→ p. 289)

2.1.14.135.6 Example

2.1.14.136.7.1 Structured Text

```
MLPmpWriteJerk( PipeNetwork.PmpMaster, 15.0 ) ;
```

2.1.14.137.8.2 Ladder Diagram



2.1.14.138.9.3 Function Block Diagram

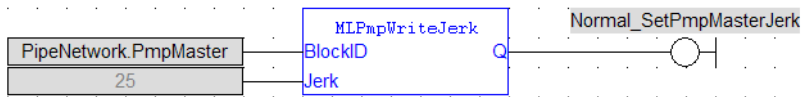

2.1.14.139 MLPmpWriteLstSpd Pipe Network ✓

2.1.14.140.1 Description

Set the LastTravelSpeed parameter of a PMP block. Returns TRUE if the function succeeded. Last Travel Speed can also be set when adding a Pmp Block to a Pipe Network and defining the parameters for that block.

2.1.14.141.2 Arguments

2.1.14.142.3.1 Input

BlockID	Description	ID Name of the PMP function block in the Pipe Network
	Data type	DINT
	Range	[-2147483648, 2147483648]
	Unit	n/a
	Default	—
Last Speed	Description	Last Travel Speed Value
	Data type	LREAL
	Range	> 0

Unit	User unit/sec
Default	Value defined in the setup of a PMP Block within a Pipe Network. It is in the "LAST_TRAVEL_SPEED" field in the parameter tab.

2.1.14.143.4.2 Output

Default (.Q)	Description	Returns True if the function block is successfully executing
	Data type	BOOL
	Unit	n/a

2.1.14.144.5 Related Functions

- "MLPmpAbs" (→ p. 270)
- "MLPmpReadLstSpd" (→ p. 280)
- "MLPmpRel" (→ p. 281)
- "MLPmpWriteAccel" (→ p. 285)
- "MLPmpWriteFstSpd" (→ p. 287)
- "MLPmpWriteJerk" (→ p. 288)

2.1.14.145.6 Example

2.1.14.146.7.1 Structured Text

```
MLPmpWriteLstSpd( PipeNetwork.PmpMaster, 650 ) ;
```

2.1.14.147.8.2 Ladder Diagram

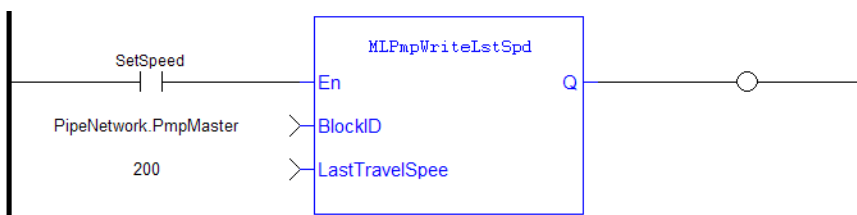

2.1.14.148.9.3 Function Block Diagram

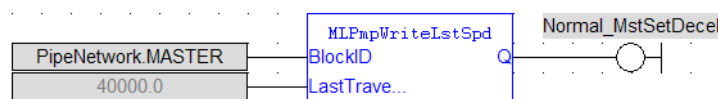

2.1.15 Motion Library - Sampler

Name	Description	Return type
"MLSmpConnect" (→ p. 291)	Connects a sampler block to a pipe network axis or pipe block	BOOL
"MLSmpConECAT" (→ p. 292)	Connects a sampler block to the specified CoE object in a PDO	BOOL

Name	Description	Return type
"MLSmpConPLCAxis" (→ p. 297)	Connects a sampler block to a PLCopen axis variable	BOOL
"MLSmpConPNAxis" (→ p. 298)	Connects a sampler block to a Pipe Network axis variable	BOOL
"MLSmpInit" (→ p. 294)	Initializes a sampler object	BOOL

TIP

There is a delay when using an external encoder. The delay is five cycles (2 cycles to read the encoder from the AKD via EtherCAT, 1 cycle for computing, 2 cycles for sending the new position set point to the AKD). This lag error is speed proportional (5 cycles * speed). A Phaser block can be used to compensate for this lag.

2.1.15.1 MLSmpConnect

2.1.15.2.1 Description

Connect a sampler to an axis or pipe block as a value source. Returns TRUE if the function succeeded.

2.1.15.3.2.1 Related Function Blocks

"MLSmpConECAT" (→ p. 292), "MLSmpInit" (→ p. 294), "MLSmpConPNAxis" (→ p. 298), "MLSmpConPLCAxis" (→ p. 297)

2.1.15.4.3 Arguments

2.1.15.5.4.1 Input

BlockID	Description	ID Name of the SMP function block in the Pipe Network
	Data type	DINT
	Range	[-2147483648, 2147483648]
	Unit	n/a
	Default	—
PipeBlockID	Description	ID Name of the Pipe Block the sampler is connected to
	Data type	DINT
	Range	[-2147483648, 2147483648]
	Unit	n/a
	Default	—

2.1.15.6.5.2 Output

Default (.Q)	Description	Returns True if the Sampler is connected.
	Data type	BOOL
	Unit	n/a

2.1.15.7.6.3 Return Type

BOOL

2.1.15.8.7 Example

2.1.15.9.8.1 Structured Text

```
//Connect a Sampler pipe block named "EncoderMaster1" to a
PipeNetwork Axis block named AXIS1
MLSmpConnect( PipeNetwork.EncoderMaster1, PipeNetwork.AXIS1 ) ;
```

2.1.15.10.9.2 Ladder Diagram

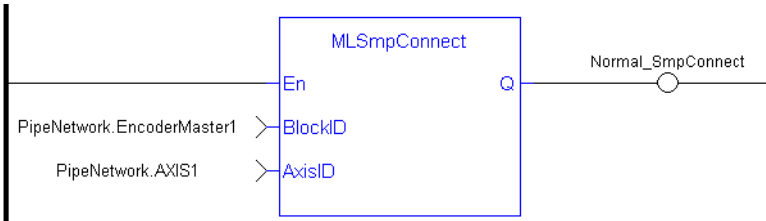

2.1.15.11.10.3 Function Block Diagram



2.1.15.12 MLSmpConECAT Pipe Network ✓

2.1.15.13.1 Description

Connects a sampler block to the specified CoE object. The CoE object must be included in a PDO for the specified EtherCAT device.

Using this function, you can use any EtherCAT data source as input for the specified sampler block.

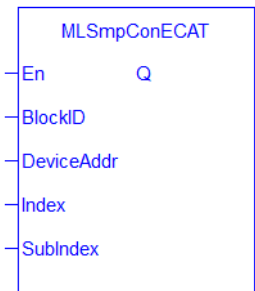

Figure 1-41: MLSmpConECAT function

2.1.15.14.2.1 Related Function Blocks

"MLSmpConnect" (→ p. 291), "MLSmplnit" (→ p. 294)

2.1.15.15.3 Arguments

2.1.15.16.4.1 Input

BlockID	Description	ID Name of the Sampler function block in the Pipe Network
	Data type	DINT
	Range	[-2147483648, 2147483648]

	Unit	n/a
	Default	—
DeviceAddr	Description	The EtherCAT address of the slave device. The first node usually has the value '1001'. Alternately, you can use the members of the EtherCATCode structure to specify a device's address.
	Data type	INT
	Range	—
	Unit	n/a
	Default	—
Index	Description	The CoE index of the object to be connected with the Sampler block.
	Data Type	UINT
	Range	—
	Unit	n/a
	Default	—
SubIndex	Description	The CoE sub-index of the object to be connected with the Sampler block.
	Data Type	UINT
	Range	—
	Unit	n/a
	Default	—

2.1.15.17.5.2 Output

Default (.Q)	Description	Function block is operational
	Data type	BOOL
	Unit	n/a

2.1.15.18.6.3 Return Type

BOOL

2.1.15.19.7 Example

2.1.15.20.8.1 Structured Text

```
//Connect a Sampler pipe block named "EncoderMaster" to an ECAT
Index Object defined by variable "CoE_SubIndex" with the
```

```
SubIndex defined by variable "CoE_SubIndex", from a device with
Ethercat Address defined by "ECAT_Addr"
MLSmpConECAT(PipeNetwork.EncoderMaster, ECAT_Addr, CoE_Index,
CoE_SubIndex );
```

2.1.15.21.9.2 Ladder Diagram

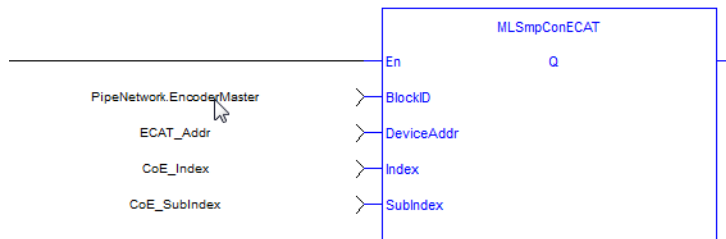

2.1.15.22.10.3 Function Block Diagram

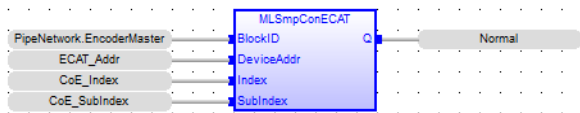

2.1.15.23 MLSmpConnectEx Pipe Network ✓

2.1.15.24.1 Description

Connect a sampler to the specified data source.

NOTE

This function was deprecated in KAS v2.9. Please use either "MLSmpConECAT" (→ p. 292), "MLSmpConPLCAxis" (→ p. 297), or "MLSmpConPNAxis" (→ p. 298) instead.

2.1.15.25 MLSmplnit Pipe Network ✓

2.1.15.26.1 Description

The purpose of the sampler block is to periodically sample and place into a pipe some output of a source object. The sampled output can typically be the POSITION or SPEED of a source object measured by a resolver, an encoder or some other types of sensor.

The sampler implements the logical connection between an encoder on a physical master axis (the source object) and one or more pipes and performs the function of periodically sampling the source and placing the sampled values into the pipe.

This function block is automatically called by the Function PipeNetwork(MLPN_CREATE_OBJECTS) if a Smp Block is added to the Pipe Network, with user-defined settings entered in the Pipe Blocks Properties screen.

The Smp Pipe Block is assigned a Name, SAMPLING_PERIOD, MODE, INPUT_VALUE_PERIOD and OUTPUT_VALUE_PERIOD.

Using AKD Secondary Feedback

The Sampler can be connected to the secondary feedback on the AKD using "MLSmpConPNAxis" (→ p. 298). The scaling for the AKD Secondary Feedback is setup using AKD Parameters: DRV.HANDWHEEL and FB2.ENCRES. The feedback signal comes through Ethercat in object 0x2050.

The scaling for this position signal is 0 to 4294967296 = 0 to FB2.ENCRES. Object 0x2050 rollovers to 0 when reaching 4294967296. One way to handle this rollover is in the Sampler block setup parameters set up

INPUT_MODULO_POSITION for LREAL#4294967296 and OUTPUT_MODULO_POSITION to the modulo of the application.

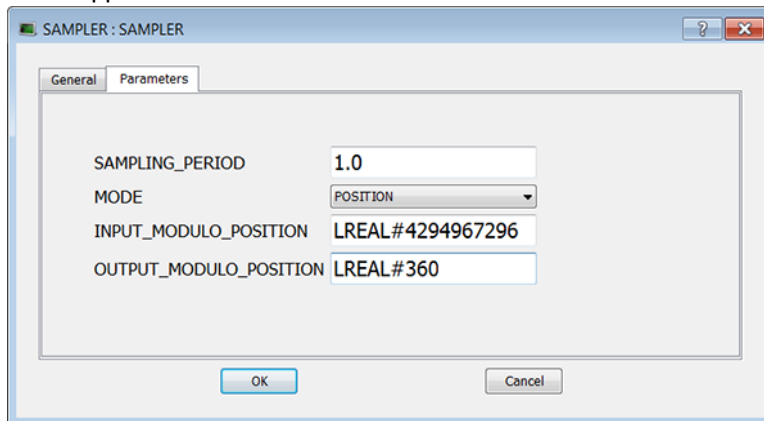

Place a Phaser Block (and write MLPhaWritePhase in the application code) or Gear Block (and write MLGearWriteOff) after the Sampler Block to offset the Sampler Block Output Position in the pipe Network.

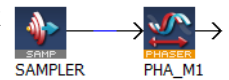

2.1.15.27.2.1 Related Function Blocks

"MLSmpConnect" (→ p. 291), "MLSmpConECAT" (→ p. 292), "MLSmpConPLCAxis" (→ p. 297), "MLSmpConPNAxis" (→ p. 298)

2.1.15.28.3 Arguments

2.1.15.29.4.1 Input

BlockID	Description	ID Name of the SMP function block in the Pipe Network
	Data type	DINT
	Range	[-2147483648, 2147483648]
	Unit	n/a
	Default	—
SamplingPeriod	Description	period that the device is sampled
	Data type	LREAL
	Range	0.25 to ?
	Unit	millisecond
	Default	1.0
Mode	Description	Sampled output can be either position or velocity
	Data type	DINT
	Range	[1 , 2] Position or Speed
	Unit	n/a
	Default	position

InputModuloPosition	Description	Period of the input signal. This should be set equal to 2^{32} (4294967296).
	Data type	LREAL
	Range	—
	Unit	User unit
	Default	360.0
OutputModuloPosition	Description	Period of the output signal
	Data type	LREAL
	Range	—
	Unit	User unit
	Default	360.0

2.1.15.30.5.2 Output

Default (.Q)	Description	Smp Block successfully initiated
	Data type	BOOL
	Unit	n/a

2.1.15.31.6 Example

2.1.15.32.7.1 Structured Text

```
//Initialize a Sampler Pipe Block named "EncoderMaster1" to a
Sample Period of 1 millisec, Mode of Operation to 2(Velocity),
Input Modulo of 4294967296, and Output Modulo of 720
MLSmpInit( PipeNetwork.EncoderMaster1, 1.0,2,4294967296,720);
```

2.1.15.33.8.2 Ladder Diagram

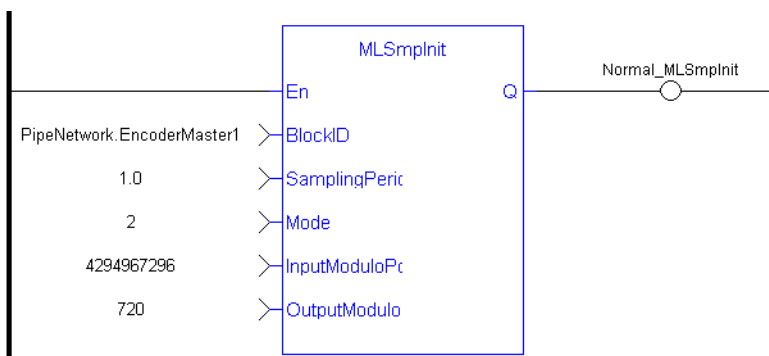

2.1.15.34.9.3 Function Block Diagram

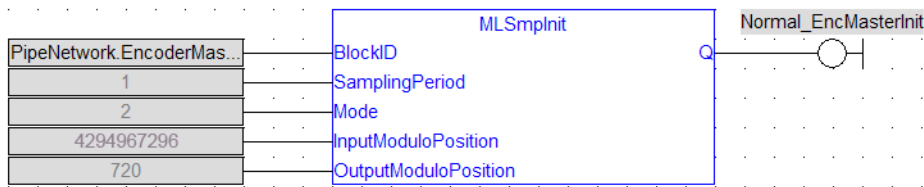

2.1.15.35 MLSmpConPLCAxis Pipe Network ✓

2.1.15.36.1 Description

This function connects a sampler block to a specific variable from a PLCOpen Axis.

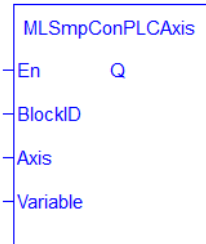

Figure 1-42: MLSmpConPLCAxis function

2.1.15.37.2 Arguments

2.1.15.38.3.1 Input

BlockID	Description	ID Name of the SMP function block in the Pipe Network
	Data type	DINT
	Range	[-2147483648, 2147483648]
	Unit	n/a
	Default	—
AxisID	Description	Name of a declared instance of the AXIS_REF library function (for more details, click here....)
	Data Type	AXIS_REF
	Range	[1,256]
	Unit	n/a
	Default	—
Variable	Description	Variable to be connected to. You need to use one of the following Internal Defines: <ul style="list-style-type: none"> • MC_ACTUAL_POSITION • MC_COMMAND_POSITION • MC_NORMAL_COMMAND_POSITION • MC_SUPERIMPOSED_COMMAND_POSITION • MC_PHASE_COMMAND_POSITION
	Data Type	UINT

Range	n/a (use available macros)
Unit	n/a
Default	—

2.1.15.39.4.2 Output

Default (.Q)	Description	Function block is operational
	Data type	BOOL
	Unit	n/a

2.1.15.40.5.3 Return Type

BOOL

2.1.15.41.6 Example

2.1.15.42.7.1 Structured Text

```
//Connect a Sampler pipe block named "SAMPLER" to a variable
named "MC_ACTUAL_POSITION" from a PLCOpen Axis named Axis1.
MLSmpConPLCAxis( PipeNetwork.SAMPLER, Axis1, MC_ACTUAL_
POSITION);
```

2.1.15.43.8.2 Ladder Diagram

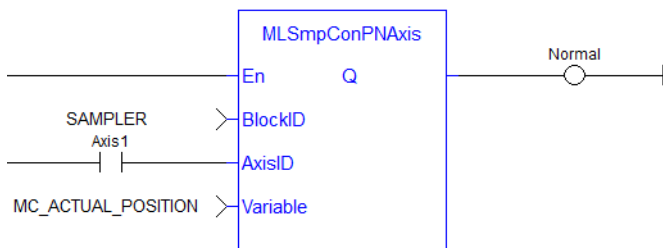

2.1.15.44.9.3 Function Block Diagram



2.1.15.45 MLSmpConPNAxis Pipe Network ✓

2.1.15.46.1 Description

This function connects a sampler block to a specific variable from a PipeNetwork Axis.

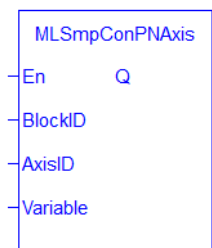

Figure 1-43: MLSmpConPNAxis function

2.1.15.47.2 Arguments

2.1.15.48.3.1 Input

BlockID	Description	ID Name of the SMP function block in the Pipe Network
	Data type	DINT
	Range	[-2147483648, 2147483648]
	Unit	n/a
	Default	—
AxisID	Description	ID Name of the Axis the sampler is connected to
	Data Type	DINT
	Range	[-2147483648, 2147483648]
	Unit	n/a
	Default	—
Variable	Description	Variable to be connected to. You need to use one of the following Internal Defines : <ul style="list-style-type: none"> • ML_PIPE_POSITION • ML_REFERENCE_POSITION • ML_GENERATOR_POSITION • ML_ACTUAL_POSITION • ML_FEEDBACK_POSITION • ML_SECOND_FEEDBACK_POSITION • ML_ACTUAL_VELOCITY • ML_ACTUAL_TORQUE • ML_FOLLOWING_ERROR • ML_CURRENT_POSITION
	Data Type	UINT
	Range	n/a (use available macros)
	Unit	n/a
	Default	—

2.1.15.49.4.2 Output

Default (.Q)	Description	Function block is operational
	Data type	BOOL
	Unit	n/a

2.1.15.50.5.3 Return Type

BOOL

2.1.15.51.6 Example

2.1.15.52.7.1 Structured Text

```
//Connect a sampler block named "SAMPLER" to a variable named
ML_PIPE_POSITION from a Pipe Network Axis named
PipeNetwork.AXIS1
MLSmpConPNAxis( PipeNetwork.SAMPLER , PipeNetwork.AXIS1, ML_
PIPE_POSITION );
```

2.1.15.53.8.2 Ladder Diagram



2.1.15.54.9.3 Function Block Diagram



2.1.16 Motion Library - Synchronizer

TIP

- For a Synchronizer example, see "Usage example of Synchronizer Functions" (→ p. 308)

Name	Description	Return type
MLSyncInit	Initializes a synchronizer Pipe Block	BOOL
MLSyncReadDeltaS	Gets the output phasing value of a synchronizer block	None
MLSyncStart	Starts a synchronization of a synchronizer Pipe Block	BOOL
MLSyncStop	De-synchronizes a synchronizer Pipe Block	BOOL
MLSyncWriteDeltaS	Sets the output phasing value of a synchronizer block	BOOL

2.1.16.1 MLSyncInit Pipe Network ✓

2.1.16.2.1 Description

Initializes a synchronizer Pipe Block. Returns TRUE if the function succeeded.

This FB is automatically created in the compiled code of a Pipe Network.

This function block is part of the MLPN_CREATE_OBJECT to initialize the Pipe Network. It is called at the beginning of an application program with the function call:

```
PipeNetwork(MLPN_CREATE_OBJECTS);
```

2.1.16.3.2 Arguments

2.1.16.4.3.1 Input

BLockID	Description	Name of the Pipe Network Block
	Data type	DINT
	Range	[-2147483648, 2147483648]
	Unit	n/a
	Default	—
ModuloPosition	Description	The modulo distance
	Data type	LREAL
	Range	—
	Unit	User unit
	Default	—
CurveType	Description	The curve type to the motion when starting and stopping synchronization. Option are Parabolic or Polynomial
	Data type	DINT
	Range	[1 , 2] (1 = Parabolic, 2 = Polynomial)
	Unit	n/a
	Default	—
DeltaS	Description	The Distance to get in or out of synchronization. This parameter is used in the MLSyncStart and MLSyncStop FunctionBlocks
	Data type	LREAL
	Range	—
	Unit	User unit
	Default	—

2.1.16.5.4.2 Output

Default (.Q)	Description	Function Block Execute Successfully
	Data type	BOOL
	Unit	n/a

2.1.16.6.5 Related Functions

[MLSyncWriteDeltaS](#)

2.1.16.7.6 Example

2.1.16.8.7.1 Structured Text

```
//Initialize a synchronizer Pipe Block named " SYN" with a
modulo of 360, Curve Type of Parabolic, and a distance (DeltaS)
of 30 to get in and out of synchronization
MLSyncInit( PipeNetwork.SYN, 360, 1, 30 );
```

2.1.16.9.8.2 Ladder Diagram

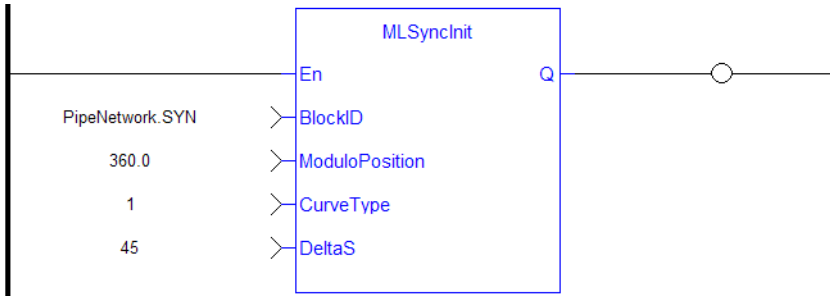

2.1.16.10.9.3 Function Block Diagram



2.1.16.11 MLSyncReadDeltaS Pipe Network ✓

2.1.16.12.1 Description

Gets the output phasing value of a synchronizer block. Output phasing is the distance or the slope the output takes to synchronize with the input when MLSyncStart Block is executed (see "Get Output Phasing after MLSyncStart" (→ p. 302)). It also affects the distance or the slope the output takes to desynchronize with the input and come to a stop when MLSyncStop Block is executed (see "Get Output Phasing after MLSyncStop" (→ p. 303)).

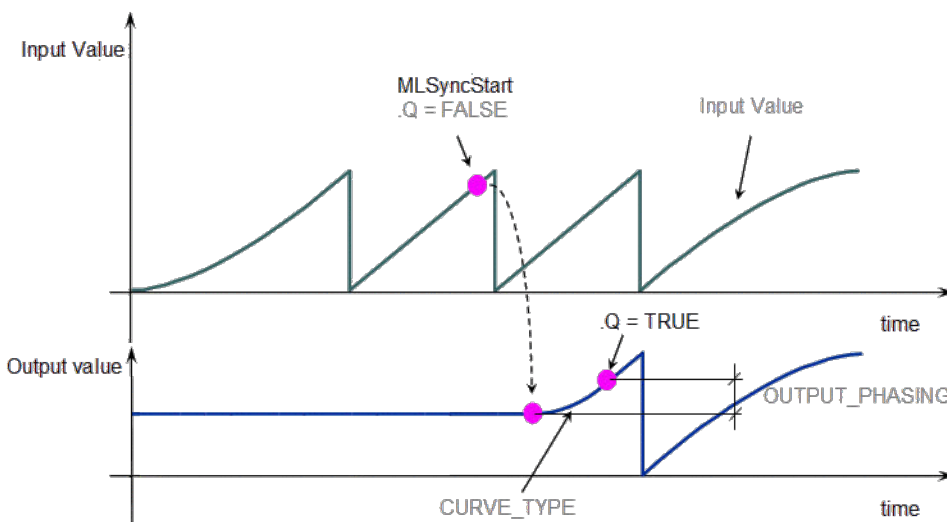

Figure 1-44: Get Output Phasing after MLSyncStart

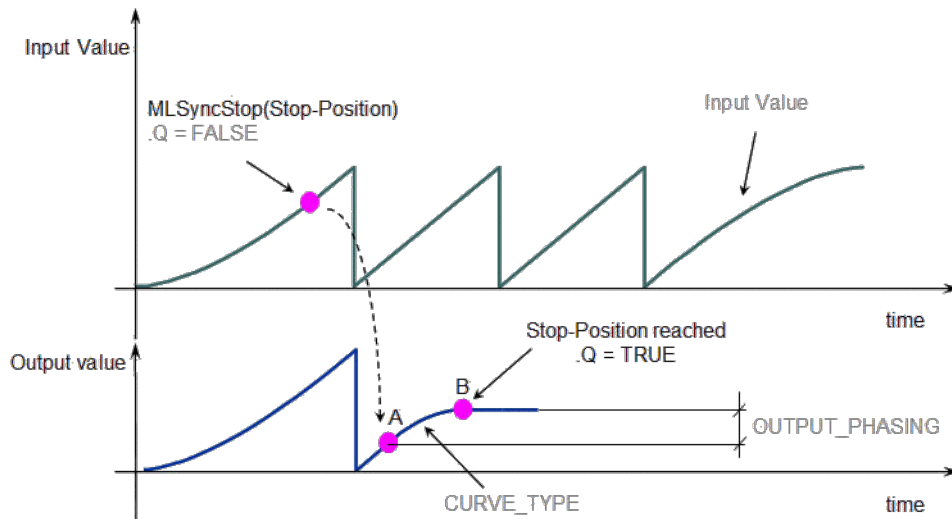

Figure 1-45: Get Output Phasing after MLSyncStop

2.1.16.13.2 Arguments

2.1.16.14.3.1 Input

BlockID	Description	Name of the Pipe Network Block
	Data type	DINT
	Range	[-2147483648, 2147483648]
	Unit	n/a
	Default	—

2.1.16.15.4.2 Output

DeltaS	Description	Present Delta Slope value
	Data type	LREAL
	Unit	User unit

2.1.16.16.5 Related Functions

[MLSyncWriteDeltaS](#)

2.1.16.17.6 Example

2.1.16.18.7.1 Structured Text

```
ActScope := MLSyncReadDeltaS( PipeNetwork.SYN );
```

2.1.16.19.8.2 Ladder Diagram



2.1.16.20.9.3 Function Block Diagram

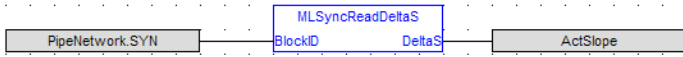

2.1.16.21 MLSyncStart Pipe Network ✓

2.1.16.22.1 Description

Start a synchronization of a synchronizer Pipe Block. Returns TRUE if the function succeeded.

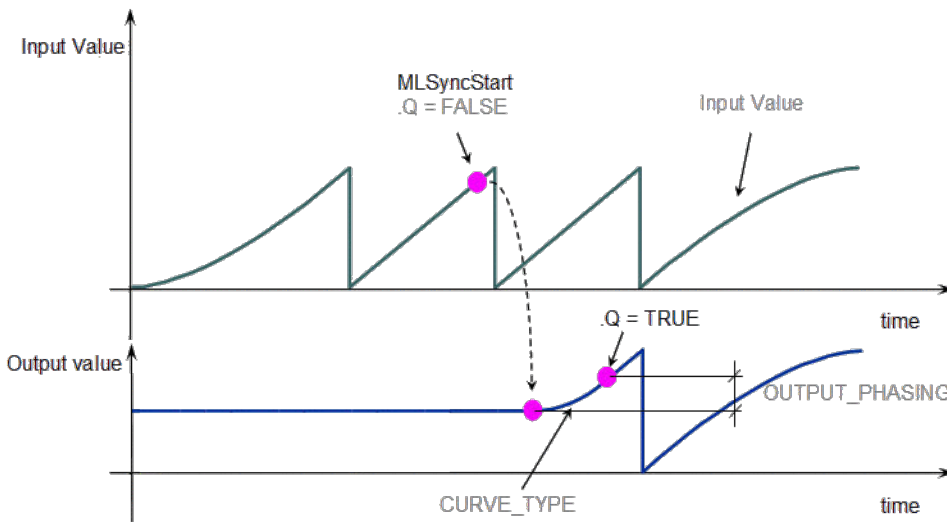

Figure 1-46: MLSyncStart

2.1.16.23.2 Arguments

2.1.16.24.3.1 Input

BlockID	Description	Name of the Pipe Network Block
	Data type	DINT
	Range	[-2147483648, 2147483648]
	Unit	n/a
	Default	—

2.1.16.25.4.2 Output

Default (.Q)	Description	Function Block Execute Successfully
	Data type	BOOL

Unit	n/a
-------------	-----

2.1.16.26.5 Example

2.1.16.27.6.1 Structured Text

```
MLSyncStart( PipeNetwork.SYN );
```

2.1.16.28.7.2 Ladder Diagram



2.1.16.29.8.3 Function Block Diagram

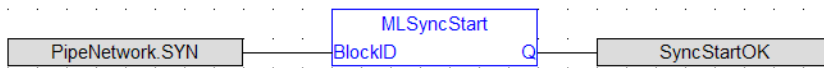

2.1.16.30 MLSyncStop Pipe Network ✓

2.1.16.31.1 Description

De-synchronizes a synchronizer Pipe Block. Returns TRUE if the function succeeded.

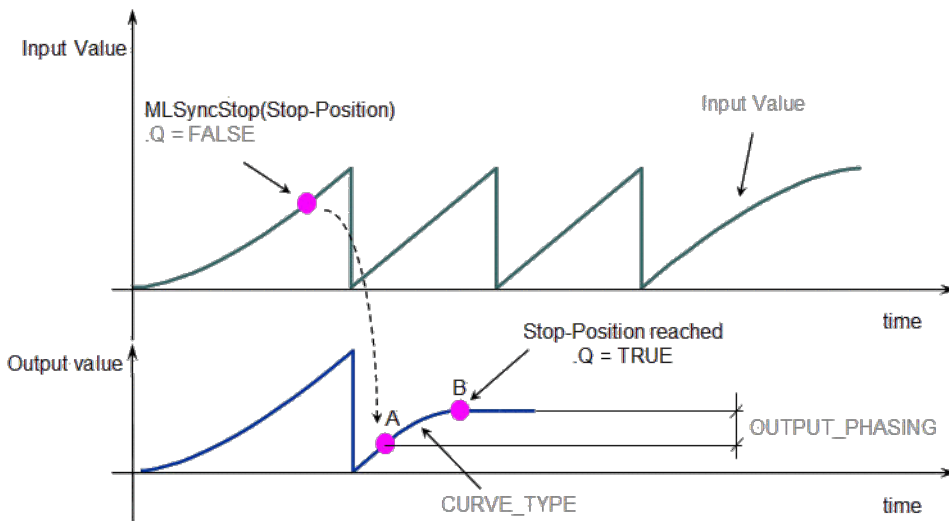

Figure 1-47: MLSyncStop

2.1.16.32.2 Arguments

2.1.16.33.3.1 Input

Position	Description
	Motion Stop Position

Data type	LREAL
Range	—
Unit	User unit
Default	—

2.1.16.34.4.2 Output

Default (.Q)	Description	Function Block Execute Successfully
	Data type	BOOL
	Unit	n/a

2.1.16.35.5 Example

2.1.16.36.6.1 Structured Text

```
MLSyncStop( PipeNetwork.SYN , 120 );
```

2.1.16.37.7.2 Ladder Diagram

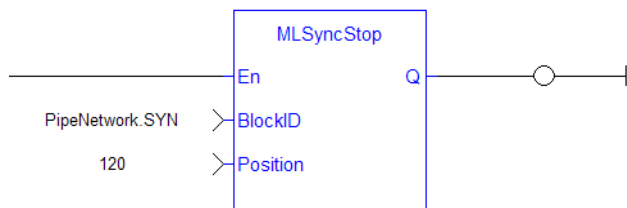

2.1.16.38.8.3 Function Block Diagram

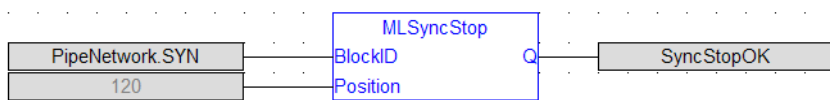

2.1.16.39 MLSyncWriteDeltaS

2.1.16.40.1 Description

Set the output phasing value of a synchronizer block. Returns TRUE if the function succeeded. Output phasing is the distance or the slope the output takes to synchronize with the input when MLSyncStart Block is executed. It also affects the distance or the slope the output takes to desynchronize with the input and come to a stop when MLSyncStop Block is executed.

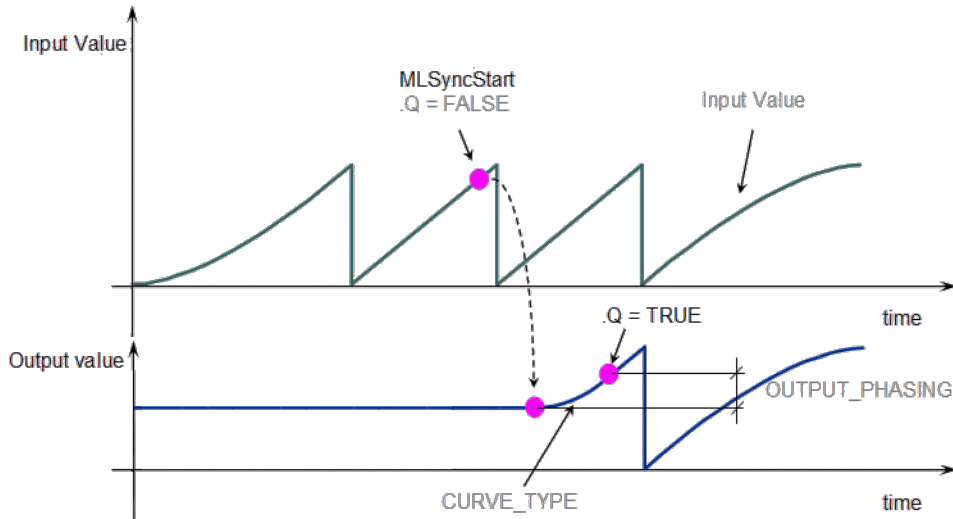

Figure 1-48: Set output phasing after MLSyncStart

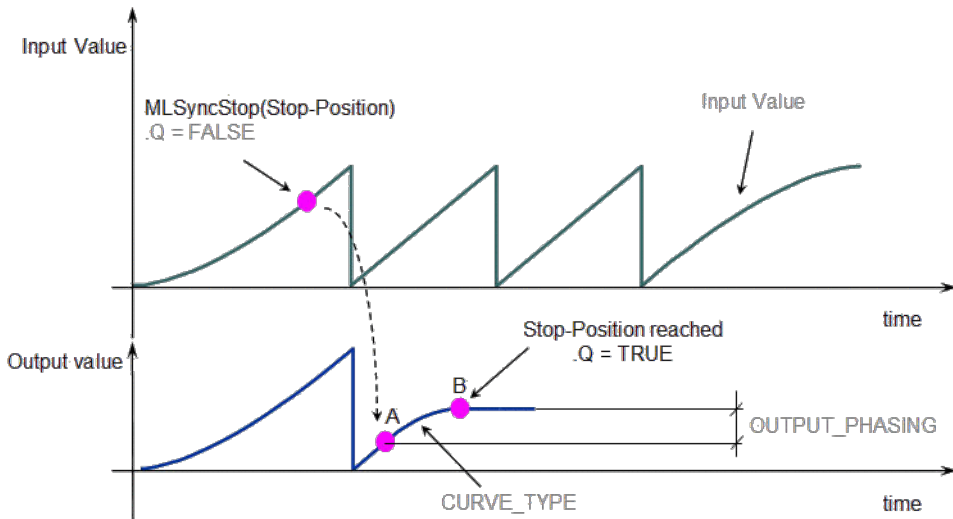

Figure 1-49: Set output phasing after MLSyncStop

2.1.16.41.2 Arguments

2.1.16.42.3.1 Input

B LockID	Description	Name of the Pipe Network Block
	Data type	DINT
	Range	[-2147483648, 2147483648]
	Unit	n/a
	Default	—
Delta S	Description	Slope to be used during Start and stop of Synchronization
	Data type	LREAL
	Range	—

Unit	User unit
Default	—

2.1.16.43.4.2 Output

Default (.Q)	Description	Function Block Execute Successfully
	Data type	BOOL
	Unit	n/a

2.1.16.44.5 Example

2.1.16.45.6.1 Structured Text

```
MLSyncWriteDeltaS( PipeNetwork.SYN, 45 );
```

2.1.16.46.7.2 Ladder Diagram

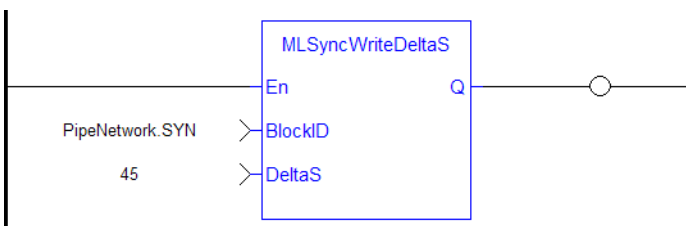

2.1.16.47.8.3 Function Block Diagram

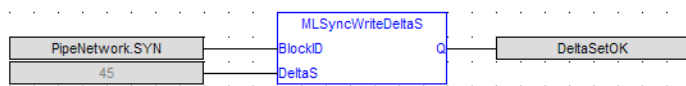

2.1.16.48 Usage example of Synchronizer Functions

When you call the **MLSyncStop** function, the output value is adapted according to the specified Stop-Position (point B).

The OUTPUT_PHASING parameter is used to define point A, where the flow follows a curve in order to smooth the output value.

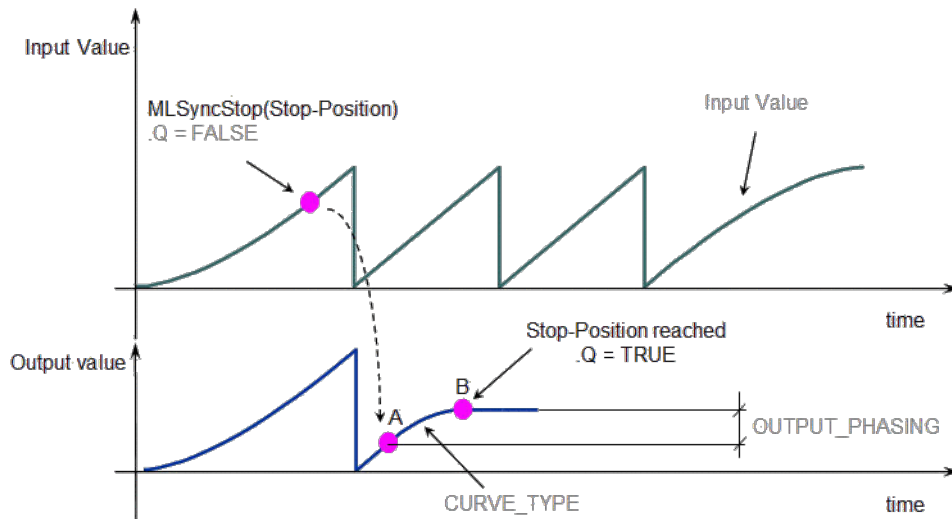

When you call the **MLSyncStart** function, the output value is adapted to catch up with the input value. The **OUTPUT_PHASING** parameter is also used to define a curve in order to smooth the output value.

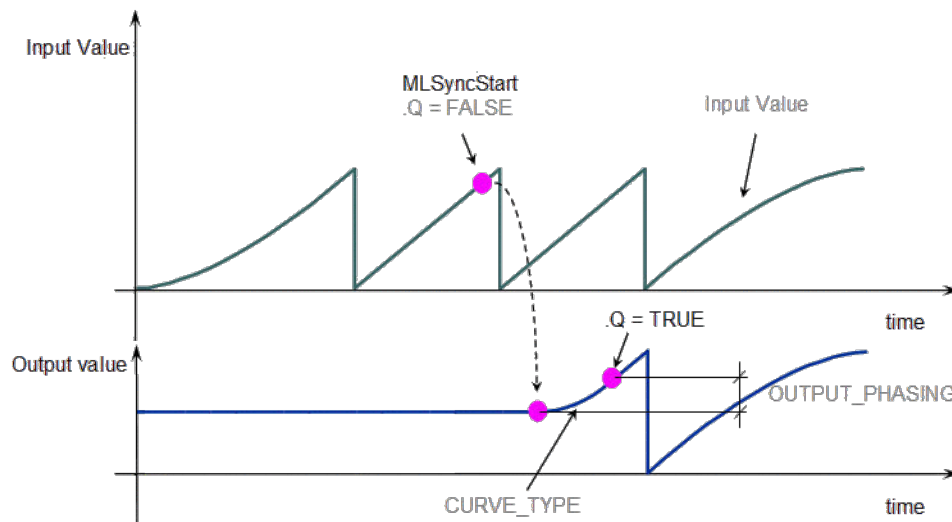

Figure 1-50: Synchronizer Functions Usage

2.1.17 Motion Library - Trigger

TIP

- For an example of Trigger functions, see "Usage example of Trigger Functions" (→ p. 322)

Name	Description	Return type
MLTrigClearFlag	Clears the flag of an initiated Trigger block	BOOL
MLTrigInit	Initializes a Trigger object	BOOL
MLTrigsTriggered	Checks if the selected block has been triggered	BOOL
MLTrigReadDelay	Returns the time that the trigger block uses to compensate the delay of the sensor that captures the triggering signal	None
MLTrigReadPos	Returns the position of the block at the moment when it was triggered	None
MLTrigReadTime	Returns the time of the moment where the block was triggered in milliseconds	None

Name	Description	Return type
"MLTrigSetEdge" (→ p. 320)	Sets the edge configuration for a Trigger object	BOOL
MLTrigWriteDelay	Sets the time that the trigger block uses to compensate for the delay introduced by the sensor that captures the triggering signal	BOOL

2.1.17.1 MLTrigClearFlag

2.1.17.2.1 Description

Clears the flag of an initiated Trigger block so the block can capture the position and time of the next event. Once triggered, a block has to be reset with this command before it can be triggered again. All events that are sent to a block while in a triggered state are ignored and the position and time information is lost.

IMPORTANT

The Fast Input assigned to a Trigger block has to be reset as well before information on a new event can be captured. MLAxisRstFastIn is generally used at the same time as MLTrigClearFlag

2.1.17.3.2 Arguments

2.1.17.4.3.1 Input

BlockID	Description	ID number of an initiated Trigger object
	Data type	DINT
	Range	[-2147483648, 2147483648]
	Unit	n/a
	Default	—

2.1.17.5.4.2 Output

Default (.Q)	Description	Returns TRUE if function block is executed
	Data type	BOOL
	Unit	n/a

2.1.17.6.5.3 Return Type

BOOL

2.1.17.7.6 Related Functions

[MLAxisRstFastIn](#)

[MLTrigsTriggered](#)

[MLTrigReadPos](#)

[MLTrigReadTime](#)

2.1.17.8 See Also

- Fast Inputs with Pipe Network Motion
- Fast Inputs with PLCOpen
- Fast Homing Example with the Pipe Network Motion Engine Axis Pipe Block

- Fast Homing Example with the PLCopen Motion Engine
- Pipe Network Registration and Fast Homing
- Registration Position Capture Example with Pipe Network Trigger Block

2.1.17.9.1 Example

2.1.17.10.2.1 Structured Text

```
//Clear Trigger Flag
MLTrigClearFlag( PipeNetwork.TRIGGER );
```

2.1.17.11.3.2 Ladder Diagram



2.1.17.12.4.3 Function Block Diagram



2.1.17.13 MLTrigInit Pipe Network ✓

2.1.17.14.1 Description

Initializes a Trigger object for use in a PLC Program. Function block is automatically called if a Trigger Block is added to the Pipe Network, with user-defined settings entered in the Pipe Blocks Properties screen.

The Trigger object monitors a selected Fast Input and captures the time of a rising or falling edge event. With the time and pipe position information the Trigger object extrapolates the axis position when the Fast Input event occurred.

Parameters to enter include the name of the Pipe Block, the Axis where the Fast Input is located, the number of the desired Fast Input, and whether to trigger on the rising or falling edge of the input.

NOTE

Trigger objects are normally created in the Pipe Network using the graphical engine. Then you do not have to add MLTrigInit function blocks to their programs. Parameters are entered directly in pop-up windows, and the code is then automatically added to the current project.

2.1.17.15.2 Arguments

2.1.17.16.3.1 Input

BlockID	Description	ID number of a created Pipe Block
	Data type	DINT
	Range	[-2147483648, 2147483648]
	Unit	n/a

	Default	—
Input_Axis	Description	Name of the axis where the Fast Input is located
	Data type	STRING
	Range	—
	Unit	n/a
	Default	—
InputID	Description	ID number of the Fast Input 0 = Capture Engine 0 1 = Capture Engine 1 Range is [0, 1] For information on configuring the capture engines, refer to AKD Capture Engine Configuration.
	Data type	DINT
	Range	[-2147483648, 2147483648]
	Unit	n/a
	Default	—
EdgeID	Description	Trigger at rising or falling edge of Fast Input. Enter 1 for rising edge, 2 for falling edge, and 0 disables the Fast Input
	Data type	DINT
	Range	[0, 2]
	Unit	n/a
	Default	1 (Rising edge)

2.1.17.17.4.2 Output

Default (.Q)	Description	Returns TRUE if function block is executed
	Data type	BOOL
	Unit	n/a

2.1.17.18.5.3 Return Type

BOOL

2.1.17.19.6 Related Functions

[MLTrigsTriggered](#)

[MLTrigReadPos](#)[MLTrigClearFlag](#)[MLAxisRstFastIn](#)

2.1.17.20 See Also

- Fast Inputs with Pipe Network Motion
- Fast Inputs with PLCOpen
- Fast Homing Example with the Pipe Network Motion Engine Axis Pipe Block
- Fast Homing Example with the PLCOpen Motion Engine
- Pipe Network Registration and Fast Homing
- Registration Position Capture Example with Pipe Network Trigger Block

2.1.17.21.1 Example

2.1.17.22.2.1 Structured Text

```
//Create and Initiate a Trigger Pipe Block named "Trigger" and
set it up to receive the trigger signal from Axis1, capture
engine 0, and the rising edge of the signal
TRIGGER := MlBlkCreate( 'TRIGGER', 'TRIGGER' );
MLTrigInit( TRIGGER, 'Axis1', 0, 1 );
```

2.1.17.23.3.2 Ladder Diagram

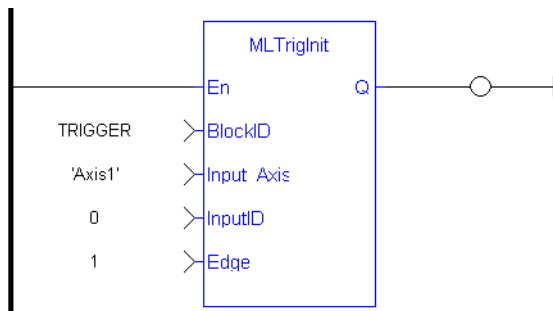

2.1.17.24.4.3 Function Block Diagram

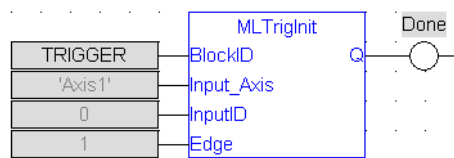

2.1.17.25 MLTrigsTriggered Pipe Network ✓

2.1.17.26.1 Description

Checks if the selected block has been triggered. When a block has been triggered, it contains the time and position when a Fast Input event occurred. The application has to reset the block before the block can be triggered again. All trigger events that are sent to the block during its triggered state are lost.

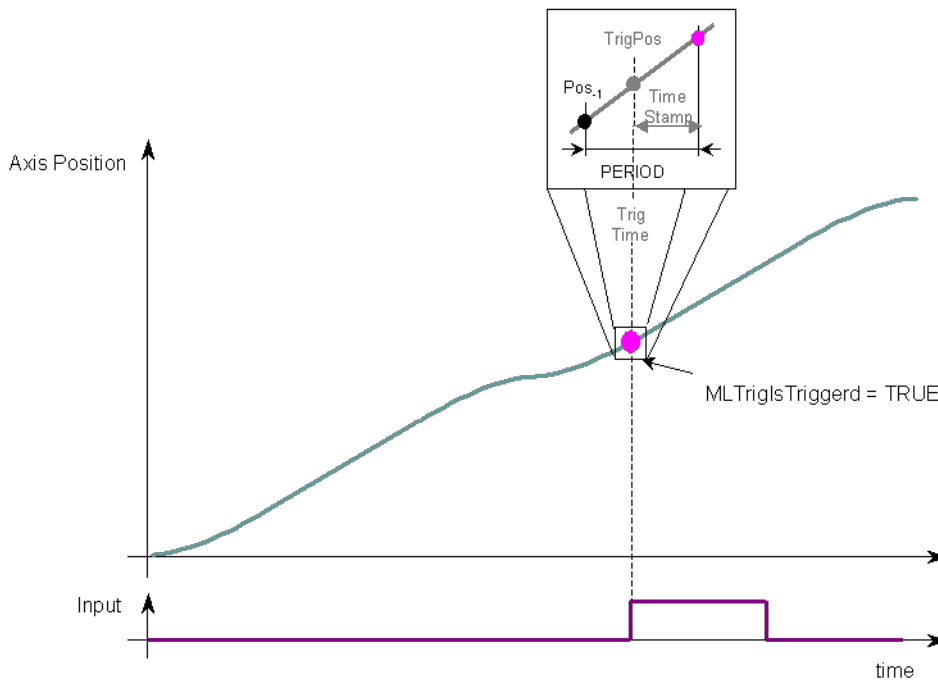

Figure 1-51: MLTrigsTriggered

NOTE

Once triggered, a block has to be reset before it can be triggered again. All events that are sent to a block while in a triggered state are ignored and the position and time information is lost.

2.1.17.27.2 Arguments

2.1.17.28.3.1 Input

BlockID	Description	ID number of an initiated Trigger object
	Data type	DINT
	Range	[-2147483648, 2147483648]
	Unit	n/a
	Default	—

2.1.17.29.4.2 Output

Default (.Q)	Description	Returns TRUE if the selected Trigger Object has Triggered
	Data type	BOOL
	Unit	n/a

2.1.17.30.5.3 Return Type

BOOL

2.1.17.31.6 Related Functions

[MLTrigReadPos](#)

[MLTrigReadTime](#)**2.1.17.32 See Also**

- Fast Inputs with Pipe Network Motion
- Fast Inputs with PLCOpen
- Fast Homing Example with the Pipe Network Motion Engine Axis Pipe Block
- Fast Homing Example with the PLCOpen Motion Engine
- Pipe Network Registration and Fast Homing
- Registration Position Capture Example with Pipe Network Trigger Block

2.1.17.33.1 Example

//Check if a Trigger Block has been triggered, then save position

IF MLTrigsTriggered(PipeNetwork.TRIGGER) THEN

Trig_Position := MLTrigReadPos(PipeNetwork.TRIGGER);

END_IF

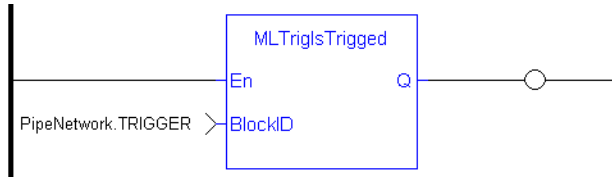
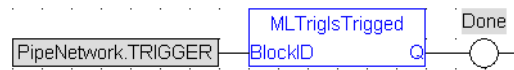
2.1.17.34.2.1 Ladder Diagram**2.1.17.35.3.2 Function Block Diagram****2.1.17.36 MLTrigReadDelay** Pipe Network ✓**2.1.17.37.1 Description**

Electronic sensors are not able to respond immediately to a signal. Sensors usually require a certain amount of time to process a change of state in their input signal. This function returns the delay that has been programmed in a trigger block by the [MLTrigWriteDelay](#) function to compensate for this reaction time required by the sensor.

2.1.17.38.2.1 Input

BlockID	Description	Identifier of the trigger block whose delay is requested
	Data type	DINT
	Range	[-2147483648, 2147483648]
	Unit	n/a
	Default	—
En	Description	Enables execution

Data type	BOOL
Unit	n/a
Default	-

2.1.17.39.3.2 Output

Delay	Description	Value of the delay compensation currently applied by the trigger block
	Data type	LREAL
	Unit	microseconds
OK	Description	Returns true when the function successfully executes
	Data type	BOOL
	Unit	n/a

2.1.17.40.4 Related Functions

[MLTrigWriteDelay](#)

2.1.17.41 See Also

- Fast Inputs with Pipe Network Motion
- Fast Inputs with PLCOpen
- Fast Homing Example with the Pipe Network Motion Engine Axis Pipe Block
- Fast Homing Example with the PLCOpen Motion Engine
- Pipe Network Registration and Fast Homing
- Registration Position Capture Example with Pipe Network Trigger Block

2.1.17.42 MLTrigReadPos Pipe Network ✓

2.1.17.43.1 Description

Returns the position of the block at the moment when it was triggered by the Trigger Block's selected Fast Input. This value is only valid when TrigsTriggered() returns TRUE. The Trigger block extrapolates the output value based on the timestamp of the Fast Input event to provide an accurate position even if the event occurs in the middle of a program cycle.

Once triggered, a block has to be reset before it can be triggered again. All events that are sent to a block while in a triggered state are ignored and the position and time information is lost.

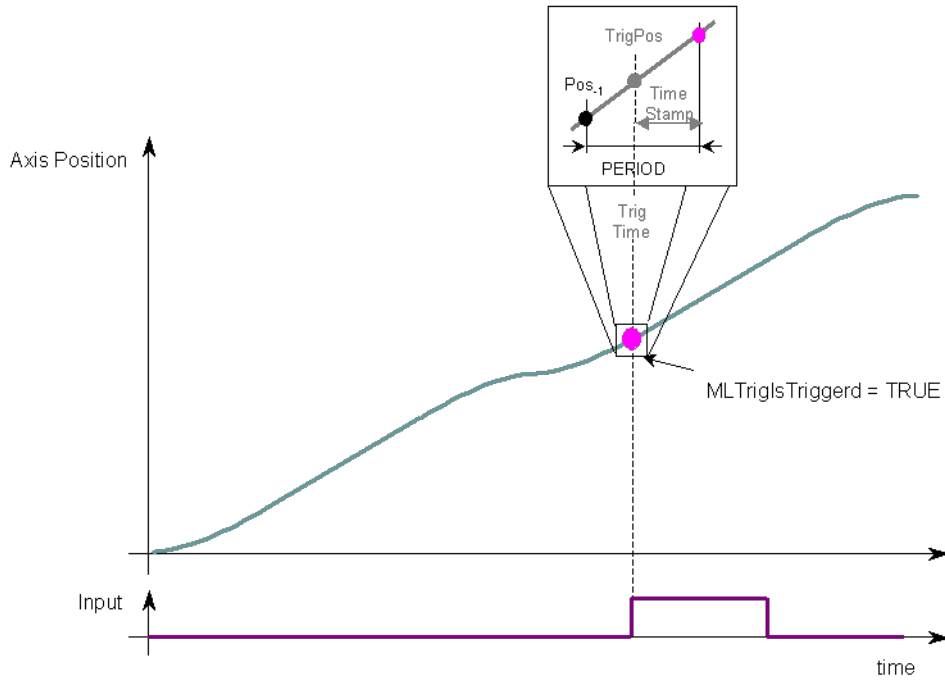

Figure 1-52: MLTrigReadPos

2.1.17.44.2 Arguments

2.1.17.45.3.1 Input

BlockID	Description	ID number of an initiated Trigger object
	Data type	DINT
	Range	[-2147483648, 2147483648]
	Unit	n/a
	Default	—

2.1.17.46.4.2 Output

Position	Description	Returns the position of the selected block's Axis at the moment when it was triggered
	Data type	LREAL
	Unit	User unit

2.1.17.47.5 Related Functions

- [MLTrigsTriggered](#)
- [MLTrigReadTime](#)
- [MLTrigClearFlag](#)
- [MLAxisRstFastIn](#)

2.1.17.48 See Also

- Fast Inputs with Pipe Network Motion
- Fast Inputs with PLCOpen
- Fast Homing Example with the Pipe Network Motion Engine Axis Pipe Block
- Fast Homing Example with the PLCOpen Motion Engine
- Pipe Network Registration and Fast Homing
- Registration Position Capture Example with Pipe Network Trigger Block

2.1.17.49.1 Previous Function Name

MLTrigGetPos

2.1.17.50.2 Example

2.1.17.51.3.1 Structured Text

```
//Save position of Axis when Fast Input event occurs
Trig_Position := MLTrigReadPos( PipeNetwork.TRIGGER );
```

2.1.17.52.4.2 Ladder Diagram

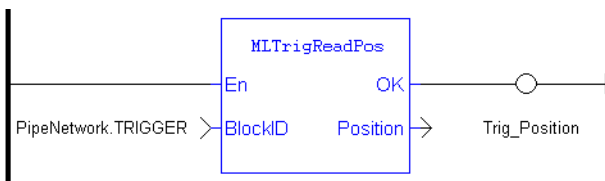

2.1.17.53.5.3 Function Block Diagram

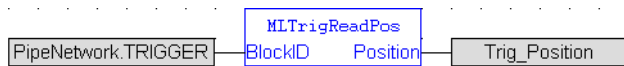

2.1.17.54 MLTrigReadTime Pipe Network ✓

2.1.17.55.1 Description

Returns the time of the moment where the block was triggered in milliseconds. This value is only valid when TrigsTriggered() returns TRUE. The output is computed from the timestamp of a Fast Input time event

Once triggered, a block has to be reset before it can be triggered again. All events that are sent to a block while in a triggered state are ignored and the position and time information is lost.

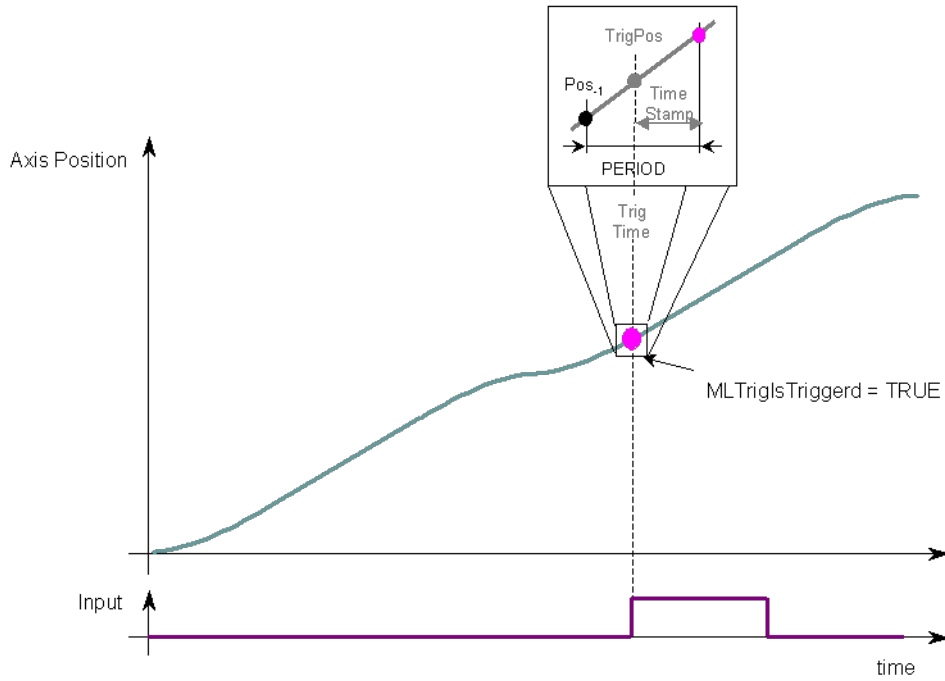

Figure 1-53: MLTrigReadTime

2.1.17.56.2 Arguments

2.1.17.57.3.1 Input

BlockID	Description	ID number of an initiated Trigger object
	Data type	DINT
	Range	[-2147483648, 2147483648]
	Unit	n/a
	Default	—

2.1.17.58.4.2 Output

Time	Description	Returns the time that the Trigger Block's selected Fast Input was triggered
	Data type	LREAL
	Unit	milliseconds

2.1.17.59.5 Related Functions

[MLTrigsTriggerd](#)

[MLTrigReadPos](#)

[MLTrigClearFlag](#)

[MLAxisRstFastIn](#)

2.1.17.60 See Also

- Fast Inputs with Pipe Network Motion
- Fast Inputs with PLCOpen
- Fast Homing Example with the Pipe Network Motion Engine Axis Pipe Block
- Fast Homing Example with the PLCopen Motion Engine
- Pipe Network Registration and Fast Homing
- Registration Position Capture Example with Pipe Network Trigger Block

2.1.17.61.1 Previous Function Name

MLTrigGetTime

2.1.17.62.2 Example

//Save time when Fast Input event occurs

```
Trig_Time := MLTrigReadTime(PipeNetwork.TRIGGER);
```

2.1.17.63.3.1 Ladder Diagram

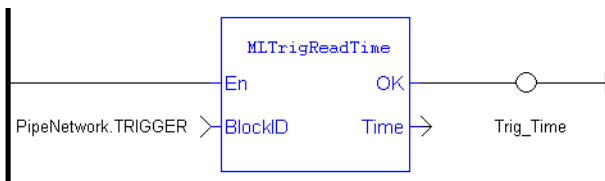

2.1.17.64.4.2 Function Block Diagram



2.1.17.65 MLTrigSetEdge Pipe Network ✓

2.1.17.66.1 Description

Sets the edge configuration (rising, falling, etc.) for a trigger block. This block should be called prior to calling "MLAxisCfgFastIn" (→ p. 120). Also the value at the Edge input must match the value at MLAxisCfgFastIn's Mode input.

2.1.17.67.2 Arguments

2.1.17.68.3.1 Input

BlockID	Description	Identifier of the trigger block
	Data type	DINT
	Range	[-2147483648, 2147483647]
	Unit	n/a
	Default	—
Edge	Description	The edge on which to trigger 0 = disable the fast input 1 = rising edge 2 = falling edge
	Data type	DINT

Range	[0,2]
Unit	n/a
Default	1 (rising edge)

2.1.17.69.4.2 Output

Q	Description	True if block executed successfully False if execution is not successful
	Data type	BOOL
	Unit	n/a

2.1.17.70.5.3 Return Type

BOOL

2.1.17.71 See Also

- Fast Inputs with Pipe Network Motion
- Fast Inputs with PLCOpen
- Fast Homing Example with the Pipe Network Motion Engine Axis Pipe Block
- Fast Homing Example with the PLCOpen Motion Engine
- Pipe Network Registration and Fast Homing
- Registration Position Capture Example with Pipe Network Trigger Block

2.1.17.72.1 Examples

2.1.17.73.2.1 Function Block Diagram

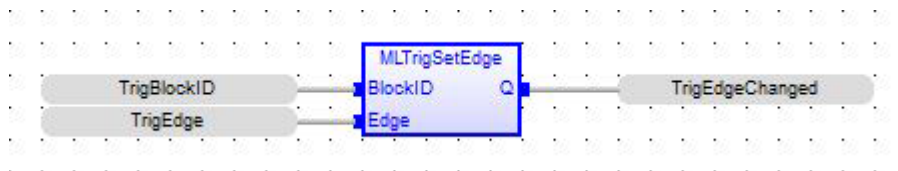

2.1.17.74.3.2 Ladder Diagram

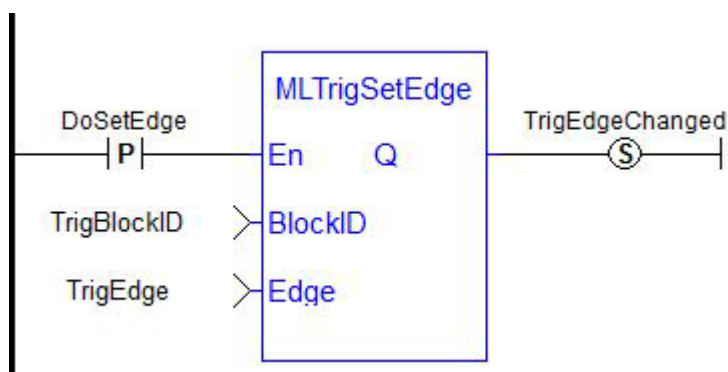

2.1.17.75.4.3 Structured Text

```
TrigEdgeChanged := MLTrigSetEdge (TrigBlockID, TrigEdge);
```

2.1.17.76 MLTrigWriteDelay Pipe Network ✓

2.1.17.77.1 Description

Electronic sensors are not able to respond immediately to a signal. Sensors usually require a certain amount of time to process a change of state in their input signal. This function allows the trigger block to calculate the exact moment at which a signal was triggered by letting you specify the delay introduced by the sensor.

2.1.17.78.2.1 Input

BlockID	Description	Identifier of the trigger block
	Data type	DINT
	Range	[-2147483648, 2147483648]
	Unit	n/a
	Default	—
Delay	Description	Reaction time of the sensor that the trigger block has to compensate
	Data type	LREAL
	Range	—
	Unit	microseconds
	Default	—

2.1.17.79.3.2 Output

Default (.Q)	Description	Returns TRUE if the delay is successfully set
	Data type	BOOL
	Unit	n/a

2.1.17.80.4.3 Return Type

BOOL

2.1.17.81.5 Related Functions

[MLTrigReadDelay](#)

2.1.17.82 See Also

- Fast Inputs with Pipe Network Motion
- Fast Inputs with PLCOpen
- Fast Homing Example with the Pipe Network Motion Engine Axis Pipe Block
- Fast Homing Example with the PLCOpen Motion Engine
- Pipe Network Registration and Fast Homing
- Registration Position Capture Example with Pipe Network Trigger Block

2.1.17.83 Usage example of Trigger Functions

When you call the **MLTrigClearFlag** function, the flag for trigger is reset to False.

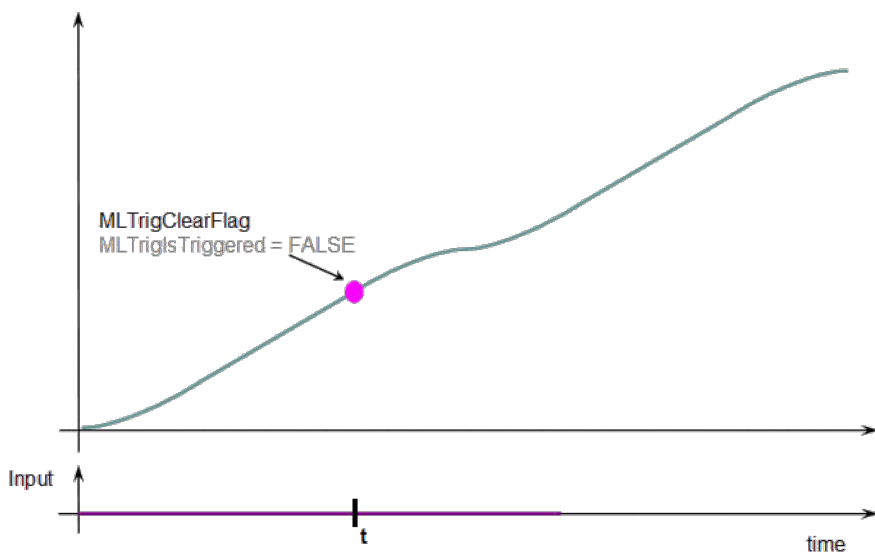

When a Fast Input is set, the **MLTrigsTriggered** function returns True.

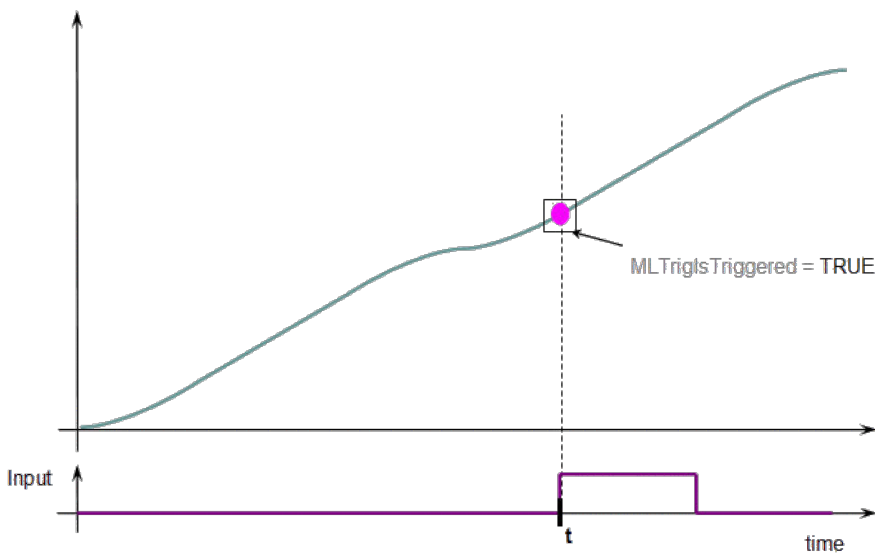

Then you can call the **MLTrigReadPos** and **MLTrigReadTime** functions to get more details.

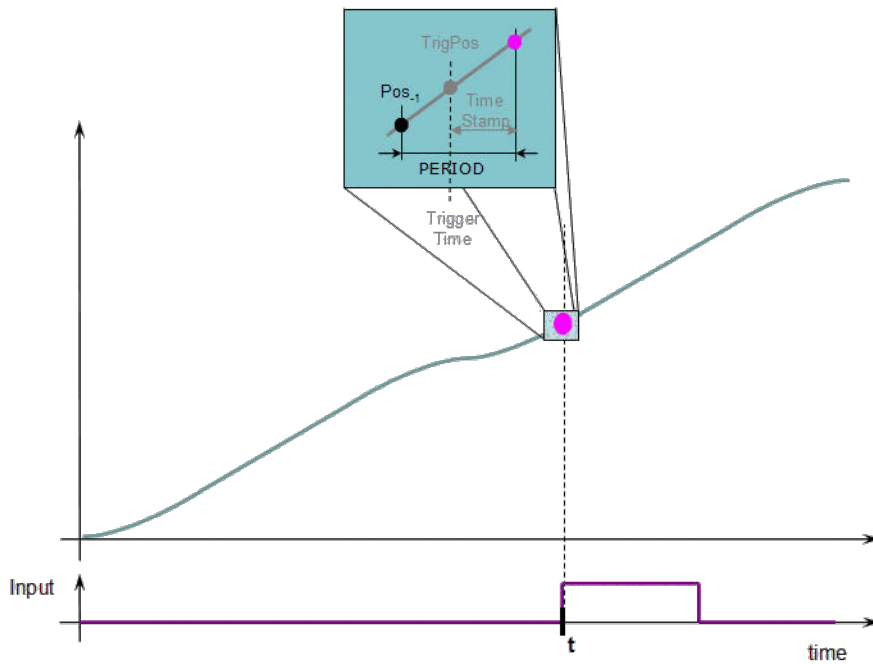

Figure 1-54: Trigger Functions Usage

! IMPORTANT

The trigger delay has to be calculated by **you** and set with the [MLTrigWriteDelay](#) function block. This delay belongs to the sensor and it is additional to the [MLTrigReadTime](#) / [MLTrigReadPos](#).

2.2 Motion Library / PLCopen

Functions sorted in alphabetical order:

Name	Description
MC_AbortTrigger	Abort MC_TouchProbe
"MC_AddSuperAxis" (→ p. 449)	Add an axis to the axis's list of assigned, superimposed axes.
MC_CamIn	Performs a slave axis move based on the Cam Table
MC_CamOut	Disengages the slave axis from a MC_CamIn move
"MC_CamResumePos" (→ p. 400)	Returns the slave axis position for resuming an MC_CamIn move
"MC_CamStartPos" (→ p. 402)	Returns the slave axis position for starting an MC_CamIn move
MC_CamTblSelect	Defined to read and initialize the specified profile
MC_ClearFaults	Clear Drive Faults
MC_CreateAxis	Creates a PLCopen Axis
MC_EStop	Performs a Emergency stop
"MC_ErrorDescription" (→ p. 453)	Converts the PLCopen error IDs into message strings.
MC_GearIn	Performs a slave axis move based on the ratio
MC_GearInPos	Performs a slave axis move based on the ratio
MC_GearOut	Disengages the slave axis from a MC_GearIn or MC_GearInPos move

Name	Description
MC_Halt	Decelerates an axis to zero velocity
MC_InitAxis	Initializes a PLCopen Servo Axis' data
MC_MachRegist	Runs Mark-to-Machine registration
MC_MarkRegist	Runs Mark-to-Mark registration
MC_MoveAbsolute	Performs a single-axis move to a specified endpoint position
MC_MoveAdditive	Performs a single-axis move for a specified distance from the endpoint of the previous move
"MC_MoveRelative" (→ p. 376)	Performs a single-axis move for a specified distance
MC_MoveSuperimp	Performs a single-axis move which is superimposed upon the active move
MC_MoveVelocity	Performs a single-axis non-ending move at a specified velocity
MC_Phasing	Performs a master position phase shift for the slave axis
MC_Power	Requests to enable the drive and close the loop, or disable the drive and open the loop
MC_ReadActPos	Reads the actual position of the axis
MC_ReadActVel	Reads the actual velocity of the axis
MC_ReadAxisErr	Returns the error status of the specified axis
MC_ReadBoolPar	Returns the value of the specified Boolean axis parameter
MC_ReadParam	Returns the value of the specified axis parameter
MC_ReadStatus	Returns the state of the specified axis
MC_Reference	Defines the position at the reference location for PLCopen Axis
"MC_RemSuperAxis" (→ p. 451)	Remove an axis from the axis's list of assigned, superimposed axes.
MC_ResetError	Resets the errors of the specified axis
MC_SetOverride	Writes velocity and acceleration override factors
MC_SetPosition	Deprecated by "MC_SetPos" (→ p. 432)
"MC_SetPos" (→ p. 432)	Sets a new axis position
MC_Stop	Aborts the active move, removes the next move from the queue, performs a controlled stop, and switches the axis to Stopping state
MC_StopRegist	Turns off registration for the specified axis
MC_SyncSlaves	Specifies synchronized slaves
MC_TouchProbe	Arm a Fast Input and capture an axis position
MC_WriteBoolPar	Writes the specified axis Boolean parameter
MC_WriteParam	Writes the specified axis parameter

2.2.1 Control Functions

This set of functions provide general controls to drives and axes.

2.2.1.1 MC_ClearFaults

2.2.1.2.1 Description

The MC_ClearFaults function sends a request to the drive to clear any drive faults that exists.

NOTE

The condition causing the drive fault has to be corrected before calling this function. If the fault condition still exists when this function is called, this function sends a request to the drive but the drive faults remain.

This function does **not** reset axis errors. [MC_ResetError](#) is required to reset axis errors.

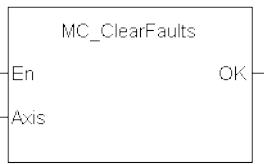

Figure 1-55: MC_ClearFaults

2.2.1.3.2 Arguments

2.2.1.4.3.1 Input

En	Description	Function enable – execute function. This Input must be on shot.
	Data type	BOOL
	Range	0, 1
	Unit	n/a
	Default	—
Axis	Description	AXIS_REF.AXIS_NUM is the master axis number
	Data type	AXIS_REF
	Range	[1,256]
	Unit	n/a
	Default	—

2.2.1.5.4.2 Output

OK	Description	Boolean output to indicate successful request. This output does not indicate that the fault are cleared, but simply indicates the request was made.
	Data type	BOOL

2.2.1.6.5 Usage

Upon the positive transition of the EN input, this function requests a Fault Reset of the Drive for the Axis defined in the axis input of this function.

2.2.1.7.6 Related Functions

[MC_ResetError](#)

2.2.1.8.7 Example

2.2.1.9.8.1 Structured Text

```
(* MC_ClearFaults ST example *)
MC_ClearFaults( Axis1); //clear drive faults for Axis 1
```

2.2.1.10.9.2 Function Block Diagram



2.2.1.11.10.3 Ladder Diagram

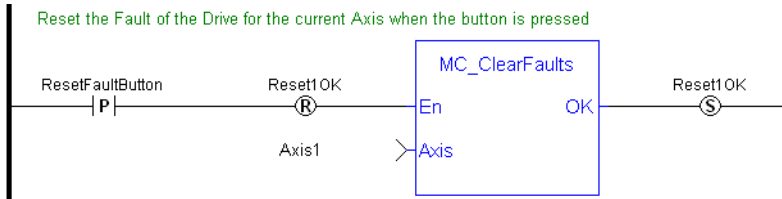

2.2.1.12 MC_CreateAxis PLCopen ✓

2.2.1.13.1 Description

This function creates a PLCopen Axis. A call to this function is automatically generated when the application is compiled, based on the data entered in the PLCopen Axis Data dialog.

ⓘ IMPORTANT

MC_CreateAxis must be called between "MLMotionInit" (→ p. 471) and "MLMotionStart" (→ p. 474).

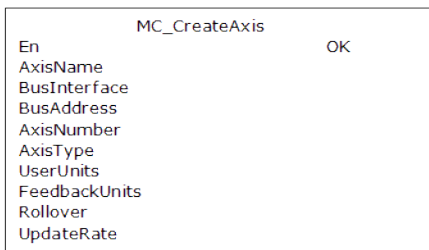

Figure 1-56: MC_CreateAxis

2.2.1.14.2 Arguments

2.2.1.15.3.1 Input

En	Description	Requests to create a PLCopen axis
	Data type	BOOL
	Range	0, 1
	Unit	n/a
	Default	—
AxisName	Description	Axis name

	Data type	STRING
	Range	—
	Unit	n/a
	Default	—
BusInterface	Description	Bus interface identifier: “EtherCATDriver” = EtherCAT interface “MSBusDriver” = KAS Simulator interface
	Data type	STRING
	Range	—
	Unit	n/a
	Default	—
BusAddress	Description	Address of the drive on the bus
	Data type	DINT
	Range	bus dependent
	Unit	n/a
	Default	—
AxisNumber	Description	Axis number
	Data type	UINT
	Range	[1,256]
	Unit	n/a
	Default	—
AxisType	Description	Axis type: 0 (MC_AXIS_TYPE_SERVO) denotes servo 1 (MC_AXIS_TYPE_DIGITIZING) denotes digitizing 2 (MC_AXIS_TYPE_VIRTUAL_SERVO) denotes virtual servo
	Data type	USINT
	Range	[0,1]
	Unit	n/a
	Default	—
UserUnits	Description	User unit portion of the user unit/feedback unit ratio
	Data type	DINT
	Range	[1,4294967296]

	Unit	User unit
	Default	—
FeedbackUnits	Description	Feedback unit portion of the user unit/feedback unit ratio
	Data type	DINT
	Range	[1,4294967296]
	Unit	feedback units. Note: <i>The FeedbackUnits input must be a power of 2. If input FeedbackUnits is not a power of two, the axis will not be created, and the OK output will be FALSE.</i>
	Default	—
Rollover	Description	Rollover position (0 = no rollover)
	Data type	LREAL
	Range	[0, 4294967296]
	Unit	User unit
	Default	—
UpdateRate	Description	Servo update rate (0, 1, and 2 are reserved for future enhancements) 3 = 125 µsec 4 = 250 µsec 5 = 500 µsec 6 = 1 msec 7 = 2 msec 8 = 4 msec 9 = 8 msec
	Data type	UINT
	Range	[3,9]
	Unit	n/a
	Default	—

2.2.1.16.4.2 Output

OK	Description	Indicates the axis has been created
	Data type	BOOL

2.2.1.17.5 Example

2.2.1.18.6.1 Structured Text

```
(* MC_CreateAxis ST Example *)
AxisName1      := 'PLCOpenAxis1';
BusName1       := 'EtherCATDriver';
```

```

BusAddress1      := 1001;
AxisNumber1     := 1;
AxisType1       := MC_AXIS_TYPE_SERVO;
UserUnits1      := 360;
FeedbackUnits1  := 1048576;
Rollover1       := 0;
UpdateRate1     := 3;
MC_CreateAxis(AxisName1, BusName1, BusAddress1, AxisNumber1,
AxisType1, UserUnits1, FeedbackUnits1, Rollover1, UpdateRate1);
    
```

2.2.1.19.7.2 Function Block Diagram

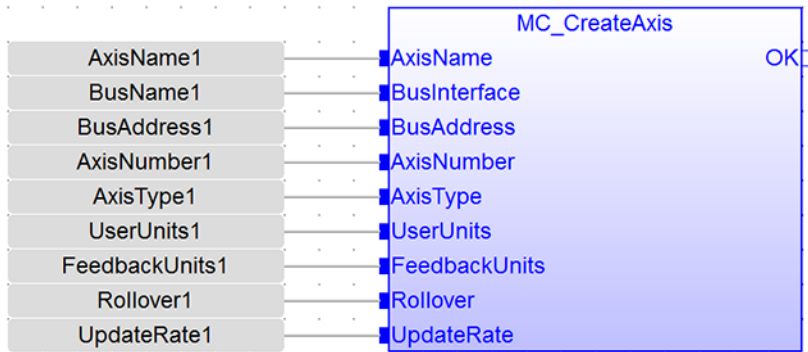

2.2.1.20.8.3 Ladder Diagram

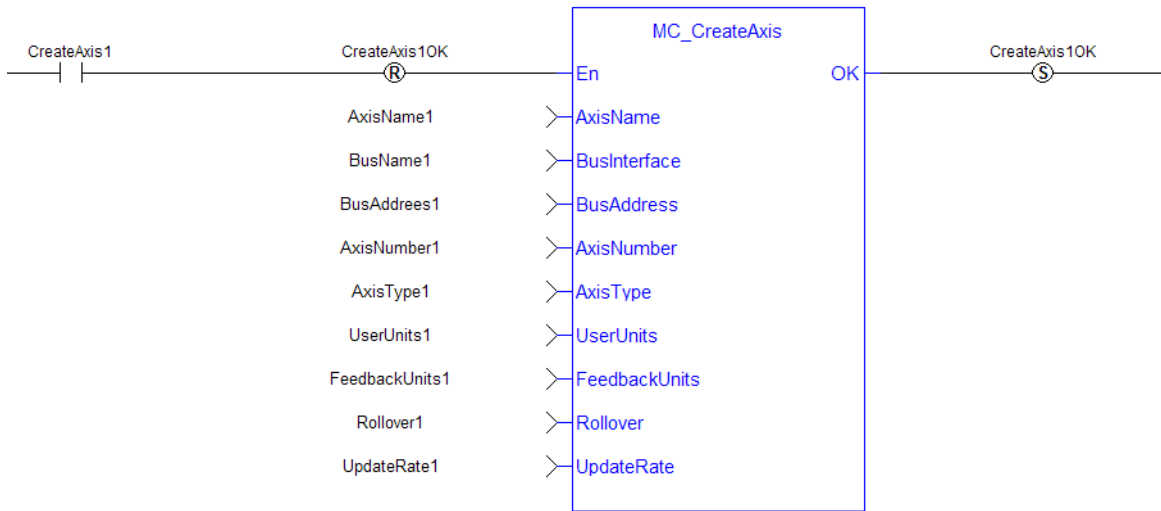

2.2.1.21 MC_EStop PLCopen

2.2.1.22.1 Description

This function causes an emergency stop (E-stop). An E-stop stops motion interpolation, clear all moves from the queue (active and next), change the axis state to [ErrorStop](#), and request the drive to open the position loop and disable the drive. The E-stop remains in effect until the application calls [MC_ResetError](#) to reset the E-stop.



Figure 1-57: MC_EStop

2.2.1.23.2 Arguments

2.2.1.24.3.1 Input

En	Description	A positive transition of this input causes an E-stop on the specified axis
	Data type	BOOL
	Range	0, 1
	Unit	n/a
	Default	—
Axis	Description	Axis identifier
	Data type	AXIS_REF
	Range	1-256 The AXIS_NUM element of the AXIS_REF structure must be in the range [1-256]
	Unit	n/a
	Default	—

2.2.1.25.4.2 Output

OK	Description	Indicates the E-stop was executed. If an invalid Axis input was specified, this output is not energized and no E-stop is performed.
	Data type	BOOL

2.2.1.26.5 Usage

Call MC_EStop to generate an emergency stop for an axis.

Call "MC_ResetError" (→ p. 339) to reset the emergency stop.

2.2.1.27.6 Related Functions

"MC_ResetError" (→ p. 339)

2.2.1.28.7 Example**2.2.1.29.8.1 Structured Text**

```
(* MC_EStop ST example *)
ON EStopButton DO
MC_EStop( Axis1 );
MC_EStop( Axis2 );
END_DO;
```

2.2.1.30.9.2 Function Block Diagram

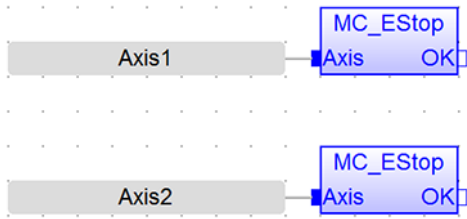

2.2.1.31.10.3 Ladder Diagram

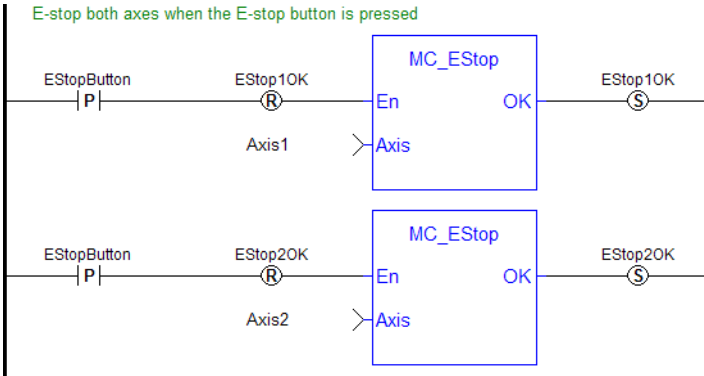

2.2.1.32 MC_InitAxis PLCopen ✓

2.2.1.33.1 Description

MC_InitAxis initializes a PLCopen Servo Axis' data. A call to this function is automatically generated when the application is compiled, based on the data entered in the PLCopen Axis Data dialog.

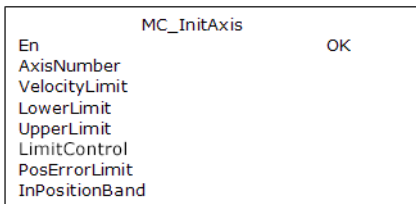

Figure 1-58: MC_InitAxis

2.2.1.34.2 Arguments

2.2.1.35.3.1 Input

En	Description	Request to initialize a PLCopen servo axis
	Data type	BOOL
	Range	0, 1
	Unit	n/a
	Default	—
AxisNumber	Description	Servo axis number
	Data type	UINT

	Range	[1,256]
	Unit	none
	Default	—
VelocityLimit	Description	Velocity limit
	Data type	LREAL
	Range	—
	Unit	User unit/sec
	Default	—
LowerLimit	Description	Lower position limit
	Data type	LREAL
	Range	—
	Unit	User unit
	Default	—
UpperLimit	Description	Upper position limit
	Data type	LREAL
	Range	—
	Unit	User unit
	Default	—
LimitControl	Description	Establishes how position limits are applied 0 = apply position limits 1 = ignore position limits 2 = ignore limits until referenced
	Data type	UINT
	Range	[0,2]
	Unit	n/a
	Default	—
PosErrorLimit	Description	Position error limit – when the Position Error (command position – actual position) exceeds this value, an E-stop is generated
	Data type	LREAL
	Range	—
	Unit	User unit

	Default	—
InPositionBand	Description	In-position bandwidth – when the axis actual position is within this distance from its programmed endpoint, the axis is considered “in position”
	Data type	LREAL
	Range	—
	Unit	User unit
	Default	—

2.2.1.36.4.2 Output

OK	Description	Indicates the initialization is complete
	Data type	BOOL

2.2.1.37.5 Example

2.2.1.38.6.1 Structured Text

```
(* MC_InitAxis ST example *)
AxisNumber1      := 1;
VelocityLimit1   := 10000; (*User unit/second*)
LowerPosLimit1   := 0;
UpperPosLimit1   := 0;
LimitControl1    := 0; (* Ignore lower and upper pos limit*)
PosErrorLimit1   := 10; (*User unit*)
InPosBand1       := 0;
MC_InitAxis(AxisNumber1, VelocityLimit1, LowerPosLimit1,
UpperPosLimit1, LimitControl1, PosErrorLimit1, InPosBand1);
```

2.2.1.39.7.2 Function Block Diagram

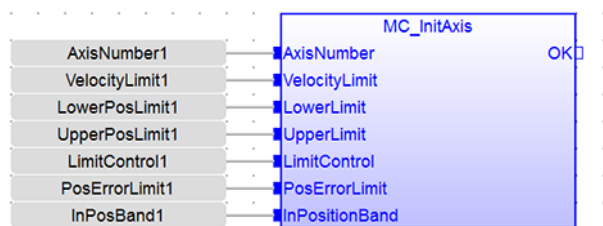

2.2.1.40.8.3 Ladder Diagram

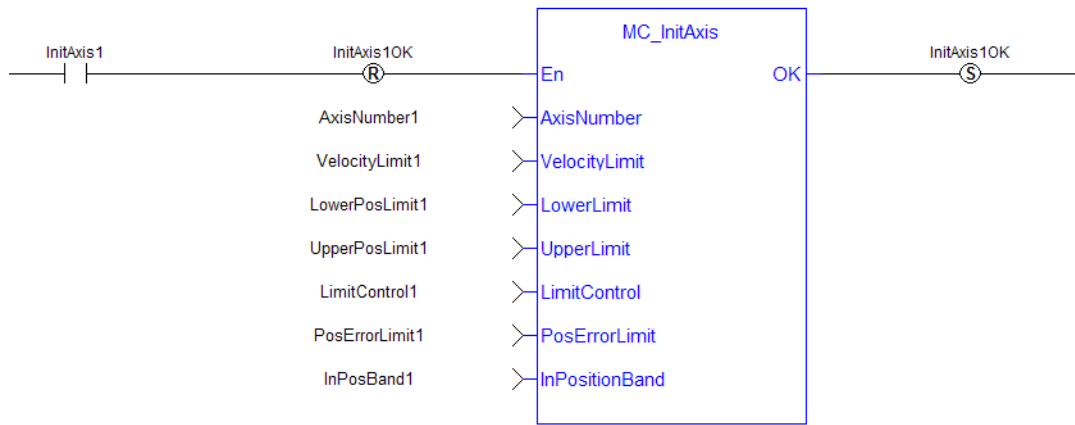

2.2.1.41 MC_Power PLCopen ✓

2.2.1.42.1 Description

This function block requests to enable the drive and close the position loop, or disable the drive and open the position loop. The Status output indicates the state of the position loop. If the position loop is open, the axis command position is set to the actual position of the axis and tracks the actual position.

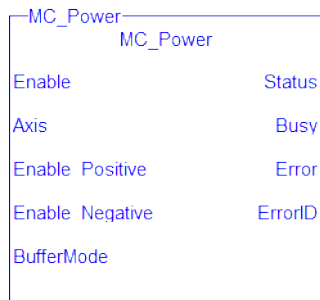

Figure 1-59: MC_Power

NOTE

You must be careful if you have more than one instance of MC_Power FB for the same drive, scanned in the same cycle. The problem arises when one instance requests the drive to enable and the other requests the same drive to disable. To avoid this trap, it is recommended to have only one instance of MC_Power for all of your active programs.

2.2.1.43.2 Arguments

2.2.1.44.3.1 Input

Enable	Description	When this transitions go to high, the control closes the servo loop and sends a command to the drive to enable . When this transitions go to low, the control opens the servo loop and sends a command to the drive to disable .
	Data type	BOOL
	Range	0, 1
	Unit	n/a

	Default	—
Axis	Description	Name of a declared instance of the AXIS_REF library function.
	Data type	AXIS_REF
	Range	[1,256]
	Unit	n/a
	Default	—
Enable Positive	Description	<i>for future enhancement</i>
	Data type	BOOL
	Range	0, 1
	Unit	n/a
	Default	—
Enable Negative	Description	<i>for future enhancement</i>
	Data type	BOOL
	Range	0, 1
	Unit	n/a
	Default	—
BufferMode	Description	Unused
	Data type	SINT
	Range	[0]
	Unit	n/a
	Default	—

2.2.1.45.4.2 Output

Status	Description	Indicates the enabled/disabled state of the drive
	Data type	BOOL
Busy	Description	for future enhancement – always false
	Data type	BOOL
Error	Description	Indicates an invalid input was specified
	Data type	BOOL
ErrorID	Description	Indicates the error if Error output is set to TRUE

Data type INT

2.2.1.46.5 Example

2.2.1.47.6.1 Structured Text

```
(* MC_Power ST example *)
Inst_MC_Power( CloseLoopReq, Axis1, TRUE, TRUE, 0 );
//Inst_MC_Power is an instance of MC_Power function block
DriveIsOn := Inst_MC_Power.Status; //store the Status output
into a user defined variable
```

2.2.1.48.7.2 Ladder Diagram

Close the servo loop and enable the drive when CloseLoop is high.
Open the servo loop and disable the drive when CloseLoop is low.

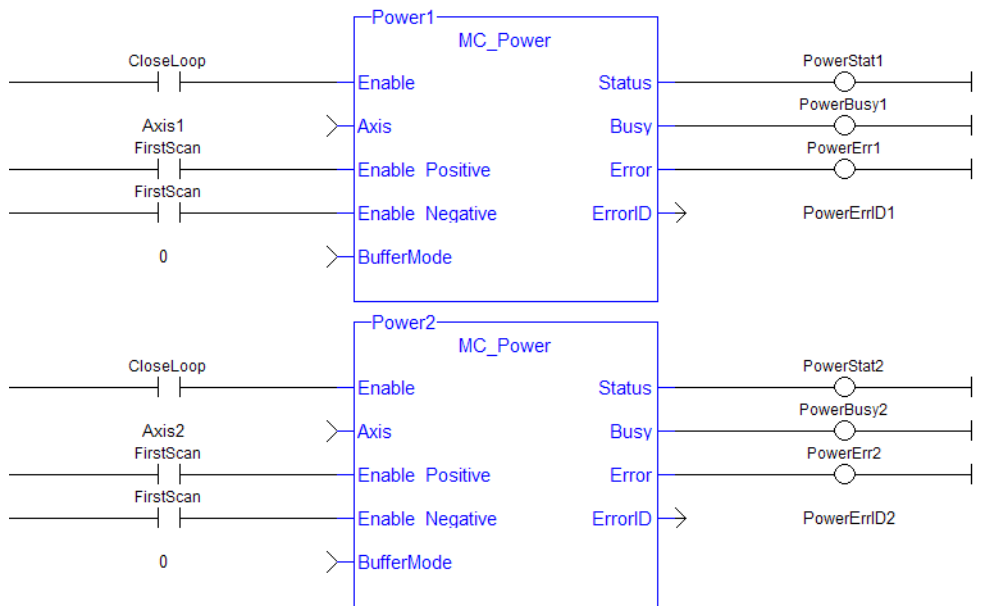

2.2.1.49 MC_ErrorDescription PLCopen ✓ Pipe Network ✓

This function converts the PLCopen error IDs into message strings which can be used for display or logging.

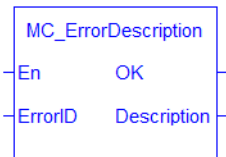

Figure 1-60: MC_ErrorDescription Function Block

2.2.1.50.1 Arguments

2.2.1.51.2.1 Inputs

En	Description	If True, then this function will convert the Error Id into a string message
	Data type	BOOL
	Range	0, 1
	Unit	n/a
	Default	—
ErrorID	Description	Error ID generated from a PLCopen Function Block. See PLCopen Function Block ErrorID Output for output details.
	Data type	INT
	Range	0,69
	Unit	n/a
	Default	—

2.2.1.52.3.2 Outputs

OK	Description	If True, then the command completed successfully.
	Data type	BOOL
	Range	0, 1
	Unit	n/a
	Default	—
Description	Description	String error description
	Data type	STRING
	Range	—
	Unit	n/a
	Default	—

2.2.1.53.4 Examples

2.2.1.54.5.1 Structured Text

```
Description := MC_ErrorDescription(ErrorID);
```

2.2.1.55.6.2 IL

Not applicable

2.2.1.56.7.3 Function Block



2.2.1.57.8.4 Ladder Diagram

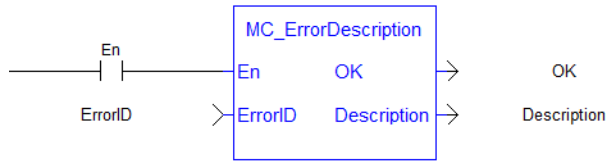

2.2.1.58 MC_ResetError PLCopen ✔

2.2.1.59.1 Description

The function MC_ResetError resets the errors of a specified axis.

This function performs in sequence the following tasks:

- It sends a request to the drive to clear any drive faults that exists
- Then it resets the axis errors

NOTE

The condition causing the axis error has to be corrected before calling this function. The axis error still remains until the error condition exists when this function is called.

See also transition 15 in the status machine of the CANopen protocol.

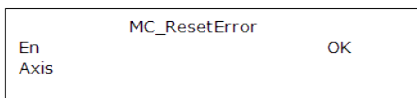

Figure 1-61: MC_ResetError

2.2.1.60.2 Arguments

2.2.1.61.3.1 Input

En	Description	Requests to reset the axis errors
	Data type	BOOL
	Range	0, 1
	Unit	n/a
	Default	—
Axis	Description	Name of a declared instance of the AXIS_REF library function)
	Data type	AXIS_REF
	Range	[1,256]
	Unit	n/a
	Default	—

2.2.1.62.4.2 Output

OK	Description	Indicates the function has completed successfully
-----------	--------------------	---

Data type BOOL

2.2.1.63.5 Example

2.2.1.64.6.1 Structured Text

```
//reset the axis and drive errors for Axis 1
MC_ResetError( Axis1 );
```

2.2.1.65.7.2 Ladder Diagram

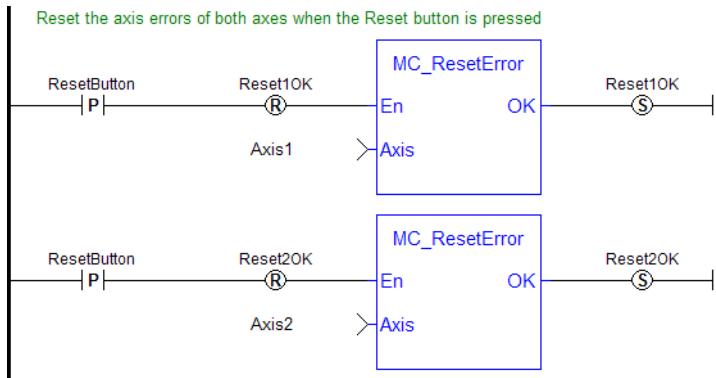

2.2.1.66 MC_Stop PLCopen ✔

2.2.1.67.1 Description

This function block aborts the active move, removes the next move from the queue, performs a controlled stop at the specified deceleration rate, and switches the axis to Stopping state.

MC_Stop cannot be aborted. This means that, while in Stopping state, no function block can command any motion on the axis. The axis remains in Stopping state until it reaches zero velocity and the Execute input is low. The application program can hold the axis in Stopping state even after it reaches zero velocity by leaving the Execute input high.

	MC_Stop	
Execute		Done
Axis		Busy
Deceleration		Active
Jerk		Error
		ErrorID

Figure 1-62: MC_Stop

2.2.1.68.2 Time Diagram

The example below shows the behavior of the combination of a MC_Stop FB with a [MC_MoveVelocity](#) FB.

- A rotating axis is ramped down with FB2 MC_Stop
- The axis rejects motion commands as long as MC_Stop parameter “Execute” = TRUE

FB1 MC_MoveVelocity reports an error indicating the busy MC_Stop command.

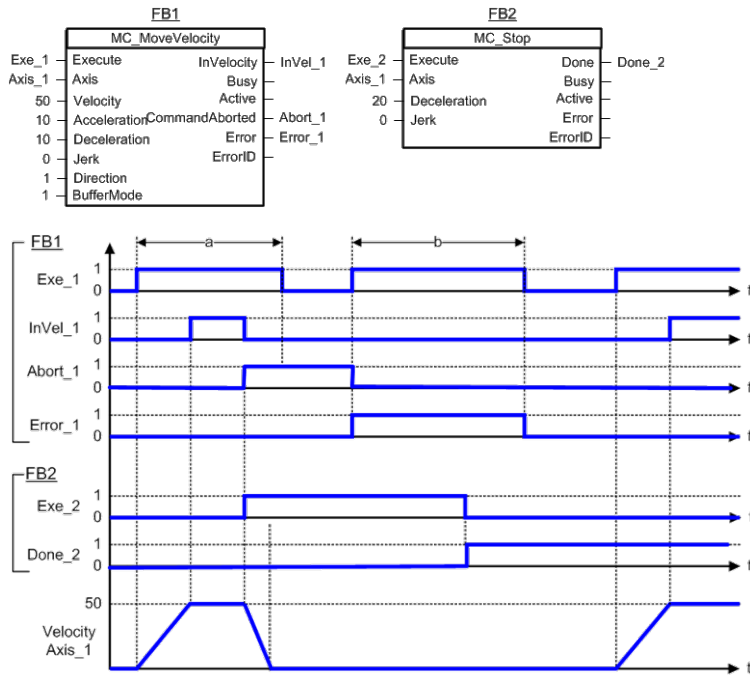

2.2.1.69.3 Arguments

2.2.1.70.4.1 Input

Execute	Description	Requests to stop the axis. It can be held high to prevent any other moves from being queued
	Data type	BOOL
	Range	0, 1
	Unit	n/a
	Default	—
Axis	Description	Name of a declared instance of the AXIS_REF library function.
	Data type	AXIS_REF
	Range	[1,256]
	Unit	n/a
	Default	—
Deceleration	Description	Trapezoidal: Deceleration rate S-curve: Maximum deceleration
	Data type	LREAL
	Range	—
	Unit	User unit/sec ²
	Default	—

Jerk	Description	Trapezoidal: 0 S-curve: Constant jerk
	Data type	LREAL
	Range	—
	Unit	User unit/sec ³
	Default	—

2.2.1.71.5.2 Output

Done	Description	Indicates the axis has reached zero velocity AND the Execute input is low
	Data type	BOOL
Busy	Description	High from the time the Execute input goes high until the axis reaches zero velocity AND the Execute input is low
	Data type	BOOL
Active	Description	High from the time the MC_Stop move becomes the active move, until the axis reaches zero velocity AND the Execute input is low
	Data type	BOOL
Error	Description	Indicates an invalid input was specified
	Data type	BOOL
ErrorID	Description	Indicates the error if Error output is set to TRUE
	Data type	INT

2.2.1.72.6 Example

2.2.1.73.7.1 Structured Text

```
(* MC_Stop ST example *)

Inst_MC_Stop( StopRequest , Axis1, 100.0, 100.0 ); //Inst_MC_Stop
is an instance of MC_Stop function block

StopComplete := Inst_MC_Stop.Done;           //store the Done output
into a user defined variable

StopActive := Inst_MC_Stop.Active;           //store the Active output
into a user defined variable

StopError := Inst_MC_Stop.Error;             //store the Error output
into a user defined variable
```

2.2.1.74.8.2 Ladder Diagram

Put Axis 1 into Stopping Mode



2.2.2 I/O Functions

This set of functions provides I/O control over TouchProbe functions.

2.2.2.1 MC_AbortTrigger PLCopen

2.2.2.2.1 Description

When the Execute input transitions from low to high, this function block aborts an MC_TouchProbe function block.

2.2.2.3.2 Arguments

2.2.2.4.3.1 Input

Execute	Description	Enables execution
	Data type	BOOL
	Range	0, 1
	Unit	n/a
	Default	—
Axis	Description	Specifies the axis that was specified in the MC_TouchProbe function block which is to be aborted
	Data type	AXIS_REF
	Range	[1,256]
	Unit	n/a
	Default	—

TriggerInput	Description	<p>Specifies the Fast Input that was specified in the MC_TouchProbe function block which is to be aborted. The elements of TriggerInput are as follows:</p> <p>InputID INT; 0 = Capture Engine 0 1 = Capture Engine 1 Range is [0,1] For information on configuring the capture engines, refer to AKD Capture Engine Configuration.</p> <p>Direction INT; 1 = rising edge, 2 = falling edge Range is [1,2]</p> <p>TrigID INT; is the axis number of the input. 0 indicates that the trigger axis is to be the same as Axis.AXIS_NUM. Range is [0,256]</p> <p>NOTE</p> <p>TrigMode INT (TriggerInput.TrigMode) is not presently supported by this function. The TriggerInput.Mode may be supported in a future software version.</p>
	Data type	TRIGGER_REF
	Range	See Description above
	Unit	n/a
	Default	—

2.2.2.5.4.2 Output

Done	Description	Function block has completed
	Data type	BOOL
Busy	Description	Indicates the function block is currently executing
	Data type	BOOL
Error	Description	Indicates the function block did not complete due to an error. The ErrorID output indicates the type of error when this output is high
	Data type	BOOL
ErrorID	Description	When the Error output is high, this output indicates the type of error. When the Error output is low, this output is undefined
	Data type	INT

2.2.2.6.5 Usage

This function block is used to abort an MC_TouchProbe function block.

2.2.2.7.6 Related Functions

[MC_TouchProbe](#)

2.2.2.8.7 Example

2.2.2.9.8.1 Structured Text

```
(* MC_AbortTrigger ST example *)
Inst_MC_AbortTrigger( AbortReq, Axis1, TriggerInputRef );
//Inst_MC_AbortTrigger is an instance of MC_AbortTrigger
```

2.2.2.10.9.2 Ladder Diagram

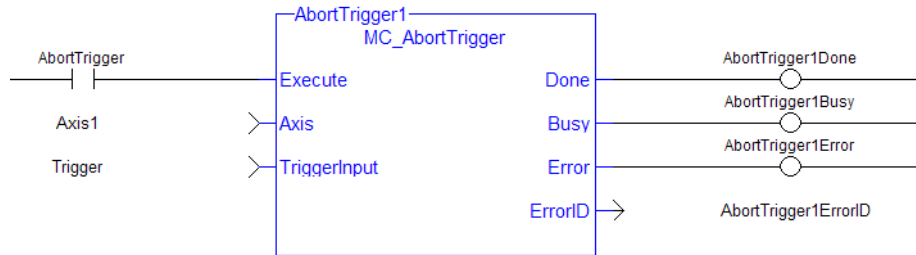

2.2.2.11 MC_TouchProbe PLCopen ✔

2.2.2.12.1 Description

This function block arms a Fast Input and returns the latched position when the Fast Input event occurs. This function block causes no motion.

When the Execute input transitions from low to high, the control requests the drive to arm its Fast Input to latch the axis position when a Fast Input occurs. The Axis input specifies which axis's position to latch and the TriggerInput input specifies which Fast Input to use and whether to trigger on the rising or falling edge of the Fast Input. When the Fast Input event occurs, the drive latches the axis's position. This function block then returns the latched position at the RecordedPosition output and set the Done output high. This process can be canceled with the AbortTrigger function block.

If the WindowOnly input is high, the FirstPosition input and the LastPosition input define a window in which a Fast Input is accepted. Any Fast Input events that occur outside the window is ignored.

If First Position \leq LastPosition, the window in which a Fast Input is accepted is:

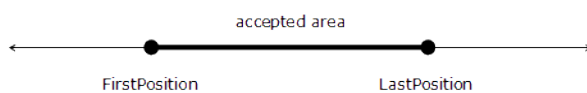
$$\text{FastInputPosition} \geq \text{FirstPosition} \text{ AND } \text{FastInputPosition} \leq \text{LastPosition}.$$

If First Position $>$ LastPosition, the window in which a Fast Input is accepted is:

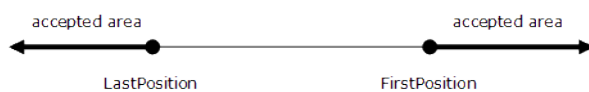
$$\text{FastInputPosition} \geq \text{FirstPosition} \text{ OR } \text{FastInputPosition} \leq \text{LastPosition}.$$

The following figure shows the ladder diagram view of the MC_TouchProbe function block:

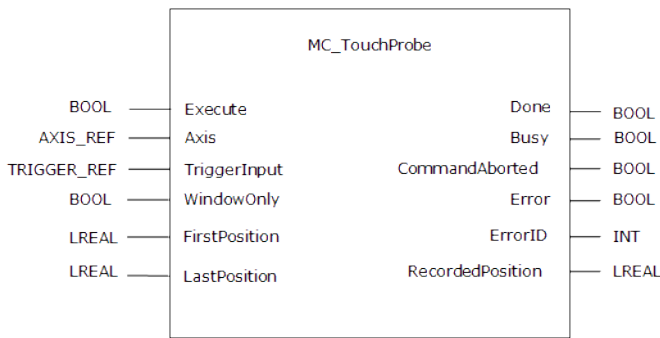

Figure 1-63: MC_TouchProbe

TIP

The accuracy of captured position data depends on the travel velocity. Please see the article [MC TouchProbe and Time-Based Capture](#) on [KDN](#) for more information and how to correct for timing.

TIP

To use Capture Engine 1 modify the input PDOs that are used and add the Latch Position 1 parameter.

TIP

When using position-based capture, the proper Capture Mode and FB Source may need to be set up in the drive. One place to do that is in the Position Capture Screen in the KAS IDE embedded WorkBench:

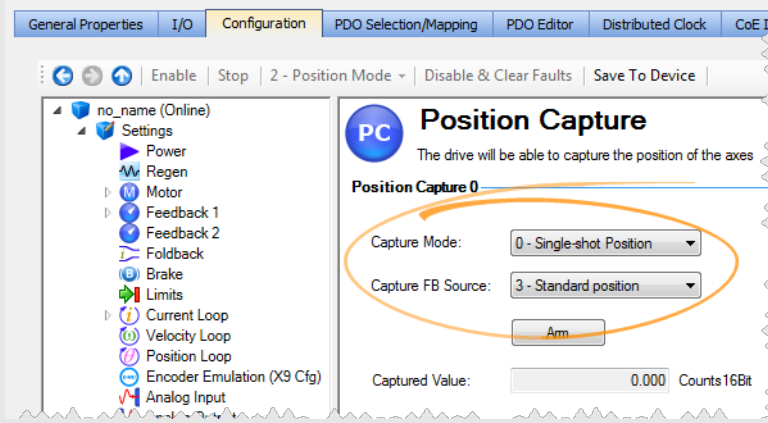

TIP

When setting up Position Capture, check the CoE-Init Command settings shown below. This is to verify they do not overwrite the corresponding drive parameters with unwanted values when the EtherCAT network initializes.

Index	Subindex	Value	Comment	Direction	Source
0x6060	0	7	Opmode	Write	ESI File
0x60C2	1	1	Cycle time	Write	ESI File
0x60C2	2	-3	Cycle exp	Write	ESI File
0x3460	1	0	Latching engine 0 config to F10, CAP0.TRIGGER=0, 0x3460-1:=0 (1 byte)	Write	ESI File
0x3460	2	1	Latching engine 1 config to F11, CAP1.TRIGGER=1, 0x3460-2:=1 (1 byte)	Write	ESI File
0x60FE	2	196608	Digital Outputs Mask, 0x60fe:=0x30000 (4 bytes)	Write	ESI File
0x36E6	0	1	Set FBUS.PARAM02 to activate synchronization with the interrupt	Write	ESI File
0x36E8	0	1	Set FBUS.PARAM04 to disabled the drive on a motion error	Write	ESI File
0x3506	0	1	Set DRV.HWENMODE to disabled the rising edge of the hardware enable from clearing the drive faults	Write	ESI File
0x35CA	0	1048576	Set UNIT.PIN to set gear IN to the correct unit conversion.	Write	ESI File
0x365F	0	0	Set UNIT.VROTARY to set the velocity units to RPM.	Write	ESI File
0x3460	3	2	Capture mode to distributed clock time (DCT), CAP0.MODE=2, 0x3460-3:=0 (1 byte)	Write	ESI File
0x3460	4	2	Capture mode to distributed clock time (DCT), CAP1.MODE=2, 0x3460-4:=0 (1 byte)	Write	ESI File
0x50E2	0	1000	Set IL.KBUSFF (L0 = 1000) UINT32	Write	ESI File
0x3498	0	1	Set FBUS.PROTECTION (available only since FW 01-07-03-000)	Write	ESI File

2.2.2.13.2 Arguments

2.2.2.14.3.1 Input

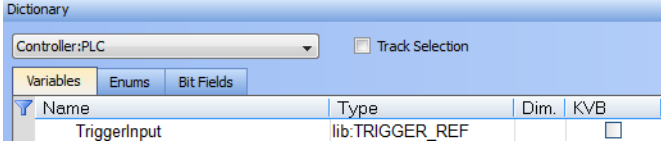
Execute	Description	Enables execution
	Data type	BOOL
	Range	0, 1
	Unit	n/a
	Default	—
Axis	Description	Selects the axis for which the position is latched
	Data type	AXIS_REF
	Range	[1,256]
	Unit	n/a
	Default	—
TriggerInput	Description	Sets up the mechanism for the capture input signal.
	Data type	TRIGGER_REF - an instance of the TRIGGER_REF reference function must first be setup in the Project Dictionary, as seen here. 
Elements	Capture Engine (drive capture engine to be used)	INT TriggerInput.InputID 0 = Capture Engine 0 1 = Capture Engine 1 Range is [0,1] For information on configuring the capture engines, refer to AKD Capture Engine Configuration.
	Trigger Direction (input signal's edge to capture)	INT TriggerInput.Direction 1 = rising edge 2 = falling edge Range is [1,2]
	Axis Number (where input comes from)	INT TriggerInput.TrigID 0 = trigger axis is to be the same as Axis.AXIS_NUM. Range is [0,256]
	Trigger Mode (capture method)	INT TriggerInput.TrigMode 0 = time based capture 1 = position based capture. For position based capture the TrigID must be the same as the Axis_Ref. Range is [0,1]
	Unit	n/a

	Default	—
WindowOnly	Description	Enables a position latching window. When this input is set, a window is defined by the FirstPosition and LastPosition inputs. Any Fast Input event that occurs outside the window is ignored. The first Fast Input event that occurs within the window latches the axis position
	Data type	BOOL
	Range	—
	Unit	n/a
	Default	—
FirstPosition	Description	See the function block Description above for an explanation of how this input and the LastPosition input define the window. This input is only applicable when the WindowOnly input is high. If the WindowOnly input is low, this input is ignored
	Data type	LREAL
	Range	—
	Unit	User unit
	Default	—
LastPosition	Description	See the function block Description above for an explanation of how this input and the FirstPosition input define the window. This input is only applicable when the WindowOnly input is high. If the WindowOnly input is low, this input is ignored
	Data type	LREAL
	Range	—
	Unit	User unit
	Default	—

2.2.2.15.4.2 Output

Done	Description	Function block has completed and the RecordedPosition output is valid
	Data type	BOOL
Busy	Description	Indicates that the specified input is arming or is armed, and waiting for the trigger and recording of the position to occur
	Data type	BOOL
CommandAborted	Description	A TriggerAbort function block has executed and canceled this function
	Data type	BOOL

Error	Description	The function block has not completed successfully due to an error. The ErrorID output indicates the type of error
	Data type	BOOL
ErrorID	Description	When the Error output is high, this output indicates the type of error. When the Error output is low, this output is undefined
	Data type	INT
RecordedPosition	Description	When the Done output goes high, this output returns the latched position. When the Done output is low, this output is undefined
	Data type	LREAL
	Unit	User unit

2.2.2.16.5 Usage

This function block can be used to:

- Perform registration
- Determine the position of a product
- Measure product length

2.2.2.17.6 Limitations

- Both high speed inputs cannot be used at the same time.
- TheTrigMode option is only used by MC_TouchProbe.

2.2.2.18.7 Related Functions

[MC_AbortTrigger](#)

2.2.2.19.8 See Also

- Fast Inputs with Pipe Network Motion
- Fast Inputs with PLCOpen
- Fast Homing Example with the Pipe Network Motion Engine Axis Pipe Block
- Fast Homing Example with the PLCOpen Motion Engine
- Pipe Network Registration and Fast Homing
- Registration Position Capture Example with Pipe Network Trigger Block

2.2.2.20.9 Example

2.2.2.21.10.1 Structured Text

```
(* MC_TouchProbe ST example *)
TriggerInputRef.InputID := 1; //configure InputID
TriggerInputRef.Direction := 1; //configure Direction
TriggerInputRef.TrigID := 0; //configure TrigID
TriggerInputRef.TrigMode := 0; //Capture trigger based on
distributed clock time

Inst_MC_TouchProbe( ArmProbe, Axis1, TriggerInputRef,
FALSE, 0.0, 0.0 );

//Inst_MC_TouchProbe is an instance of MC_TouchProbe function
block

ProbeIsDone := Inst_MC_TouchProbe.Done; //store Done output
into a user defined variable

ProbeValue := Inst_MC_TouchProbe.RecordedPosition; //store
RecordedPosition output into a user defined variable
```

2.2.22.11.2 Ladder Diagram

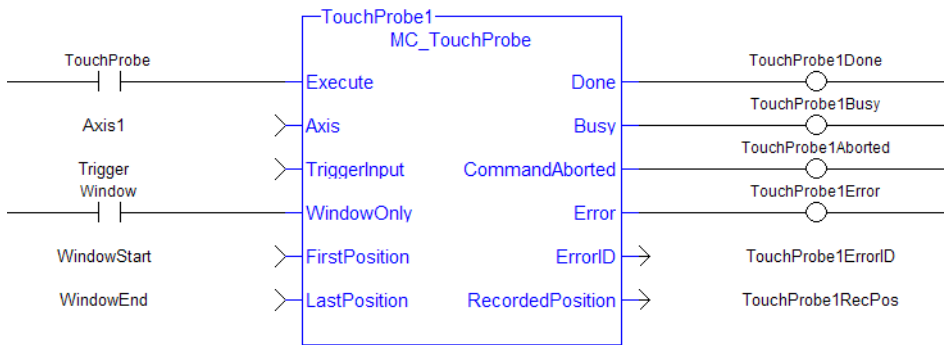

2.2.3 Information Functions

This set of functions provides feedback and allows you to writer parameters.

2.2.3.1 MC_ReadActPos PLCopen ✓

2.2.3.2.1 Description

The MC_ReadActPos function block reads the actual position of the axis.

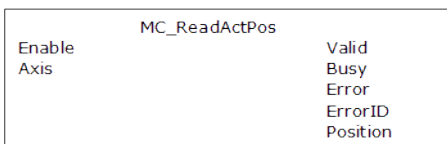

Figure 1-64: MC_ReadActPos

2.2.3.3.2 Arguments

2.2.3.4.3.1 Input

Enable	Description	Request to read the axis's actual position Keeps continuously to read the actual position every PLC cycle, as long as the Enable remains high
	Data type	BOOL
	Range	0, 1
	Unit	n/a
	Default	—
Axis	Description	Name of a declared instance of the AXIS_REF library function.)
	Data type	AXIS_REF
	Range	[1,256]
	Unit	n/a
	Default	—

2.2.3.5.4.2 Output

Valid	Description	Indicates the value at the Position output is available
	Data type	BOOL
Busy	Description	Indicates this function block is executing
	Data type	BOOL
Error	Description	Indicates an invalid input
	Data type	BOOL
ErrorID	Description	Indicates the error if Error output is set to TRUE.
	Data type	INT
Position	Description	Actual position of the axis.
	Unit	User unit
	Data type	LREAL

2.2.3.6.5 Example

2.2.3.7.6.1 Structured Text

```
(* MC_ReadActPos ST example *)
Inst_MC_ReadActPos( TRUE, Axis1 );
//Inst_MC_ReadActPos is an instance of MC_ReadActPos function
block

ActualPos := Inst_MC_ReadActPos.Position;
//store Position output into a user defined variable
```

2.2.3.8.7.2 Ladder Diagram

Get the Axis 1 actual position for the Control Panel to display

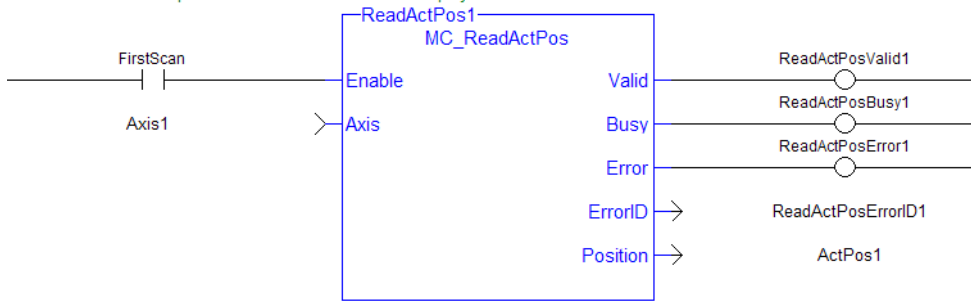

2.2.3.9 MC_ReadActVel PLCopen ✓

2.2.3.10.1 Description

The MC_ReadActVel function block reads the actual velocity of the axis.

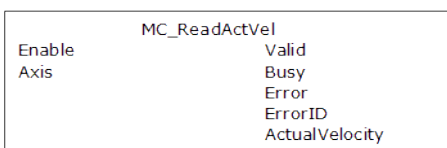

Figure 1-65: MC_ReadActVel

2.2.3.11.2 Arguments

2.2.3.12.3.1 Input

Enable	Description	Requests to read the axis's actual velocity
	Data type	BOOL
	Range	0, 1
	Unit	n/a
	Default	—
Axis	Description	Name of a declared instance of the AXIS_REF library function.
	Data type	AXIS_REF
	Range	[1,256]
	Unit	n/a
	Default	—

2.2.3.13.4.2 Output

Valid	Description	Indicates the value at the ActualVelocity output is available
	Data type	BOOL
Busy	Description	Indicates this function block is executing
	Data type	BOOL

Error	Description	Indicates an invalid input
	Data type	BOOL
ErrorID	Description	Indicates the error if Error output is set to TRUE.
	Data type	INT
ActualVelocity	Description	Actual velocity of the axis. Please note that oscillations may be seen due to this being an instant velocity, not an average velocity.
	Unit	User unit/sec
	Data type	LREAL

2.2.3.14.5 Example

2.2.3.15.6.1 Structured Text

```

* MC_ReadActVel ST example *);
Inst_MC_ReadActVel( TRUE, Axis1 ); //Inst_MC_ReadActVel is an
instance of MC_ReadActVel function block

ActualVel := Inst_MC_ReadActVel.ActualVelocity; // store
ActualVelocity output into a user defined variable
    
```

2.2.3.16.7.2 Ladder Diagram

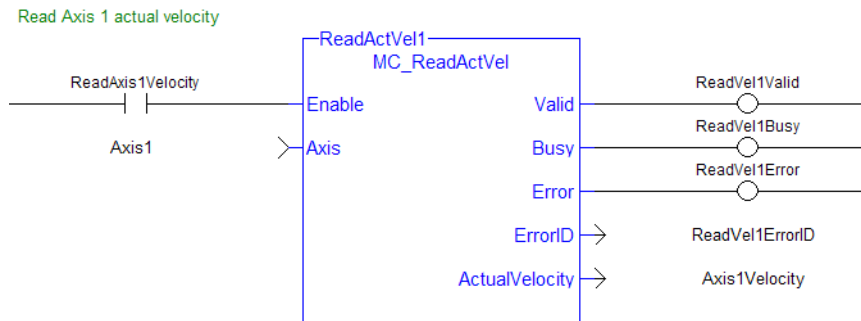

2.2.3.17 MC_ReadAxisErr PLCopen ✔

2.2.3.18.1 Description

The Function Block MC_ReadAxisErr returns the error status of the specified axis.

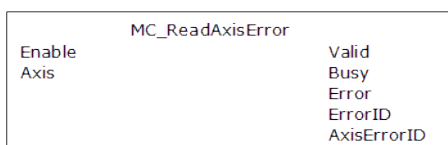

Figure 1-66: MC_ReadAxisErr

2.2.3.19.2 Arguments

2.2.3.20.3.1 Input

Enable	Description	requests to read the error status of the axis
	Data type	BOOL
	Range	0, 1
	Unit	n/a
	Default	—
Axis	Description	Name of a declared instance of the AXIS_REF library function.
	Data type	AXIS_REF
	Range	[1,256]
	Unit	n/a
	Default	—

2.2.3.21.4.2 Output

Valid	Description	Indicates the AxisErrorID output is valid
	Data type	BOOL
Busy	Description	Indicates this function block is executing
	Data type	BOOL
Error	Description	Indicates an invalid input
	Data type	BOOL
ErrorID	Description	Indicates the error if Error output is set to TRUE
	Data type	INT
AxisErrorID	Description	Indicates the error status of the axis. Each bit indicates a specific error. Both emergency-stop (E-stop) and controlled-stop (C-stop) errors are indicated. The table below defines the bits of this output.
	Data type	INT

Hexadecimal	Decimal	Description
0000H	0	No Error
0001H	1	User-set E-stop via MC_EStop, E-stop
0002H	2	Loss of Feedback, E-stop
0004H	4	Drive Fault, E-stop
0008H	8	Drive Communication Failure, E-stop
0400H	1024	Synchronization Error, C-stop

NOTE

Multiple errors can be active at the same time. For example, if a User-set E-stop and an Excess Position Error E-stop are both active, the value would be 00000011H (17 decimal).

2.2.3.22.5 Example

2.2.3.23.6.1 Structured Text

```
(* MC_ReadAxisErr ST example *)
Inst_MC_ReadAxisErr( TRUE, Axis1 );
//Inst_MC_ReadAxisErr is an instance of MC_ReadAxisErr function
block
AxisErrorBits := Inst_MC_ReadAxisErr.AxisErrorID; //AxisErrorID
contains the error bits
```

2.2.3.24.7.2 Ladder Diagram

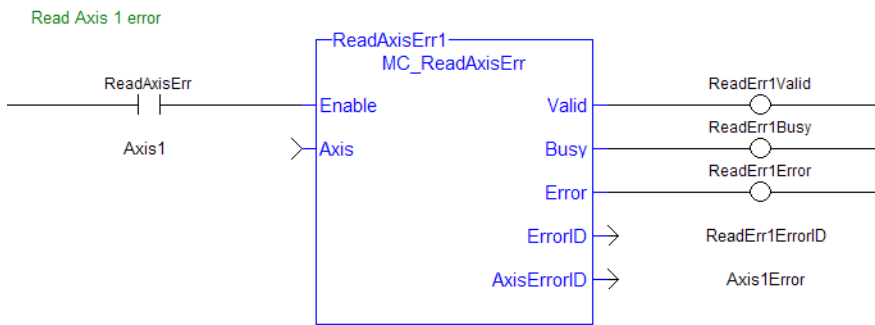

2.2.3.25 MC_ReadBoolPar PLCopen ✔

2.2.3.26.1 Description

The MC_ReadBoolPar function block returns the value of the specified Boolean axis parameter.

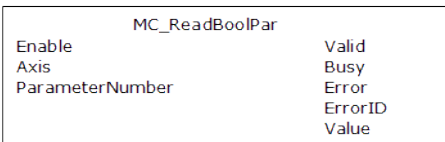

Figure 1-67: MC_ReadBoolPar

2.2.3.27.2 Arguments

2.2.3.28.3.1 Input

Enable	Description	Requests to read the Boolean axis parameter
	Data type	BOOL
	Range	0, 1
	Unit	n/a
	Default	—
Axis	Description	Name of a declared instance of the AXIS_REF library function.)

	Data type	AXIS_REF
	Range	[1,256]
	Unit	n/a
	Default	—
ParameterNumber	Description	Parameter number, see table in Axis Parameters
	Data type	INT
	Range	—
	Unit	n/a
	Default	—

2.2.3.29.4.2 Output

Valid	Description	Indicates the Value output is valid
	Data type	BOOL
Busy	Description	Indicates this function block is executing
	Data type	BOOL
Error	Description	Indicates an invalid input
	Data type	BOOL
ErrorID	Description	Indicates the error if Error output is set to TRUE
	Data type	INT
Value	Description	State of the Boolean parameter
	Data type	BOOL

2.2.3.30.5 Example

2.2.3.31.6.1 Structured Text

```
(* MC_ReadBoolPar ST example *)
Inst_MC_ReadBoolPar( EnableRead, Axis1, MC_AXIS_PARAM_IN_
POSITION );
Axis1InPosition := Inst_MC_ReadBoolPar.Value;
```

2.2.3.32.7.2 Ladder Diagram

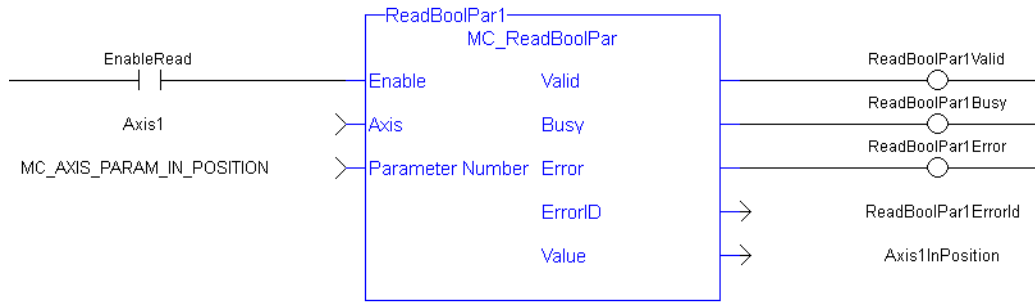

2.2.3.33 MC_ReadParam PLCopen ✓

2.2.3.34.1 Description

The MC_ReadParam function block returns the value of the specified axis parameter.

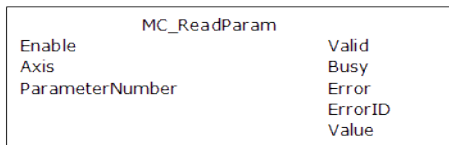

Figure 1-68: MC_ReadParam

2.2.3.35.2 Arguments

2.2.3.36.3.1 Input

Enable	Description	Requests to read the axis parameter
	Data type	BOOL
	Range	0, 1
	Unit	n/a
	Default	—
Axis	Description	Name of a declared instance of the AXIS_REF library function.)
	Data type	AXIS_REF
	Range	[1,256]
	Unit	n/a
	Default	—
ParameterNumber	Description	Parameter number, see table in Axis Parameters
	Data type	INT
	Range	—
	Unit	n/a
	Default	—

2.2.3.37.4.2 Output

Valid	Description	Indicates the Value output is valid
	Data type	BOOL
Busy	Description	Indicates this function block is executing
	Data type	BOOL
Error	Description	Indicates an invalid input
	Data type	BOOL
ErrorID	Description	Indicates the error if Error output is set to TRUE
	Data type	INT
Value	Description	Value of the parameter
	Data type	LREAL

2.2.3.38.5 Example

2.2.3.39.6.1 Structured Text

```
(* MC_ReadParam ST example *)
Inst_MC_ReadParam( EnableRead, Axis1, MC_AXIS_PARAM_CMD_VEL );
Axis1_CmdVel := Inst_MC_ReadParam.Value;
```

2.2.3.40.7.2 Ladder Diagram

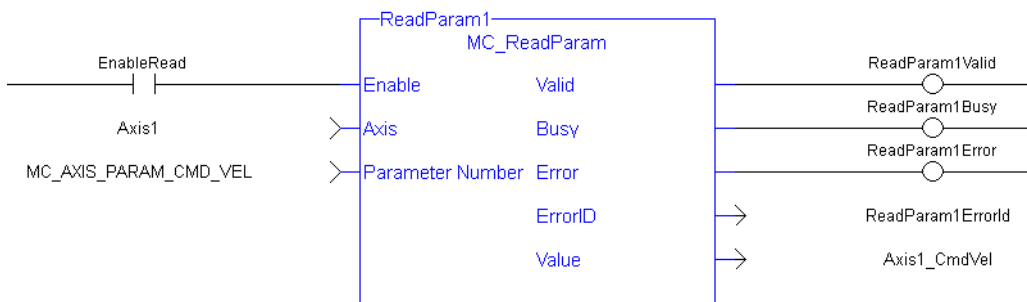

2.2.3.41 MC_ReadStatus PLCopen

2.2.3.42.1 Description

The function block MC_ReadStatus returns the state of the specified axis.

Enable	Valid
Axis	Busy
	Error
	ErrorID
	ErrorStop
	Disabled
	Stopping
	StandStill
	DiscreteMotion
	ContinuousMotion
	SynchronizedMotion
	Homing
	ConstantVelocity
	Accelerating
	Decelerating

Figure 1-69: MC_ReadStatus

2.2.3.43.2 Arguments

2.2.3.44.3.1 Input

Enable	Description	Requests to read and return the axis status
	Data type	BOOL
	Range	0, 1
	Unit	n/a
	Default	—
Axis	Description	Name of a declared instance of the AXIS_REF library function. click here...
	Data type	AXIS_REF
	Range	[1,256]
	Unit	n/a
	Default	—

2.2.3.45.4.2 Output

Valid	Description	Indicates the outputs are valid
	Data type	BOOL
Busy	Description	Indicates this function block is executing
	Data type	BOOL
Error	Description	Indicates an invalid input
	Data type	BOOL
ErrorID	Description	Indicates the error if Error output is set to TRUE
	Data type	INT
ErrorStop	Description	Indicates Error Stop state – E-stop or C-stop
	Data type	BOOL
Disabled	Description	Indicates Disabled state – open loop and drive is disabled
	Data type	BOOL
Stopping	Description	Indicates Stopping state – MC_Stop command
	Data type	BOOL
StandStill	Description	Indicates Stand Still state – no move, closed loop, drive enabled

	Data type	BOOL
DiscreteMotion	Description	Indicates Discrete Motion state – programmed endpoint move is active
	Data type	BOOL
ContinuousMotion	Description	Indicates Continuous Motion state – unending, single-axis move is active
	Data type	BOOL
SynchronizedMotion	Description	Indicates Synchronized Motion state – slave move is active
	Data type	BOOL
Homing	Description	Indicates Homing state – a homing cycle is currently executing
	Data type	BOOL
ConstantVelocity	Description	Indicates the axis is moving at a constant velocity
	Data type	BOOL
Accelerating	Description	Indicates the axis is accelerating
	Data type	BOOL
Decelerating	Description	Indicates the axis is decelerating
	Data type	BOOL

2.2.3.46.5 Example

2.2.3.47.6.1 Structured Text

```
(* MC_ReadStatus ST example *)
Inst_MC_ReadStatus( EnableRead, Axis1 );
//Inst_MC_ReadStatus is an instance of MC_ReadStatus function
block
AxisStopping := Inst_MC_ReadStatus.Stopping; // store Stopping
output to a user defined variable
AxisAccelerating := Inst_MC_ReadStatus.Accelerating; // store
Accelerating output to a user defined variable
```

2.2.3.48.7.2 Ladder Diagram

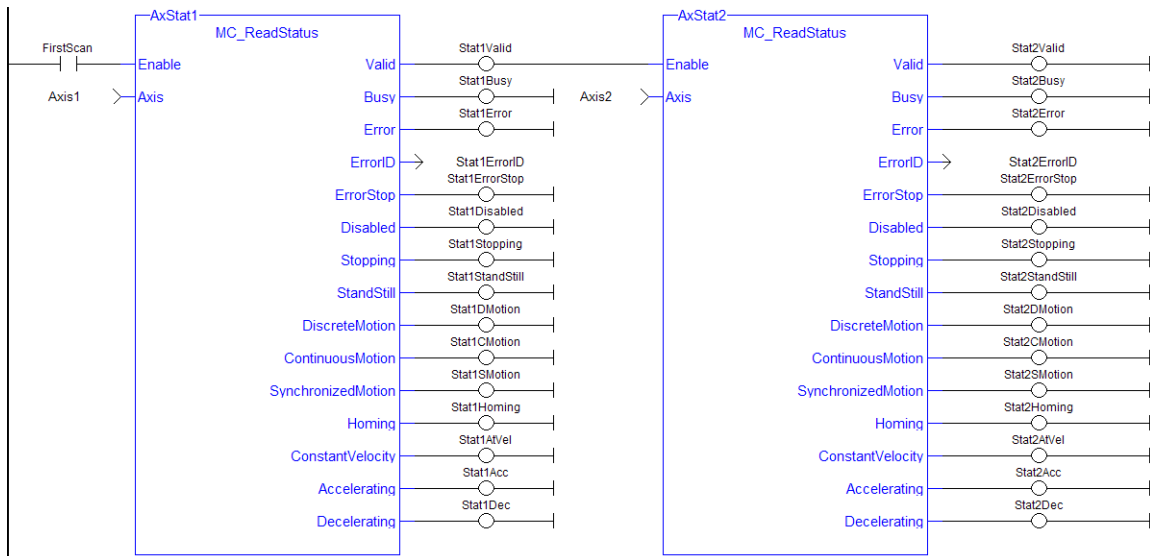

2.2.3.49 MC_WriteBoolPar PLCopen ✓

2.2.3.50.1 Description

The MC_WriteBoolPar function block writes the specified axis Boolean parameter.

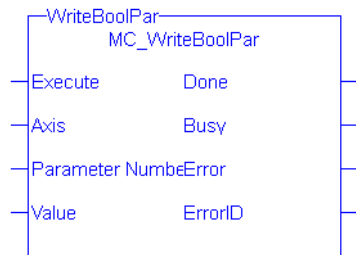

The MC_WriteBoolPar function block

2.2.3.51.2 Arguments

2.2.3.52.3.1 Input

Execute	Description	Requests to write a Boolean axis parameter
	Data type	BOOL
	Range	0, 1
	Unit	n/a
	Default	—
Axis	Description	Name of a declared instance of the AXIS_REF library function.
	Data type	AXIS_REF
	Range	[1,256]
	Unit	n/a
	Default	—

ParameterNumber	Description	Parameter number, see table in Axis Parameters
	Data type	INT
	Range	—
	Unit	n/a
	Default	—
Value	Description	State to write
	Data type	BOOL
	Range	0, 1
	Unit	n/a
	Default	—

2.2.3.53.4.2 Output

Done	Description	Indicates the Boolean parameter has been written
	Data type	BOOL
Busy	Description	Indicates this function block is executing
	Data type	BOOL
Error	Description	Indicates an invalid input
	Data type	BOOL
ErrorID	Description	Indicates the error if Error output is set to TRUE
	Data type	INT

2.2.3.54.5 Example

2.2.3.55.6.1 Structured Text

```
(* MC_WriteBoolPar ST example *)
WriteBool := FALSE;
Inst_MC_WriteBoolPar( WriteReq, Axis1, 1050, WriteBool );
```

2.2.3.56.7.2 Ladder Diagram

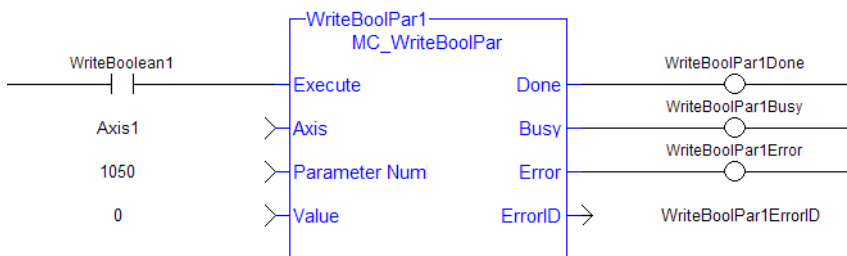

NOTE

Currently, MC_WriteBoolPar does not support any parameters (1050 is an arbitrary number chosen for example)

2.2.3.57 MC_WriteParam PLCopen ✓**2.2.3.58.1 Description**

The MC_WriteParam function block writes the specified axis parameter.

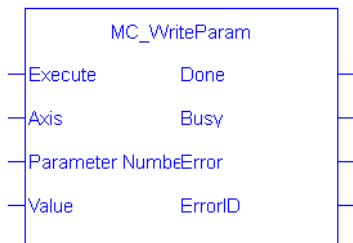

Figure 1-70: The MC_WriteParam function block

2.2.3.59.2 Arguments**2.2.3.60.3.1 Input**

Execute	Description	Requests to write the axis parameter
	Data type	BOOL
	Range	0, 1
	Unit	n/a
	Default	—
Axis	Description	Name of a declared instance of the AXIS_REF library function.
	Data type	AXIS_REF
	Range	[1,256]
	Unit	n/a
	Default	—
ParameterNumber	Description	Parameter number, see table in Axis Parameters
	Data type	INT
	Range	—
	Unit	n/a
	Default	—
Value	Description	Value to write
	Data type	LREAL

Range	—
Unit	n/a
Default	—

2.2.3.61.4.2 Output

Done	Description	Indicates the parameter has been written
	Data type	BOOL
Busy	Description	Indicates this function block is executing
	Data type	BOOL
Error	Description	Indicates an invalid input
	Data type	BOOL
ErrorID	Description	Indicates the error if Error output is set to TRUE
	Data type	INT

2.2.3.62.5 Example

2.2.3.63.6.1 Structured Text

```
(* MC_WriteParam ST example *)
MasterOffset := 12.34;
Inst_MC_WriteParam( EnableWrite, Axis1, MC_AXIS_PARAM_MASTER_
OFFSET, MasterOffset);
```

2.2.3.64.7.2 Ladder Diagram

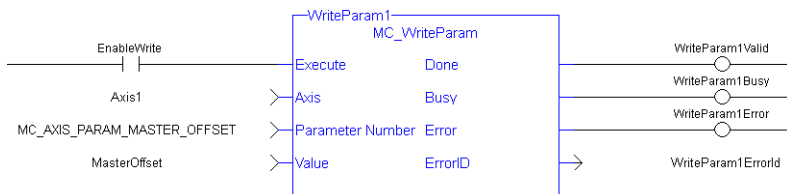

2.2.4 PLCOpenMotion Functions

This set of functions provides control over an axis.

2.2.4.1 MC_Halt PLCopen ✓

2.2.4.2.1 Description

This function block decelerates an axis to zero velocity. It is a queued single-axis move. The move is complete when the axis reaches zero velocity. It is typically used with Abort at the BufferMode input to terminate a move. To execute a stop that cannot be aborted, see [MC_Stop](#).

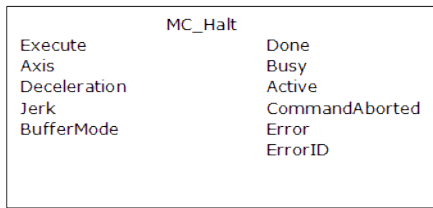

Figure 1-71: MC_Halt

2.2.4.3.2 Time Diagram

The example below shows the behavior in combination with a [MC_MoveVelocity](#).

- A rotating axis is ramped down with FB2 MC_Halt
- Another motion command overrides the MC_Halt command

MC_Halt allows this, in contrast to MC_Stop. The axis can accelerate again without reaching standstill.

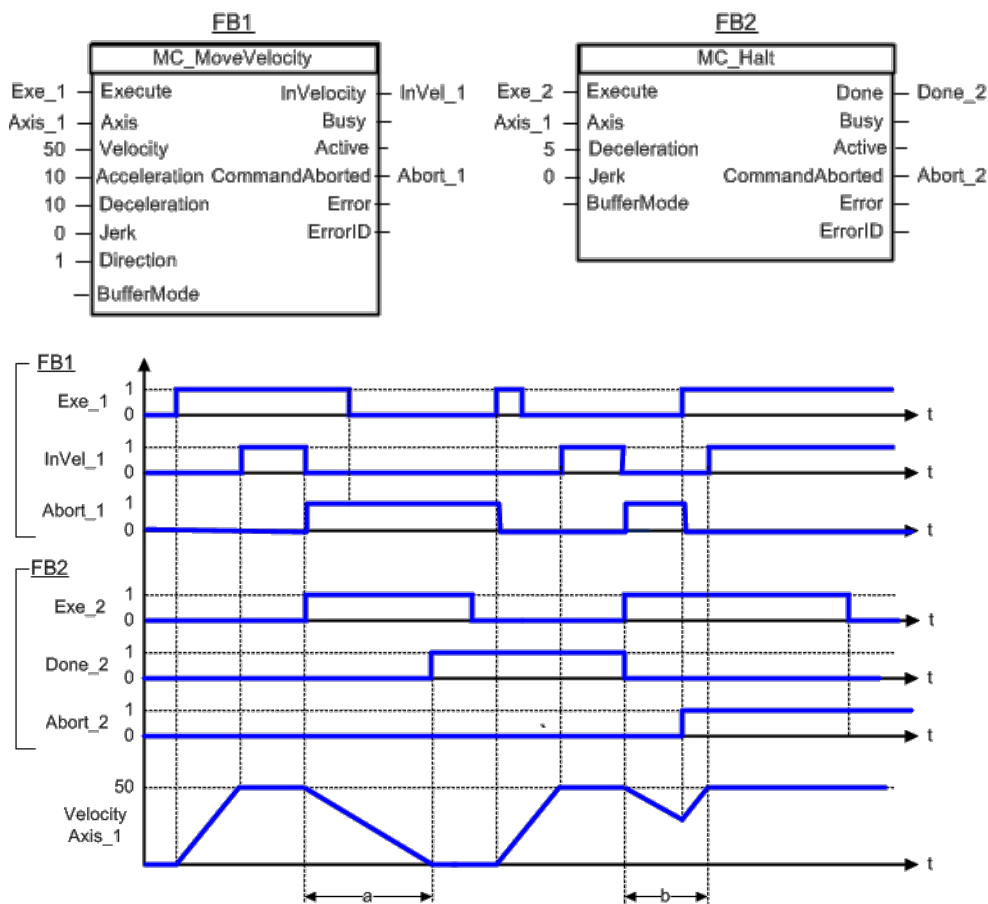

2.2.4.4.3 Arguments

2.2.4.5.4.1 Input

Execute	Description	Requests to queue the move
	Data type	BOOL
	Range	0, 1
	Unit	n/a

	Default	—
Axis	Description	Name of a declared instance of the AXIS_REF library function
	Data type	AXIS_REF
	Range	[1,256]
	Unit	n/a
	Default	—
Deceleration	Description	Trapezoidal: Deceleration rate S-curve: Maximum deceleration
	Data type	LREAL
	Range	—
	Unit	User unit/sec ²
	Default	—
Jerk	Description	Trapezoidal: 0 S-curve: Constant jerk
	Data type	LREAL
	Range	—
	Unit	User unit/sec ³
	Default	—
BufferMode	Description	0 = abort 1 = buffer 2 = blend to active 3 = blend to next 4 = blend to low velocity 5 = blend to high velocity
	Data type	SINT
	Range	[0,5]
	Unit	n/a
	Default	—

2.2.4.6.5.2 Output

Done	Description	Indicates the move completed successfully. The Command Position has reached the endpoint.
	Data type	BOOL
Busy	Description	High from the moment the Execute input is one-shot to the time the move is ended

	Data type	BOOL
Active	Description	Indicates this move is the active move
	Data type	BOOL
CommandAborted	Description	Indicates this move was aborted
	Data type	BOOL
Error	Description	Indicates an invalid input was specified or the move was terminated due to an error
	Data type	BOOL
ErrorID	Description	Indicates the error if Error output is set to TRUE
	Data type	INT

2.2.4.7.6 Example

2.2.4.8.7.1 Structured Text

```
(* MC_Halt ST example *)
Inst_MC_Halt( HaltReq, Axis1,100.0, 100.0, 0 );
//Inst_MC_Halt is an instance of MC_halt function block
HaltComplete := Inst_MC_Halt.Done; //store Done output into
user defined variable
```

2.2.4.9.8.2 Ladder Diagram

Stop both axes when the Run/Stop switch is set to Stop

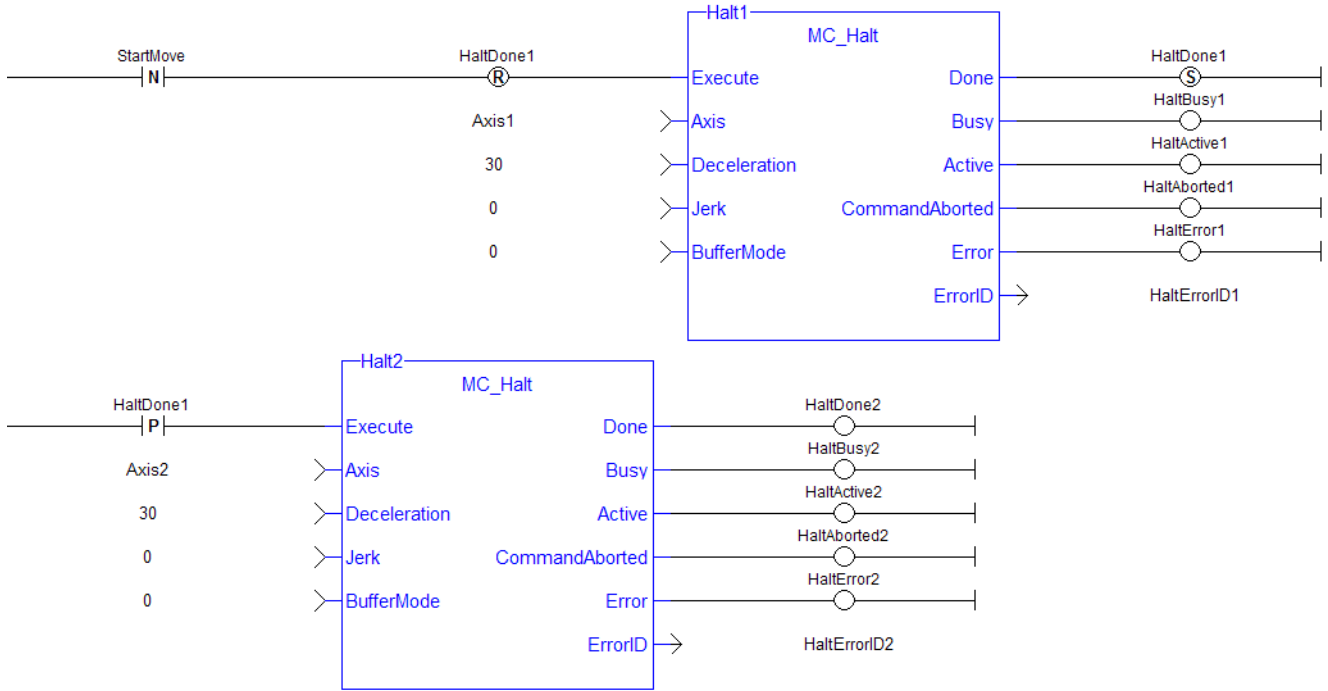

2.2.4.10 MC_MoveAbsolute PLCopen ✓

2.2.4.11.1 Description

This function block performs a single-axis move to a specified endpoint position based on Axis, Position, Velocity, Acceleration, Deceleration, Jerk, and Direction parameters.

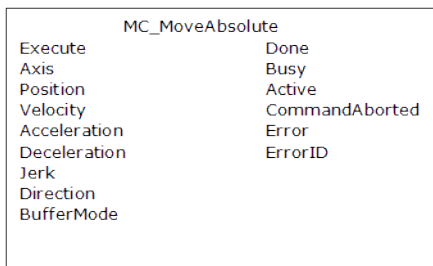
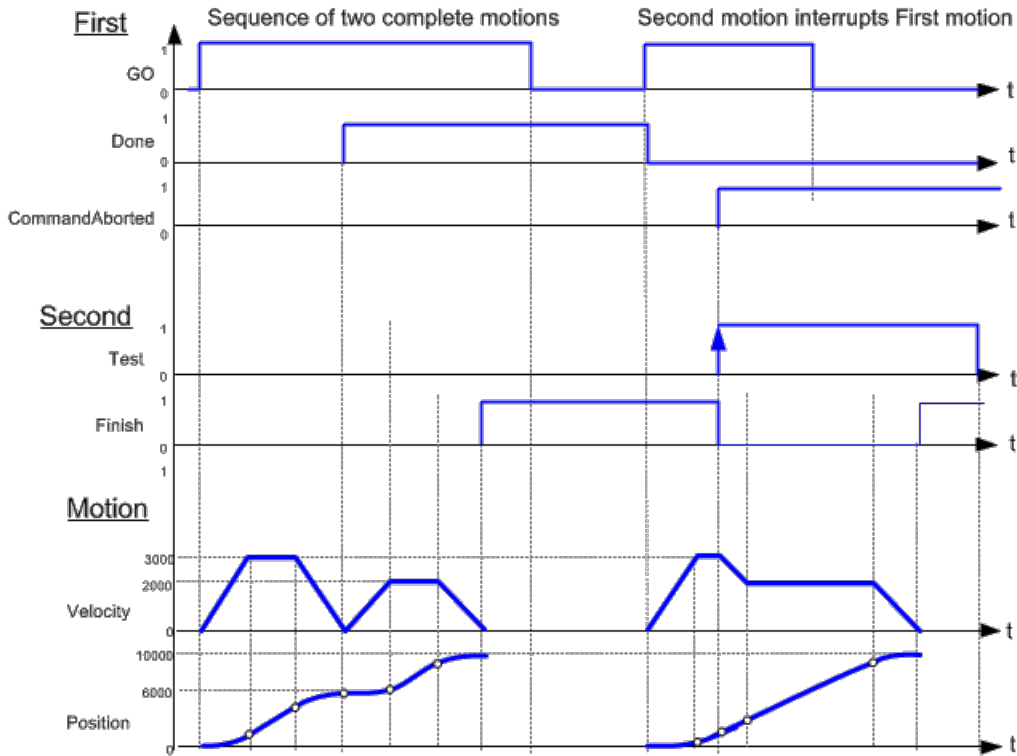
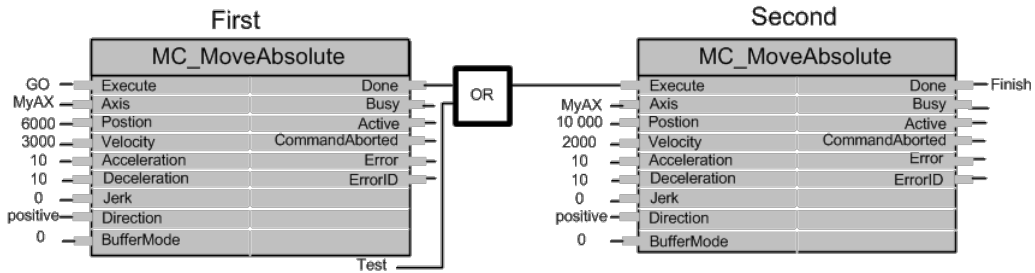

Figure 1-72: MC_MoveAbsolute

2.2.4.12.2 Time Diagram

The following figure shows two examples of the combination of two absolute move Function Blocks:

- The left part of timing diagram illustrates the case if the Second Function Block is called **after** the First one. If First reaches the commanded position of 6000 (and the velocity is 0) then the output Done causes the Second FB to move to the position 10000
- The right part of the timing diagram illustrates the case if the Second move Function Block starts the execution **while** the First FB is still executing. In this case the First motion is interrupted and aborted by the Test signal during the constant velocity of the First FB. The Second FB moves directly to the position 10000 although the position of 6000 is not yet reached



2.2.4.13.3 Arguments

2.2.4.14.4.1 Input

Execute	Description	Requests to queue the move
	Data type	BOOL
	Range	0, 1
	Unit	n/a
	Default	—
Axis	Description	Name of a declared instance of the AXIS_REF library function
	Data type	AXIS_REF
	Range	[1,256]
	Unit	n/a
	Default	—

Position	Description	Endpoint position. If Rollover Position is nonzero, this value must be in the range $0 \leq \text{Position} < \text{Rollover Position}$ When not in Rollover mode, the input accepts a 64-bit floating point value. When converted to feedback units, the range is $[-2^{51}, 2^{51}-1]$ feedback units.
	Data type	LREAL
	Range	[see Description]
	Unit	User unit
	Default	—
Velocity	Description	Velocity setpoint
	Data type	LREAL
	Range	—
	Unit	User unit/sec
	Default	—
Acceleration	Description	Trapezoidal: Acceleration rate S-curve: Maximum acceleration If Acceleration is not valid, ErrorID is set to 21 Selection of Acceleration and Jerk Parameters for Function Blocks
	Data type	LREAL
	Range	—
	Unit	User unit/sec ²
	Default	—
Deceleration	Description	Trapezoidal: Deceleration rate S-curve: Unused
	Data type	LREAL
	Range	—
	Unit	User unit/sec ²
	Default	—

Jerk	Description	Trapezoidal: 0 S-curve: Constant jerk If Jerk is not valid, ErrorID is set to 21 Selection of Acceleration and Jerk Parameters for Function Blocks												
	Data type	LREAL												
	Range	—												
	Unit	User unit/sec ³												
	Default	—												
Direction	Description	<p>When Rollover Position is zero, a value of 0 must be specified. When Rollover Position is nonzero, a value of 1, 2, 3, or 4 must be specified.</p> <table border="1"> <thead> <tr> <th>Value</th> <th>Description</th> </tr> </thead> <tbody> <tr> <td>0</td> <td>no direction specification</td> </tr> <tr> <td>1</td> <td>positive direction. The axis travels in the positive direction to the endpoint</td> </tr> <tr> <td>2</td> <td>shortest distance. The axis travels in the direction that provides the shortest distance to the endpoint</td> </tr> <tr> <td>3</td> <td>negative direction. The axis travels in the negative direction to the endpoint</td> </tr> <tr> <td>4</td> <td>last direction. The axis travels to the endpoint in the same direction as its previous move</td> </tr> </tbody> </table> <p>If the Position input is the same as the axis's current position, then:</p> <ul style="list-style-type: none"> when Direction = 2 (shortest distance), the axis does not move and the Done output goes high indicating that the move has been completed. when Direction = 1, 3, or 4, the axis travels in the specified direction, through one rollover cycle, and arrives back at the same position. 	Value	Description	0	no direction specification	1	positive direction. The axis travels in the positive direction to the endpoint	2	shortest distance. The axis travels in the direction that provides the shortest distance to the endpoint	3	negative direction. The axis travels in the negative direction to the endpoint	4	last direction. The axis travels to the endpoint in the same direction as its previous move
Value	Description													
0	no direction specification													
1	positive direction. The axis travels in the positive direction to the endpoint													
2	shortest distance. The axis travels in the direction that provides the shortest distance to the endpoint													
3	negative direction. The axis travels in the negative direction to the endpoint													
4	last direction. The axis travels to the endpoint in the same direction as its previous move													
	Data type	SINT												
	Range	[0,4]												
	Unit	n/a												
	Default	—												
BufferMode	Description	0 = abort 1 = buffer 2 = blend to active 3 = blend to next 4 = blend to low velocity 5 = blend to high velocity												

Data type	SINT
Range	[0,5]
Unit	n/a
Default	—

2.2.4.15.5.2 Output

Done	Description	Indicates the move completed successfully. The Command Position has reached the endpoint.
	Data type	BOOL
Busy	Description	High from the moment the Execute input is one-shot to the time the move is ended
	Data type	BOOL
Active	Description	Indicates this move is the active move
	Data type	BOOL
CommandAborted	Description	Indicates the move was aborted
	Data type	BOOL
Error	Description	Indicates an invalid input was specified or the move was terminated due to an error
	Data type	BOOL
ErrorID	Description	Indicates the error if Error output is set to TRUE
	Data type	INT

2.2.4.16.6 Example

2.2.4.17.7.1 Structured Text

```
(* MC_MoveAbsolute ST example *)
Inst_MC_MoveAbsolute( MovAbsReq, Axis1, 1234.567, 100.0, 100.0,
100.0, 0, 0, 0 ); //instance of MC_MoveAbsolute
MovAbsDone := Inst_MC_MoveAbsolute.Done; //store done output
into user defined variable
MovAbsBusy := Inst_MC_MoveAbsolute.Busy;
MovAbsActive := Inst_MC_MoveAbsolute.Active;
MovAbsAborted := Inst_MC_MoveAbsolute.CommandAborted;
MovAbsError := Inst_MC_MoveAbsolute.Error;
MovAbsErrID := Inst_MC_MoveAbsolute.ErrorID;
```

2.2.4.18.8.2 Ladder Diagram

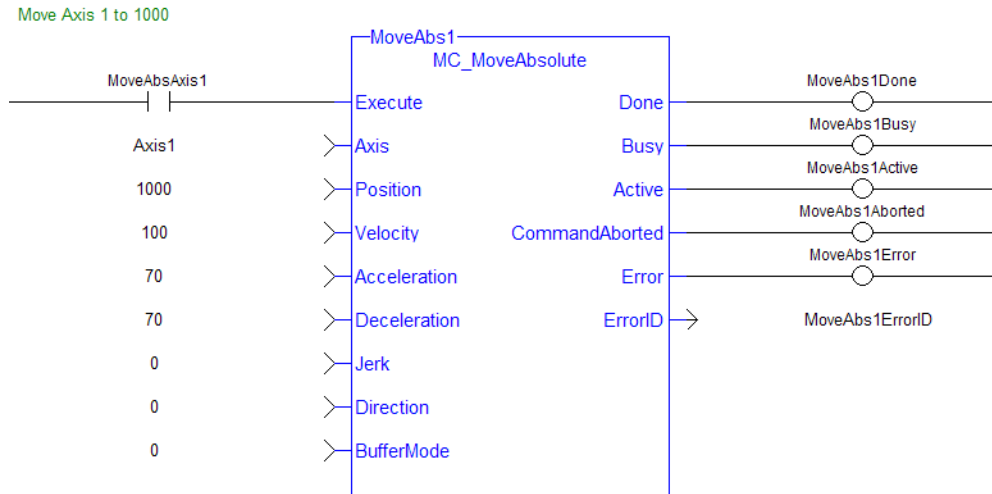

2.2.4.19 MC_MoveAdditive PLCopen ✓

2.2.4.20.1 Description

This function block performs a single-axis move for a specified distance from the endpoint of the previous move. It is typically used with Abort specified at the BufferMode input. If BufferMode is not Abort, this move is identical to an MC_MoveRelative.

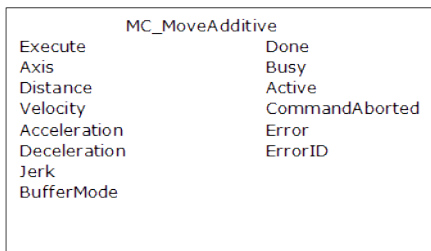
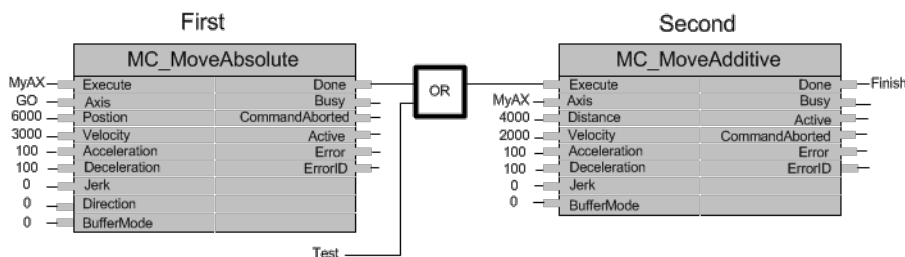

Figure 1-73: MC_MoveAdditive

2.2.4.21.2 Time Diagram

The following figure shows two examples of the combination of two Function Blocks while the axis is in Discrete Motion state:

- The left part of timing diagram illustrates the case if the Second Function Block is called **after** the First one. If First reaches the commanded distance 6000 (and the velocity is 0) then the output **Done** causes the Second FB to move to the distance 10000
- The right part of the timing diagram illustrates the case if the Second move Function Blocks starts the execution **while** the First FB is still executing. In this case the First motion is interrupted and aborted by the Test signal during the constant velocity of the First FB. The Second FB **adds on the previous commanded position** of 6000 the distance 4000 and moves the axis to the resulting position of 10000



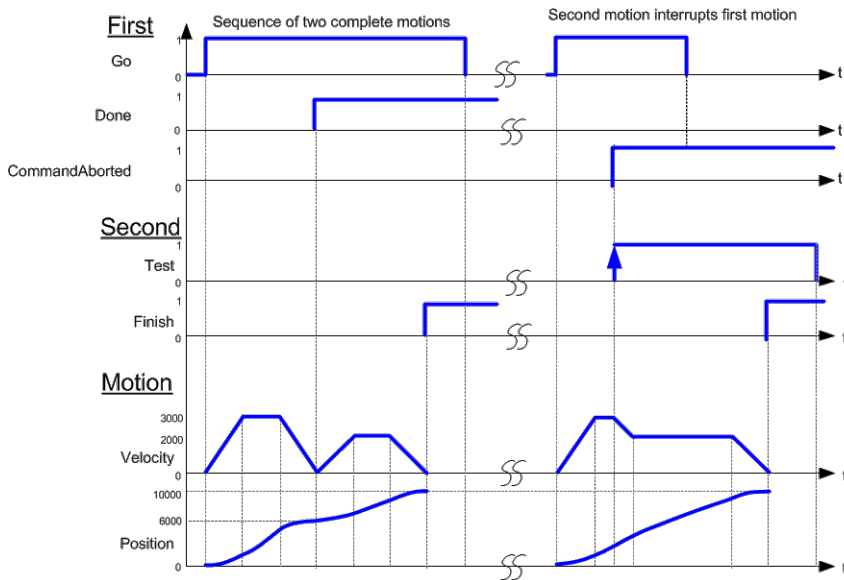

2.2.4.22.3 Arguments

2.2.4.23.4.1 Input

Execute	Description	Requests to queue the move
	Data type	BOOL
	Range	0, 1
	Unit	n/a
	Default	—
Axis	Description	Name of a declared instance of the AXIS_REF library function.)
	Data type	AXIS_REF
	Range	[1,256]
	Unit	n/a
	Default	—
Distance	Description	Distance to add to the endpoint of the previous move
	Data type	REAL
	Range	—
	Unit	User unit
	Default	—
Velocity	Description	Velocity setpoint
	Data type	LREAL
	Range	—

	Unit	User unit/sec
	Default	—
Acceleration	Description	Trapezoidal: Acceleration rate S-curve: Maximum acceleration
	Data type	LREAL
	Range	—
	Unit	User unit/sec ²
	Default	—
Deceleration	Description	Trapezoidal: Deceleration rate S-curve: Unused
	Data type	LREAL
	Range	—
	Unit	User unit/sec ²
	Default	—
Jerk	Description	Trapezoidal: 0 S-curve: Constant jerk
	Data type	LREAL
	Range	—
	Unit	User unit/sec ³
	Default	—
BufferMode	Description	0 = abort 1 = buffer 2 = blend to active 3 = blend to next 4 = blend to low velocity 5 = blend to high velocity
	Data type	SINT
	Range	[0,5]
	Unit	n/a
	Default	—

2.2.4.24.5.2 Output

Done	Description	Indicates the move completed successfully. The Command Position has reached the endpoint.
-------------	--------------------	--

	Data type	BOOL
Busy	Description	High from the moment the Execute input is one-shot to the time the move is ended
	Data type	BOOL
Active	Description	Indicates this move is the active move
	Data type	BOOL
CommandAborted	Description	Indicates the move was aborted
	Data type	BOOL
Error	Description	Indicates an invalid input was specified or the move was terminated due to an error
	Data type	BOOL
ErrorID	Description	Indicates the error if Error output is set to TRUE
	Data type	INT

2.2.4.25.6 Example

2.2.4.26.7.1 Structured Text

```
(* MC_MoveAdditive ST example *)
Inst_MC_MoveAdditive( MovAddReq, Axis1, 123.456, 100.0, 100.0,
100.0, 0, 0 );
//Inst_MC_MoveAdditive is an instance of MC_MoveAdditive
function block
MovAddDone := Inst_MC_MoveAdditive.Done;
//store Done output into user defined variable
```

2.2.4.27.8.2 Ladder Diagram

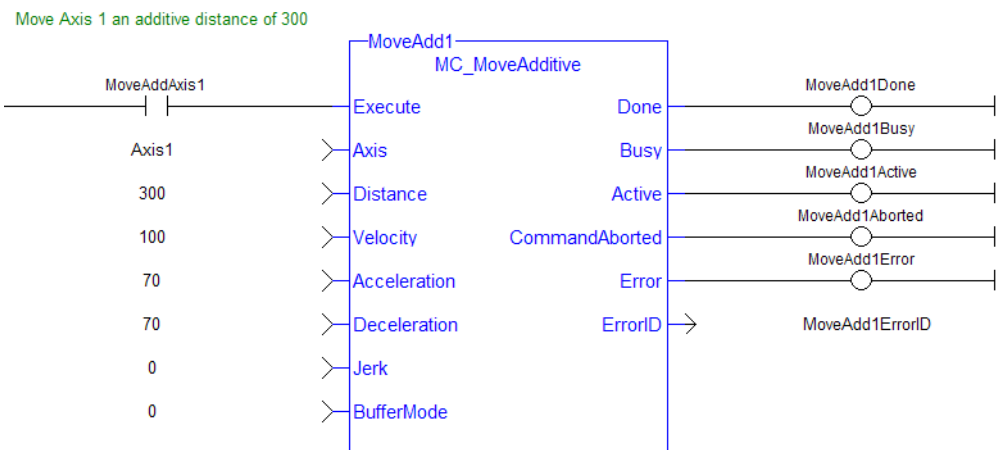

2.2.4.28 MC_MoveRelative PLCopen ✓

2.2.4.29.1 Description

This function block executes a single-axis move for a specified distance to perform incremental motion.

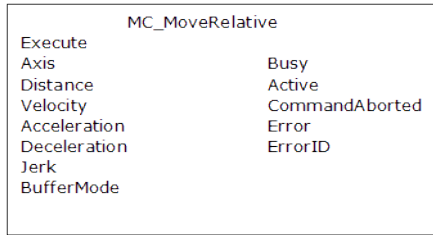
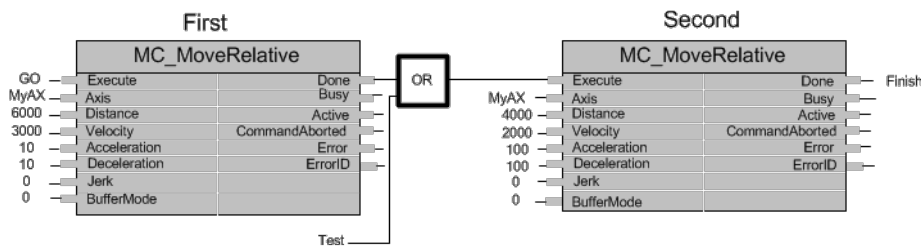

Figure 1-74: MC_MoveRelative

2.2.4.30.2 Time Diagram

The following figure shows the example of the combination of two relative move Function Blocks:

- The left part of timing diagram illustrates the case if the Second Function Block is called **after** the First one. If First reaches the commanded distance 6000 (and the velocity is 0) then the output **Done** causes the Second FB to move to the distance 10000
- The right part of the timing diagram illustrates the case if the Second move Function Blocks starts the execution **while** the First FB is still executing. In this case the First motion is interrupted and aborted by the Test signal during the constant velocity of the First FB. The Second FB **adds on the actual position** of 3250 the distance 4000 and moves the axis to the resulting position of 7250



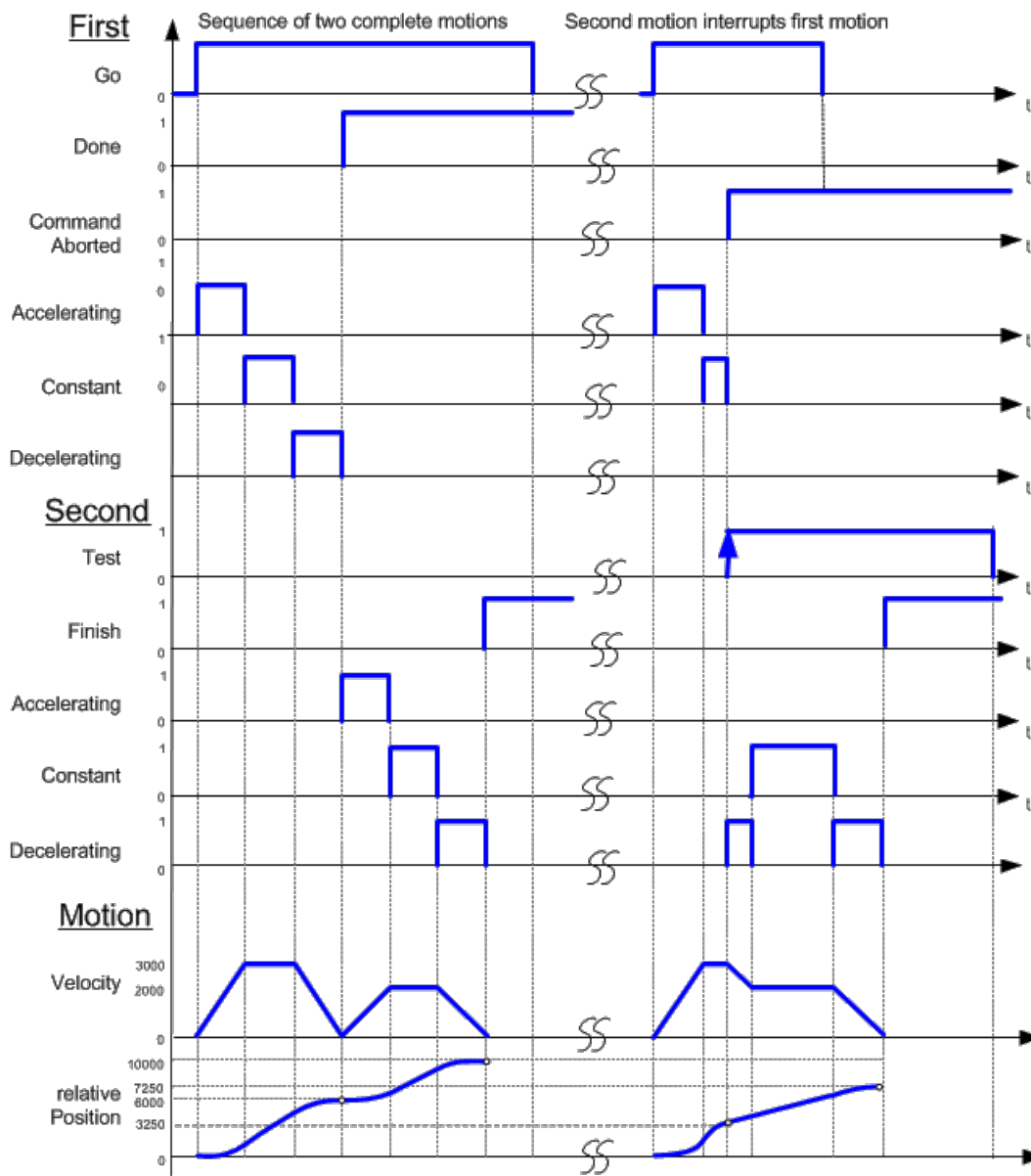

2.2.4.31.3 Arguments

2.2.4.32.4.1 Input

Execute	Description	Requests to queue the move
	Data type	BOOL
	Range	0, 1
	Unit	n/a
	Default	—
Axis	Description	Name of a declared instance of the AXIS_REF library function.
	Data type	AXIS_REF

	Range	[1,256]
	Unit	n/a
	Default	—
Distance	Description	Distance
	Data type	LREAL
	Range	—
	Unit	User unit
	Default	—
Velocity	Description	Velocity setpoint
	Data type	LREAL
	Range	—
	Unit	User unit/sec
	Default	—
Acceleration	Description	Trapezoidal: Acceleration rate S-curve: Maximum acceleration
	Data type	LREAL
	Range	—
	Unit	User unit/sec ²
	Default	—
Deceleration	Description	Trapezoidal: Deceleration rate S-curve: Unused
	Data type	LREAL
	Range	—
	Unit	User unit/sec ²
	Default	—
Jerk	Description	Trapezoidal: 0 S-curve: Constant jerk
	Data type	LREAL
	Range	—
	Unit	User unit/sec ³

	Default	—
BufferMode	Description	0 = abort 1 = buffer 2 = blend to active 3 = blend to next 4 = blend to low velocity 5 = blend to high velocity
	Data type	SINT
	Range	[0,5]
	Unit	n/a
	Default	—

2.2.4.33.5.2 Output

Done	Description	Indicates the move completed successfully. The Command Position has reached the endpoint.
	Data type	BOOL
Busy	Description	High from the moment the Execute input is one-shot to the time the move is ended
	Data type	BOOL
Active	Description	Indicates this move is the active move
	Data type	BOOL
CommandAborted	Description	Indicates the move was aborted
	Data type	BOOL
Error	Description	Indicates an invalid input was specified or the move was terminated due to an error
	Data type	BOOL
ErrorID	Description	Indicates the error if Error output is set to TRUE
	Data type	INT

2.2.4.34.6 Example

2.2.4.35.7.1 Structured Text

```
(* MC_MoveRelative ST example *)
Inst_MC_MoveRelative( MovRelReq, Axis1, 10.0, 200.0,150.0,
150.0, 0,0 );
MovRelDone := Inst_MC_MoveRelative.Done; //store Done output
into user defined variable
```

See also how this function is used in the Hole punch project [here](#)

2.2.4.36.8.2 Ladder Diagram

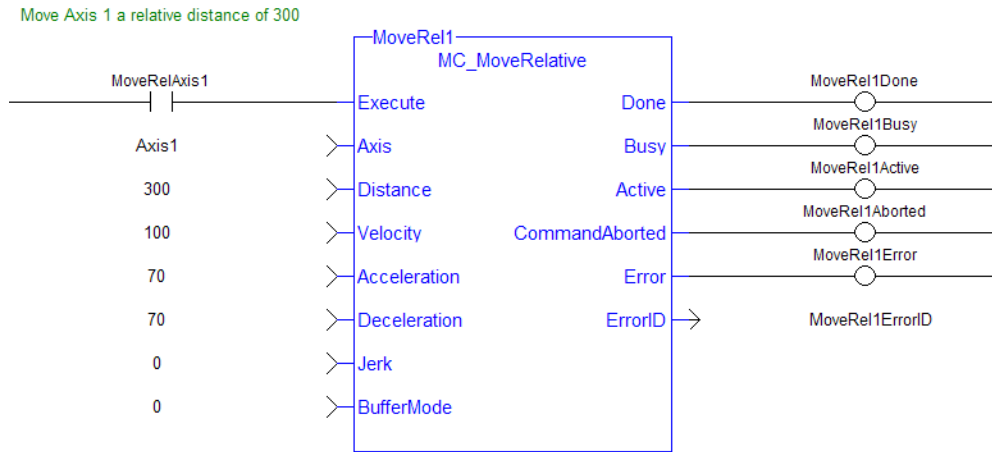

2.2.4.37 MC_MoveSuperimp PLCopen ✓

2.2.4.38.1 Description

This function block provides the ability to cause additional axis motion superimposed upon a currently executing move. A superimposed move is executed like an "MC_MoveRelative" (→ p. 376) move using the specified **Distance**, **Velocity** (i.e. VelocityDiff), **Acceleration**, **Deceleration**, and **Jerk** values. The interpolated command generated by a superimposed move is added to the command of the currently executing move. Subsequent calls to MC_MoveSuperimp can abort or blend to an executing MC_MoveSuperimp move.

This function block provides a way to smoothly apply a shift in axis position while it is executing a move.

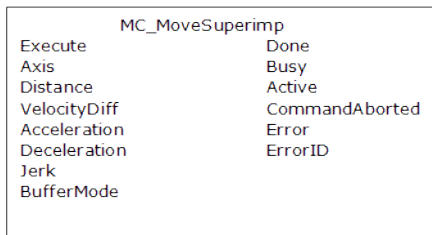
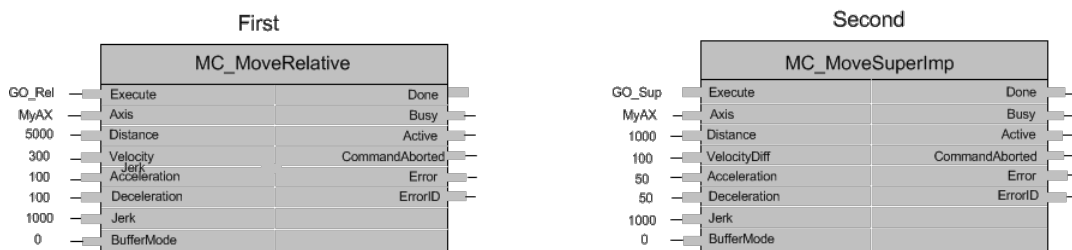
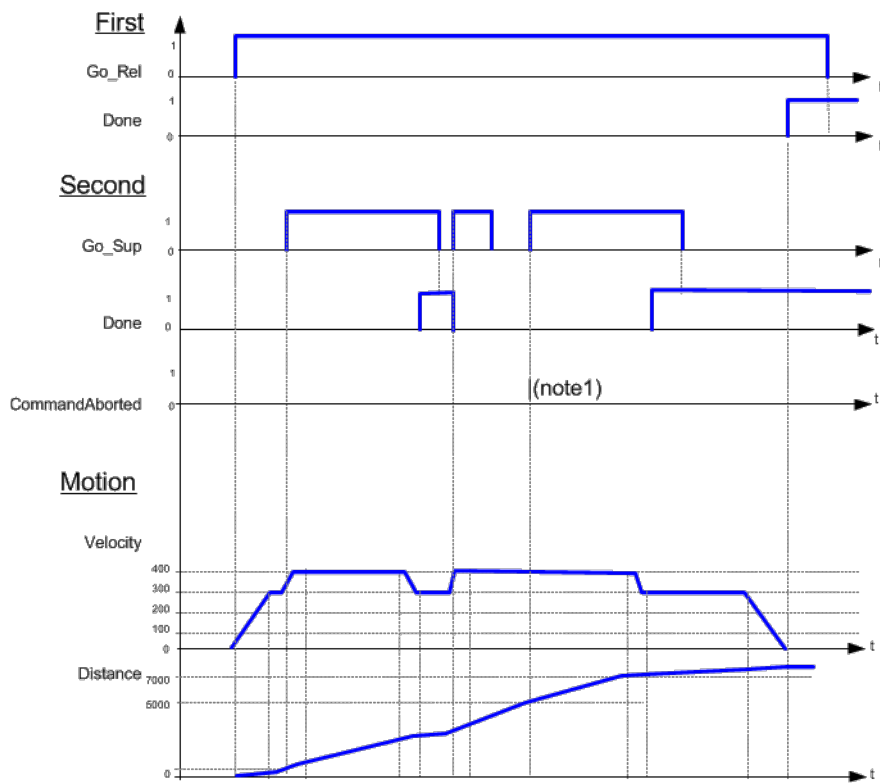

Figure 1-75: MC_MoveSuperimp

2.2.4.39.2 Time Diagram





NOTE

1. The CommandAborted is not visible here, because the new command works on the same instance
2. The end position is between 7000 and 8000, depending on the timing of the aborting of the second command set for the MC_MoveSuperimposed

2.2.4.40.3 Arguments

2.2.4.41.4.1 Input

Execute	Description	Requests to queue the superimposed move
	Data type	BOOL
	Range	0, 1
	Unit	n/a
	Default	—
Axis	Description	Name of a declared instance of the AXIS_REF library function.
	Data type	AXIS_REF
	Range	[1,256]
	Unit	n/a
	Default	—
Distance	Description	Distance

	Data type	LREAL
	Range	—
	Unit	User unit
	Default	—
VelocityDiff	Description	Velocity rate
	Data type	LREAL
	Range	—
	Unit	User unit/sec
	Default	—
Acceleration	Description	Trapezoidal: Acceleration rate S-curve: Maximum acceleration
	Data type	LREAL
	Range	—
	Unit	User unit/sec ²
	Default	—
Deceleration	Description	Trapezoidal: Deceleration rate S-curve: Unused
	Data type	LREAL
	Range	—
	Unit	User unit/sec ²
	Default	—
Jerk	Description	Trapezoidal: 0 S-curve: Constant jerk
	Data type	LREAL
	Range	—
	Unit	User unit/sec ³
	Default	—
BufferMode	Description	<ol style="list-style-type: none"> 0. abort 1. buffer 2. blend to active 3. blend to next 4. blend to low velocity 5. blend to high velocity

Data type	SINT
Range	[0,5]
Unit	n/a
Default	—

2.2.4.42.5.2 Output

Done	Description	Indicates the move completed successfully. The Command Position has reached the endpoint.
	Data type	BOOL
Busy	Description	High from the moment the Execute input is one-shot to the time the move is ended
	Data type	BOOL
Active	Description	Indicates this move is the active superimposed move
	Data type	BOOL
CommandAborted	Description	Indicates the move was aborted
	Data type	BOOL
Error	Description	Indicates an invalid input was specified or the move was terminated due to an error
	Data type	BOOL
ErrorID	Description	Indicates the error if Error output is set to TRUE
	Data type	INT

2.2.4.43.6 Example

2.2.4.44.7.1 Structured Text

```
(* MC_MoveSuperimp ST example *)
Inst_MC_MoveSuperimp( MovSupReq, Axis1, 123.555, 10.0, 100.0,
100.0, 0, 0 );
MovSupDone := Inst_MC_MoveSuperimp.Done; //store Done output
into user defined variable
```

2.2.4.45.8.2 Ladder Diagram

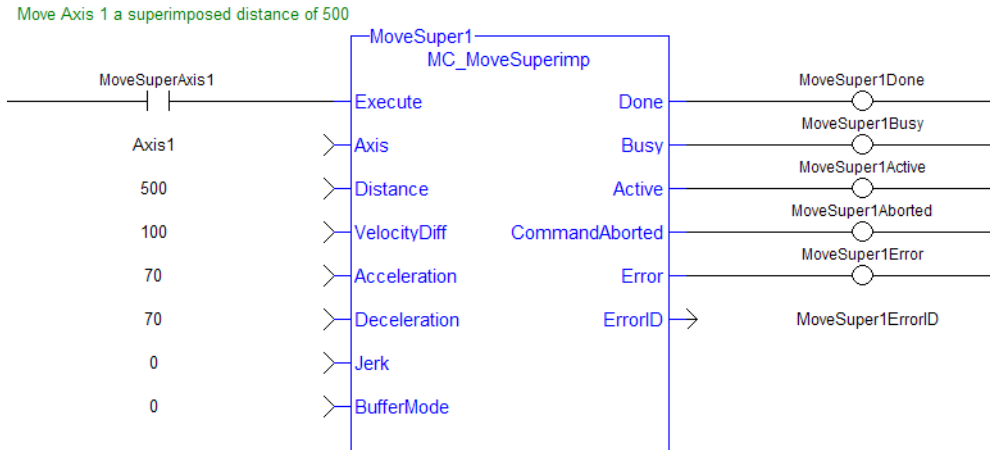

2.2.4.46 MC_MoveVelocity PLCopen ✔

2.2.4.47.1 Description

This function block performs a single-axis non-ending move at a specified velocity. This type of move can be terminated with the MC_Halt function block or by aborting it with another move.

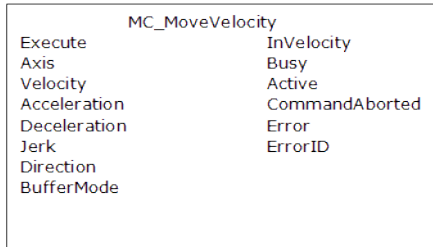

Figure 1-76: MC_MoveVelocity

2.2.4.48.2 Time Diagram

The example below shows the behavior of the combination of a [MC_Stop](#) FB with a MC_MoveVelocity FB.

- A rotating axis is ramped down with FB2 MC_Stop
- The axis rejects motion commands as long as MC_Stop parameter “Execute” = TRUE

FB1 MC_MoveVelocity reports an error indicating the busy MC_Stop command.

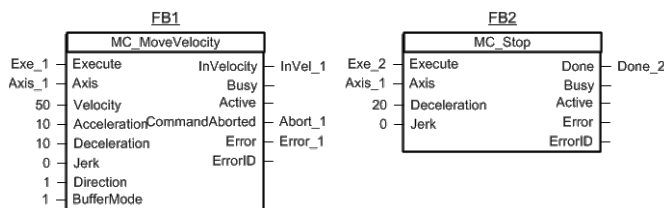

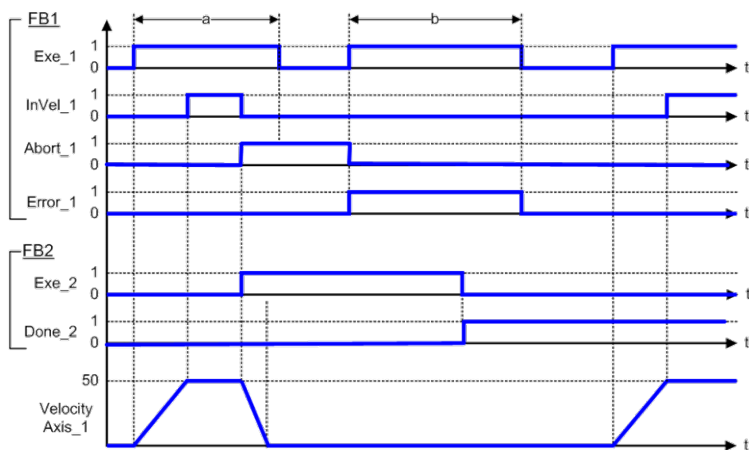

2.2.4.49.3 Arguments

2.2.4.50.4.1 Input

Execute	Description	Requests to queue the move
	Data type	BOOL
	Range	0, 1
	Unit	n/a
	Default	—
Axis	Description	Name of a declared instance of the AXIS_REF library function
	Data type	AXIS_REF
	Range	[1,256]
	Unit	n/a
	Default	—
Velocity	Description	Velocity rate
	Data type	LREAL
	Range	—
	Unit	User unit/sec
	Default	—
Acceleration	Description	Trapezoidal: Acceleration rate S-curve: Maximum acceleration
	Data type	LREAL
	Range	—
	Unit	User unit/sec ²

	Default	—
Deceleration	Description	Trapezoidal: Deceleration rate S-curve: Unused
	Data type	LREAL
	Range	—
	Unit	User unit/sec ²
	Default	—
Jerk	Description	Trapezoidal: 0 S-curve: Constant jerk
	Data type	LREAL
	Range	—
	Unit	User unit/sec ³
	Default	—
Direction	Description	0 = positive direction 1 = negative direction
	Data type	SINT
	Range	[0, 1]
	Unit	n/a
	Default	—
BufferMode	Description	0 = abort 1 = buffer 2 = blend to active 3 = blend to next 4 = blend to low velocity 5 = blend to high velocity
	Data type	SINT
	Range	[0, 5]
	Unit	n/a
	Default	—

2.2.4.51.5.2 Output

InVelocity	Description	Indicates the command velocity has reached the programmed velocity
	Data type	BOOL

Busy	Description	High from the moment the Execute input is one-shot to the time the move is ended
	Data type	BOOL
Active	Description	Indicates this move is the active move
	Data type	BOOL
CommandAborted	Description	Indicates the move was aborted
	Data type	BOOL
Error	Description	Indicates an invalid input was specified or the move was terminated due to an error
	Data type	BOOL
ErrorID	Description	Indicates the error if Error output is set to TRUE
	Data type	INT

2.2.4.52.6 Example

2.2.4.53.7.1 Structured Text

```
(* MC_MoveVelocity ST example *)
Inst_MC_MoveVelocity( MovVelReq , Axis1, 200.0, 100.0,100.0, 0,
0, 0 );
```

2.2.4.54.8.2 Ladder Diagram

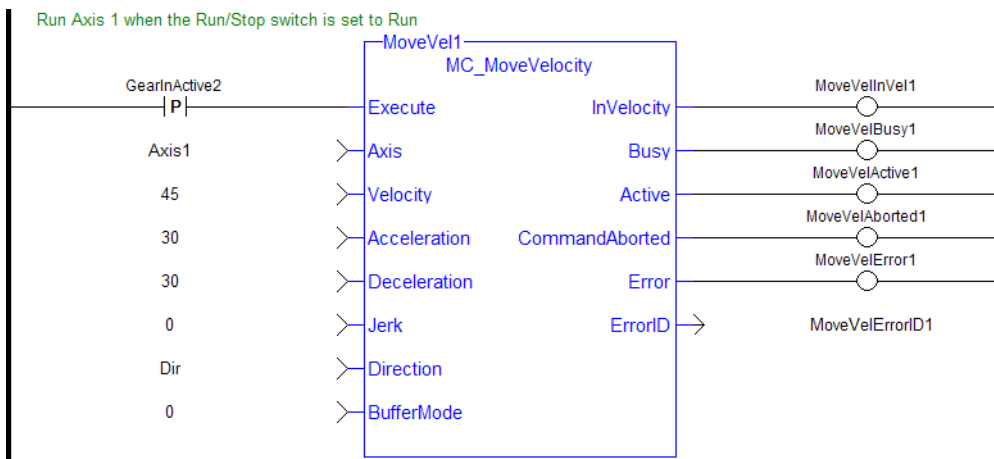

2.2.4.55 MC_SetOverride PLCopen ✓

2.2.4.56.1 Description

This function block writes the velocity override factor. A change in the velocity override factor takes effect immediately on the active move.

The velocity override factor is applied to the programmed velocity (of a "MC_MoveAbsolute" (→ p. 368), "MC_MoveAdditive" (→ p. 373), "MC_MoveRelative" (→ p. 376), "MC_MoveSuperimp" (→ p. 381), or "MC_MoveVelocity" (→ p. 385) function block) to determine the command velocity:

```
command velocity = programmed velocity * VelFactor
```

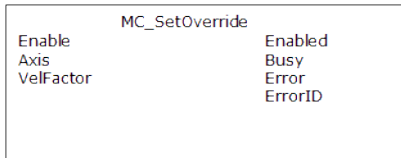

Figure 1-77: MC_SetOverride

2.2.4.57.2 Arguments

2.2.4.58.3.1 Input

Enable	Description	Request to write the override factors
	Data type	BOOL
	Range	0, 1
	Unit	n/a
	Default	—
Axis	Description	Name of a declared instance of the AXIS_REF library function.
	Data type	AXIS_REF
	Range	[1,256]
	Unit	n/a
	Default	—
VelFactor	Description	Velocity override factor
	Data type	REAL
	Range	[0.0, 2.0]
	Unit	n/a
	Default	—

2.2.4.59.4.2 Output

Enabled	Description	Indicates the override values have been written
	Data type	BOOL
Busy	Description	Indicates the function block is executing
	Data type	BOOL
Error	Description	Indicates an invalid input is specified
	Data type	BOOL

ErrorID	Description	Indicates the error if Error output is set to TRUE
	Data type	INT

2.2.4.60.5 Example

2.2.4.61.6.1 Structured Text

```
(* MC_SetOverride ST example *)
VelFactor := 1.25 ; //set the velocity factor to 1.25 (125%)
Inst_MC_SetOverride( TRUE , Axis1, VelFactor ); // Inst_MC_
Setoverride is an instance of MC_SetOverride
```

2.2.4.62.7.2 Ladder Diagram

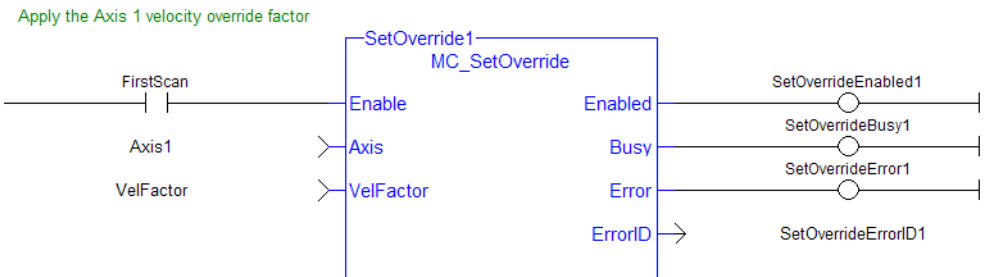

2.2.5 Profile Functions

This set of functions provides commands for slave axes, such as cams and gearing.

2.2.5.1 MC_CamIn PLCopen ✔

2.2.5.2.1 Description

This function block performs a slave axis move which follows the master axis based on the Cam Table specified by CamTableID.

This function block is used to either initiate a new MC_CamIn move or to resume a previously programmed MC_CamIn move. Refer to "MC_CamStartPos" (→ p. 402) and "MC_CamResumePos" (→ p. 400) for information on positioning the slave axis prior to calling MC_CamIn.



Figure 1-78: MC_CamIn

Aborting Camming

There are two common options to stop camming after MC_CamIn has been called.

- "MC_CamOut" (→ p. 397) will continue motion at the instantaneous final actual velocity of the slave axis when it is called, and axis motion will continue at that final actual velocity.
- "MC_Halt" (→ p. 364) (with buffer mode input = 0) will decelerate axis motion to 0 speed and stop motion.

The master / slave relationship between the two axes is ended when MC_CamOut or MC_Halt is called.

NOTE

Ending camming is also possible with other single axis function blocks such as "MC_MoveRelative" (→ p. 376) and "MC_MoveAbsolute" (→ p. 368).

2.2.5.3.2 Arguments

2.2.5.4.3.1 Input

Execute	Description	Requests to queue the CamIn move
	Data type	BOOL
	Range	0, 1
	Unit	n/a
Master	Description	Name of a declared instance of the AXIS_REF library function
	Data type	AXIS_REF
	Range	1 - 256
	Unit	n/a
Slave	Description	AXIS_REF.AXIS_NUM is the slave axis number
	Data type	AXIS_REF
	Range	1-256
	Unit	n/a
MasterOffset	Description	Profile shift along the master axis. This input is not used if the StartMode input is set to 1 for Resume Mode.
	Data type	LREAL
	Range	—
	Unit	User unit
SlaveOffset	Description	Profile shift along the slave axis. This input is not used if the StartMode input is set to 1 for Resume Mode.
	Data type	LREAL

	Range	—
	Unit	User unit
MasterScaling	Description	Master axis profile range. This input is not used if the StartMode input is set to 1 for Resume Mode. Scaling must be a positive value that is greater than 0.
	Data type	LREAL
	Range	—
	Unit	User unit
SlaveScaling	Description	Slave axis profile range. This input is not used if the StartMode input is set to 1 for Resume Mode. Scaling must be a positive value that is greater than 0.
	Data type	LREAL
	Range	—
	Unit	User unit
Startmode	Description	<p>Starting mode of the cam profile. 0 = Start Mode. Start a cam profile move. 1 = Resume Mode. Resume the most recent MC_CamIn move.</p> <p>This input indicates whether the axis should start a MC_CamIn move as an initial cam start (StartMode = 0) or if the axis should resume the most recently programmed MC_CamIn move (StartMode = 1).</p> <p>It should be noted that in the case of Resume Mode (StartMode = 1) that the inputs MasterOffset, SlaveOffset, MasterScaling, and SlaveScaling are not used. The function block will use the values that were in effect during the most recently programmed MC_CamIn move for the slave axis.</p>
	Data type	INT
	Range	[0,1]
	Unit	n/a
CamTableID	Description	ID number of the profile to be used with MC_CamIn
	Data type	INT
	Range	—
	Unit	n/a
BufferMode	Description	Buffer mode for CamIn block.
	Data type	SINT

Range	0-5
Unit	n/a

2.2.5.5.4.2 Output

InSync	Description	Indicates the slave axis is in sync with the profile
	Data type	BOOL
	Range	0, 1
	Unit	n/a
Busy	Description	Indicates this function block is executing
	Data type	BOOL
	Range	0, 1
	Unit	n/a
Active	Description	Indicates this move is the Active move
	Data type	BOOL
	Range	0, 1
	Unit	n/a
CommandAborted	Description	Indicates the move was aborted
	Data type	BOOL
	Range	0, 1
	Unit	n/a
Error	Description	Indicates an invalid input, or the move was terminated due to an error
	Data type	BOOL
	Range	0, 1
	Unit	n/a
ErrorID	Description	Indicates the error if the Error output is high.
	Data type	INT
	Range	—
	Unit	n/a

EndOfProfile	Description	Indicates the end of profile has been reached. If the profile is periodic this output is set to ON for one ladder scan. If the profile is not periodic, the output remains ON while outside the range of the profile.
	Data type	BOOL
	Range	0, 1
	Unit	n/a

2.2.5.6.5 Usage

The slave axis immediately locks on to the Cam Table profile.

The **Master Offset** is used to shift the profile along the master axis.

The **Master Scaling** defines the range of the profile along the master axis.

The **Slave Offset** is used to shift the profile along the Slave axis.

The **Slave Scaling** defines the range of the profile along the slave axis.

If the profile is periodic, when the end of profile reached, the profile continues at the start of the profile. The EndOfProfile output is ON for 1 ladder scan.

If the profile is not periodic, when the end of profile is reached, the slave axis stops and remains at the end of the profile until the master axis returns to within the profile range as defined by MasterScaling. The EndOfProfile output remains ON anytime the master axis is outside of the profile range.

Adjustments computation is done as follows:

When cam is first started, offsets are adjusted if necessary

- If slave is not absolute, then slave offset = slave offset + starting position
- If master is not absolute, then master offset = master offset + starting position.

At run-time

- Master position for profile = master position - master offset
- Use master position for profile table to obtain slave profile position
- Slave commanded position = slave profile position + slave offset

2.2.5.7.6 Related Functions

"MC_CamResumePos" (→ p. 400)

"MC_CamStartPos" (→ p. 402)

[MC_CamTblSelect](#)

[MC_CamOut](#)

2.2.5.8.7 Examples

2.2.5.9.8.1 Structured Text

```
(* MC_CamIn ST example *) //Inst_MC_CamIn is an instance of MC_CamIn
Inst_MC_CamIn( CamStartBool, Axis1, Axis2, 0.0, 0.0, 360.0,
360.0, 0, CamTableID, 0 );
```

2.2.5.10.9.2 Ladder Diagram

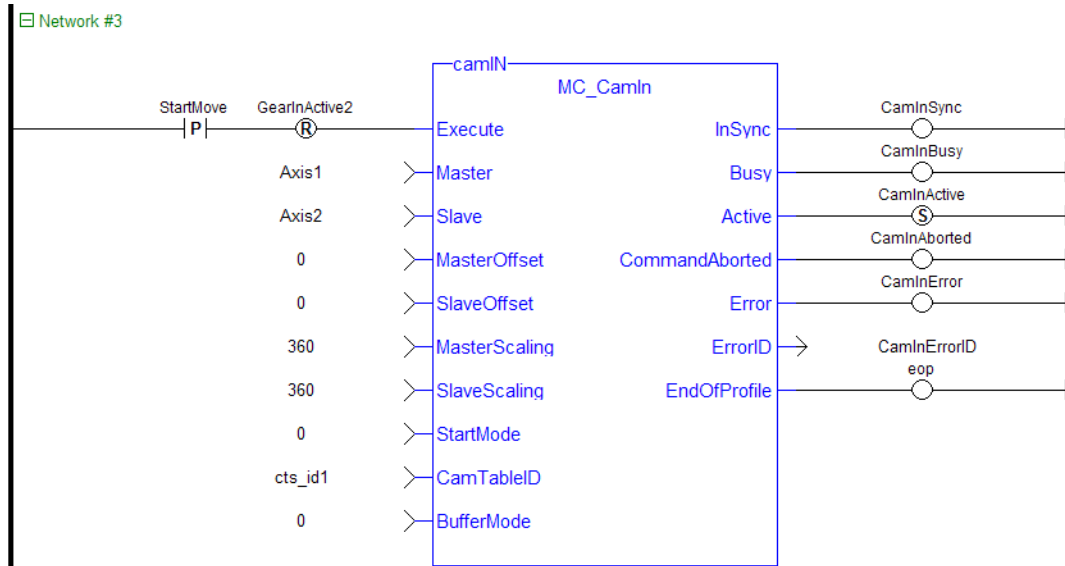

The three following examples utilizes the screen shot below showing the cam profile “MyProfile”

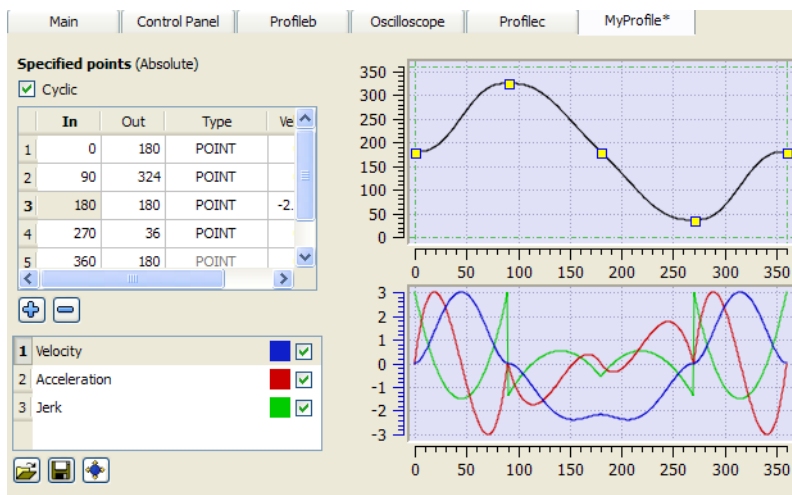
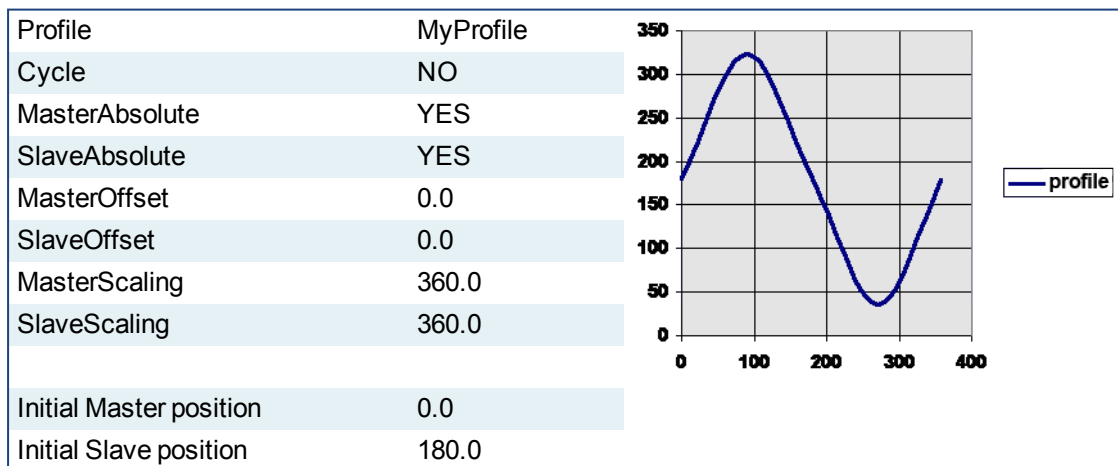

Figure 1-79: MC_CamIn examples

2.2.5.11.10.3 Example 1



After MC_CamTblSelect and MC_CamIn are programmed with the above parameters, the slave axis is locked on to the profile. Since both have zero offsets, the profile is not shifted in either axis. The initial condition of the master axis at position 0, yields a slave command position of 180.0. As the master axis

moves positive, the slave position follows the profile. When the master position is at 90.0, the slave is commanded to 324.0 (see curve below where in = 90, out = 324). The slave follows the profile as the master axis moves until the master axis reaches a position of 360.0. At this time the slave is commanded to 180.0.

If the master were to continue to move past 360.0 the slave commanded position would remain at 180.0 since the Cyclic input is false. If the master moves negative and its position returns to less than 360.0, then the slave follows the profile again.

2.2.5.12.11.4 Example 2

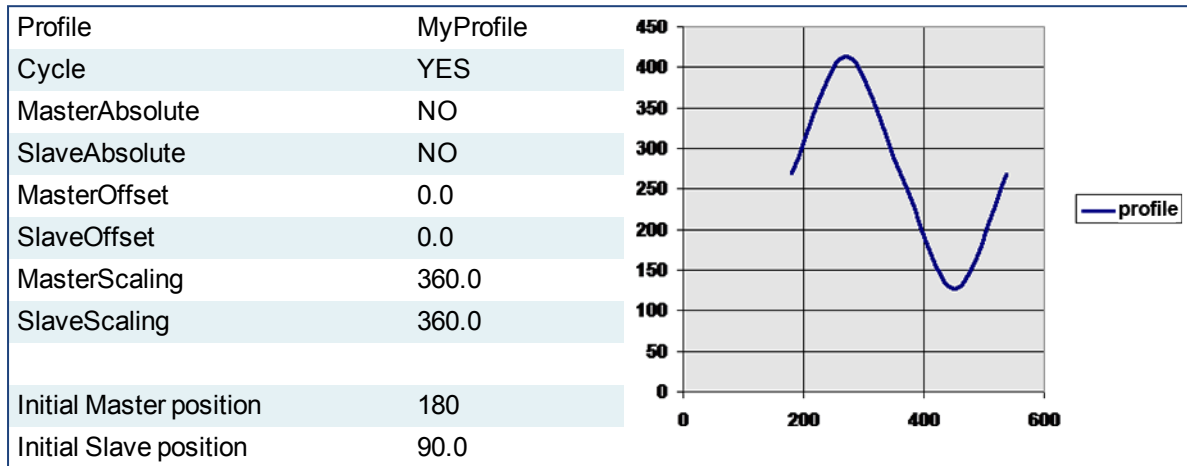

After MC_CamTblSelect and MC_CamIn are programmed with the above parameters, the slave axis is locked on to the profile. Since the both axes have zero offsets, the profile is not shifted in either axis. Neither the *MasterAbsolute* nor *SlaveAbsolute* input is on, so the profile is relative to the axes initial positions. Specifically, the initial condition of the master axis at position 180 would represent a master profile position of 0 (180-180). This yields a slave command position of 270 (180 + 90). As the master axis moves positive, the slave position follows the profile. When the master position is at 270, the slave is commanded to 414.0 (324 + 90). The slave follows the profile as the master axis moves until the master axis reaches a position of 540. At this time the slave is commanded to 270.0 (180 + 90).

If the master continues to move past 540.0, the slave commanded position follows the profile from the beginning since the Cyclic input is TRUE. When the master reaches a position of 630, the slave is commanded to a position of 414.0 (324 + 90).

2.2.5.13.12.5 Example 3

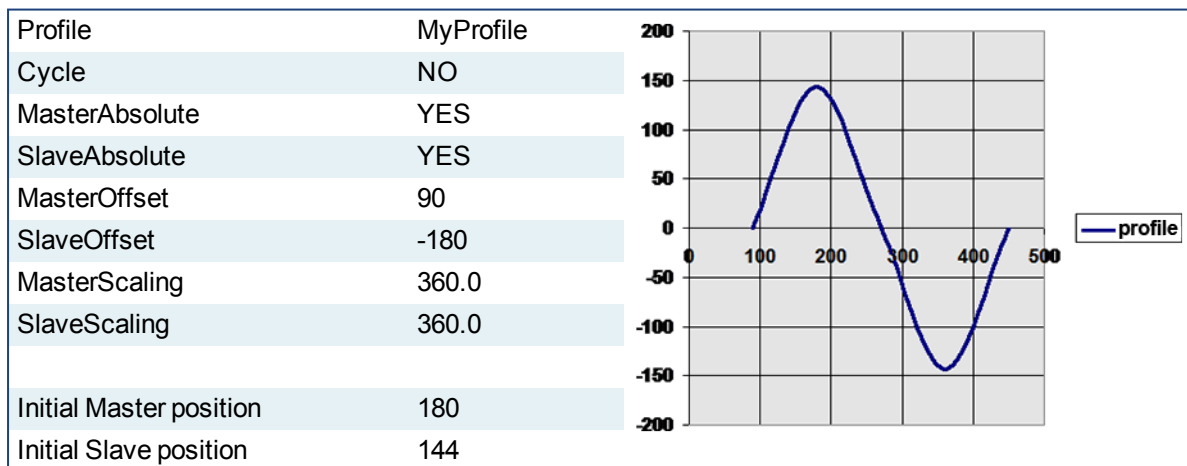

After MC_CamTblSelect and MC_CamIn are programmed with the above parameters, the slave axis is locked on to the profile. Since the both axes have offsets, the profile is shifted along both axes. Specifically the master axis is shifted 90, and the slave axis is shifted -180. Initially the master axis position of 180 yields a master position for the profile calculation of 90 (master position 180 - Master offset 90), which yields a slave command position of 144 (slave profile command 324 + slave offset (-180)). As the master axis moves

positive, the slave position follows the profile. When the master axis position is at 270, the master position for profile calculation is 180 (270 - 90). This yields a slave command position of 0 (180 + (-180)).

The slave follows the profile as the master axis moves until the master axis reaches a position of 450. The master axis position of 450 yields a master position for profile calculation of 360 (450 - 90). The slave command position is 0 (180 + (-180)).

When the master reaches a position of 450, the slave commanded position remains at 0 since the Cyclic input is false.

2.2.5.14 MC_CamOut

2.2.5.15.1 Description

This function block:

- aborts the active MC_CamIn move
- disengages the axis from its master
- and commands the axis to continue at its current velocity

TIP

The current velocity is calculated by taking the average of the actual velocity during the previous 16 cycles.

Like a MC_MoveVelocity move, the control continues to command the axis to move at this velocity until this MC_CamOut move is aborted. If this function block is called and the active move is not a MC_CamIn move, this function block returns an error and the active move is not aborted.

TIP

As an alternative method to cancel the cam motion, a single axis move ("MC_MoveAbsolute" (→ p. 368), "MC_MoveRelative" (→ p. 376), "MC_MoveAdditive" (→ p. 373), "MC_MoveVelocity" (→ p. 385), and "MC_Halt" (→ p. 364)) with the **buffermode** input set to **0** can be called. This will cancel the "MC_CamIn" (→ p. 390) function and start the new motion function on the slave axis. Many applications prefer calling MC_Halt instead of MC_CamOut because it will not send a velocity command to the slave axis.

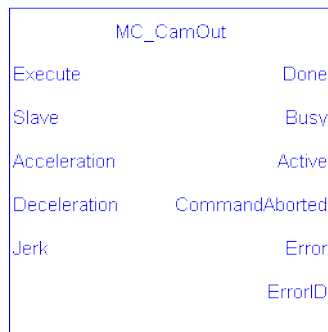

Figure 1-80: MC_CamOut

2.2.5.16.2 Arguments

2.2.5.17.3.1 Input

Execute	Description	Requests to queue the CamOut move
	Data type	BOOL
	Range	0, 1
	Unit	n/a

	Default	—
Slave	Description	Name of a declared instance of the AXIS_REF library function
	Data type	AXIS_REF
	Range	1 – 256
	Unit	n/a
	Default	—
Acceleration	Description	Trapezoidal: Acceleration rate S-curve: Maximum acceleration
	Data type	LREAL
	Range	—
	Unit	User unit/sec ²
	Default	—
Deceleration	Description	Trapezoidal: Deceleration rate S-curve: Unused
	Data type	LREAL
	Range	—
	Unit	User unit/sec ²
	Default	—
Jerk	Description	Trapezoidal: 0 S-curve: Constant jerk
	Data type	LREAL
	Range	—
	Unit	User unit/sec ³
	Default	—

2.2.5.18.4.2 Output

Done	Description	Indicates the axis is disengaged from its master
	Data type	BOOL
	Range	0, 1
	Unit	n/a
Busy	Description	Indicates this function block is executing

	Data type	BOOL
	Range	0, 1
	Unit	n/a
Active	Description	Indicates this move is the Active move
	Data type	BOOL
	Range	0, 1
	Unit	n/a
CommandAborted	Description	Indicates the move was aborted
	Data type	BOOL
	Range	0, 1
	Unit	n/a
Error	Description	Indicates an invalid input was specified or no MC_CamIn move was active
	Data type	BOOL
	Range	0, 1
	Unit	n/a
ErrorID	Description	Indicates the error if the Error output is high
	Data type	INT
	Range	—
	Unit	n/a

2.2.5.19.5 Usage

This function block disengages the slave axis from a MC_CamIn move and then leaves the axis running at its current velocity. The axis continues to run at this velocity until this move is aborted.

2.2.5.20.6 Related Functions

[MC_CamIn](#)

[MC_CamTblSelect](#)

2.2.5.21.7 Example

2.2.5.22.8.1 Structured Text

```
(* MC_CamOut ST example *)
Inst_MC_CamOut
(ExecCamOut1, Axis1, CamOut1Acc, CamOut1Dec, CamOut1Jerk);
//Inst_MC_CamOut is an instance of MC_CamOut
```

2.2.5.23.9.2 Ladder Diagram

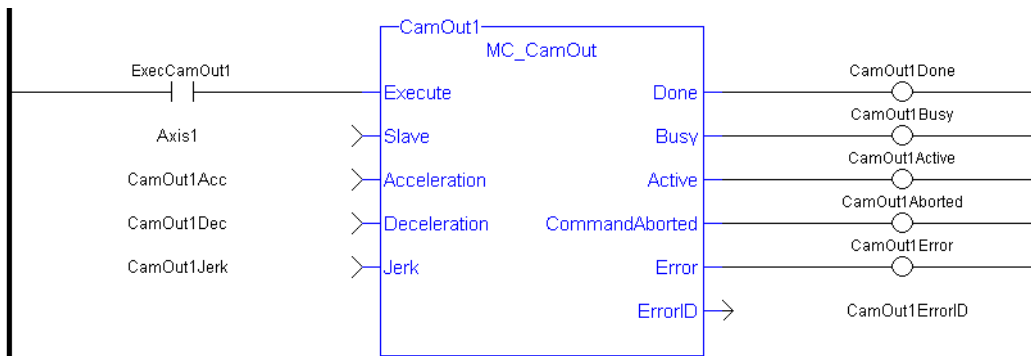

See also [MC_CamIn](#) for examples.

2.2.5.24 MC_CamResumePos PLCopen

2.2.5.25.1 Description

This function block returns the slave axis position for the most recently executed "MC_CamIn" (→ p. 390) profile, based on the current position of the master axis. This slave axis position can be used to command the slave axis to return to the proper location prior to resuming a MC_CamIn function. When calculating the slave axis position, MC_CamResumePos will utilize the master offset, slave offset, master scaling, and slave scaling of the most recently executed MC_CamIn function block for the slave axis.

The typical application of MC_CamResumePos is to aid in returning a slave axis back to its profile position after an event (e.g. E-stop) caused the slave axis to go off path. See Resuming Camming After an E-Stop for complete instructions.

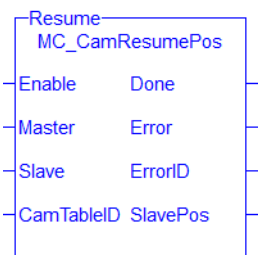

Figure 1-81: MC_CamStartPos

2.2.5.26.2 Related Functions

"MC_CamIn" (→ p. 390)

"MC_CamStartPos" (→ p. 402)

2.2.5.27.3 Arguments

2.2.5.28.4.1 Inputs

Enable	Description	Enables execution of the function block
	Data Type	BOOL
	Range	n/a
	Units	n/a
	Default	—
Master	Description	Master axis. This must be the same as the Master Axis specified for the most recently executed MC_CamIn function block.
	Data Type	AXIS_REF
	Range	[1,256] for .AXIS_NUM
	Units	n/a
	Default	—
Slave	Description	Slave axis. This must be the same as the Slave Axis specified for the most recently executed MC_CamIn function block.
	Data Type	AXIS_REF
	Range	[1,256] for .AXIS_NUM
	Units	n/a
	Default	—
CamTableID	Description	Profile ID number. This value was generated by "MC_CamTblSelect" (→ p. 406). This must be the same as the CamTableID specified for the most recently executed MC_CamIn function block.
	Data Type	INT
	Range	[0,255]
	Units	n/a
	Default	—

2.2.5.29.5.2 Outputs

Done	Description	TRUE = the function block has successfully calculated the slave position. The slave position is available at the SlavePos output.
	Data Type	BOOL
	Units	n/a

Error	Description	TRUE = an invalid input was specified or an error occurred in the calculations. The value at the SlavePos output is undefined.
	Data Type	BOOL
	Units	n/a
ErrorID	Description	Indicates the error if Error output is set to TRUE. See table in PLCopen Function Block ErrorID Output
	Data Type	INT
	Units	n/a
SlavePos	Description	If the Done output is TRUE, this output returns the position for the slave axis given the profile, the current master axis position, and the previously programmed master and slave offsets and scaling.
	Data Type	LREAL
	Units	User Units

2.2.5.30.6 Examples

2.2.5.31.7.1 ST

```
Inst_MC_CamStartPos( TRUE, Axis1, Axis2, Profile1CamTableID);
```

2.2.5.32.8.2 IL

```
CAL Inst_MC_CamResumePos( TRUE, Axis1, Axis2, Profile1CamTable ID)
```

2.2.5.33.9.3 FBD

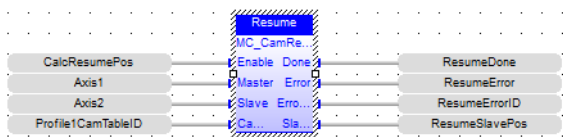

2.2.5.34.10.4 FFLD

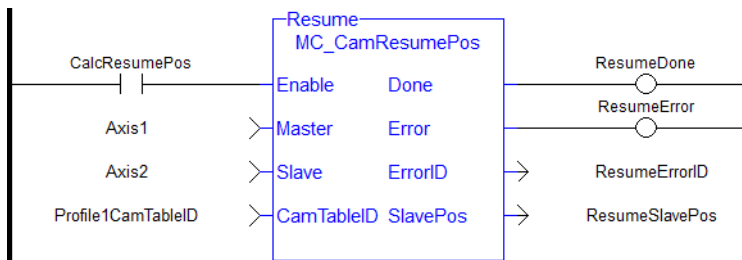

2.2.5.35 MC_CamStartPos PLCopen ✔

2.2.5.36.1 Description

This function block returns the slave axis position for the specified profile, based on the current position of the master axis. This slave axis position can be used to command the slave axis to move to the proper location prior to commanding a "MC_CamIn" (→ p. 390) move with StartMode = 0 (Start mode).

The typical application of MC_CamStartPos is to aid in positioning a slave axis to its starting position for a MC_CamIn move with a slave absolute profile. See Positioning an Axis Before Starting Camming for complete instructions.

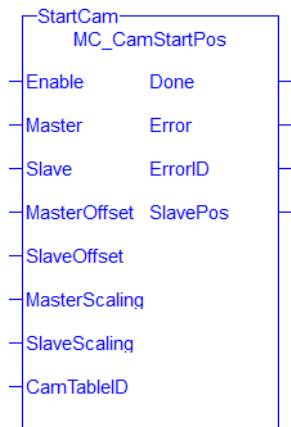

Figure 1-82: MC_CamStartPos

2.2.5.37.2 Arguments

2.2.5.38.3.1 Inputs

Enable	Description	Enables execution of the function block
	Data Type	BOOL
	Range	n/a
	Units	n/a
	Default	—
Master	Description	Master axis
	Data Type	AXIS_REF
	Range	[1,256] for .AXIS_NUM
	Units	n/a
	Default	—
Slave	Description	Slave axis
	Data Type	AXIS_REF
	Range	[1,256] for .AXIS_NUM
	Units	n/a
	Default	—

MasterOffset	Description	Master axis offset
	Data Type	LREAL
	Range	—
	Units	User Units
	Default	—
SlaveOffset	Description	Slave axis offset
	Data Type	LREAL
	Range	—
	Units	User Units
	Default	—
MasterScaling	Description	Master axis scale factor. Scaling must be a positive value that is greater than 0.
	Data Type	LREAL
	Range	—
	Units	User Units
	Default	—
SlaveScaling	Description	Slave axis scale factor. Scaling must be a positive value that is greater than 0.
	Data Type	LREAL
	Range	—
	Units	User Units
	Default	—
CamTableID	Description	Profile ID number. This number was generated by "MC_CamTblSelect" (→ p. 406).
	Data Type	INT
	Range	[0,255]
	Units	n/a
	Default	—

2.2.5.39.4.2 Outputs

Done	Description	TRUE = the function block has successfully calculated the slave position. The slave position is available at the SlavePos output.
	Data Type	BOOL
	Units	n/a
Error	Description	TRUE = an invalid input was specified or an error occurred in the calculations. The value at the SlavePos output is undefined.
	Data Type	BOOL
	Units	n/a
ErrorID	Description	Indicates the error if Error output is set to TRUE. See table in PLCopen Function Block ErrorID Output
	Data Type	INT
	Units	n/a
SlavePos	Description	If the Done output is TRUE, this output returns the position for the slave axis given the profile and the current master axis position.
	Data Type	LREAL
	Units	User Units

2.2.5.40.5 Examples

2.2.5.41.6.1 ST

```
Inst_MC_CamStartPos( TRUE, Axis1, Axis2, MasterOffset,
SlaveOffset, MasterScale, SlaveScale, Profile1CamTableID);
```

2.2.5.42.7.2 IL

```
CAL Inst_MC_CamStartPos( TRUE, Axis1, Axis2, MasterOffset,
SlaveOffset, MasterScale, SlaveScale, Profile1CamTable ID)
```

2.2.5.43.8.3 FBD

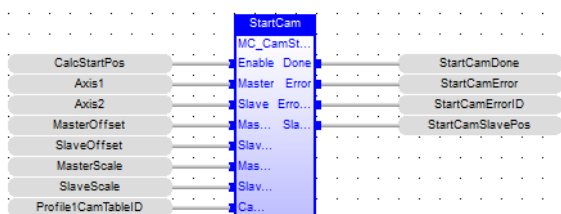

2.2.5.44.9.4 FFLD

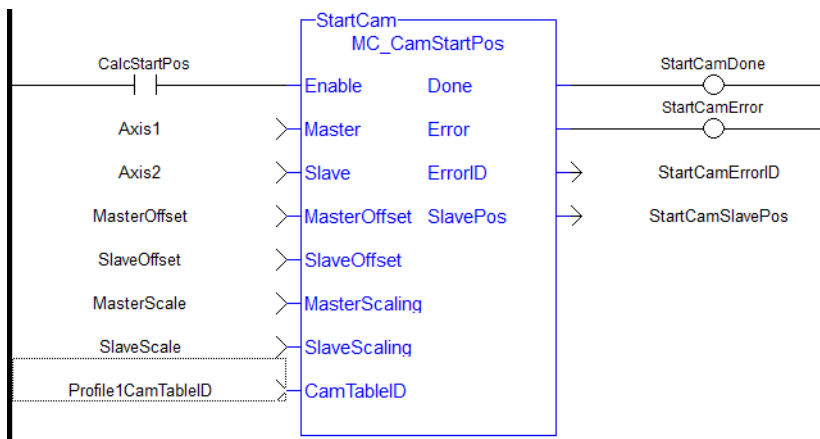

2.2.5.45 MC_CamTblSelect PLCopen ✓

2.2.5.46.1 Description

This Function Block is defined to read and initialize the specified profile, returning an ID to be used with MC_CamIn function block.

2.2.5.47.2 Arguments

2.2.5.48.3.1 Input

Execute	Description	Requests to queue the slave gear ratio move
	Data type	BOOL
	Range	0, 1
	Unit	n/a
	Default	—
CamTable	Description	Profile name as defined in the CAM Profile Properties dialog
	Data type	STRING
	Range	—
	Unit	n/a
	Default	—
Periodic	Description	Selects if the profile is periodic (see also Usage section)
	Data type	BOOL
	Range	0, 1
	Unit	n/a
	Default	—

MasterAbsolute	Description	Selects if master profile is absolute or relative (see also Usage section)
	Data type	BOOL
	Range	0, 1
	Unit	n/a
	Default	—
SlaveAbsolute	Description	Selects if Slave profile is absolute or relative (see also Usage section)
	Data type	BOOL
	Range	0, 1
	Unit	n/a
	Default	—

2.2.5.49.4.2 Output

Done	Description	Indicates the function block has completed successfully
	Data type	BOOL
	Range	0, 1
	Unit	n/a
Busy	Description	Indicates this function block is executing
	Data type	BOOL
	Range	0, 1
	Unit	n/a
Error	Description	Indicates an invalid input was specified
	Data type	BOOL
	Range	0, 1
	Unit	n/a
ErrorID	Description	Indicates the error if the Error output is high
	Data type	INT
	Range	—
	Unit	n/a

CamTableID	Description	Indicates the ID number of the profile to be used with MC_CamIn
	Data type	INT
	Range	0 - 255
	Unit	n/a

2.2.5.50.5 Usage

- Each positive transition of the **Enable** input will create a unique Cam ID and store the profile information in a table. The number of unique Cam IDs is limited to 256. If the application attempts to create more than 256 Cam IDs, the **Error** output will be true and the **ErrorID** output will be 22 (Too Many Profiles). It is only necessary to call MC_CamTblSelect once for each Profile/Periodic/MasterAbsolute/SlaveAbsolute configuration to be used.
- The **Periodic** input selects if the profile is to repeat each cycle. If the profile is not periodic and the master axis moves beyond the profile range, the slave stops at the end of the profile.

NOTE

If the master axis moves back into the profile range, the slave resumes following the profile.

- If the **MasterAbsolute** input is ON, the profile is in reference to the Master axis position. If the MasterAbsolute input is OFF, the profile is in reference to the Master axis position at the time the MC_CamIn function block is executed.
- Similarly, the **SlaveAbsolute** input selects if the slave positions are in reference to the Slave axis position or the Slave axis position at the time the MC_CamIn function block is executed.

TIP

If the SlaveAbsolute input is set to TRUE, the axis jumps back to the starting position. If you set this input to FALSE, the axis will no longer jump back; but rather, as the profile repeats, the slave moves relative to the start of each period.

2.2.5.51.6 Related Functions

[MC_CamIn](#)

[MC_CamOut](#)

2.2.5.52.7 Example

2.2.5.53.8.1 Structured Text

```
(* MC_CamTblSelect ST example *) //call this function block
every scan until "Done"
Inst_MC_CamTblSelect(DoSelect, 'Profileb', TRUE, TRUE, TRUE );
//Inst_MC_CamTblSelect is instance of MC_CamTblSelect
CamSelDone := Inst_MC_CamTblSelect.Done; //store Done output to
user defined variable
IF CamSelDone = TRUE THEN//when function block is "done" store
CamTableID := Inst_MC_CamTblSelect.CamTableID; //CamTableID in
user defined variable
END_IF;
```

See also how this function is used in the Hole punch project [here](#)

2.2.5.54.9.2 Ladder Diagram

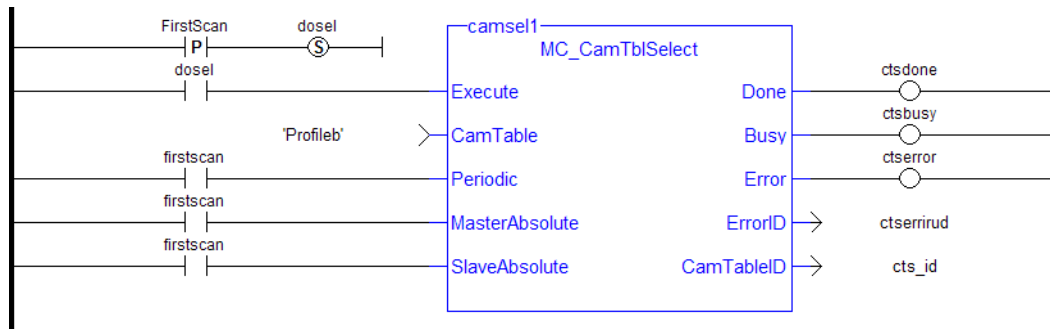

See also [MC_CamIn](#) for examples.

2.2.5.55 MC_GearIn PLCopen ✔

2.2.5.56.1 Description

This function block performs a slave axis move which follows the master axis based on the ratio specified by RatioNumerator and RatioDenominator.

$$\text{SlaveCommandPosition} = \text{MasterActualPosition} * \text{RatioNumerator} / \text{RatioDenominator}$$

When this command is executed, the slave axis accelerates or decelerates (using the Acceleration, Deceleration, and Jerk) to the target velocity determined by the master axis velocity and the ratio. When the slave axis reaches a velocity within the [“In Gear” bandwidth](#) around the target velocity, it locks on to the master, and the InGear output goes high. When the slave is locked to the master, the slave motion is no longer affected by the acceleration, deceleration, and jerk inputs.

For example if the “In Gear” bandwidth is set to 0.1 User Units per second, the InGear output will turn on if the slave velocity is within +/- 0.1 User Units per second of the target velocity.

The slave axis then continues to follow the master axis until this move is aborted.

Aborting Gearing

Gearing functions can generate large accelerations while following the master. If the aborting function block has small, non-zero Jerk, or small acceleration values, it can take a long time for an accelerating axis to reach the target velocity, or position of the aborting function block. If the Jerk and/or acceleration of the aborting function cannot be increased to suitable values, it may be desirable to:

- Abort the gearing function with an "MC_GearOut" (→ p. 419) with higher accelerations and/or Jerk values (or zero jerk value),
- Execute the next MC motion function block such as "MC_Halt" (→ p. 364).

Time to Reach the Target Velocity

While following the master, gearing functions can generate large accelerations. If the gearing function is aborted while the axis is currently accelerating, and the aborting function block has small non-zero Jerk or small acceleration values, it can take a long time to reach the target velocity, or position of the aborting function block. If the Jerk and/or acceleration of the aborting function cannot be increased to suitable values, it may be desirable to:

- Abort the gearing function with an [MC_GearOut](#) with higher accelerations and/or Jerk values (or zero jerk value),
- Execute the next MC motion function block such as "MC_Halt" (→ p. 364).

MC_GearIn	
Execute	InGear
Master	Busy
Slave	Active
RatioNumerator	CommandAborted
RatioDenominator	Error
Acceleration	ErrorID
Deceleration	
Jerk	
BufferMode	

Figure 1-83: MC_GearIn

2.2.5.57.2 Time Diagram

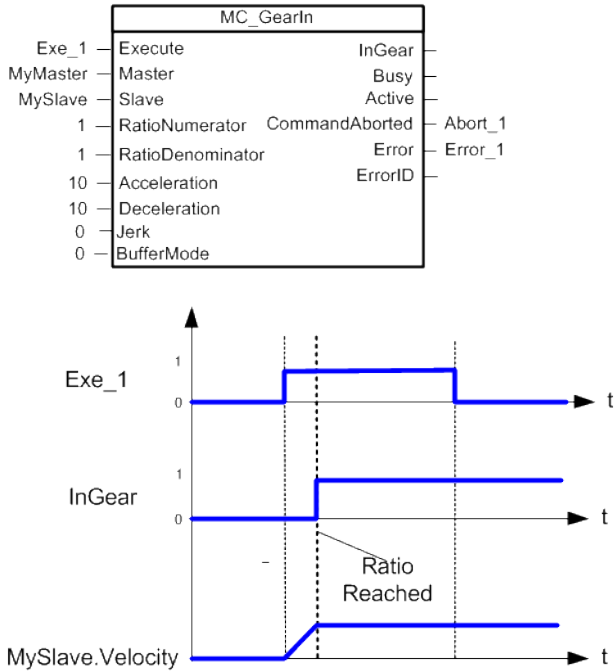

2.2.5.58.3 Arguments

2.2.5.59.4.1 Input

Execute	Description	Requests to queue the slave gear ratio move
	Data type	BOOL
	Range	0, 1
	Unit	n/a
	Default	—
Master	Description	Name of a declared instance of the AXIS_REF library function
	Data type	AXIS_REF
	Range	[1,256]
	Unit	n/a

	Default	—
Slave	Description	AXIS_REF.AXIS_NUM is the slave axis number
	Data type	AXIS_REF
	Range	[1,256]
	Unit	n/a
	Default	—
RatioNumerator	Description	Numerator of master/slave ratio
	Data type	DINT
	Range	[-2147483648, 2147483647]
	Unit	n/a
	Default	—
RatioDenominator	Description	Denominator of master/slave ratio
	Data type	DINT
	Range	[-2147483648, 2147483647]
	Unit	n/a
	Default	—
Acceleration	Description	Trapezoidal: Acceleration rate S-curve: Maximum acceleration
	Data type	LREAL
	Range	—
	Unit	User unit/sec ²
	Default	—
Deceleration	Description	Trapezoidal: Deceleration rate S-curve: Unused
	Data type	LREAL
	Range	—
	Unit	User unit/sec ²
	Default	—
Jerk	Description	Trapezoidal: 0 S-curve: Constant jerk

	Data type	LREAL
	Range	—
	Unit	User unit/sec ³
	Default	—
BufferMode	Description	0 = abort 1 = buffer
	Data type	SINT
	Range	[0,1]
	Unit	n/a
	Default	—

2.2.5.60.5.2 Output

InGear	Description	Indicates the slave axis is locked on to the master axis
	Data type	BOOL
Busy	Description	High from the moment the Execute input goes high until the time the move is ended
	Data type	BOOL
Active	Description	Indicates this move is the Active move
	Data type	BOOL
CommandAborted	Description	Indicates the move was aborted
	Data type	BOOL
Error	Description	Indicates an invalid input was specified or the move was terminated due to an error
	Data type	BOOL
ErrorID	Description	Indicates the error if Error output is set to TRUE
	Data type	INT

2.2.5.61.6 Example

2.2.5.62.7.1 Structured Text

```
(* MC_GearIn ST example *)
Inst_MC_GearIn( GearInReq, Axis1, Axis2, 2, 1, 150.0, 150.0, 0, 0 );
//Inst_MC_GearIn is an instance of MC_GearIn
```

See also how this function is used in the Hole punch project [here](#)

2.2.5.63.8.2 Ladder Diagram

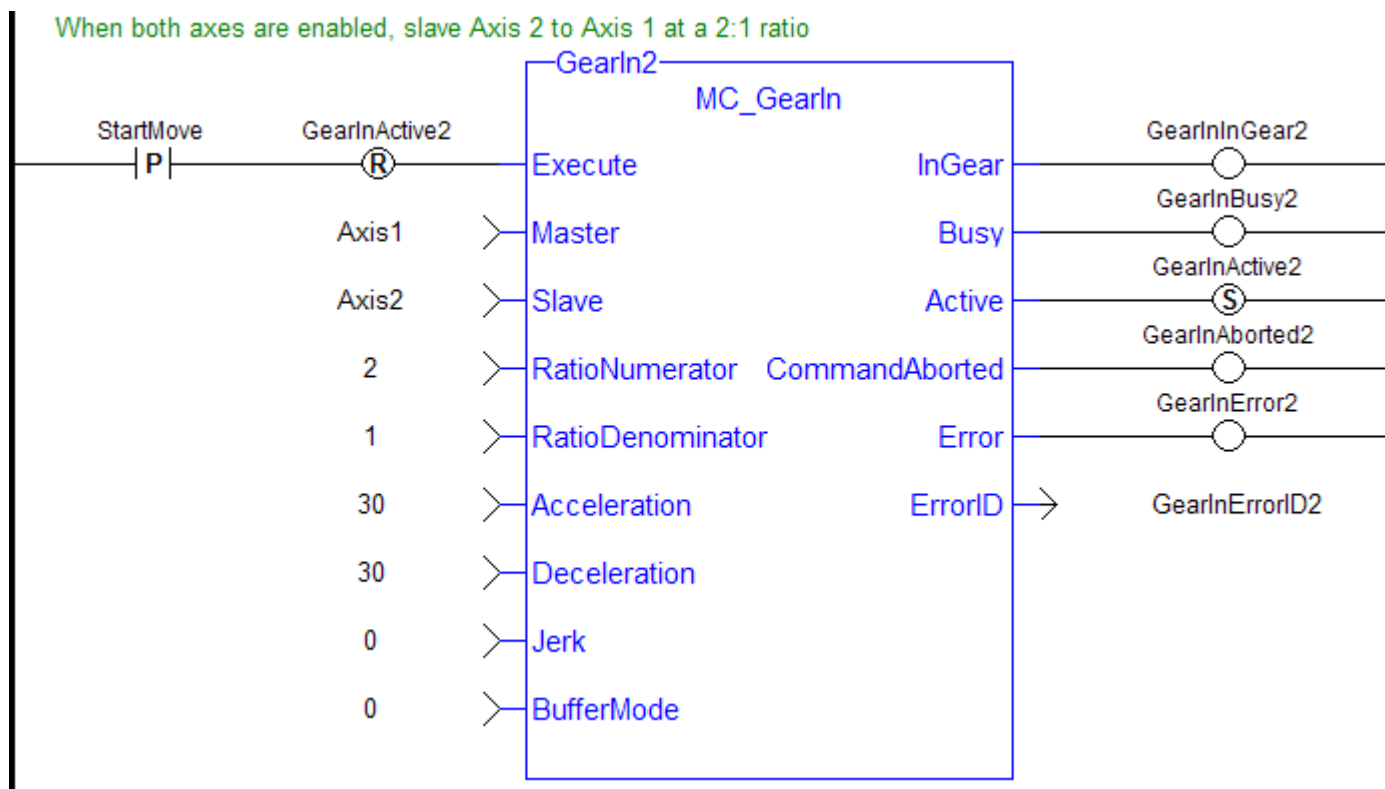

2.2.5.64 MC_GearInPos PLCopen ✓

2.2.5.65.1 Description

This function block performs a slave axis move which follows the master axis based on the ratio specified by RatioNumerator and RatioDenominator.

$$\text{SlaveCommandPosition} = \text{MasterActualPosition} * \text{RatioNumerator} / \text{RatioDenominator}$$

This function block also allows the application to specify sync positions for the master and slave axes. It is the point in which the master and slave axes become engaged in synchronous motion. When the master axis reaches the MasterStartDistance from the MasterSyncPosition, the slave axis begins to accelerate to the target velocity determined by the master axis velocity and the ratio. The slave axis arrives at the target velocity and the SlaveSyncPosition at the same time the master axis arrives at the MasterSyncPosition. At that time, the slave is locked on to the master and follows the master at the ratio specified. The slave axis continues to follow the master axis until this move is aborted.

Aborting Gearing

Gearing functions can generate large accelerations while following the master. If the aborting function block has small, non-zero Jerk, or small acceleration values, it can take a long time for an accelerating axis to reach the target velocity, or position of the aborting function block. If the Jerk and/or acceleration of the aborting function cannot be increased to suitable values, it may be desirable to:

- Abort the gearing function with an "MC_GearOut" (→ p. 419) with higher accelerations and/or Jerk values (or zero jerk value),
- Execute the next MC motion function block such as "MC_Halt" (→ p. 364).

Time to Reach the Target Velocity

While following the master, gearing functions can generate large accelerations. If the gearing function is aborted while the axis is currently accelerating, and the aborting function block has small non-zero Jerk or

small acceleration values, it can take a long time to reach the target velocity, or position of the aborting function block. If the Jerk and/or acceleration of the aborting function cannot be increased to suitable values, it may be desirable to:

- Abort the gearing function with an [MC_GearOut](#) with higher accelerations and/or Jerk values (or zero jerk value),
- Execute the next MC motion function block such as "MC_Halt" (→ p. 364).

MC_GearInPos	
Execute	StartSync
Master	InSync
Slave	Busy
RatioNumerator	Active
RatioDenominator	CommandAborted
MasterSyncPosition	Error
SlaveSyncPosition	ErrorID
SyncMode	
MasterStartDistance	
BufferMode	

Figure 1-84: MC_GearInPos

2.2.5.66.2 Time Diagram

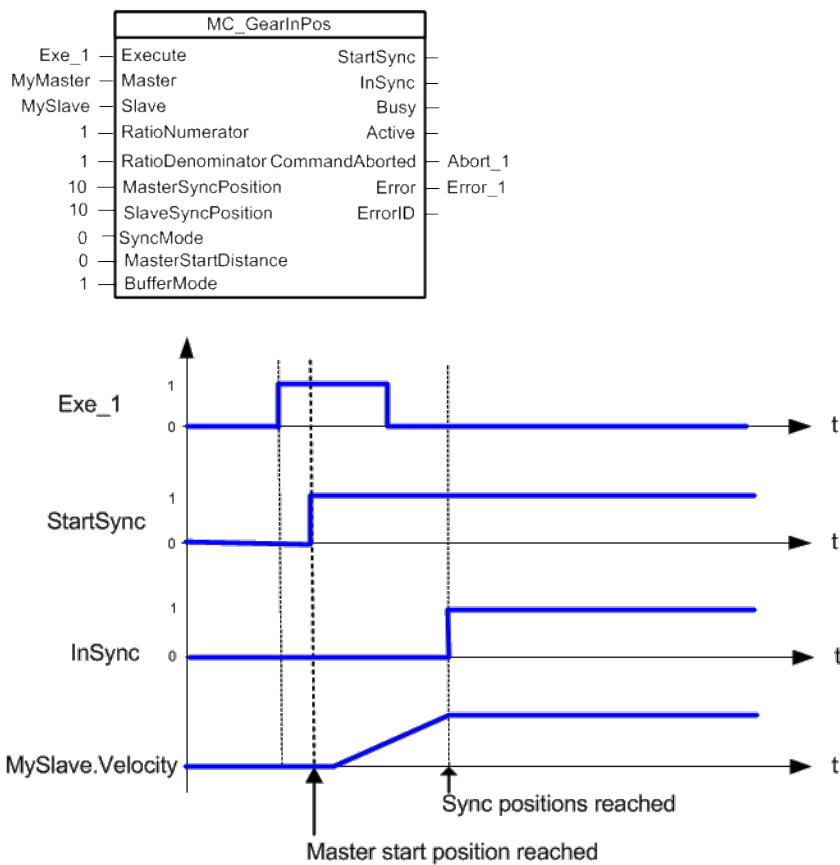

2.2.5.67.3 Arguments

2.2.5.68.4.1 Input

Execute	Description
	Requests to queue the slave gear ratio move
Data type	BOOL

	Range	0, 1
	Unit	n/a
	Default	—
Master	Description	Name of a declared instance of the AXIS_REF library function (for more details,
	Data type	AXIS_REF
	Range	[1,256]
	Unit	n/a
	Default	—
Slave	Description	AXIS_REF.AXIS_NUM is the slave axis number
	Data type	AXIS_REF
	Range	[1,256]
	Unit	n/a
	Default	—
RatioNumerator	Description	Numerator of master/slave ratio. The sign (+ or -) indicates the direction for the slave axis.
	Data type	DINT
	Range	[-2147483648, 2147483647]
	Unit	n/a
	Default	—
RatioDenominator	Description	Denominator of master/slave ratio. The sign (+ or -) indicates the direction for the master axis. The direction determines the sync trigger comparison direction for the slave. <ul style="list-style-type: none"> • For a master moving in the positive direction, use a positive RatioDenominator. • For a master moving in the negative direction, use a negative RatioDenominator.
	Data type	DINT
	Range	[-2147483648, 2147483647]
	Unit	n/a
	Default	—
MasterSyncPosition	Description	Master axis sync position
	Data type	LREAL

	Range	-1.7 ³⁰⁸ to 1.7 ³⁰⁸ (14 to 15 significant digits of accuracy)
	Unit	n/a
	Default	—
SlaveSyncPosition	Description	Slave axis sync position
	Data type	LREAL
	Range	-1.7 ³⁰⁸ to 1.7 ³⁰⁸ (14 to 15 significant digits of accuracy)
	Unit	n/a
	Default	—
SyncMode	Description	<p>SyncMode determines the allowed conditions for synchronization:</p> <p>0 = Normal synchronization. Prior to executing the MC_GearInPos function block, the <i>Master</i> axis position must be before the <i>MasterSyncPosition</i> by a distance greater than the <i>MasterStartDistance</i>. The <i>Slave</i> axis position must be before the <i>SlaveSyncPosition</i>.</p> <p>In the case of axes that have a non-zero rollover, the MC_GearInPos function block will always assume the axes meet these conditions by assuming the sync point is in the next occurrence of the sync position. <i>MasterStartDistance</i> must be positive and greater than the distance the master axis is currently moving per axis update. If the master start distance and the slave axis distance from the <i>SlaveSyncPosition</i> are sufficiently large enough, the slave axis will ramp to the sync position. If not sufficiently large enough, acceleration of the slave axis may be excessive.</p> <p>1 = Immediate synchronization allowed. This mode is only allowed if both the master and slave axes have rollover = 0. If the conditions of SyncMode = 0 are not met, Synchronization is allowed even though the axis positions may be beyond their respective Sync Positions. The <i>MasterStartDistance</i> may be 0. If the <i>MasterStartDistance</i> is zero, the Slave axis will synchronize with the master the instant the master axis crosses the <i>MasterSyncPosition</i>.</p> <p>If either the master or slave axis are beyond their respective sync start positions, the slave axis will immediately synchronize to the master axis. If the master start distance and the slave axis distance from the <i>SlaveSyncPosition</i> are sufficiently large enough, the slave axis will ramp to the sync position. If not sufficiently large enough or immediate synchronization occurs, slave axis acceleration may be excessive.</p> <p>Excessive slave acceleration may also occur if the master axis velocity is large or the master and slave axes have disproportionately different distances to their respective sync positions. If the slave axis is ahead of the master axis at the time of synchronization, the slave axis will move backwards.</p>
	Data type	INT

	Range	0-1
	Unit	n/a
	Default	—
MasterStartDistance	Description	When the master axis reaches this distance before MasterSyncPosition, the slave axis begins its lock-on process. ⓘ IMPORTANT The MasterStartDistance * (RatioNumerator/RatioDenominator) should be greater than (or equal to) the slave sync distance. The slave sync distance is defined as the distance between the slave position when MC_GearInPos executes and the SlaveSyncPosition . If the MasterStartDistance is too short, the MC_GearInPos may have excessive acceleration and a warning log message will be generated.
	Data type	LREAL
	Range	1.7^{-308} to 1.7^{308} (14 to 15 significant digits of accuracy)
	Unit	User unit
	Default	—
BufferMode	Description	1 = buffer
	Data type	SINT
	Range	[1]
	Unit	n/a
	Default	—

2.2.5.69.5.2 Output

StartSync	Description	Indicates that the master axis has reached the MasterStartDistance from the MasterSyncPosition and the lock-on process has begun
	Data type	BOOL
InSync	Description	Indicated the slave axis is locked on to the master axis
	Data type	BOOL
Busy	Description	High from the moment the Execute input goes high until the time the move is ended
	Data type	BOOL
Active	Description	Indicates this move is the Active move
	Data type	BOOL

CommandAborted	Description	Indicates the move was aborted. If the abort arises because the inputs cause inconsistent motion, then this FB: <ul style="list-style-type: none"> • performs no motion • sets an error flag • set the ErrorID to 13
	Data type	BOOL
Error	Description	Indicates an invalid input was specified or the move was terminated due to an error
	Data type	BOOL
ErrorID	Description	Indicates the error if Error output is set to TRUE
	Data type	INT

2.2.5.70.6 Example

2.2.5.71.7.1 Example Description

- Master and Slave are rotary axes with rollovers at 360 degrees.
- The Master initial position is 0 degrees and the slave initial position is 45 degrees.
- The GearInPos FB commands the slave to accelerate up to the geared ratio (1:1) during the master start distance (90 degrees) and be synchronized with the master at the master and slave sync positions.

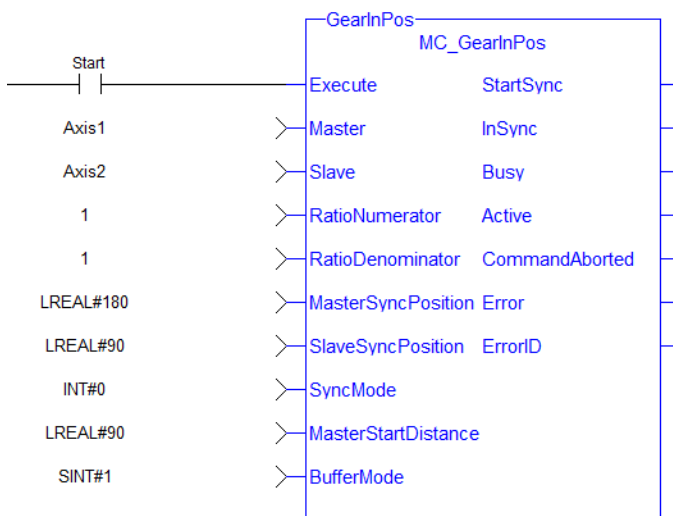

1. Master Axis
2. Slave Axis
3. Master Start Distance
4. Slave starts to accelerate
5. Master Sync Position
6. Slave Sync Position

2.2.5.72.8.2 Structured Text

```
(* MC_GearInPos ST example *)
Inst_MC_GearInPos( GearInPosReq, Axis1, Axis2, 2, 1, 0, 0, 0,
100.0, 1 );
//Inst_MC_GearInPos is instance of MC_GearInPos
GearInPosSync:= Inst_MC_GearInPos.InSync;
//store InSync output into user defined variable
```

2.2.5.73.9.3 Ladder Diagram

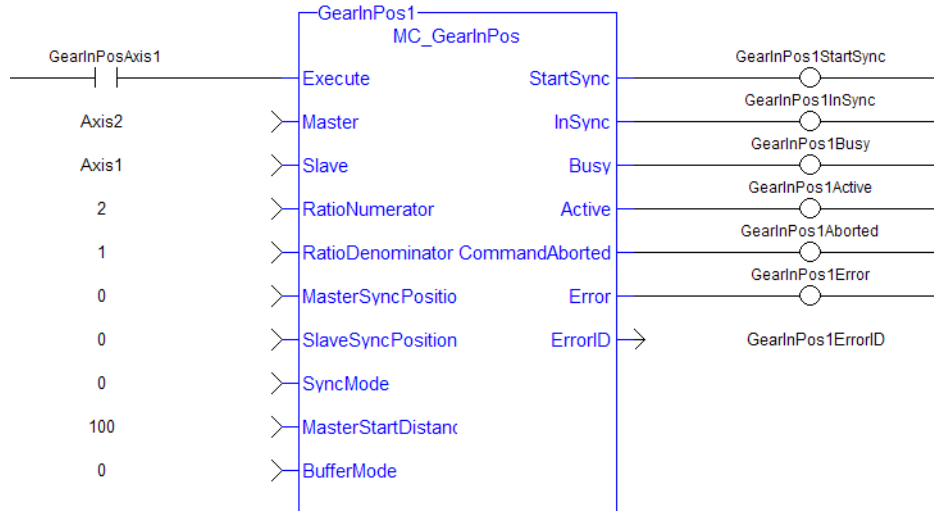

2.2.5.74 MC_GearOut PLCopen ✔

2.2.5.75.1 Description

This function block:

- aborts the active MC_GearIn or MC_GearInPos move,
- disengages the axis from its master,
- and commands the axis to continue at its current velocity.

TIP

The current velocity is calculated by taking the average of the actual velocity during the previous 16 cycles.

Like a [MC_MoveVelocity](#) move, the control continues to command the axis to move at this velocity until this MC_GearOut move is aborted. The Acceleration, Deceleration and Jerk input parameters are applied if this command velocity is modified by the [MC_SetOverride](#) function block. If this function block is called and the active move is not a [MC_GearIn](#) or [MC_GearInPos](#) move, this function block returns an error and the active move is not aborted.

NOTE

The MC_GearOut is done when the slave axis is disengaged from the master axis. Once done, the MC_GearOut will remain busy and active until it is aborted by a different motion function block. This is different behavior than most other motion function blocks. The MC_GearOut function block represents an exception to the exclusivity rule as the **Done** and **Active** outputs may be true at the same time.

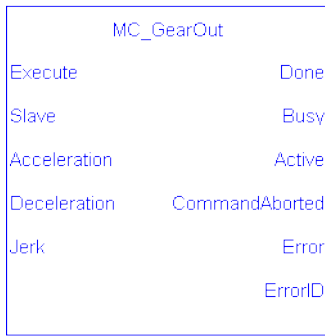

Figure 1-85: MC_GearOut

2.2.5.76.2 Arguments

2.2.5.77.3.1 Input

Execute	Description	Requests to disengage the slave axis from a MC_GearIn or MC_GearInPos move
	Data type	BOOL
	Range	0, 1
	Unit	n/a
	Default	—
Slave	Description	Name of a declared instance of the AXIS_REF library function
	Data type	AXIS_REF
	Range	[1,256]
	Unit	n/a
	Default	—
Acceleration	Description	Trapezoidal: Acceleration rate S-curve: Maximum acceleration
	Data type	LREAL
	Range	—
	Unit	User unit/sec ²
	Default	—
Deceleration	Description	Trapezoidal: Deceleration rate S-curve: Unused
	Data type	LREAL
	Range	—
	Unit	User unit/sec ²

	Default	—
Jerk	Description	Trapezoidal: 0 S-curve: Constant jerk
	Data type	LREAL
	Range	—
	Unit	User unit/sec ³
	Default	—

2.2.5.78.4.2 Output

Done	Description	Indicates the axis is disengaged from its master
	Data type	BOOL
Busy	Description	Indicates the function is executing
	Data type	BOOL
Active	Description	Indicates this move is the Active move
	Data type	BOOL
CommandAborted	Description	Indicates the move was aborted
	Data type	BOOL
Error	Description	Indicates an invalid input was specified or no MC_GearIn or MC_GearInPos move is active
	Data type	BOOL
ErrorID	Description	Indicates the error if Error output is set to TRUE
	Data type	INT

2.2.5.79.5 Example

2.2.5.80.6.1 Structured Text

```
(* MC_GearOut ST example *)
Inst_MC_GearOut
(ExecGearOut1,Axis1,GearOut1Acc,GearOut1Dec,GearOut1Jerk);
//Inst_MC_GearOut is instance of MC_GearOut
```

2.2.5.81.7.2 Ladder Diagram

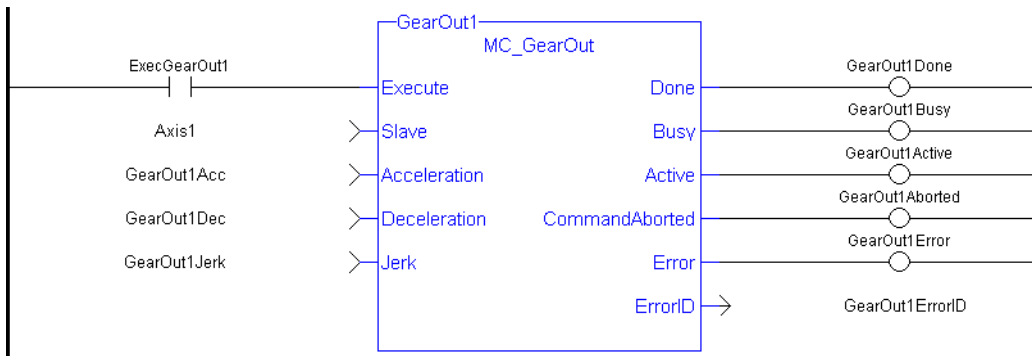

2.2.5.82 MC_Phasing PLCopen ✓

2.2.5.83.1 Description

The MC_Phasing function block performs a master position phase shift for a slave axis. The distance entered at the **PhaseShift** input is iterated into the Slave axis's Master Offset. This distance is iterated like a "MC_MoveRelative" (→ p. 376) move using the specified **Velocity**, **Acceleration**, **Deceleration**, and **Jerk** values. The difference is that the interpolated command delta is not commanded to the axis but is, instead, added to the Slave axis's Master Offset. This will shift the Master axis's position as viewed by the Slave axis, causing a change in the Slave axis's physical position. This will only affect the Slave axis if it is executing a slave move. Subsequent calls to MC_Phasing can abort or blend to an executing MC_Phasing command.

This function block provides a way to smoothly apply a master offset instead of writing values directly to the Master Offset Parameter 1002.

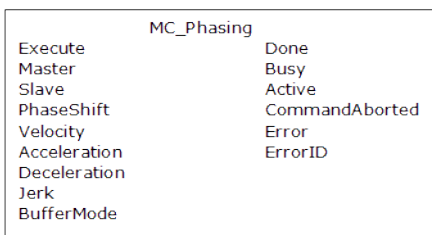

Figure 1-86: MC_Phasing

2.2.5.84.2 Arguments

2.2.5.85.3.1 Input

Execute	Description	Requests to queue the phase shift
	Data type	BOOL
	Range	0, 1
	Unit	n/a
	Default	—
Master	Description	Name of a declared instance of the AXIS_REF library function.)
	Data type	AXIS_REF
	Range	[1,256]
	Unit	n/a

	Default	—
Slave	Description	AXIS_REF AXIS_NUM is the slave axis number
	Data type	AXIS_REF
	Range	[1,256]
	Unit	n/a
	Default	—
PhaseShift	Description	Amount of phase shift
	Data type	LREAL
	Range	—
	Unit	User unit
	Default	—
Velocity	Description	Velocity setpoint
	Data type	LREAL
	Range	—
	Unit	User unit/sec
	Default	—
Acceleration	Description	Trapezoidal: Acceleration rate S-curve: Maximum acceleration
	Data type	LREAL
	Range	—
	Unit	User unit/sec ²
	Default	—
Deceleration	Description	Trapezoidal: Deceleration rate S-curve: Unused
	Data type	LREAL
	Range	—
	Unit	User unit/sec ²
	Default	—
Jerk	Description	Trapezoidal: 0 S-curve: Constant jerk
	Data type	LREAL
	Range	—

	Unit	User unit/sec ³
	Default	—
BufferMode	Description	<ul style="list-style-type: none"> 0. abort 1. buffer 2. blend to active 3. blend to next 4. blend to low velocity 5. blend to high velocity
	Data type	SINT
	Range	[0,5]
	Unit	n/a
	Default	—

2.2.5.86.4.2 Output

Done	Description	Indicates the phase shift has been completely applied
	Data type	BOOL
Busy	Description	High from the moment the Execute input is one-shot to the time the move is ended
	Data type	BOOL
Active	Description	Indicates this phase shift is the active phase shift
	Data type	BOOL
CommandAborted	Description	Indicates the move was aborted
	Data type	BOOL
Error	Description	Indicates an invalid input was specified or the move was terminated due to an error
	Data type	BOOL
ErrorID	Description	Indicates the error if Error output is set to TRUE
	Data type	INT

2.2.5.87.5 Example

2.2.5.88.6.1 Structured Text

```
(* MC_Phasing ST example *) //Inst_MC_Phasing is an instance of
MC_Phasing function block
Inst_MC_Phasing(PhasingAxis1, Axis2, Axis1, 1000.0,100.0, 200.0,
200.0, 0, 0 );
```

2.2.5.89.7.2 Ladder Diagram

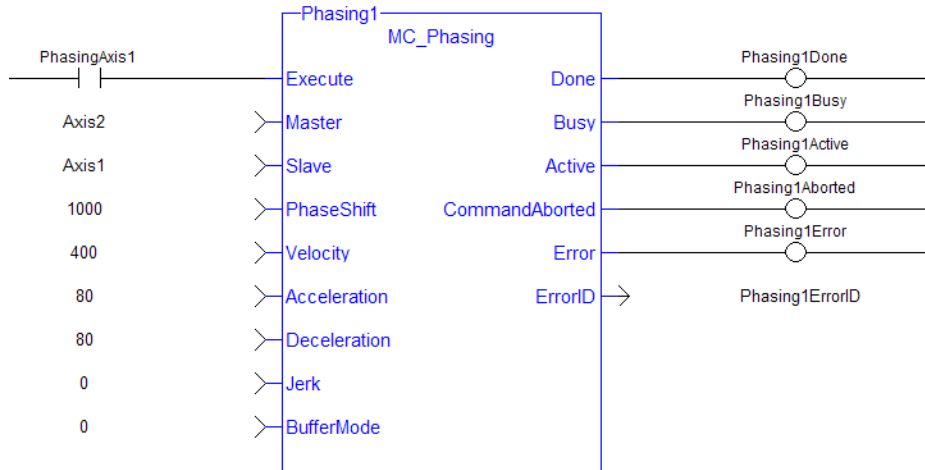

2.2.5.90 MC_SyncSlaves PLCopen

2.2.5.91.1 Description

This function block allows the application to specify what slave axes are to be synchronized and which master they follow. After this function block is executed successfully, all the slave axes specified at the SlaveList input start their slave moves (i.e. MC_GearIn, MC_CamIn, etc.) on the same servo interrupt for a synchronized slave start. When a slave move is commanded for one of the slave axes listed, the slave move is queued but the motion is held off until all of the listed slaves have queued their slave moves.



Figure 1-87: MC_SyncSlaves

2.2.5.92.2 Arguments

2.2.5.93.3.1 Input

Execute	Description	A positive transition of this input causes the function block to execute
	Data type	BOOL
	Range	0, 1
	Unit	n/a
	Default	—
Master	Description	Master axis identifier
	Data type	AXIS_REF
	Range	1 - 256
	Unit	n/a
	Default	—

SlaveCount	Description	The number of slave axes listed in the SlaveList array input that are to be synchronized. This number must not be greater than the declared size of the SlaveList array. If this number is 0, the list of synchronized slaves for the specified Master axis is cleared.
	Data type	AXIS_REF
	Range	1-256 The AXIS_NUM element of the AXIS_REF structure must be in the range [1-256]
	Unit	n/a
	Default	—
SlaveList	Description	The list of slave axes that are to be synchronized. Each element of this array contains a unique axis number. The axis number must not be the same as the Master axis number.
	Data type	UINT
	Range	1-32
	Unit	n/a
	Default	—

2.2.5.94.4.2 Output

Done	Description	Indicates the synchronized slave assignments were completed without error
	Data type	BOOL
Error	Description	Indicates an invalid input was specified
	Data type	BOOL
ErrorID	Description	Indicates the error if Error output is set to TRUE
	Data type	INT

2.2.5.95.5 Usage

Call MC_SyncSlaves to specify the slave axes to synchronize.

Call each slave move (e.g. MC_GearIn) for each slave axis. The motion is held off until all the slave moves have been queued.

After all the slave moves have been queued, the interpolation for all the slave axes begin on the same servo interrupt, providing a synchronized start.

The master axis can be in motion prior to this sequence, or the master can be commanded after all the slave moves are queued.

2.2.5.96.6 Related Functions

[MC_GearIn](#)

[MC_GearInPos](#)

MC_CamIn

2.2.5.97.7 Example

2.2.5.98.8.1 Structured Text

```
(* MC_SyncSlaves ST example *)
// Inst_MC_SyncSlaves is an instance of MC_SyncSlaves function
block
Inst_MC_SyncSlaves( SyncSlaves, Axis1, SlaveCount, SlaveList );
```

2.2.5.99.9.2 Ladder Diagram

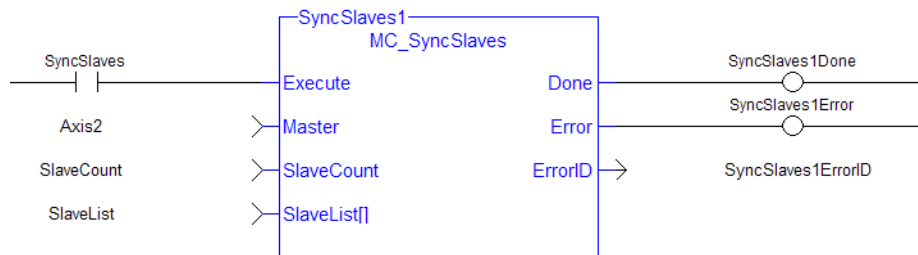

2.2.6 Reference Functions

This set of functions provides commands for reference points.

2.2.6.1 MC_Reference PLCopen

2.2.6.2.1 Description

This function block is used to execute a fast home to a switch. If the application selects to reference to the index mark of an encoder, or the null of a resolver (which is typical), the new position value is assigned to the position of the index of the encoder (or the null of the resolver) and not the position of the switch. The [ECATWriteSDO](#) function block is used to setup the trigger event and any desired preconditions. **This function block utilizes the Position Capture Mode of the AKD.**

NOTE

At this time, position capture is not available for PLCopen axes assigned to the secondary feedback input (digitizing axes). Therefore, MC_Reference cannot be used to home digitizing axes at this time.

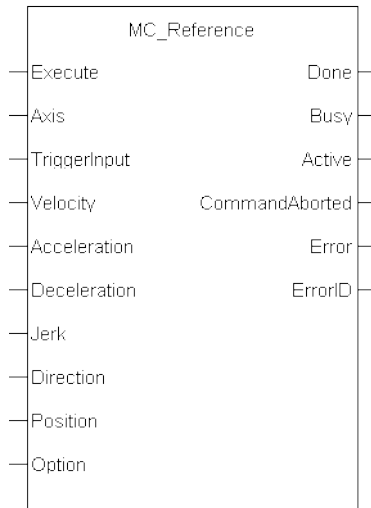

Figure 1-88: MC_Reference

2.2.6.3.2 Arguments

2.2.6.4.3.1 Input

Execute	Description	Requests to queue the MC_Reference move and arms reference trigger events
	Data type	BOOL
	Range	0, 1
	Unit	n/a
	Default	—
Axis	Description	Name of a declared instance of the AXIS_REF library function.)
	Data type	AXIS_REF
	Range	[1,256]
	Unit	n/a
	Default	—

TriggerInput	Description	<p>TRIGGER_REF structure defines the trigger</p> <p>InputID INT :</p> <p>0 = Capture Engine 0 1 = Capture Engine 1 Range is [0, 1] For information on configuring the capture engines, refer to AKD Capture Engine Configuration.</p> <p>Direction INT; 1 = rising edge of trigger, 2 = falling edge of trigger</p> <p>Trigid INT; must be zero</p> <p>NOTE</p> <p>TrigMode INT (TriggerInput.TrigMode) is not presently supported by this function. The TriggerInput.Mode may be supported in a future software version.</p>
	Data type	TRIGGER_REF
	Range	See Description above
	Unit	n/a
	Default	—
Velocity	Description	Commanded velocity for the reference move
	Data type	LREAL
	Range	—
	Unit	User unit/sec
	Default	—
Acceleration	Description	Commanded acceleration for the reference move
	Data type	LREAL
	Range	—
	Unit	User unit/sec ²
	Default	—
Deceleration	Description	Commanded deceleration for the reference move
	Data type	LREAL
	Range	—
	Unit	User unit/sec ²
	Default	—

Jerk	Description	Commanded jerk for the reference move (if zero, then trapezoidal acc/dec is used)
	Data type	LREAL
	Range	—
	Unit	User unit/sec ³
	Default	—
Direction	Description	Commanded Direction of the reference
	Data type	SINT
	Range	[0, 1]
	Unit	n/a
	Default	—
Position	Description	The position the axis will be reset to when at the machine reference location
	Data type	LREAL
	Range	—
	Unit	User unit
	Default	—
Option	Description	Option identifier for Resolvers/Modulo reference. 0 = Use latched position for reference 1 = use resolver position of nearest null for reference 2 pole resolver 2 = use resolver position of nearest null for reference 4 pole resolver 3 = use resolver position of nearest null for reference 6 pole resolver 4 = use resolver position of nearest null for reference 8 pole resolver 5 = use resolver position of nearest null for reference 10 pole resolver ... 15 = use resolver position of nearest null for reference 30 pole resolver
	Data type	SINT
	Range	[0, 15]
	Unit	n/a
	Default	—

2.2.6.5.4.2 Output

Done	Description	Indicates the reference move and position adjustment is complete
	Data type	BOOL
Busy	Description	Indicates this function block is executing
	Data type	BOOL
Active	Description	Indicates this move is the Active move
	Data type	BOOL
CommandAborted	Description	Indicates the move was aborted
	Data type	BOOL
Error	Description	Indicates an invalid input, or the move was terminated due to an error
	Data type	BOOL
ErrorID	Description	Indicates the error if the Error output is high
	Data type	INT

2.2.6.6.5 Usage

The following lists the steps for homing a PLCopen axis, using the MC_Reference function block. Not all of the steps are necessary depending on the configuration and the homing cycle design.

The sequence of events of a PLCopen homing cycle consists of the following steps:

- Ensure Axis is not on Reference switch.
If a switch is used in the homing cycle for the event or precondition to the event, check to ensure the axis is not already tripping the switches that trigger the event and precondition. If it is, move the axis off the switches.
- Configure AKD capture engine
Configuration of the AKD capture engine is performed by writing drive CAN objects via SDO. It is accomplished with the [ECATWriteSdo](#) function. **The AKD Capture mode must be set to POSITION CAPTURE.**
The available configurations are discussed in AKD Capture Engine Configuration . Example AKD capture engine configurations and reference examples are discussed in PLCopen Homing Methods.
- Call the MC_REFERENCE function to initiate optional homing motion and to arm the AKD capture engine
The MC_Reference function block selects the trigger edge (rising or falling edge) and arm the capture. Then, it optionally moves the axis to the reference location as directed by inputs to this function. When the AKD indicates that the capture event has occurred, the coordinate system is shifted so that the reference position input to this function block is set to the reference location. Then, the reference motion is stopped.
- Wait for the completion of the MC_Reference function block
The application is notified by the completion, abort or error of the homing by the MC_Reference function block.
- Upon completion of the MC_Reference function block, the axis can be moved to the home position with a [MC_MoveAbsolute](#) function block.

TIP

Once the MC_Reference block is queued, but before it is completed, the cycle can be aborted with a [MC_](#)

[Halt](#) or [MC_Stop](#) function block or by queuing a new motion function block with the Abort selected for buffer mode.

2.2.6.7.6 Related Functions

[ECATWriteSdo](#)

[MC_MoveAbsolute](#)

2.2.6.8.7 Example

2.2.6.9.8.1 Structured Text

```
(* MC_Reference ST example *)
TriggerInput.InputID := 0; //configure the reference InputID
TriggerInput.DIRECTION := 1; //configure the reference
direction
Inst_MC_Reference( RefReq, Axis1, TriggerInput, 20.0, 100.0,
100.0, 100.0, 0, 0.0, 0 );
```

2.2.6.10.9.2 Ladder Diagram

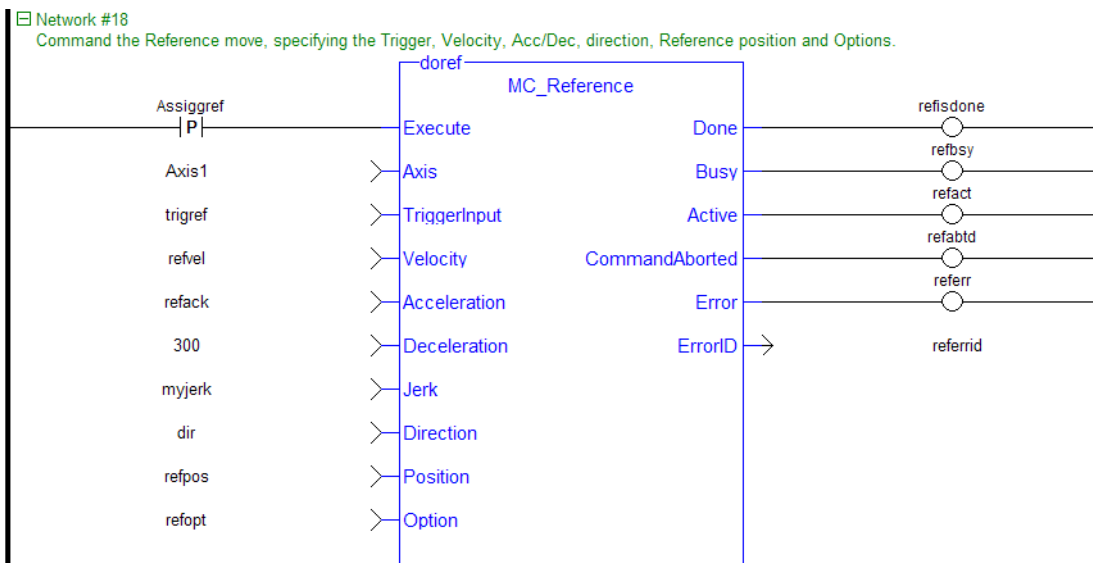

2.2.6.11 MC_SetPos PLCopen ✓

2.2.6.12.1 Description

This function block changes the present actual position of the axis (as reported by "MC_ReadActPos" (→ p. 350)) to the position specified by the **Position** and **Mode** inputs. If a motor is associated with the axis, it will not move when MC_SetPos is executed. MC_SetPos does not cause any motion. It applies an offset to the command and actual positions.

MC_SetPos also sets the accumulated Superimposed distance value for the input axis to 0. See the table in Axis Positions Data.

This function block replaces the MC_SetPosition function.

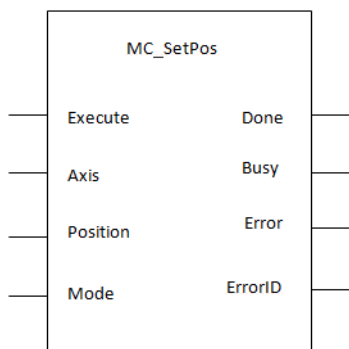

Figure 1-89: MC_SetPos

2.2.6.13.2 Arguments

For more detail on how inputs and outputs work, refer to PLCopen Function Blocks - General Rules.

2.2.6.14.3.1 Inputs

Execute	Description	Requests to change the axis position
	Data type	BOOL
	Range	0,1
	Unit	n/a
	Default	—
Axis	Description	Name of a declared instance of the AXIS_REF library function. For more details Modify PLCopen Axis.
	Data type	AXIS_REF Structure
	Range	[1,256]
	Unit	n/a
	Default	—
Position	Description	Absolute Mode: New Axis Position to replace the present position. Relative Mode: Position offset to apply to present position (typically used with multiturn absolute position feedback devices).
	Data type	LREAL
	Range	—
	Unit	n/a
	Default	—
Mode	Description	LOW = Position input is an absolute position HIGH = Position input is a relative position
	Data type	BOOL

Range	—
Unit	n/a
Default	—

2.2.6.15.4.2 Outputs

Done	Description	Indicates the reference move and position adjustment is complete
	Data type	BOOL
Busy	Description	Indicates this function block is executing
	Data type	BOOL
Error	Description	Indicates an invalid input, or the move was terminated due to an error
	Data type	BOOL
ErrorID	Description	Indicates the error if the Error output is high See table in PLCopen Function Block ErrorID Output
	Data type	INT

2.2.6.16.5 Example

2.2.6.17.6.1 Structured Text

```

(* MC_SetPos ST example *)
Inst_MC_SetPos ( Axis1 , 0 , 0 );
//Inst_MC_SetPos is an instance of MC_SetPos function

(* MC_SetPos absolute mode example: Set position value to zero. *)
Inst_MC_SetPos ( Axis1 , 0 , 0 );
//Inst_MC_SetPos is an instance of MC_SetPos function

(* MC_SetPos relative mode example: Increase position value by 1000. *)
Inst_MC_SetPos ( Axis1 , 1000 , 1 );
//Inst_MC_SetPos is an instance of MC_SetPos function
    
```

2.2.6.18.7.2 Ladder Diagram

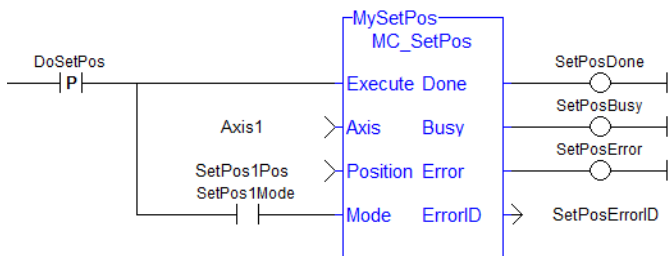

2.2.6.19 MC_SetPosition

2.2.6.20.1 Description

This function has been deprecated by the "MC_SetPos" (→ p. 432) function block.

2.2.7 Registration Function Blocks

This set of function blocks allow for Mark-to-Mark or Mark-to-Machine registration. See Registration for techniques on setting up and using the registration function blocks.

2.2.7.1 MC_MachRegist

2.2.7.2 Description

This function block enables Mark-to-Machine registration and can be used on any servo or digitizing axis and with any move type. It is most frequently used in master/slave applications.



Used with	Effect
...	
Non-slave moves	Resets the axis position when a good mark is captured by the fast input.
Slave moves	In addition to resetting the axis position, applies a compensation offset to correct for the difference between the target position and the measured position. This provides the ability to compensate for product or process inconsistencies providing a system that remains synchronized with no accumulated error and maintaining repeatable accuracy throughout the process.

- A positive transition of the **En** input will start registration. The application may change the registration parameters while registration is active by changing the input values and causing another positive transition of the En input. The function block will then read and apply the new values.
- The axis number at the **Axis** input indicates the axis whose position, at the fast input, is used to determine if the mark is a good mark.
- The **Distance**, **Tolerance**, and **Ignore** inputs are used to determine whether or not the registration mark is good. For a mark to be recognized as good, it must be outside of the Ignore distance and the correct Distance from the previous mark +/- the Tolerance window. A mark is considered bad if it occurs outside of the "good tolerance band" and is not ignored. Both good marks and bad marks are recognized as marks, ignored marks are not recognized. If all marks are to be recognized as good marks, enter 0 at both **Distance** and **Tolerance**.

- The **Distance** value defines the distance between good marks. In Clear Lane and Product registration the Distance input value typically is the same as the Target input value. However in Print registration the Distance is typically not the same as Target.
- The **Tolerance** value is the distance, plus and minus, about Distance. Marks that are detected within this window are considered good marks and registration will occur. Marks that are detected outside this window and outside the Ignore band, are considered bad marks and registration will not occur. This window should be large enough to allow for the worst case error in the distance between the previous mark and the current mark.
- The **Ignore** value defines the distance from the previous mark where all marks detected by the fast input will be ignored. This is crucial when registering products that do not have Clear Lane registration marks.
- The **Target** input is the expected target position that is used to calculate how much registration compensation is to be applied when a registration mark is considered good. When a good mark is detected, the position of the **PosAxis** is compared to the Target position to calculate a correction. The registration correction will only be applied with master/slave move types.
- The **Position** input is the position value that the registration Axis position will be reset to when a good registration mark is detected.
- When a good mark occurs the position of the **PosAxis** is compared to the Target position and used to calculate the amount of registration compensation to apply to the CompAxis.
- Registration compensation is applied to the axis specified at the **CompAxis** input under the following conditions. If CompAxis is executing a slave move (i.e. MC_GearIn or MC_CamIn), the compensation is applied directly to the axis. If CompAxis is a master axis, the compensation is applied to the master offsets of all its slaves. This shifts the master's position as seen by its slaves.
- The **PosTolerance** input is the distance, plus and minus, about the Target position used to determine if compensation will be applied. When a good mark occurs, the position of the **PosAxis** axis is checked to see if it lies within the window defined by PosTolerance. If it is in the window, compensation will be applied. If it is outside the window, compensation will not be applied even though a good mark was found.
- If **PosAxis** and **CompAxis** are different axes, the **RatioNumerator** and **RatioDenominator** inputs define the conversion factor for calculating the compensation value. This is needed because the amount of error between actual and target positions is determined by PosAxis's position and the compensation is applied to the CompAxis. The RatioNumerator should typically be the number of User Units of CompAxis motion for one registration cycle and the RatioDenominator should typically be the number of User Units of PosAxis motion for one registration cycle. If PosAxis and CompAxis are the same, RatioNumerator and RatioDenominator should be the same value, thus resulting in a 1:1 ratio.
- The **Option** input defines various modes of operation for registration.
 - The first bit, 0001H, selects Absolute or Resetting. This refers to the way in which the second mark and all subsequent marks are determined to be good marks. With both registration schemes, the very first mark detected is the starting point. With Resetting registration, when the next mark is detected, the position of that mark becomes the starting point for the next good mark detection calculation and so on. The starting point is "reset" with each good or bad mark. This feature allows the product to re-synchronize, if necessary, due to process issues like product shift, etc. In contrast, Absolute registration determines all good marks based on the very first mark. The position of the second and each subsequent mark is compared to an integer multiple of Distance from the very first mark. This method insures the product will always register to a known fixed distance.
 - The third bit, 0004H, must always be 0. Mark-to-machine registration requires time-based capture.

2.2.7.3.1 Arguments

2.2.7.4.2.1 Input

En	Description	Rising edge of EN enables execution
	Data type	BOOL

	Range	0, 1
	Unit	n/a
	Default	—
Axis	Description	Axis whose position is used to determine a good mark.
	Data type	Axis_Ref
	Range	The range of .AXIS_NUM is [1,256]
	Unit	n/a
	Default	n/a
TriggerInput	Description	<p>Structure specifying the fast input. The structure elements are:</p> <p>InputID INT 0 = Capture Engine 0 1 = Capture Engine 1 Range is [0, 1] For information on configuring the capture engines, refer to AKD Capture Engine Configuration.</p> <p>Direction INT 1 = rising edge, 2 = falling edge, 3 = NA, 4 = toggle between both, falling edge first, 5 = toggle between both, rising edge first, range = [1, 5]</p> <p>TrigID INT Axis number of the fast input. Zero indicates this trigger axis is to be the same as the Axis input. range = [0, 256]</p>
		<p>NOTE</p> <p>TrigMode INT (TriggerInput.TrigMode) is not presently supported by this function. The TriggerInput.Mode may be supported in a future software version.</p>
	Data type	TRIGGER_REF
	Range	
	Unit	
	Default	
Distance	Description	This is the expected distance between good marks. Along with Tolerance and Ignore, this value is used to determine if the mark detected by the fast input is a good mark.
	Data type	LREAL
	Range	When converted to feedback units, the range is $[-2^{51}, 2^{51}-1]$. This value must have the same sign as Ignore.
	Unit	user units
	Default	n/a

Tolerance	Description	This value specifies the distance, plus or minus, about Distance to determine if the mark detected by the fast input is a good mark.
	Data type	LREAL
	Range	When converted to feedback units, the range is $[0, 2^{51}-1]$
	Unit	user units
	Default	n/a
Ignore	Description	This value specifies the distance after the previous good mark in which any detected marks are ignored.
	Data type	LREAL
	Range	When converted to feedback units, the range is $[-2^{51}, 2^{51}-1]$. This value must have the same sign as Distance.
	Unit	user units
	Default	n/a
Target	Description	This is the target position. This position is compared to the actual position captured by the fast input to determine the amount of registration compensation to apply.
	Data type	LREAL
	Range	When converted to feedback units, the range is: <ul style="list-style-type: none"> • $[-2^{51}, 2^{51}-1]$ if PosAxis' rollover value is zero • $[0, \text{PosAxis' Rollover Value}]$ if PosAxis' rollover value is non-zero (i.e., $\geq 0 < \text{PosAxis' Rollover Value}$)
	Unit	user units
	Default	n/a
Position	Description	The position the axis is set to when a good registration mark occurs.
	Data type	LREAL
	Range	When converted to feedback units, the range is: <ul style="list-style-type: none"> • $[-2^{51}, 2^{51}-1]$ if PosAxis' rollover value is zero • $[0, \text{PosAxis' Rollover Value}]$ if PosAxis' rollover value is non-zero (i.e., $\geq 0 < \text{PosAxis' Rollover Value}$)
	Unit	user units
	Default	n/a

PosAxis	Description	The position of this axis at the time the fast input occurs is compared to the Target position to determine the amount of registration compensation to apply.
	Data type	AXIS_REF
	Range	The range of .AXIS_NUM is [1,256]
	Unit	n/a
	Default	n/a
CompAxis	Description	The calculated registration compensation is applied to this axis.
	Data type	AXIS_REF
	Range	The range of .AXIS_NUM is [1,256]
	Unit	n/a
	Default	n/a
PosTolerance	Description	This value specifies the distance, plus or minus, about the Target position to determine if the position will be accepted and compensation value is calculated and applied.
	Data type	LREAL
	Range	When converted to feedback units, the range is $[-2^{51}, 2^{51}-1]$
	Unit	user units
	Default	n/a
RatioNumerator	Description	This value is typically the number of User Units of CompAxis motion for one product cycle. This value is used with RatioDenominator to create a conversion factor for calculating the compensation value when PosAxis and CompAxis are different axes.
	Data type	DINT
	Range	When converted to feedback units, the range is [1,4294967295]
	Unit	user units
	Default	n/a
RatioDenominator	Description	This value is typically the number of User Units of PosAxis motion for one product cycle. This value is used with RatioNumerator to create a conversion factor for calculating the compensation value when PosAxis and CompAxis are different axes.
	Data type	DINT
	Range	When converted to feedback units, the range is [1,4294967295]

	Unit	user units
	Default	n/a
Options	Description	Each bit enables/disables an option. The following table defines the bits. Any bits not defined are reserved. The third bit, 0004H, must be 0.
	Data type	UINT
	Range	refer to the following options table
	Unit	n/a
	Default	n/a

Hexadecimal	Decimal	Option	Description
0001 H	1	Absolute/Resetting	0 = Resetting, 1 = Absolute
0002 H	2	Reserved	0
0004 H	4	Time/position based capture	0 = time based capture, 1 = position based capture
0008 H	8	Inhibit Reference on Good Mark	0 = Perform reference, 1 = inhibit reference
0010H	16	Inhibit Master Compensation	0 = Perform Master Compensation, 1 = Inhibit Master Compensation
0020H	32	Inhibit Slave Compensation	0 = Perform Slave Compensation, 1 = Inhibit Slave Compensation.

Table 1-2: MC_MachRegist Options Table

2.2.7.5.3.2 Outputs

RegistOn	Description	Indicates registration is activated
	Data type	BOOL
Aborted	Description	Indicates registration has been terminated by MC_StopRegist.
	Data type	BOOL
Error	Description	Indicates an invalid input was specified or registration was terminated due to an error
	Data type	BOOL
ErrorID	Description	Indicates the error if Error output is TRUE. See table in PLCopen Function Block ErrorID Output.
	Data type	INT

TIP

To use Capture Engine 1 modify the input PDOs that are used and add the Latch Position 1 parameter.

2.2.7.6.4 Related Functions

[MC_ReadParam](#)

[MC_StopRegist](#)

[MC_WriteParam](#)

2.2.7.7.5 Examples

2.2.7.8.6.1 Function Block

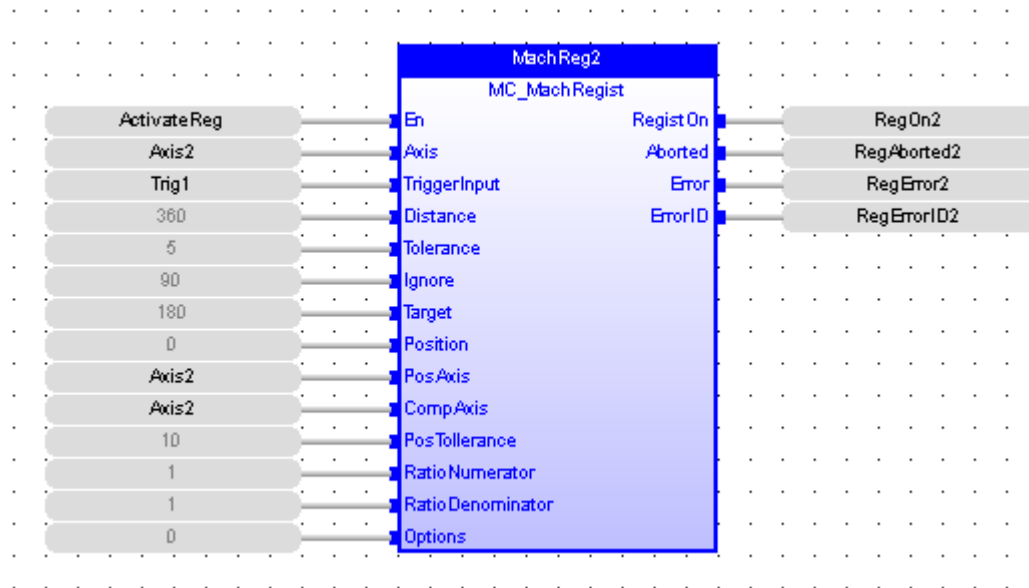

2.2.7.9.7.2 Instruction List

```
CAL Inst_MC_MachRegist( ActivateReg, Axis2, Trig1, 360, 5, 90, 180, 0, Axis2, Axis2, 5, 1, 1, 0 )
```

2.2.7.10.8.3 Ladder Diagram

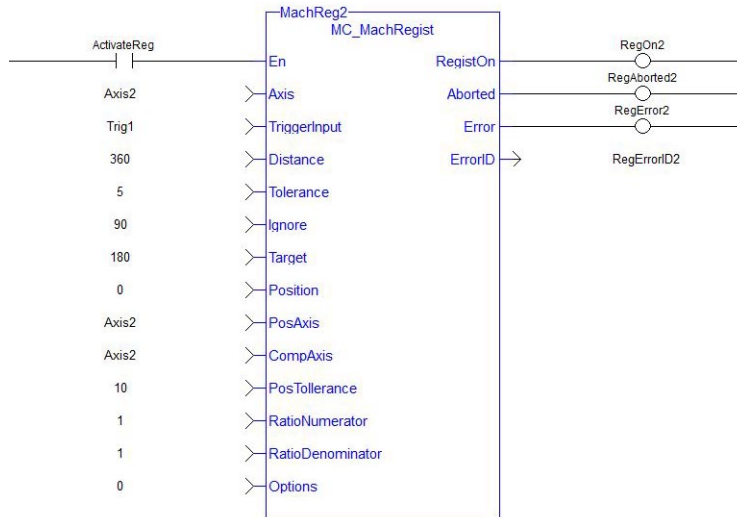

2.2.7.11.9.4 Structured Text

```
Inst_MC_MachRegist( ActivateReg, Axis2, Trig1, 360, 5, 90, 180, 0, Axis2, Axis2, 10,
```

2.2.7.12 MC_MarkRegist PLCopen ✔

2.2.7.13.1 Description

This function block enables mark-to-mark registration and can be used on any servo or digitizing axis and with any move type. This function block is most frequently used in master/slave applications.

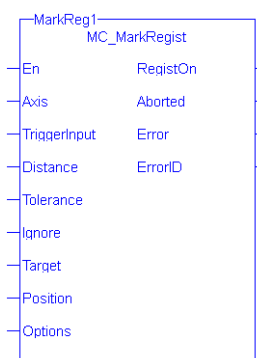

Used with ...	Effect
Non-slave moves	Resets the axis position when a good mark is captured by the fast input.
Slave moves	In addition to resetting the axis position, applies a compensation offset to correct for the difference between the target mark-to-mark distance and the measured mark-to-mark distance. This provides the ability to compensate for product or process inconsistencies providing a system that remains synchronized with no accumulated error and maintaining repeatable accuracy throughout the process.

- A positive transition of the **En** input will start registration. The application may change the registration parameters while registration is active by changing the input values and causing another positive transition of the En input. The function block will then read and apply the new values.
- The axis number at the **Axis** input identifies the axis of registration. If Axis is a master axis for another axis's slave move, Master Registration will be activated. Master Registration calculates a compensation that is added to the master offset of its slaves. This offset shifts the position of the master axis as seen by its slaves. The compensation is not applied to the master axis, but to its slaves. If Axis is a slave axis, Slave Registration will be activated. Slave Registration calculates a compensation that is added to the slave offset of the axis. This compensation value is applied directly to the slave axis.
- The **Distance**, **Tolerance**, and **Ignore** inputs are used to determine whether or not the registration mark is good. For a mark to be recognized as good, it must be outside of the Ignore distance and the correct Distance from the previous mark +/- the Tolerance window. A mark is considered bad if it occurs outside of the "good tolerance band" and is not ignored. Both good marks and bad marks are recognized as marks, ignored marks are not recognized. If all marks are to be recognized as good marks, enter 0 at both **Distance** and **Tolerance**.
- The **Distance** value defines the distance between good marks. In Clear Lane and Product registration the Distance input value typically is the same as the **Target** input value. However in Print registration the Distance is typically not the same as Target.
- The **Tolerance** value is the distance, plus and minus, about **Distance**. Marks that are detected within this window are considered good marks and registration will occur. Marks that are detected outside this window and outside the Ignore band, are considered bad marks and registration will not occur. This window should be large enough to allow for the worst case error in the distance between the previous mark and the current mark.
- The **Ignore** value defines the distance from the previous mark where all marks detected by the fast input will be ignored. This is crucial when registering products that do not have Clear Lane registration marks.
- The **Target** input is the expected distance between good registration marks and is used to calculate how much registration compensation is to be applied when a registration mark is considered good. In many applications this is often equivalent to the product length or the cycle length. When a good mark is detected, the actual distance between the good mark and the previous mark is determined and compared to the Target distance to calculate a correction. The registration correction will only be applied with master/slave move types and always affects the slave axis.

- The **Position** input is the position value that the registration Axis position will be reset to when a good registration mark is detected.
- The **Option** input defines various modes of operation for registration. The first bit, 0001H, selects Absolute or Resetting. This refers to the way in which the second mark and all subsequent marks are determined to be good marks. With both registration schemes, the very first mark detected is the starting point. With Resetting registration, when the next mark is detected, the position of that mark becomes the starting point for the next good mark detection calculation and so on. The starting point is “reset” with each good or bad mark. This feature allows the product to re-synchronize, if necessary, due to process issues like product shift, etc. In contrast, Absolute registration determines all good marks based on the very first mark. The position of the second and each subsequent mark is compared to an integer multiple of Distance from the very first mark. This method insures the product will always register to a known fixed distance.

2.2.7.14.2 Arguments

2.2.7.15.3.1 Input

En	Description	Rising edge of EN enables execution
	Data type	BOOL
	Range	0, 1
	Unit	n/a
	Default	—
Axis	Description	Axis to apply registration to
	Data type	AXIS_REF
	Range	The range of .AXIS_NUM is [1,256]
	Unit	n/a
	Default	n/a

TriggerInput	Description	<p>Structure specifying the fast input.</p> <p>The structure elements are:</p> <p>InputID INT 0 = Capture Engine 0 1 = Capture Engine 1 Range is [0,1] For information on configuring the capture engines, refer to AKD Capture Engine Configuration.</p> <p>DirectionINT 1 = rising edge, 2 = falling edge, 3 = NA, 4 = toggle between both, falling edge first, 5 = toggle between both, rising edge first, range = [1,5]</p> <p>TrigIDINT Axis number of the fast input. Zero indicates this trigger axis is to be the same as the Axis input. range = [0,256]</p>
		<p style="text-align: center;">NOTE</p> <p>TrigMode INT (TriggerInput.TrigMode) is not presently supported by this function. The TriggerInput.Mode may be supported in a future software version.</p>
	Data type	TRIGGER_REF
	Range	
	Unit	
	Default	
Distance	Description	This is the expected distance between good marks. Along with Tolerance and Ignore, this value is used to determine if the mark detected by the fast input is a good mark.
	Data type	LREAL
	Range	When converted to feedback units, the range is $[-2^{51}, 2^{51}-1]$. This value must have the same sign as Ignore.
	Unit	user units
	Default	n/a
Tolerance	Description	This value specifies the distance, plus or minus, about Distance to determine if the mark detected by the fast input is a good mark.
	Data type	LREAL
	Range	When converted to feedback units, the range is $[0, 2^{51}-1]$
	Unit	user units
	Default	n/a

Ignore	Description	This value specifies the distance after the previous good mark in which any detected marks are ignored.																	
	Data type	LREAL																	
	Range	When converted to feedback units, the range is $[-2^{51}, 2^{51}-1]$. This value must have the same sign as Distance.																	
	Unit	user units																	
	Default	n/a																	
Target	Description	This is the target distance between good marks. This distance is compared to the actual distance measured by the fast input to determine the amount of registration compensation to apply.																	
	Data type	LREAL																	
	Range	When converted to feedback units, the range is $[-2^{51}, 2^{51}-1]$. This value must have the same sign as Distance.																	
	Unit	user units																	
	Default	n/a																	
Position	Description	The position the axis is set to when a good registration mark occurs																	
	Data type	LREAL																	
	Range	When converted to feedback units, the range is: <ul style="list-style-type: none"> • $[-2^{51}, 2^{51}-1]$ if PosAxis' rollover value is zero • $[0, \text{PosAxis' Rollover Value}]$ if PosAxis' rollover value is non-zero (i.e., $\geq 0 < \text{PosAxis' Rollover Value}$) 																	
	Unit	user units																	
	Default	n/a																	
Options	Description	Each bit enables/disables an option. The following table defines the bits. Any bits not defined are reserved.																	
	Data type	UINT																	
	Range	Refer to the following options table.																	
	Unit	n/a																	
	Default	n/a																	
<table border="1"> <thead> <tr> <th>Hexadecimal</th> <th>Decimal</th> <th>Option</th> <th>Description</th> </tr> </thead> <tbody> <tr> <td>0001 H</td> <td>1</td> <td>Absolute/Resetting</td> <td>0 = Resetting, 1 = Absolute</td> </tr> <tr> <td>0002 H</td> <td>2</td> <td>Reserved</td> <td>0</td> </tr> <tr> <td>0004 H</td> <td>4</td> <td>Time/position based capture</td> <td>0 = time based capture, 1 = position based capture</td> </tr> </tbody> </table>				Hexadecimal	Decimal	Option	Description	0001 H	1	Absolute/Resetting	0 = Resetting, 1 = Absolute	0002 H	2	Reserved	0	0004 H	4	Time/position based capture	0 = time based capture, 1 = position based capture
Hexadecimal	Decimal	Option	Description																
0001 H	1	Absolute/Resetting	0 = Resetting, 1 = Absolute																
0002 H	2	Reserved	0																
0004 H	4	Time/position based capture	0 = time based capture, 1 = position based capture																

Hexadecimal	Decimal	Option	Description
0008 H	8	Inhibit Reference on Good Mark	0 = Perform reference, 1 = inhibit reference
0010H	16	Inhibit Master Compensation	0 = Perform Master Compensation, 1 = Inhibit Master Compensation
0020H	32	Inhibit Slave Compensation	0 = Perform Slave Compensation, 1 = Inhibit Slave Compensation.

Table 1-3: MC_MarkRegist Options Table.

TIP

To use Capture Engine 1 modify the input PDOs that are used and add the Latch Position 1 parameter.

2.2.7.16.4.2 Outputs

RegistOn	Description	Indicates that registration is active.
	Data type	BOOL
Aborted	Description	Indicates registration has been terminated by MC_StopRegist.
	Data type	BOOL
Error	Description	Indicates an invalid input was specified or registration was terminated due to an error
	Data type	BOOL
ErrorID	Description	Indicates the error if Error output is TRUE. See table in PLCopen Function Block ErrorID Output.
	Data type	INT

2.2.7.17.5 Related Functions

[MC_ReadParam](#)

[MC_Stop](#)

[MC_WriteParam](#)

2.2.7.18.6 Examples

2.2.7.19.7.1 Function Block

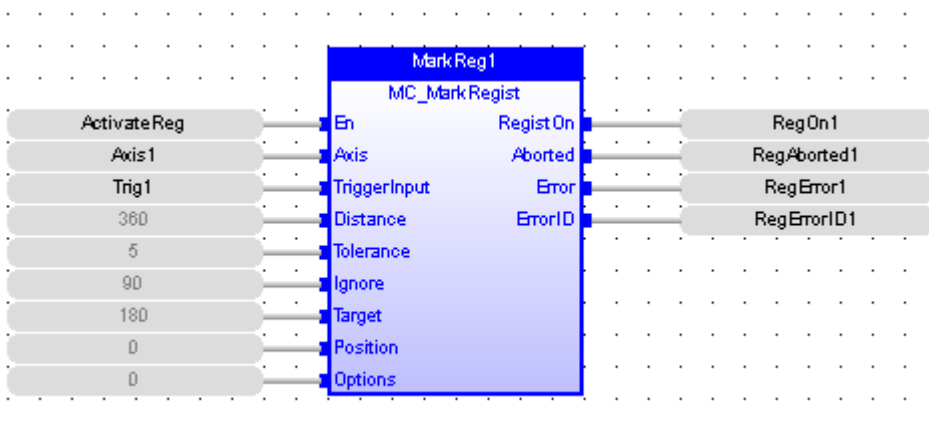

2.2.7.20.8.2 Instruction List

```
CAL Inst_MC_MarkRegist( ActivateReg, Axis1, Trig1, 360, 5, 90, 360, 0, 0 )
```

2.2.7.21.9.3 Ladder Diagram

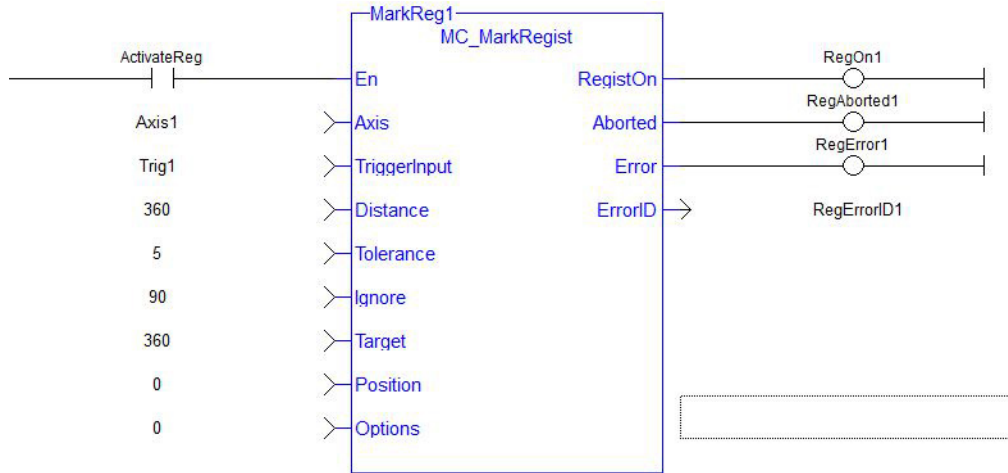

2.2.7.22.10.4 Structured Text

```
Inst_MC_MarkRegist( ActivateReg, Axis1, Trig1, 360, 5, 90, 360, 0, 0 );
```

2.2.7.23 MC_StopRegist PLCopen ✓

2.2.7.24.1 Description

This function will turn off registration for the specified axis and disarm the specified fast input.



2.2.7.25.2 Arguments

2.2.7.26.3.1 Input

En	Description	Enables execution
	Data type	BOOL
	Range	0, 1
	Unit	n/a
	Default	—
Axis	Description	Axis registration to turn off
	Data type	AXIS_REF
	Range	The range of .AXIS_NUM is [1,256]

	Unit	n/a
	Default	n/a
TriggerInput	Description	<p>Structure specifying the fast input to disarm. The structure elements are:</p> <p>InputID INT 0 = Capture Engine 0 1 = Capture Engine 1 Range is [0, 1] For information on configuring the capture engines, refer to AKD Capture Engine Configuration.</p> <p>Direction INT 1 = rising edge, 2 = falling edge, 3 = NA, 4 = toggle between both, falling edge first, 5 = toggle between both, rising edge first, range = [1, 5]</p> <p>TrigID INT Axis number of the fast input. 0 indicates this trigger axis is to be the same as the Axis input. range = [0, 256]</p> <div style="background-color: #f0f0f0; padding: 5px; border: 1px solid #ccc;"> <p style="text-align: center;">NOTE</p> <p>TrigMode INT (TriggerInput.TrigMode) is not presently supported by this function. The TriggerInput.Mode may be supported in a future software version.</p> </div>
	Data type	TRIGGER_REF
	Range	
	Unit	
	Default	

2.2.7.27.4.2 Outputs

OK	Description	Indicates function executed successfully
	Data type	BOOL

TIP

To use Capture Engine 1 modify the input PDOs that are used and add the Latch Position 1 parameter.

2.2.7.28.5 Related Functions

[MC_MachRegist](#)

[MC_MarkRegist](#)

2.2.7.29.6 Examples

2.2.7.30.7.1 Function Block



2.2.7.31.8.2 Ladder Diagram

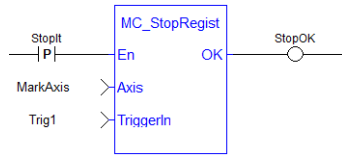

2.2.7.32.9.3 Structured Text

```
StopOK := MC_StopRegist( Axis1, Trig1);
```

2.2.8 Superimposed Axes

This feature allows the application program to superimpose the moves of multiple axes ("Superimposed Axes") on top of the move of another axis ("Receiving Axis"). This is performed internally by adding the command deltas of the Superimposed Axes to the command delta of the Receiving Axis. Up to four different Superimposed Axes can be superimposed upon a Receiving Axis.

See "MC_AddSuperAxis" (→ p. 449), "MC_RemSuperAxis" (→ p. 451) and PLCopen Function Blocks - Overview for more information.

2.2.8.1 MC_AddSuperAxis PLCopen ✓

This function will add a Superimposed Axis to the Axis's list of assigned superimposed axes. While the Superimposed Axis is on this list, its command deltas will be added to the Axis's command deltas. Up to four different superimposed axes can be on an axis's list. The `Axis` and the `SuperimposedAxis` must have the same update rate. The `OK` output will go high to indicate that the function executed successfully. If the `OK` output does not go high, one of the following errors was detected:

- Axis and SuperimposedAxis do not have the same update rate
- Four different superimposed axes have already been assigned to Axis
- Axis is not a valid axis - Axis is not a servo or virtual axis
- SuperimposedAxis is not a valid axis number
- SuperimposedAxis is not a servo or virtual axis

2.2.8.2.1 Inputs

En	Description
	Enables Execution
	Data Type BOOL
	Range n/a
	Unit n/a
	Default n/a

Axis	Description	Axis to receive the additional superimposed axis's command delta
	Data Type	AXIS_REF
	Range	.AXIS_NUM [1,256]
	Unit	n/a
	Default	n/a
SuperimposedAxis	Description	Axis number of the superimposed axis whose command delta will be added to delta of <code>Axis</code>
	Data Type	UINT
	Range	[1,256]
	Unit	n/a
	Default	n/a

2.2.8.3.2 Outputs

OK	Description	Execution successful
	Data Type	BOOL
	Range	n/a

2.2.8.4.3 Examples

2.2.8.5.4.1 Structured Text

```
AddOKST := MC_AddSuperAxis( Axis1, 3 );
```

2.2.8.6.5.2 Function Block Diagram

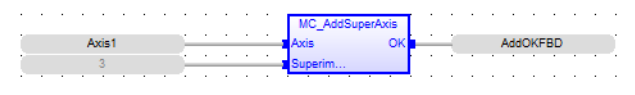

2.2.8.7.6.3 Ladder Diagram

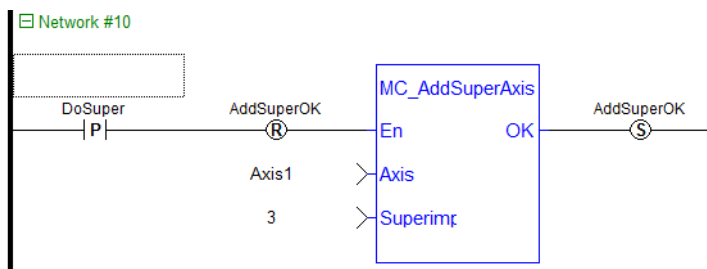

2.2.8.8.7 Related Functions

"MC_RemSuperAxis" (→ p. 451)

2.2.8.9 MC_RemSuperAxis

This function removes the Superimposed Axis from the Axis's list of assigned superimposed axes. If the value at `SuperimposedAxis` is 0 all the assigned superimposed axes will be removed from Axis's list. The `OK` output will go high to indicate that the function executed successfully. If the `OK` output does not go high, one of the following errors was detected:

- Axis is not a valid axis
- Axis is not a servo or virtual axis

2.2.8.10.1 Inputs

En	Description	Enables Execution
	Data Type	BOOL
	Range	-
	Unit	n/a
	Default	
Axis	Description	Axis whose list of assigned superimposed axes will be updated.
	Data Type	AXIS_REF
	Range	.AXIS_NUM [1,256]
	Unit	n/a
	Default	n/a
SuperimposedAxis	Description	Axis number of the superimposed axis that will be removed from Axis's list of assigned superimposed axes. A value of 0 will remove all superimposed axes from Axis's list.
	Data Type	UINT
	Range	n/a
	Unit	n/a
	Default	n/a

2.2.8.11.2 Outputs

OK	Description	Execution successful
	Data Type	BOOL
	Range	n/a

2.2.8.12.3 Examples

2.2.8.13.4.1 Structured Text

```
RemOK := MC_RemSuperAxis (Axis1, 3);
```

2.2.8.14.5.2 Function Block Diagram

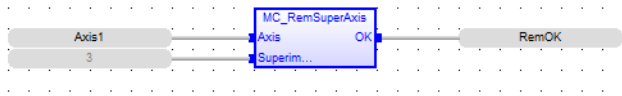

2.2.8.15.6.3 Ladder Diagram

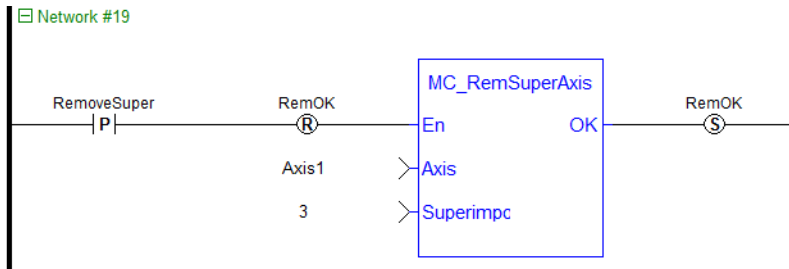

2.2.8.16.7 Related Functions

"MC_AddSuperAxis" (→ p. 449)

2.3 MotionLibrary- Common

Functions sorted in alphabetical order.

Name	Description	Return type
"MC_ErrorDescription" (→ p. 453)	Return a text description corresponding to a motion control error ID code	STRING
"MLMotionCycleTime" (→ p. 470)	Returns the Motion Base Cycle time in Seconds	
"MLMotionInit" (→ p. 471)	Initializes the motion library. Must be called before any other Motion Library function. Returns TRUE if the function succeeded. BasePeriod is the duration of one motion cycle in microseconds.	BOOL
"MLMotionRstErr" (→ p. 473)	Clears motion engine errors, motion bus driver errors, and EtherCAT network errors. MLMotionRstErr will return the motion engine status to the Stopped state, if an error condition was cleared successfully. Returns TRUE if the function succeeded.	BOOL
"MLMotionStart" (→ p. 474)	Starts the motion engine, motion bus driver, and initializes EtherCAT network to operational mode. Applicable to PLCopen and PipesNetwork motion engines. Returns TRUE if the function succeeded.	BOOL
"MLMotionStatus" (→ p. 475)	Returns the status of the motion engine 0: Not initialized 1: Running 2: Stopped 3: Error	None
"MLMotionStop" (→ p. 477)	Stops the motion bus driver, motion engine, and EtherCAT network operation, resulting in the EtherCAT network transitioning to the Init state. Returns TRUE if the function succeeded.	BOOL
"MLMotionSysTime" (→ p. 478)	Prints the system time to the log	BOOL

Name	Description	Return type
"MLProfileBuild" (→ p. 455)	Builds a cam profile from application data	See "Output" (→ p. 458)
"MLProfileCreate" (→ p. 463)	Creates a new cam profile object	None
"MLProfileInit" (→ p. 464)	Initializes a previously created cam profile object	BOOL
"MLProfileRelease" (→ p. 467)	Removes a Profile so the Profile ID may be used by a different or new Profile.	See "Output" (→ p. 468)

2.3.1 Motion Library - Common - Info

Name	Description	Return type
"MC_ErrorDescription" (→ p. 453)	Converts the PLCopen error IDs into message strings.	String

2.3.1.1 MC_ErrorDescription

This function converts the PLCopen error IDs into message strings which can be used for display or logging.

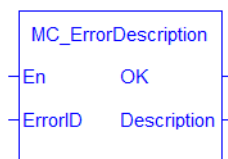

Figure 1-90: MC_ErrorDescription Function Block

2.3.1.2.1 Arguments

2.3.1.3.2.1 Inputs

En	Description	If True, then this function will convert the Error Id into a string message
	Data type	BOOL
	Range	0, 1
	Unit	n/a
	Default	—
ErrorID	Description	Error ID generated from a PLCopen Function Block. See PLCopen Function Block ErrorID Output for output details.
	Data type	INT
	Range	0,69

Unit	n/a
Default	—

2.3.1.4.3.2 Outputs

OK	Description	If True, then the command completed successfully.
	Data type	BOOL
	Range	0, 1
	Unit	n/a
	Default	—
Description	Description	String error description
	Data type	STRING
	Range	—
	Unit	n/a
	Default	—

2.3.1.5.4 Examples

2.3.1.6.5.1 Structured Text

```
Description := MC_ErrorDescription(ErrorID);
```

2.3.1.7.6.2 IL

Not applicable

2.3.1.8.7.3 Function Block



2.3.1.9.8.4 Ladder Diagram

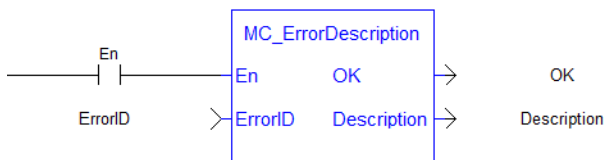

2.3.2 Motion Library - Common - Profiles

Name	Description	Return type
"MLProfileBuild" (→ p. 455)	Builds a cam profile from application data	See "Output" (→ p. 458)
"MLProfileCreate" (→ p. 463)	Creates a new cam profile object	None

Name	Description	Return type
"MLProfileInit" (→ p. 464)	Initializes a previously created cam profile object	BOOL
"MLProfileRelease" (→ p. 467)	Removes a Profile so the Profile ID may be used by a different or new Profile.	See "Output" (→ p. 468)

2.3.2.1 MLProfileBuild

2.3.2.2.1 Description

This Function Block allows the application to create a cam profile that may be executed by a cam block in PipeNetwork or PLCopen. This Function Block will take input as cam data (see Cam Profile Editor's Cam Table for information) and profile properties from application data memory and compile the input data to a form the controller can use to calculate cam positions. The input cam data and profile properties are similar to the cam data entered in the IDE's Cam Editor and the runtime's Cam Profile Properties dialog. MLProfileBuild internally perform two functions:

1. Compile the cam data (like the cam editor performs in the IDE).
2. Puts the compiled profile into the profile object so it can be used by other Profile Function Blocks (provides similar functionality to "MLProfileInit" (→ p. 464)).

NOTE

Prior to using MLProfileBuild you must call "MLProfileCreate" (→ p. 463) to create the profile object. The ID output of MLProfileCreate is then used as the ProfileID input to MLProfileBuild. MLProfileCreate must be performed in the application *before* the "MLMotionStart" (→ p. 474) command is executed.

MLProfileBuild will compile the cam profile data specified at the CamData input and write the resulting profile to the CAM Profile object specified at input ProfileID. The created profile can then be used as an input to PLCopen Cam Function Blocks ([MC_CamTblSelect](#), [MC_CamIn](#), [MC_CamOut](#)), or any Pipe network Cam Profile Function/Function Blocks. When the operation is complete, the Done output will go high. If an error is encountered, the Error output will go high and the ErrorID output will return a error code. If the Error can be attributed to a specific profile element in the CamData array, ErrorElem will attempt to indicate the element in error.

2.3.2.3.2.1 CamProps_Ref Structure

The cam properties structure (CamProps_Ref) will contain the following data members:

Parameter	Type	Description
InputScale	LREAL	The input amplitude or master axis multiplier applied to the CAM profile
OutputScale	LREAL	The output amplitude or slave axis multiplier applied to the CAM profile
InputOffset	LREAL	input offset or master axis shift applied to the CAM profile
OutputOffset	LREAL	The output offset or slave axis shift applied to the CAM profile

See Master/Input offset for more information about the parameters which transform the cam profile.

2.3.2.4.3.2 CamData_Ref Structure

The Cam_Data function block input will be an array of CamData_Ref structures. Each element of the structure will contain the following data members:

Parameter	Type	Description
MasterIn	LREAL	master position (in the unit range [0 - InputScale])
SlaveOut	LREAL	slave position (in the unit range [0 - OutputScale])

Parameter	Type	Description
SegType	UINT	Defines the segment type for the segment following the master positions defined by MasterIn . CAM_SEGMENT_TYPE_POINT = Point 5 th order polynomial) CAM_SEGMENT_TYPE_LINE = Line (constant velocity segment) CAM_SEGMENT_TYPE_PARABOLIC = Parabolic (constant acceleration) See Cam Profile Segment Overview for information on the segment types.
Vel	LREAL	Cam velocity at the master position specified by MasterIn . Units: (slave position user units) / (master position user units)
Accel	LREAL	<u>For CAM_SEGMENT_TYPE_POINT:</u> Accel represents the cam acceleration at the master position specified by MasterIn . Units: (slave position user units) / (master position user units) <u>For CAM_SEGMENT_TYPE_LINE and CAM_SEGMENT_TYPE_PARABOLIC:</u> Accel is ignored.

The type of the Nth cam segment is defined by the Nth Cam_Data element. Since the cam will be constructed with one less segment than the Cam_Data elements, the last element's SegType will not be used.

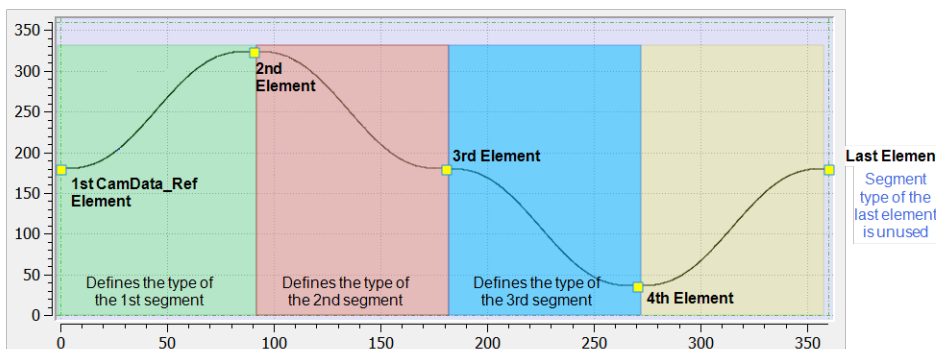

See Cam Profile Editor's Cam Table for more information.

2.3.2.5.4 Arguments

2.3.2.6.5.1 Input

Enable	Description	Enable execution. Starts on rising edge.
	Data Type	BOOL
	Range	
	Unit	
	Default	

Cam_Props	Description	Structures containing the cam profile properties
	Data Type	CamProps_ref
	Range	
	Unit	
	Default	
Cam_Data	Description	Array of structures containing the cam profile data
	Data Type	CamData_ref
	Range	N=3 to 2000 elements
	Unit	
	Default	3 elements minimum size
CamDataCount	Description	Number of elements in the Cam_Data array to be used.
	Data Type	UINT
	Range	3 - 2000
	Unit	elements
	Default	3
ProfileID	Description	ID number of a created CAM Profile
	Data Type	DINT
	Range	[-2147483648, 2147483648]
	Unit	n/a
	Default	--
Cyclic	Description	False: one time through the profile; True: repeating profile
	Data Type	BOOL
	Range	0-1 (FALSE/TRUE)
	Unit	
	Default	

Options	Description	Describes the combinations of segments that may be used to build a cam profile.
	Data Type	UINT
	Range	CAM_PROFILE_OPTION_DEFAULT: Allows the use of point and line segments. CAM_PROFILE_OPTION_PARABOLIC: Allows the use of line and parabolic segments.
	NOTE	
	The DEFAULT and PARABOLIC options cannot be combined. A cam profile can only use point and line segments, or parabolic and line segments. Point and parabolic segments cannot both be used in the same profile.	
	Unit	
Default		

2.3.2.7.6.2 Output

Done	Description	Indication of whether or not the profile was successfully compiled and built.
	Data Type	BOOL
	Range	0-1 (FALSE/TRUE)
	Unit	
Busy	Description	Indication that the function block is executing. TRUE if executing. False if not executing.
	Data Type	BOOL
	Range	0-1 (FALSE/TRUE)
	Unit	
Err	Description	Indication that the function did not execute correctly. ErrorID output will be valid and indicate the reason.
	Data Type	BOOL
	Range	0-1 (FALSE/TRUE)
	Unit	
ErrorID	Description	Indication of the reason for the failure to execute properly. See "Error Codes" (→ p. 459) table.
	Data Type	INT
	Range	
	Unit	

ErrorElem	Description	The array element number of the cam data where an error is detected
	Data Type	UINT
	Range	
	Unit	

2.3.2.8.7 Error Codes

NOTE

If **Cyclic** is TRUE and the Vel/Accel of the first and last elements do not match, MLProfileBuild will automatically copy the first element's vel/accel to the last element's. A LOG warning message will be posted indicating that this change has occurred.

ErrorID	Description
100	Cam_Data array does not have CamDataCount elements. The Cam_Data array is not large enough to hold the specified number of elements.
101	Invalid master or slave scale. The scale cannot be less than zero.
102	Element master or slave position is outside the range defined by Cam_Props.
103	A segment type was specified that is not supported by the value of the Options argument.
104	Master position of an element is too close to the master position of a previous element. $0.0005 * \text{InputScale}$ (see "CamProps_Ref Structure" on page 455) is the minimum distance allowed.. Each element is compared to all previous elements. If the master distance between any two elements in the list are too close, this error will be generated.
106	Invalid profile ID. This can occur if the profile ID: <ul style="list-style-type: none"> 1. does not exist 2. has not been created yet 3. profile ID is not a profile
107	CamDataCount exceeds maximum array size of 2000.
108	Profile is currently in use.
109	Attempting to build a profile already containing elements. Profile needs to be released first using MLProfileRelease.
110	The controller is running low on memory and could not allocate memory to hold the cam table data.
111	CamDataCount is not large enough. The minimum allowed value is 3.
112	For CAM_PROFILE_OPTION_PARABOLIC: Elements are not sorted in increasing order by master position. After the first element, each element must have its master position be greater than the master position of the previous element.

ErrorID	Description
113	<p>For CAM_SEGMENT_TYPE_PARABOLIC: The average velocity for the segment is outside of range defined by start and end element velocities. The following diagram illustrates the valid range for the average velocity.</p> <p>Cam Velocity Profile</p>
200	First element's <code>MasterIn</code> value not equal to zero.
201	Last element's <code>MasterIn</code> value does not equal value of X-amplitude.
202	Cannot modify the first element in the cam element table. <code>SlaveOut</code> value is outside the output range specified by <code>Cam_Props</code> .
203	Cannot modify the last element in the cam element table. <code>SlaveOut</code> value is outside the output range specified by <code>Cam_Props</code> .

2.3.2.9.8 Related Functions

"MLCamInit" (→ p. 177)

"MLCamSwitch" (→ p. 179)

"MLProfileCreate" (→ p. 463)

"MLProfileInit" (→ p. 464)

"MLProfileRelease" (→ p. 467)

"MC_CamIn" (→ p. 390)

"MC_CamOut" (→ p. 397)

[MC_CamTblSelect](#)

2.3.2.10.9 Example of How to Use MLProfileBuild

Prior to using `MLProfileBuild` you must first create a profile. This must be done prior to `MLMotionStart`.

```
// Allocate space for a profile that will be built later
profileID := MLProfileCreate('ProfileName');
```

Next you need to define your profile data. This is done by creating an array of `CamData_Ref` structures in the data dictionary and then entering each of your elements into that newly created structure. In this example `ProfileData` is the name of the `CamData_Ref` structure.

```
// Define the profile data
ProfileData[0].MasterIn := 0.0;
```

```

ProfileData[0].SlaveOut := 180.0;
ProfileData[0].SegType := CAM_SEGMENT_TYPE_POINT;
ProfileData[0].Velocity := 0.0;
ProfileData[0].Acceleration := 0.0;

ProfileData[1].MasterIn := 180.0;
ProfileData[1].SlaveOut := 324.0;
ProfileData[1].SegType := CAM_SEGMENT_TYPE_POINT;
ProfileData[1].Velocity := 0.5;
ProfileData[1].Acceleration := -0.025;

ProfileData[2].MasterIn := 360.0;
ProfileData[2].SlaveOut := 240.0;
ProfileData[2].SegType := CAM_SEGMENT_TYPE_POINT;
ProfileData[2].Velocity := 0.0;
ProfileData[2].Acceleration := 0.0;

```

Now you need to define your profile properties. This is done by creating a CamProps_Ref structure in the data dictionary and then entering each of the properties into the newly created structure. In this example ProfileProps is the name of the CamProps_Ref structure.

```

// Define the profile properties
ProfileProps.InputScale := 360.0; // Must be Positive!
ProfileProps.OutputScale := 360.0; // Must be Positive!
ProfileProps.InputOffset := 0.0;
ProfileProps.OutputOffset := 0.0;

```

Next call the MLProfileBuild Function Block in the IEC language of choice. As part of this call it is recommended that you validate the Done and Error output before proceeding.

```

// Build the profile
Inst_MLProfileBuild( TRUE, ProfileProps, ProfileData, 3,
ProfileID, TRUE, CAM_PROFILE_OPTION_DEFAULT);

```

Finally, after verifying that MLProfileBuild is Done and there are no errors, you can proceed and use the newly generated profile. The next step depends on the motion engine in use.

- PLCopen: call "MC_CamTblSelect" (→ p. 406)
- Pipe Network: call either "MLCamInit" (→ p. 177) or "MLCamSwitch" (→ p. 179)

NOTE

Pipe Network: In order to correctly set the cam scales and offsets (defined by the Cam_Props argument) "MLPrfWriteIScale" (→ p. 186), "MLPrfWriteOScale" (→ p. 189), "MLPrfWriteIOffset" (→ p. 185) and "MLPrfWriteOOffset" (→ p. 188) must be called before calling "MLCamSwitch" (→ p. 179),

```

// Switch Pipe Network Profile
MLPrfWriteIScale(profileID, ProfileProps.InputScale);
MLPrfWriteOScale(profileID, ProfileProps.OutputScale);
MLPrfWriteIOffset(profileID, ProfileProps.InputOffset);
MLPrfWriteOOffset(profileID, ProfileProps.OutputOffset);
MLCamSwitch(PipeNetwork.CAM, profileID);

```

2.3.2.11.10 Example of Building a Parabolic Cam Profile

In order to build a parabolic cam profile, your cam data elements must use `CAM_SEGMENT_TYPE_PARABOLIC` or `CAM_SEGMENT_TYPE_LINE` when defining the cam data array:

```
// Define the profile data
ProfileData[0].MasterIn      := 0.0;
ProfileData[0].SlaveOut     := 0.0;
ProfileData[0].SegType      := CAM_SEGMENT_TYPE_PARABOLIC;
ProfileData[0].Velocity     := 0.0;
ProfileData[0].Acceleration := 0.5;

ProfileData[1].MasterIn      := 50.0;
ProfileData[1].SlaveOut     := 150.0;
ProfileData[1].SegType      := CAM_SEGMENT_TYPE_LINE;
ProfileData[1].Velocity     := 5.0;
ProfileData[1].Acceleration := 0.0;           // Not used

ProfileData[2].MasterIn      := 55.0;
ProfileData[2].SlaveOut     := 175.0;
ProfileData[2].SegType      := CAM_SEGMENT_TYPE_PARABOLIC;
ProfileData[2].Velocity     := 5.0;
ProfileData[2].Acceleration := 0.0;           // No limit to the
acceleration rate of the segment.

ProfileData[3].MasterIn      := 105.0;
ProfileData[3].SlaveOut     := 250.0;
ProfileData[3].SegType      := CAM_SEGMENT_TYPE_PARABOLIC;
ProfileData[3].Velocity     := 0.0;
ProfileData[3].Acceleration := 0.5;

ProfileData[4].MasterIn      := 225.0;
ProfileData[4].SlaveOut     := 125.0;
ProfileData[4].SegType      := CAM_SEGMENT_TYPE_PARABOLIC;
ProfileData[4].Velocity     := -10.0;
ProfileData[4].Acceleration := 0.5;

ProfileData[5].MasterIn      := 360.0;
ProfileData[5].SlaveOut     := 0.0;
ProfileData[5].SegType      := CAM_SEGMENT_TYPE_PARABOLIC;           //
Not used
ProfileData[5].Velocity     := 0.0;
ProfileData[5].Acceleration := 0.0;           // Not used
```

When calling the `MLProfileBuild` function block, make sure `CAM_PROFILE_OPTION_PARABOLIC` is specified for the `Option` argument: in the IEC language of choice. As part of this call it is recommended that you validate the **Done** and **Error** output before proceeding.

```
// Build the profile
Inst_MLProfileBuild( TRUE, ProfileProps, ProfileData, 3,
ProfileID, TRUE, CAM_PROFILE_OPTION_PARABOLIC);
```

2.3.2.12.11 Code Examples

Structured Text:

```
// Build the profile
Inst_MLProfileBuild( TRUE, ProfileProps, ProfileData, 3,
ProfileID, TRUE, CAM_PROFILE_OPTION_DEFAULT);
```

Function Block Diagram:

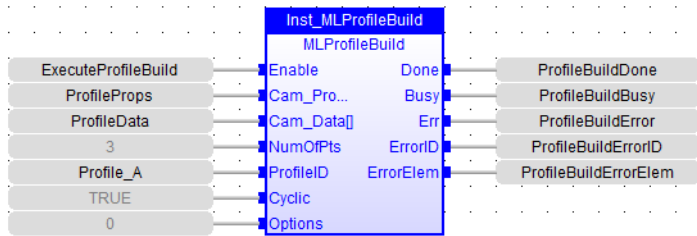

Ladder Diagram:

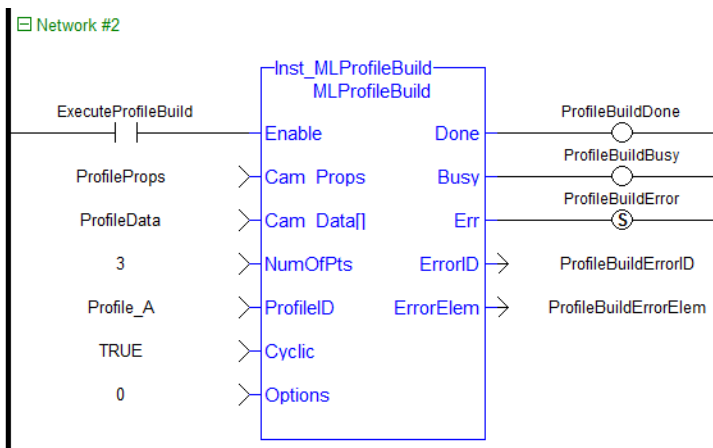

2.3.2.13 MLProfileCreate PLCopen ✓ Pipe Network ✓

2.3.2.14.1 Description

Creates a new Profile Object for use in a PLC Program or Pipe Network CAM block. This function block is automatically called if a Profile is created in the Project Explorer, with user-defined settings then entered in the CAM Profile Properties screen.

Profiles are created and initiated separately and the shape is modified with the CAM Editor. With the Editor profiles can be changed graphically or by manually changing values in a numeric table relating input and output values with specific slopes. The Cam Editor software tool provides the capability to visualize, analyze, edit, and smooth profiles.

Profile switching can be done on the fly, without losing synchronization and without dead time. In addition, the offsets and ratios of CAM Profiles can be changed on the fly.

NOTE

Profile objects are normally created in the Project Explorer. Then you do not have to add MLCamInit function blocks to their programs. By right clicking the Profiles folder under the PLC->Motion Tree, you can select Add new profile. Parameters are entered directly in a pop-up window, and the code is then automatically added to the current project.

TIP

This function must be called or executed before "MLMotionStart" (→ p. 474) is called.

2.3.2.15.2 Arguments

2.3.2.16.3.1 Input

Name	Description	Name of initialized CAM Profile
	Data type	STRING
	Range	—
	Unit	n/a
	Default	—

2.3.2.17.4.2 Output

OK	Description	Indicates the profile has been created
	Data type	BOOL
ID	Description	Returns the ID number of the created CAM Profile
	Data type	DINT
	Unit	n/a

2.3.2.18.5 Related Functions

"MLProfileInit" (→ p. 464)

"MLCamInit" (→ p. 177)

2.3.2.19.6 Example

2.3.2.20.7.1 Structured Text

```
//Create a new Profile
Profile_A := MLProfileCreate( 'Profile_A' );
```

2.3.2.21.8.2 Ladder Diagram

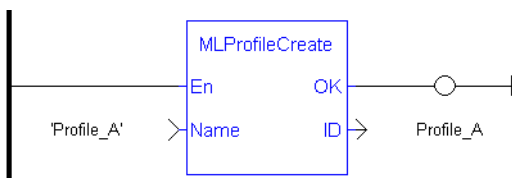

2.3.2.22.9.3 Function Block Diagram



2.3.2.23 MLProfileInit PLCopen ✓ Pipe Network ✓

2.3.2.24.1 Description

Initializes a previously created CAM Profile object for use in a PLC Program or Pipe Network CAM block. This function block is automatically called if a Profile is created in the Project Explorer, with user-defined settings then entered in the CAM Profile Properties screen.

Profiles are created and initiated separately and the shape is modified with the CAM Editor. With the Editor profiles can be changed graphically or by manually changing values in a numeric table relating input and output values with specific slopes. The Cam Editor software tool provides the capability to visualize, analyze, edit, and smooth profiles.

Profile switching can be done on the fly, without losing synchronization and without dead time. In addition, the offsets and ratios of CAM Profiles can be changed on the fly.

NOTE

Profile objects are normally initiated in the Project Explorer. Then you do not have to add MLCamInit function blocks to their programs. By right clicking the Profiles folder under the PLC->Motion Tree, you can select Add new profile. Parameters are entered directly in a pop-up window, and the code is then automatically added to the current project.

TIP

Loading a Profile Editor-generated profile into a ProfileID released by MLProfileRelease should be done with care. The MLProfileInit () function call can take in excess of 4 milliseconds to execute. Application execution is suspended during this time until the function call is completed.

2.3.2.25.2 Arguments

2.3.2.26.3.1 Input

ProfileID	Description	ID number of a created CAM Profile
	Data type	DINT
	Range	[-2147483648, 2147483648]
	Unit	n/a
	Default	—
FileName	Description	Filename used to save Profile on the computer's hard disk
	Data type	STRING
	Range	—
	Unit	n/a
	Default	—
InputScale	Description	The input amplitude or x-axis multiplier applied to the CAM Profile
	Data type	LREAL
	Range	Positive
	Unit	n/a
	Default	—

OutputScale	Description	The output amplitude or y-axis multiplier applied to the CAM Profile
	Data type	LREAL
	Range	—
	Unit	n/a
	Default	—
InputOffset	Description	The input offset or x-axis shift applied to the CAM Profile.
	Data type	LREAL
	Range	—
	Unit	n/a
	Default	—
OutputOffset	Description	The output offset or y-axis shift applied to the CAM Profile
	Data type	LREAL
	Range	—
	Unit	n/a
	Default	—

2.3.2.27.4.2 Output

Default (.Q)	Description	Returns TRUE if a new CAM Profile is initialized
	Data type	BOOL
	Unit	n/a

2.3.2.28.5.3 Return Type

BOOL

2.3.2.29.6 Related Functions

"MLProfileCreate" (→ p. 463)

"MLCamInit" (→ p. 177)

2.3.2.30.7 Example

2.3.2.31.8.1 Structured Text

```
//Initialize a previously created CAM Profile
MLProfileCreate( Profile_A , 'Profile_A.5op' , 360, 360, 0, 0
);
```

2.3.2.32.9.2 Ladder Diagram

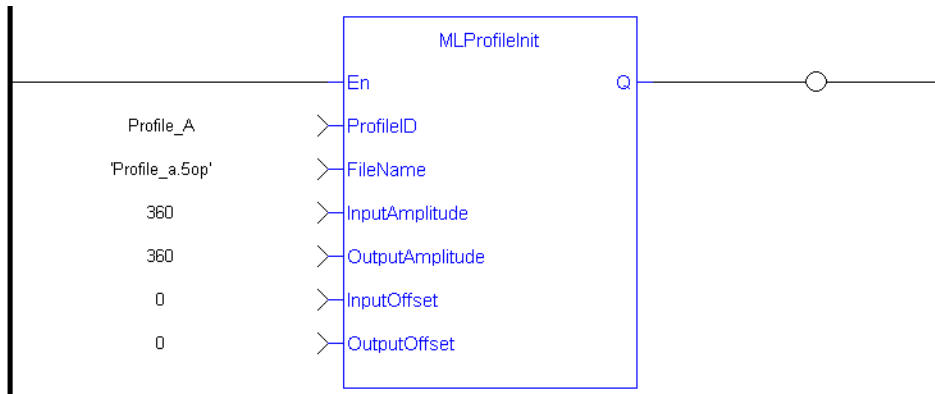

2.3.2.33.10.3 Function Block Diagram

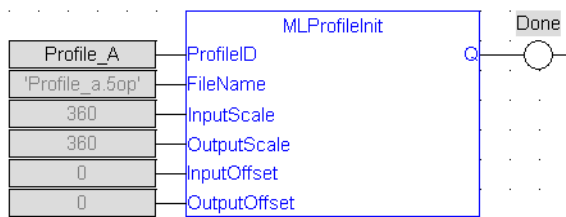

2.3.2.34 MLProfileRelease PLCopen ✓ Pipe Network ✓

An application program is limited to 256 Profile ID's. This FB releases an existing profile ID definition so that the profile ID can be used for a different/new Profile (minimizing the risk of reaching 256 Profile ID's). Once the existing Profile ID definition has been successfully released, the Profile ID can then be used by either "MLProfileInit" (→ p. 464) or "MLProfileBuild" (→ p. 455) to create a new Profile.

The Profile ID selected by the input parameter must not be in-use by a motion engine. In-use is defined as:

- For Pipe Network – it must not be currently selected for use by an active CAM block in an active pipe. Pipe has been activated by "MLCamSwitch" (→ p. 179).
- For PLCOpen – selected for use by "MC_CamIn" (→ p. 390) and has an active move.

There are a number of ways to change an in-use profile to one that is not in-use (deactivated):

- For Pipe Network – Perform a "MLCamSwitch" (→ p. 179) on an active Pipe to a different Profile or deactivate the pipe.
- For PLCOpen – whenever the active profile move is halted or aborted, the profile is no longer in use. "MC_CamOut" (→ p. 397) is one way of aborting the profile move. Actually, any PLCopen motion command that aborts a profile move will also deactivate a profile.

NOTE

Any profile ID created by [MC_CamTblSelect](#) from the specified ProfileID will be destroyed and need to be recreated upon completion of this FB. This means that all derived profile ID's created by MC_CamTblSelect FB must also not be in use by the PLCopen motion engine in order for this function to succeed.

TIP

Loading a Profile Editor-generated profile into a ProfileID released by MLProfileRelease should be done with care. The MLProfileInit () function call can take in excess of 4 milliseconds to execute. Application execution is suspended during this time until the function call is completed.

2.3.2.35.1 Arguments

For more information on how Arguments work, refer to PLCopen function blocks - General rules .

2.3.2.36.2.1 Input

Enable	Description	Enable execution of the function block. Successful completion will result in a profile ID that is no longer assigned to a specific profile and can be reused for a different/new Profile. Prior to reusing this Profile ID it will need to be re-initialized by either an MLProfileInit Function call or by calling MLProfileBuild.
	Data Type	BOOL
	Range	0, 1
	Unit	
	Default	0
ProfileID	Description	Specify a Profile ID that has been created by MLProfileCreate. This is the profile ID that will be released so it can be reused for different/new Profiles. This Profile ID must not be in use by a motion engine.
	Data Type	DINT
	Range	1 to 256
	Unit	
	Default	0

2.3.2.37.3.2 Output

Done	Description	If high, Successful completion. The Profile can now be reused.
	Data Type	BOOL
	Range	0, 1
Err	Description	If high, the Function Block did not complete successfully. Reason is given in Error ID.
	Data Type	BOOL
	Range	0, 1
ErrorID	Description	Indicates the reason for the failure. See "Error Codes" (→ p. 468) table for possible reasons.
	Data Type	INT
	Range	

2.3.2.38.4 Error Codes

ErrorID	Description
106	Invalid profile ID. Profile ID: <ol style="list-style-type: none"> 1. does not exist 2. has not been created yet 3. profile ID is not a profile
108	Profile cannot be released because it is in use by the motion engine or currently selected by an active CAM block.

2.3.2.39.5 Related Functions

"MLProfileCreate" (→ p. 463)

"MLProfileInit" (→ p. 464)

"MLProfileBuild" (→ p. 455)

"MLCamInit" (→ p. 177)

"MC_CamTblSelect" (→ p. 406)

"MC_CamIn" (→ p. 390)

"MC_CamOut" (→ p. 397)

2.3.2.40.6 Example

2.3.2.41.7.1 Structured Text

```
//Release a Cam Profile
Inst_MLProfileRelease( Profile_A , 'Profile_A.5op');

If Inst_MLProfileRelease.Done THEN
  // Do Something
ELSIF Inst_MLProfileRelease.Err THEN
  // Handle Error
END_IF;
```

2.3.2.42.8.2 Ladder Diagram

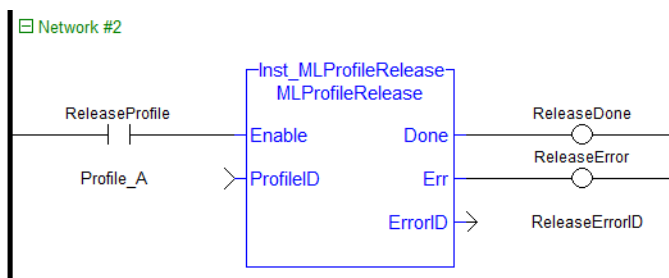

2.3.2.43.9.3 Function Block Diagram

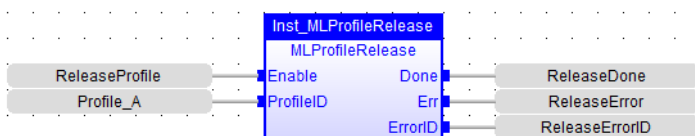

2.3.3 Motion Library

Name	Description	Return type
"MLMotionInit" (→ p. 471)	Initializes the motion library. Must be called before any other Motion Library function. Returns TRUE if the function succeeded. BasePeriod is the duration of one motion cycle in microseconds.	BOOL
"MLMotionStart" (→ p. 474)	Starts the motion engine, motion bus driver, and initializes EtherCAT network to operational mode. Applicable to PLCopen and PipesNetwork motion engines. Returns TRUE if the function succeeded.	BOOL
"MLMotionStatus" (→ p. 475)	Returns the status of the motion engine 0: Not initialized 1: Running 2: Stopped 3: Error	None
"MLMotionStop" (→ p. 477)	Stops the motion bus driver, motion engine, and EtherCAT network operation, resulting in the EtherCAT network transitioning to the Init state. Returns TRUE if the function succeeded.	BOOL
"MLMotionSysTime" (→ p. 478)	Prints the system time to the log	BOOL
"MLMotionCycleTime" (→ p. 470)	Returns the Motion Base Cycle time in seconds.	

2.3.3.1 State Machine

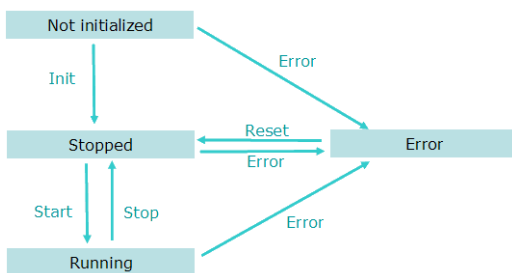

Figure 1-91: Motion State Machine

The Motion State Machine is driven by the IEC 61131-3 application with the help of the "Motion Library" (→ p. 469) function blocks.

Each arrow represents a transition from one State to another one.

2.3.3.2 MLMotionCycleTime PLCopen ✓ Pipe Network ✓

Returns the Motion Base Cycle time in seconds.

2.3.3.3.1 Arguments

2.3.3.4.2.1 Input

Enable	Description
	Data type
	Range
	Unit
	Default

2.3.3.5.3.2 Output

OK	Description
	Data type
CycleTime	Description Cycle time in seconds
	Data type
	Unit

2.3.3.6.4 Example

2.3.3.7.5.1 Structured Text

```
//Read EtherCAT cycle rate in ms
lrCycleTime:= MLMotionCycleTime();
```

2.3.3.8.6.2 Ladder Diagram

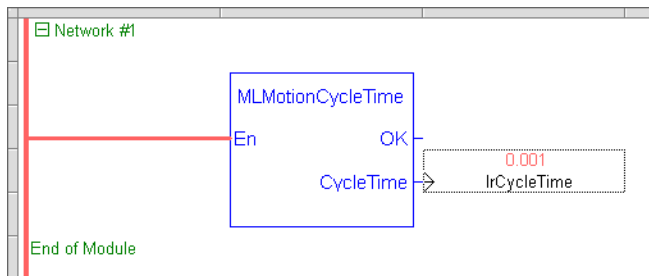

2.3.3.9.7.3 Function Block Diagram



2.3.3.10 MLMotionInit PLCopen ✓ Pipe Network ✓

2.3.3.11.1 Description

Initializes the motion library. Must be called before any other Motion Library function. Returns TRUE if the function succeeded.

NOTE

The BasePeriod argument establishes the base cycle time (in microseconds) for the Motion Engine when running simulations without the EtherCAT Motion Bus. When the EtherCAT Motion Bus is present, the EtherCAT cycle time overrides the BasePeriod argument (the cycle time is defined in the Master tab). The EtherCAT cycle time then becomes the base cycle time for the Motion Engine.

2.3.3.12.2 Parameter

BasePeriod : LREAL (input)

2.3.3.13.3 Return Type

BOOL

2.3.3.14.4 Example

2.3.3.15.5.1 ST

```

//Initialization code to start EtherCAT network.
//First initialize network with MLMotionInit command
//Then wait for command to finish by monitoring MLMotionStatus
output
//Once initialized, create any cam profiles and PLCopen or
Pipenetwork devices
//Then call MLMotionStart and monitor MLMotionStatus again
before beginning rest of program
FirstCycle := TRUE;

On FirstCycle DO //Initialize the motion engine
  MLMotionInit( 1000);
END_DO;

MotionEngineStatus := MLMotionStatus();//Check the current
status of the motion engine
//Once motion engine is initialized, create CAM profiles and
defined Axis, then start the motion engine
ON MotionEngineStatus = MLSTATUS_INITIALISED DO
  Profiles( MLPR_CREATE_PROFILES );
  PLCopen( 0 );
  MLMotionStart();
END_DO;

IF MotionEngineStatus = MLSTATUS_RUNNING THEN
  bMotionEngineStarted := TRUE;
ELSE
  bMotionEngineStarted := FALSE;
END_IF;

```

2.3.3.16.6.2 FBD



2.3.3.17.7.3 FFLD

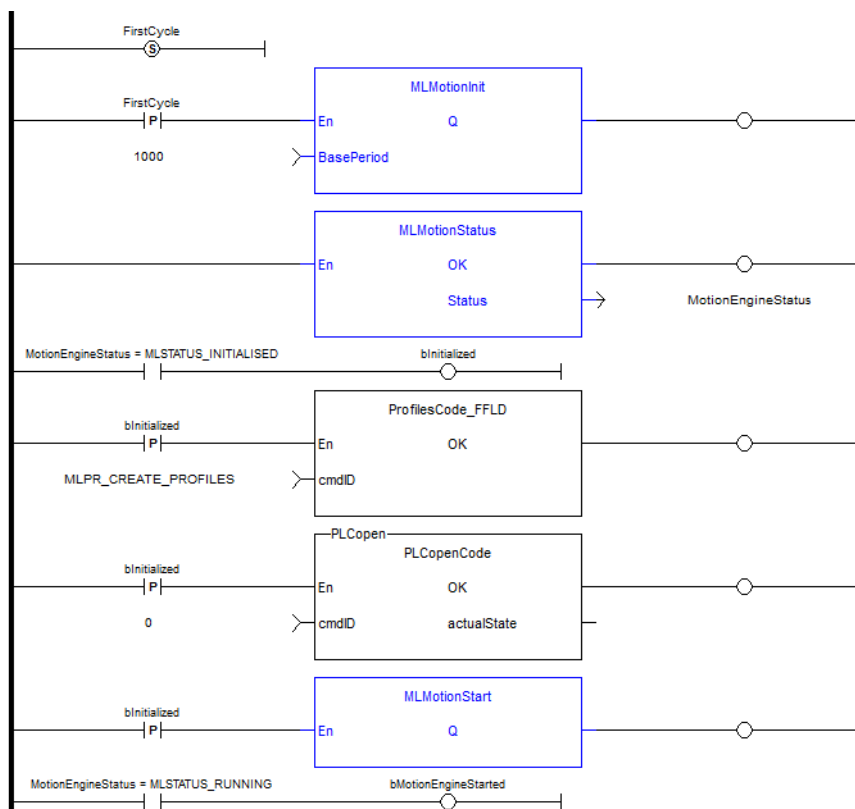

2.3.3.18 MLMotionRstErr PLCopen ✓ Pipe Network ✓

2.3.3.19.1 Description

Clears motion engine errors, motion bus driver errors, and EtherCAT network errors. `MLMotionRstErr` will return the motion engine status to the Stopped state. Returns TRUE if the function succeeded.

See also: "`MLMotionStatus`" (→ p. 475), "`MLMotionStop`" (→ p. 477), "`MLMotionStart`" (→ p. 474)

2.3.3.20.2 Return Type

BOOL

2.3.3.21.3 Example

2.3.3.22.4.1 ST

```
//Reset and restart motion engine
//Done to restart ethercat after controller error such as
//E30 or E33 that stops network communication
//First have to reset error, then start network again

ON ResetMotionEngineError DO
  MLMotionRstErr();
END_DO;

MotionEngineStatus:= MLMotionStatus();

ON StartMotionEngine DO
  MLMotionStart();
END_DO;
```

2.3.3.23.5.2 FBD

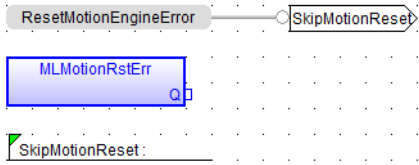

2.3.3.24.6.3 FFLD

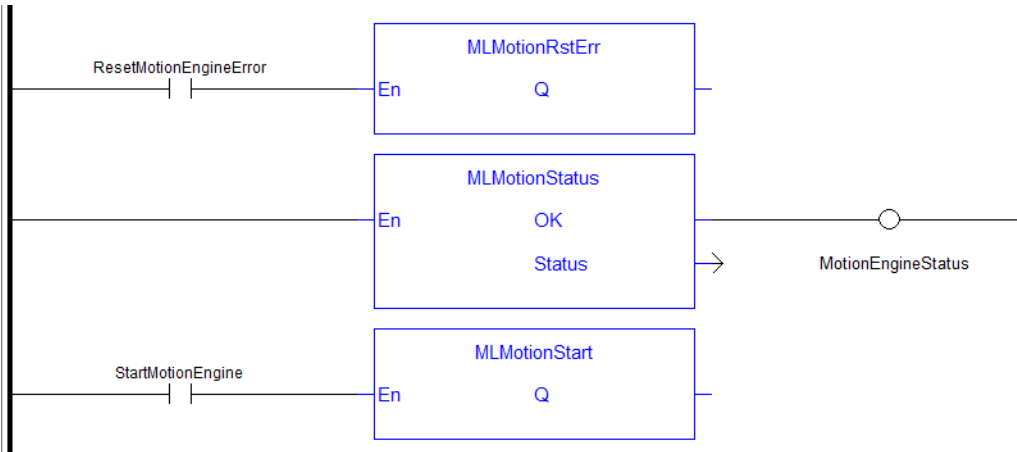

2.3.3.25 MLMotionStart PLCopen ✓ Pipe Network ✓

2.3.3.26.1 Description

Starts the motion engine, motion bus driver, clears the EtherCAT diagnostic registers of all nodes, and initializes EtherCAT network to operational mode. Applicable to PLCopen and PipesNetwork motion engines. MLMotionStart does not clear any pre-existing error conditions. Returns TRUE if the function succeeded. If motion engine is in the Error state, MLMotionStart will return FALSE.

See also: "MLMotionStop" (→ p. 477), "MLMotionRstErr" (→ p. 473), "MLMotionStatus" (→ p. 475)

2.3.3.27.2 Return Type

BOOL

2.3.3.28.3 Example

2.3.3.29.4.1 ST

```

//Initialization code to start EtherCAT network.
//First initialize network with MLMotionInit command
//Then wait for command to finish by monitoring MLMotionStatus
output
//Once initialized, create any cam profiles and PLCopen or
Pipenetwork devices
//Then call MLMotionStart and monitor MLMotionStatus again
before beginning rest of program
FirstCycle := TRUE;

On FirstCycle DO //Initialize the motion engine
    MLMotionInit( 1000);
END_DO;
    
```

```

MotionEngineStatus := MLMotionStatus();//Check the current
status of the motion engine

//Once motion engine is initialized, create CAM profiles and
defined Axis, then start the motion engine
ON MotionEngineStatus = MLSTATUS_INITIALISED DO
  Profiles( MLPR_CREATE_PROFILES );
  PLCopen( 0 );
  MLMotionStart();
END_DO;

IF MotionEngineStatus = MLSTATUS_RUNNING THEN
  bMotionEngineStarted := TRUE;
ELSE
  bMotionEngineStarted := FALSE;
END_IF;

```

2.3.3.30.5.2 FBD



2.3.3.31.6.3 FFLD

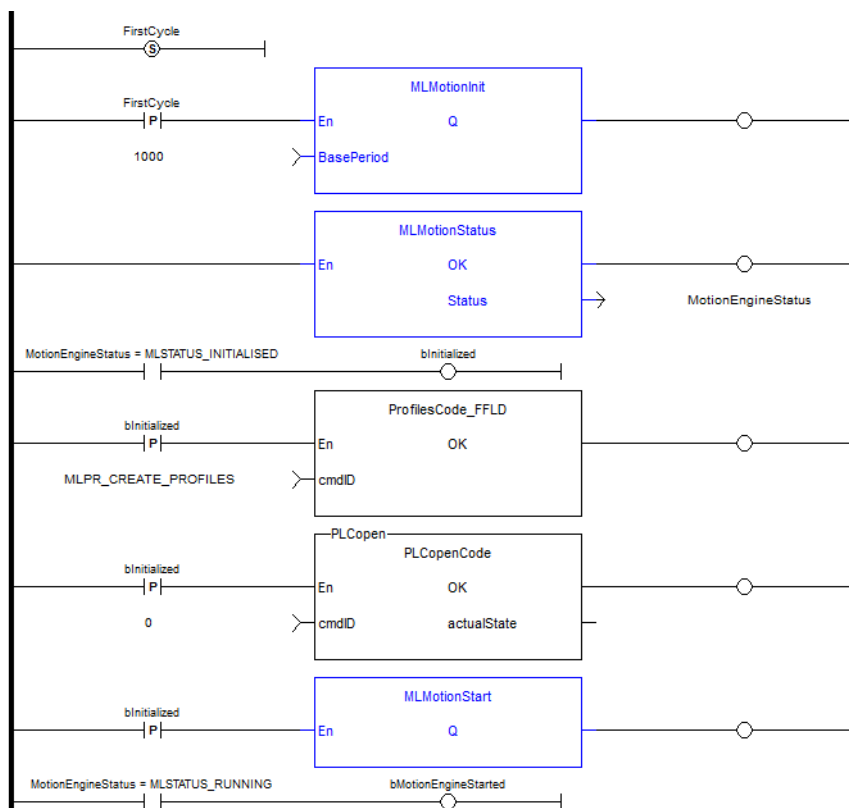

2.3.3.32 MLMotionStatus PLCopen ✓ Pipe Network ✓

2.3.3.33.1 Description

Returns the status of the motion engine. Based on the Internal Defines, the status will be one of the following.

```
#define MLSTATUS_NOT_INITIALISED 0 (*Motion not initialised*)
#define MLSTATUS_RUNNING 1 (*Motion is running*)
#define MLSTATUS_STOPPED 2 (*Motion is stopped*)
#define MLSTATUS_ERROR 3 (*Motion is in error*)
```

2.3.3.34.2 Parameter

Status : DINT (output)

2.3.3.35.3 Return Type

None

2.3.3.36.4 Example

2.3.3.37.5.1 ST

```
//Initialization code to start EtherCAT network.
//First initialize network with MLMotionInit command
//Then wait for command to finish by monitoring MLMotionStatus
output
//Once initialized, create any cam profiles and PLCopen or
Pipenetwork devices
//Then call MLMotionStart and monitor MLMotionStatus again
before beginning rest of program
FirstCycle := TRUE;

On FirstCycle DO //Initialize the motion engine
MLMotionInit( 1000);
END_DO;

MotionEngineStatus := MLMotionStatus();//Check the current
status of the motion engine
//Once motion engine is initialized, create CAM profiles and
defined Axis, then start the motion engine
ON MotionEngineStatus = MLSTATUS_INITIALISED DO
Profiles( MLPR_CREATE_PROFILES );
PLCopen( 0 );
MLMotionStart();
END_DO;

IF MotionEngineStatus = MLSTATUS_RUNNING THEN
bMotionEngineStarted := TRUE;
ELSE
bMotionEngineStarted := FALSE;
END_IF;
```

2.3.3.38.6.2 FBD



2.3.3.39.7.3 FFLD

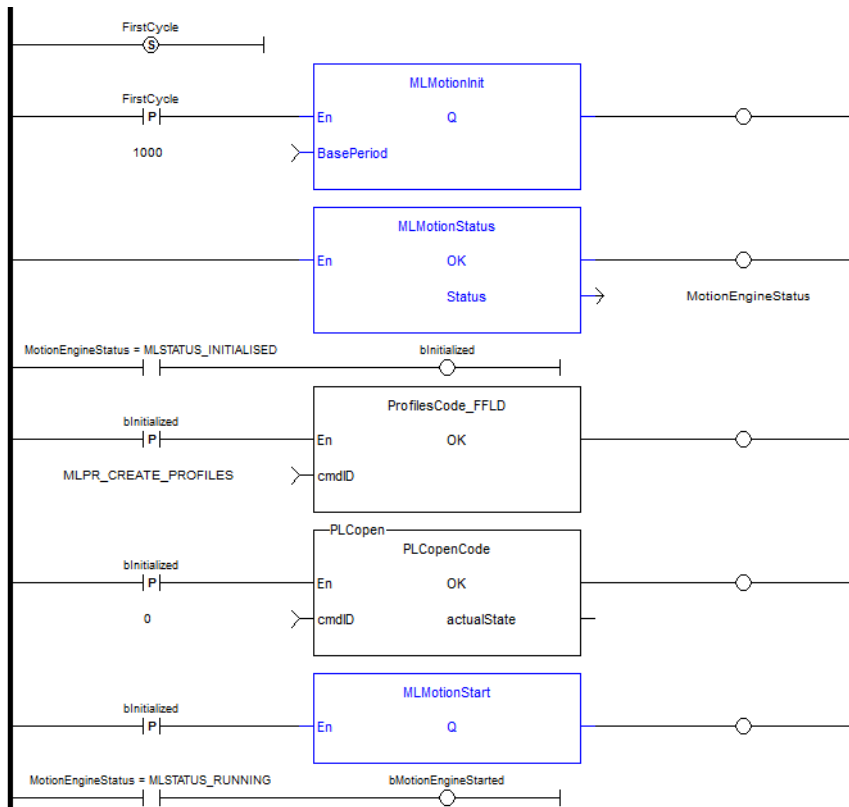

2.3.3.40 MLMotionStop PLCopen ✓ Pipe Network ✓

2.3.3.41.1 Description

Stops the motion bus driver, motion engine, and EtherCAT network operation, resulting in the EtherCAT network transitioning to the Init state. Returns TRUE if the function succeeded.

See also: "MLMotionStart" (→ p. 474), "MLMotionRstErr" (→ p. 473), "MLMotionStatus" (→ p. 475)

2.3.3.42.2 Return Type

BOOL

2.3.3.43.3 Example

2.3.3.44.4.1 ST

```

//Stop the EtherCAT network
ON StopMotionEngine DO
    MLMotionStop();
END_DO;
```

2.3.3.45.5.2 FBD

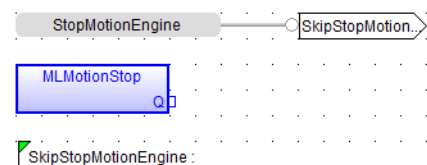

2.3.3.46.6.3 FFLD

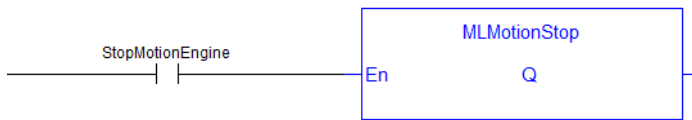

2.3.3.47 MLMotionSysTime PLCopen ✓ Pipe Network ✓

2.3.3.48.1 Description

Prints the system time to the log. Returns always TRUE.

2.3.3.49.2 Return Type

BOOL

2.3.3.50.3 Units

milliseconds

2.3.3.51.4 Example

2.3.3.52.5.1 ST

```
//Write the current system time to controller log message
ON PrintSystemTimeToLog DO
    MLMotionSysTime ();
END_DO;
```

2.3.3.53.6.2 FBD

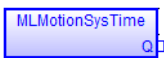

2.3.3.54.7.3 FFLD

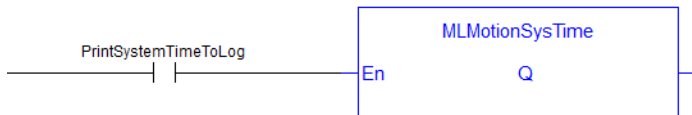

2.3.4 Coordinated Motion Function Blocks

This section contains a table with an alphabetical list of the Coordinated Motion function blocks. The table includes where the function block can be found in the KAS IDE library, starting from *Motion/Common* > *Coordinated Motion* > (*Grouping*).

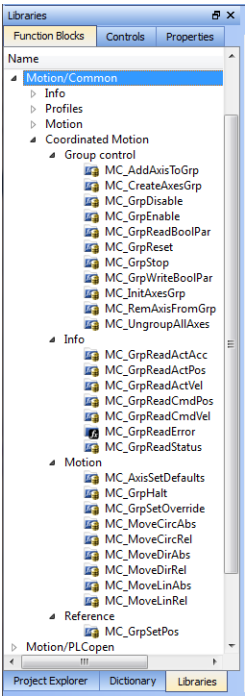
Name	Grouping	Description	Location in the Dictionary
MC_AddAxisToGrp	Group Control	Adds an axis to an axes group.	 <p>The screenshot shows the 'Libraries' window in a software application. The 'Motion/Common' folder is expanded, and the 'Coordinated Motion' sub-folder is also expanded. Under 'Coordinated Motion', the 'Group control' sub-folder is expanded, and 'MC_AddAxisToGrp' is highlighted. The 'Reference' folder is also visible at the bottom of the tree.</p>
MC_AxisSetDefaults	Motion	Sets the default kinematic parameters for an axis.	
MC_CreateAxesGrp	Group Control	Create an axis group for coordinated motion.	
MC_ErrorDescription	Motion/Common > Info	Converts the PLCopen error IDs into message strings	
MC_GrpReset	Group Control	Resets all the axes in an axes group.	
MC_GrpDisable	Group Control	Changes the state of a group to GroupDisabled.	
MC_GrpEnable	Group Control	Changes the state of a group from GroupDisabled to GroupStandby.	
MC_GrpHalt	Motion	Performs a controlled motion stop of all the axes in the group	
MC_GrpReadActAcc	Info	Reads the actual acceleration of the group and the axes in the group.	
MC_GrpReadActPos	Info	Reads the actual position of the axes in the group.	
MC_GrpReadActVel	Info	Reads the actual velocity of the group and the axes in the group.	
MC_GrpReadBoolPar	Group Control	Reads a value from the specified boolean group parameter	
MC_GrpReadParam	Group Control	Reads a value from the specified group parameter.	
MC_GrpReadCmdPos	Info	Reads the command position of the axes in the group.	
MC_GrpReadCmdVel	Info	Reads the command velocity of the axes in the group and the path velocity.	
MC_GrpReadError	Info	Reads the Group ErrorID in State ERRORSTOP.	
MC_GrpReadStatus	Info	Returns the status of an axes group.	

Name	Grouping	Description	Location in the Dictionary
MC_GrpReset	Group Control	Makes the transition from the state GroupErrorStop to GroupStandby by resetting all internal group-related errors. Also resets axis errors and drive faults for each axis in the group.	
MC_GrpSetOverride	Motion	Sets the velocity factor that is multiplied to the commanded velocity of all axes in the group.	
MC_GrpSetPos	Reference	Sets the axis position for all of the axes in an axes group to the positions specified in the Position input.	
MC_GrpStop	Group Control	Performs a non-aborted, controlled motion stop on all axes in an AxesGroup.	
MC_GrpWriteBoolPar	Group Control	Writes a value to the specified boolean group parameter.	
MC_GrpWriteParam	Group Control	Writes a value to the specified group parameter.	
MC_InitAxesGrp	Group Control	Initializes the kinematic limits for the axis group.	
MC_MoveCircAbs	Motion	Commands interpolated circular movement on an axes group to the specified absolute positions.	
MC_MoveCircRel	Motion	Commands interpolated circular movement on an axes group to the specified relative positions.	
MC_MoveDirAbs	Motion	Commands movement of an axes group to an absolute position regardless of path.	
MC_MoveDirRel	Motion	Commands movement of an axes group to a relative position regardless of path.	
MC_MoveLinAbs	Motion	Commands interpolated linear movement on an axes group to the specified absolute positions.	
MC_MoveLinRel	Motion	Commands interpolated linear movement on an axes group to the specified relative positions.	
MC_RemAxisFromGrp	Group Control	Removes an individual axis from an axis group.	
MC_UngroupAllAxes	Group Control	Removes all axes from an axes group.	

2.3.4.1 Coordinated Motion Group Control Library

Function	Description
"MC_AddAxisToGrp" (→ p. 481)	Adds an axis to an axes group.

Function	Description
"MC_CreateAxesGrp" (→ p. 483)	Create an axis group for coordinated motion.
"MC_GrpDisable" (→ p. 486)	Changes the state of a group to GroupDisabled.
"MC_GrpEnable" (→ p. 488)	Changes the state of a group from GroupDisabled to GroupStandby.
"MC_GrpReadBoolPar" (→ p. 490)	Reads a value from the specified Boolean group parameter
MC_GrpReadParam	Reads a value from the specified group parameter.
"MC_GrpReset" (→ p. 492)	Makes the transition from the state GroupErrorStop to GroupStandby by resetting all internal group-related errors. Also resets axis errors and drive faults for each axis in the group.
"MC_GrpStop" (→ p. 494)	Performs a non-aborted, controlled motion stop on all axes in an AxesGroup.
"MC_GrpWriteBoolPar" (→ p. 497)	Writes a value to the specified Boolean group parameter.
MC_GrpWriteParam	Writes a value to the specified group parameter.
"MC_InitAxesGrp" (→ p. 499)	Initializes the kinematic limits for the axis group.
"MC_RemAxisFromGrp" (→ p. 502)	Removes an individual axis from an axis group.
"MC_UngroupAllAxes" (→ p. 504)	Removes all axes from an axes group.

2.3.4.2.1 MC_AddAxisToGrp



2.3.4.3.2.1 Description

This function block adds an axis to an axes group. Both the axis and the axes group must be created prior to calling this function block. See "MC_CreateAxesGrp" (→ p. 483) and Create PLCopen Axis.

The IdentInGroup input specifies the index of the axis in the group. Axes do not need to be added in sequential order and gaps are acceptable. Gaps are ignored when the group is used.

The group must be in either the "GroupStandby" or "GroupDisabled" state when the axis is added. The state of the group can be read with "MC_GrpReadStatus" (→ p. 521). This implies that the group cannot be moving when the axis is added.

This function block does not cause motion.

TIP

- An axes group cannot contain more than one instance of an axis.
- Two active groups cannot contain the same axis. An "active" group is one in any state other than GroupDisabled.

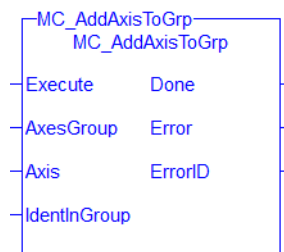

Figure 1-92: MC_AddAxisToGrp

2.3.5 Related Functions

"MC_CreateAxesGrp" (→ p. 483), "MC_GrpReadStatus" (→ p. 521), "MC_RemAxisFromGrp" (→ p. 502), "MC_UngroupAllAxes" (→ p. 504), "MC_ErrorDescription" (→ p. 453)

See also "Coordinated Motion", the top-level topic for Coordinated Motion.

2.3.5.1.1.1 Arguments

2.3.6 Input

Execute	Description	On the rising edge the axis is added to the group.
	Data type	BOOL
	Range	0, 1
	Unit	n/a
	Default	—
AxesGroup	Description	Reference to an axes group
	Data type	AXES_GROUP_REF
	Range	—
	Unit	n/a
	Default	—
Axis	Description	Reference to the axis to be added. An axes group cannot contain more than one instance of an axis.
	Data type	AXIS_REF
	Range	—
	Unit	n/a
	Default	—
IdentInGroup	Description	<p>The zero-based index of the axis in the group.</p> <ul style="list-style-type: none"> The axis slot in the group cannot be occupied by another axis. The index must be less than the maximum number of axes the group can contain. <code>MaxNumberOfAxes</code> is a property of the axes group and is set when the group is created. <p>To remove an axis from a group see "MC_RemAxisFromGrp" (→ p. 502).</p>
	Data type	UINT
	Range	[0, MaxNumberOfAxes - 1]
	Unit	n/a
	Default	—

2.3.7 Output

Done	Description	If True, then the command completed successfully.
	Data type	BOOL
Error	Description	If True, an error has occurred.
	Data type	BOOL
ErrorID	Description	Indicates the error identifier if Error output is set to True. See the table in PLCopen Function Block ErrorID Output.
	Data type	INT

2.3.7.1.1.1 Example

2.3.8 Structured Text

```
(*MC_AddAxisToGrp ST example *)
Inst_MC_AddAxisToGrp (AddAxisToGrp, Group1_ref, Axis_1, 0);
```

2.3.9 IL

```
BEGIN_IL
    CAL Inst_MC_AddAxisToGrp( AddAxisToGrp, Group1_ref, Axis_1,
    0 )
END_IL
```

2.3.10 FBD

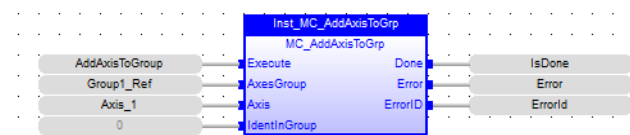

2.3.11 Ladder Diagram

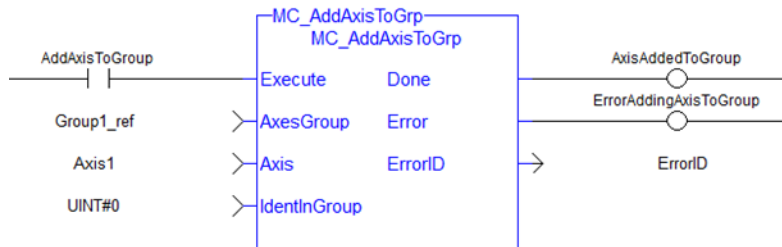

2.3.11.1.1 MC_CreateAxesGrp PLCopen ✓ Pipe Network ✓

2.3.11.2.2.1 Description

MC_CreateAxesGrp creates an axes group for coordinated motion. More than one axes group may be created and be active at the same time but each axis can only be a part of one group at a time.

Example of a valid setup:

```

AxesGroup1: Axis0, Axis1, Axis2
AxesGroup2: Axis3, Axis4
    
```

Example of an invalid setup:

```

AxesGroup1: Axis0, Axis1, Axis2
AxesGroup2: Axis2, Axis3, Axis4
    
```

The invalid setup is not allowed because Axis2 would be a part of two axes groups at the same time.

If an axis needs to be in more than one group, it can be removed from one and then added to another group. This is done using "MC_RemAxisFromGrp" (→ p. 502) and "MC_AddAxisToGrp" (→ p. 481).

IMPORTANT

MC_CreateAxesGrp must be called between "MLMotionInit" (→ p. 471) and "MLMotionStart" (→ p. 474).

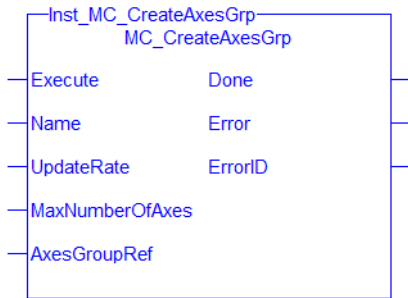

Figure 1-93: MC_CreateAxesGrp

2.3.12 Related Function Blocks

"MC_InitAxesGrp" (→ p. 499), "MC_ErrorDescription" (→ p. 453)

See also "Coordinated Motion", the top-level topic for Coordinated Motion.

2.3.12.1.1.1 Arguments

For more detail on how inputs and outputs work, refer to PLCopen Function Blocks - General Rules.

2.3.12.2.2.2 Input

Execute	Description	On the rising edge, this function block will create a coordinated motion axes group
	Data Type	BOOL
	Range	0, 1
	Unit	n/a
	Default	—
Name	Description	Axes Group Name
	Data Type	STRING
	Range	—
	Unit	n/a

	Default	—
UpdateRate	Description	Update rate of the axes group. The group update rate will be the same as the Base Period specified in "MLMotionInit" (→ p. 471). The update rate will run at the Base Period if it is a smaller time than the Base Period. (0, 1, and 2 are reserved for future enhancements) 3 = 125 µsec 4 = 250 µsec 5 = 500 µsec 6 = 1 msec 7 = 2 msec 8 = 4 msec 9 = 8 msec
	Data Type	UINT
	Range	[3,9]
	Unit	n/a
	Default	—
MaxNumberOfAxes	Description	The maximum number of axes that can be controlled by the group.
	Data Type	UINT
	Range	[2,256]
	Unit	n/a
	Default	—
AxesGroupRef	Description	The axes group reference variable to be initialized with a reference to the new axes group.
	Data Type	AXES_GROUP_REF
	Range	n/a
	Unit	n/a
	Default	—

2.3.12.3.3.3 Output

Done	Description	If True, then the command completed successfully.
	Date Type	BOOL
Error	Description	If True, then an error has occurred.
	Date Type	BOOL

ErrorID	Description	Indicates the error if Error output is set to TRUE. See the table in PLCopen Function Block ErrorID Output.
	Date Type	INT

2.3.12.4.4 Example

Calls to this function block are automatically generated when the application is compiled. Users should not manually call this function block.

2.3.13 Structured Text

```
Inst_MC_CreateAxesGrp( DoExecute, 'Group1', UpdateRate_3,
MaxAxes, Group1_Ref);
```

2.3.14 Instruction List

```
BEGIN_IL
    CAL Inst_MC_CreateAxesGrp1(DoExecute, 'Group1', UpdateRate_
3, MaxAxes, Group1_Ref)
END_IL
```

2.3.15 Function Block Diagram

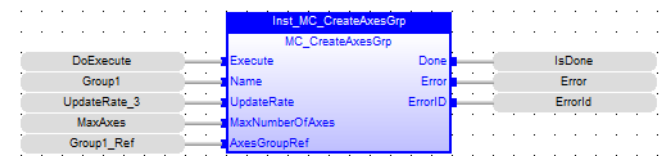

2.3.16 Ladder Diagram

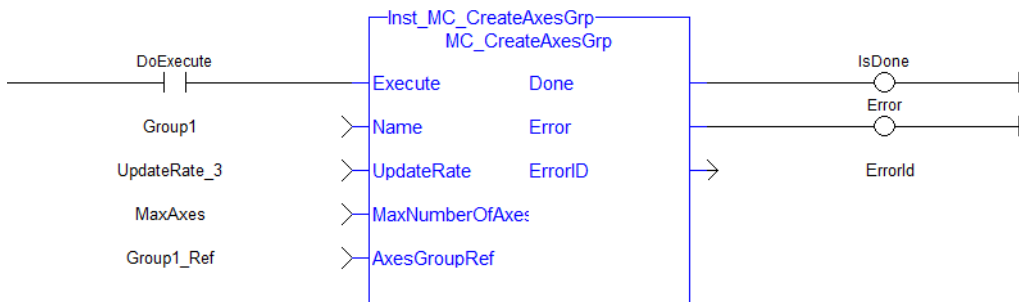

2.3.16.1.1 MC_GrpDisable PLCopen ✓ Pipe Network ✓

2.3.16.2.2.1 Description

MC_GrpDisable changes the state for a group to GroupDisabled. If the group is already in GroupDisabled, then MC_GrpDisable will do nothing. This function block can be issued in the group states: (GroupDisabled, GroupStandby, or GroupErrorStop).

NOTE
MC_GrpDisable will fail if the group is in any state other than GroupStandby or GroupDisabled.

Refer to Group State Diagrams for details.

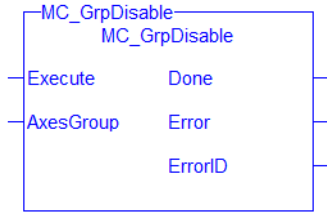

Figure 1-94: MC_GrpDisable

2.3.17 Related Functions

"MC_GrpEnable" (→ p. 488), "MC_ErrorDescription" (→ p. 453)

See also "Coordinated Motion", the top-level topic for Coordinated Motion.

2.3.17.1.1 Arguments

2.3.18 Input

Execute	Description	On the rising edge, request to disable the axis group.
	Data Type	BOOL
	Range	0, 1
	Unit	n/a
	Default	—
AxesGroup	Description	The axis group to be disabled
	Data Type	AXIS_GROUP_REF
	Range	n/a
	Unit	n/a
	Default	—

2.3.19 Output

Done	Description	If True, then the command completed successfully.
	Data Type	BOOL
Error	Description	If True, then an error has occurred.
	Data Type	BOOL
ErrorID	Description	Indicates the error if Error output is set to TRUE. See the table in PLCopen Function Block ErrorID Output
	Data Type	INT

2.3.19.1.1 Example

2.3.20 ST

```
(* Inst_MC_GrpDisableST example *)
Inst_MC_GrpDisable( DisableGroup, Group1_Ref );
```

2.3.21 IL

```
BEGIN_IL
    CAL Inst_MC_GrpDisable( DisableGroup, Group1_Ref )
END_IL
```

2.3.22 FBD

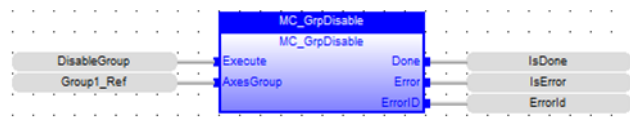

2.3.23 FFLD

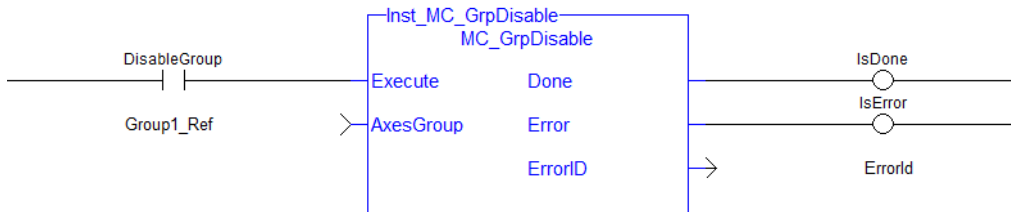

2.3.23.1.1 MC_GrpEnable



2.3.23.2.2.1 Description

MC_GrpEnable changes the state of a group from GroupDisabled to GroupStandby. If the group is already in GroupStandby, then MC_GrpEnable will do nothing.

NOTE
The group must be in GroupStandby in order to perform motion.

MC_GrpEnable will fail under the following conditions.

- It contains no axes
- The group is not in GroupDisabled or GroupStandby
- One or more axes in the group are in another group that is not in GroupDisabled.

Refer to Group State Diagrams for more details.

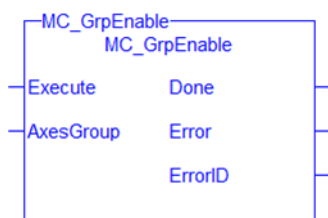

Figure 1-95: MC_GrpEnable

2.3.24 Related Functions

"MC_GrpDisable" (→ p. 486), "MC_ErrorDescription" (→ p. 453)

See also "Coordinated Motion", the top-level topic for Coordinated Motion.

2.3.24.1.1.1 Arguments

2.3.25 Input

Execute	Description	On the rising edge, request to enable the axis group
	Data Type	BOOL
	Range	0, 1
	Unit	n/a
	Default	—
AxesGroup	Description	The axis group to be enabled
	Data Type	AXIS_GROUP_REF
	Range	n/a
	Unit	n/a
	Default	—

2.3.26 Output

Done	Description	If True, then the command completed successfully.
	Data Type	BOOL
Error	Description	If True, an error has occurred.
	Data Type	BOOL
ErrorID	Description	Indicates the error if Error output is set to TRUE. See the table in PLCopen Function Block ErrorID Output
	Data Type	INT

2.3.26.1.1.1 Example

2.3.27 Structured Text

```
(* Inst_MC_GrpEnableST example *)
Inst_MC_GrpEnable( EnableGroup, Group1_Ref );
```

2.3.28 IL

```
BEGIN_IL
    CAL Inst_MC_GrpEnable( EnableGroup, Group1_Ref )
END_IL
```

2.3.29 FBD



2.3.30 FFLD

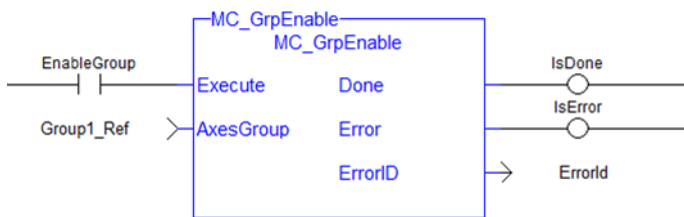

2.3.30.1.1 MC_GrpReadBoolPar PLCopen ✓ Pipe Network ✓

2.3.30.2.2.1 Description

This function block reads a value from the specified Boolean group parameter. See Recovery of the System State After an Axis Error for more information.

MC_GrpReadBoolPar(Axesgroup_Ref GroupID, Uint BoolID) where BoolID can be one of the following 2 currently defined Booleans:

IGNORE_AXIS_ESTOP: ID = 1000 : The value read will be either TRUE or False as set by the MC_GrpWriteBoolPar function block.

AXIS_ESTOP_ACTIVE: ID = 1001 : This Read-only parameter will be asserted TRUE whenever an axis in the group is experiencing an Axis Estop Error. When there are no Axis Estop Errors present on the axes in a group, this parameter will be set to FALSE.

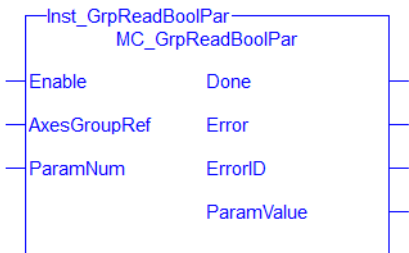

Figure 1-96: MC_GrpReadBoolPar

2.3.31 Related Function Blocks

"MC_GrpWriteBoolPar" (→ p. 497), "MC_ErrorDescription" (→ p. 453)

See also "Coordinated Motion", the top-level topic for Coordinated Motion.

2.3.31.1.1.1 Arguments

For more details on how inputs and outputs work, refer to PLCopen Function Blocks - General Rules.

2.3.32 Input

Enable	Description	If True, then request to read a value from the specified Boolean group parameter.
	Data Type	BOOL
	Range	0, 1
	Unit	n/a
	Default	—
AxesGroupRef	Description	The axis group that the Boolean parameter value will be read from.
	Data Type	AXES_GROUP_REF
	Range	n/a
	Unit	n/a
	Default	—
ParamNum	Description	<p>ParamNum can be one of the following two currently defined Booleans:</p> <ul style="list-style-type: none"> • IGNORE_AXIS_ESTOP: ID = 1000 : The value read will be either TRUE or False as set by the MC_GrpWriteBoolPar function block. • AXIS_ESTOP_ACTIVE: ID = 1001 : This Read-only parameter will be asserted TRUE whenever an axis in the group is experiencing an Axis Estop Error. When there are no Axis Estop Errors present on the axes in a group, this parameter will be set to FALSE.
	Data Type	UINT
	Range	1000, 1001
	Unit	UINT
	Default	—

2.3.33 Output

Done	Description	If True, then the command completed successfully.
	Data Type	BOOL
Error	Description	If True, an error has occurred.
	Data Type	BOOL
ErrorID	Description	Indicates the error if Error output is set to TRUE. See the table in PLCopen Function Block ErrorID Output.

	Data Type	INT
ParamValue	Description	True or False
	Data Type	BOOL

2.3.33.1.1.1 Example

2.3.34 ST

```
Inst_GrpReadBoolPar( DoEnable, Group1_Ref, AXIS_ESTOP_ACTIVE );
```

2.3.35 IL

```
BEGIN_IL
    Cal Inst_GrpReadBoolPar( DoEnable, Group1_Ref, AXIS_ESTOP_
ACTIVE )
END_IL
```

2.3.36 FBD

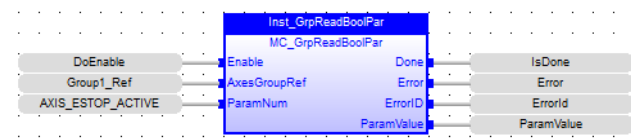

2.3.37 FFLD

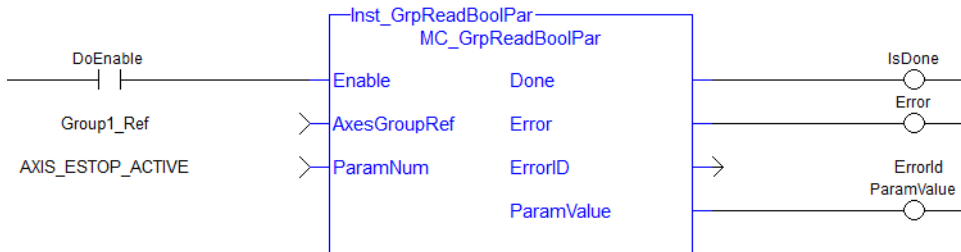

2.3.37.1.1 MC_GrpReset PLCopen ✓ Pipe Network ✓

2.3.37.2.2.1 Description

This function block makes the transition from the state GroupErrorStop to GroupStandby by resetting all internal group-related errors – it does not affect the output of the FB instances. This function block also resets axis errors and drive faults for each axis in the group. This function block does not cause any motion.

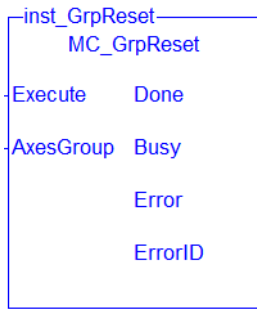

Figure 1-97: MC_GrpReset

2.3.38 Related Functions

"MC_GrpReadError" (→ p. 519), "MC_GrpReadStatus" (→ p. 521), "MC_ErrorDescription" (→ p. 453)

See also "Coordinated Motion", the top-level topic for Coordinated Motion.

2.3.38.1.1.1 Arguments

For more details on how inputs and outputs work, refer to PLCopen Function Blocks - General Rules.

2.3.39 Input

Execute	Description	On the rising edge, this FB resets group-related errors and all of the axes in the group.
	Data Type	BOOL
	Range	0, 1
	Unit	n/a
	Default	—
AxesGroup	Description	The axes group in which the axes will be reset.
	Data Type	AXES_GROUP_REF
	Range	n/a
	Unit	n/a
	Default	—

2.3.40 Output

Done	Description	If True, then the reset completed successfully.
	Data Type	BOOL
Busy	Description	If True, then the FB is executing.
	Data Type	BOOL
Error	Description	If True, an error has occurred.

	Data Type	BOOL
ErrorID	Description	Indicates the error identifier if Error output is set to TRUE. See table in PLCopen Function Block ErrorID Output.
	Data Type	INT

2.3.40.1.1.1 Example

2.3.41 ST

```
Inst_MC_GrpReset ( EnableReset, Group1_Ref );
```

2.3.42 FBD

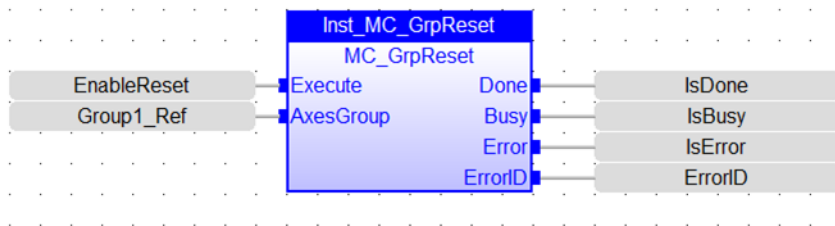

2.3.43 IL

```
BEGIN_IL
    CAL Inst_MC_GrpReset ( EnableReset, Group1_Ref )
END_IL
```

2.3.44 FFLD

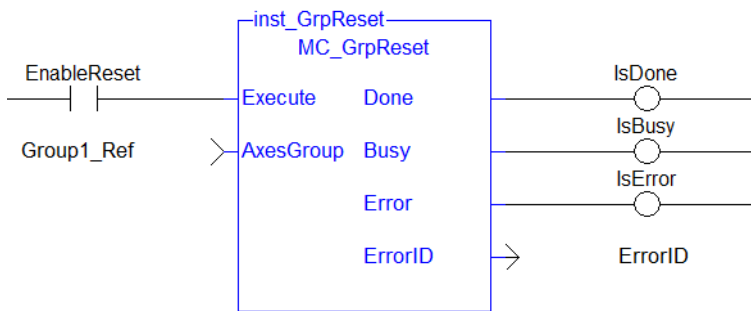

2.3.44.1.1 MC_GrpStop PLCopen ✓ Pipe Network ✓

2.3.44.2.2.1 Description

MC_GrpStop performs a controlled motion stop of all axes in the group. When the path velocity reaches zero any queued moves are flushed from the buffer and the Done output is set. When both the Done output is true and the application has cleared the Execute input the state transitions to GroupStandby. MC_GrpStop *can not be aborted*.

NOTE

MC_GrpStop does NOT prevent a single axis from executing nor does it prevent other Coordinated Motion moves from executing once MC_GrpStop has completed.

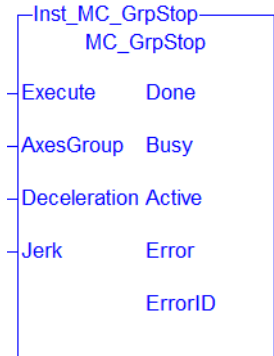
**2.3.45 Related Functions**

"MC_GrpHalt" (→ p. 528), "MC_ErrorDescription" (→ p. 453)

See also "Coordinated Motion", the top-level topic for Coordinated Motion.

2.3.45.1.1.1 Arguments

For more details on how inputs and outputs work, refer to PLCopen Function Blocks - General Rules.

2.3.46 Input

Execute	Description	On the rising edge the command to stop all of the axes in the group is initiated.
	Data type	BOOL
	Range	0, 1
	Unit	n/a
	Default	—
AxesGroup	Description	The axes group in which the axes will be stopped.
	Data type	AXES_GROUP_REF
	Range	n/a
	Unit	n/a
	Default	—
Deceleration	Description	The path deceleration rate for all of the axes in the group
	Data type	LREAL
	Range	0 < Deceleration See Limitations on Acceleration and Jerk for more information.
	Unit	n/a

	Default	—
Jerk	Description	Not supported
	Data type	LREAL
	Range	$0 \leq \text{Jerk}$ See Limitations on Acceleration and Jerk for more information.
	Unit	n/a
	Default	—

2.3.47 Output

Done	Description	If True, then the command completed successfully.
	Data type	BOOL
Busy	Description	TRUE from the moment the EXECUTE input is TRUE until the stop is complete.
	Data type	BOOL
Active	Description	If True, then the stop is still executing.
	Data type	BOOL
Error	Description	If True, an error has occurred.
	Data type	BOOL
ErrorID	Description	Indicates the error identifier if Error output is set to TRUE. See table in PLCopen Function Block ErrorID Output.
	Data type	INT

2.3.47.1.1.1 Example

2.3.48 Structured Text

```
Inst_MC_GrpStop ( EnableStop, Group1_Ref, Deceleration, Jerk );
```

2.3.49 IL

```
BEGIN_IL
    CAL Inst_MC_GrpStop ( EnableStop, Group1_Ref, Deceleration,
    Jerk )
END_IL
```

2.3.50 FBD

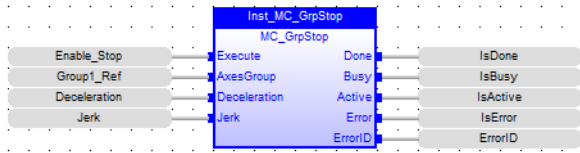

2.3.51 FFLD

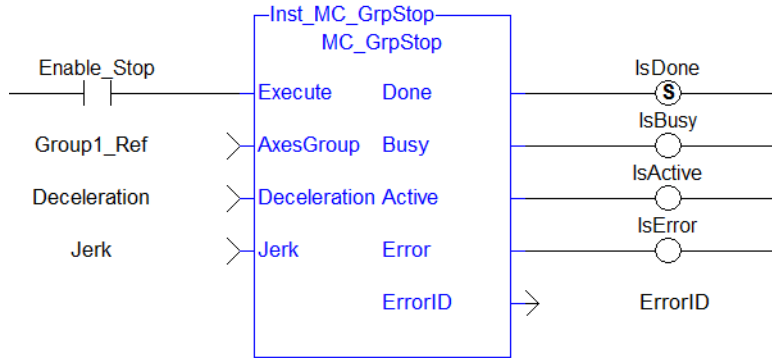

2.3.51.1.1 MC_GrpWriteBoolPar PLCopen ✓ Pipe Network ✓

2.3.51.2.2.1 Description

This function block writes a value to the specified Boolean group parameter. See Recovery of the System State After an Axis Error for more information.

IGNORE_AXIS_ESTOP (BoolID = 1000), and the Value can be either TRUE or FALSE.

- Setting this Boolean Parameter to TRUE will result in the Coordinated Motion Engine NOT stopping all axes in a group when one of them is stopped due to an Axis Estop Error. Only the axis experiencing the error will stop when this Parameter is set to TRUE.
- When this parameter is FALSE (Default), all axes in a group will be stopped and the power off request is asserted for each axis.

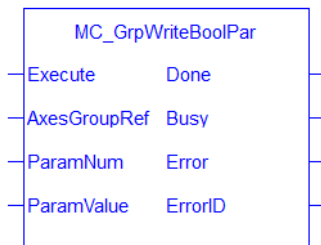

Figure 1-98: MC_GrpWriteBoolPar

2.3.52 Related Function Blocks

"MC_GrpReadBoolPar" (→ p. 490), "MC_ErrorDescription" (→ p. 453)

See also "Coordinated Motion", the top-level topic for Coordinated Motion.

2.3.52.1.1.1 Arguments

For more details on how inputs and outputs work, refer to PLCopen Function Blocks - General Rules.

2.3.53 Input

Execute	Description
	On the rising edge, request to write a value to the specified Boolean group parameter.

	Data Type	BOOL
	Range	0, 1
	Unit	n/a
	Default	—
AxesGroupRef	Description	The axis group that the Boolean parameter value will be written to.
	Data Type	AXES_GROUP_REF
	Range	n/a
	Unit	n/a
	Default	—
ParamNum	Description	The ID number of the Boolean parameter that is to be written IGNORE_AXIS_ESTOP (BoolID = 1000)
	Data Type	UINT
	Range	
	Unit	
	Default	
ParamValue	Description	True or false
	Data Type	BOOL
	Range	0, 1
	Unit	n/a
	Default	—

2.3.54 Output

Done	Description	If True, then the command completed successfully.
	Data Type	BOOL
Busy	Description	If True, then the function block is executing.
	Data Type	BOOL
Error	Description	If True, an error has occurred.
	Data Type	BOOL
ErrorID	Description	Indicates the error if Error output is set to TRUE. See the table in PLCopen Function Block ErrorID Output.

Data Type	INT
------------------	-----

2.3.54.1.1.1 Example

2.3.55 ST

```
Inst_MC_GrpWriteBoolPar( ExecuteWrite, Group1Ref, IGNORE_AXIS_
ESTOP, true );
```

2.3.56 IL

```
BEGIN_IL
    Cal Inst_MC_GrpWriteBoolPar( ExecuteWrite, Group1Ref,
IGNORE_AXIS_ESTOP, true )
END_IL
```

2.3.57 FBD

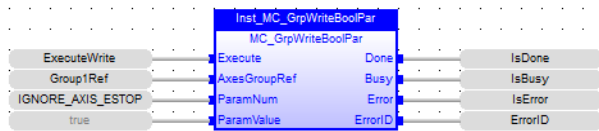

2.3.58 FFLD

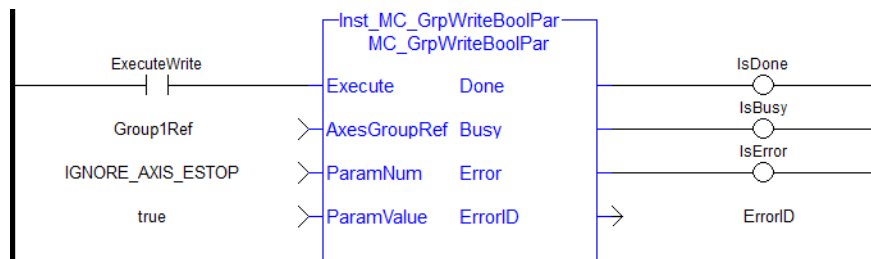

2.3.58.1.1 MC_InitAxesGrp PLCopen ✓ Pipe Network ✓

2.3.58.2.2.1 Description

MC_InitAxesGrp initializes the kinematic limits for the axis group. During a move, the motion engine verifies that the limits are not exceeded.

NOTE

The function block returns an error if the group state is not GroupStandby or GroupDisabled.

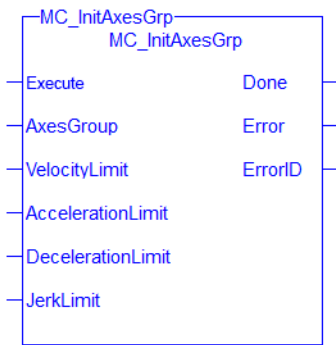

Figure 1-99: MC_InitAxesGrp

2.3.59 Related Function Blocks

"MC_CreateAxesGrp" (→ p. 483), "MC_ErrorDescription" (→ p. 453)

See also "Coordinated Motion", the top-level topic for Coordinated Motion.

2.3.59.1.1.1 Arguments

2.3.60 Inputs

Execute	Description	On the rising edge, this function block will initialize the axis group.
	Data type	BOOL
	Range	0, 1
	Unit	n/a
	Default	—
AxesGroup	Description	The axis group to be initialized
	Data type	AXIS_GROUP_REF
	Range	n/a
	Unit	n/a
	Default	—
VelocityLimit	Description	Velocity limit
	Data type	LREAL
	Range	$0 < \text{Velocity} < (20 * \text{Acceleration})$ and $0 < \text{Velocity} < (20 * \text{Deceleration})$ See Limitations on Acceleration and Jerk for more information.
	Unit	user units per second
	Default	—
AccelerationLimit	Description	Acceleration limit

	Data type	LREAL
	Range	$0 < \text{Velocity} < (20 * \text{Acceleration})$ See Limitations on Acceleration and Jerk for more information.
	Unit	user units per second ²
	Default	—
DecelerationLimit	Description	Deceleration limit
	Data type	LREAL
	Range	$0 < \text{Velocity} < (20 * \text{Deceleration})$ See Limitations on Acceleration and Jerk for more information.
	Unit	User units per second ²
	Default	—
JerkLimit	Description	Jerk limit
	Data type	LREAL
	Range	$(\text{Velocity} / 20) < \text{Acceleration} < (2 * \text{Jerk})$ and $(\text{Velocity} / 20) < \text{Deceleration} < (2 * \text{Jerk})$ See Limitations on Acceleration and Jerk for more information.
	Unit	User units per second ³
	Default	

2.3.61 Outputs

Done	Description	If True, then the command completed successfully.
	Data type	BOOL
Error	Description	If True, then an error has occurred.
	Data type	BOOL
ErrorID	Description	Indicates the error if Error output is set to TRUE. See the table in PLCopen Function Block ErrorID Output
	Data type	INT

2.3.61.1.1 Example

2.3.62 Structured Text

```
(* Inst_MC_InitAxesGrpST example *)
Inst_MC_InitAxesGrp( initAxesGrp, grp, velLim, accelLim,
decelLim, jerkLim );
```

2.3.63 IL

```
BEGIN_IL
    CAL Inst_MC_InitAxesGrp( initAxesGrp, grp, velLim,
    accelLim, decelLim, jerkLim )
END_IL
```

2.3.64 FBD

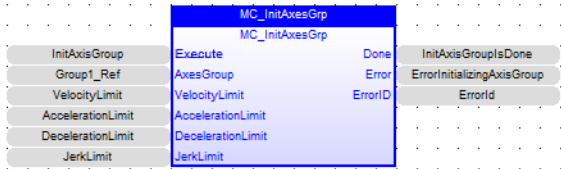

2.3.65 FFLD

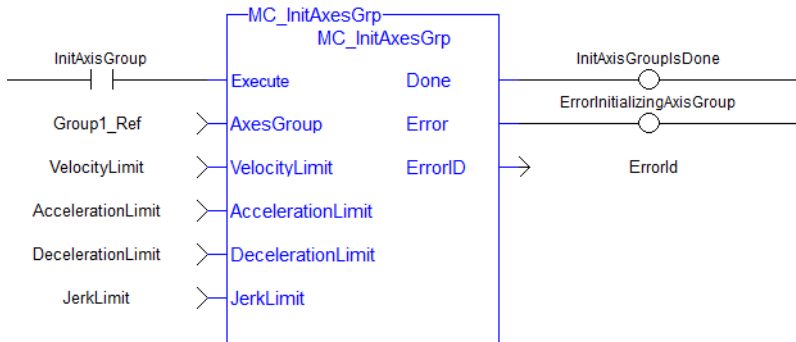

2.3.65.1.1 MC_RemAxisFromGrp



2.3.65.2.2.1 Description

MC_RemAxisFromGrp removes a single axis from a group. This function block can be issued in the group states: (GroupDisabled, GroupStandby, or GroupErrorStop). The group's state will change to GroupDisabled if the axis removed is the last valid axis in the group. This function block does not cause any motion.

NOTE

MC_RemAxisFromGrp will fail if the group is in any state other than GroupStandby or GroupDisabled. Refer to Group State Diagrams for details.

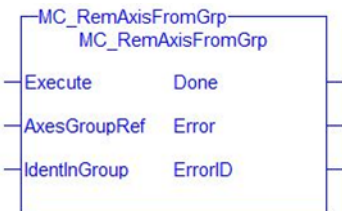

Figure 1-100: MC_RemAxisFromGrp

2.3.66 Related Functions

"MC_AddAxisToGrp" (→ p. 481), "MC_UngroupAllAxes" (→ p. 504), "MC_ErrorDescription" (→ p. 453)
See also "Coordinated Motion", the top-level topic for Coordinated Motion.

2.3.66.1.1.1 Arguments

2.3.67 Input

Execute	Description	On the rising edge, request to remove an axis from the group
	Data type	BOOL
	Range	0, 1
	Unit	n/a
	Default	—
AxesGroupRef	Description	The axis group from which the axis will be removed
	Data type	AXIS_GROUP_REF
	Range	n/a
	Unit	n/a
	Default	—
IdentInGroup	Description	<p>The zero-based index of the axis in the group.</p> <ul style="list-style-type: none"> • The axis index in the group must contain a valid axis • The index must be less than the maximum number of axes the group can contain. <code>MaxNumberOfAxes</code> is a property of the axes group and is set when the group is created.
	Data type	UINT
	Range	[0, MaxNumberOfAxes - 1]
	Unit	n/a
	Default	—

2.3.68 Output

Done	Description	If True, then the command completed successfully.
	Data type	BOOL
Error	Description	If True, an error has occurred.
	Data type	BOOL
ErrorID	Description	Indicates the error identifier if Error output is set to True. See the table in PLCopen Function Block ErrorID Output.
	Data type	INT

2.3.68.1.1.1 Example

2.3.69 ST

```
(* Inst_MC_InitAxisGrpST example *)
Inst_MC_RemAxisFromGrp( ExecuteRemAxisFromGrp, Group1_Ref,
AxisId );
```

2.3.70 IL

```
BEGIN_IL
    CAL Inst_MC_RemAxisFromGrp( ExecuteRemAxisFromGrp, Group1_
Ref, AxisId )
END_IL
```

2.3.71 FBD



2.3.72 FFLD

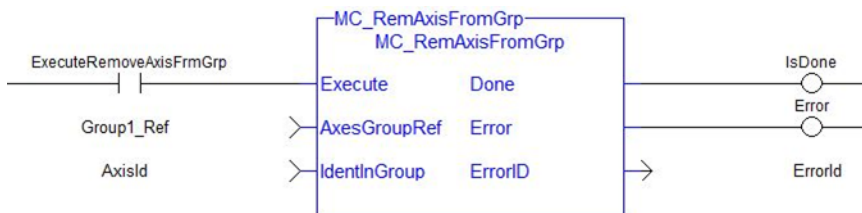

2.3.72.1.1 MC_UngroupAllAxes

PLCopen ✓ Pipe Network ✓

2.3.72.2.1 Description

MC_UngroupAllAxes removes all axes from an axes group. This function block can be issued in the group states: (GroupDisabled, GroupStandby, or GroupErrorStop). The axes group state will be changed to GroupDisabled upon successful completion. This function block does not cause any motion.

NOTE

MC_UngroupAllAxes will fail if the group is in any state other than GroupStandby or GroupDisabled. Refer to Group State Diagrams for details.

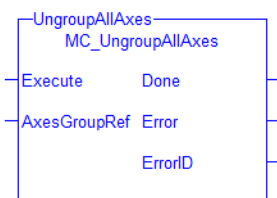

Figure 1-101: MC_UngroupAllAxes

2.3.73 Related Functions

"MC_AddAxisToGrp" (→ p. 481), "MC_RemAxisFromGrp" (→ p. 502), "MC_ErrorDescription" (→ p. 453)
See also "Coordinated Motion", the top-level topic for Coordinated Motion.

2.3.73.1.1.1 Arguments

2.3.74 Input

Execute	Description	On the rising edge, request to remove all axes in the axes group
	Data type	BOOL
	Range	0, 1
	Unit	n/a
	Default	—
AxesGroupRef	Description	The axis group from which to remove all axes
	Data type	AXIS_GROUP_REF
	Range	n/a
	Unit	n/a
	Default	—

2.3.75 Output

Done	Description	If True, then the command completed successfully.
	Data type	BOOL
Error	Description	If True, an error has occurred
	Data type	BOOL
ErrorID	Description	Indicates the error identifier if 'Error' output is set to TRUE. See the table in PLCopen Function Block ErrorID Output.
	Data type	INT

2.3.75.1.1.1 Examples

2.3.76 ST

```
Inst_MC_UngroupAllAxes( ExecuteUngroup, Group1_Ref );
```

2.3.77 IL

```
BEGIN_IL
    CAL Inst_MC_UngroupAllAxes( ExecuteUngroup, Group1_Ref )
END_IL
```

2.3.78 FBD



2.3.79 FFLD

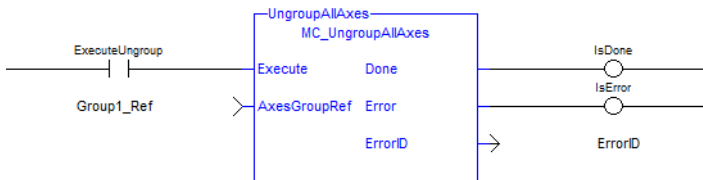

2.3.79.1 Coordinated Motion Info Library

Function	Description
"MC_GrpReadActAcc" (→ p. 506)	Reads the actual acceleration of the group and the axes in the group.
"MC_GrpReadActPos" (→ p. 509)	Reads the actual position of the axes in the group.
"MC_GrpReadActVel" (→ p. 511)	Reads the actual velocity of the group and the axes in the group.
"MC_GrpReadCmdPos" (→ p. 514)	Reads the command position of the axes in the group.
"MC_GrpReadCmdVel" (→ p. 517)	Reads the command velocity of the axes in the group and the path velocity.
"MC_GrpReadError" (→ p. 519)	Reads the Group ErrorID in State ERRORSTOP.
"MC_GrpReadStatus" (→ p. 521)	Returns the status of an axes group.

2.3.79.2.1 MC_GrpReadActAcc PLCopen ✓ Pipe Network ✓

2.3.79.3.2.1 Description

The MC_GrpReadActAcc function block fills the array specified by the 'Acceleration' argument with the actual acceleration of the system in the coordinate system specified by the CoordSystem argument. The measured path acceleration is also calculated and reported via the 'PathAcceleration' output. This function block does not cause any motion.

NOTE

- The actual acceleration is smoothed over the last 10 samples. This reduces the error in acceleration estimation, but introduces a small amount of phase delay in the reported accelerations.
- Currently, only the ACS coordinate system is supported. See Coordinate Systems to learn more.

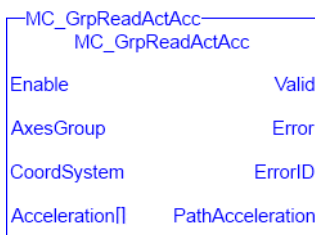
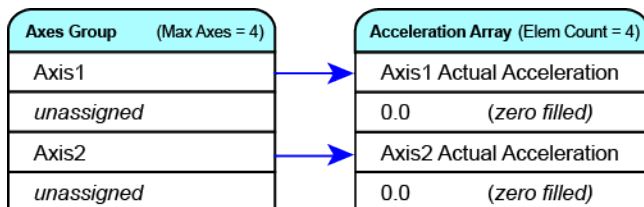

Figure 1-102: MC_GrpReadActAcc

There is a one-to-one correspondence between the axes in the Axes Group array and the acceleration values in the Acceleration array. Each element in the Acceleration array corresponds to the axis element in the Axes Group array. If an index in the Axes Group is unassigned then the acceleration value for that array element in the Acceleration array will be 0. If the element does contain an axis then the acceleration value will be filled with the current actual acceleration for that axis. Here is an example to illustrate how this works:



2.3.80 Related Functions

"MC_GrpReadActPos" (→ p. 509), "MC_GrpReadActVel" (→ p. 511), "MC_GrpReadCmdPos" (→ p. 514), "MC_GrpReadCmdVel" (→ p. 517)

See also "Coordinated Motion", the top-level topic for Coordinated Motion.

2.3.80.1.1.1 Arguments

For more detail on how inputs and outputs work, refer to PLCopen Function Blocks - General Rules.

2.3.81 Input

Enable	Description	If True, then this function block will read the current actual acceleration of the group and the axes in the group
	Data type	BOOL
	Range	0, 1
	Unit	n/a
	Default	—
AxesGroup	Description	The axes group from which the actual acceleration will be read.
	Data type	AXES_GROUP_REF
	Range	n/a
	Unit	n/a
	Default	—
CoordSystem	Description	The coordinate system used when reading the actual acceleration
	Data type	SINT
	Range	One of the following enumeration values: <ul style="list-style-type: none"> MC_COORDINATE_SYSTEM_ACS = 0 MC_COORDINATE_SYSTEM_MCS = 1 MC_COORDINATE_SYSTEM_PCS = 2

	Unit	n/a
	Default	—
Acceleration[]	Description	An array where the acceleration data will be written. The length of the array must equal the maximum number of axes allowed in the group. The maximum number of axes is an argument to "MC_CreateAxesGrp" (→ p. 483) that is used to create axes groups.
	Data type	LREAL
	Range	n/a
	Unit	User units per second ²
	Default	—

2.3.82 Output

Valid	Description	If true, the accelerations have been read without error.
	Data type	BOOL
Error	Description	If true, an error has occurred.
	Data type	BOOL
ErrorID	Description	Indicates the error if Error output was set to TRUE. See the table PLCopen Function Block ErrorID Output
	Data type	INT
PathAcceleration	Description	The current measured path acceleration of the group, measured by taking the square root of the sum of the squared accelerations of each axis.
	Data type	LREAL
	Unit	User units per second ²

2.3.82.1.1.1 Example

2.3.83 Structured Text

```
Inst_MC_GrpReadActAcc( DoRead, Group, CoordSys, AccList );
```

2.3.84 IL

```
BEGIN_IL
    CAL Inst_MC_GrpReadActAcc( DoRead, Group, CoordSys, AccList
)
END_IL
```

2.3.85 FBD



2.3.86 Ladder Diagram

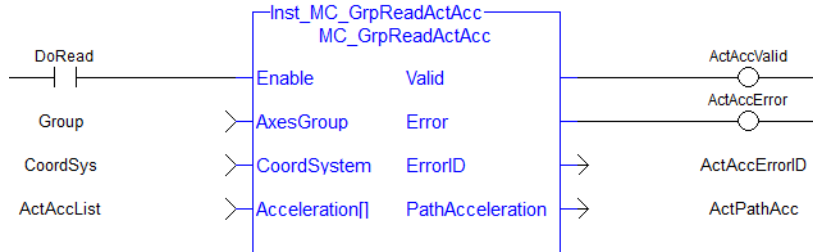

2.3.86.1.1 MC_GrpReadActPos



2.3.86.2.2.1 Description

MC_GrpReadActPos fills the array specified by the 'Position' argument with the actual position of the system in the coordinate system specified by the CoordSystem argument. This function block does not cause any motion.

NOTE

Currently, only the ACS coordinate system is supported. See Coordinate Systems to learn more.

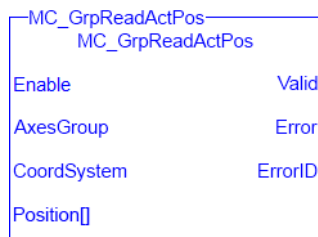

Figure 1-103: MC_GrpReadActPos

There is a one to one correspondence between the axes in the Axes Group and the position values in the Position Array. Each element in the Position Array corresponds to the axis element in the Axis Group array. If an index in the Axes Group is unassigned then the position value for that array element in the Position Array will be 0. If the element does contain an axis then the position value will be filled with the current actual position for that axis. Here is an example to illustrate how this works:



2.3.87 Related Functions

"MC_GrpReadActVel" (→ p. 511), "MC_GrpReadActAcc" (→ p. 506), "MC_GrpReadCmdPos" (→ p. 514), "MC_GrpReadCmdVel" (→ p. 517)

See also "Coordinated Motion", the top-level topic for Coordinated Motion.

2.3.87.1.1.1 Arguments

For more detail on how inputs and outputs work, refer to PLCopen Function Blocks - General Rules.

2.3.88 Input

Enable	Description	If True, then this function block will read the current actual position of the axes in the group
	Data type	BOOL
	Range	0, 1
	Unit	n/a
	Default	—
AxesGroup	Description	The axes group from which the actual position will be read
	Data type	AXES_GROUP_REF
	Range	n/a
	Unit	n/a
	Default	—
CoordSystem	Description	The coordinate system used when reading the actual position
	Data type	SINT
	Range	One of the following enumeration values: <ul style="list-style-type: none"> • MC_COORDINATE_SYSTEM_ACS = 0 • MC_COORDINATE_SYSTEM_MCS = 1 • MC_COORDINATE_SYSTEM_PCS = 2
	Unit	n/a
	Default	—
Position[]	Description	An array where the position data will be written. The length of the array must equal the maximum number of axes allowed in the group. The maximum number of axes is an argument to the CreateAxesGrp function block that is used to create axes groups.
	Data type	LREAL
	Range	n/a
	Unit	User units
	Default	—

2.3.89 Output

Valid	Description	If true, the positions have been read without error
	Data type	BOOL
Error	Description	If true, an error has occurred.
	Data type	BOOL
ErrorID	Description	Indicates the error if Error output is set to TRUE. See the table PLCopen Function Block ErrorID Output
	Data type	INT

2.3.89.1.1.1 Example

2.3.90 Structured Text

```
Inst_MC_GrpReadActPos( DoRead, Group, CoordSys, PosList );
```

2.3.91 IL

```
BEGIN_IL
    CAL Inst_MC_GrpReadActPos( DoRead, Group, CoordSys, PosList
)
END_IL
```

2.3.92 FBD

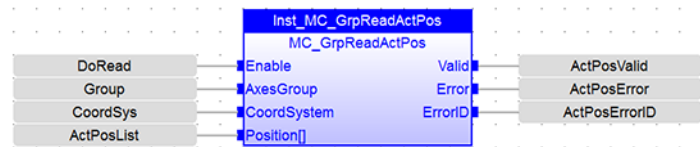

2.3.93 Ladder Diagram

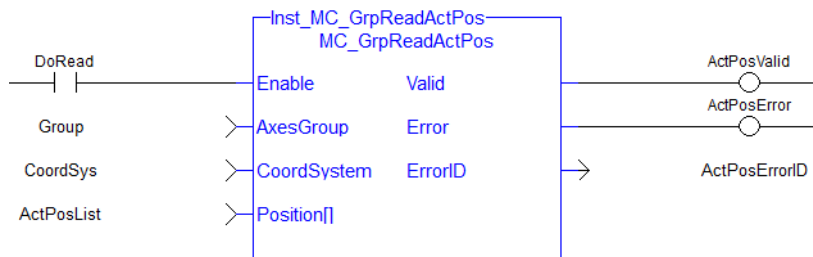

2.3.93.1.1 MC_GrpReadActVel PLCopen ✓ Pipe Network ✓

2.3.93.2.2.1 Description

MC_GrpReadActVel fills the array specified by the 'Velocity' argument with the actual velocity of the system in the coordinate system specified by the CoordSystem argument. The measured path velocity is also calculated and reported via the 'PathVelocity' output. This function block does not cause any motion.

NOTE

- The actual velocity is smoothed over the last 10 samples. This reduces the error in velocity estimation, but introduces a small amount of phase delay in the reported velocities.
- Currently, only the ACS coordinate system is supported. See Coordinate Systems to learn more.

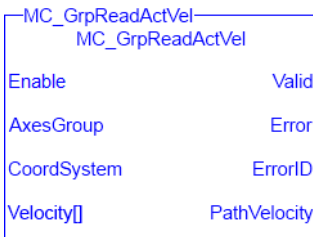
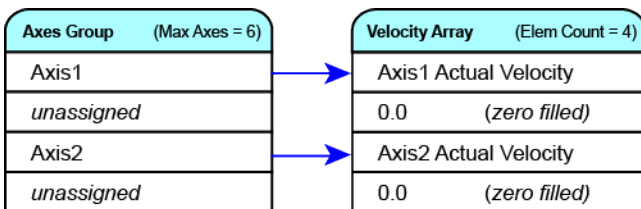

Figure 1-104: MC_GrpReadActVel

There is a one to one correspondence between the axes in the Axes Group and the velocity values in the Velocity Array. Each element in the Velocity array corresponds to the axis element in the Axes Group array. If an index in the Axes Group is unassigned then the velocity value for that array element in the Velocity array will be 0. If the element does contain an axis then the velocity value will be filled with the current actual velocity for that axis. Here is an example to illustrate how this works:



2.3.94 Related Functions

"MC_GrpReadActPos" (→ p. 509), "MC_GrpReadActAcc" (→ p. 506), "MC_GrpReadCmdPos" (→ p. 514), "MC_GrpReadCmdVel" (→ p. 517)

See also "Coordinated Motion", the top-level topic for Coordinated Motion.

2.3.94.1.1.1 Arguments

For more detail on how inputs and outputs work, refer to PLCopen Function Blocks - General Rules.

2.3.95 Input

Enable	Description	If True, then this function block will read the current actual velocity of the group and the axes in the group
	Data type	BOOL
	Range	0, 1
	Unit	n/a
	Default	—
AxesGroup	Description	The axes group from which the actual velocity will be read
	Data type	AXES_GROUP_REF
	Range	n/a
	Unit	n/a

	Default	—
CoordSystem	Description	The coordinate system used when reading the actual velocity
	Data type	SINT
	Range	One of the following enumeration values: <ul style="list-style-type: none"> • MC_COORDINATE_SYSTEM_ACS = 0 • MC_COORDINATE_SYSTEM_MCS = 1 • MC_COORDINATE_SYSTEM_PCS = 2
	Unit	n/a
	Default	—
Velocity[]	Description	An array where the velocity data will be written. The length of the array must equal the maximum number of axes allowed in the group. The maximum number of axes is an argument to "MC_CreateAxesGrp" (→ p. 483) that is used to create axes groups.
	Data type	LREAL
	Range	n/a
	Unit	User units per second
	Default	—

2.3.96 Output

Valid	Description	If true, the velocities have been read without error.
	Data type	BOOL
Error	Description	If true, an error has occurred.
	Data type	BOOL
ErrorID	Description	Indicates the error if Error output is set to TRUE. See the table PLCopen Function Block ErrorID Output
	Data type	INT
PathVelocity	Description	The current measured path velocity of the group, measured by taking the square root of the sum of the squared velocities of each axis.
	Data type	LREAL
	Unit	User units per second

2.3.96.1.1.1 Example

2.3.97 Structured Text

```
Inst_MC_GrpReadActVel(DoRead, Group, CoordSys, VelList);
```

2.3.98 IL

```
BEGIN_IL
    CAL Inst_MC_GrpReadActVel(DoRead, Group, CoordsSys,
    VelList)
END_IL
```

2.3.99 FBD



2.3.100 FFLD

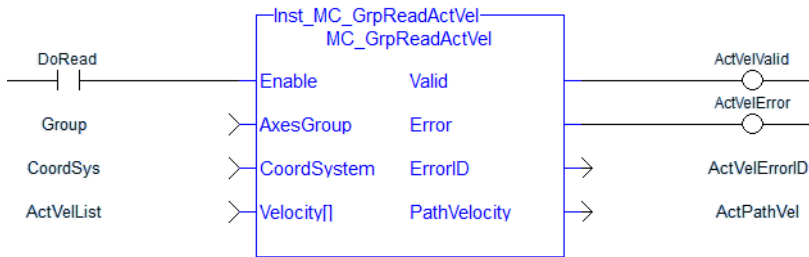

2.3.100.1.1 MC_GrpReadCmdPos PLCopen ✓ Pipe Network ✓

2.3.100.2.2.1 Description

MC_GrpReadCmdPos fills the array (specified by the `Position` argument) with the commanded position of the coordinate system specified by the `CoordSystem` argument. This function block does not cause any motion.

NOTE
Currently, only the ACS coordinate system is supported. See Coordinate Systems to learn more.

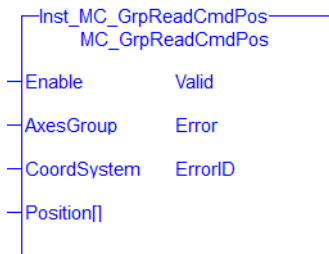
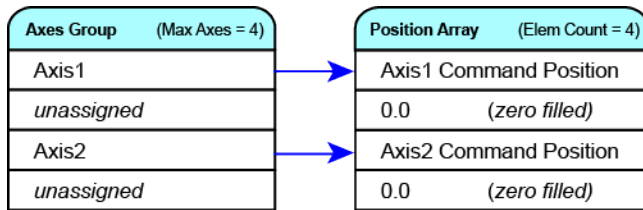

Figure 1-105: MC_GrpReadCmdPos

There is a one to one correspondence between the axes in the Axes Group and the position values in the Position Array. Each element in the Position Array corresponds to the axis element in the Axis Group array. If an index in the Axes Group is unassigned then the position value for that array element in the Position Array

will be 0. If the element does contain an axis then the position value will be filled with the current actual position for that axis. Here is an example to illustrate how this works:



2.3.101 Related Function Blocks

"MC_GrpReadActPos" (→ p. 509), "MC_GrpReadActVel" (→ p. 511), "MC_GrpReadActAcc" (→ p. 506), "MC_GrpReadCmdVel" (→ p. 517)

See also "Coordinated Motion", the top-level topic for Coordinated Motion.

2.3.101.1.1 Arguments

For more detail on how inputs and outputs work, refer to PLCopen Function Blocks - General Rules.

2.3.102 Input

Enable	Description	If True, then this function block will read the current commanded position of the axes in the group
	Data type	BOOL
	Range	0, 1
	Unit	n/a
	Default	—
AxesGroup	Description	The axes group from which the commanded position will be read.
	Data type	AXES_GROUP_REF
	Range	n/a
	Unit	n/a
	Default	—
CoordSystem	Description	The coordinate system used when reading the commanded position.
	Data type	SINT
	Range	One of the following enumeration values: <ul style="list-style-type: none"> MC_COORDINATE_SYSTEM_ACS = 0 MC_COORDINATE_SYSTEM_MCS = 1 MC_COORDINATE_SYSTEM_PCS = 2
	Unit	n/a

	Default	—
Position[]	Description	An array where the position data will be written. The length of the array must equal the maximum number of axes allowed in the group. The maximum number of axes is an argument to "MC_CreateAxesGrp" (→ p. 483), which is used to create axes groups.
	Data type	LREAL
	Range	n/a
	Unit	User units
	Default	—

2.3.103 Output

Valid	Description	If true, that the positions have been read without error.
	Data type	BOOL
Error	Description	If true, an error has occurred.
	Data type	BOOL
ErrorID	Description	Indicates the error if Error output is set to TRUE. See the table in PLCOpen Function Block ErrorID Output
	Data type	INT

2.3.103.1.1.1 Example

2.3.104 Structured Text

```
(*MC_GrpReadCmdPos ST example *)
Inst_MC_GrpReadCmdPos(DoRead, Group, CoordSys, PosList );
```

2.3.105 IL

```
BEGIN_IL
    CAL Inst_MC_GrpReadCmdPos( DoRead, Group, CoordSys, PosList
)
END_IL
```

2.3.106 FBD

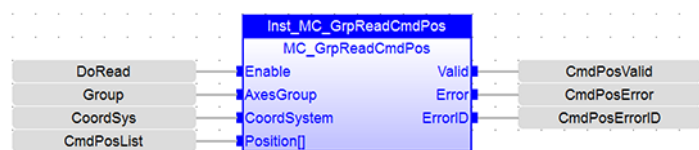

2.3.107 FFLD

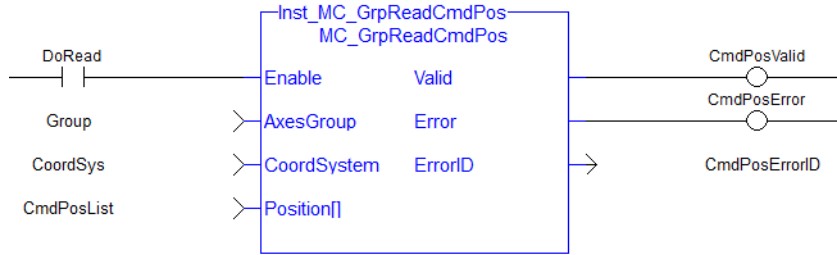

2.3.107.1.1 MC_GrpReadCmdVel PLCopen ✓ Pipe Network ✓

2.3.107.2.2.1 Description

MC_GrpReadCmdVel fills the array specified by the `Velocity` argument with the commanded velocity for the coordinate system, which is specified by the `CoordSystem` argument. The path velocity is also reported via the 'PathVelocity' output. This function block does not cause any motion.

NOTE
Currently, only the ACS coordinate system is supported. See Coordinate Systems to learn more.

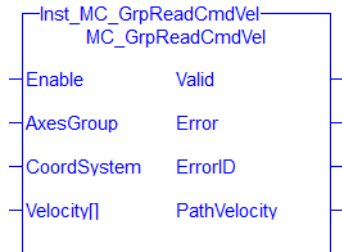
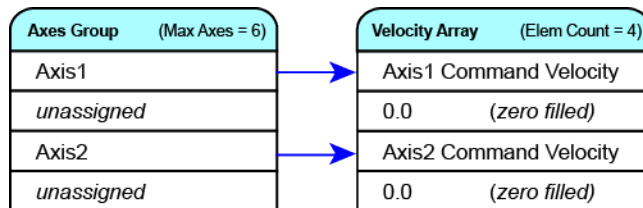

Figure 1-106: MC_GrpReadCmdVel

There is a one to one correspondence between the axes in the Axes Group and the velocity values in the Velocity Array. Each element in the Velocity Array corresponds to the axis element in the Axis Group array. If an index in the Axes Group is unassigned then the velocity value for that array element in the Velocity Array will be 0. If the element does contain an axis then the velocity value will be filled with the current velocity for that axis. Here is an example to illustrate how this works:



2.3.108 Related Function Blocks

"MC_GrpReadActPos" (→ p. 509), "MC_GrpReadActVel" (→ p. 511), "MC_GrpReadActAcc" (→ p. 506), "MC_GrpReadCmdPos" (→ p. 514)

See also "Coordinated Motion", the top-level topic for Coordinated Motion.

2.3.108.1.1.1 Arguments

For more detail on how inputs and outputs work, refer to PLCopen Function Blocks - General Rules.

2.3.109 Input

Enable	Description	If True, then this function block will read the current commanded velocity of the group and the axes in the group
	Data type	BOOL
	Range	0, 1
	Unit	n/a
	Default	—
AxesGroup	Description	The axes group from which the commanded velocity will be read.
	Data type	AXES_GROUP_REF
	Range	n/a
	Unit	n/a
	Default	—
CoordSystem	Description	The coordinate system used when reading the commanded velocity.
	Data type	SINT
	Range	One of the following enumeration values: <ul style="list-style-type: none"> • MC_COORDINATE_SYSTEM_ACS = 0 • MC_COORDINATE_SYSTEM_MCS = 1 • MC_COORDINATE_SYSTEM_PCS = 2
	Unit	n/a
	Default	—
Velocity[]	Description	An array where the velocity data will be written. The length of the array must equal the maximum number of axes allowed in the group. The maximum number of axes is an argument to "MC_CreateAxesGrp" (→ p. 483), which is used to create axes groups.
	Data type	LREAL
	Range	n/a
	Unit	User units per second
	Default	—

2.3.110 Output

Valid	Description	If true, that the velocities have been read without error.
	Data type	BOOL

Error	Description	If true, an error has occurred.
	Data type	BOOL
ErrorID	Description	Indicates the error if Error output is set to TRUE. See the table in PLCopen Function Block ErrorID Output
	Data type	INT
PathVelocity	Description	The current commanded path velocity of the group, measured by taking the square root of the sum of the squared velocities of each axis.
	Data type	LREAL
	Unit	User units per second

2.3.110.1.1.1 Example

2.3.111 Structured Text

```
(*MC_GrpReadCmdVel ST example *)
Inst_MC_GrpReadCmdVel(DoRead, Group, CoordSys, VelList );
```

2.3.112 IL

```
BEGIN_IL
    CAL Inst_MC_GrpReadCmdVel( DoRead, Group, CoordSys, VelList
)
END_IL
```

2.3.113 FBD



2.3.114 FFLD

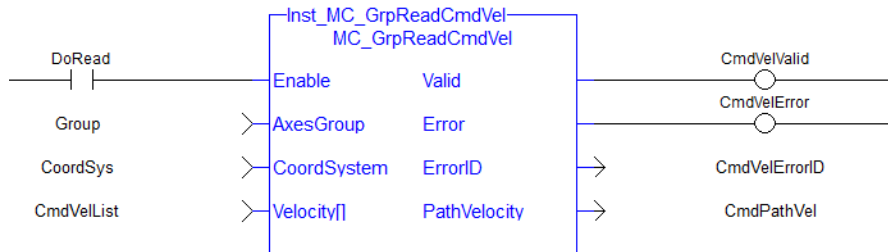

2.3.114.1.1 MC_GrpReadError PLCopen ✓ Pipe Network ✓

2.3.114.2.2.1 Description

This function describes general axes group errors. This function does not cause any motion.

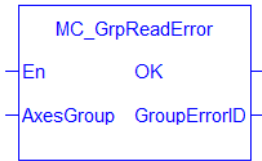

Figure 1-107: MC_GrpReadError

2.3.115 Related Functions

"MC_GrpReset" (→ p. 492), "MC_ErrorDescription" (→ p. 453)

See also "Coordinated Motion", the top-level topic for Coordinated Motion.

2.3.115.1.1 Arguments

2.3.116 Input

En	Description	Enables execution
	Data Type	BOOL
	Range	0,1
	Unit	n/a
	Default	—
AxesGroup	Description	The axes group from which the GroupErrorID will be read.
	Data Type	AXES_GROUP_REF
	Range	n/a
	Unit	n/a
	Default	—

2.3.117 Output

OK	Description	Indicates the function executed successfully
	Data Type	BOOL
GroupErrorID	Description	Displays the Error ID for the given Axis Group. See table in PLCopen Function Block ErrorID Output
	Data Type	INT

2.3.117.1.1 Examples

2.3.118 Structured Text

```
//Read a group error number
GroupErrorID:= MC_GrpReadError( Axis_Group );
```

2.3.119 FBD

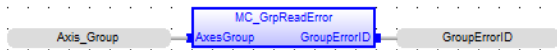

2.3.120 FFLD

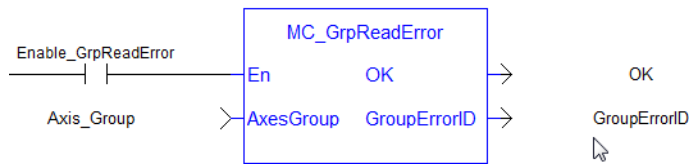

2.3.120.1.1 MC_GrpReadStatus PLCopen ✓ Pipe Network ✓

2.3.120.2.2.1 Description

MC_GrpReadStatus returns the status of an axes group. This function block does not cause any motion. Refer to Group State Diagrams for details.

NOTE

The following output is not currently supported. It will be supported in a future release.

- GroupHoming

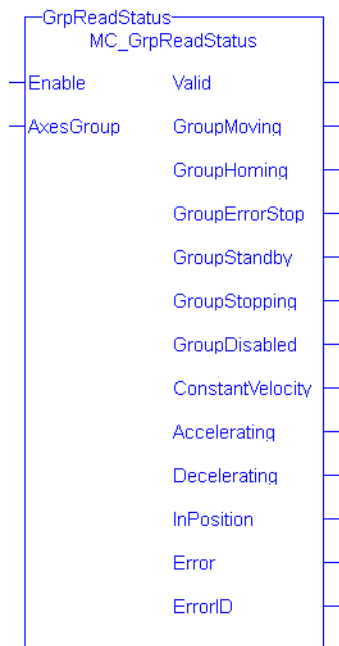

Figure 1-108: MC_GrpReadStatus

2.3.121 Related Functions

"MC_ErrorDescription" (→ p. 453)

See also "Coordinated Motion", the top-level topic for Coordinated Motion.

2.3.121.1.1.1 Arguments

2.3.121.2.2.2 Input

Enable	Description
	If True, then the axes group status will be read.

	Data type	BOOL
	Range	0. 1
	Unit	n/a
	Default	—
AxesGroup	Description	The axis group from which the status will be read
	Data type	AXIS_GROUP_REF
	Range	n/a
	Unit	n/a
	Default	—

2.3.121.3.3.3 Output

Valid	Description	True if valid outputs are available
	Data type	BOOL
GroupMoving ¹	Description	The axes group is in the Moving state, indicating that the group is enabled and currently executing a coordinated motion command.
	Data type	BOOL
GroupHoming ¹	Description	Not supported
	Data type	BOOL
GroupErrorStop ¹	Description	The axes group is in the ErrorStop state due to an axis error or group error. The group cannot accept coordinated motion commands. The execution of MC_GrpReset is required to change the group's state from ErrorStop to Standby.
	Data type	BOOL
GroupStandby ¹	Description	The axes group is in the Standby state, meaning that the group is enabled and all its axes are enabled and the group is not currently executing a coordinated motion command. The axes group is ready to accept coordinated motion commands.
	Data type	BOOL
GroupStopping ¹	Description	The axes group is in the Stopping state due the execution of MC_GrpStop. The axes group is enabled but cannot accept coordinated motion commands while in the Stopping state. The axes group remains in the Stopping state while MC_GrpStop is executing and will remain in the Stopping state while MC_GrpStop's Execute input is held high.
	Data type	BOOL

GroupDisabled ¹	Description	The axis group is in the Disabled state and cannot accept coordinated motion commands.
	Data type	BOOL
ConstantVelocity	Description	True if the commanded path velocity is the same between the current scan of the application program and the previous scan. ConstantVelocity is always TRUE for Direct moves. The commanded path velocity of Direct moves is always zero.
	Data type	BOOL
Accelerating	Description	True if the commanded path velocity is accelerating between the current scan of the application program and the previous scan.
	Data type	BOOL
Decelerating	Description	True if the commanded path velocity is decelerating between the current scan of the application program and the previous scan.
	Data type	BOOL
InPosition	Description	True indicates that the axes group is “in position”. The following must be true for the axes group to be “in position”: <ul style="list-style-type: none"> • The axes group is enabled. • There are no moves in the group’s queue. • The servo loop is closed for each axis in the group. • There are no moves in the individual axis queue for each axis in the group. • The command delta is zero for each axis in the group. • The actual position is within the In-Position Bandwidth of the command position for each axis in the group.
	Data type	BOOL
Error	Description	If True, an error has occurred.
	Data type	BOOL
ErrorID	Description	Indicates the error identifier if the Error output is set to TRUE. See the table in PLCopen Function Block ErrorID Output.
	Data type	BOOL

¹ These outputs are mutually exclusive, meaning only one will be true at a time. All others will be false. Please refer to the Group State Diagrams.

2.3.121.4.4.4 Example

2.3.122 Structured Text

```
//Check boolean status bits for an Axis Group
Inst_MC_GrpReadStatus( EnableGrpReadStatus, Group1_Ref );
```

```

IsGroupMoving:= Inst_MC_GrpReadStatus.GroupMoving;
IsGroupErrorStop:= Inst_MC_GrpReadStatus.GroupErrorStop;
IsGroupStandby:= Inst_MC_GrpReadStatus.GroupStandby;
IsGroupDisabled:= Inst_MC_GrpReadStatus.GroupDisabled;
Accelerating:= Inst_MC_GrpReadStatus.Accelerating;
IsConstantVelocity:= Inst_MC_GrpReadStatus.ConstantVelocity;
IsInPosition:= Inst_MC_GrpReadStatus.InPosition;
    
```

2.3.123 IL

```

BEGIN_IL
    CAL Inst_MC_GrpReadStatus( EnableGrpReadStatus, Group1_Ref
)
END_IL
    
```

2.3.124 FBD

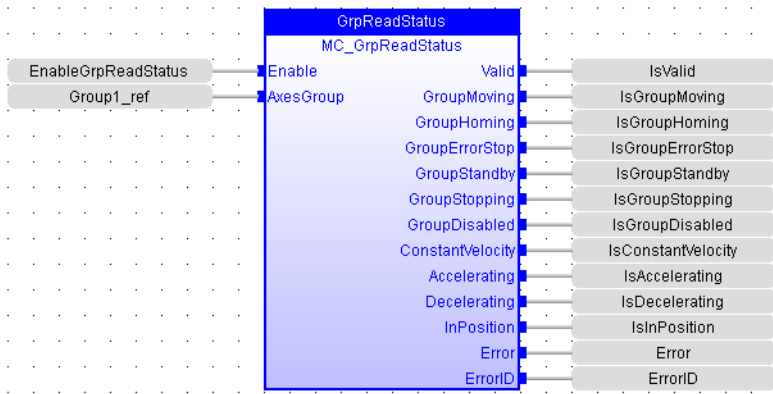

2.3.125 FFLD

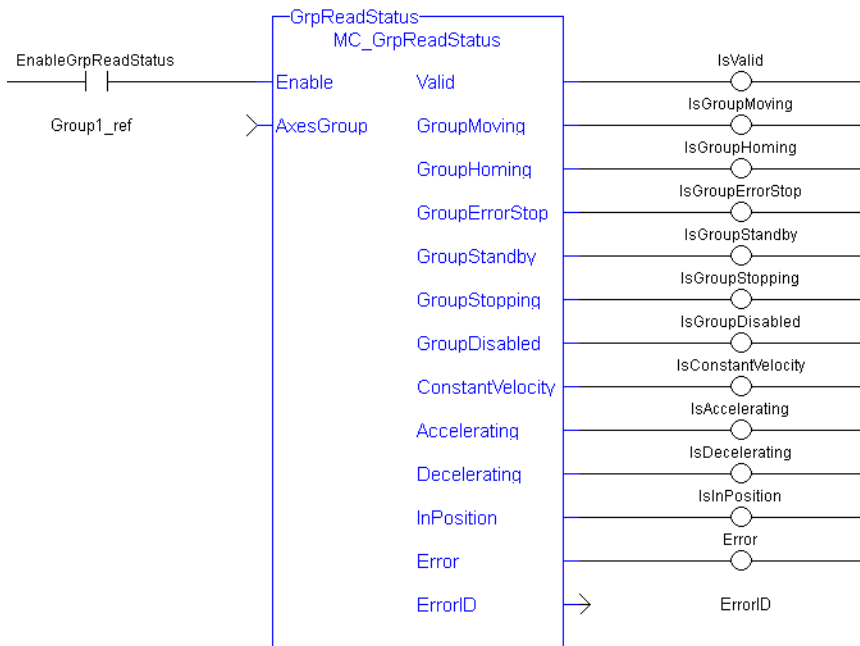

2.3.125.1 Coordinated Motion Motion Library

Function	Description
"MC_AxisSetDefaults" (→ p. 525)	Sets the default kinematic parameters for an axis.
"MC_GrpHalt" (→ p. 528)	Performs a controlled motion stop of all the axes in the group
"MC_GrpSetOverride" (→ p. 531)	Sets the velocity factor that is multiplied to the commanded velocity of all axes in the group.
"MC_MoveCircAbs" (→ p. 533)	Commands interpolated circular movement on an axes group to the specified absolute positions.
"MC_MoveCircRel" (→ p. 540)	Commands interpolated circular movement on an axes group to the specified relative positions.
"MC_MoveDirAbs" (→ p. 547)	Commands movement of an axes group to an absolute position regardless of path.
"MC_MoveDirRel" (→ p. 550)	Commands movement of an axes group to a relative position regardless of path.
"MC_MoveLinAbs" (→ p. 553)	Commands interpolated linear movement on an axes group to the specified absolute positions.
"MC_MoveLinRel" (→ p. 558)	Commands interpolated linear movement on an axes group to the specified relative positions.

2.3.125.2.1 MC_AxisSetDefaults

2.3.125.3.2.1 Description

MC_AxisSetDefaults sets the default kinematic variables for "MC_MoveDirAbs" (→ p. 547) and "MC_MoveDirRel" (→ p. 550). These variables are only used with the MC_MoveDir function blocks.

Each axis within the group must have the default kinematic parameters of Velocity, Acceleration, Deceleration, and Jerk set to values greater than zero. A non-zero Jerk value will perform an S-Curve rather than a trapezoidal move. Each axis within the group must have these values set before a direct move can be started.

The function block returns an error if the group state is not GroupStandby or GroupDisabled.

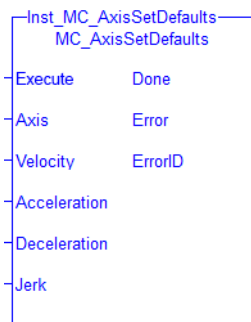

Figure 1-109: MC_AxisSetDefaults

2.3.126 Related Functions

"MC_MoveDirAbs" (→ p. 547), "MC_MoveDirRel" (→ p. 550), "MC_ErrorDescription" (→ p. 453)

See also "Coordinated Motion", the top-level topic for Coordinated Motion.

See also:

- Differences Between Functions and Function Blocks
- Calling a function

2.3.126.1.1.1 Arguments

2.3.127 Input

Execute	Description	On the rising edge, request to set the default kinematic parameters.
	Data type	BOOL
	Range	0, 1
	Unit	n/a
	Default	—
Axis	Description	Reference to the axis which will have its default kinematic parameters set.
	Data type	AXIS_REF
	Range	—
	Unit	n/a
	Default	—
Velocity	Description	The default velocity.
	Data type	LREAL
	Range	$0 < \text{Velocity} < (20 * \text{Acceleration})$ and $0 < \text{Velocity} < (20 * \text{Deceleration})$ See Limitations on Acceleration and Jerk for more information.
	Unit	User units per second
	Default	—
Acceleration	Description	Trapezoidal: Acceleration rate S-curve: Maximum acceleration see "Selection of Acceleration and Jerk Parameters for Function Blocks"
	Data type	LREAL
	Range	$(\text{Velocity} / 20) < \text{Acceleration} < (2 * \text{Jerk})$ See Limitations on Acceleration and Jerk for more information.
	Unit	User units per second ²
	Default	—
Deceleration	Description	Trapezoidal: Deceleration rate S-curve: Unused
	Data type	LREAL

	Range	$(\text{Velocity} / 20) < \text{Deceleration} < (2 * \text{Jerk})$
	Unit	User unit per second ²
	Default	—
Jerk	Description	Trapezoidal: 0 S-curve: Constant jerk see "Selection of Acceleration and Jerk Parameters for Function Blocks"
	Data type	LREAL
	Range	$(\text{Velocity} / 20) < \text{Acceleration} < (2 * \text{Jerk})$ and $(\text{Velocity} / 20) < \text{Deceleration} < (2 * \text{Jerk})$
	Unit	User units per second ³
	Default	—

2.3.128 Output

Done	Description	If True, then the command completed successfully.
	Data type	BOOL
Error	Description	If True, then an error has occurred
	Data type	BOOL
ErrorID	Description	Indicates the error if Error output is set to TRUE. See the table in PLCopen Function Block ErrorID Output.
	Data type	DINT

2.3.128.1.1.1 Example

2.3.129 Structured Text

```
(* ST MC_AxisSetDefaults Example *)

default_velocity      := 50.0;
default_acceleration  := 250.0;
default_deceleration  := 300.0;
default_jerk          := 1000.0;

Inst_MC_AxisSetDefaults ( TRUE, CoordAxis1_ref, default_
velocity, default_acceleration, default_deceleration, default_
jerk);
```

2.3.130 Instruction List

```

BEGIN_IL
    CAL Inst_MC_AxisSetDefaults( TRUE, CoordAxis1_Ref, default_
velocity, default_acceleration, default_deceleration, default_
jerk)
END_IL
    
```

2.3.131 Function Block Diagram

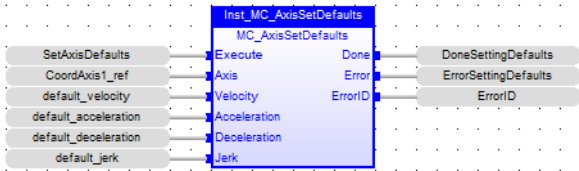

2.3.132 Ladder Diagram

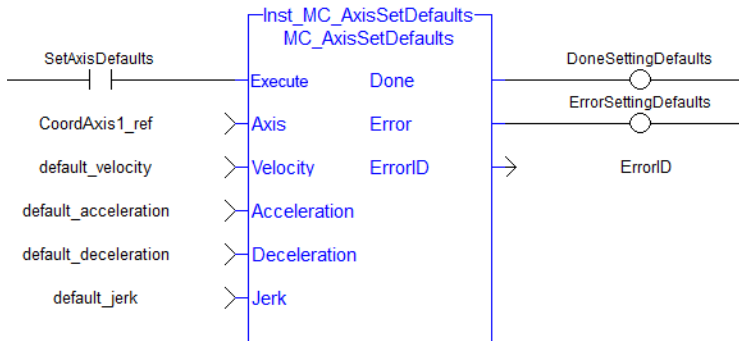

2.3.132.1.1 MC_GrpHalt PLCopen ✓ Pipe Network ✓

2.3.132.2.2.1 Description

MC_GrpHalt performs a controlled motion stop of all the axes in the group. When the path velocity reaches zero any queued moves are flushed from the buffer, the Done output is set, and the state transitions to GroupStandby. Unlike MC_GrpStop, MC_GrpHalt can be aborted.

NOTE

MC_GrpHalt does NOT prevent a single axis from executing nor does it prevent other Coordinated Motion moves from executing once MC_GrpHalt has completed.

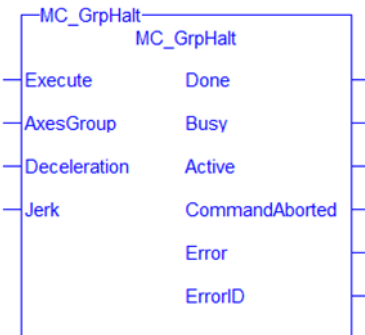

2.3.133 Related Functions

"MC_GrpStop" (→ p. 494), "MC_ErrorDescription" (→ p. 453)

See also "Coordinated Motion", the top-level topic for Coordinated Motion.

2.3.133.1.1.1 Arguments

For more details on how inputs and outputs work, refer to PLCopen Function Blocks - General Rules.

2.3.134 Input

Execute	Description	On the rising edge the command to halt all of the axes in the group is initiated.
	Data type	BOOL
	Range	0, 1
	Unit	n/a
	Default	—
AxesGroup	Description	The axes group in which the axes will be stopped.
	Data type	AXES_GROUP_REF
	Range	n/a
	Unit	n/a
	Default	—
Deceleration	Description	The path deceleration rate for all of the axes in the group
	Data type	LREAL
	Range	0 < Deceleration See Limitations on Acceleration and Jerk for more information.
	Unit	n/a
	Default	—
Jerk	Description	Not supported
	Data type	LREAL
	Range	0 ≤ Jerk See Limitations on Acceleration and Jerk for more information.
	Unit	n/a
	Default	—

2.3.135 Output

Done	Description	If True, then the command completed successfully.
	Data type	BOOL

Busy	Description	TRUE from the moment the EXECUTE input is TRUE until the time the halt is completed.
	Data type	BOOL
Active	Description	Indicates that the halt is still executing.
	Data type	BOOL
CommandAborted	Description	If True, command was aborted by another FB.
	Data type	BOOL
Error	Description	If True, an error has occurred.
	Data type	BOOL
ErrorID	Description	Indicates the error identifier if Error output is set to TRUE.. See table in PLCOpen Function Block ErrorID Output.
	Data type	INT

2.3.135.1.1.1 Example

2.3.136 Structured Text

```
Inst_MC_GrpHalt ( EnableHalt, Group1_Ref, Deceleration, Jerk );
```

2.3.137 IL

```
BEGIN_IL
    CAL Inst_MC_GrpHalt ( EnableHalt, Group1_Ref, Deceleration,
    Jerk )
END_IL
```

2.3.138 FBD

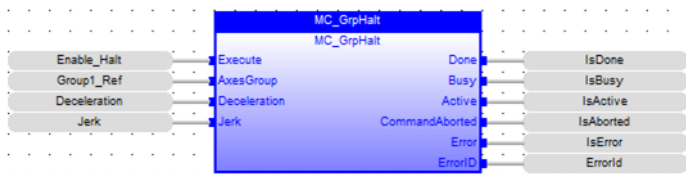

2.3.139 FFLD

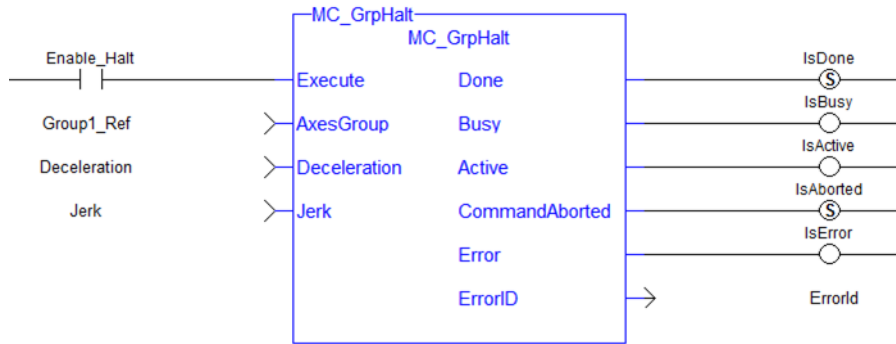

2.3.139.1.1 MC_GrpSetOverride PLCopen ✓ Pipe Network ✓

2.3.139.2.2.1 Description

MC_GrpSetOverride sets the velocity factor that is multiplied to the commanded velocity of all axes in the group. This function block in itself does not cause any motion.

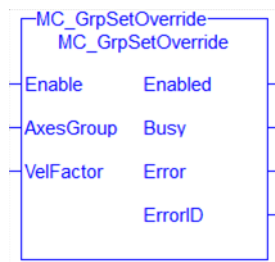

Figure 1-110: MC_GrpSetOverride

2.3.140 Related Functions

"MC_ErrorDescription" (→ p. 453)

See also "Coordinated Motion", the top-level topic for Coordinated Motion.

2.3.140.1.1.1 Arguments

For more detail on how inputs and outputs work, refer to PLCopen Function Blocks - General Rules.

2.3.141 Input

Enable	Description	On the rising edge, changes the velocity multiplier for the axes group.
	Data type	BOOL
	Range	0, 1
	Unit	n/a
	Default	—
AxesGroup	Description	The axes group in which the velocity multiplier will be applied.
	Data type	AXES_GROUP_REF
	Range	n/a

	Unit	n/a
	Default	—
VelFactor	Description	The new multiplier factor for the commanded velocity of the axes group.
	Data type	REAL
	Range	[0.0 .. 2.0]
	Unit	n/a
	Default	—

2.3.142 Output

Enabled	Description	Indicates that the override was successful.
	Data type	BOOL
Busy	Description	If True, then the FB is executing.
	Data type	BOOL
Error	Description	If True, an error has occurred.
	Data type	BOOL
ErrorID	Description	Indicates the error identifier if Error output is set to TRUE. See the table PLCOpen Function Block ErrorID Output.
	Data type	INT

2.3.142.1.1.1 Example

2.3.143 ST

```
Inst_MC_GrpSetOverride( EnableOverride, Group1_Ref,
VelocityFactor );
```

2.3.144 IL

```
BEGIN_IL
    CAL Inst_MC_GrpSetOverride( EnableOverride, Group1_Ref,
VelocityFactor )
END_IL
```

2.3.145 FBD

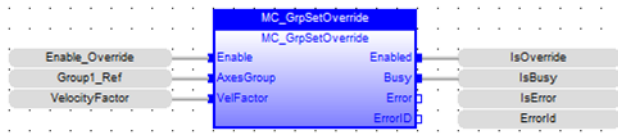

2.3.146 FFLD

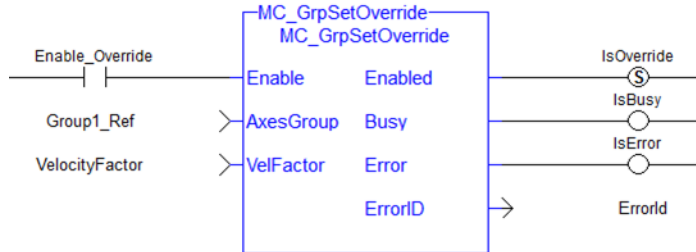

2.3.146.1.1 MC_MoveCircAbs



2.3.146.2.2.1 Description

MC_MoveCircAbs commands interpolated circular movement on an axes group to the specified absolute positions in the coordinate system as specified by the 'CoordSystem' argument. See Circular Moves Diagrams for detailed information on the movement options.

NOTE

- An error is returned if the group is in the GroupDisabled state.
- An error is returned if the input parameters do not meet the required precision. See Precision Requirements for Circular Move Input Parameters for more information.

NOTE

Circular motion is only supported for axes groups with only two attached axes.

When all motion has completed successfully, the state of the axes group goes to GroupStandby.

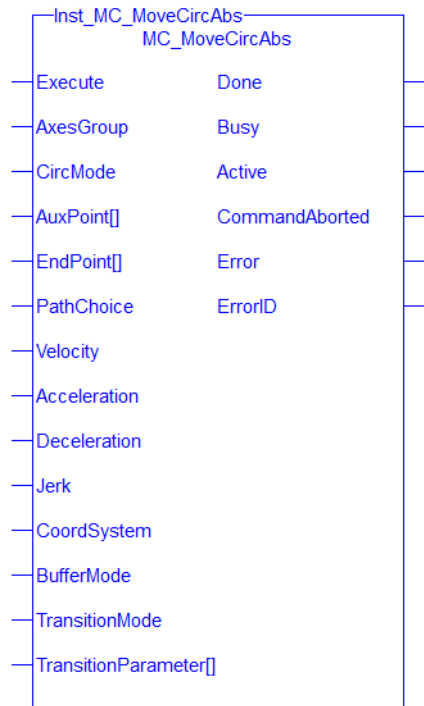

Figure 1-111: MC_MoveCircAbs

2.3.147 Related Functions

"MC_MoveCircRel" (→ p. 540), "MC_ErrorDescription" (→ p. 453)

See also "Coordinated Motion", the top-level topic for Coordinated Motion.

2.3.147.1.1.1 Arguments

2.3.148 Input

Execute	Description	On the rising edge request to perform a circular absolute move
	Data type	BOOL
	Range	0, 1
	Unit	n/a
	Default	—
AxesGroup	Description	The axis group that will perform the circular absolute move
	Data type	AXIS_GROUP_REF
	Range	n/a
	Unit	n/a
	Default	—
CircMode	Description	Specifies the meaning of the AuxPoint[] input.
	Data type	SINT One of the following enumeration values: <ul style="list-style-type: none"> • MC_CIRC_MODE_BORDER = 0 • MC_CIRC_MODE_CENTER = 1
	Range	n/a
	Unit	n/a
	Default	—

AuxPoint[]	Description	<p>Array of absolute positions for each axis in the group. The meaning depends on the value of the CircMode input:</p> <ul style="list-style-type: none"> • MC_CIRC_MODE_BORDER: AuxPoint defines a point on the circle which is crossed on the path from the starting to the end point. • MC_CIRC_MODE_CENTER: AuxPoint defines the center point of the circle.
	Data type	LREAL
	Range	[0, Number of axes in group - 1]
	Unit	n/a
	Required Precision	1 part in 100,000. See Precision Requirements for Circular Move Input Parameters.
	Default	—
EndPoint[]	Description	Array of absolute end positions for each axis in the group
	Data type	LREAL
	Range	[0, Number of axes in group - 1]
	Unit	n/a
	Default	—
	Required Precision	1 part in 100,000. See Precision Requirements for Circular Move Input Parameters.
PathChoice	Description	Specifies the direction of the path. This argument is only relevant when CircMode is MC_CIRC_MODE_CENTER.
	Data type	<p>SINT</p> <p>One of the following enumeration values:</p> <ul style="list-style-type: none"> • MC_CIRC_PATHCHOICE_CLOCKWISE = 0 = Clockwise • MC_CIRC_PATHCHOICE_COUNTERCLOCKWISE = 1 = Counterclockwise
	Range	n/a
	Unit	n/a

	Default	—
Velocity	Description	Maximum velocity of the defined path
	Data type	LREAL
	Range	$0 < \text{Velocity} < (20 * \text{Acceleration})$ and $0 < \text{Velocity} < (20 * \text{Deceleration})$ See Limitations on Acceleration and Jerk for more information.
	Unit	user units per second
	Default	—
Acceleration	Description	Maximum acceleration
	Data type	LREAL
	Range	$0 < \text{Velocity} < (20 * \text{Acceleration})$ See Limitations on Acceleration and Jerk for more information.
	Unit	user units per second ²
	Default	—
Deceleration	Description	Maximum Deceleration
	Data type	LREAL
	Range	$0 < \text{Velocity} < (20 * \text{Deceleration})$ See Limitations on Acceleration and Jerk for more information.
	Unit	user units per second ²
	Default	—
Jerk	Description	Maximum jerk
	Data type	LREAL
	Range	$(\text{Velocity} / 20) < \text{Acceleration} < (2 * \text{Jerk})$ and $(\text{Velocity} / 20) < \text{Deceleration} < (2 * \text{Jerk})$ See Limitations on Acceleration and Jerk for more information.
	Unit	user units per second ³
	Default	—

CoordSystem	Description	<p>The coordinate system used when commanding the circular absolute move.</p> <p>Currently, only the ACS coordinate system is supported. See Coordinate Systems to learn more.</p>
	Data type	SINT
	Range	<p>One of the following enumeration values:</p> <ul style="list-style-type: none"> • MC_COORDINATE_SYSTEM_ACS = 0 • MC_COORDINATE_SYSTEM_MCS = 1 • MC_COORDINATE_SYSTEM_PCS = 2
	Unit	n/a
	Default	—
BufferMode	Description	<p>Defines the chronological sequence of the function block relative to the previous block.</p> <p>The blending modes (2, 3, 4, & 5) match the path velocity at the active move's endpoint. Some individual axis velocities may make an abrupt change if the path of the next move travels in a different direction. A transition move may be programmed at the <code>TransitionMode</code> input to avoid this.</p> <p>See the table in Buffer Modes.</p>
	Data type	<p>SINT</p> <p>One of the following enumeration values:</p> <ul style="list-style-type: none"> • MC_BUFFER_MODE_BUFFERED = 1 = Buffered • MC_BUFFER_MODE_BLENDED_PREVIOUS = 2 = Blending Previous • MC_BUFFER_MODE_BLENDED_NEXT = 3 = Blending Next • MC_BUFFER_MODE_BLENDED_LOW = 4 = Blending Low • MC_BUFFER_MODE_BLENDED_HIGH = 5 = Blending High <p><i>BufferMode = Abort = 0 is not allowed with this function block.</i></p>

	Range	—
	Unit	n/a
	Default	—
TransitionMode	Description	Coupled with the TransitionParameter[], this input defines the shape and dynamics of the inserted contour to connect the current motion with the next motion in the queue. See Transition Between Moves for additional information.
	Data type	SINT
	Range	The value is limited to the following: <ul style="list-style-type: none"> • MC_TRANSITION_MODE_NONE = 0 • MC_TRANSITION_MODE_CORNER_DISTANCE = 3
	Unit	n/a
	Default	—
TransitionParameter[]	Description	This array is dependent on the TransitionMode specified. The transition parameter values are applied to the axis group. See table: " Transition Mode Parameters " for details.
	Data type	LREAL
	Range	[1, N] N values are supplier specified dependent on the TransitionMode selected.
	Unit	n/a
	Default	—

2.3.149 Output

Done	Description	If True, then the command completed successfully.
	Data type	BOOL
Busy	Description	If True, then the function block is executing.
	Data type	BOOL
Active	Description	If True, then the function block is controlling motion.

	Data type	BOOL
CommandAborted	Description	If True, command was aborted by another function block.
	Data type	BOOL
Error	Description	If True, an error has occurred.
	Data type	BOOL
ErrorID	Description	Indicates the error if Error output is set to TRUE. See table in PLCopen Function Block ErrorID Output
	Data type	INT

2.3.149.1.1.1 Example

2.3.150 ST

```

Inst_MC_MoveCircAbs( ExecuteMove, Group1_Ref, MC_CIRC_MODE_
BORDER, AuxPoints, EndPoints, MC_CIRC_PATHCHOICE_CLOCKWISE,
Velocity, Acceleration, Deceleration, Jerk, MC_COORDINATE_
SYSTEM_ACS, MC_BUFFER_MODE_ABORTING, MC_TRANSITION_MODE_NONE,
TransitionParams );
    
```

2.3.151 IL

```

BEGIN_IL
    CALL Inst_MC_MoveCircAbs( ExecuteMove, Group1_Ref, MC_CIRC_
MODE_BORDER, AuxPoints, EndPoints, MC_CIRC_PATHCHOICE_CLOCKWISE,
Velocity, Acceleration, Deceleration, Jerk, MC_COORDINATE_
SYSTEM_ACS, MC_BUFFER_MODE_ABORTING, MC_TRANSITION_MODE_NONE,
TransitionParams )
END_IL
    
```

2.3.152 FBD

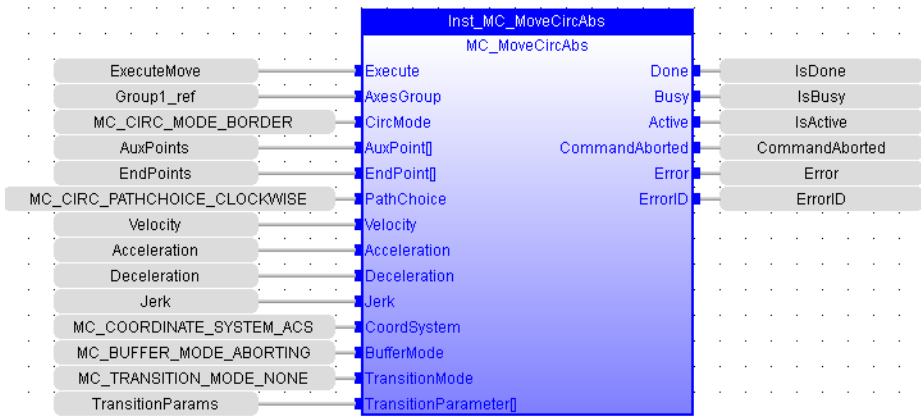

2.3.153 FFLD

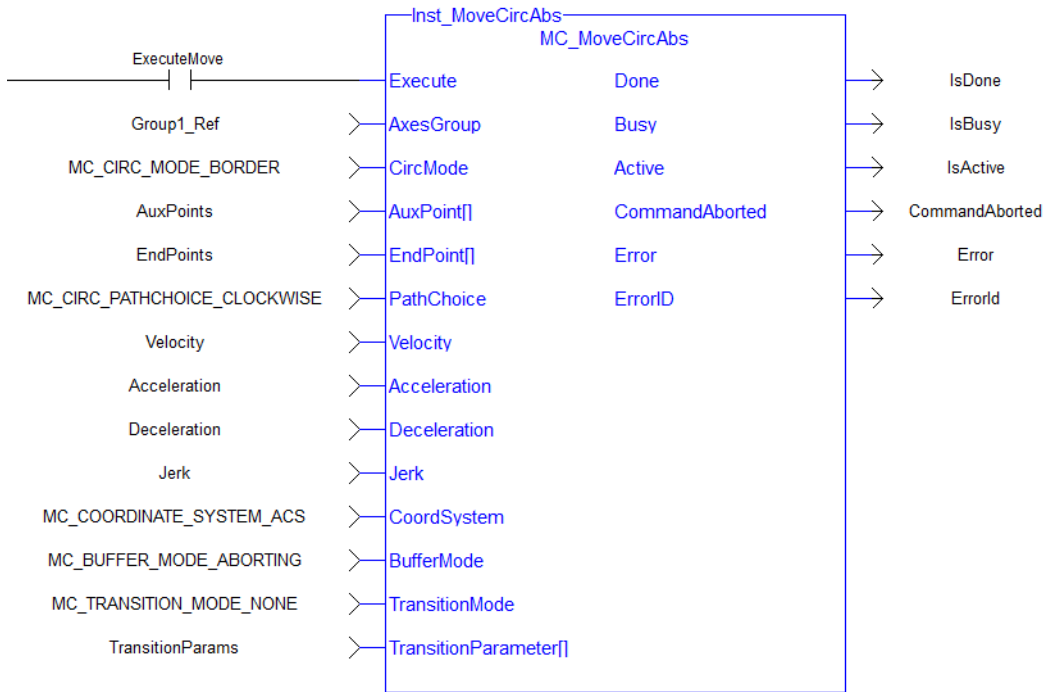

2.3.153.1.1 MC_MoveCircRel



2.3.153.2.2.1 Description

MC_MoveCircRel commands interpolated circular movement on an axes group to the specified relative positions in the coordinate system as specified by the 'CoordSystem' argument. See Circular Moves Diagrams for detailed information on the movement options.

NOTE

An error is returned if the group is in the GroupDisabled state.

NOTE

Circular motion is only supported for axes groups with only two attached axes.

When all motion has completed successfully, the state of the axes group goes to GroupStandby.

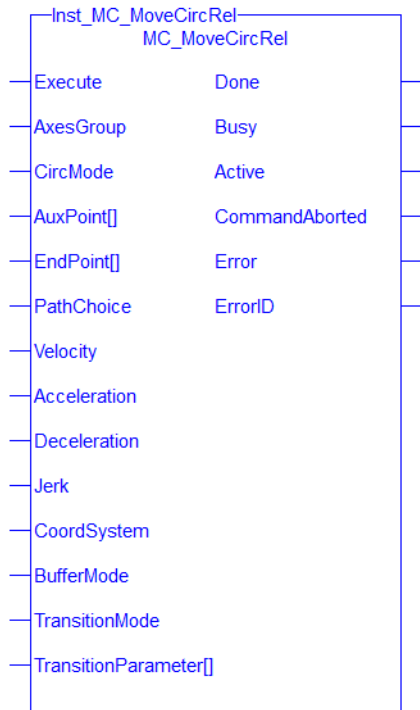

Figure 1-112: MC_MoveCircRel

2.3.154 Related Functions

"MC_MoveCircAbs" (→ p. 533), "MC_ErrorDescription" (→ p. 453)

See also "Coordinated Motion", the top-level topic for Coordinated Motion.

2.3.154.1.1.1 Arguments

2.3.155 Input

Execute	Description	On the rising edge request to perform a circular relative move.
	Data type	BOOL
	Range	0, 1
	Unit	n/a
	Default	—
AxesGroup	Description	The axis group that will perform the circular relative move
	Data type	AXIS_GROUP_REF
	Range	n/a
	Unit	n/a
	Default	—

CircMode	Description	Specifies the meaning of the AuxPoint[] input (see AuxPoint[] below).
	Data type	SINT One of the following enumeration values: <ul style="list-style-type: none"> • MC_CIRC_MODE_BORDER = 0 • MC_CIRC_MODE_CENTER = 1
	Range	n/a
	Unit	n/a
	Default	—
AuxPoint[]	Description	Array of relative positions for each axis in the group. The meaning depends on the value of the CircMode input: <ul style="list-style-type: none"> • MC_CIRC_MODE_BORDER: AuxPoint defines a point on the circle which is crossed on the path from the starting to the end point. • MC_CIRC_MODE_CENTER: AuxPoint defines the center point of the circle. <p>In all cases the points are relative to the starting point.</p>
	Data type	LREAL
	Range	[0, Number of axes in group - 1]
	Unit	n/a
	Default	—
	Required Precision	1 part in 100,000. See Precision Requirements for Circular Move Input Parameters.
EndPoint[]	Description	Array of relative end positions for each axis in the group.
	Data type	LREAL
	Range	[0, Number of axes in group - 1]
	Unit	n/a
	Default	—
	Required Precision	1 part in 100,000. See Precision Requirements for Circular Move Input Parameters.
PathChoice	Description	Specifies the direction of the path. This argument is only relevant when CircMode is MC_CIRC_MODE_CENTER.

	Data type	SINT One of the following enumeration values: <ul style="list-style-type: none"> MC_CIRC_PATHCHOICE_CLOCKWISE = 0 = Clockwise MC_CIRC_PATHCHOICE_COUNTERCLOCKWISE = 1 = Counterclockwise
	Range	n/a
	Unit	n/a
	Default	—
Velocity	Description	Maximum velocity of the defined path
	Data type	LREAL
	Range	0 < Velocity < (20 * Acceleration) and 0 < Velocity < (20 * Deceleration) See Limitations on Acceleration and Jerk for more information.
	Unit	user units per second
	Default	—
Acceleration	Description	Maximum acceleration
	Data type	LREAL
	Range	0 < Velocity < (20 * Acceleration) See Limitations on Acceleration and Jerk for more information.
	Unit	user units per second ²
	Default	—
Deceleration	Description	Maximum Deceleration
	Data type	LREAL
	Range	0 < Velocity < (20 * Deceleration) See Limitations on Acceleration and Jerk for more information.
	Unit	user units per second ²
	Default	—
Jerk	Description	Maximum jerk
	Data type	LREAL

	Range	(Velocity / 20) < Acceleration < (2 * Jerk) and (Velocity / 20) < Deceleration < (2 * Jerk) See Limitations on Acceleration and Jerk for more information.
	Unit	user units per second ³
	Default	—
CoordSystem	Description	The coordinate system used when commanding the circular relative move Currently, only the ACS coordinate system is supported. See Coordinate Systems to learn more.
	Data type	SINT
	Range	One of the following enumeration values: <ul style="list-style-type: none"> • MC_COORDINATE_SYSTEM_ACS = 0 • MC_COORDINATE_SYSTEM_MCS = 1 • MC_COORDINATE_SYSTEM_PCS = 2
	Unit	n/a
	Default	—
BufferMode	Description	Defines the chronological sequence of the function block relative to the previous block. The blending modes (2, 3, 4, & 5) match the path velocity at the active move's endpoint. Some individual axis velocities may make an abrupt change if the path of the next move travels in a different direction. A transition move may be programmed at the <code>TransitionMode</code> input to avoid this. See the table in Buffer Modes.
	Data type	SINT One of the following enumeration values: <ul style="list-style-type: none"> • MC_BUFFER_MODE_ABORTING = 0 = Abort • MC_BUFFER_MODE_BUFFERED = 1 = Buffered • MC_BUFFER_MODE_BLENDING_PREVIOUS = 2 = Blending Previous • MC_BUFFER_MODE_BLENDING_NEXT = 3 = Blending Next • MC_BUFFER_MODE_BLENDING_LOW = 4 = Blending Low • MC_BUFFER_MODE_BLENDING_HIGH = 5 = Blending High
	Range	—

	Unit	n/a
	Default	—
TransitionMode	Description	Coupled with the TransitionParameter[], this input defines the shape and dynamics of the inserted contour to connect the current motion with the next motion in the queue. See Transition Between Moves for additional information.
	Data type	SINT
	Range	The value is limited to the following: <ul style="list-style-type: none"> • MC_TRANSITION_MODE_NONE = 0 • MC_TRANSITION_MODE_CORNER_DISTANCE = 3
	Unit	n/a
	Default	—
TransitionParameter[]	Description	This array is dependent on the TransitionMode specified. The transition parameter values are applied to the axis group. See table: " Transition Mode Parameters " for details.
	Data type	LREAL
	Range	[1, N] N values are supplier specified dependent on the TransitionMode selected.
	Unit	n/a
	Default	—

2.3.156 Output

Done	Description	If True, then the command completed successfully.
	Data type	BOOL
Busy	Description	If True, then the function block is executing.
	Data type	BOOL
Active	Description	If True, then the function block is controlling motion.
	Data type	BOOL
CommandAborted	Description	If True, command was aborted by another function block.
	Data type	BOOL

Error	Description	If True, an error has occurred.
	Data type	BOOL
ErrorID	Description	Indicates the error if Error output is set to TRUE. See table in PLCopen Function Block ErrorID Output
	Data type	INT

2.3.156.1.1.1 Example

2.3.157 ST

```

Inst_MC_MoveCircRel( ExecuteMove, Group1_Ref, MC_CIRC_MODE_
BORDER, AuxPoints, EndPoints, MC_CIRC_PATHCHOICE_CLOCKWISE,
Velocity, Acceleration, Deceleration, Jerk, MC_COORDINATE_
SYSTEM_ACS, MC_BUFFER_MODE_ABORTING, MC_TRANSITION_MODE_NONE,
TransitionParams );
    
```

2.3.158 IL

```

BEGIN_IL
    CAL Inst_MC_MoveCircRel( ExecuteMove, Group1_Ref, MC_CIRC_
MODE_BORDER, AuxPoints, EndPoints, MC_CIRC_PATHCHOICE_CLOCKWISE,
Velocity, Acceleration, Deceleration, Jerk, MC_COORDINATE_
SYSTEM_ACS, MC_BUFFER_MODE_ABORTING, MC_TRANSITION_MODE_NONE,
TransitionParams )
END_IL
    
```

2.3.159 FBD

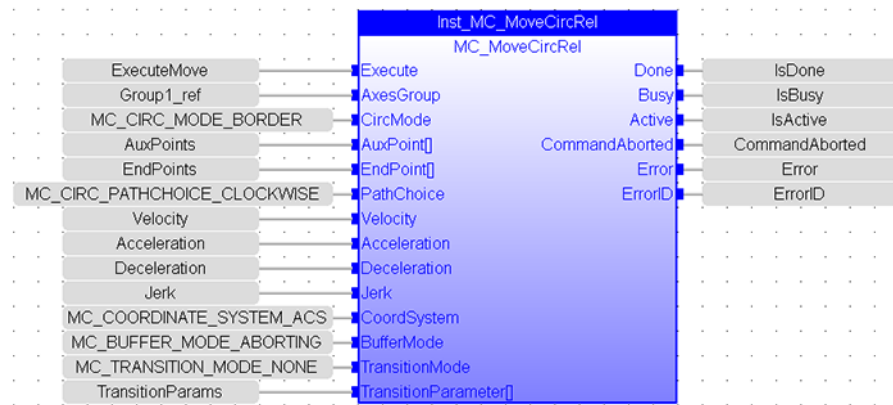

2.3.160 FFLD

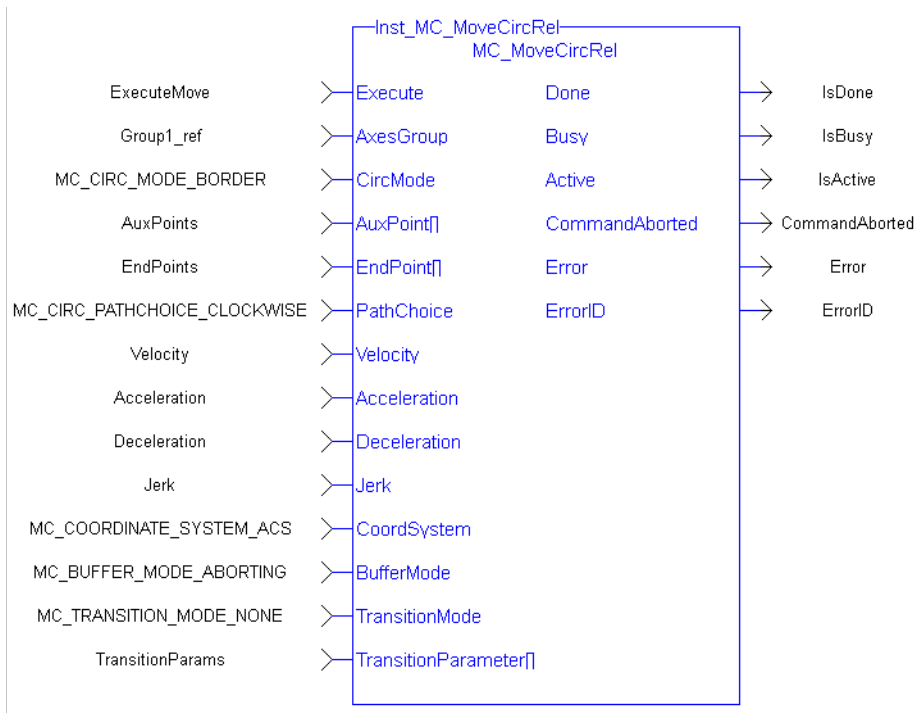

2.3.160.1.1 MC_MoveDirAbs PLCopen ✓ Pipe Network ✓

2.3.160.2.2.1 Description

MC_MoveDirAbs commands the movement of an axes group to a specified absolute position in the specified coordinate system without taking care of how (on which path) the target position is reached.

NOTE

- An error is returned if the group is in the GroupDisabled state.
- This function block does not have its own Acceleration, Deceleration, Velocity, and Jerk arguments. These are set using "MC_AxisSetDefaults" (→ p. 525).
- The maximum number of axes is set by the **MaxNumberOfAxes** input set in the "MC_CreateAxesGrp" (→ p. 483) function block.

When all motion is completed successfully, the state becomes GroupStandby.

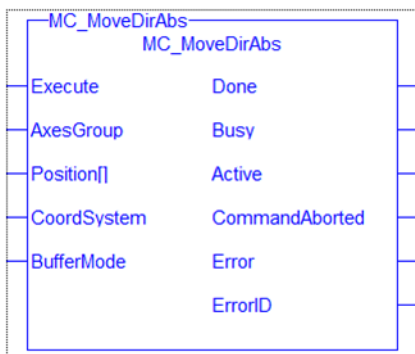

Figure 1-113: MC_MoveDirAbs

2.3.161 Related Functions

"MC_MoveDirRel" (→ p. 550), "MC_ErrorDescription" (→ p. 453)

See also "Coordinated Motion", the top-level topic for Coordinated Motion.

2.3.161.1.1.1 Arguments

2.3.162 Input

Execute	Description	On the rising edge, request to perform a direct absolute move.
	Data Type	BOOL
	Range	0, 1
	Unit	n/a
	Default	—
AxesGroup	Description	Reference to an axes group
	Data Type	AXES_GROUP_REF
	Range	—
	Unit	n/a
	Default	—
Position[]	Description	Array of absolute end positions for each axis in the group.
	Data Type	LREAL
	Range	[0, Number of axes in group - 1]
	Unit	n/a
	Default	—
CoordSystem	Description	The coordinate system used when commanding the direct absolute move Currently, only the ACS coordinate system is supported. See Coordinate Systems to learn more.
	Data Type	SINT
	Range	<ul style="list-style-type: none"> • MC_COORDINATE_SYSTEM_ACS = 0 • MC_COORDINATE_SYSTEM_MCS = 1 • MC_COORDINATE_SYSTEM_PCS = 2
	Unit	n/a
	Default	—
BufferMode	Description	Defines the chronological sequence of the function block relative to the previous block. See the table in Buffer Modes.

Data Type	SINT MC_BUFFER_MODE_ABORTING = 0 = Abort MC_BUFFER_MODE_BUFFERED = 1 = Buffered
Range	—
Unit	n/a
Default	—

2.3.163 Output

Done	Description	If True, then the command completed successfully.
	Data type	BOOL
Busy	Description	If True, then the function block is executing.
	Data type	BOOL
Active	Description	If True, then the function block is controlling motion.
	Data type	BOOL
CommandAborted	Description	If True, command was aborted by another function block.
	Data type	BOOL
Error	Description	If True, an error has occurred.
	Data type	BOOL
ErrorID	Description	Indicates the error if Error output is set to TRUE. See table in PLCopen Function Block ErrorID Output.
	Data type	INT

2.3.163.1.1.1 Example

2.3.164 Structure Text

```
Inst_MC_MoveDirAbs( DirectMove, Group1_Ref, PositionList, MC_
COORDSYSTEM_ACS, MC_BUFFER_MODE_ABORTING);
```

2.3.165 IL

```
BEGIN_IL
    CAL Inst_MC_MoveDirAbs( DirectMove, Group1_Ref,
    PositionList, MC_COORD_SYSTEM_ACS, MC_BUFFER_MODE_ABORTING)
END_IL
```

2.3.166 Function Block Diagram

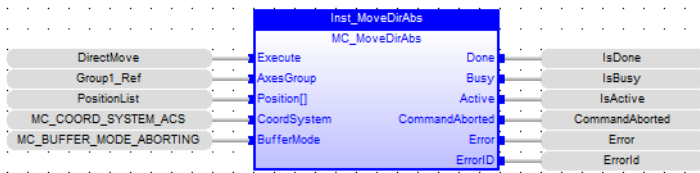

2.3.167 Ladder Diagram

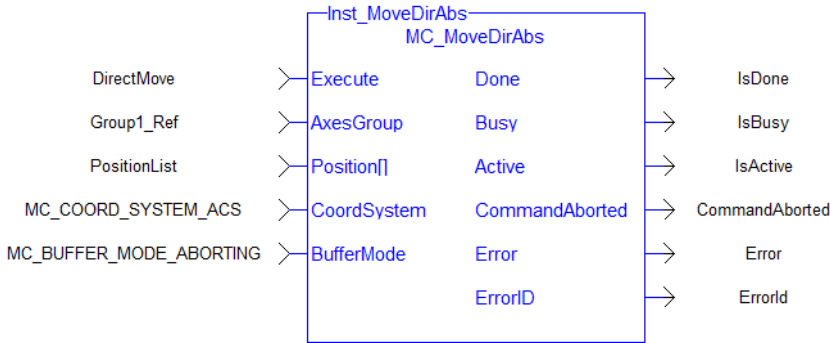

2.3.167.1.1 MC_MoveDirRel PLCopen ✓ Pipe Network ✓

2.3.167.2.2.1 Description

MC_MoveDirRel commands a movement of an axes group to a relative position in the specified coordinate system without taking care of how (on which path) the target position is reached.

NOTE

- An error is returned if the group is in the GroupDisabled state.
- This function block does not have its own Acceleration, Deceleration, Velocity, and Jerk arguments. These are set using "MC_AxisSetDefaults" (→ p. 525).
- The maximum number of axes is set by the **MaxNumberOfAxes** input set in the "MC_CreateAxesGrp" (→ p. 483) function block.

When all motion has completed successfully, the state of the axes group goes to GroupStandby.

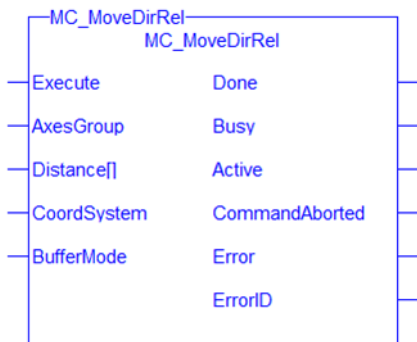

Figure 1-114: MC_MoveDirRel

2.3.168 Related Functions

"MC_MoveDirAbs" (→ p. 547), "MC_ErrorDescription" (→ p. 453)

See also "Coordinated Motion", the top-level topic for Coordinated Motion.

2.3.168.1.1.1 Arguments

2.3.169 Input

Execute	Description	On the rising edge request to perform a direct relative move.
	Data type	BOOL
	Range	0, 1
	Unit	n/a
	Default	—
AxesGroup	Description	Reference to an axes group
	Data type	AXES_GROUP_REF
	Range	—
	Unit	n/a
	Default	—
Distance[]	Description	An array containing the distance for each axis in the group.
	Data type	LREAL
	Range	[0, Number of axes in group - 1]
	Unit	n/a
	Default	—
CoordSystem	Description	The coordinate system used when commanding the direct relative move. Currently, only the ACS coordinate system is supported. See Coordinate Systems to learn more.
	Data type	SINT
	Range	<ul style="list-style-type: none"> • MC_COORDINATE_SYSTEM_ACS = 0 • MC_COORDINATE_SYSTEM_MCS = 1 • MC_COORDINATE_SYSTEM_PCS = 2
	Unit	n/a
	Default	—
BufferMode	Description	Defines the chronological sequence of the function block relative to the previous block. See the table in Buffer Modes
	Data type	SINT MC_BUFFER_MODE_ABORTING = 0 = Abort MC_BUFFER_MODE_BUFFERED = 1 = Buffered
	Range	—
	Unit	n/a

Default	—
----------------	---

2.3.170 Output

Done	Description	If True, then the command completed successfully.
	Data type	BOOL
Busy	Description	If True, then the function block is executing.
	Data type	BOOL
Active	Description	If True, then the function block is controlling motion.
	Data type	BOOL
CommandAborted	Description	If True, command was aborted by another function block.
	Data type	BOOL
Error	Description	If True, an error has occurred.
	Data type	BOOL
ErrorID	Description	Indicates the error if Error output is set to TRUE. See table in PLCopen Function Block ErrorID Output.
	Data type	INT

2.3.170.1.1.1 Example

2.3.171 Structure Text

```
Inst_MC_MoveDirRel( ExecuteMove, Group1_Ref, DistanceList, MC_
COORDINATE_SYSTEM_ACS, MC_BUFFER_MODE_ABORTING );
```

2.3.172 IL

```
BEGIN_IL
    CAL Inst_MC_MoveDirRel( ExecuteMove, Group1_Ref,
DistanceList, MC_COORDINATE_SYSTEM_ACS, MC_BUFFER_MODE_ABORTING
)
END_IL
```

2.3.173 Function Block Diagram

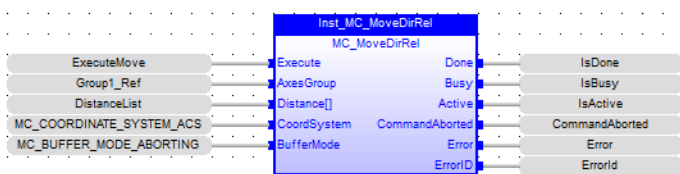

2.3.174 Ladder Diagram

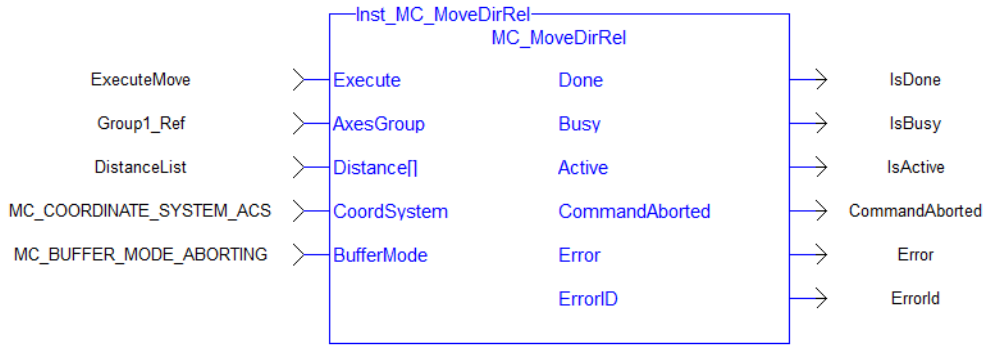

2.3.174.1.1 MC_MoveLinAbs PLCopen ✓ Pipe Network ✓

2.3.174.2.2.1 Description

MC_MoveLinAbs commands interpolated linear movement on an axes group to the specified absolute positions in the coordinate system as specified by the 'CoordSystem' argument. The dimensionality of the move is determined by the number of axes mapped to the group.

NOTE

- An error is returned if the group is in the GroupDisabled state.
- The maximum number of axes is set by the **MaxNumberOfAxes** input set in the "MC_CreateAxesGrp" (→ p. 483) function block.

When all motion has completed successfully, the state of the axes group goes to GroupStandby.

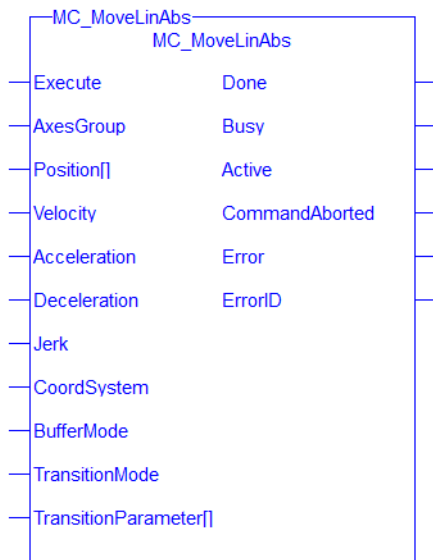

Figure 1-115: MC_MoveLinAbs

2.3.175 Related Functions

"MC_MoveLinRel" (→ p. 558), "MC_ErrorDescription" (→ p. 453)

See also "Coordinated Motion", the top-level topic for Coordinated Motion.

2.3.175.1.1.1 Arguments

2.3.176 Input

Execute	Description	On the rising edge request to perform a linear absolute move.
	Data Type	BOOL
	Range	0, 1
	Unit	n/a
	Default	—
AxesGroup	Description	The axis group that will perform the linear absolute move
	Data Type	AXIS_GROUP_REF
	Range	n/a
	Unit	n/a
	Default	—
Position[]	Description	Array of absolute end positions for each axis in the group.
	Data Type	LREAL
	Range	n/a
	Unit	user units
	Default	—
Velocity	Description	Maximum velocity of the defined path
	Data Type	LREAL
	Range	$0 < \text{Velocity} < (20 * \text{Acceleration})$ and $0 < \text{Velocity} < (20 * \text{Deceleration})$ See Limitations on Acceleration and Jerk for more information.
	Unit	user units per second
	Default	—
Acceleration	Description	Maximum acceleration
	Data Type	LREAL
	Range	$0 < \text{Velocity} < (20 * \text{Acceleration})$ See Limitations on Acceleration and Jerk for more information.
	Unit	user units per second ²

	Default	—
Deceleration	Description	Maximum deceleration
	Data Type	LREAL
	Range	0 < Velocity < (20 * Deceleration) See Limitations on Acceleration and Jerk for more information.
	Unit	user units per second ²
	Default	—
Jerk	Description	Maximum jerk
	Data Type	LREAL
	Range	(Velocity / 20) < Acceleration < (2 * Jerk) and (Velocity / 20) < Deceleration < (2 * Jerk) See Limitations on Acceleration and Jerk for more information.
	Unit	user units per second ³
	Default	—
CoordSystem	Description	The coordinate system used when commanding the linear absolute move. Currently, only the ACS coordinate system is supported. See Coordinate Systems to learn more.
	Data Type	SINT
	Range	One of the following enumeration values: <ul style="list-style-type: none"> • MC_COORDINATE_SYSTEM_ACS = 0 • MC_COORDINATE_SYSTEM_MCS = 1 • MC_COORDINATE_SYSTEM_PCS = 2
	Unit	n/a
	Default	—

BufferMode	<p>Description</p> <p>Defines the chronological sequence of the function block relative to the previous block.</p> <p>MC_BUFFER_MODE_ABORTING = 0 = Abort MC_BUFFER_MODE_BUFFERED = 1 = Buffered MC_BUFFER_MODE_BLENDING_PREVIOUS = 2 = Blending Previous MC_BUFFER_MODE_BLENDING_NEXT = 3 = Blending Next MC_BUFFER_MODE_BLENDING_LOW = 4 = Blending Low MC_BUFFER_MODE_BLENDING_HIGH = 5 = Blending High</p> <p>The buffer mode is limited to MC_BUFFER_MODE_BUFFERED for groups with more than two axes.</p> <p>The blending modes (2, 3, 4, & 5) match the path velocity at the active move's endpoint. Some individual axis velocities may make an abrupt change if the path of the next move travels in a different direction. A transition move may be programmed at the <code>TransitionMode</code> input to avoid this.</p> <p>See the table in Buffer Modes</p>
	<p>Data Type</p> <p>SINT</p>
	<p>Range</p> <p>—</p>
	<p>Unit</p> <p>n/a</p>
	<p>Default</p> <p>—</p>
TransitionMode	<p>Description</p> <p>Coupled with the <code>TransitionParameter[]</code>, this input defines the shape and dynamics of the inserted contour to connect the current motion with the next motion in the queue.</p> <p>See Transition Between Moves for additional information.</p>
	<p>Data type</p> <p>SINT</p>
	<p>Range</p> <p>The value is limited to the following:</p> <ul style="list-style-type: none"> • MC_TRANSITION_MODE_NONE = 0 • MC_TRANSITION_MODE_CORNER_DISTANCE = 3 <p>The transition mode is limited to MC_TRANSITION_MODE_NONE for groups with more than two axes.</p>
	<p>Unit</p> <p>n/a</p>
	<p>Default</p> <p>—</p>

TransitionParameter[]	Description	This array is dependent on the TransitionMode specified. The transition parameter values are applied to the axis group. See table: " Transition Mode Parameters " for details.
	Data Type	LREAL
	Range	[1, N] N values are supplier specified dependent on the TransitionMode selected.
	Unit	n/a
	Default	—

2.3.177 Output

Done	Description	If True, then the command completed successfully.
	Data type	BOOL
Busy	Description	If True, then the function block is executing.
	Data type	BOOL
Active	Description	If True, then the function block is controlling motion.
	Data type	BOOL
CommandAborted	Description	If True, then the command was aborted by another function block.
	Data type	BOOL
Error	Description	If True, an error has occurred.
	Data type	BOOL
ErrorID	Description	Indicates the error if Error output is set to TRUE. See table in PLCopen Function Block ErrorID Output
	Data type	INT

2.3.177.1.1.1 Example

2.3.178 Structured Text

```
(* Inst_MC_MoveLinAbsST example *)
Inst_MC_MoveLinAbs( ExecuteLinearMove, Group1_Ref, PositionList,
Velocity, Acceleration, Deceleration, Jerk, CoordSystem,
BufferMode, TransitionMode, TransitionParams );
```

2.3.179 IL

```

BEGIN_IL
    CAL Inst_MC_MoveLinAbs( ExecuteLinearMove, Group1_Ref,
        PositionList, Velocity, Acceleration, Deceleration, Jerk,
        CoordSystem, BufferMode, TransitionMode, TransitionParams )
END_IL
    
```

2.3.180 FBD

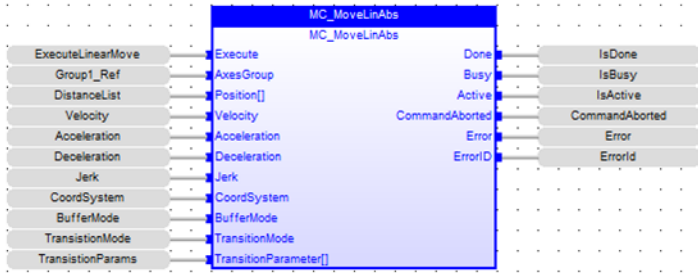

2.3.181 FFLD

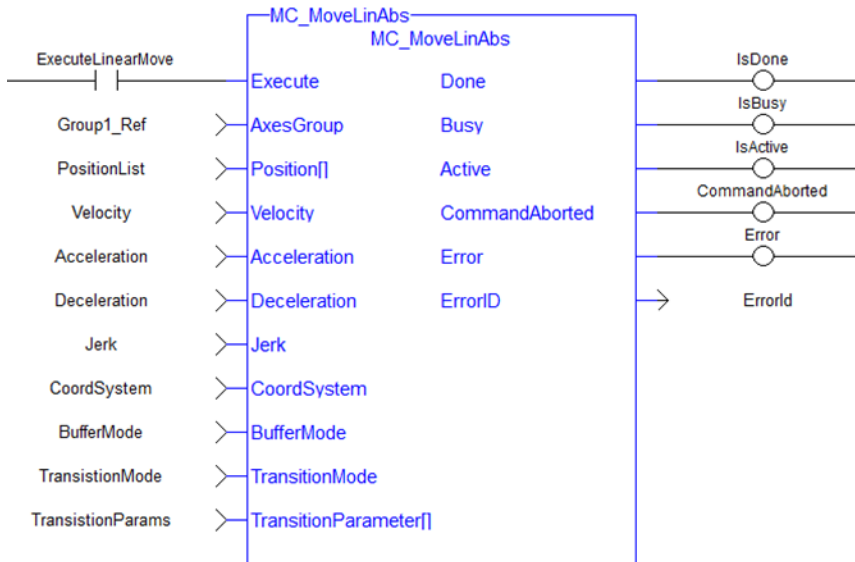

2.3.181.1.1 MC_MoveLinRel PLCopen ✓ Pipe Network ✓

2.3.181.2.2.1 Description

MC_MoveLinRel commands interpolated linear movement of an axes group to the specified relative positions. The dimensionality of the move is determined by the number of axes mapped to the group.

NOTE

- An error is returned if the group is in the GroupDisabled state.
- The maximum number of axes is set by the **MaxNumberOfAxes** input set in the "MC_CreateAxesGrp" (→ p. 483) function block.

When all motion has completed successfully, the state of the axes group goes to GroupStandby. See Transition Between Moves for additional information.

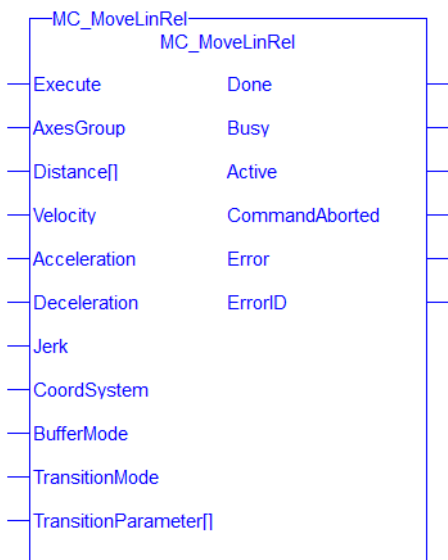

Figure 1-116: MC_MoveLinRel

2.3.182 Related Functions

"MC_MoveLinAbs" (→ p. 553), "MC_ErrorDescription" (→ p. 453)

See also "Coordinated Motion", the top-level topic for Coordinated Motion.

2.3.182.1.1.1 Arguments

2.3.183 Input

Execute	Description	On the rising edge request to perform a linear relative move
	Data Type	BOOL
	Range	0, 1
	Unit	n/a
	Default	—
AxesGroup	Description	The axis group that will perform the linear relative move
	Data Type	AXIS_GROUP_REF
	Range	n/a
	Unit	n/a
	Default	—
Distance[]	Description	Array of distances for each axis in the group.
	Data Type	LREAL
	Range	n/a

	Unit	user units
	Default	—
Velocity	Description	Maximum velocity of the defined path
	Data Type	LREAL
	Range	$0 < \text{Velocity} < (20 * \text{Acceleration})$ and $0 < \text{Velocity} < (20 * \text{Deceleration})$ See Limitations on Acceleration and Jerk for more information.
	Unit	user units per second
	Default	—
Acceleration	Description	Maximum acceleration
	Data Type	LREAL
	Range	$0 < \text{Velocity} < (20 * \text{Acceleration})$ See Limitations on Acceleration and Jerk for more information.
	Unit	user units per second ²
	Default	—
Deceleration	Description	Maximum deceleration
	Data Type	LREAL
	Range	$0 < \text{Velocity} < (20 * \text{Deceleration})$ See Limitations on Acceleration and Jerk for more information.
	Unit	user units per second ²
	Default	—
Jerk	Description	Maximum jerk
	Data Type	LREAL
	Range	$(\text{Velocity} / 20) < \text{Acceleration} < (2 * \text{Jerk})$ and $(\text{Velocity} / 20) < \text{Deceleration} < (2 * \text{Jerk})$ See Limitations on Acceleration and Jerk for more information.
	Unit	user units per second ³
	Default	—

CoordSystem	Description	<p>The coordinate system used when commanding the linear relative move</p> <p>Currently, only the ACS coordinate system is supported. See Coordinate Systems to learn more.</p>
	Data Type	SINT
	Range	<p>One of the following enumeration values:</p> <ul style="list-style-type: none"> • MC_COORDINATE_SYSTEM_ACS = 0 • MC_COORDINATE_SYSTEM_MCS = 1 • MC_COORDINATE_SYSTEM_PCS = 2
	Unit	n/a
	Default	—
BufferMode	Description	<p>Defines the chronological sequence of the function block relative to the previous block.</p> <p>MC_BUFFER_MODE_ABORTING = 0 = Abort MC_BUFFER_MODE_BUFFERED = 1 = Buffered MC_BUFFER_MODE_BLENDING_PREVIOUS = 2 = Blending Previous MC_BUFFER_MODE_BLENDING_NEXT = 3 = Blending Next MC_BUFFER_MODE_BLENDING_LOW = 4 = Blending Low MC_BUFFER_MODE_BLENDING_HIGH = 5 = Blending High</p> <p>The buffer mode is limited to MC_BUFFER_MODE_BUFFERED for groups with more than two axes.</p> <p>The blending modes (2, 3, 4, & 5) match the path velocity at the active move's endpoint. Some individual axis velocities may make an abrupt change if the path of the next move travels in a different direction. A transition move may be programmed at the <code>TransitionMode</code> input to avoid this.</p> <p>See the table in Buffer Modes</p>
	Data Type	SINT
	Range	—
	Unit	n/a
	Default	—

TransitionMode	Description	Coupled with the TransitionParameter[], this input defines the shape and dynamics of the inserted contour to connect the current motion with the next motion in the queue. See Transition Between Moves for additional information.
	Data Type	SINT
	Range	The value is limited to the following: <ul style="list-style-type: none"> • MC_TRANSITION_MODE_NONE = 0 • MC_TRANSITION_MODE_CORNER_DISTANCE = 3 <p>The transition mode is limited to MC_TRANSITION_MODE_NONE for groups with more than two axes.</p>
	Unit	n/a
	Default	—
TransitionParameter[]	Description	This array is dependent on the TransitionMode specified. The transition parameter values are applied to the axis group. See table: " Transition Mode Parameters " for details.
	Data Type	LREAL
	Range	[0, N] The value of N is dependent on the TransitionMode specified.
	Unit	n/a
	Default	—

2.3.184 Output

Done	Description	If True, then the command completed successfully.
	Data type	BOOL
Busy	Description	If True, then the function block is executing.
	Data type	BOOL
Active	Description	If True, then the function block is still controlling motion.
	Data type	BOOL
CommandAborted	Description	If True, then the command was aborted by another function block.
	Data type	BOOL

Error	Description	If True, then an error has occurred
	Data type	BOOL
ErrorID	Description	Indicates the error if Error output is set to TRUE. See table in PLCopen Function Block ErrorID Output
	Data type	INT

2.3.184.1.1.1 Example

2.3.185 Structured Text

```
(* Inst_MC_MoveLinRelST example *)

Inst_MC_MoveLinRel( ExecuteLinearMove, Group1_Ref, DistanceList,
Velocity, Acceleration, Deceleration, Jerk, CoordSystem,
BufferMode, TranstionMode, TransitionParams );
```

2.3.186 IL

```
BEGIN_IL
    CAL Inst_MC_MoveLinRel( ExecuteLinearMove, Group1_Ref,
DistanceList, Velocity, Acceleration, Deceleration, Jerk,
CoordSystem, BufferMode, TransitionMode, TransitionParams )
END_IL
```

2.3.187 FBD

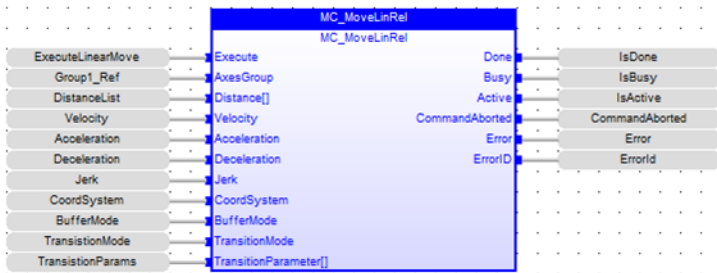

2.3.188 FFLD

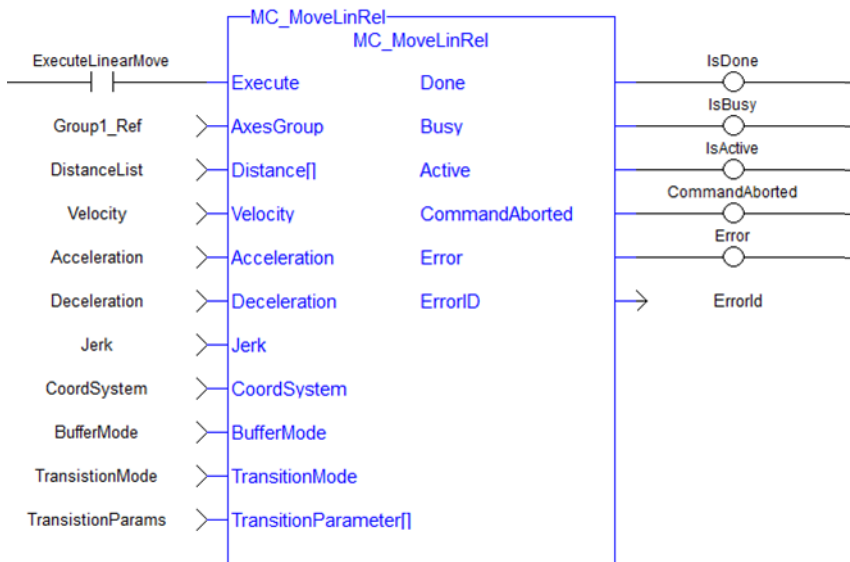

2.3.188.1 Coordinated Motion Reference Library

Function	Description
"MC_GrpSetPos" (→ p. 564)	Sets the position of the group.

2.3.188.2.1 MC_GrpSetPos PLCopen ✓ Pipe Network ✓

2.3.188.3.2.1 Description

MC_GrpSetPos sets the axis command position for all of the axes in an axes group to the positions specified in the `Position` input. This function block does not cause any motion. The axes group must be enabled and in Standby mode for MC_GrpSetPos to execute. If it is not, this FB will return an error and the axis positions will remain unchanged. The command position is that returned by the Function Block MC_GrpReadCmdPos.

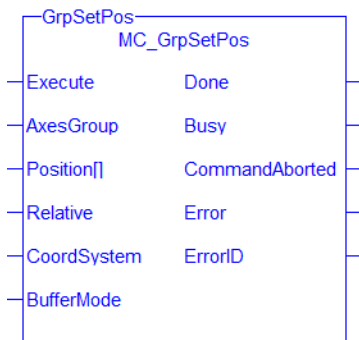

Figure 1-117: MC_GrpSetPos

2.3.189 Related Functions

"MC_ErrorDescription" (→ p. 453), "MC_GrpReadCmdPos" (→ p. 514)
 See also "Coordinated Motion", the top-level topic for Coordinated Motion.

2.3.189.1.1.1 Arguments

2.3.190 Input

Execute	Description
	On the rising edge, request to set the position of the group

	Data Type	BOOL
	Range	0, 1
	Unit	n/a
	Default	—
AxesGroup	Description	The axis group for which to set the positions
	Data Type	AXIS_GROUP_REF
	Range	n/a
	Unit	n/a
	Default	—
Position[]	Description	An array containing the position for each axis in the group. If "Relative" is set, position represents a distance rather than an absolute position. The length of the array must equal the maximum number of axes allowed in the group. The maximum number of axes is an argument to MC_CreateAxesGrp, which is used to create axes groups.
	Data Type	LREAL
	Range	[0, Number of axes in group-1]
	Unit	n/a
	Default	—
Relative	Description	Request to set relative (1) or absolute (0) position
	Data Type	BOOL
	Range	1, 0
	Unit	n/a
	Default	—
CoordSystem	Description	The coordinate system used when setting the positions.
	Data Type	SINT
	Range	One of the following enumeration values: <ul style="list-style-type: none"> • MC_COORDINATE_SYSTEM_ACS = 0 • MC_COORDINATE_SYSTEM_MCS = 1 • MC_COORDINATE_SYSTEM_PCS = 2 <p>Currently, only the ACS coordinate system is supported. See Coordinate Systems for more information.</p>
	Unit	n/a

	Default	—
BufferMode	Description	Currently unused
	Data Type	SINT
	Range	[0, 0]
	Unit	n/a
	Default	—

2.3.191 Output

Done	Description	If True, then the command completed successfully.
	Data Type	BOOL
Busy	Description	Currently unused, returns FALSE
	Data Type	BOOL
CommandAborted	Description	Currently unused, returns FALSE
	Data Type	BOOL
Error	Description	If True, an error has occurred.
	Data Type	BOOL
ErrorID	Description	Indicates the error identifier if Error output is set to TRUE. See the table in PLCopen Function Block ErrorID Output.
	Data Type	INT

2.3.191.1.1 Example

2.3.192 ST

```
Inst_MC_GrpSetPos( DoSetPos, Group1, PositionArray, Relative,
MC_COORDINATE_SYSTEM_ACS, 0 );
```

2.3.193 FBD



2.3.194 IL

```

BEGIN_IL
  CAL Inst_MC_GrpSetPos( DoSetPos, Group1, PositionArray,
    Relative, MC_COORDINATE_SYSTEM_ACS, BufferMode);
END_IL

```

2.3.195 FFLD

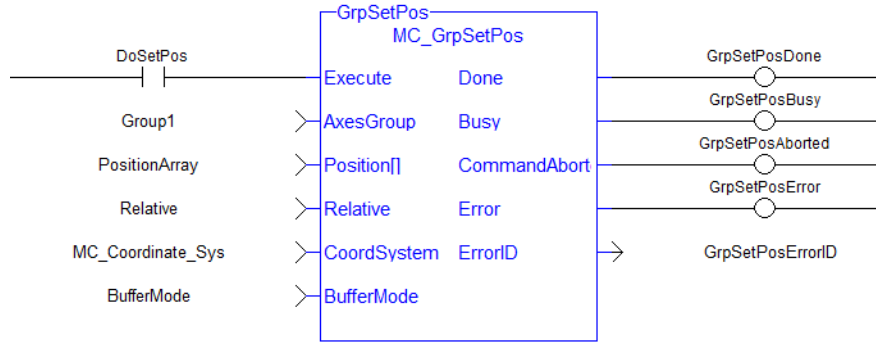

3 Fieldbus Library

3.1 EtherCAT Library	569
3.2 Profibus Library	592

3.1 EtherCAT Library

Name	Object Type	Description
DriveParamRead	SDO	Reads a drive parameter (ASCII format)
DriveParamWrite	SDO	Writes a drive parameter (ASCII format)
ECATGetObjVal	PDO	Reads cyclic drive parameter (String format) by returning the value of an EtherCAT PDO element
ECATGetStatus	PDO	Reads cyclic status word (Index 6041)
ECATReadData	PDO	Reads cyclic parameter (byte offset format)
ECATReadSdo	SDO	Reads parameter (32 bit format) using SDO command
ECATSetControl	PDO	Manipulates the state of a drive by setting its control word (Index 6040)
ECATWriteData	PDO	Writes cyclic parameter (byte offset format)
ECATWriteSdo	SDO	Writes parameter (32 bit format) using SDO command

Table 1-4: List of EtherCAT FB

The four EtherCAT SDO function blocks are activated by the CANopen over EtherCAT ([CoE](#)) protocol in a client/server mode.

- The client (aka EtherCAT master) is the KAS Runtime application
- The servers (aka EtherCAT slaves) are the drives and I/O nodes where data can be retrieved

The SDO function blocks only support the reading and writing of 32-bit values. It is the fundamental size of CANopen SDO calls.

Why use ECATReadSdo and ECATWriteSdo FBs?

The ECATReadSdo and ECATWriteSdo response time is faster and therefore is typically preferred over the DriveParamRead and DriveParamWrite.

Why use the DriveParam FBs?

The two reasons to prefer the DriveParam FBs are:

- They allow direct use of the parameter name (e.g. IL.LIMITP instead of the SDO index: 356Eh)
- They can be used to setup a drive terminal in the HMI application (which is similar to the [Terminal](#) view available in the AKD widget embedded in the KAS IDE)

See some [stats](#) about the CPU load

Increase of CPU load when calling SDO function blocks

	Mid-range AKC (Celeron 1.2GHz)	High-range AKC (Core 2 Duo 1.86GHz)
Mean	60 μ s	30 μ s
Min	48 μ s	24 μ s
Max	64 μ s	38 μ s

(these values have been computed with the TraceTimes command)

3.1.1 EtherCAT Library - Drive

These function blocks are used to work with drive parameters that are not supported by ML and MC function blocks.

They support reading and writing drive parameters using the non-cyclic SDO channel in the EtherCAT network. The ASCII name for the parameter is used as an input.

3.1.1.1.1 Execution Time

These function blocks typically take a longer time to execute (up to ten cycles to finish executing). It takes the same amount of time to Read or Write a parameter.

NOTE

It takes more than one cycle to execute these function blocks (but less than 100 ms).

3.1.1.2.2.1 Reason

It is not only linked to the SDO ASCII communication. Because these FBs are waiting for the AKD drive to respond, the execution time can also increase due to the load of the AKD firmware at the time you call them.

3.1.1.3.3.2 Result

The PLC code is overrunning the cycle duration. as explained in paragraph "**Tasking Model / Scheduling**". As a consequence, you can see the following message in the Controller Log window:

"The Virtual Machine missed 1 cycle(s) of PLC execution"

3.1.1.4.4.3 Solution

When this happens we recommend to:

- Use these function blocks sparingly in programs
- Rely on the EtherCAT read/write SDO function blocks whenever possible
- Smooth the load of the PLC code by executing these function blocks at the required update rate.

See some [stats](#) about the FB execution time

- There is a small difference in timing when running EtherCAT at 2ms compared to other frequencies.

	0.25, 0.5, 1ms	2ms
Mean	9ms	14ms
Min	3ms	8ms
Max	16ms	24ms

- **Max** time to consider when executing a single SDO command, (i.e. before the Done output becomes true): **24ms**.
- **Max** time to consider when executing a single Drive Parameter command (i.e. before the Done output becomes True): **60 ms**

	4 kHz	1 kHz
Mean	20 ms	11 ms
Min	15 ms	9 ms
Max	45 ms	58 ms

- When sending multiple commands to a single drive, only one command can be sent at a time. Therefore the time to execute multiple commands is:
Number of commands x Execution time of a single command
- When commands are sent to different AKD drives at the same time, the requests do not interfere with each other. So you can be confident the function finishes execution in the same max time as to one drive.

3.1.1.5 DriveParamRead PLCopen ✓ Pipe Network ✓

3.1.1.6.1 Description

This function block reads a drive parameter by sending an ASCII command to a drive.

It takes multiple cycles to complete this function block. Typically only *one* DriveParamRead or "DriveParamWrite" (→ p. 575) function should be active for *each axis* at one time. If executing this function block continuously or multiple times is required, add code that waits for this function block to complete (Done bit = 1) before executing it again, as shown in the example below.

See also some **stats** about the execution time [here](#).

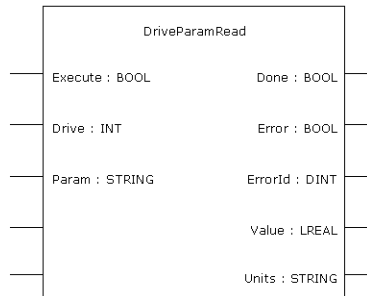

Figure 1-118: DriveParamRead

NOTE

This function block uses *and reserves* the EtherCAT SDO Channel. The SDO Channel will remain reserved until the done output is "true". Therefore, this FB should be called at each cycle until the done output is true. If it is not called at each cycle the rest of SDO communication (the AKD GUI Views, for example) will be blocked.

Using this FB in SFC P0 or P1 steps is not recommended as these steps are executed only once. If this FB is used in P0 or P1 then it must be used in an SFC N step to ensure the FB completes.

3.1.1.7.2 Arguments

3.1.1.8.3.1 Input

Execute	Description
	On the rising edge of Execute, a drive parameter is read. The function block only handles one request at a time. If Execute is toggled quickly so that another rising edge occurs before the function block has completed, the function block does not issue a second read command.
	Data type BOOL
	Range 0, 1
	Unit n/a
	Default —

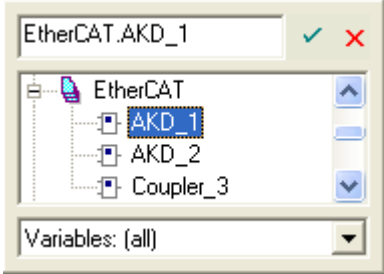
Drive	Description	<p>The address of the drive from which data is read. The first node usually has the value '1001'. The second node usually has the value '1002'.</p> <p>Alternately, you can use the members of the EtherCAT structure to specify a drive's address when you create the variable.</p>
		
	Data type	INT
	Range	—
	Unit	n/a
Param	Description	The parameter to read.
	Data type	STRING
	Range	—
	Unit	n/a
	Default	—

3.1.1.9.4.2 Output

Done	Description	Indicates whether the DriveParamRead function block has completed without error.
	Data type	BOOL
	Unit	n/a
Error	Description	Indicates whether the DriveParamRead function block call has completed with error:
	Data type	BOOL
	Unit	n/a
ErrorID	Description	The DriveParamRead error result if Error is TRUE (see list of Error Codes in table below). Upon success, Error is set to zero.
	Data type	DINT
	Unit	n/a

Value	Description	The value of the drive parameter. Value is only set when the function block has successfully completed.
	Data type	LREAL
	Unit	n/a
Units	Description	The units of the drive parameter. Value is only set when the function block has successfully completed.
	Data type	STRING
	Unit	n/a

Error Code	Value, dec (hex)	Description
ECERR_OK	0	The SDO call succeeded
ECERR_DEVICE_INVALIDINDEX	1795 (0x703)	An invalid value for the Index input was specified
ECERR_DEVICE_INVALIDACCESS	1796 (0x704)	Reading of the variable is not permitted
ECERR_DEVICE_INVALIDSIZE	1797 (0x705)	An invalid size for the parameter was specified
ECERR_DEVICE_INVALIDDATA	1798 (0x706)	Invalid parameter value(s) in SDO index and/or sub-index
ECERR_DEVICE_NOTREADY	1799 (0x707)	device is not in a ready state, network is not in operational
ECERR_DEVICE_NOTFOUND	1804 (0x70C)	EtherCAT device not found
ECERR_DEVICE_SYNTAX	1805 (0x70D)	An unexpected error occurred
ECERR_DEVICE_INVALIDSTATE	1810 (0x712)	The EtherCAT device is in an invalid state
ECERR_DEVICE_TIMEOUT	1817 (0x719)	The EtherCAT device failed to respond, timing out
ECERR_DEVICE_INSERTMAILBOX	1826 (0x722)	Error while inserting the mailbox command into internal FIFO
ECERR_DEVICE_INVALIDOFFSET	1827 (0x723)	An invalid value for the SubIndex input was specified
ECERR_DEVICE_UNKNOWNMAILBOXCMD	1828 (0x724)	The master sent an unknown mailbox command to the slave
ECERR_DEVICE_INVALIDADDR	1832 (0x728)	Can't send a mailbox command to the specified slave
ECERR_DEVICE_PARAM_ACCESS_ERROR	1920 (0x780)	Unknown error occurred while accessing parameter
ECERR_DEVICE_PARAM_NOT_FOUND	1921 (0x781)	Parameter was not found
ECERR_DEVICE_PARAM_NOT_INTEGER	1922 (0x782)	Parameter is a floating-point value. Integer value required.
ECERR_DEVICE_VALUE_IS_NEGATIVE	1923 (0x783)	No negative values allowed. Value specified was negative.
ECERR_DEVICE_VALUE_OUT_OF_RANGE	1924 (0x784)	Value is out of data-range
ECERR_DEVICE_VALUE_GREATER_THAN_MAX	1925 (0x785)	Value bigger than maximum

Error Code	Value, dec (hex)	Description
ECERR_DEVICE_VALUE_LOWER_THAN_MIN	1926 (0x786)	Value lower than minimum
ECERR_CLIENT_ERROR	2048 (0x800)	Error in Mailbox response to a previously sent mailbox command
ECERR_CLIENT_TIMEOUT	2049 (0x801)	The SDO command timed out
ECERR_CLIENT_INVALIDPARG	2050 (0x802)	An invalid value was specified
ECERR_CLIENT_INVALIDSIZE	2051 (0x803)	An invalid value for the size input was specified

Table 1-5: List of EtherCAT Error Codes

3.1.1.10.5 Usage

Use this FB to read drive parameters that are not supported by other function blocks. Examples would be motor temperature, drive bus voltage, Present drive limit settings, present regen loading, drive display, and fault history.

3.1.1.11.6 Related Functions

[DriveParamWrite](#)

3.1.1.12.7 Example

3.1.1.13.8.1 Structured Text

```

(* Read PL.KP on first AKD Drive on EtherCAT network *)
(* The code continually calls the FB (without re-executing it)
until the first execution is done, then reads the returned value
from the drive and reset the FB *)

IF ReadPropGain then
    Inst_DriveParamRead1( 1, 1001, 'PL.KP' );
End_If;

On Inst_DriveParamRead1.Done do
    Inst_DriveParamRead1( 0, 1001, 'PL.KP' );
    PositionProportionalGain := Inst_DriveParamRead1.Value; (*
Reads the returned value from the drive *)
    ReadPropGain := 0; (* Reset the FB *)
End_DO;
    
```

3.1.1.14.9.2 FBD

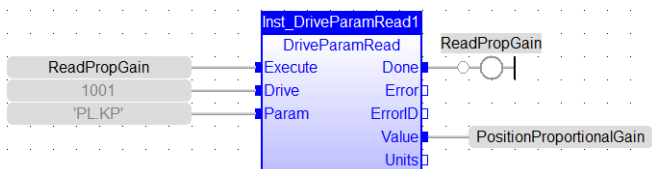

3.1.1.15.10.3 FFLD

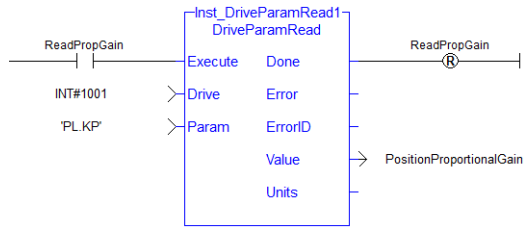

3.1.1.16 DriveParamWrite PLCopen ✓ Pipe Network ✓

3.1.1.17.1 Description

This function block writes a drive parameter by sending an ASCII command to a drive.

It takes multiple cycles to complete this function block. Typically only *one* DriveParamRead or DriveParamWrite function should be active for *each axis* at one time. If executing this function block continuously or multiple times is required, add code that waits for this function block to complete (Done bit = 1) before executing it again, as shown in DriveParamRead.

See also some **stats** about the execution time [here](#).

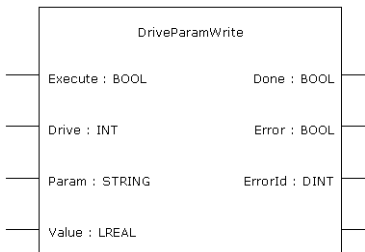

Figure 1-119: DriveParamWrite

NOTE

This function block uses *and reserves* the EtherCAT SDO Channel. The SDO Channel will remain reserved until the done output is "true". Therefore, this FB should be called at each cycle until the done output is true. If it is not called at each cycle the rest of SDO communication (the AKD GUI Views, for example) will be blocked.

Using this FB in SFC P0 or P1 steps is not recommended as these steps are executed only once. If this FB is used in P0 or P1 then it must be used in an SFC N step to ensure the FB completes.

3.1.1.18.2 Arguments

3.1.1.19.3.1 Input

Execute	Description	On the rising edge of Execute, a drive parameter is set. The function block only handles one request at a time. If Execute is toggled quickly so that another rising edge occurs before the function block has completed, the function block does not issue a second write command.
	Data type	BOOL
	Range	0, 1
	Unit	n/a
	Default	—

Drive	Description	<p>The address of the drive to which data is written to. The first node usually has the value '1001'. The second node usually has the value '1002'.</p> <p>Alternately, you can use the members of the EtherCAT structure to specify a drive's address when you create the variable.</p>
		
	Data type	INT
	Range	—
	Unit	n/a
	Default	—
Param	Description	The parameter to write.
	Data type	STRING
	Range	—
	Unit	n/a
	Default	—
Value	Description	The value to set the drive parameter to.
	Data type	LREAL
	Range	—
	Unit	n/a
	Default	—

3.1.1.20.4.2 Output

Done	Description	Indicates whether the DriveParamWrite function block has completed without error.
	Data type	BOOL
	Unit	n/a
Error	Description	Indicates whether the DriveParamWrite function block call has completed with error.

	Data type	BOOL
	Unit	n/a
ErrorID	Description	The DriveParamWrite error result if Error is TRUE (see List of EtherCAT Error Codes (→ p. 574)) Upon success, Error is set to zero.
	Data type	DINT
	Unit	n/a

3.1.1.21.5 Usage

The function block can be used to change drive parameters. Common examples include tuning parameters and changing drive limits such as peak current.

3.1.1.22.6 Related Functions

[DriveParamRead](#)

3.1.1.23.7 Example

3.1.1.24.8.1 Structured Text

```
(* Write 58.000 to PL.KP of first AKD Drive on EtherCAT network *)
Inst_DriveParamWrite( TRUE, 1001, 'PL.KP', 58 );
```

3.1.1.25.9.2 FBD

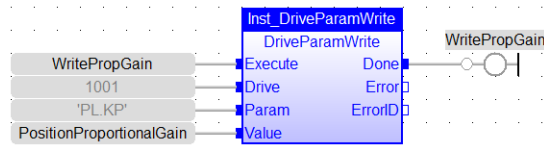

3.1.1.26.10.3 FFLD

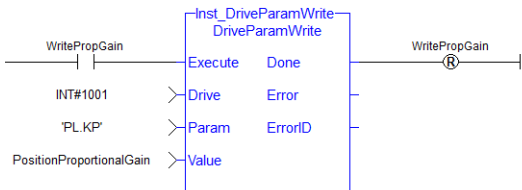

3.1.2 EtherCAT Library - SDO

These function blocks are used to work with drive or remote I/O parameters that are not supported by ML and MC function blocks.

Drive or remote I/O parameters that have an associated SDO number can be read and written using these function blocks.

NOTE

It takes more than one cycle to execute these function blocks (but less than 100 ms).

See some [stats](#) about the FB execution time

- There is a small difference in timing when running EtherCAT at 2ms compared to other frequencies.

	0.25, 0.5, 1ms	2ms
Mean	9ms	14ms
Min	3ms	8ms
Max	16ms	24ms

- **Max** time to consider when executing a single SDO command, (i.e. before the Done output becomes true): **24ms**.
- **Max** time to consider when executing a single Drive Parameter command (i.e. before the Done output becomes True): **60 ms**

	4 kHz	1 kHz
Mean	20 ms	11 ms
Min	15 ms	9 ms
Max	45 ms	58 ms

- When sending multiple commands to a single drive, only one command can be sent at a time. Therefore the time to execute multiple commands is:
Number of commands x Execution time of a single command
- When commands are sent to different AKD drives at the same time, the requests do not interfere with each other. So you can be confident the function finishes execution in the same max time as to one drive.

3.1.2.1 ECATReadSDO



3.1.2.2.1 Description

This function block reads a 32-bit word from I/O nodes using a CANopen SDO read command. It is typically used to query the status of inputs.

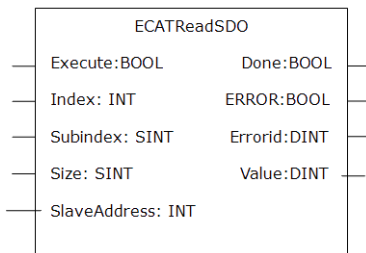

Figure 1-120: ECATReadSdo

Manufacturer specific SDOs, Object Dictionary

3.1.2.3.2.1 State Diagram

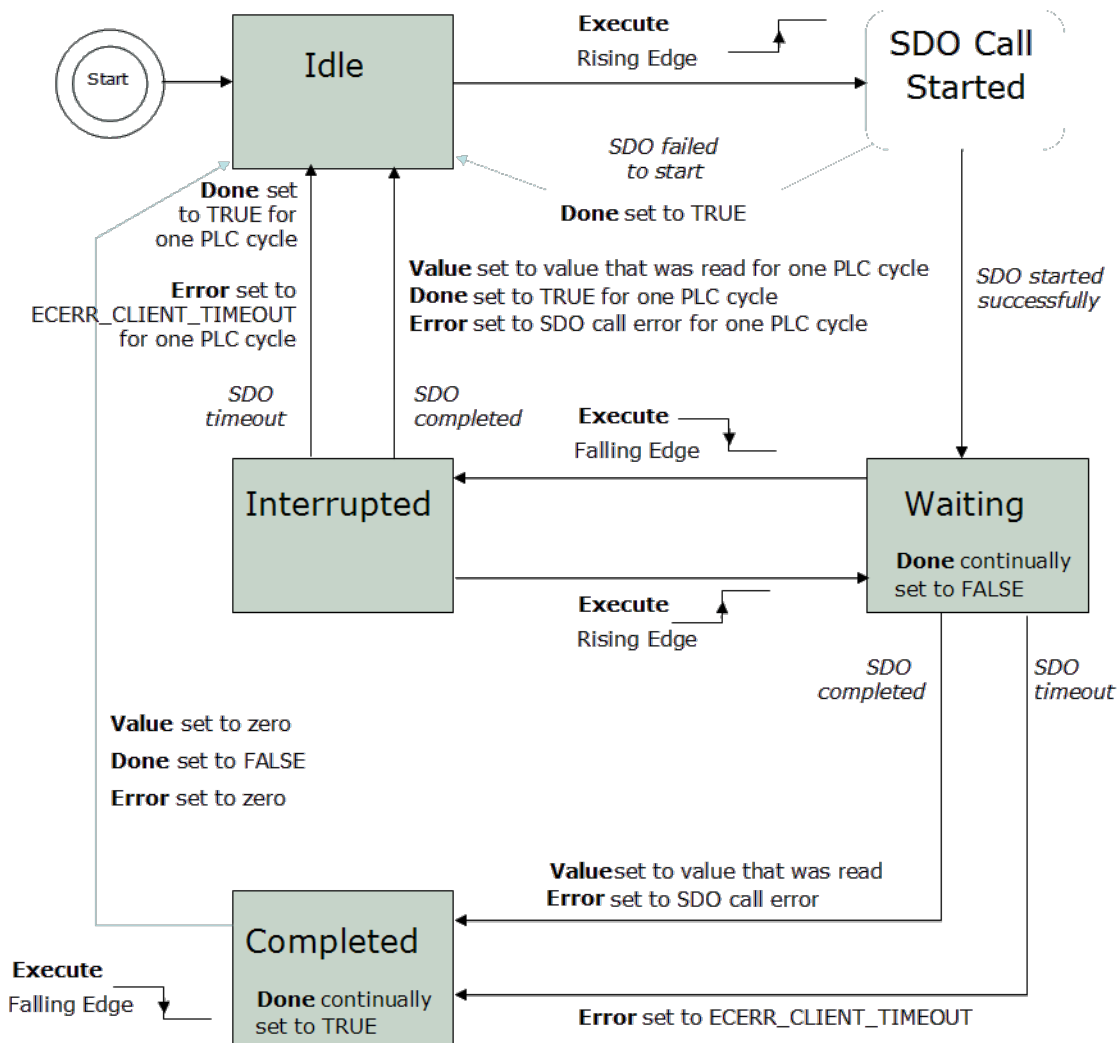

Figure 1-121: ECATReadSdo State Diagram

NOTE
 This function block uses *and reserves* the EtherCAT SDO Channel. The SDO Channel will remain reserved until the done output is "true". Therefore, this FB should be called at each cycle until the done output is true. If it is not called at each cycle the rest of SDO communication (the AKD GUI Views, for example) will be blocked.
 Using this FB in SFC P0 or P1 steps is not recommended as these steps are executed only once. If this FB is used in P0 or P1 then it must be used in an SFC N step to ensure the FB completes.

3.1.2.4.3 Arguments

3.1.2.5.4.1 Input

Execute	Description	On the rising edge of Execute, an SDO read command is issued. The function block only handles one SDO command at a time. If Execute is toggled quickly so that another rising edge occurs before the SDO command has completed, the function block does not issue a second SDO command.
	Data type	BOOL
	Range	0, 1

	Unit	n/a
	Default	—
Index	Description	<p>The object directory index of the data to be read.</p> <p>For more details, refer to:</p> <ul style="list-style-type: none"> • Communication SDOs • Manufacturer specific SDOs • Profile specific SDOs <p>To read/write an SDO object with an index greater than 16#7FFF (32767), the value must be entered in the form <code>any_to_int(index # in hex format)</code>. For example <code>any_to_int(16#8321)</code>.</p>
	Data type	INT
	Range	—
	Unit	n/a
	Default	—
Subindex	Description	<p>The sub-index of the object directory variable to be read.</p> <p>For more details, refer to:</p> <ul style="list-style-type: none"> • Communication SDOs • Manufacturer specific SDOs • Profile specific SDOs <p>To read/write an SDO object with an index greater than 16#7FFF (32767), the value must be entered in the form <code>any_to_int(index # in hex format)</code>. For example <code>any_to_int(16#8321)</code>.</p>
	Data type	SINT
	Range	—
	Unit	n/a
	Default	—
Size	Description	The size (number of bytes) to write.
	Data type	SINT
	Range	1 - 4
	Unit	n/a
	Default	—

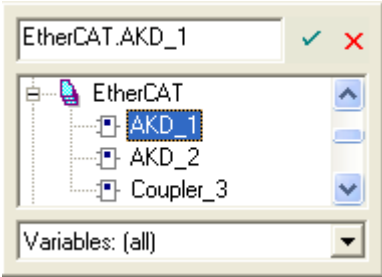
SlaveAddress	Description	<p>The EtherCAT address of the slave from which data is written to. The first node usually has the value '1001'. The second node usually has the value '1002'.</p> <p>Alternately, you can use the members of the EtherCAT structure to specify a drive's address when you create the variable.</p>
		
	Data type	INT
	Range	—
	Unit	n/a
	Default	—

3.1.2.6.5.2 Output

Done	Description	Indicates whether the SDO call has completed without error.
	Data type	BOOL
	Unit	n/a
Error	Description	Indicates whether the SDO call has completed with error:
	Data type	BOOL
	Unit	n/a
ErrorID	Description	The SDO call error result, if Error is TRUE (see list of Error Codes in table below). Upon success, Error is set to zero.
	Data type	DINT
	Unit	n/a
Value	Description	The value of the object directory variable being read. Value is only set when an SDO read command has successfully completed.
	Data type	DINT
	Unit	n/a

Table 1-6: List of EtherCAT Error Codes

3.1.2.7.6 Related Functions

ECATWriteSDO

3.1.2.8.7 Example

3.1.2.9.8.1 Structured Text

```
(* Read PL.KP on first AKD Drive on EtherCAT network *)
Inst_ECATReadSdo( TRUE, 16#3542, 0, 4, 1001 );
PositionProportionalGain := Inst_ECATReadSdo.Value;
```

```
(* Read the 4 byte data in SDO index 8321h (33569 decimal), sub-
index 1 on the first AKD Drive
Inst_ECATReadSdo( TRUE, any_to_int(16#8321), 1, 4, 1001 );
ParamValue := Inst_ECATReadSdo.Value;
```

3.1.2.10.9.2 FBD

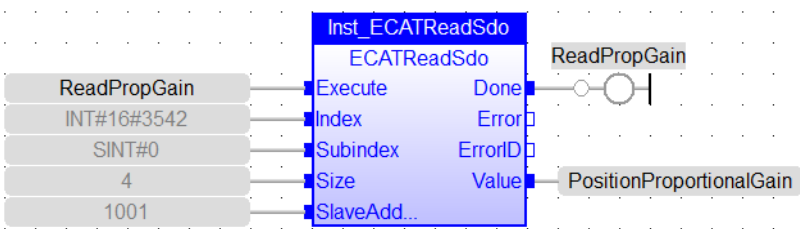

3.1.2.11.10.3 FFLD

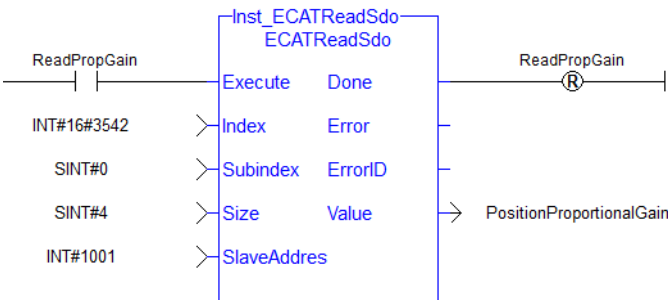

3.1.2.12 ECATWriteSDO PLCopen ✓ Pipe Network ✓

3.1.2.13.1 Description

This function block writes a 32-bit word to I/O nodes using a CANopen SDO write command.

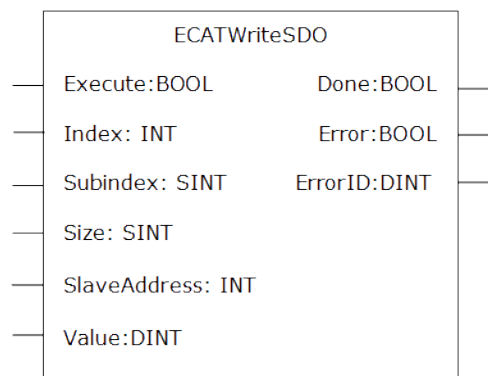

Figure 1-122: ECATWriteSdo

Manufacturer specific SDOs, Object Dictionary

3.1.2.14.2.1 State Diagram

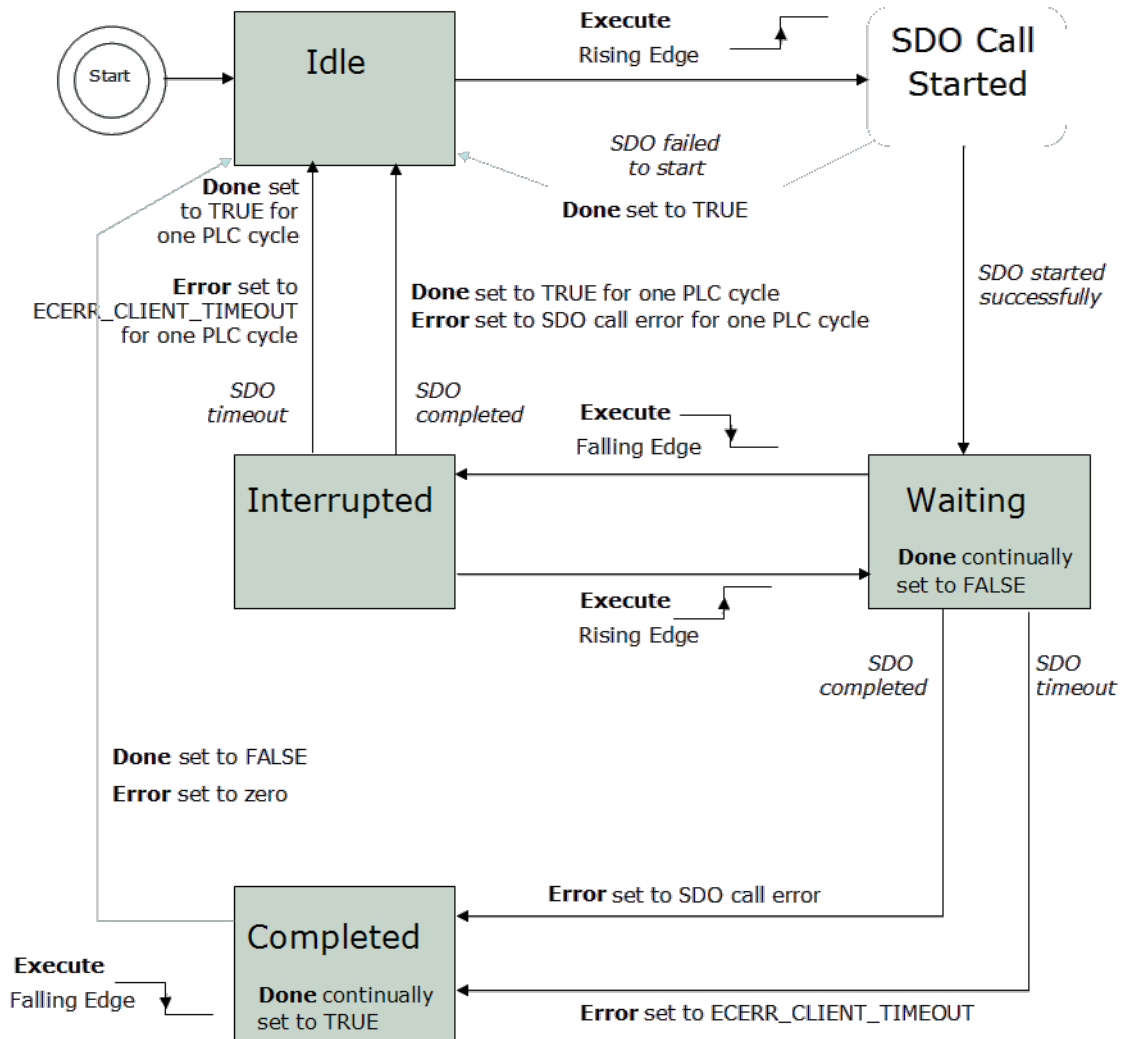

Figure 1-123: ECATWriteSdo State Diagram

NOTE

This function block uses *and reserves* the EtherCAT SDO Channel. The SDO Channel will remain reserved until the done output is "true". Therefore, this FB should be called at each cycle until the done output is true. If it is not called at each cycle the rest of SDO communication (the AKD GUI Views, for example) will be blocked.

Using this FB in SFC P0 or P1 steps is not recommended as these steps are executed only once. If this FB is used in P0 or P1 then it must be used in an SFC N step to ensure the FB completes.

3.1.2.15.3 Arguments

3.1.2.16.4.1 Input

Execute	Description
	On the rising edge of Execute, an SDO write command will be issued. The function block will only handle one SDO command at a time. If Execute is toggled quickly so that another rising edge occurs before the SDO command has completed, the function block will not issue a second SDO command.

	Data type	BOOL
	Range	0, 1
	Unit	n/a
	Default	—
Index	Description	<p>The object directory index of the data to be written to.</p> <p>For more details, refer to:</p> <ul style="list-style-type: none"> • Communication SDOs • Manufacturer specific SDOs • Profile specific SDOs <p>To read/write an SDO object with an index greater than 16#7FFF (32767), the value must be entered in the form <code>any_to_int(index # in hex format)</code>. For example <code>any_to_int(16#8321)</code>.</p>
	Data type	INT
	Range	—
	Unit	n/a
	Default	—
Subindex	Description	<p>The sub-index of the object directory variable to be written to.</p> <p>For more details, refer to:</p> <ul style="list-style-type: none"> • Communication SDOs • Manufacturer specific SDOs • Profile specific SDOs <p>To read/write an SDO object with an index greater than 16#7FFF (32767), the value must be entered in the form <code>any_to_int(index # in hex format)</code>. For example <code>any_to_int(16#8321)</code>.</p>
	Data type	SINT
	Range	—
	Unit	n/a
	Default	—
Size	Description	The size (number of bytes) to write.
	Data type	SINT
	Range	1 - 4
	Unit	n/a
	Default	—

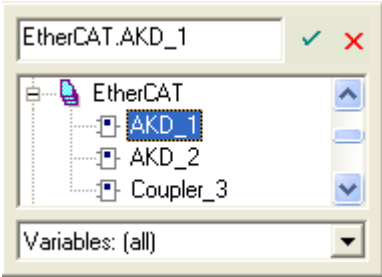
SlaveAddress	Description	<p>The EtherCAT address of the slave from which data will be written to. The first node usually has the value '1001'. The second node usually has the value '1002'.</p> <p>Alternately, you can use the members of the EtherCAT structure to specify a drive's address when you create the variable.</p>
		
	Data type	INT
	Range	—
	Unit	n/a
	Default	—
Value	Description	The value to write to the object directory variable.
	Data type	DINT
	Range	[-2147483648, 2147483648]
	Unit	n/a
	Default	—

3.1.2.17.5.2 Output

Done	Description	Indicates whether the SDO call has completed without error.
	Data type	BOOL
	Unit	n/a
Error	Description	Indicates whether the SDO call has completed with error:
	Data type	BOOL
	Unit	n/a
ErrorID	Description	The SDO call error result, if Error is TRUE (see). Upon success, Error is set to zero.
	Data type	DINT
	Unit	n/a

Table 1-7: List of EtherCAT Error Codes

3.1.2.18.6 Related Functions

[ECATReadSDO](#)

3.1.2.19.7 Example

3.1.2.20.8.1 Structured Text

```
(* Write 58.000 to PL.KP of first AKD Drive on EtherCAT network *)
Inst_ECATWriteSdo( TRUE, 16#3542, 0, 4, 1001, 58000 );
```

```
(* Write a value of 246 to the 4 byte data in SDO index 8321h (33569 decimal), sub-index 1 on the first AKD Drive *)
Inst_ECATWriteSdo( TRUE, any_to_int(16#8321), 1, 4, 1001, 246 );
```

3.1.2.21.9.2 FBD

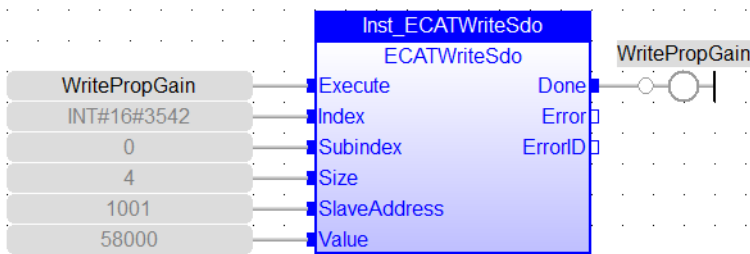

3.1.2.22.10.3 FFLD

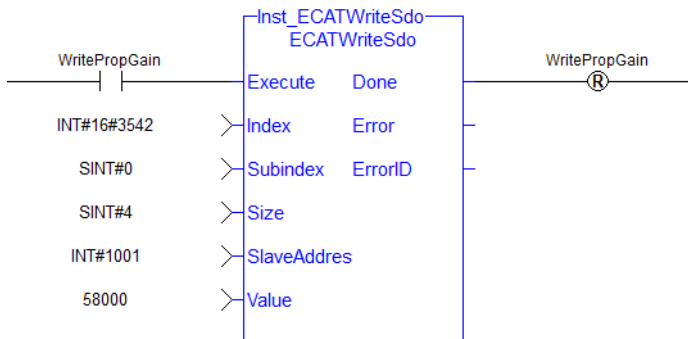

3.1.3 EtherCAT Library - Debug

The following function blocks support advanced functionality typically used for diagnostic support. Most information available in these function blocks is also available in a ML and MC function block.

3.1.3.1 ECATReadData PLCopen ✓ Pipe Network ✓

⚠ IMPORTANT

This is a low level function and it should only be used carefully by **advanced users**.

3.1.3.2.1 Description

This function allows a direct access to the memory [image](#) of the EtherCAT frame which is sent or received when you need to debug your application. You access the EtherCAT image element by giving the offset in the image and the size of the element.

If you have a device other than the drive, ECATReadData is used for more than just debug. It is used to get the status of the module (e.g. Stepper I/O slice).

3.1.3.3.2 Arguments

3.1.3.4.3.1 Input

Offset	Description	Offset in bytes from the beginning of the frame
	Data type	UINT
	Range	0-size of frame (maximum size of an Ethernet frame is 1500)
	Unit	bytes
	Default	—
Nbytes	Description	Number of bytes to read
	Data type	SINT
	Range	1, 2 or 4
	Unit	bytes
	Default	—
Direction	Description	Direction of the frame (true = output image, false = input image).
	Data type	BOOL
	Range	0, 1
	Unit	n/a
	Default	—

NOTE

The valid ranges for the **Value** parameter are:

For 1 byte: 0 to 255

For 2 bytes: 0 to 65535

For 4 bytes: - 2147483648 to 2147483648 (The sign bit represents the most significant bit in the data word)

3.1.3.5.4.2 Output

Value	Description	Value of the EtherCAT frame
	Data type	DINT
	Unit	n/a

3.1.3.6.5 Related Functions

[ECATGetObjVal](#)

3.1.3.7.6 Example

3.1.3.8.7.1 Structured Text

```
// Read 4 bytes starting at offset 26 of the output image
```

```
Position := ECATReadData(26, 4, true);
```

3.1.3.9.8.2 FBD

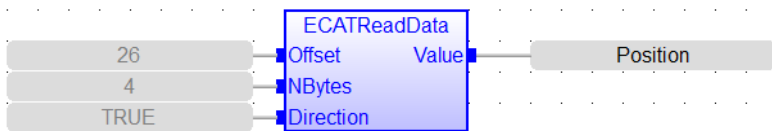

3.1.3.10.9.3 FFLD

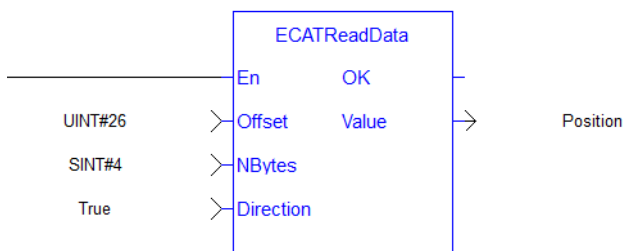

3.1.3.11 ECATWriteData



⚠ IMPORTANT

This is a low level function and it should only be used carefully by **advanced users**.

3.1.3.12.1 Description

Modify the EtherCAT process image by directly writing values in it.

If you have a device other than the drive, ECATWriteData is used for more than just debug. It is used to set the status of the module (e.g. Stepper I/O slice) in the case your project is based on an external XML file because it contains unsupported EtherCAT Device.

3.1.3.13.2 Arguments

3.1.3.14.3.1 Input

Offset	Description	Offset in bytes from the beginning of the frame
	Data type	UINT
	Range	0 - 1500
	Unit	bytes
	Default	—
Nbytes	Description	Number of bytes to write

	Data type	SINT
	Range	1, 2 or 4
	Unit	bytes
	Default	—
Value	Description	Value to be written in the image. Only the number of bytes specified by Nbytes is copied.
	Data type	DINT
	Range	[-2147483648, 2147483648]
	Unit	n/a
	Default	—

NOTE

The valid ranges for the **Value** parameter are:

For 1 byte: 0 to 255

For 2 bytes: 0 to 65535

For 4 bytes: - 2147483648 to 2147483648 (The sign bit represents the most significant bit in the data word)

3.1.3.15.4.2 Output

Default (.Q)	Description	True if data was written
	Data type	BOOL
	Unit	n/a

3.1.3.16.5 Related Functions

[ECATReadData](#)

3.1.3.17.6 Example**3.1.3.18.7.1 Structured Text**

```
//For use with Kollmorgen Thermocouple slice I/O to read in deg
C
//Lookup offset by exporting ENI file after EtherCAT network is
scanned
//Use offst 124 (byte) to write 0 in control word to allow
temperature to be shown on status byte

ON WriteControlOnly DO
ECATWriteData( 124, 1, 0 );
END_DO
```

3.1.3.19.8.2 FBD

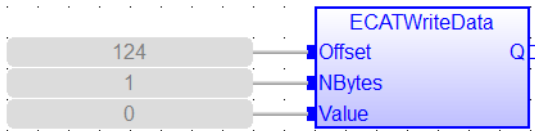

3.1.3.20.9.3 FFLD

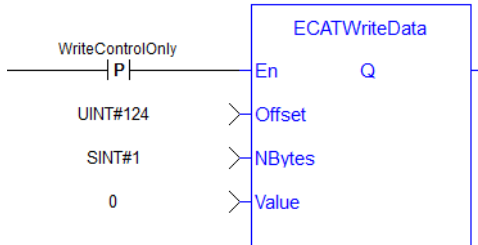

3.1.3.21 ECATGetObjVal

NOTE

This function is deprecated as of KAS v2.7. The recommended best practice is to map a PLC variable to a PDO object.

3.1.4 EtherCAT Library - Status

The following function blocks support advanced functionality typically used for diagnostic support. Most information available in these function blocks is also available in ML and MC function blocks.

3.1.4.1 ECATGetStatus PLCopen ✓ Pipe Network ✓

3.1.4.2.1 Description

Return the status word of the designated drive (SDO 0x6041).

The status machine for the status word corresponds to the CANopen status machine.

The Function Block receives the status word through the cyclic EtherCAT PDO communications. The status word is captured in every instance of fixed PDO mapping.

3.1.4.3.2 Arguments

3.1.4.4.3.1 Input

Address	Description	EtherCAT address of the drive
	Data type	DINT
	Range	[0, 65535]
	Unit	n/a
	Default	—

3.1.4.5.4.2 Output

Status	Description	Status word of the drive as defined in the EtherCAT profile for the S300/S400/S600/S700. Compatible with CiA 402 definition of status word (CANopen object 0x6041).
	Data type	UINT
	Unit	n/a

3.1.4.6.5 Related Functions

[ECATSetControl](#)

3.1.4.7.6 Example

3.1.4.8.7.1 Structured Text

```

(*****)
(* read EtherCAT axis status (Bit3: Fault, Bit7: Warning) *)
(*****)

Axis1Status := ECATGetStatus(1001); //Read the ECAT Status Word
(SDO 6041) of the Axis
Axis1Fault := Axis1Status.3;
Axis1Warning := Axis1Status.7;
    
```

3.1.4.9.8.2 FBD

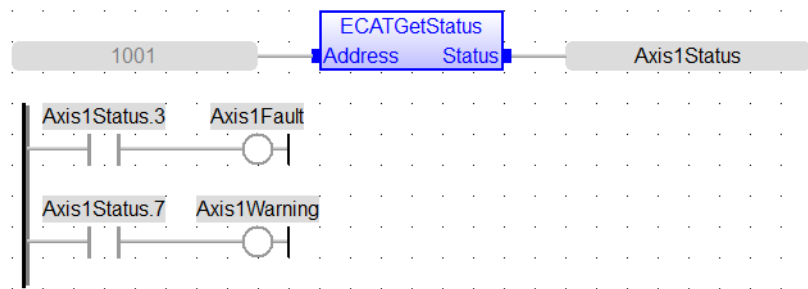

3.1.4.10.9.3 FFLD

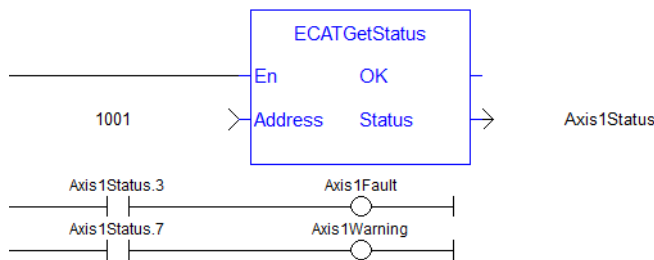

3.1.4.11 ECATSetControl PLCopen ✓ Pipe Network ✓

3.1.4.12.1 Description

Manipulate the state of a drive by setting its control word (SDO 06040).
 The status machine for the control word corresponds to the CANopen Status Machine.
 The Function Block transmits the control word through the cyclic EtherCAT PDO communications. The control word is captured in every instance of fixed PDO mapping.

3.1.4.13.2 Arguments

3.1.4.14.3.1 Input

Address	Description	EtherCAT address of the drive
	Data type	DINT
	Range	[0, 65535]

	Unit	n/a
	Default	—
Control	Description	Control word of the drive as defined in the EtherCAT profile for the S300/S400/S600/S700. Compatible with CiA 402 definition of control word (CANopen object 0x6040).
	Data type	UINT
	Range	—
	Unit	n/a
	Default	—

3.1.4.15.4.2 Output

Default (.Q)	Description	Returns true when function successfully executes (i.e. if the control word was successfully set)
	Data type	BOOL
	Unit	n/a

3.1.4.16.5 Related Functions

[ECATGetStatus](#)

3.2 Profibus Library PLCopen ✓ Pipe Network ✓

The Profibus driver has a thread that performs the exchange with the HW from time to time. The minimal exchange period (as well as the thread system priority) can be configured.

Name	Description
PBGetExchPrio	Return or change the priority of the I/O exchange thread. Which can be:
PBSetExchPrio	<ul style="list-style-type: none"> • #define CIF_EXCHANGE_PRIORITY_NORMAL 0 /* Profibus exchange thread priority lower than VM thread priority */ • #define CIF_EXCHANGE_PRIORITY_HIGHER 1 /* Profibus exchange thread priority equal to VM thread priority */
PBGetExchPeriod	Return or change the minimum period of the I/O exchange thread with the HW (in PLC cycles). 2 is the minimum value. Taking the system load into account, it can be set to more than 2.
PBSetExchPeriod	<p><i>Example:</i> set the period to 2 if you want the exchange to be performed at the most once every 2 cycles (compared with the VM cycle)</p>
PBGetExchNb	Return the amount of exchange performed with the HW
PBGetLastPeriod	Return the last period between two exchanges
PBGetMaxPeriod	idem but max period
PBResetStats	Reset the previous statistics of the I/O exchange thread. Which are: <ul style="list-style-type: none"> • the number of exchanges done • the last exchange period • the maximum exchange period <p>Statistics are reset each time the driver is Open (i.e. when the program start)</p>

Table 1-8: List of Profibus FB

4 System Library

4.1 PrintMessage	595
4.2 GetCtrlErrors	597
4.3 ClearCtrlErrors	598
4.4 GetCtrlInfo	599
4.5 GetCtrlPerf	601

Name	Description
"PrintMessage" (→ p. 595)	Generate an output message in the log windows.
"GetCtrlErrors" (→ p. 597)	Get a list of the active errors and alarms on the controller.
"ClearCtrlErrors" (→ p. 598)	Clears the list of active errors and alarms on the controller.
"GetCtrlPerf" (→ p. 601)	Generate a text file with performance statistics of the controller.
"GetCtrlInfo" (→ p. 599)	Get the serial, model, and/or part number of the controller.

Table 1-9: List of System Functions

4.1 PrintMessage

4.1.1 Description

The PrintMessage block is used to generate a log message with any wanted strings in the Log Messages window.

4.1.1.1 About the Source

PrintMessage use the PLC message type. So, to display all messages generated by PrintMessage, go to the log configuration and select the DEBUG level for the PLC source.

4.1.1.2 About the Level

The message could be sent with a logging level from 0 to 4 that qualifies its importance. The highest level, 4, logs critical messages (available levels are: debug, informational, warning, error and Critical).

Keep in mind that only Error and Critical messages a generated by default. If you want to force the system to generate every message level, go into the log configuration and change the settings to the desired level.

IMPORTANT

Enabling all messages can slow down the application's execution. To avoid locking up communications between the IDE and Runtime, you must never include a print statement in your program that prints to the log every update cycle.

See at the configuration settings for more details.

4.1.2 Arguments

4.1.2.1 Input

Level	Description
	Level of the logged message. In other words, the importance of it. Keep in mind that not all messages are displayed in the log windows by default. Only Error and Critical messages a displayed. So, in order to show lower level, it is needed to change the log settings. PrintMessage logs PLC messages.
	Data type DINT
	Range [0 , 4] Defines are: LEVEL_DEBUG, LEVEL_INFO, LEVEL_WARNING, LEVEL_ERROR, LEVEL_CRITICAL

	Unit	n/a
	Default	—
Message	Description	Content of the message. A string of 255 characters maximum.
	Data type	String
	Range	1 to 255 characters
	Unit	n/a
	Default	—

4.1.2.2 Output

Default (.Q)	Description	Returns true when function successfully executes
	Data type	BOOL
	Unit	n/a

4.1.3 Usage

```
PrintMessage( LEVEL_DEBUG, 'Message string to be logged' );
```

4.1.4 Example

4.1.4.1 Structured Text

```
// It's possible to create a temporary variable with the
// message.
MESSAGE := CONCAT( 'MachineState=', ANY_TO_STRING(MachineState),
'. MachineSpeed=', ANY_TO_STRING(MachineSpeed) );

// Then print the message to the log window
PrintMessage( LEVEL_INFO, MESSAGE );
PrintMessage( LEVEL_WARNING, MESSAGE );
PrintMessage( LEVEL_ERROR, MESSAGE );

// Or to create the string directly in the function call:
PrintMessage( LEVEL_CRITICAL, CONCAT( 'MachineState=', ANY_TO_
STRING(MachineState), '. MachineSpeed=', ANY_TO_STRING
(MachineSpeed) ) );
```

4.1.4.2 Function Block Diagram

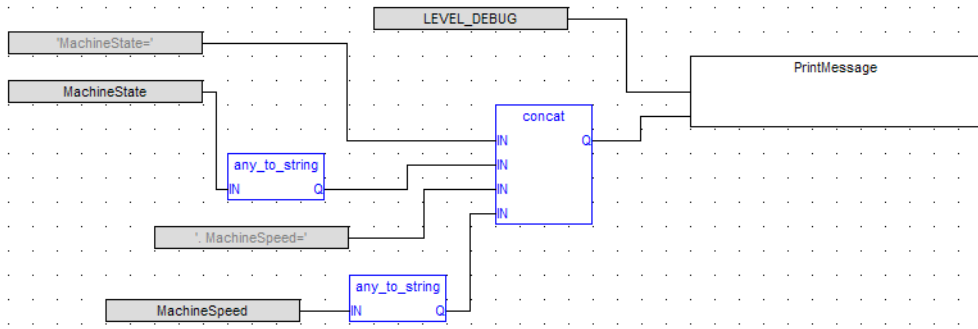

4.1.4.3 FFLD

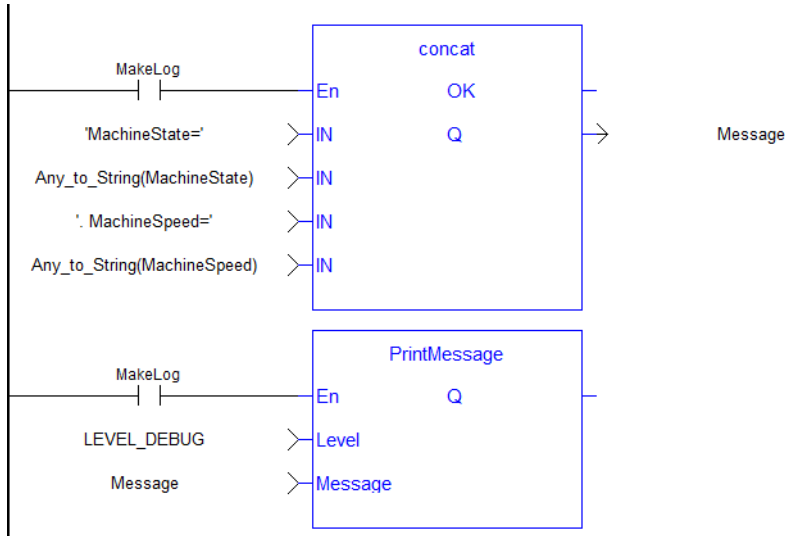

4.2 GetCtrlErrors PLCopen ✓ Pipe Network ✓

Returns active errors and alarms on the controller in two arrays of hundred Booleans. Every index in the array corresponds to the error and alarm numbers in the tables. See Errors for a list of errors and alarms that may be generated.

4.2.1 Arguments

4.2.1.1 Input

EN	BOOL	Enable
ActiveError	BOOL[100]	Array of bool with the size equal to 100
ActiveAlarm	BOOL[100]	Array of bool with size equal to 100

4.2.1.2 Output

OK	BOOL	
Q	DINT	Status of the execution

Status meaning:

Bit 0	Value 0	No error, no alarm, no shut down
Bit 0	Value 1	There is an active error or an active alarm (i.e. there is something in the array ActiveError/ActiveAlarm)
Bit 1	Value 0	No shut down
Bit 1	Value 1	The PLC processes will be shut down. This will start 10 seconds after the error is triggered
Bit 2-15	Value 2 4 9 to 2147483648	reserved

4.2.2 Examples

4.2.2.1 FBD

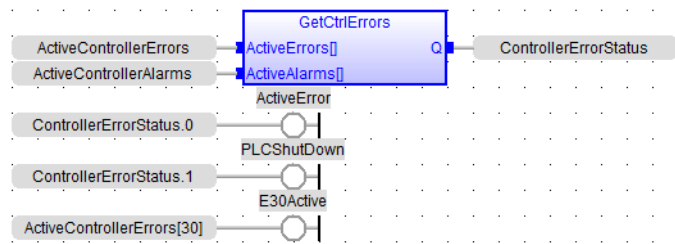

4.2.2.2 FFLD

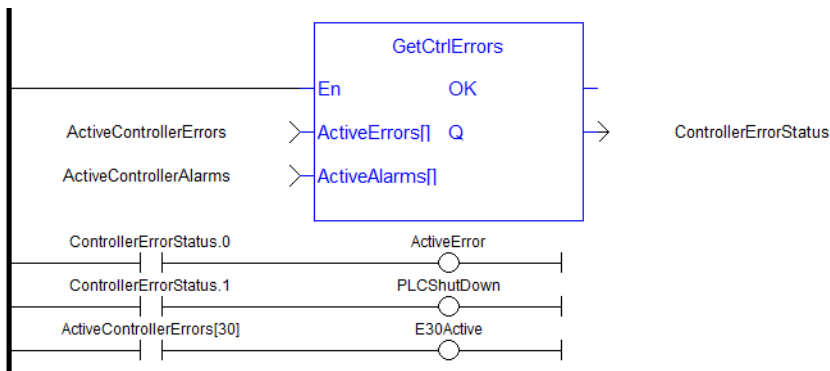

4.2.2.3 ST

```
//Retrieve active controller level alarm and errors.
//Check status output to see if any error or alarm is active and
//if PLC is shutting down
ControllerErrorStatus:= GetCtrlErrors( ActiveControllerErrors,
ActiveControllerAlarms);
ActiveError:= ControllerErrorStatus.0;
PLCShutDown:= ControllerErrorStatus.1;
E30Active:= ActiveControllerErrors[30];
```

4.3 ClearCtrlErrors PLCopen ✓ Pipe Network ✓

Clears the active errors and alarms on the controller. Only clearable errors will be cleared. See Errors for a list of errors and alarms that may be generated.

4.3.1 Arguments

4.3.2 Input

EN	Data Type	Enable the function
-----------	------------------	---------------------

4.3.3 Output

Q	Data Type	BOOL
----------	------------------	------

NOTE

If clearable and non-clearable errors are present and this function is called, the Output Q will be turned to true but the non-clearable errors will remain.

4.3.4 Examples

4.3.4.1 FBD

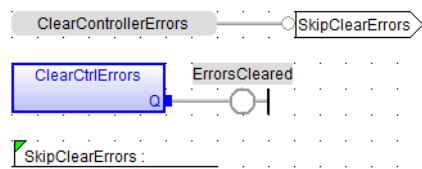

4.3.4.2 FFLD

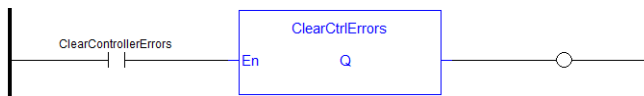

4.3.4.3 ST

```
//Attempt to clear active controller level errors and alarms
(such as E33)
IF ClearControllerErrors THEN
ClearCtrlErrors();
END_IF;
```

4.4 GetCtrlInfo PLCopen ✓ Pipe Network ✓

This function block returns a String containing the value of the control parameter requested.

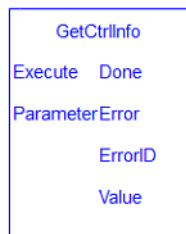

4.4.1 Arguments

4.4.1.1 Input

Execute	Description	Rising edge of enable initiates read of parameter
	Data Type	BOOL
	Range	0, 1
	Unit	n/a
	Default	—
Parameter Number	Description	Parameter number to read
	Data Type	INT
	Range	[1,3]
	Unit	n/a
	Default	<p>1 = PDMM/PCMM serial number 2 = PDMM/PCMM model number 3 = PDMM/PCMM part number0</p> <p>These parameters are also Internal Defines, as shown in the table below.</p> <pre>#define CTRLINFO_SERIAL_NUMBER 1 #define CTRLINFO_MODEL_NUMBER 2 #define CTRLINFO_PART_NUMBER 3</pre>

4.4.1.2 Output

Done	Description	Indication that read completed without error
	Data Type	BOOL
Error	Description	Indication that read completed with error
	Data Type	BOOL
ErrorID	Description	Error value to indicate error condition

Data Type	INT NO Error : 0 Invalid parameter : 1 Error reading data : 2 Not valid on non-PDMM : 3 These parameters are also Internal Defines, as shown in the table below.
	<pre>#define CTRLINFO_ERROR_NO_ERROR 0 #define CTRLINFO_ERROR_INV_PARAMETER 1 #define CTRLINFO_ERROR_CANT_READ_DATA 2 #define CTRLINFO_ERROR_NOT_PDMM 3</pre>
Value	Description String containing data that was read.
	Data Type STRING

4.4.2 Examples

4.4.2.1 Structured Text

```
Inst_GetCtrlInfo( ExecuteRead, 1);

if Inst_GetCtrlInfo.Done then
    serialNumber := Inst_GetCtrlInfo.Value;
end_if;
```

4.4.2.2 Ladder Diagram

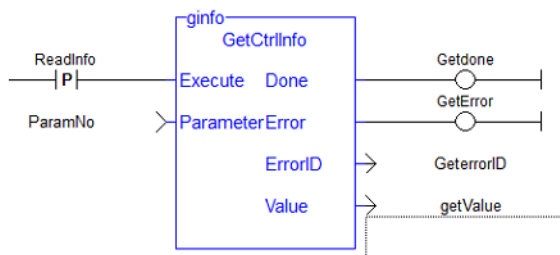

4.5 GetCtrlPerf PLCopen ✓ Pipe Network ✓

4.5.1 Description

This function block returns controller CPU performance statistics.

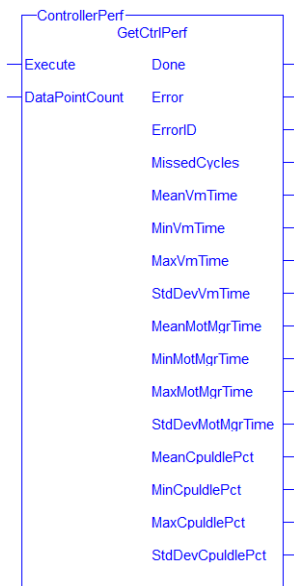

Figure 1-124: GetCtrlPerf

See also:

- Differences Between Functions and Function Blocks
- Calling a function block

4.5.2 Arguments

4.5.2.1 Input

Execute	Description	On the rising edge, request to collect the controller's performance data.
	Data type	BOOL
	Range	0,1
	Unit	n/a
	Default	—
DataPointCount	Description	The number of motion manager cycles over which performance statistics will be gathered.
	Data type	UDINT
	Range	2 - 240,000
	Unit	n/a
	Default	—

4.5.2.2 Output

Done	Description	If True, then the command completed successfully.
	Data type	BOOL

Error	Description	If True, an error has occurred.
	Data type	BOOL
ErrorID	Description	Indicates the error if Error output is set to TRUE. ErrorID = 0 indicates no error, ErrorID = 1 indicates an error
	Data type	INT
MissedCycles	Description	Indicates the number of missing VM cycles.
	Data type	UDINT
MeanVmTime	Description	The mean VM execution time measured in microseconds.
	Data type	LREAL
StdDevVmTime	Description	The standard deviation of the VM execution time measured in microseconds.
	Data type	LREAL
MinVmTime	Description	The minimum VM execution time measured in microseconds.
	Data type	LREAL
MaxVmTime	Description	The maximum VM execution time measured in microseconds.
	Data type	LREAL
MeanMotMgrTime	Description	The mean motion manager execution time measured in microseconds.
	Data type	LREAL
StdDevMotMgrTime	Description	The standard deviation of the motion manager execution time measured in microseconds.
	Data type	LREAL
MinMotMgrTime	Description	The minimum motion manager execution time measured in microseconds.
	Data type	LREAL
MaxMotMgrTime	Description	The maximum motion manager execution time measured in microseconds.
	Data type	LREAL
MeanCpuldlePct	Description	The mean percentage of time the controller CPU is idle.
	Data type	LREAL
StdDevCpuldlePct	Description	The standard deviation of the measurements of the time that the controller CPU is idle.

	Data type	LREAL
MinCpuldlePct	Description	The minimum measurement of the time that the controller CPU is idle.
	Data type	LREAL
MaxCpuldlePct	Description	The maximum measurement of the time that the controller CPU is idle.
	Data type	LREAL

4.5.3 Example

4.5.3.1 FBD

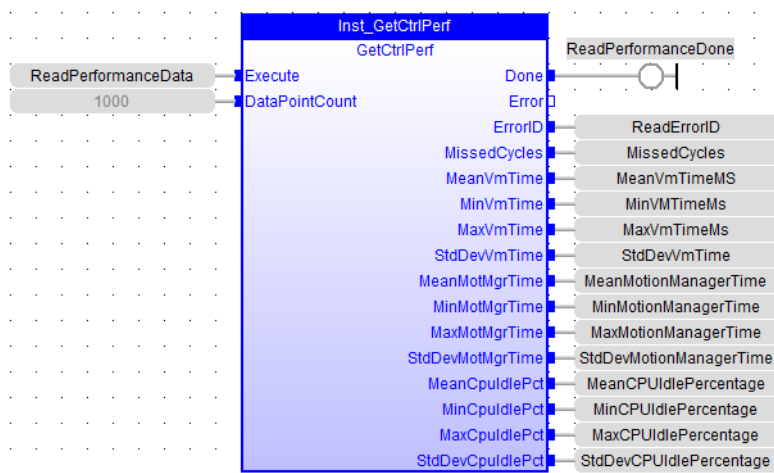

4.5.3.2 FFLD

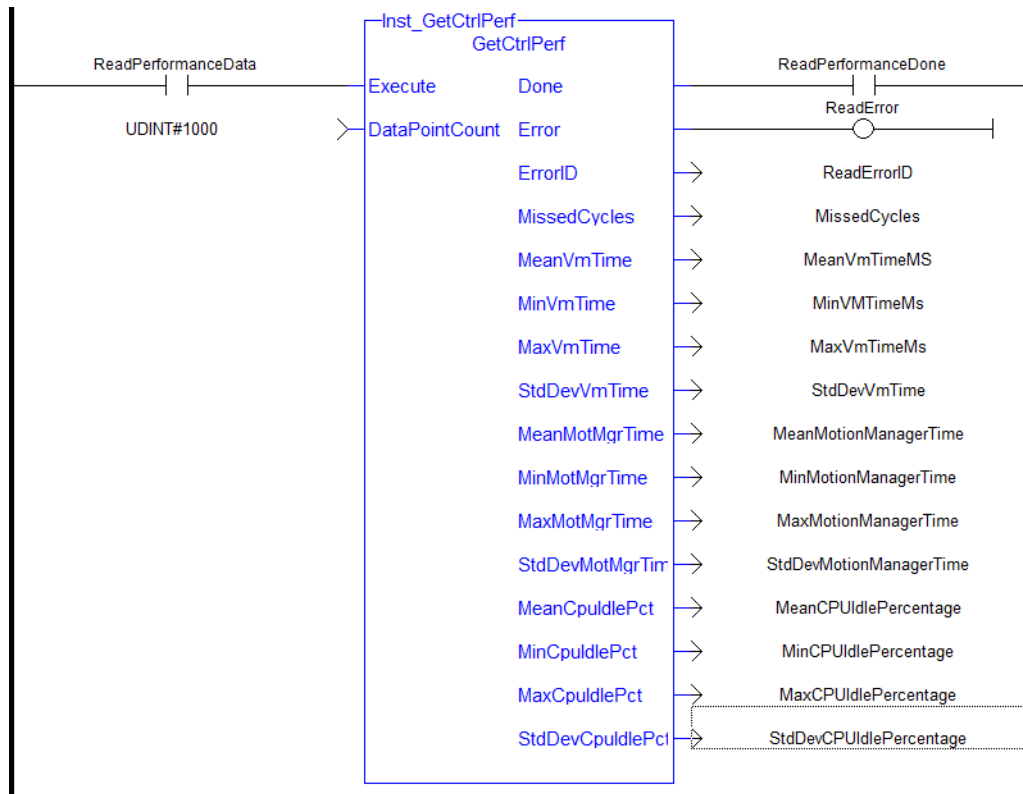

4.5.3.3 Structured Text

```
//Read controller performance data from last 1000 cycles (1
second at T#1ms update rate)
Inst_GetCtrlPerf( ReadPerformanceData, 1000 );

IF Inst_GetCtrlInfo.Done THEN
MissedCycles:= Inst_GetCtrlPerf.MissedCycles;
MaxVmTimeMs:= Inst_GetCtrlPerf.MaxVmTime;
MaxMotionManagerTime:= Inst_GetCtrlPerf.MaxMotMgrTime;
MeanCPUIdlePercentage:= Inst_GetCtrlPerf.MeanCpuIdlePct;
MaxCPUIdlePercentage:= Inst_GetCtrlPerf.MaxCpuIdlePct;
END_IF;
```

5 Kollmorgen UDFBs

5.1 How to create an instance	609
5.2 Working with Kollmorgen UDFBs	610

A Kollmorgen UDFB¹ is a pre-defined function block created by Kollmorgen to simplify certain tasks or demonstrate a particular function. A Kollmorgen UDFB must be instantiated and unlocked before it may be used.

Name	Description
FB_AKDFitRpt	Outputs AKD fault information
FB_AxisPlsPosModulo	
FB_AxisPlsPosNoModulo	
FB_Cylinder	Control a cylinder and the Limit Switches.
FB_ElapseTime	Keeps track of the time that a Boolean input variable is on.
FB_FirstOrderDigitalFilter	Filter an Analog signal.
FB_PWDutyOutput	Converts an input range to a duty cycle percentage
FB_S700FitRpt	Outputs S700 drive fault Information
FB_ScaleInput	Scale DINT to LREAL
FB_ScaleOutput	Scale DINT to LREAL
FB_TemperaturePID (→ p. 630)	{rovides PID temperature control with auto tuning
MCFB_AKDFault (→ p. 732)	Outputs AKD drive fault Information.
MCFB_AKDFaultLookup (→ p. 734)	String message of the corresponding AKD drive fault number
"MCFB_GearedWebTension" (→ p. 719)	Facilitates dancer and tension control in an electronic geared master/slave machine design
MCFB_Jog	Jog an axis in the selected direction at a defined speed
MCFB_StepAbsolute	Performs a static homing function by setting Actual Position to the position of an absolute encoder
MCFB_StepAbsSwitch	Performs a homing function by searching for an absolute positioned external physical switch
MCFB_StepAbsSwitchFastInput	Performs a homing function by searching for an absolute positioned external physical switch
MCFB_StepBlock	Performs homing against a physical object, mechanically blocking the movement
MCFB_StepLimitSwitch	Performs a single-axis home to a limit switch
MCFB_StepLimitSwitchFastInput	Performs a homing function by searching for an external physical switch
MCFB_StepRefPulse	Performs homing by searching for Zero pulse, Marker, or reference pulse in encoder

¹"User Defined Function Block" UDFB can be used as a sub-function block in another program of the application. It is described using FBD, LD, ST or IL language. Input / output parameters of a UDFB (as well as private variables) are declared in the variable editor as local variables of the UDFB

Name	Description
MLFB_HomeFindHomeFastInput	Performs a single-axis home to a limit switch connected to a High Speed Input
MLFB_HomeFindHomeFastInputModulo	Performs a single-axis home to a limit switch connected to a High Speed Input
MLFB_HomeFindHomeInput	Fast Homing to a home switch
MLFB_HomeFindHomeInputThenZeroAngle	Fast Homing to a home switch + Zero angle
MLFB_HomeFindLimitFastInput	Homing to a limit switch
MLFB_HomeFindLimitFastInputModulo	Homing to a limit switch: Modulo mode
MLFB_HomeFindLimitInput	Homing to a limit switch
MLFB_HomeFindLimitInputThenZeroAngle	Homing to a limit switch + Zero angle
MLFB_HomeFindZeroAngle	Homing to a zero-angle reference
MLFB_HomeMoveUntilPosErrExceeded	Homing until the position error is exceeded
MLFB_HomeMoveUntilPosErrExceededThenZeroAngle	Homing until the position error is exceeded + Zero angle
MLFB_HomeUsingCurrentPosition	Homing using the current position
MLFB_Jog	Jog in a selected direction at a defined speed
MLFB_PlsPosFw	Forward position range indicator
MLFB_PlsPosFwBw	Forward/Backward position range indicator
MLFB_PlsTimeFw	Forward/Backward position/time range indicator
"PipeNetwork_FFLED" (→ p. 627)	Used to call the PNCode function block in FFLED POU's
"ProfilesCode_FFLED" (→ p. 628)	Used to call the ProfilesCode function block in FFLED POU's

Table 1-10: List of System Kollmorgen UDFBs

5.1 How to create an instance

- Open your PLC code
- Select the UDFB in the [Library](#) tree
- Drag-and-drop the UDFB in the PLC editor to create the instance of the UDFB

An instance of the UDFB has now been created in **Subprograms**.

NOTE

You cannot create the instance of the UDFB directly from the dictionary or from the PLC Editor.

5.2 Working with Kollmorgen UDFBs

By default all Kollmorgen UDFBs are protected, meaning they may not be modified or renamed. When a Kollmorgen UDFB is dropped into an instance it is not editable. There are two solutions to make it editable:

- Right click on a Kollmorgen UDFB that has been dropped into an instance (in **Subprograms**) and select **Unlock**. This creates an unlocked version of the UDFB with the name "U<sequence number><UDFB name>".

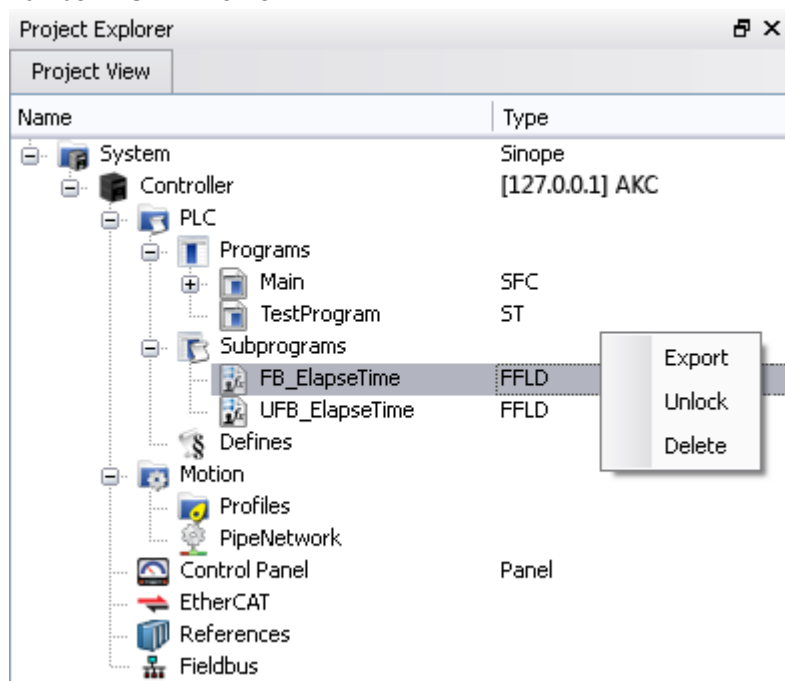

- Instead of dropping a Kollmorgen UDFB into an instance, right click on the UDFB and select **Create unlocked copy in Subprograms**. This creates an unlocked instance of the UDFB with the name "U<sequence number><Kollmorgen UDFB name>".

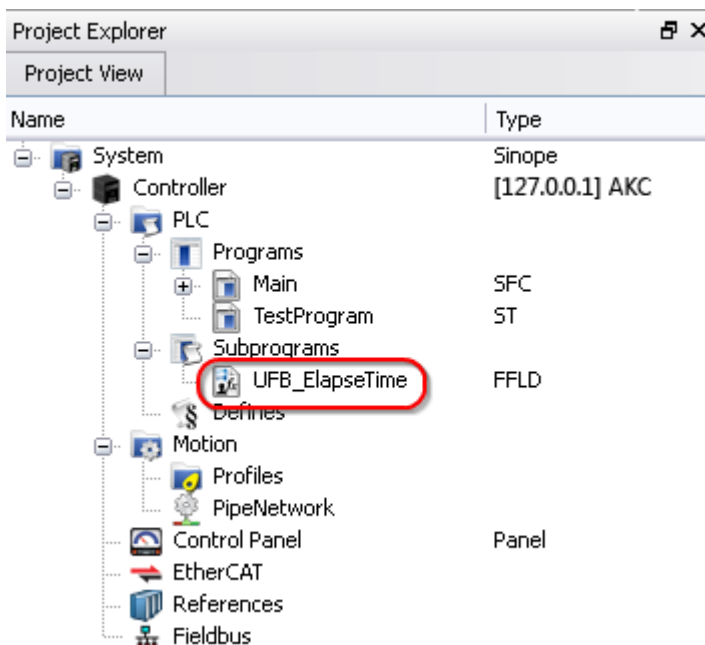
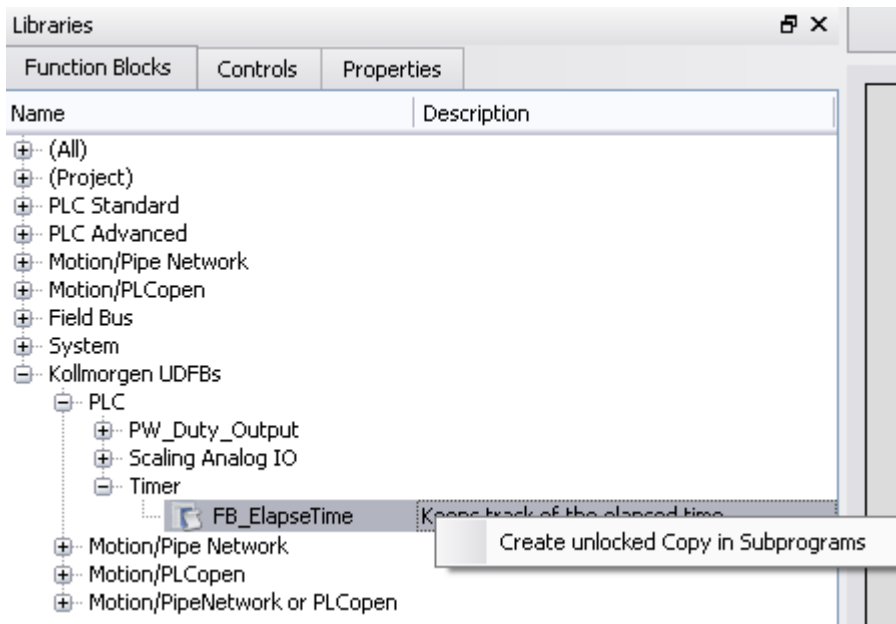

Once a Kollmorgen UDFB has been unlocked it may be renamed and exported by right-clicking on the UDFB. Renamed UDFBs must have unique names. Importing a saved UDFB will increment the UDFB's name.

TIP

In order for a UDFB to modify a structure or array based on the output, you must first define it as an input. The input is automatically set as an INOUT parameter. This is because OUTs are strictly simple types.

5.2.1 FB_FirstOrderDigitalFilter

5.2.1.1 Description

This FB is defined to filter an Analog signal.

In any control system with an analog feedback signal present there is the risk of unwanted noise and jitter that can compromise the signal integrity yielding a less desirable system.

This Kollmorgen UDFB will provide a digital first order filter of an analog feedback signal from an LVDT, tension transducer, potentiometer, encoder, resolver, or some other like device. The amount of filtering is based on a gain value and can provide no filter to full filter conditioning.

The following figure shows the function block I/O

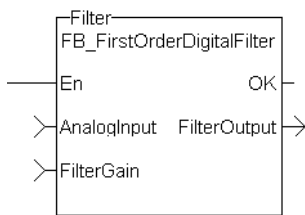

Figure 1-125: CBS First Order Digital Filter

5.2.1.2 Arguments

5.2.1.3.1 Inputs

EN	Description	Enables execution (FFLD only)
	Data type	BOOL
	Range	—
	Unit	n/a
	Default	
AnalogInput	Description	Analog Input from transducer
	Data type	INT
	Range	—
	Unit	n/a
	Default	
FilterGain	Description	Filter Gain
	Data type	REAL
	Range	[1 - 0.05]
	Unit	n/a
	Default	—

5.2.1.4.2 Outputs

OK	Description	Execution Complete
	Data type	BOOL
	Range	[0,1]

Unit	
FilterOutput	Description Filtered analog input value
	Data type REAL
	Range [0,1]
Unit	

5.2.1.5 Usage

When using this UDFB, the Enable (EN) input should always be energized in order to provide the desired filtering.

- The AnalogInput input is the unfiltered “raw” analog feedback signal from an LVDT, tension transducer, potentiometer, or some other like device.
- The FilterGain defines the amount of filtering to be used. The range of the gain is from 1.0 or no filtering to 0.05 or the maximum filtering.
- The FilterOutput is the filtered analog input and is typically used as an input to some other function block or UDFB that has an analog input, for example the MCFB_GearedWebTension UDFB.
- The implementation of the digital first order filter is for PLCopen.
- The equation is defined as: $Input * Gain + Output * (1 - Gain) = Output$
- The steady state filter delay with a gain of 0.8 can be seen in the following table.

FilterGain	FilterInput	FilterOutput
0.8	0	0
	100	80
	100	96
	100	99.2
	100	99.84
	100	99.968
	100	99.9936
	100	99.99872
	100	99.999744
	100	99.9999488
	100	99.99998976
	100	99.99999795
	100	99.99999959
	100	99.99999992
	100	99.99999998
	100	100
	100	100
	100	100
	100	100
	100	100
	100	100
	100	100
	100	100
	100	100
	100	100

Table 1-11: Filter Input Delay Example

The range of the filter gain is between 1.00 and 0.05. From the table, for a filter gain of 0.8 there is a delay of 15 time constants with a time constant defined as the rate the UDFB is scanned or executed in the application. For example if the UDFB was executed every millisecond a gain of 0.8 would provide a filter delay of 15ms. Conversely a gain of 1.00 provides zero filtering and the output signal follows the input signal, and a gain of 0.05 provides the most filtering for 463 ms.

The numbers of filter delays for a steady state analog input at a given gain are shown in the table and graph below.

Gain	Filter Delay Tn
1.00	0
0.95	8
.90	11
.85	13
.80	15
.75	18
.70	20
.65	23
.60	26
.55	30
.50	35
.45	40
.40	47
.35	56
.30	66
.25	83
.20	107
.15	146
.10	226
.05	463

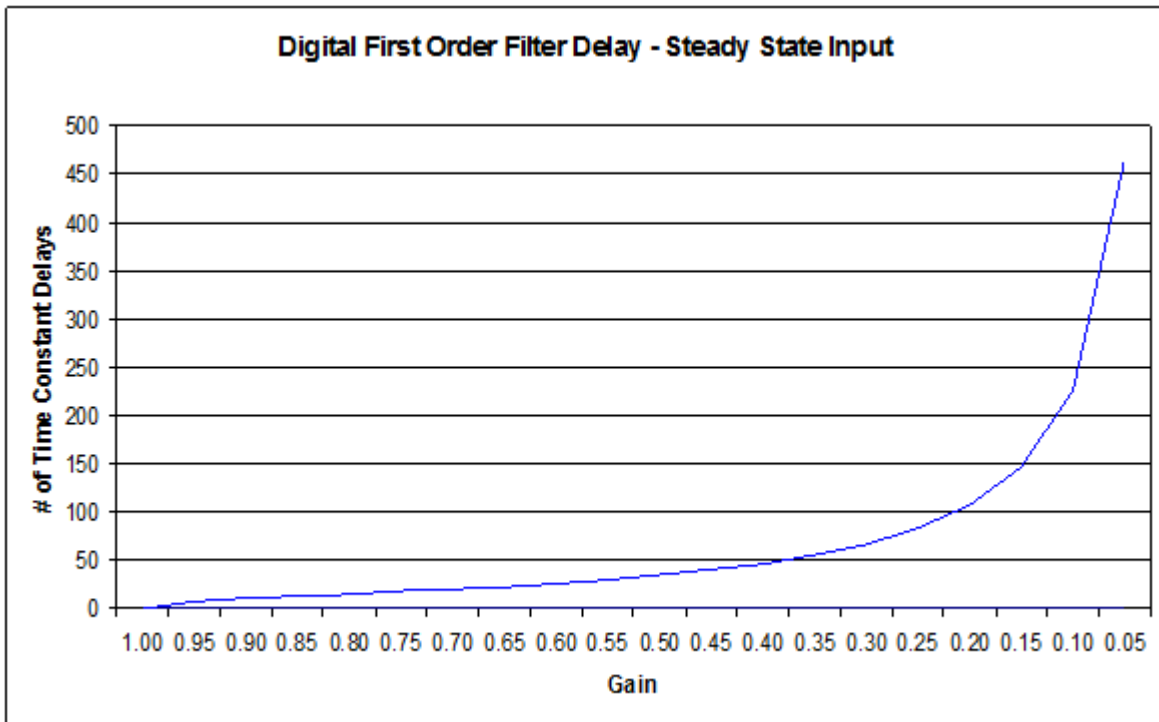

Of course a real world analog input is most always a varying feedback signal. In Table 2.3 this is shown with an initial input of 100, a gain of 0.8, and a random variability of 10%. Filter Input

Filter Input	Filter Current Output	Amount of Input Filtering	Random Filter % Variation
0	0	0	10%
100	80	-20	
97.38903813	93.9112305	-3.477807626	
92.67638093	92.92335084	0.246969915	
94.12988912	93.88858146	-0.241307655	
103.0835564	101.2445614	-1.838994993	
91.16845433	93.18367575	2.015221422	
93.23936976	93.22823096	-0.011138803	
94.90272089	94.56782291	-0.334897986	
103.3070737	101.5592235	-1.747850153	
96.83149418	97.77704005	0.945545867	
96.35024002	96.63560002	0.285360007	
99.82417525	99.1864602	-0.637715045	
105.0792636	103.9007029	-1.178560685	
97.36988208	98.67604626	1.306164172	
107.82502	105.9952253	-1.829794752	
97.7886524	99.42996698	1.641314572	
108.2038024	106.4490353	-1.754767081	
91.58527607	94.55802792	2.972751845	
93.6783421	93.85427926	0.175937164	
102.8695349	101.0664838	-1.803051129	
93.95916817	95.3806313	1.421463121	

Filter Input	Filter Current Output	Amount of Input Filtering	Random Filter % Variation
108.6579707	106.0025028	-2.655467871	
109.3425748	108.6745604	-0.668014397	
103.9066	104.8601921	0.953592077	
92.30112142	94.81293555	2.511814127	
109.4460726	106.5194452	-2.926627416	
94.88799896	97.21428821	2.326289251	
105.4738635	103.8219484	-1.651915057	
102.988167	103.1549233	0.166756284	
92.92925408	94.97438792	2.045133846	
95.58185568	95.46036213	-0.121493552	
109.414248	106.6234708	-2.790777178	
106.5661311	106.577599	0.011467953	
99.85857253	101.2023778	1.343805301	
107.865421	106.5328124	-1.332608643	
92.19683177	95.0640279	2.867196126	
104.8558146	102.8974573	-1.958357346	
104.5140236	104.1907104	-0.323313268	
104.3675014	104.3321432	-0.035358206	
109.2704266	108.2827699	-0.987656683	
101.4962729	102.8535723	1.35729941	
92.19199163	94.32430776	2.132316128	
99.13065312	98.16938405	-0.961269073	
103.5068114	102.4393259	-1.067485466	
109.502983	108.0902516	-1.412731426	
99.05504822	100.8620889	1.80704068	
94.97711299	96.15410817	1.176995182	
107.1063597	104.9159094	-2.190450308	
91.12245188	93.88114339	2.758691504	
108.130314	105.2804799	-2.849834129	
104.2923832	104.4900025	0.197619344	
101.3775072	102.0000062	0.62249907	
100.5303014	100.0399168	-0.490384645	Averages

Table 1-12: Filter Input Lag Example - Random Input

5.2.1.6 Example

5.2.1.7.1 Structured Text

```
//Filter analog input signal with a gain of 0.8 to remove noise
FilteredOutput:= Inst_FB_FirstOrderDigitalFilter(
AnalogInput1Value, 0.8 );
```

5.2.1.8.2 Ladder Diagram

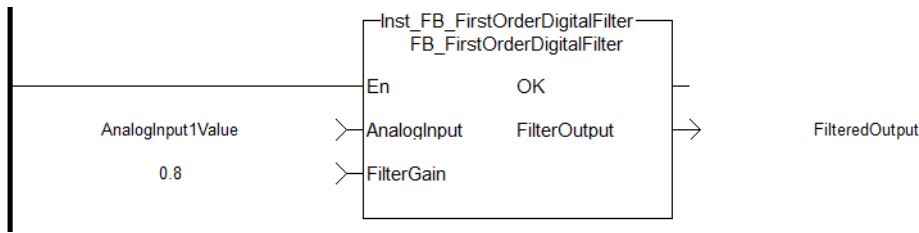

5.2.1.9.3 Function Block Diagram

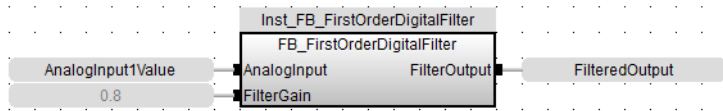

5.2.2 FB_PWDutyOutput

5.2.2.1 Description

The Pulse Width Duty Cycle function block accepts an input value between the minimum and maximum input range and converts this to a duty cycle percentage. The output is then cycled on and off over the period of the duty cycle at the duty cycle percentage. If it is desired to have the output ON time range from 0 to the duty cycle period, the minimum should be set to zero and the maximum to the duty cycle period. If the calculated duty cycle based on the input and range values is less than the minimum ON time (MinTime), the output will not come on. If the calculated duty cycle is between or equal to the range values the output is cycled by the duty cycle. If the calculated duty cycle is greater than the maximum ON time (MaxTime) the output will remain on.

The following figure shows the function block I/O

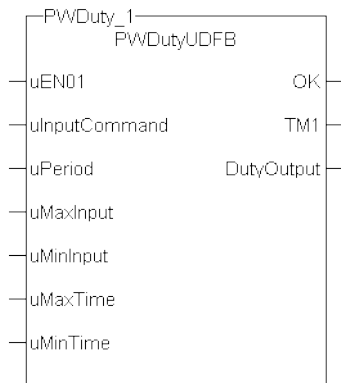

Figure 1-126: Pulse Width Duty Cycle

5.2.2.2 Arguments

5.2.2.3.1 Input

uEN01	Description	Enable for the block
	Data type	BOOL
	Range	[0 , 1]
	Unit	n/a
	Default	—
uInputCommand	Description	Duty Cycle Input (sometimes the output of a PID block).
	Data type	REAL
	Range	[0 , 1]
	Unit	n/a
	Default	—

uPeriod	Description	Period of the duty cycle
	Data type	TIME
	Range	[0 , 1]
	Unit	n/a
	Default	—
uMaxInput	Description	Maximum value for the Input
	Data type	REAL
	Range	[0 , 1]
	Unit	n/a
	Default	—
uMinInput	Description	Minimum value for the Input
	Data type	REAL
	Range	[0 , 1]
	Unit	n/a
	Default	—
uMaxTime	Description	Maximum on time for the Output
	Data type	TIME
	Range	[0 , 1]
	Unit	n/a
	Default	—
uMinTime	Description	Minimum on time for the Output
	Data type	TIME
	Range	[0 , 1]
	Unit	n/a
	Default	—

5.2.2.4.2 Output

OK	Description	Function block is OK.
	Data type	BOOL
	Unit	n/a
TM1	Description	Duty cycle on time
	Data type	TIME
	Unit	n/a
DutyOutput	Description	Indicates if output is on or off
	Data type	BOOL
	Unit	n/a

5.2.2.5 Usage

Flash a warning light for operators.

5.2.2.6 Related Functions

[Timers](#)

5.2.2.7 Example

5.2.2.8.1 Structured Text

```

Inst_FB_PWDutyOutput(PWDuty_3_Switch, PWDuty_In3, PWDuty_3_Period, PWDuty_3_MaxInput,
PWDuty_3_MinInput, PWDuty_3_MaxTime, PWDuty_3_MinTime);
PWDuty_3_OK:=Inst_FB_PWDutyOutput.OK;
PWDuty_3_Time:=Inst_FB_PWDutyOutput.TM1;
PWDuty_3_Output:=Inst_FB_PWDutyOutput.DutyOutput;
    
```

5.2.2.9.2 Ladder Diagram

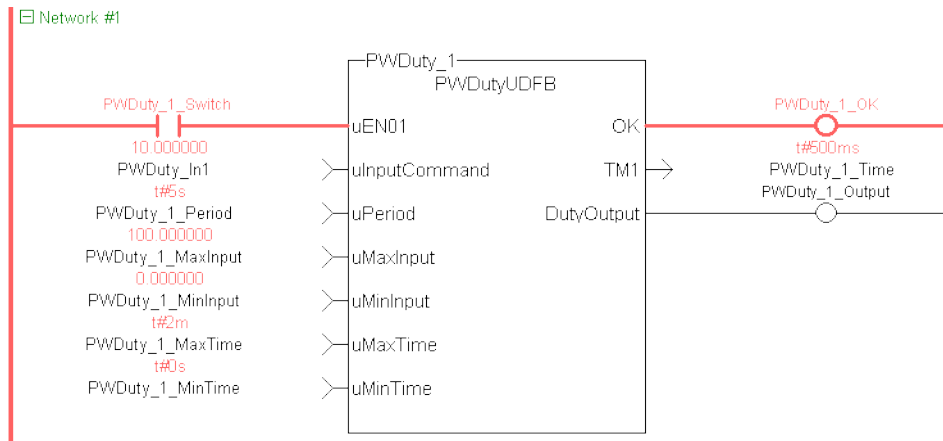

5.2.2.10.3 Function Block Diagram

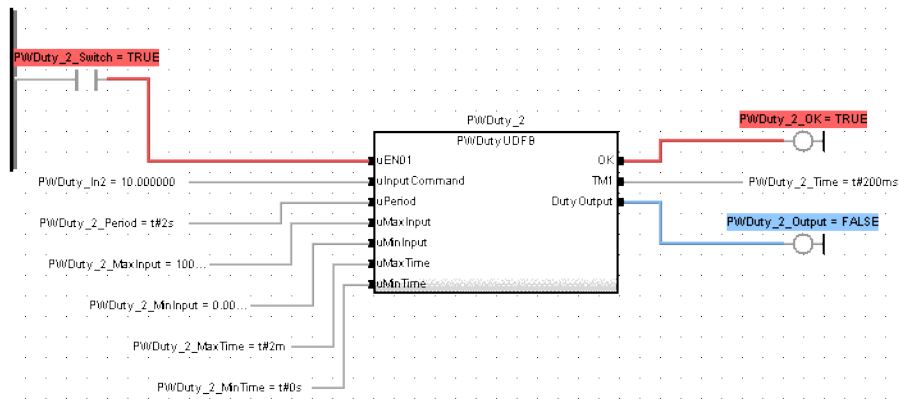

5.2.2.11 FB_ScaleInput

5.2.2.12.1 Description

Scale DINT to LREAL.

Converts un-scaled DINT values from Analog Inputs into user units of type LREAL. The input signal is converted based on a linear mapping automatically calculated by two points entered. InputMin is mapped to OutputMin, InputMax is mapped to OutputMax, and all values in between are scaled automatically. If an input value is not between the selected Min/Max, the Boolean output OutsideRange turns TRUE, and the OutputSignal is set to the corresponding OutputMin or OutputMax value.

The following figure shows the function block I/O:

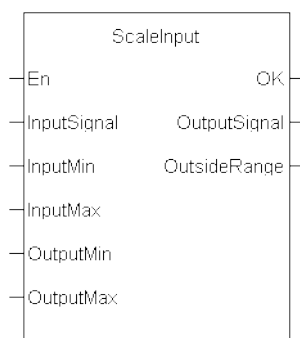

Figure 1-127: Scale Input

5.2.2.13.2 Arguments

5.2.2.14.3.1 Input

InputSignal	Description	Un-scaled input signal
	Data type	DINT
	Range	[0 , 4]
	Unit	n/a
	Default	—
InputMin	Description	Minimum value of accepted input signal range
	Data type	DINT
	Range	[0 , 4]
	Unit	n/a
	Default	—
InputMax	Description	Maximum value of accepted input signal range
	Data type	DINT
	Range	[0 , 4]
	Unit	n/a
	Default	—
OutputMin	Description	Output value mapped to the InputMin
	Data type	LREAL
	Range	[0 , 4]
	Unit	n/a
	Default	—

OutputMax	Description	Output value mapped to the InputMax
	Data type	LREAL
	Range	[0 , 4]
	Unit	n/a
	Default	—

5.2.2.15.4.2 Output

OutputSignal	Description	Scaled value of the Input Signal with type converted to LREAL. Stays within specified Min/Max output values
	Data type	LREAL
	Unit	n/a
OutsideRange	Description	True if InputSignal is outside range setup by min/max values, otherwise FALSE
	Data type	BOOL
	Unit	n/a

5.2.2.16.5 Usage

Scale an analog signal from a drive.

5.2.2.17.6 Related Functions

[UDFB ScaleOutput](#)

5.2.2.18.7 Example

5.2.2.19.8.1 Structured Text

```
//Scale an integer based analog input signal into floating point
LREAL variable
ScaleInput_1( Analog_In, Analog_In_Min, Analog_In_Max, LREAL_
Out_Min, LREAL_Out_Max );
LREAL_OutputSignal:= ScaleInput_1.OutputSignal;
Analog_Range_Err:= ScaleInput_1.OutsideRange;
```

5.2.2.20.9.2 Ladder Diagram

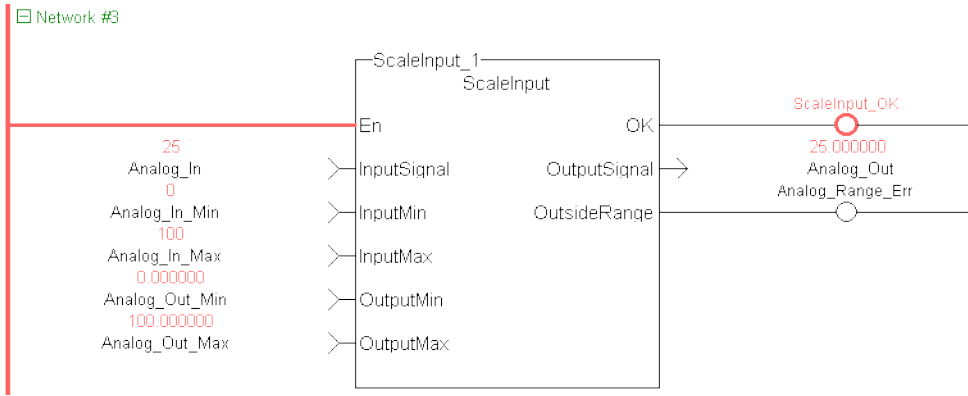

5.2.2.21.10.3 Function Block Diagram

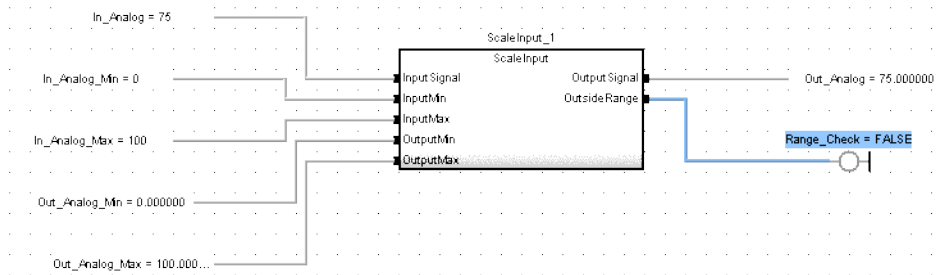

5.2.2.22 FB_ScaleOutput

5.2.2.23.1 Description

Scale LREAL to DINT .

This Kollmorgen UDFB converts un-scaled LREAL values from a PLC Program into units of type DINT that can be mapped to an analog output. The input signal is converted based on a linear mapping automatically calculated by two points entered. InputMin is mapped to OutputMin, InputMax is mapped to OutputMax, and all values in between are scaled automatically. If an input value is not between the selected Min/Max, the Boolean output OutsideRange turns TRUE, and the OutputSignal is set to the corresponding OutputMin or OutputMax value.

The following figure shows the function block I/O:

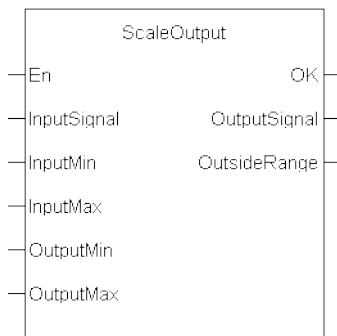

Figure 1-128: Scale Output

5.2.2.24.2 Arguments

5.2.2.25.3.1 Input

InputSignal	Description	Un-scaled input signal
	Data type	LREAL
	Range	[0 , 4]
	Unit	n/a
	Default	—
InputMin	Description	Minimum value of accepted input signal range
	Data type	LREAL
	Range	[0 , 4]
	Unit	n/a
	Default	—
InputMax	Description	Maximum value of accepted input signal range
	Data type	LREAL
	Range	[0 , 4]
	Unit	n/a
	Default	—
OutputMin	Description	Output value mapped to the InputMin
	Data type	DINT
	Range	[0 , 4]
	Unit	n/a
	Default	—
OutputMax	Description	Output value mapped to the InputMax
	Data type	DINT
	Range	[0 , 4]
	Unit	n/a
	Default	—

5.2.2.26.4.2 Output

OutputSignal	Description	Scaled value of the Input Signal with type converted to DINT. Stays within specified Min/Max output values
	Data type	DINT
	Unit	n/a
OutsideRange	Description	True if InputSignal is outside range setup by min/max values, otherwise FALSE
	Data type	BOOL
	Unit	n/a

5.2.2.27.5 Usage

Scale an analog signal to a drive.

5.2.2.28.6 Related Functions

[UDFB ScaleInput](#)

5.2.2.29.7 Example

5.2.2.30.8.1 Structured Text

```

Inst_ScaleOutput1( ScaleOutput_In2, ScaleOutput_In2_
Min,ScaleOutput_In2_Max, ScaledOutput_2_Min, ScaledOutput_2_Max
);
ScaledOutput_2:=Inst_ScaleOutput1.OutputSignal;
ScaledOutput_2_Err:=Inst_ScaleOutput1.OutsideRange;
    
```

5.2.2.31.9.2 Ladder Diagram

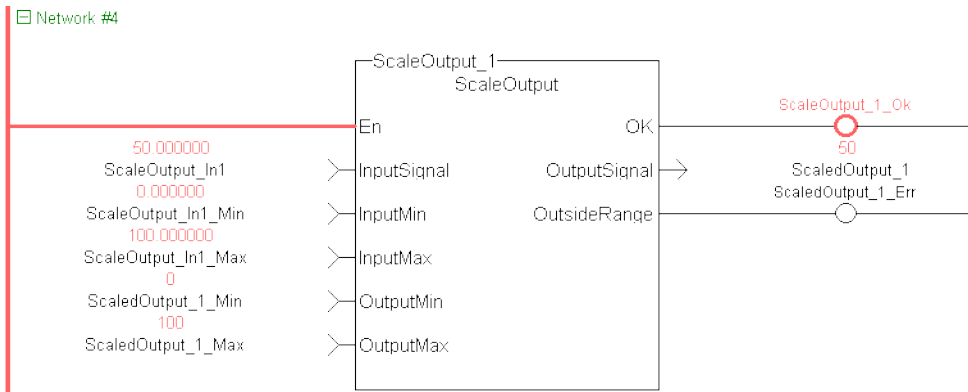

5.2.2.32.10.3 Function Block Diagram

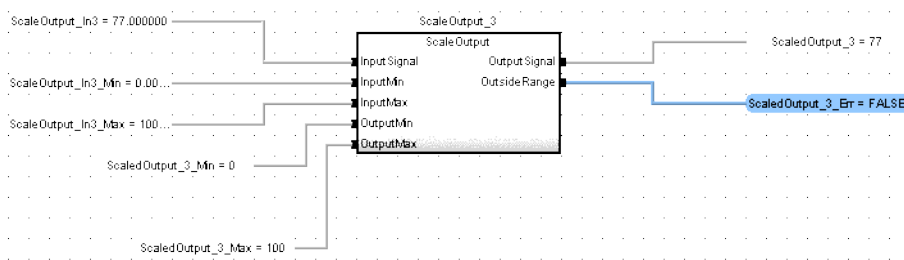

5.2.3 FB_ElapseTime

5.2.3.1 Description

This Kollmorgen UDFB keeps track of the time (oTotalOnTime) that a Boolean input variable is on. Once the iEN00 enable input is high the Kollmorgen UDFB will keep track of the total time iVariable is on. If iVariable changes to an off state while iEN00 is on, the oTotalOnTime will stop. oTotalOnTime will start to add again once iVariable changes state to high. As long as the iEN00 input is on, iVariable can change states many times. The oTotalOnTime will reflect only the total time that iVariable has been on. While iVariable is still TRUE, oInProcess will also be TRUE and oDone will be FALSE. Once iVariable is FALSE, oInProcess will be FALSE and oDone will be TRUE.

If the iEN00 input goes off, oTotalOnTime stops counting and the Kollmorgen UDFB execution stops. To restart the timer turn iEN00 on again. This will reset oTotalOnTime to zero and counting will begin once iVariable is also on.

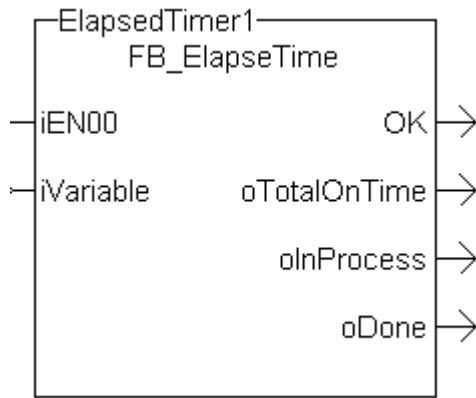

Figure 1-129: FB_ElapseTime

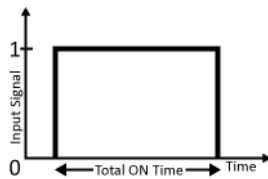

Figure 1-130: MFB_ElapseTime – Time Diagram

5.2.3.2 Arguments

5.2.3.3.1 Input

iEN00	Description	Enable for the block
	Data type	Boolean
	Range	FALSE or TRUE
	Unit	n/a
	Default	FALSE
iVariable	Description	The variable to be tracked
	Data type	Boolean
	Range	FALSE or TRUE
	Unit	n/a
	Default	FALSE

5.2.3.4.2 Output

OK	Description	Function Block OK. This output follows the state on iEN00 input
	Data type	Boolean
	Range	FALSE or TRUE
	Unit	n/a

oTotalOnTime	Description	The amount of time the iVariable is turned on.
	Data type	Time
	Range	0ms – 24h
	Unit	ms
oTotalOnTime	Description	The amount of time the iVariable is turned on.
	Data type	Time
	Range	0ms – 24h
	Unit	ms
oInProcess	Description	The state of block’s execution whether or not it is still keeping track of time
	Data type	Boolean
	Range	FALSE or TRUE
	Unit	n/a
oDone	Description	The state of block’s execution whether or not it is completed
	Data type	Boolean
	Range	FALSE or TRUE
	Unit	n/a

5.2.3.5 Usage

- Enable the block by setting iEN00 to TRUE
- Either manually set iVariable to TRUE or have the application set this variable to TRUE
- Once oDone returns TRUE, read the oTotalOnTime to find out how long iVariable was on.

5.2.3.6 Example

5.2.3.7.1 Structured text

```
//Keep track of total time that IncrementTimer variable is
TRUE while EnableTimer variable is true
//Timer will be reset when EnableTimer variable is false
Inst_FB_ElapseTime( EnableTimer, IncrementTimer );
TotalOnTime := Inst_FB_ElapseTime.oTotalOnTime;
```

5.2.3.8.2 Function Block Diagram

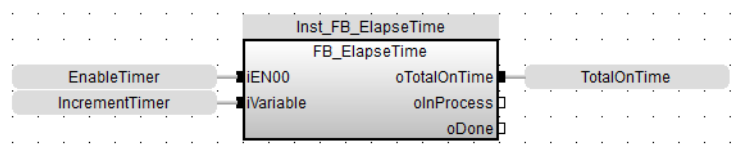

5.2.3.9.3 Free Form Ladder Diagram

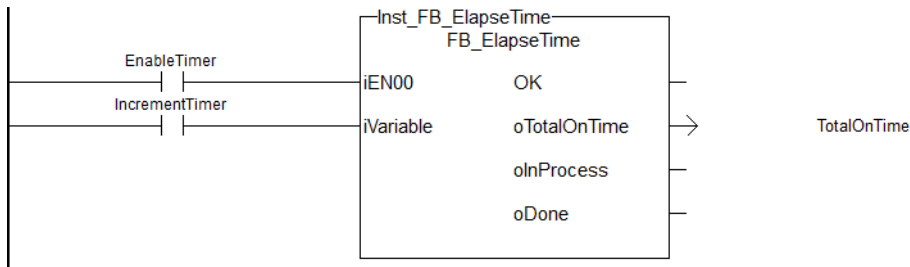

5.2.4 PipeNetwork_FFLD Pipe Network ✓

5.2.4.1 Description

This function is used to call the PNCode Function Block in FFLD POU's. It starts and initializes the Pipe Network, based on the command specified by `cmdID`. Internally this function calls the Function Block PNCode.

This is a special function that should only be used in Pipe Network applications that contain FFLD POU's that call PNCode. Calling this function instead of PNCode in FFLD POU's will eliminate the following compile error that occurs after modifying the Pipe Network using the Pipe Network editor.

```
Controller:PLC:Main: NW1(1,14): PNCode: Invalid block height
```

NOTE

The compile error is generated because the number of outputs on PNCode can vary. This occurs after modifying the original Pipe Network using the Pipe Network editor. The new PNCode Function Block is not automatically updated in any FFLD POU, reflecting the new outputs. You need to manually update each PNCode Function Block call in any FFLD POU to correct this problem.

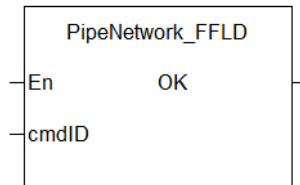

Figure 1-131: PipeNetwork_FFLD

See also: Design Motion with Pipe Network, Initialize and Start up a Pipe Network, PLCopen 2-Axes Template with FFLD

5.2.4.2 Arguments

5.2.4.3.1 Inputs

En	Description	Request to initialize the Pipe Network
	Data type	BOOL
	Range	0, 1
	Unit	n/a
	Default	—

cmdID	Description	Commands used to start and initialize the Pipe Network <ul style="list-style-type: none"> • MLPN_CREATE_OBJECTS – Create Pipe Network • MLPN_POWER_ON – Power on all axes • MLPN_POWER_OFF – Power off all axes • MLPN_ACTIVATE – Activate the pipes • MLPN_CONNECT – Connect the axes to the pipes • MLPN_DEACTIVATE – Deactivate the pipes
	Data type	DINT
	Range	n/a
	Unit	n/a
	Default	—

5.2.4.4.2 Outputs

OK	Description	Returns TRUE when the function has completed
	Data type	BOOL
	Unit	n/a

5.2.4.5 Usage

- This is a special function that should only be used in Pipe Network applications that contain FFLD POU's that call PNCode.
- To use this Function, PipeNetwork must be declared as a global variable in the dictionary.

TIP

The Pipe Network FFLD Application Template is a good example of how to use this Function. See Pipe Network 2-Axes Template with FFLD only.

5.2.4.6 Example

5.2.4.7.1 FFLD

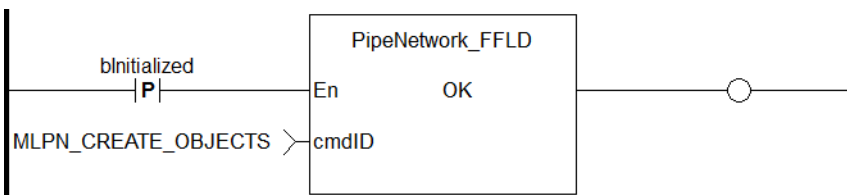

5.2.5 ProfilesCode_FFLD

5.2.5.1 Description

This function is used to call the Profiles Code Function Block in FFLD POU's. Internally this function calls the Function Block ProfilesCode.

This is a special function which should only be used in applications that contain FFLD POU's that call ProfilesCode. Calling this function instead of ProfilesCode in FFLD POU's will eliminate the following compile error that occurs after adding a new Profile to the project tree.

```
Controller:PLC:Main:NW1(1,14):ProfilesCode:Invalid block height
```

The compile error is generated because the number of outputs on ProfilesCode can vary. This occurs after adding a new profile to the project tree. The ProfilesCode Function Block is not automatically updated in any FFLD POU, reflecting the new outputs. You needed to manually update each ProfilesCode Function Block call in any FFLD POU to correct this problem. If you use this new Function instead, you no longer need to manually update each ProfilesCode Function Block in FFLD.

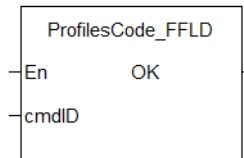

Figure 1-132: ProfilesCode_FFLD

5.2.5.2 Arguments

5.2.5.3.1 Inputs

En	Description	Request to initialize the Pipe Network
	Data type	BOOL
	Range	0,1
	Unit	n/a
	Default	—
cmdID	Description	Commands used to start and initialize the Pipe Network <ul style="list-style-type: none"> • MLPR_CREATE_PROFILES - Creation and initialization of profiles.
	Data type	DINT
	Range	n/a
	Unit	n/a
	Default	—

5.2.5.4.2 Outputs

OK	Description	Returns TRUE when the function has completed
	Data type	BOOL
	Unit	n/a

5.2.5.5 Usage

- This is a special function that should only be used in applications that contain FFLD POU's that call ProfilesCode.
- To use this function, Profiles must be declared as a global variable in the dictionary.

TIP

The Pipe Network and PLCopen 2 Axis FFLD Application Templates are two examples of how to use this function. See Pipe Network 2-Axes Template with FFLD only and PLCopen 2-Axes Template with FFLD.

5.2.5.6 Example

5.2.5.7.1 FFLD

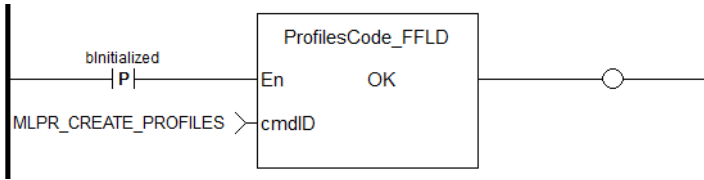

5.2.6 FB_TemperaturePID

5.2.6.1 Description

This function block provides PID temperature control with auto tuning.

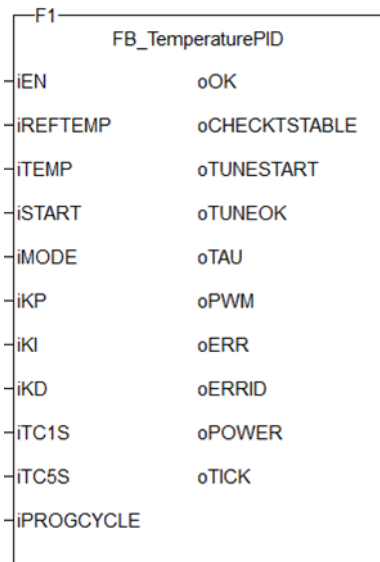

Figure 1-133: The TemperaturePID user-defined function block

5.2.6.2 Arguments

5.2.6.3.1 Inputs

iEN	BOOL	Enable function
iREFTEMP	LREAL	Reference temperature [°C]
iTEMP	LREAL	Actual temperature [°C]
iSTART	BOOL	Start PID or auto tuning
iMODE	BOOL	FALSE-automatic, TRUE-tuning
iKP	LREAL	PID Proportional Gain
iKI	LREAL	PID Integral Gain

iKD	LREAL	PID Derivative Gain
iTC1S	BOOL	Sampling Time is 1s
iTC5S	BOOL	Sampling Time is 5s
iPROGCYCLE	LREAL	Execution time of the function [ms]

5.2.6.4.2 Outputs

oOK	BOOL	Function enabled
oCHECKSTABLE	BOOL	TRUE when checking if ambient temperature is stable
oTUNESTART	BOOL	Tuning is started
oTUNEOK	BOOL	Tuning is completed
oTAU	LREAL	System Time Constant[s]
oPWM	BOOL	PWM command for heater
oERR	BOOL	Function error
oERRID	INT	Function ID error (in case of oERR=TRUE)
oPOWER	LREAL	% of power requested from heater (100%=full power)
oTICK	BOOL	Pulse every sampling time

5.2.6.5 Usage

5.2.6.6.1 Tuning Process

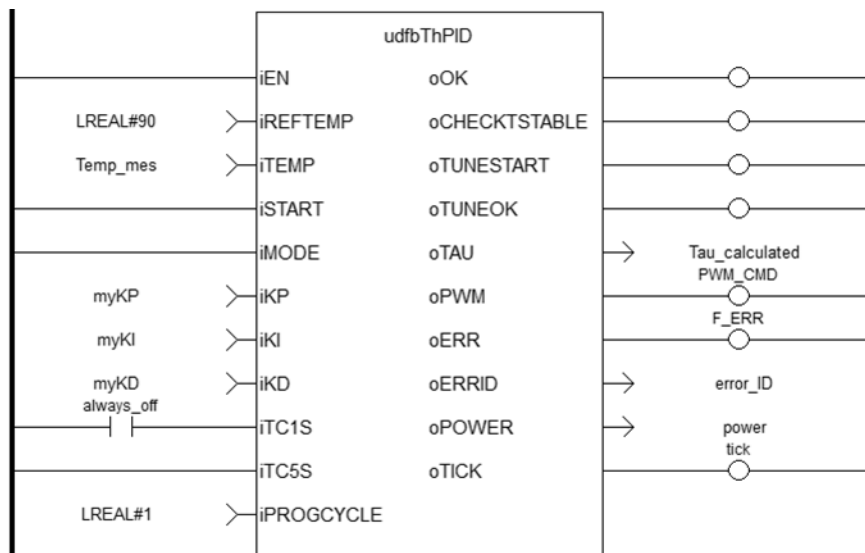

Tuning consists of three steps.

1. Check if the ambient temperature is stable: the measured $\text{delta_temp} = T_{\text{max}} - T_{\text{min}}$ must be lower than $0.1 \cdot T_{\text{max}}$.
This step takes 10 cycles ($10 \cdot iTC5s$ or $10 \cdot iTC1s$).
The tuning fails ($oERR = \text{TRUE}$, $oERRID = 1$) if the ambient temperature is greater than $0.1 \cdot T_{\text{max}}$,

- otherwise $T_{amb} = (T_{max} + T_{min}) / 2$.
2. Start tuning Phase1: output **oPWM** is kept TRUE until the final measured temperature **iTEMP** gets over $iREFTEMP / 2$. After that **oPWM** is kept LOW.
 3. Start tuning Phase2: with **oPWM** kept LOW the temperature gets down until the final value is lower than $[(iREFTEMP / 2 - T_{amb}) * 0.368 + T_{amb}]$.

After, PID gains are calculated as:

```

Kp=10
Ki=0.14
delta_time = time to complete Phase2

Kd=SQRT(delta_time)*7
    
```

The tuning is completed.

TIP

oTAU may be useful for setting the proper sampling time (1s or 5s).

5.2.6.7.2 Start PID Controller

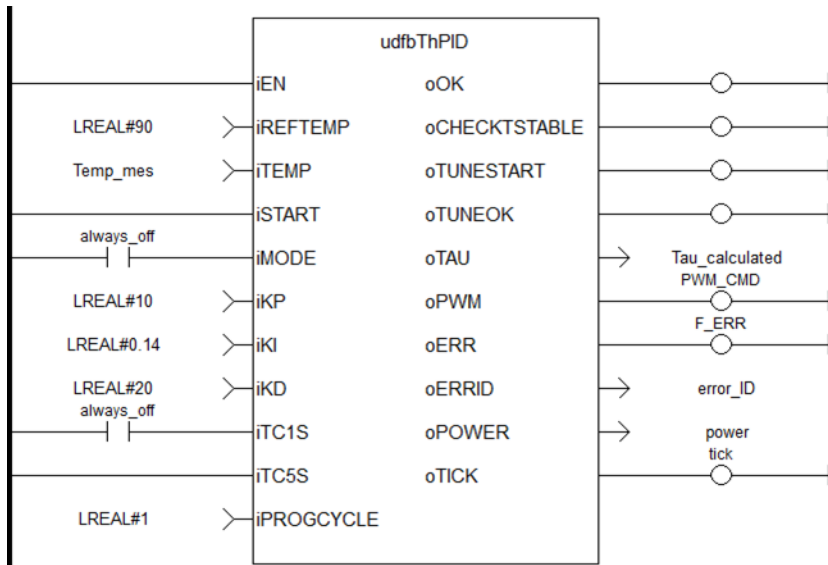

Upon starting the PID controller, the output **oPWM** is modulated 5 times within the sampling time (blue line is **oTICK**, green line is **oPWM**) and each pulse length depends on output **oPOWER** (100%=full length).

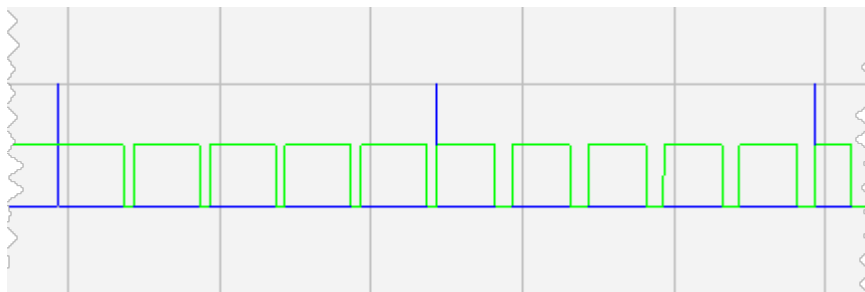

5.2.6.8 Example

5.2.6.9.1 ST

```
//Run PID function with determined proportional, integral, and
derivative gains
//send PWM output to command heater
udfbThPID( TRUE, 90, Temp_mes, TRUE, FALSE, KP, KI, KD, FALSE,
TRUE, 1);
Tau_Calculated := udfbThPID.oTAU;
PWM_CMD := udfbThPID.oPWM;
Power := udfbThPID.oPOWER;
Tick := udfbThPID.oTICK;
```

5.2.6.10.2 FBD

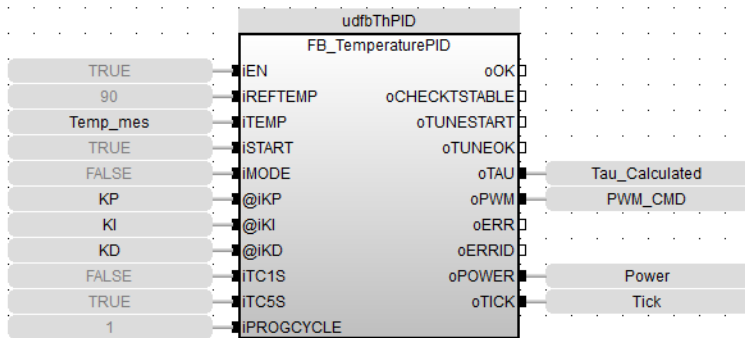

5.2.6.11.3 FFLD

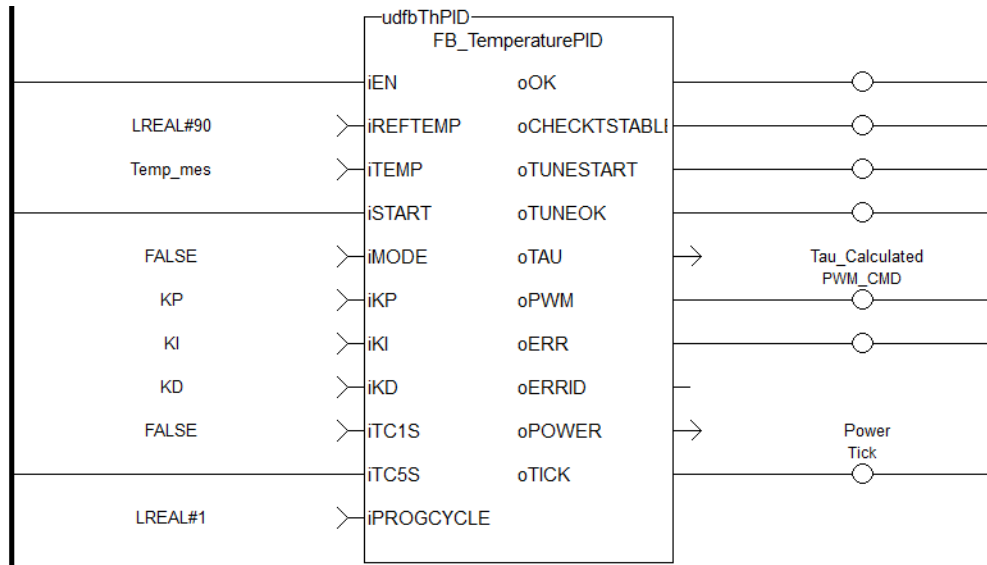

5.2.6.12 MLFB_HomeFindHomeInput Pipe Network ✓

5.2.6.13.1 Description

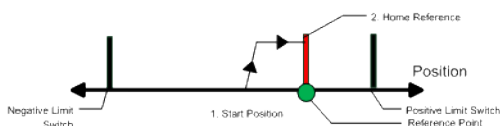

The motor starts to move according to the direction setting. The home position has been found as soon as the home-switch becomes active during a motion in direction of the direction setting. The command position of the drive will immediately be set to the position value and the motor ramps down to velocity 0. The hardware

limit switches are monitored during the homing procedure. The drive behaves as follows in case that a hardware limit switch is active before the home-switch has been activated: The motor changes the direction until the home switch is crossed. The motor ramps down to zero velocity and reverses direction again after crossing the home-switch. The home-switch will now be activated according to the direction setting and the home-position has been found. The command position of the drive will immediately be set to the position value and the motor ramps down to zero velocity.

5.2.6.14.2 Arguments

5.2.6.15.3.1 Input

ibExecute	Description Data type	Start homing, edge-triggered BOOL
iAxisID	Description Data type	ID of Axis block of Pipe Network DINT
iPosition	Description Data type	Reference position LREAL
ibDirection	Description Data type	0=positive, 1=negative BOOL
iVelocity	Description Data type	Reference speed LREAL
iAcceleration	Description Data type	Reference acceleration LREAL
iDeceleration	Description Data type	Reference deceleration LREAL
ibHomeInput	Description Data type	Home input, high-active BOOL
ibPosLimitSwitch	Description Data type	Positive limit switch, high-active BOOL
ibNegLimitSwitch	Description Data type	Negative limit switch, high-active BOOL
iTimeout	Description Data type	Time monitoring (T#0ms: off) TIME

5.2.6.16.4.2 Output

obDone	Description Data type	Done bit BOOL
obActive	Description Data type	Active bit BOOL
obError	Description Data type	Error bit BOOL

oErrorID	Description	Error identifier, see list here	
		ErrorID	Description
		1	Axis in error
		2	Axis not enabled
		3	Timeout expired
		4	SDO read/write error
		5	Input parameter out of range
	Data type	DINT	

5.2.6.17.5 Example

5.2.6.18.6.1 ST

```

//Call homing function on Axis1 with preset velocity, accel, and
//decel values
//Start in negative direction, change if limit switch seen
//before home switch
//after seeing home switch, set axis position to zero
Inst_MLFB_HomeFindHomeInput( StartHomeRoutine,
    PipeNetwork.AXIS1,
    0,
    TRUE,
    100,
    1000,
    1000,
    HomeDigitalInput,
    PositiveLimitSwitch,
    NegativeLimitSwitch,
    T#30s );

HomeDone := Inst_MLFB_HomeFindHomeInput.obDone;
    
```

5.2.6.19.7.2 Function Block Diagram

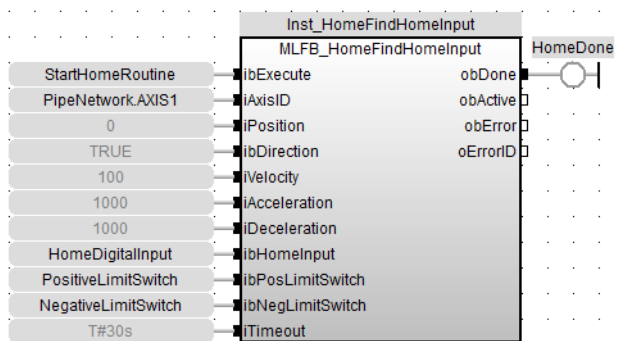

5.2.6.20.8.3 FFLD

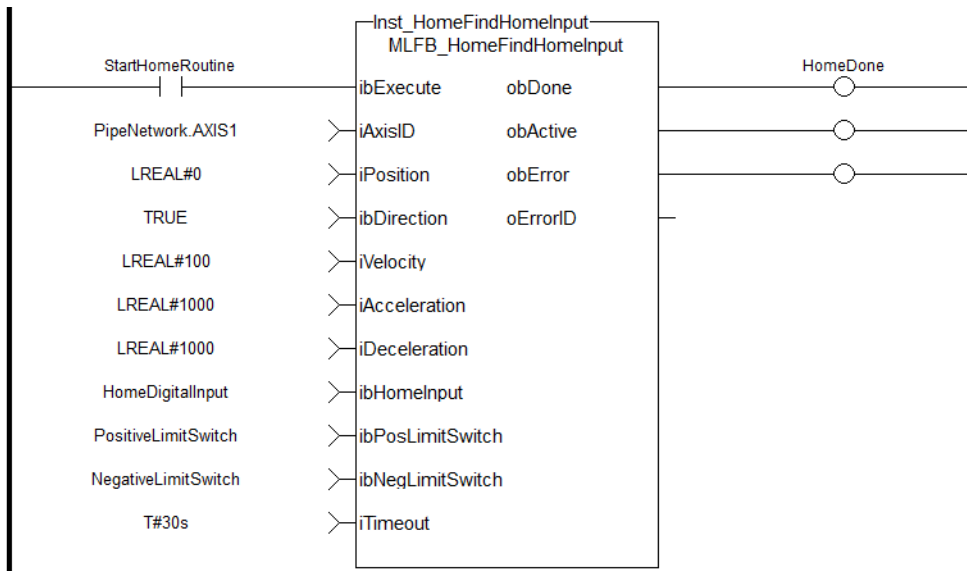

5.2.6.21 MLFB_HomeFindHomeInputThenZeroAngle Pipe Network ✓

5.2.6.22.1 Description

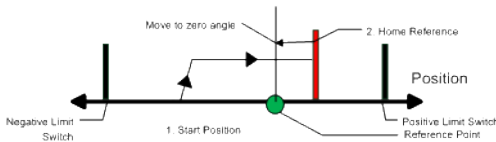

Similar to the Find Home Limit method, the find input home then find zero angle. Mode follows the same steps, but upon completion of the move, it continues to move to find the zero angle reference of the motor.

5.2.6.23.2 Arguments

5.2.6.24.3.1 Input

ibExecute	Description Data type	Start homing, edge-triggered BOOL
iAxisID	Description Data type	ID of Axis block of Pipe Network DINT
iPosition	Description Data type	Reference position LREAL
ibDirection	Description Data type	0=positive, 1=negative BOOL
iVelocity	Description Data type	Reference speed LREAL
iAcceleration	Description Data type	Reference acceleration LREAL
iDeceleration	Description Data type	Reference deceleration LREAL
ibHomeInput	Description Data type	Home input, high-active BOOL
ibPosLimitSwitch	Description Data type	Positive limit switch, high-active BOOL

ibNegLimitSwitch	Description Data type	Negative limit switch, high-active BOOL
iTimeout	Description Data type	Time monitoring (T#0ms: off) TIME

5.2.6.25.4.2 Output

obDone	Description Data type	Done bit BOOL
obActive	Description Data type	Active bit BOOL
obError	Description Data type	Error bit BOOL

Error identifier, see list here

oErrorID	Description	ErrorID Description	
		1	Axis in error
		2	Axis not enabled
		3	Timeout expired
		4	SDO read/write error
		5	Input parameter out of range
	Data type	DINT	

5.2.6.26.5 Example

5.2.6.27.6.1 ST

```
//Call homing function on Axis1 with preset velocity, accel, and
//decel values
//Start in negative direction, change if limit switch seen
//before home switch
//after seeing home switch and moving to zero angle, set axis
//position to zero
Inst_MLFB_HomeFindHomeInputThenZeroAngle( StartHomeRoutine,
    PipeNetwork.AXIS1,
    0,
    TRUE,
    100,
    1000,
    1000,
    HomeDigitalInput,
    PositiveLimitSwitch,
    NegativeLimitSwitch,
    T#30s );

HomeDone := Inst_MLFB_HomeFindHomeInputThenZeroAngle.obDone;
```

5.2.6.28.7.2 Function Block Diagram

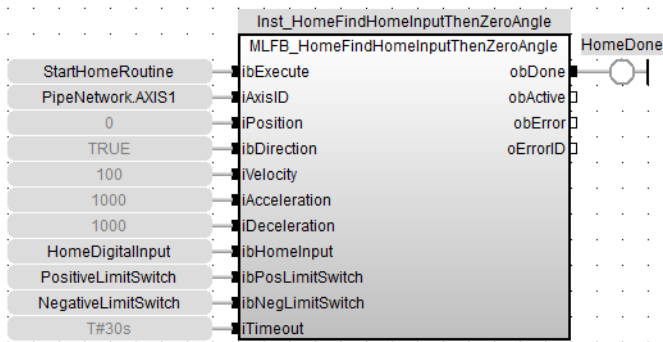

5.2.6.29.8.3 FFLD

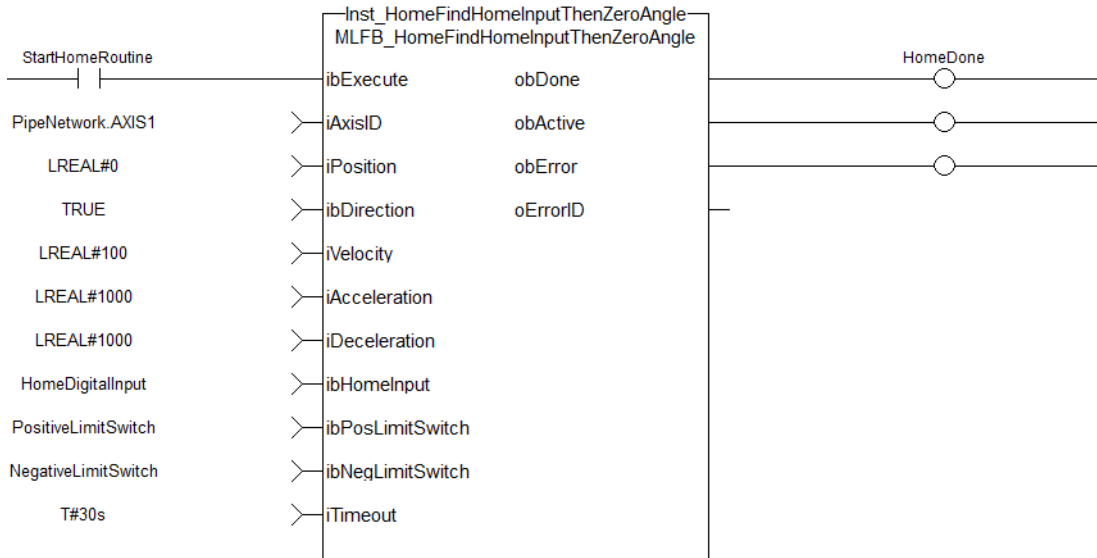

5.2.6.30 MLFB_HomeFindLimitInput Pipe Network ✓

5.2.6.31.1 Description

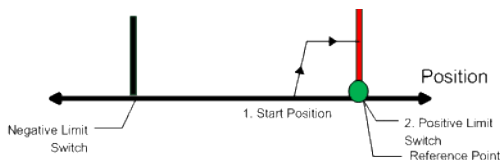

The find limit input mode moves to a limit input. This method can be used if you have a positive or negative limit switch available that you want to establish as a home reference point.

5.2.6.32.2 Arguments

5.2.6.33.3.1 Input

Input	Description	Data type
ibExecute	Start homing, edge-triggered	BOOL
iAxisID	ID of Axis block of Pipe Network	DINT
iPosition	Reference position	LREAL
ibDirection	0=positive, 1=negative	BOOL

iVelocity	Description Data type	Reference speed LREAL
iAcceleration	Description Data type	Reference acceleration LREAL
iDeceleration	Description Data type	Reference deceleration LREAL
ibLimitSwitch	Description Data type	Pos. or neg. limit switch, high-active (depends on ibDirection) BOOL
iTimeout	Description Data type	Time monitoring (T#0ms: off) TIME

5.2.6.34.4.2 Output

obDone	Description Data type	Done bit BOOL
obActive	Description Data type	Active bit BOOL
obError	Description Data type	Error bit BOOL

Error identifier, see list here

oErrorID	Description	ErrorID	Description
		1	Axis in error
		2	Axis not enabled
		3	Timeout expired
		4	SDO read/write error
		5	Input parameter out of range
	Data type	DINT	

5.2.6.35.5 Example

5.2.6.36.6.1 ST

```

//Call homing function on Axis1 with preset velocity, accel, and
decel values
//Start in negative direction and stop when axis hits limit
switch or times out
//after seeing limit switch, set axis position to zero
Inst_MLFB_HomeFindLimitInput( StartHomeRoutine,
    PipeNetwork.AXIS1,
    0,
    TRUE,
    100,
    1000,
    1000,
    HomeDigitalInput,
    T#30s );

HomeDone := Inst_MLFB_HomeFindLimitInput.obDone;
    
```

5.2.6.37.7.2 Function Block Diagram

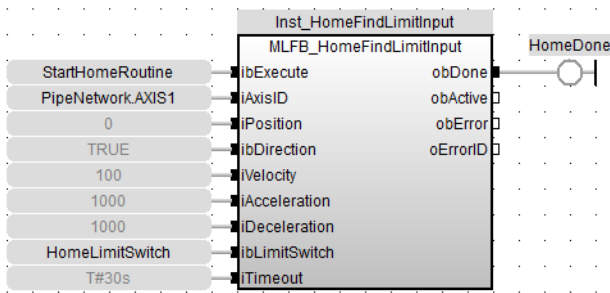

5.2.6.38.8.3 FFLD

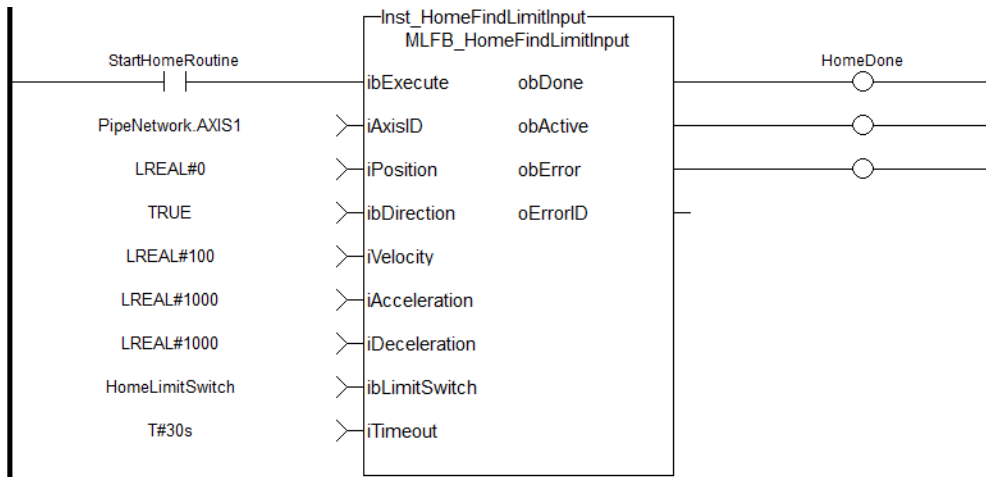

5.2.6.39 MLFB_HomeFindLimitInputThenZeroAngle Pipe Network ✓

5.2.6.40.1 Description

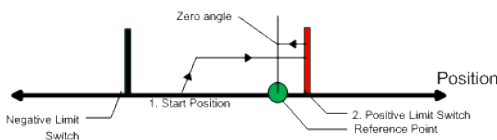

Similar to the Find Input Limit method, the find input limit then find zero angle. Mode follows the same steps, but upon completion of the move, it continues to move to find the zero angle reference of the motor.

5.2.6.41.2 Arguments

5.2.6.42.3.1 Input

ibExecute	Description Data type	Start homing, edge-triggered BOOL
iAxisID	Description Data type	ID of Axis block of Pipe Network BOOL
iPosition	Description Data type	Reference position BOOL
ibDirection	Description Data type	0=positive, 1=negative BOOL
iVelocity	Description Data type	Reference speed BOOL
iAcceleration	Description	Reference acceleration

	Data type	BOOL
iDeceleration	Description	Reference deceleration
	Data type	BOOL
ibLimitSwitch	Description	Pos. or neg. limit switch, high-active (depends on ibDirection)
	Data type	BOOL
iTimeout	Description	Time monitoring (T#0ms: off)
	Data type	BOOL

5.2.6.43.4.2 Output

obDone	Description	Done bit
	Data type	BOOL
obActive	Description	Active bit
	Data type	BOOL
obError	Description	Error bit
	Data type	BOOL

Error identifier, see list here

		ErrorID	Description
		1	Axis in error
		2	Axis not enabled
		3	Timeout expired
		4	SDO read/write error
		5	Input parameter out of range
oErrorID	Description		
	Data type		DINT

5.2.6.44.5 Example

5.2.6.45.6.1 ST

```
//Call homing function on Axis1 with preset velocity, accel, and
decel values
//Start in negative direction and stop when axis hits limit
switch or times out
//after seeing limit switch, moves to zero angle and set axis
position to zero
Inst_MLFB_HomeFindLimitInputThenZeroAngle( StartHomeRoutine,
PipeNetwork.AXIS1,
0,
TRUE,
100,
1000,
1000,
HomeDigitalInput,
T#30s );

HomeDone := Inst_MLFB_HomeFindLimitInputThenZeroAngle.obDone;
```

5.2.6.46.7.2 Function Block Diagram

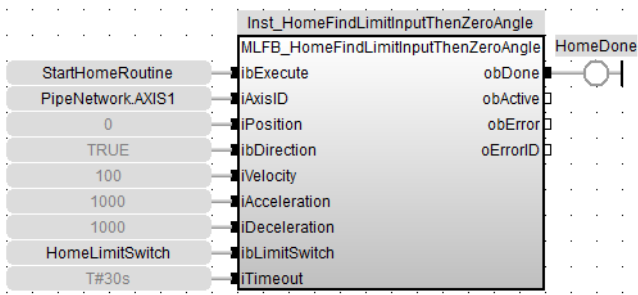

5.2.6.47.8.3 FFLD

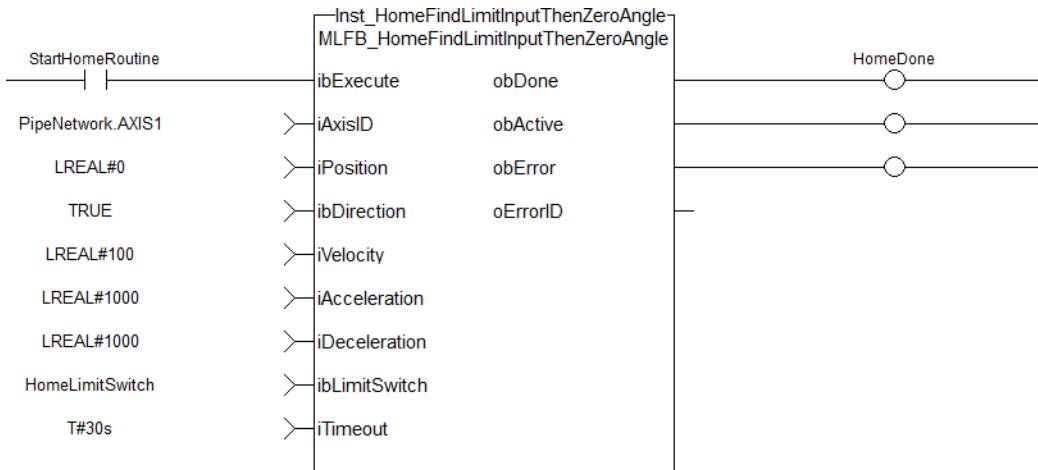

5.2.6.48 MLFB_HomeFindZeroAngle Pipe Network ✓

5.2.6.49.1 Description

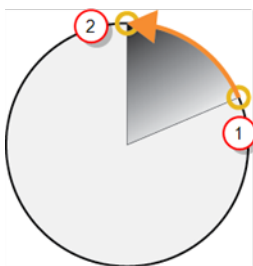

1. Start Position
2. End Position (Zero degrees)

Figure 1-134: Mode to find the zero angle reference of the motor.

NOTE

This function block is only applicable to motors with Resolver or SFD feedback.

5.2.6.50.2 Arguments

5.2.6.51.3.1 Input

ibExecute	Description	Start homing, edge-triggered
	Data type	BOOL
iAxisID	Description	ID of Axis block of Pipe Network
	Data type	DINT

iPosition	Description	Reference position
	Data type	LREAL
iDirectionType	Description	0=positive, 1=negative, 2=shortest
	Data type	DINT
iVelocity	Description	Reference speed
	Data type	LREAL
iAcceleration	Description	Reference acceleration
	Data type	LREAL
iDeceleration	Description	Reference deceleration
	Data type	LREAL
iTimeout	Description	Time monitoring (T#0ms: off)
	Data type	TIME

5.2.6.52.4.2 Output

obDone	Description	Done bit
	Data type	BOOL
obActive	Description	Active bit
	Data type	BOOL
obError	Description	Error bit
	Data type	BOOL
oErrorID	Description	Error identifier, see list here
	Data type	DINT

ErrorID	Description
1	Axis in error
2	Axis not enabled
3	Timeout expired
4	SDO read/write error
5	Input parameter out of range

5.2.6.53.5 Example

5.2.6.54.6.1 ST

```
//Call homing function on Axis1 with preset velocity, accel, and
decel values
//Start in negative direction and go to zero angle or time out
```

```
//after reaching zero angle set axis position to zero
Inst_MLFB_HomeFindZeroAngle( StartHomeRoutine,
PipeNetwork.AXIS1,
0,
1,
100,
1000,
1000,
T#30s );

HomeDone := Inst_MLFB_HomeFindZeroAngle.obDone;
```

5.2.6.55.7.2 Function Block Diagram

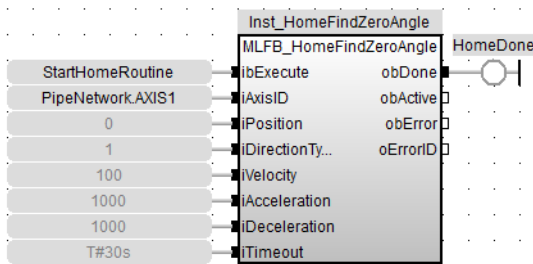

5.2.6.56.8.3 FFLD

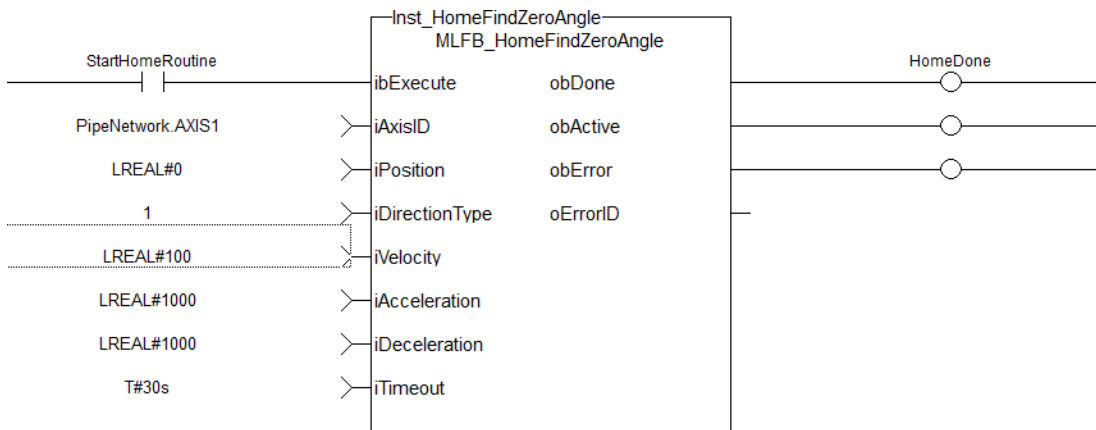

5.2.6.57 MLFB_HomeMoveUntilPosErrExceeded Pipe Network ✓

5.2.6.58.1 Description

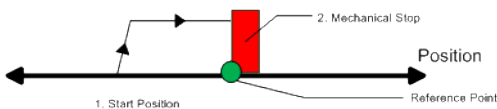

When executed, the motor will move to the hard stop with a definable peak current. When the position error exceeds, the home Position is set.

5.2.6.59.2 Arguments

5.2.6.60.3.1 Input

ibExecute	Description Data type	Start homing, edge-triggered BOOL
-----------	--------------------------	--------------------------------------

iAxisID	Description Data type	ID of Axis block of Pipe Network DINT
iPosition	Description Data type	Reference position LREAL
ibDirection	Description Data type	0=positive, 1=negative BOOL
iVelocity	Description Data type	Reference speed LREAL
iAcceleration	Description Data type	Reference acceleration LREAL
iDeceleration	Description Data type	Reference deceleration LREAL
iMaxPositionError	Description Data type	Maximum position error LREAL
iPeakCurrent	Description Data type	Peak current in mA DINT
iTimeout	Description Data type	Time monitoring (T#0ms: off) TIME

5.2.6.61.4.2 Output

obDone	Description Data type	Done bit BOOL
obActive	Description Data type	Active bit BOOL
obError	Description Data type	Error bit BOOL

Error identifier, see list here

oErrorID	Description	ErrorID	Description
		1	Axis in error
		2	Axis not enabled
		3	Timeout expired
		4	SDO read/write error
		5	Input parameter out of range
	Data type	DINT	

5.2.6.62.5 Example

5.2.6.63.6.1 ST

```
//Call homing function on Axis1 with preset velocity, accel, and
decel values
//Start in negative direction and go until position error
exceeds input value or time out
//afterterwards set axis position to zero
//function block temporarily writes new max current value to 2
Amp while home routine active
Inst_MLFB_HomeMoveUntilPosErrExceeded( StartHomeRoutine,
```

```

PipeNetwork.AXIS1,
0,
1,
100,
1000,
1000,
MaxPosError,
2000,
T#30s );

HomeDone := Inst_MLFB_HomeMoveUntilPosErrExceeded.obDone;
    
```

5.2.6.64.7.2 Function Block Diagram

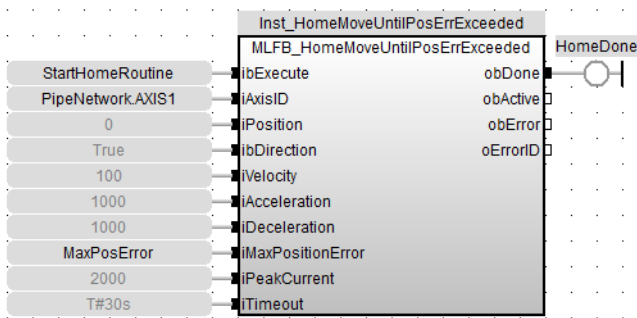

5.2.6.65.8.3 FFLD

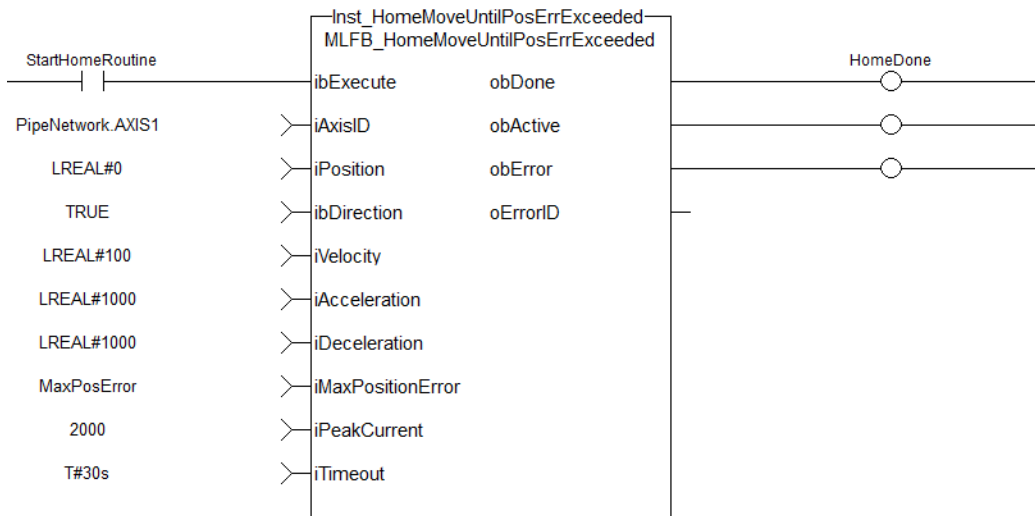

5.2.6.66 MLFB_HomeMoveUntilPosErrExceededThenZeroAngle Pipe Network ✓

5.2.6.67.1 Description

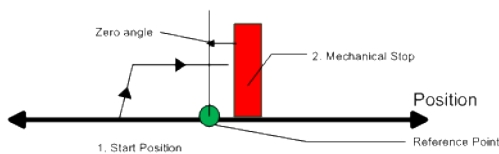

Similar to the Move Until Position Error Exceeded method, the move until position error exceeded then find zero angle. Mode follows the same steps, but upon completion of the move, it continues to move to find the zero angle reference of the motor.

5.2.6.68.2 Arguments**5.2.6.69.3.1 Input**

ibExecute	Description Data type	Start homing, edge-triggered BOOL
iAxisID	Description Data type	ID of Axis block of Pipe Network DINT
iPosition	Description Data type	Reference position LREAL
ibDirection	Description Data type	0=positive, 1=negative BOOL
iVelocity	Description Data type	Reference speed LREAL
iAcceleration	Description Data type	Reference acceleration LREAL
iDeceleration	Description Data type	Reference deceleration LREAL
iMaxPositionError	Description Data type	Maximum position error LREAL
iPeakCurrent	Description Data type	Peak current in mA DINT
iTimeout	Description Data type	Time monitoring (T#0ms: off) TIME

5.2.6.70.4.2 Output

obDone	Description Data type	Done bit BOOL
obActive	Description Data type	Active bit BOOL
obError	Description Data type	Error bit BOOL

Error identifier, see list here

oErrorID	Description	ErrorID	Description
		1	Axis in error
		2	Axis not enabled
		3	Timeout expired
		4	SDO read/write error
		5	Input parameter out of range
	Data type	DINT	

5.2.6.71.5 Example**5.2.6.72.6.1 ST**

```
//Call homing function on Axis1 with preset velocity, accel, and
decel values
//Start in negative direction and go until position error
```

```

exceeds input value or time out
//afterwards moves to zero angle and sets axis position to
zero
//function block temporarily writes new max current value to 2
Amp while home routine active
Inst_MLFB_HomeMoveUntilPosErrExceededThenZeroAngle(
StartHomeRoutine,
PipeNetwork.AXIS1,
0,
1,
100,
1000,
1000,
MaxPosError,
2000,
T#30s );

HomeDone := Inst_MLFB_
HomeMoveUntilPosErrExceededThenZeroAngle.obDone;
    
```

5.2.6.73.7.2 Function Block Diagram

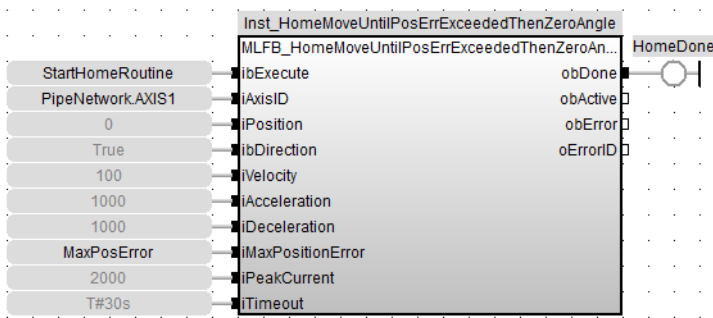

5.2.6.74.8.3 FFLD

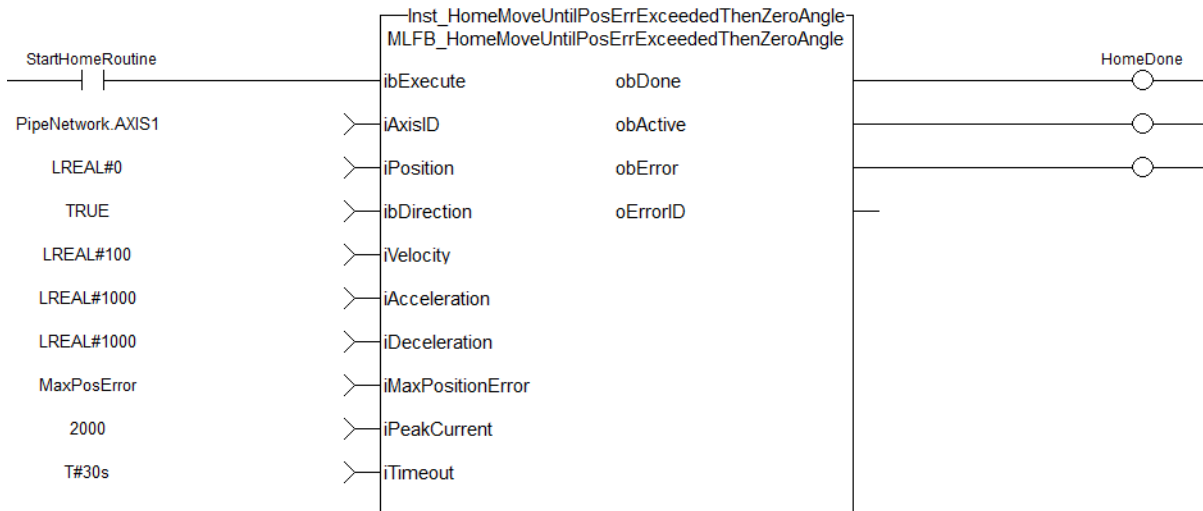

5.2.6.75 MLFB_HomeUsingCurrentPosition Pipe Network ✓

5.2.6.76.1 Description

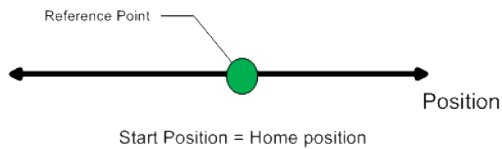

Using the current position is the most basic homing method. This method simply uses the current position of the motor as the home point reference.

You can use this parameter to set the value of the home position other than zero. This allows you to offset your home reference away from zero.

5.2.6.77.2 Arguments

5.2.6.78.3.1 Input

ibExecute	Description Data type	Start homing, edge-triggered BOOL
iAxisID	Description Data type	ID of Axis block of Pipe Network DINT
iPosition	Description Data type	Reference position LREAL

5.2.6.79.4.2 Output

obDone	Description Data type	Done bit BOOL
obActive	Description Data type	Active bit BOOL
obError	Description Data type	Error bit BOOL

Error identifier, see list here

ErrorID	Description
1	Axis in error
2	Axis not enabled
3	Timeout expired
4	SDO read/write error
5	Input parameter out of range

oErrorID	Description	DINT
----------	-------------	------

5.2.6.80.5 Example

5.2.6.81.6.1 ST

```
//No movement, set current axis position to position input in
this case zero
Inst_MLFB_HomeUsingCurrentPosition( StartHomeRoutine,
PipeNetwork.AXIS1, 0 );
HomeDone := Inst_MLFB_HomeUsingCurrentPosition.obDone;
```

5.2.6.82.7.2 Function Block Diagram

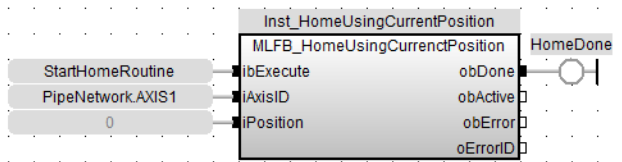

5.2.6.83.8.3 FFLD

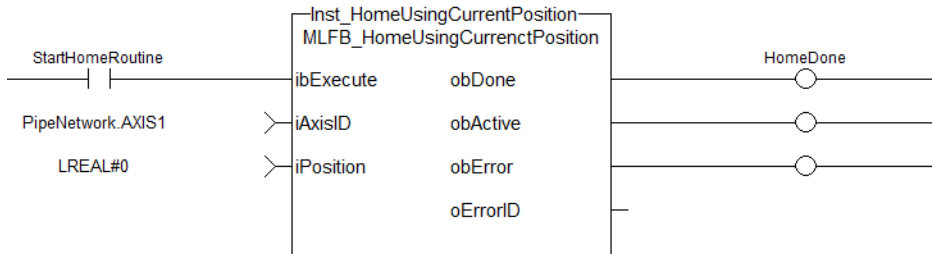

5.2.6.84 MLFB_HomeFindHomeFastInput Pipe Network ✓

5.2.6.85.1 Description

This function block performs a single-axis home to a limit switch connected to a High Speed Input. The motor starts to move according to the direction setting. The home position has been found as soon as the fast input selected is triggered on the edge selected.

An absolute move is made to the triggered position, and then the position value is set. The hardware limit switches are monitored during the homing procedure.

The drive behaves as follows in case that a hardware limit switch is active before the home-switch has been activated: The motor changes the direction until the home switch is crossed.

The following figure shows the function block I/O:

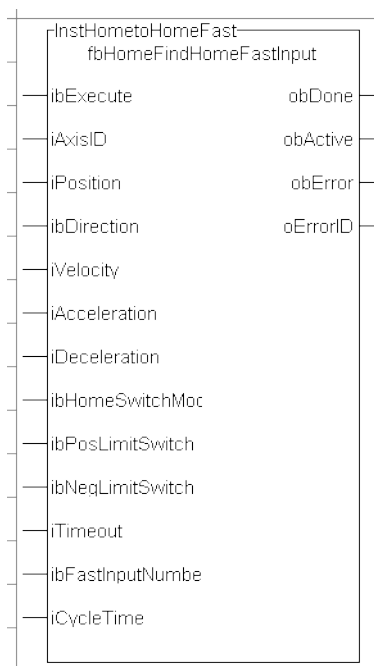

Figure 1-135: MLFB HomeFindHomeFastInput

5.2.6.86.2 Arguments**5.2.6.87.3.1 Input**

ibExecute	Description	Request the homing step procedure at rising edge
	Data type	BOOL
	Range	[0 , 1]
	Unit	n/a
	Default	—
iAxisID	Description	Name of a declared instance of the AXIS_REF library function
	Data type	AXIS_REF
	Range	[1 , 256]
	Unit	n/a
	Default	—
iPosition	Description	Offset Position Applied After Home Switch is found
	Data type	LREAL
	Range	—
	Unit	User unit
	Default	—

Define the axis homing direction

ibDirection	Description	<table border="1"> <thead> <tr> <th>Value</th> <th>Description</th> </tr> </thead> <tbody> <tr> <td>0</td> <td>clockwise rotation</td> </tr> <tr> <td>1</td> <td>counterclockwise rotation</td> </tr> </tbody> </table>		Value	Description	0	clockwise rotation	1	counterclockwise rotation
		Value	Description						
	0	clockwise rotation							
	1	counterclockwise rotation							
	Data type	BOOL							
Range	[0 , 1]								
Unit	n/a								
Default	—								

iVelocity	Description	Commanded velocity for the homing move
	Data type	LREAL
	Range	—
	Unit	User unit/sec
	Default	—
iAcceleration	Description	Commanded acceleration for the homing move
	Data type	LREAL
	Range	—
	Unit	User unit/sec ²
	Default	—
iDeceleration	Description	Commanded deceleration for the homing move
	Data type	LREAL
	Range	—
	Unit	User unit/sec ²
	Default	—

Limit switch state to complete homing

ibHomeSwitchMode	Description	<table border="1"> <thead> <tr> <th>Value</th> <th>Description</th> </tr> </thead> <tbody> <tr> <td>0</td> <td>Rising edge of switch</td> </tr> <tr> <td>1</td> <td>Falling edge of switch</td> </tr> </tbody> </table>		Value	Description	0	Rising edge of switch	1	Falling edge of switch
		Value	Description						
	0	Rising edge of switch							
1	Falling edge of switch								
Data type	BOOL								
Range	[0 , 1]								

	Unit	n/a						
	Default	—						
ibPosLimitSwitch	Description	The positive direction limit switch input I/O point						
	Data type	BOOL						
	Range	[0, 1]						
	Unit	n/a						
	Default	—						
ibNegLimitSwitch	Description	The negative direction limit switch input I/O point						
	Data type	BOOL						
	Range	[0, 1]						
	Unit	n/a						
	Default	—						
iTimeout	Description	Maximum time for homing move to complete. If exceeded the homing procedure will error out. 0= no time limit						
	Data type	TIME						
	Range	—						
	Unit	sec						
	Default	—						
		Limit switch state to complete homing.						
ibFastInputNumber	Description	<table border="1"> <thead> <tr> <th>Value</th> <th>Description</th> </tr> </thead> <tbody> <tr> <td>0</td> <td>Fast Input Number 1</td> </tr> <tr> <td>1</td> <td>Fast Input Number 2</td> </tr> </tbody> </table>	Value	Description	0	Fast Input Number 1	1	Fast Input Number 2
Value	Description							
0	Fast Input Number 1							
1	Fast Input Number 2							
	Data type	BOOL						
	Range	[0, 1]						
	Unit	n/a						
	Default	—						
iCycleTime	Description	Ethercat Cycle Time 250, 500 or 1000						
	Data type	LREAL						
	Range	—						
	Unit	microseconds						
	Default	—						

5.2.6.88.4.2 Output

obDone	Description	Indicates the move completed successfully. The Command Position has reached the endpoint
	Data type	BOOL
	Unit	n/a
obActive	Description	Indicates this move is the active move
	Data type	BOOL
	Unit	n/a
obError	Description	Indicates an invalid input was specified or the move was terminated due to an error
	Data type	BOOL
	Unit	n/a

Indicates the error if Error output is set to TRUE

oErrorID

Description

Value	Description
1	Axis in Error State
2	Axis is Not Enabled
3	Timeout Exceeded
4	SDO Read/Write Error
5	Input Parameter out of Range

Data type

DINT

Unit

n/a

5.2.6.89.5 Usage

This homing procedure performs a homing function searching for sensor using only High Speed Input Switches. (A High Speed Limit Switch has 1 "Off" (or "On") area).

- Home is commanded by user in the desired homing direction at the selected Velocity
- If LimitSwitch is found 'On' on rising 'Execute', then the process is started in the opposite direction as specified, LimitSwitch is search for 'Off' (or On, depending on LimitSwitchMode setting) Edge (released), and process is restarted again in original direction. This ensures that the end conditions are always the same
- The Timeout can cause an error if exceeded

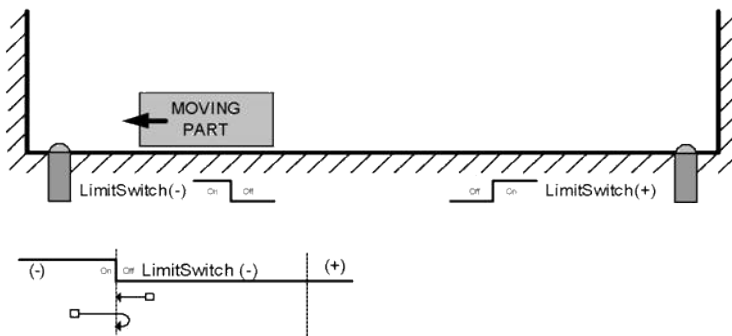

5.2.6.90.6 Related Functions

[MLFB_HomeFindHomeFastInputModulo](#)

[MLFB_HomeFindLimitFastInput](#)

[MLFB_HomeFindLimitFastInputModulo](#)

5.2.6.91.7 Example

5.2.6.92.8.1 Structured Text

```

Direction:= 0;
Position:=1000;
Velocity:=1000;
Acceleration:=10000;
Deceleration:=10000;
SwitchMode:=0;
Timeout:=T#100;
FastInputNumber:=0;
CycleTime:=1000;
    
```

```

inst_fbHomeFindHomeFastInput(True, Axis1, Position, Direction,
Velocity, Acceleration, Deceleration, HomeSwitchMode,
PosLimitSwitch, NegLimitSwitch, Timeout, FastInputNumber,
CycleTime);
    
```

```

HomeComplete :=inst_fbHomeFindHomeFastInput.Done;
HomeActive :=inst_fbHomeFindHomeFastInput.Active;
HomeError :=inst_fbHomeFindHomeFastInput.Error;
HomeErrorID :=inst_fbHomeFindHomeFastInput.ErrorID;
    
```

(* PosLimitSwitch and NegLimitSwtch are declared I/O points *)

5.2.6.93.9.2 Ladder Diagram

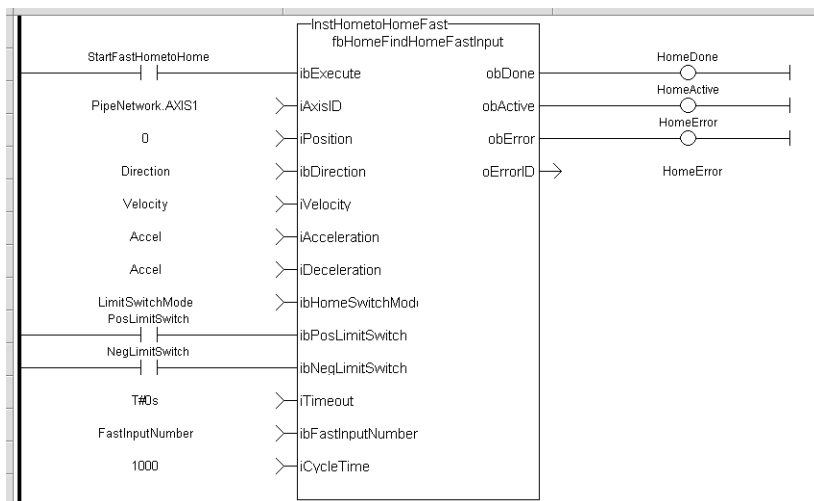

5.2.6.94.10.3 Function Block Diagram

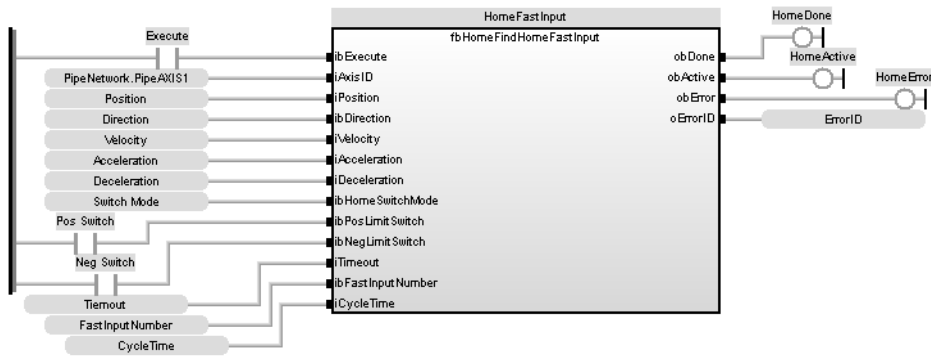

5.2.6.95 MLFB_HomeFindHomeFastInputModulo Pipe Network ✓

5.2.6.96.1 Description

This Application Specific Function function block performs a single-axis home to a limit switch connected to a High Speed Input. The motor starts to move according to the direction setting. The home position has been found as soon as the fast input selected is triggered on the edge selected.

An absolute move is made to the triggered position, and then the position value is set. The hardware limit switches are monitored during the homing procedure.

The drive behaves as follows in case that a hardware limit switch is active before the home-switch has been activated: The motor changes the direction until the home switch is crossed. This function is to be used when the axis is set-up in Modulo mode.

The following figure shows the function block I/O:

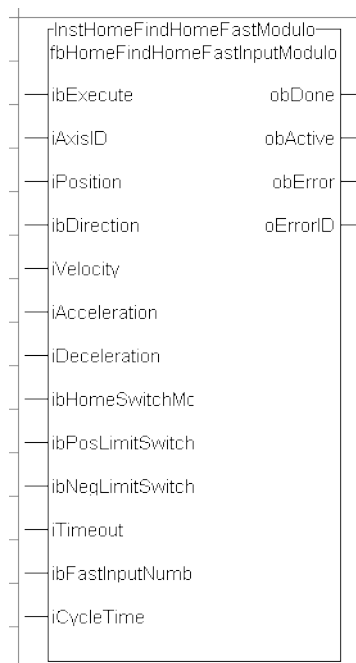

Figure 1-136: MLFB HomeFindHomeFastInputModulo

5.2.6.97.2 Arguments

5.2.6.98.3.1 Input

ibExecute	Description	Request the homing step procedure at rising edge						
	Data type	BOOL						
	Range	[0 , 1]						
	Unit	n/a						
	Default	—						
iAxisID	Description	Name of a declared instance of the AXIS_REF library function						
	Data type	AXIS_REF						
	Range	[1 , 256]						
	Unit	n/a						
	Default	—						
iPosition	Description	Offset Position Applied After Home Switch is found						
	Data type	LREAL						
	Range	—						
	Unit	User unit						
	Default	—						
ibDirection	Description	Define the axis homing direction						
		<table border="1"> <thead> <tr> <th>Value</th> <th>Description</th> </tr> </thead> <tbody> <tr> <td>0</td> <td>clockwise rotation</td> </tr> <tr> <td>1</td> <td>counterclockwise rotation</td> </tr> </tbody> </table>	Value	Description	0	clockwise rotation	1	counterclockwise rotation
		Value	Description					
	0	clockwise rotation						
	1	counterclockwise rotation						
Data type	BOOL							
Range	[0 , 1]							
Unit	n/a							
iVelocity	Description	Commanded velocity for the homing move						
	Data type	LREAL						
	Range	—						
	Unit	User unit/sec						
	Default	—						
iAcceleration	Description	Commanded acceleration for the homing move						
	Data type	LREAL						
	Range	—						
	Unit	User unit/sec ²						
	Default	—						
iDeceleration	Description	Commanded deceleration for the homing move						
	Data type	LREAL						
	Range	—						
	Unit	User unit/sec ²						
	Default	—						
ibLimitSwitchMode	Description	Limit switch state to complete homing						
		<table border="1"> <thead> <tr> <th>Value</th> <th>Description</th> </tr> </thead> <tbody> <tr> <td>0</td> <td>Rising edge of switch</td> </tr> <tr> <td>1</td> <td>Falling edge of switch</td> </tr> </tbody> </table>	Value	Description	0	Rising edge of switch	1	Falling edge of switch
		Value	Description					
	0	Rising edge of switch						
	1	Falling edge of switch						
Data type	BOOL							
Range	[0 , 1]							
Unit	n/a							
Default	—							

ibPosLimitSwitch	Description	The positive direction limit switch input I/O point					
	Data type	BOOL					
	Range	[0 , 1]					
	Unit	n/a					
	Default	—					
ibNegLimitSwitch	Description	The negative direction limit switch input I/O point					
	Data type	BOOL					
	Range	[0 , 1]					
	Unit	n/a					
	Default	—					
iTimeout	Description	Maximum time for homing move to complete. If exceeded the homing procedure will error out. 0= no time limit					
	Data type	TIME					
	Range	—					
	Unit	sec					
	Default	—					
ibFastInputNumber	Description	Limit switch state to complete homing.					
		<table border="1"> <thead> <tr> <th>Value</th> <th>Description</th> </tr> </thead> <tbody> <tr> <td>0</td> <td>Fast Input Number 1</td> </tr> <tr> <td>1</td> <td>Fast Input Number 2</td> </tr> </tbody> </table>	Value	Description	0	Fast Input Number 1	1
	Value	Description					
	0	Fast Input Number 1					
	1	Fast Input Number 2					
Data type	BOOL						
Range	[0 , 1]						
Unit	n/a						
iCycleTime	Description	Ethercat Cycle Time					
		250, 500 or 1000					
	Data type	LREAL					
	Range	—					
	Unit	microseconds					
	Default	—					
5.2.6.99.4.2 Output							
obDone	Description	Indicates the move completed successfully. The Command Position has reached the endpoint					
	Data type	BOOL					
	Unit	n/a					
obActive	Description	Indicates this move is the active move					
	Data type	BOOL					
	Unit	n/a					
obError	Description	Indicates an invalid input was specified or the move was terminated due to an error					
	Data type	BOOL					
	Unit	n/a					

Indicates the error if Error output is set to TRUE

oErrorID

Description

Data type
Unit

Value	Description
1	Axis in Error State
2	Axis is Not Enabled
3	Timeout Exceeded
4	SDO Read/Write Error
5	Input Parameter out of Range

DINT
n/a

5.2.6.100.5 Usage

This homing procedure performs a homing function searching for sensor using only High Speed Input Switches. (A High Speed Limit Switch has 1 “Off” (or “On”) area).

- Home is commanded by user in the desired homing direction at the selected Velocity
- If LimitSwitch is found ‘On’ on rising ‘Execute’, then the process is started in the opposite direction as specified, LimitSwitch is search for ‘Off’ (or On, depending on LimitSwitchMode setting) Edge (released), and process is restarted again in original direction. This ensures that the end conditions are always the same
- The Timeout can cause an error if exceeded

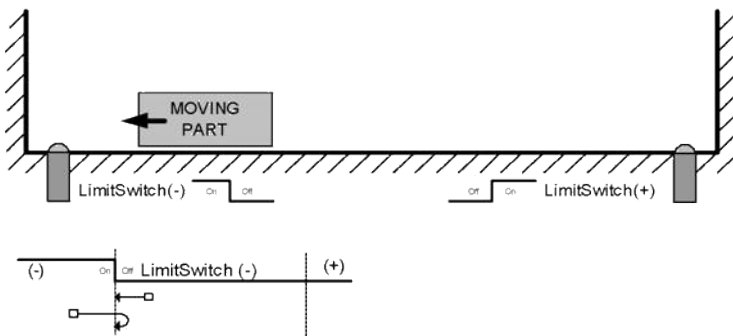

5.2.6.101.6 Related Functions

[MLFB_HomeFindHomeFastInput](#)

[MLFB_HomeFindLimitFastInput](#)

[MLFB_HomeFindLimitFastInputModulo](#)

5.2.6.102.7 Example

5.2.6.103.8.1 Structured Text

```
Direction:= 0;
Position:=1000;
Velocity:=1000;
Acceleration:=10000;
Deceleration:=10000;
SwitchMode:=0;
Timeout:=T#100;
FastInputNumber:=0;
CycleTime:=1000;

inst_fbHomeFindHomeFastInputModulo(True, Axis1, Position,
Direction, Velocity, Acceleration, Deceleration,
PosLimitSwitch, NegLimitSwitch, Timeout, FastInputNumber,
CycleTime);

HomeComplete :=inst_fbHomeFindHomeFastInputModulo.Done;
HomeActive :=inst_fbHomeFindHomeFastInputModulo.Active;
HomeError :=inst_fbHomeFindHomeFastInputModulo.Error;
HomeErrorID :=inst_fbHomeFindHomeFastInputModulo.ErrorID;

(* PosLimitSwitch and NegLimitSwtch are declared I/O points *)
```

5.2.6.104.9.2 Ladder Diagram

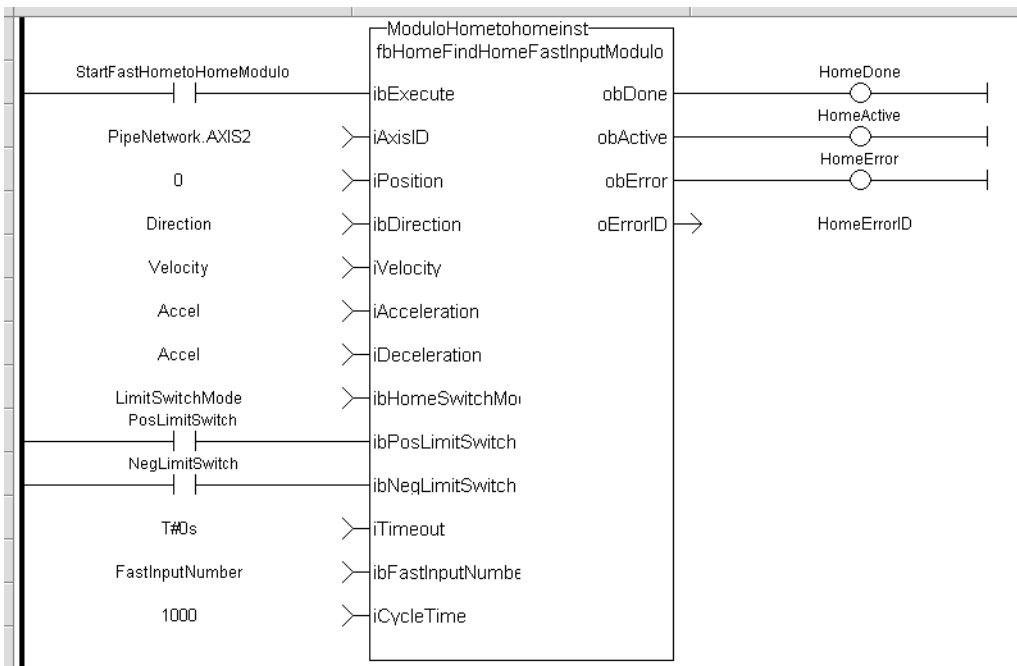

5.2.6.105.10.3 Function Block Diagram

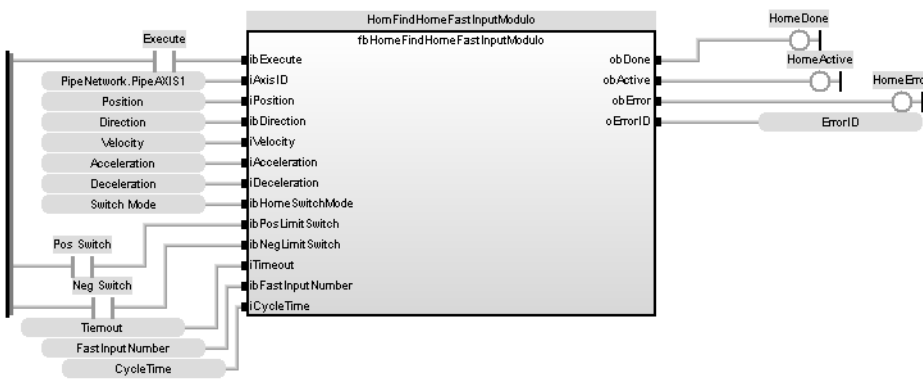

5.2.6.106 MLFB_HomeFindLimitFastInput Pipe Network ✓

5.2.6.107.1 Description

This function block performs a single-axis home to a limit switch connected to a High Speed Input. The motor starts to move according to the direction setting. The home position has been found as soon as the fast input selected is triggered on the edge selected.

An absolute move is made to the triggered position, and then the position value is set.

The following figure shows the function block I/O:

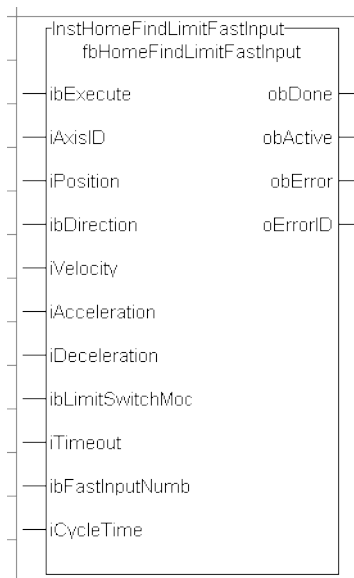

Figure 1-137: MLFB HomeFindLimitFastInput

5.2.6.108.2 Arguments

5.2.6.109.3.1 Input

ibExecute	Description	Request the homing step procedure at rising edge					
	Data type	BOOL					
	Range	[0 , 1]					
	Unit	n/a					
	Default	—					
iAxisID	Description	Name of a declared instance of the AXIS_REF library function					
	Data type	AXIS_REF					
	Range	[1 , 256]					
	Unit	n/a					
	Default	—					
iPosition	Description	Offset Position Applied After Home Switch is found					
	Data type	LREAL					
	Range	—					
	Unit	User unit					
	Default	—					
ibDirection	Description	Define the axis homing direction					
		<table border="1"> <thead> <tr> <th>Value</th> <th>Description</th> </tr> </thead> <tbody> <tr> <td>0</td> <td>clockwise rotation</td> </tr> <tr> <td>1</td> <td>counterclockwise rotation</td> </tr> </tbody> </table>	Value	Description	0	clockwise rotation	1
	Value	Description					
	0	clockwise rotation					
	1	counterclockwise rotation					
Data type	BOOL						
Range	[0 , 1]						
Unit	n/a						
Default	—						
iVelocity	Description	Commanded velocity for the homing move					
	Data type	LREAL					
	Range	—					
	Unit	User unit/sec					
	Default	—					

iAcceleration Description Commanded acceleration for the homing move
 Data type LREAL
 Range —
 Unit User unit/sec²
 Default —

iDeceleration Description Commanded deceleration for the homing move
 Data type LREAL
 Range —
 Unit User unit/sec²
 Default —

ibLimitSwitchMode Description Limit switch state to complete homing

Value	Description
0	Rising edge of switch
1	Falling edge of switch

Data type BOOL
 Range [0 , 1]
 Unit n/a
 Default —

iTimeout Description Maximum time for homing move to complete. If exceeded the homing procedure will error out. 0= no time limit
 Data type TIME
 Range —
 Unit sec
 Default —

ibFastInputNumber Description Limit switch state to complete homing.

Value	Description
0	Fast Input Number 1
1	Fast Input Number 2

Data type BOOL
 Range [0 , 1]
 Unit n/a
 Default —

iCycleTime Description Ethercat Cycle Time
 250, 500 or 1000
 Data type LREAL
 Range —
 Unit microseconds
 Default —

5.2.6.110.4.2 Output

obDone Description Indicates the move completed successfully.
 The Command Position has reached the endpoint
 Data type BOOL
 Unit n/a

obActive Description Indicates this move is the active move
 Data type BOOL
 Unit n/a

obError Description Indicates an invalid input was specified or the move was terminated due to an error
 Data type BOOL
 Unit n/a

Indicates the error if Error output is set to TRUE

oErrorID Description
 Data type DINT
 Unit n/a

Value	Description
1	Axis in Error State
2	Axis is Not Enabled
3	Timeout Exceeded
4	SDO Read/Write Error
5	Input Parameter out of Range

5.2.6.111.5 Usage

This homing procedure performs a homing function searching for sensor using only High Speed Input Switches. (A High Speed Limit Switch has 1 “Off” (or “On”) area).

- Home is commanded by user in the desired homing direction at the selected Velocity.
- The Timeout can cause an error if exceeded

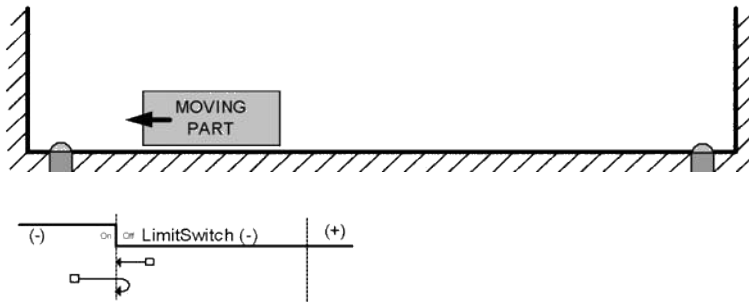

5.2.6.112.6 Related Functions

- [MLFB_HomeFindHomeFastInput](#)
- [MLFB_HomeFindHomeFastInputModulo](#)
- [MLFB_HomeFindLimitFastInputModulo](#)

5.2.6.113.7 Example

5.2.6.114.8.1 Structured Text

```

Direction:= 0;
Position:=1000;
Velocity:=1000;
Acceleration:=10000;
Deceleration:=10000;
SwitchMode:=0;
Timeout:=T#100;
FastInputNumber:=0;
CycleTime:=1000;
    
```

```

inst_fbHomeFindLimitFastInput(True, Axis1, Position, Direction,
Velocity, Acceleration, Deceleration, LimitSwitchMode, Timeout,
FastInputNumber, CycleTime);
    
```

```

HomeComplete :=inst_fbHomeFindLimitFastInput.Done;
HomeActive :=inst_fbHomeFindLimitFastInput.Active;
HomeError :=inst_fbHomeFindLimitFastInput.Error;
HomeErrorID :=inst_fbHomeFindLimitFastInput.ErrorID;
    
```

5.2.6.115.9.2 Ladder Diagram

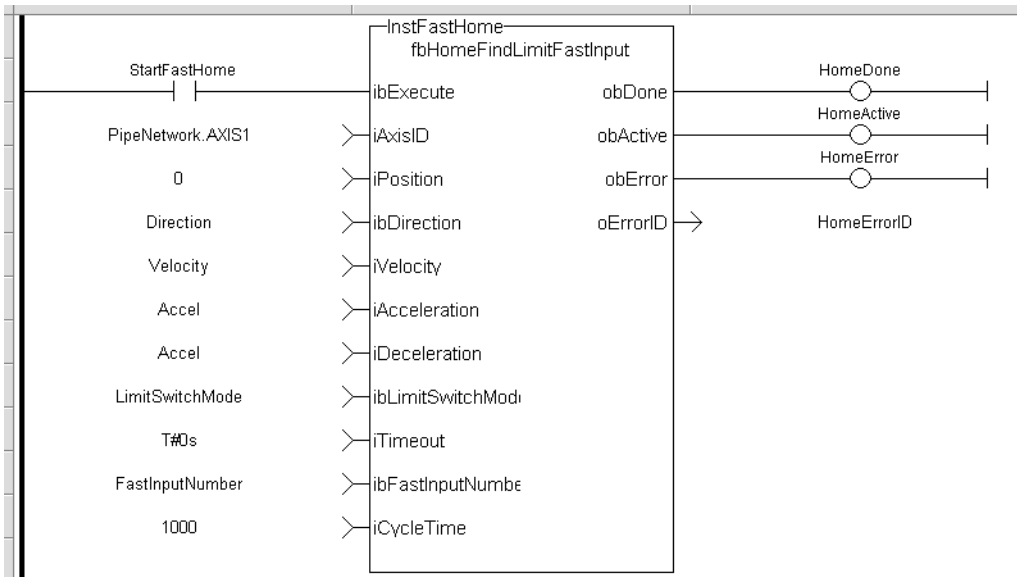

5.2.6.116.10.3 Function Block Diagram

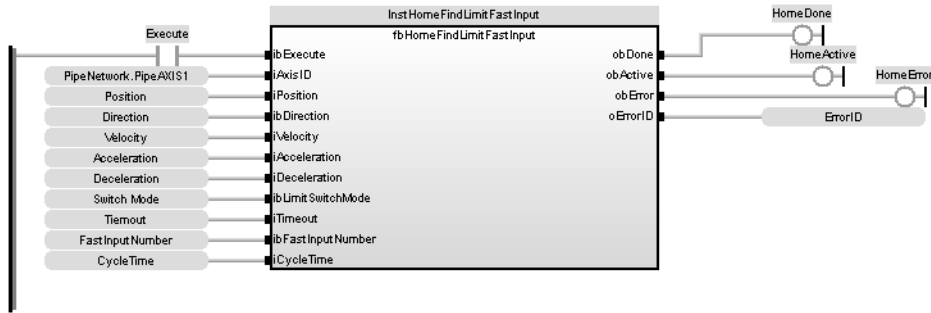

5.2.6.117 MLFB_HomeFindLimitFastInputModulo Pipe Network ✓

5.2.6.118.1 Description

This function block performs a single-axis home to a limit switch connected to a High Speed Input. The motor starts to move according to the direction setting. The home position has been found as soon as the fast input selected is triggered on the edge selected.

An absolute move is made to the triggered position, and then the position value is set. This function is to be used when the axis is set-up in Modulo mode.

The following figure shows the function block I/O:

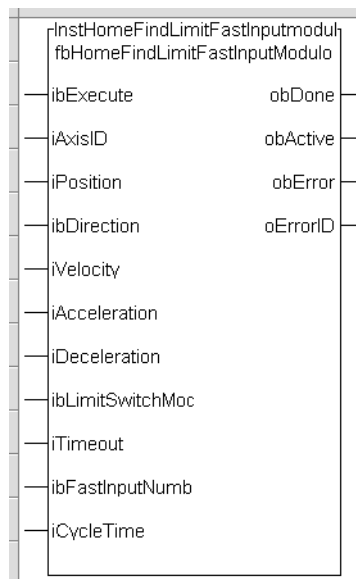

Figure 1-138: MLFB HomeFindLimitFastInputModulo

5.2.6.119.2 Arguments

5.2.6.120.3.1 Input

ibExecute	Description	Request the homing step procedure at rising edge
	Data type	BOOL
	Range	[0, 1]
	Unit	n/a
	Default	—

iAxisID	Description	Name of a declared instance of the AXIS_REF library function					
	Data type	AXIS_REF					
	Range	[1 , 256]					
	Unit	n/a					
	Default	—					
iPosition	Description	Offset Position Applied After Home Switch is found					
	Data type	LREAL					
	Range	—					
	Unit	User unit					
	Default	—					
ibDirection	Description	Define the axis homing direction					
		<table border="1"> <thead> <tr> <th>Value</th> <th>Description</th> </tr> </thead> <tbody> <tr> <td>0</td> <td>clockwise rotation</td> </tr> <tr> <td>1</td> <td>counterclockwise rotation</td> </tr> </tbody> </table>	Value	Description	0	clockwise rotation	1
	Value	Description					
	0	clockwise rotation					
	1	counterclockwise rotation					
Data type	BOOL						
Range	[0 , 1]						
Unit	n/a						
iVelocity	Description	Commanded velocity for the homing move					
	Data type	LREAL					
	Range	—					
	Unit	User unit/sec					
	Default	—					
iAcceleration	Description	Commanded acceleration for the homing move					
	Data type	LREAL					
	Range	—					
	Unit	User unit/sec ²					
	Default	—					
iDeceleration	Description	Commanded deceleration for the homing move					
	Data type	LREAL					
	Range	—					
	Unit	User unit/sec ²					
	Default	—					
ibLimitSwitchMode	Description	Limit switch state to complete homing					
		<table border="1"> <thead> <tr> <th>Value</th> <th>Description</th> </tr> </thead> <tbody> <tr> <td>0</td> <td>Rising edge of switch</td> </tr> <tr> <td>1</td> <td>Falling edge of switch</td> </tr> </tbody> </table>	Value	Description	0	Rising edge of switch	1
	Value	Description					
	0	Rising edge of switch					
	1	Falling edge of switch					
Data type	BOOL						
Range	[0 , 1]						
Unit	n/a						
iTimeout	Description	Maximum time for homing move to complete. If exceeded the homing procedure will error out. 0= no time limit					
	Data type	TIME					
	Range	—					
	Unit	sec					
	Default	—					

Limit switch state to complete homing.

ibFastInputNumber	Description	Value	Description
		0	Fast Input Number 1
		1	Fast Input Number 2
	Data type	BOOL	
	Range	[0 , 1]	
	Unit	n/a	
	Default	—	
iCycleTime	Description	Ethercat Cycle Time 250, 500 or 1000	
	Data type	LREAL	
	Range	—	
	Unit	microseconds	
	Default	—	

5.2.6.121.4.2 Output

obDone	Description	Indicates the move completed successfully. The Command Position has reached the endpoint	
	Data type	BOOL	
	Unit	n/a	
obActive	Description	Indicates this move is the active move	
	Data type	BOOL	
	Unit	n/a	
obError	Description	Indicates an invalid input was specified or the move was terminated due to an error	
	Data type	BOOL	
	Unit	n/a	
oErrorID	Description	Indicates the error if Error output is set to TRUE	
		Value	Description
		1	Axis in Error State
		2	Axis is Not Enabled
		3	Timeout Exceeded
4	SDO Read/Write Error		
	5	Input Parameter out of Range	
	Data type	DINT	
	Unit	n/a	

5.2.6.122.5 Usage

This homing procedure performs a homing function searching for sensor using only High Speed Input Switches. (A High Speed Limit Switch has 1 “Off” (or “On”) area).

- Home is commanded by user in the desired homing direction at the selected Velocity.
- The Timeout can cause an error if exceeded



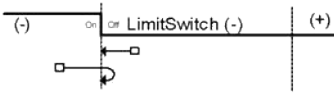

5.2.6.123.6 Related Functions

[MLFB_HomeFindHomeFastInput](#)

[MLFB_HomeFindHomeFastInputModulo](#)

[MLFB_HomeFindLimitFastInput](#)

5.2.6.124.7 Example

5.2.6.125.8.1 Structured Text

```

Direction:= 0;
Position:=1000;
Velocity:=1000;
Acceleration:=10000;
Deceleration:=10000;
SwitchMode:=0;
Timeout:=T#100;
FastInputNumber:=0;
CycleTime:=1000;

```

```

inst_fbHomeFindLimitFastInputModulo(True, Axis1, Position,
Direction, Velocity, Acceleration, Deceleration,
LimitSwitchMode, Timeout, FastInputNumber, CycleTime);

```

```

HomeComplete :=inst_fbHomeFindLimitFastInputModulo.Done;
HomeActive :=inst_fbHomeFindLimitFastInputModulo.Active;
HomeError :=inst_fbHomeFindLimitFastInputModulo.Error;
HomeErrorID :=inst_fbHomeFindLimitFastInputModulo.ErrorID;

```

5.2.6.126.9.2 Ladder Diagram

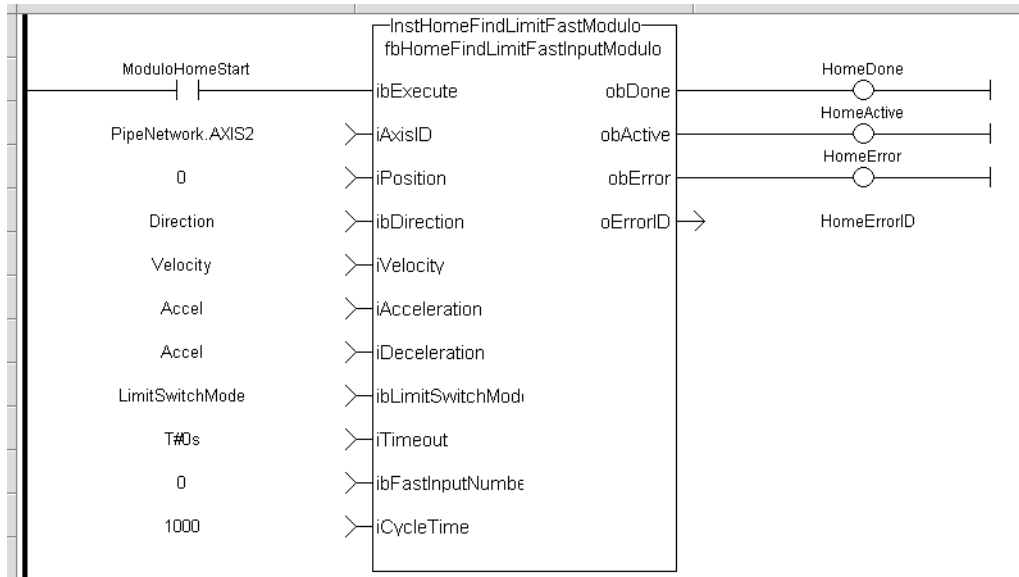

5.2.6.127.10.3 Function Block Diagram

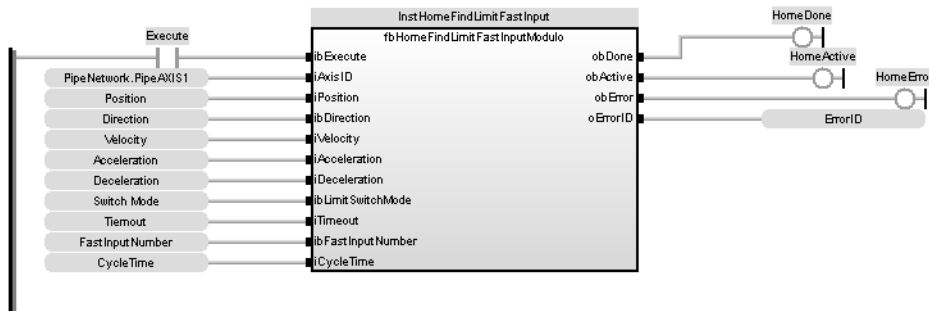

5.2.7 Jog for Pipe Network Pipe Network ✓

5.2.7.1 Description

This function is defined to jog an axis in the selected direction at a defined speed. The En input (FFLD editor only) must be high. Typically wired to the rail. The AxisID selects the axis to jog. The JogPlus and JogMinus inputs select the direction the motion will occur in. Only one of these inputs should be enabled at a given time. If both are selected the motion will stop. If other motion is active when the jog is requested that motion will be aborted and the jog will start.

The following figure shows the function I/O

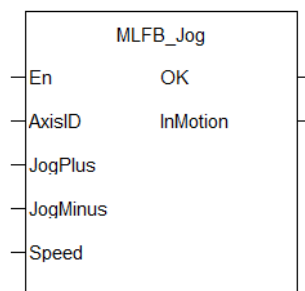

Figure 1-139: Kollmorgen UDFB Jog for PipeNetwork

5.2.7.2 Arguments

5.2.7.3.1 Input

En	Description	Enables execution (FFLD only)
	Data type	BOOL
	Range	—
	Unit	n/a
	Default	—
AxisID	Description	ID Name of the Axis
	Data type	DINT
	Range	—
	Unit	n/a
	Default	—
JogPlus	Description	Enables a Jog in the plus direction
	Data type	BOOL
	Range	[0 , 1]
	Unit	n/a
	Default	—
JogMinus	Description	Enables a Jog in the Minus direction
	Data type	BOOL
	Range	[0 , 1]
	Unit	n/a
	Default	—
Speed	Description	Rate at which the axis will move
	Data type	LREAL
	Range	—
	Unit	User unit/sec
	Default	—

5.2.7.4.2 Output

InMotion	Description	Jogging is active when TRUE
-----------------	--------------------	-----------------------------

Data type	BOOL
Range	n/a

5.2.7.5 Usage

This function is used to command motion in a designated direction at a defined rate. This may be used where continuous motion required as in a conveyor system, or in a setup mode for manually jogging the axis. Motion will start when the JogPlus or JogMinus input is true. It will stop when the input goes false. This function is used with the Pipe Network motion engine.

5.2.7.6 Related Functions

[MLAxisMoveVel](#)

5.2.7.7 Example

5.2.7.8.1 Structured Text

```
//Jog Axis1 at 6000 user units a second when JogPlus or JogMinus
variables are TRUE
//Stop motion on falling edge of either variable
MLFB_Jog( PipeNetwork.AXIS1, JogPlus, JogMinus, 6000 );
```

5.2.7.9.2 Ladder Diagram

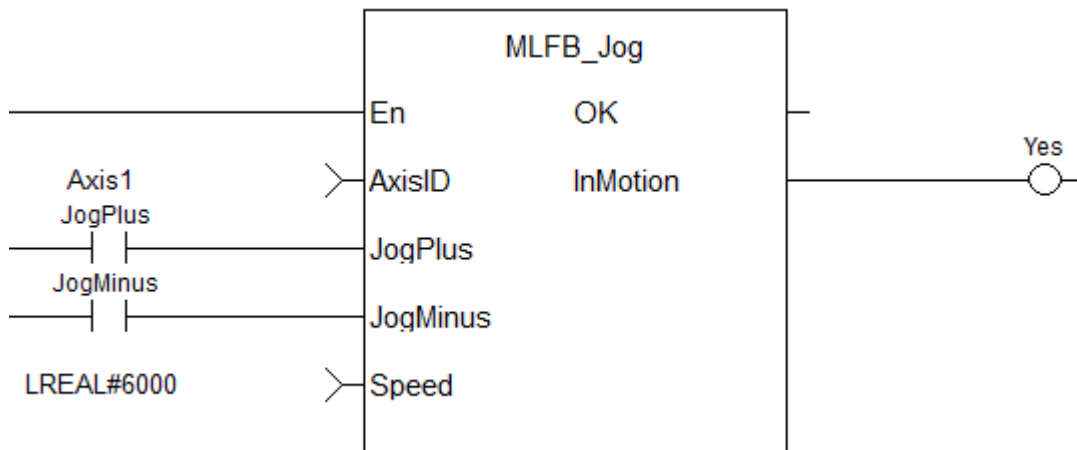

5.2.7.10.3 Function Block Diagram

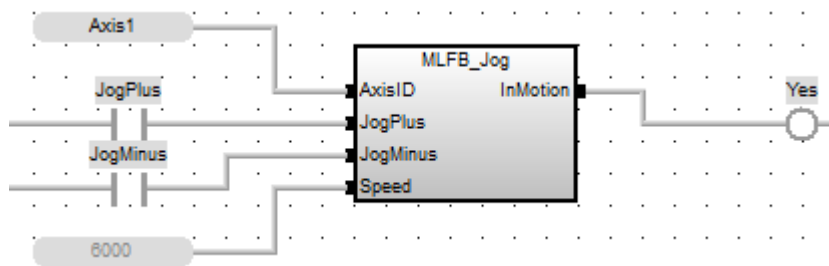

5.2.7.11 MLFB_PIsPosFw Pipe Network ✓

5.2.7.12.1 Description

This function block should be used in the command position path with ascending position. A dedicated comparator pipe block is needed. The Boolean output oPLS is set to TRUE if the position of the comparator has crossed the start position and is set to FALSE if the position has crossed the end position. The function block is executed cyclically. The modulo position is considered. The function block has the possibility to compensate a delay time of the connected device, e.g. glue nozzles.

5.2.7.13.2 Arguments

5.2.7.14.3.1 Input

ibExecute	Description Data type	Enable PLS BOOL
iDedicatedCmpID	Description Data type	ID of dedicated comparator DINT
iStartPos	Description Data type	Start position of PLS LREAL
iEndPos	Description Data type	End position of PLS LREAL
iDelayTime	Description Data type	Delay time for compensation TIME
ibForce	Description Data type	Force PLS BOOL

5.2.7.15.4.2 Output

oPLS	Description Data type	Position limit switch BOOL
------	--------------------------	-------------------------------

5.2.7.16.5 Example

5.2.7.17.6 Timing

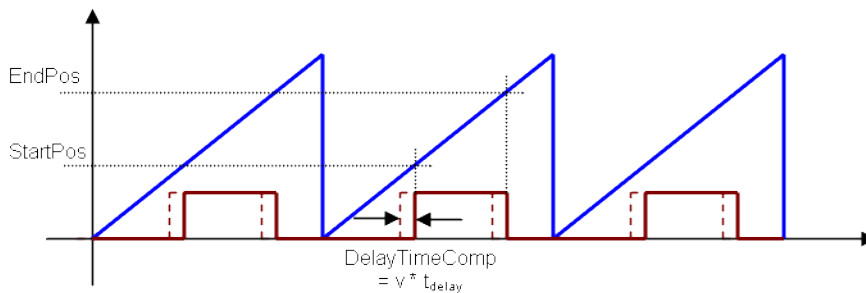

5.2.7.18.7.1 ST

```
//PLSOutput is True when chosen comparator is between 180 and
//270 with a T#2ms delay
//Can also force the output to be true with ForceOutput variable
Inst_MLFB_PlsPosFw( EnablePLS, PipeNetwork.COMPARATOR, 180, 270,
T#2ms, ForceOutput );
PLSOutput := Inst_MLFB_PlsPosFw.oPLS;
```

5.2.7.19.8.2 FBD

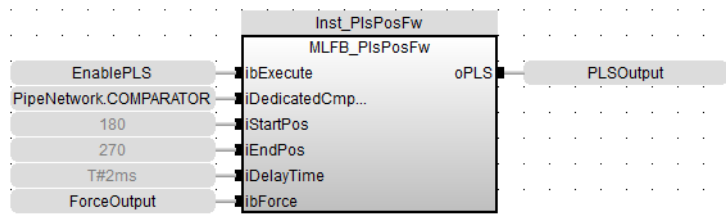

5.2.7.20.9.3 FFLD

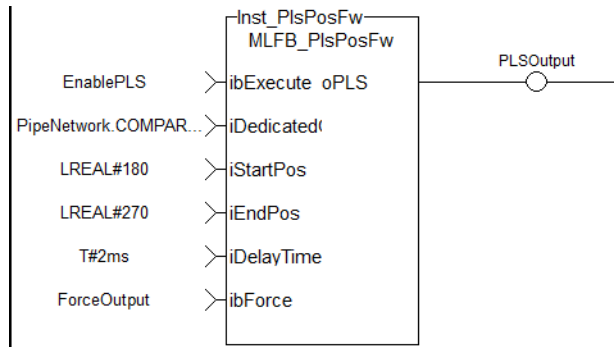

5.2.7.21 MLFB_PlsPosFwBw Pipe Network ✓

5.2.7.22.1 Description

This function block can be used in the command or actual position path, e.g. sampler pipe with noisy position, in both directions. Any modulo pipe block is needed, which can also be used for another instance of this UDFB. The Boolean output oPLS is set to TRUE if the position of the comparator has crossed the start position and is set to FALSE if the position has crossed the end position. The function block is executed cyclically. The modulo position is considered. The function block has the possibility to compensate a delay time of the connected device, e.g. glue nozzles. It is also possible to define a hysteresis for switching on and off of the PLS.

5.2.7.23.2 Arguments

5.2.7.24.3.1 Input

ibExecute	Description	Enable PLS
	Data type	BOOL
iAnyModuloBlkID	Description	Any modulo pipe network block ID
	Data type	DINT
iStartPos	Description	Start position of PLS
	Data type	LREAL
iEndPos	Description	End position of PLS
	Data type	LREAL
iDelayTime	Description	Delay time for compensation
	Data type	TIME
iHysteresis	Description	Hysteresis
	Data type	LREAL
ibForce	Description	Force PLS
	Data type	BOOL

5.2.7.25.4.2 Output

oPLS	Description	Position limit switch
------	-------------	-----------------------

Data type BOOL

5.2.7.26.5 Example

5.2.7.27.6 Timing

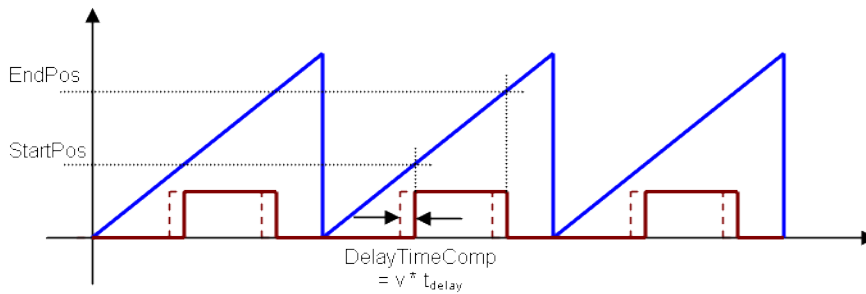

5.2.7.28.7 Hysteresis

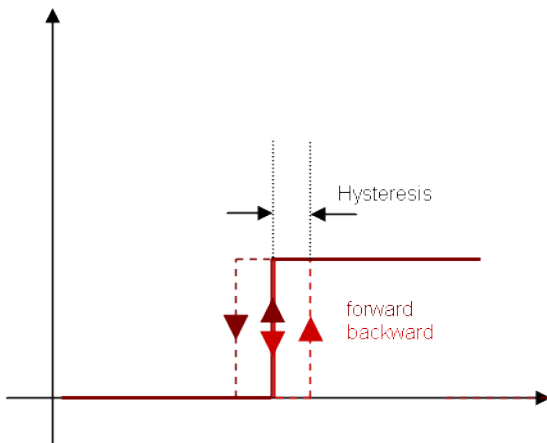

5.2.7.29.8.1 ST

```
//PLSOutput is True when chosen comparator is between 180 and
//270 with a T#2ms delay
//Can also force the output to be true with ForceOutput variable
//Hysteresis is on for 3 user units in case direction changes
//around start point
Inst_MLFB_PlsPosFwBw( EnablePLS, PipeNetwork.COMPARATOR, 180,
270, T#2ms, 3, ForceOutput );
PLSOutput := Inst_MLFB_PlsPosFwBW.oPLS;
```

5.2.7.30.9.2 FBD

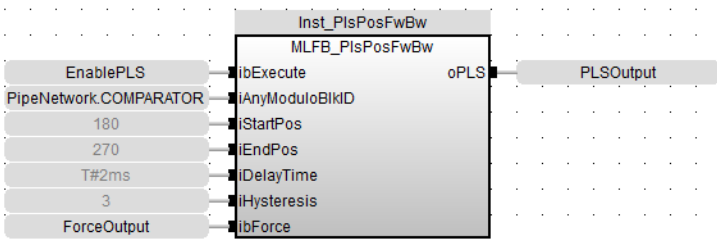

5.2.7.31.10.3 FFLD

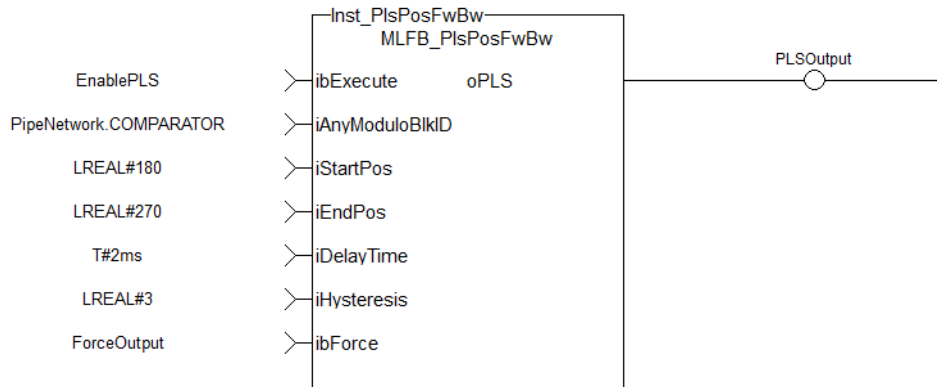

5.2.7.32 MLFB_PlsTimeFw Pipe Network ✓

5.2.7.33.1 Description

This function block should be used in the command position path with ascending position. A dedicated comparator pipe block is needed. The Boolean output oPLS is set to TRUE if the position of the comparator has crossed the start position and a timer with iOnTime is started. When the timer has expired the output is set to FALSE. The function block is executed cyclically. The modulo position is considered. The function block has the possibility to compensate a delay time of the connected device, e.g. glue nozzles.

5.2.7.34.2 Arguments

5.2.7.35.3.1 Input

ibExecute	Description Data type	Enable PLS BOOL
iDedicatedCmpID	Description Data type	ID of dedicated comparator DINT
iStartPos	Description Data type	Start position of PLS LREAL
iOnTime	Description Data type	Time PLS is on TIME
iDelayTime	Description Data type	Delay time for compensation TIME
ibForce	Description Data type	Force PLS BOOL

5.2.7.36.4.2 Output

oPLS	Description Data type	Position limit switch BOOL
------	--------------------------	-------------------------------

5.2.7.37.5 Example

5.2.7.38.6 Timing

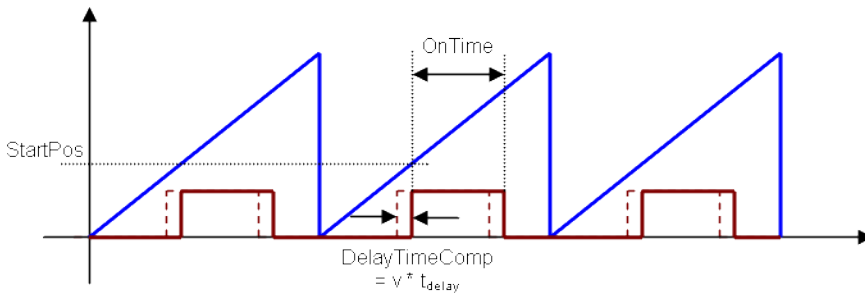

5.2.7.39.7.1 ST

```
//PLSOutput is True when chosen comparator passes 180 for 3
seconds a T#2ms delay
//Can also force the output to be true with ForceOutput variable
Inst_MLFB_PlsTimeFw( EnablePLS, PipeNetwork.COMPARATOR, 180,
T#3s, T#2ms, ForceOutput );
PLSOutput := Inst_MLFB_PlsTimeFw.oPLS;
```

5.2.7.40.8.2 FBD

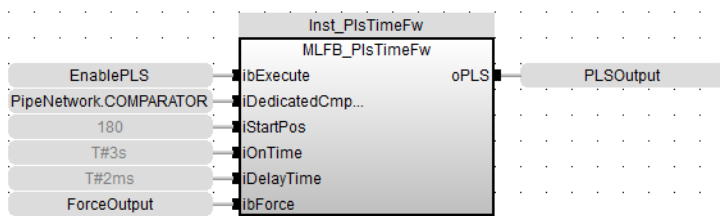

5.2.7.41.9.3 FFLD

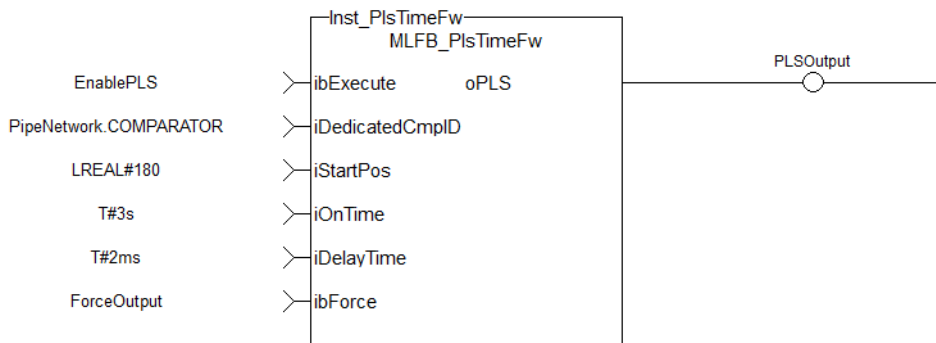

5.2.7.42 MCFB_StepAbsolutes PLCopen ✓

5.2.7.43.1 Description

This function block performs a static homing function by setting Actual Position to the position of an absolute encoder. No physical motion is performed in this mode. Equivalent to MC_SetPosition is performed with SetPosition coming from absolute encoder reading, but with the option of using the once per rev feedback value.

The following figure shows the function block I/O:

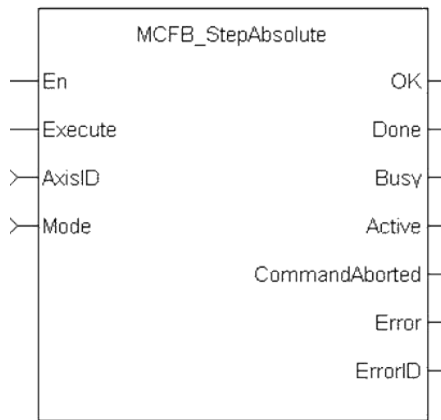

Figure 1-140: MCFB StepAbsolute

5.2.7.44.2 Arguments

5.2.7.45.3.1 Input

En	Description	Enables execution (FFLD only)						
	Data type	BOOL						
	Range	—						
	Unit	n/a						
	Default	—						
Execute	Description	Request the homing step procedure at rising edge						
	Data type	BOOL						
	Range	[0 , 1]						
	Unit	n/a						
	Default	—						
AxisID	Description	Name of a declared instance of the AXIS_REF library function						
	Data type	AXIS_REF						
	Range	[1 , 256]						
	Unit	n/a						
	Default	—						
Mode	Description	Define the actual position assignment source						
		<table border="1"> <thead> <tr> <th>Value</th> <th>Description</th> </tr> </thead> <tbody> <tr> <td>0</td> <td>use drive feedback position for actual position</td> </tr> <tr> <td>1</td> <td>use once per rev feedback position</td> </tr> </tbody> </table>	Value	Description	0	use drive feedback position for actual position	1	use once per rev feedback position
	Value	Description						
0	use drive feedback position for actual position							
1	use once per rev feedback position							
Data type	BOOL							

Range	[0 , 1]
Unit	n/a
Default	—

5.2.7.46.4.2 Output

Done	Description	Indicates the move completed successfully. The Command Position has reached the endpoint
	Data type	BOOL
	Unit	n/a
Busy	Description	High from the moment the Execute input is one-shot to the time the move is ended
	Data type	BOOL
	Unit	n/a
Active	Description	Indicates this move is the active move
	Data type	BOOL
	Unit	n/a
CommandAborted	Description	Indicates the move was aborted
	Data type	BOOL
	Unit	n/a
Error	Description	Indicates an invalid input was specified or the move was terminated due to an error
	Data type	BOOL
	Unit	n/a
Error	Description	Indicates an invalid input was specified or the move was terminated due to an error
	Data type	BOOL
	Unit	n/a
ErrorID	Description	Indicates the error if Error output is set to TRUE
	Value	Description
	1	Desired SetPosition is outside of Rollover period
	Data type	INT
	Unit	n/a

5.2.7.47.5 Related Functions

[MCFB_StepAbsSwitch](#)

[MCFB_StepRefPulse](#)

[MCFB_StepBlock](#)

[MCFB_StepLimitSwitch](#)

5.2.7.48.6 Example

5.2.7.49.7.1 Structured Text

```
//Write current once per rev feedback position to overall axis
position
MCFB_StepAbsolute( ExecuteHome, Axis1, ModeHome );
```

5.2.7.50.8.2 Ladder Diagram

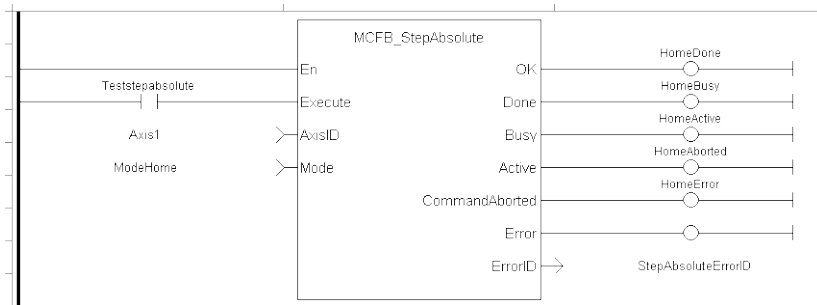

5.2.7.51.9.3 Function Block Diagram

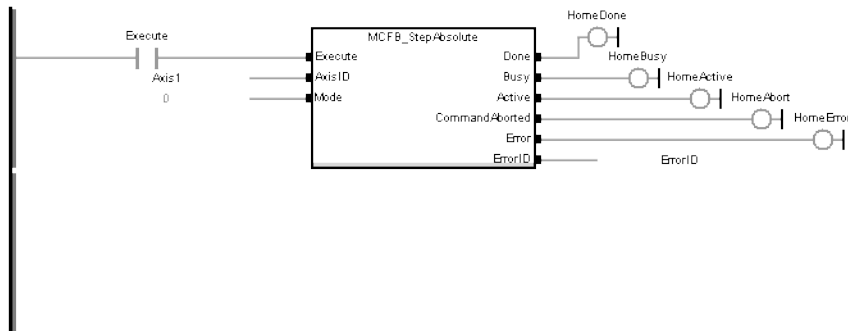

5.2.7.52 MCFB_StepAbsSwitch PLCopen ✓

5.2.7.53.1 Description

This function block performs a homing function by searching for an absolute positioned external physical switch. (An Absolute Switch has two "Off" (or "On") areas.

The following figure shows the function block I/O:

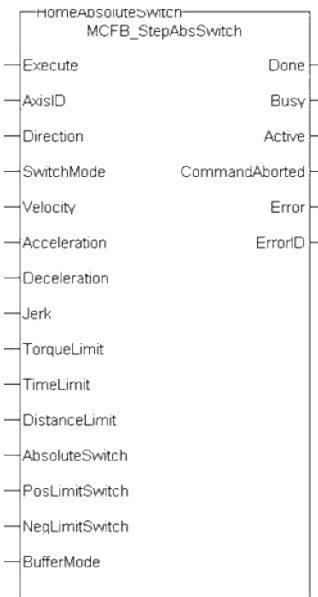

Figure 1-141: MCFB StepAbsSwitch

5.2.7.54.2 Arguments

5.2.7.55.3.1 Input

Execute	Description	Request the homing step procedure at rising edge. Outputs are reset when execute input is false.										
	Data type	BOOL										
	Range	[0 , 1]										
	Unit	n/a										
	Default	—										
AxisID	Description	Name of a declared instance of the AXIS_REF library function										
	Data type	AXIS_REF										
	Range	[1 , 256]										
	Unit	n/a										
	Default	—										
Direction	Description	Define the axis homing direction										
		<table border="1"> <thead> <tr> <th>Value</th> <th>Description</th> </tr> </thead> <tbody> <tr> <td>0</td> <td>clockwise rotation</td> </tr> <tr> <td>1</td> <td>counterclockwise rotation</td> </tr> <tr> <td>2</td> <td>clockwise if AbsoluteSwitch starts Off and negative if switch starts On</td> </tr> <tr> <td>3</td> <td>counter clockwise if AbsoluteSwitch starts On and positive if switch starts Off</td> </tr> </tbody> </table>	Value	Description	0	clockwise rotation	1	counterclockwise rotation	2	clockwise if AbsoluteSwitch starts Off and negative if switch starts On	3	counter clockwise if AbsoluteSwitch starts On and positive if switch starts Off
Value	Description											
0	clockwise rotation											
1	counterclockwise rotation											
2	clockwise if AbsoluteSwitch starts Off and negative if switch starts On											
3	counter clockwise if AbsoluteSwitch starts On and positive if switch starts Off											

	Data type	DINT										
	Range	[0 , 3]										
	Unit	n/a										
	Default	—										
SwitchMode	Description	Switch state to complete homing										
		<table border="1"> <thead> <tr> <th>Value</th> <th>Description</th> </tr> </thead> <tbody> <tr> <td>0</td> <td>switch is on</td> </tr> <tr> <td>1</td> <td>switch if off</td> </tr> <tr> <td>2</td> <td>rising edge of switch</td> </tr> <tr> <td>3</td> <td>falling edge of switch</td> </tr> </tbody> </table>	Value	Description	0	switch is on	1	switch if off	2	rising edge of switch	3	falling edge of switch
Value	Description											
0	switch is on											
1	switch if off											
2	rising edge of switch											
3	falling edge of switch											
	Data type	DINT										
	Range	[0 , 3]										
	Unit	n/a										
	Default	—										
Velocity	Description	Commanded velocity for the homing move										
	Data type	LREAL										
	Range	—										
	Unit	User unit/sec										
	Default	—										
Acceleration	Description	Commanded acceleration for the homing move										
	Data type	LREAL										
	Range	—										
	Unit	User unit/sec ²										
	Default	—										
Deceleration	Description	Commanded deceleration for the homing move										
	Data type	LREAL										
	Range	—										
	Unit	User unit/sec ²										
	Default	—										
Jerk	Description	Commanded jerk for the homing move (if zero, then trapezoidal acc/dec is used)										

	Data type	LREAL
	Range	—
	Unit	User unit/sec ³
	Default	—
TorqueLimit	Description	Maximum torque applied for the homing move entered in thousandths of maximum torque, e.g. "250" is 250/1000, or 25%.
	Data type	LREAL
	Range	—
	Unit	User unit
	Default	—
TimeLimit	Description	Maximum time for homing move to complete. If exceeded the homing procedure will error out. 0= no time limit
	Data type	TIME
	Range	—
	Unit	sec
	Default	—
DistanceLimit	Description	Maximum distance for homing move to complete. If exceeded the homing procedure will error out. 0= no distance limit
	Data type	LREAL
	Range	—
	Unit	User unit
	Default	—
AbsoluteSwitch	Description	The absolute switch input I/O point
	Data type	BOOL
	Range	[0, 1]
	Unit	n/a
	Default	—
PosLimitSwitch	Description	The positive direction limit switch input I/O point
	Data type	BOOL
	Range	[0, 1]

	Unit	n/a														
	Default	—														
NegLimitSwitch	Description	The negative direction limit switch input I/O point														
	Data type	BOOL														
	Range	[0 , 1]														
	Unit	n/a														
	Default	—														
SwitchMode	Description	Switch state to complete homing														
		<table border="1"> <thead> <tr> <th>Value</th> <th>Description</th> </tr> </thead> <tbody> <tr> <td>0</td> <td>abort</td> </tr> <tr> <td>1</td> <td>buffer</td> </tr> <tr> <td>2</td> <td>Blend to active</td> </tr> <tr> <td>3</td> <td>blend to next</td> </tr> <tr> <td>4</td> <td>blend to low velocity</td> </tr> <tr> <td>5</td> <td>blend to high velocity</td> </tr> </tbody> </table>	Value	Description	0	abort	1	buffer	2	Blend to active	3	blend to next	4	blend to low velocity	5	blend to high velocity
Value	Description															
0	abort															
1	buffer															
2	Blend to active															
3	blend to next															
4	blend to low velocity															
5	blend to high velocity															
	Data type	SINT														
	Range	[0 , 5]														
	Unit	n/a														
	Default	—														

5.2.7.56.4.2 Output

Done	Description	Indicates the move completed successfully. The Command Position has reached the endpoint
	Data type	BOOL
	Unit	n/a
Busy	Description	High from the moment the Execute input is one-shot to the time the move is ended
	Data type	BOOL
	Unit	n/a
Active	Description	Indicates this move is the active move
	Data type	BOOL
	Unit	n/a
CommandAborted	Description	Indicates the move was aborted

	Data type	BOOL
	Unit	n/a
Error	Description	Indicates an invalid input was specified or the move was terminated due to an error
	Data type	BOOL
	Unit	n/a
ErrorID	Description	Indicates the error if Error output is set to TRUE
	Value	Description
	1	TimeLimit exceeded
	2	DistanceLimit exceeded
	3	TorqueLimit exceeded
	4	axis error stop state
	5	axis not enabled
	6	invalid inputs for Velocity-Acceleration-Deceleration
	Data type	INT
	Unit	n/a

5.2.7.57.5 Usage

This physical layout has the risk that homing is started in the wrong direction (escaping the switch). To support such case, it implements a special behavior when Limit Switches are found (or the AbsSwitch itself is "On" at Execute):

- The homing is commanded in the most likely direction were the sensor can be found. In this example (-).
- The velocity is defined by the input.
- The torque is limited.
- Both Time and Distance Limits can cause an error if exceeded
- If any LimitSwitch is found during Homing (any of them), then a special process is started in the opposite direction, the AbsSwitch is searched to switch off (or On, depending on SwitchMode setting). The Edge (passed by), and homing process is restarted in the original direction and with the same conditions. This ensures that the end conditions are always same
- If the SwitchMode is either MC_SwitchNegative or MC_SwitchPositive, then the special process is also started in opposite direction depending from the switch state at 'execute'.
- The direction changes only when the specified Velocity is reached (InVelocity).
- This Function Block doesn't modify the actual position

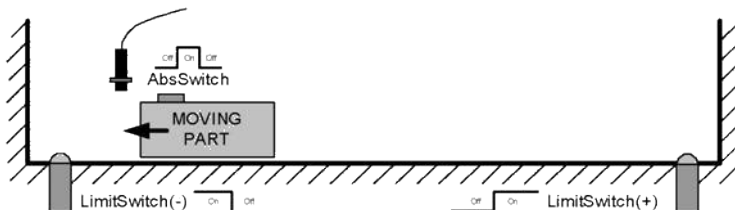

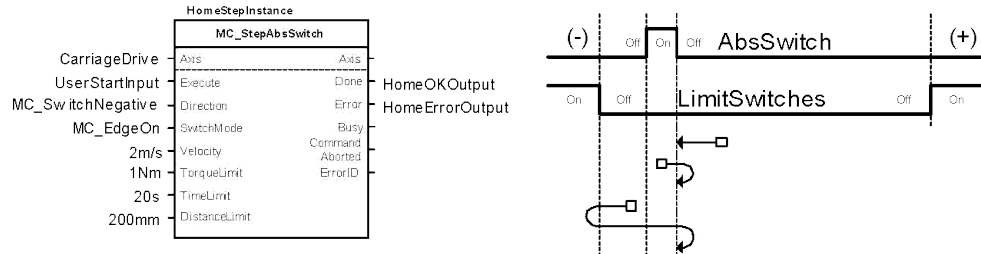
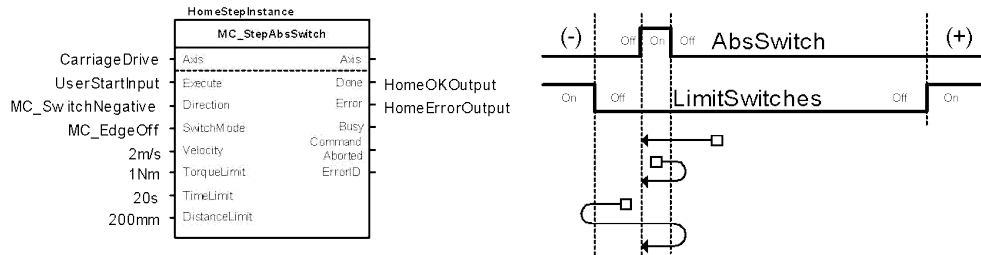

An overlapping switch configuration is also possible. This has same the behavior as working on the limit switches:

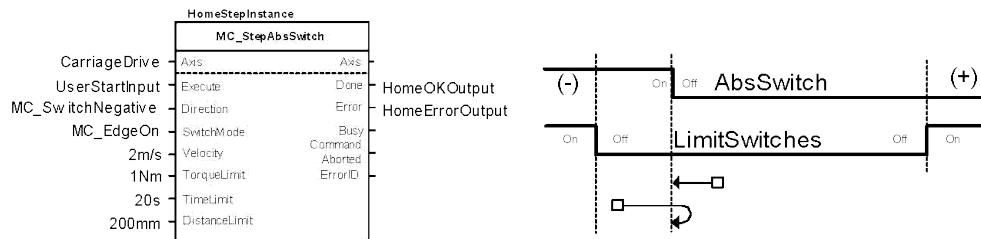

If the input Direction is set to a fixed direction (MC_Positive or MC_Negative), then the initial switch state is ignored (used for example in rotary axis where only one sense of rotation is allowed):

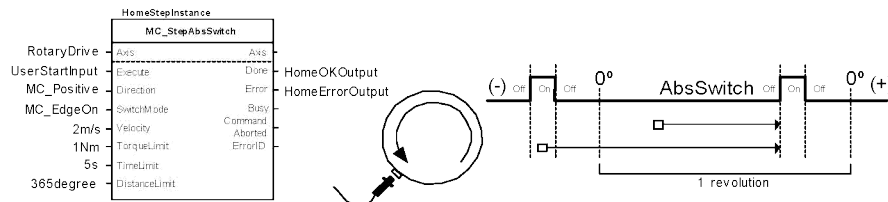

5.2.7.58.6 Related Functions

[MCFB_StepAbsolute](#)

[MCFB_StepRefPulse](#)

[MCFB_StepBlock](#)

[MCFB_StepLimitSwitch](#)

5.2.7.59.7 Example

5.2.7.60.8.1 Structured Text

```

NegativeDirection :=1;
RisingEdge :=2;
Velocity :=10000.0;
TorqueLimit :=50.0;
TimeLimit :=T#10s;
DistanceLimit :=10000.0;

Inst_MCFB_StepAbsSwitch( True, Axis1, NegativeDirection,
RisingEdge, Velocity, 1000, 1000, 0, TorqueLimit, TimeLimit,
DistanceLimit, AbsoluteSwitch, PosLimitSwitch, NegLimitSwitch,
0 );

HomeComplete :=Inst_MCFB_StepAbsSwitch.Done;
HomeBusy :=Inst_MCFB_StepAbsSwitch.Busy;
HomeActive :=Inst_MCFB_StepAbsSwitch.Active;
HomeAborted :=Inst_MCFB_StepAbsSwitch.CommandAborted;
HomeError :=Inst_MCFB_StepAbsSwitch.Error;
HomeErrorID :=Inst_MCFB_StepAbsSwitch.ErrorID;

(* AbsoluteSwitch, PosLimitSwitch, NegLimitSwitch are declared
I/O points *)

```

5.2.7.61.9.2 Ladder Diagram

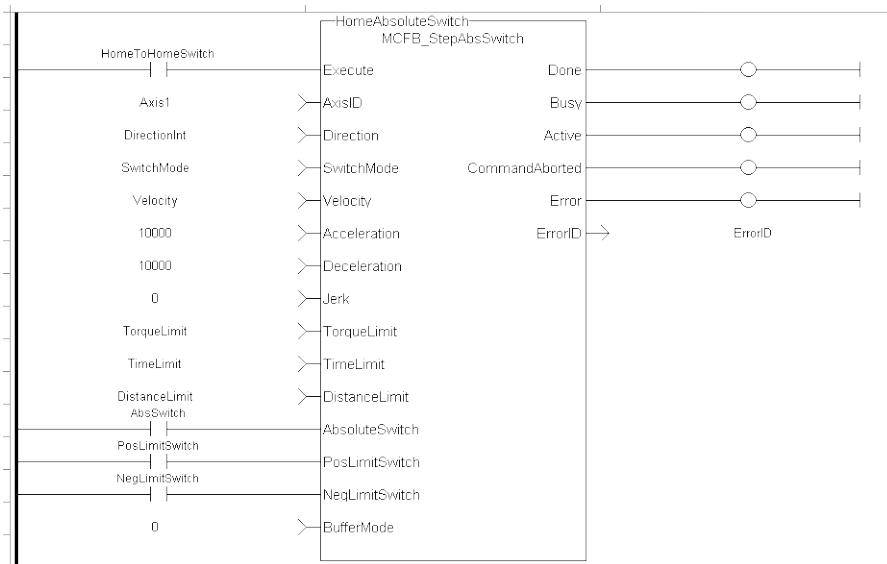

5.2.7.62.10.3 Function Block Diagram

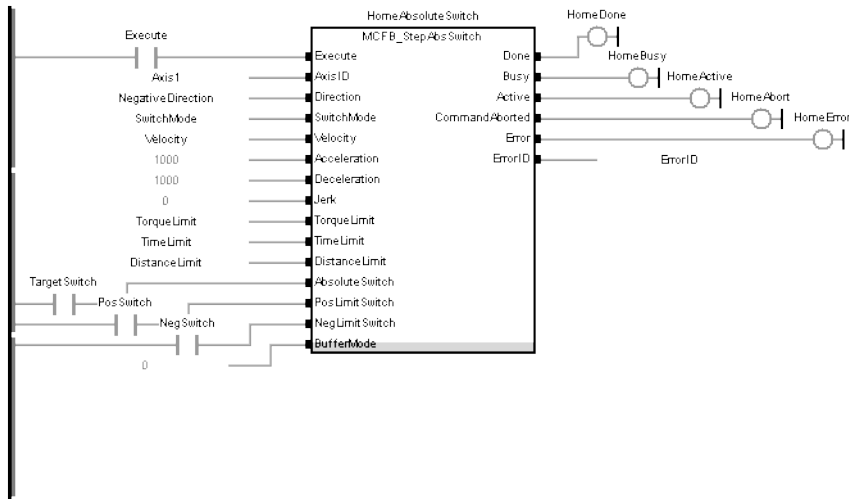

5.2.7.63 MCFB_StepBlock PLCopen

5.2.7.64.1 Description

This function block performs homing against a physical object, mechanically blocking the movement. In this mode there is no limit switch or Reference Pulse. Adequate torque limits are required for not damaging mechanics during homing process. The StepBlock condition is that we have reached the torque limit and real velocity falls below 5% of demanded.

The following figure shows the function block I/O:

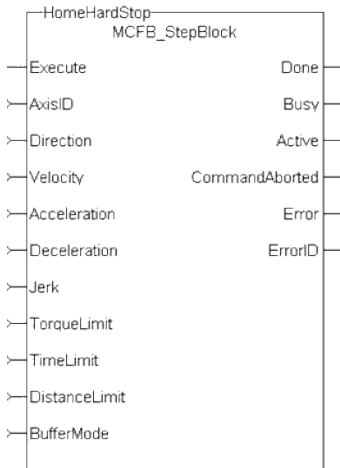

Figure 1-142: MCFB StepBlock

5.2.7.65.2 Arguments

5.2.7.66.3.1 Input

Execute	Description
	Request the homing step procedure at rising edge. Outputs are reset when execute input is false.
	Data type BOOL
	Range [0, 1]
	Unit n/a
	Default —

AxisID	Description	Name of a declared instance of the AXIS_REF library function						
	Data type	AXIS_REF						
	Range	[1 , 256]						
	Unit	n/a						
	Default	—						
Direction	Define the axis homing direction							
	Description	<table border="1"> <thead> <tr> <th>Value</th> <th>Description</th> </tr> </thead> <tbody> <tr> <td>0</td> <td>clockwise rotation</td> </tr> <tr> <td>1</td> <td>counterclockwise rotation</td> </tr> </tbody> </table>	Value	Description	0	clockwise rotation	1	counterclockwise rotation
	Value	Description						
	0	clockwise rotation						
	1	counterclockwise rotation						
Data type	BOOL							
Range	[0 , 1]							
Unit	n/a							
Velocity	Description	Commanded velocity for the homing move						
	Data type	LREAL						
	Range	—						
	Unit	User unit/sec						
	Default	—						
Acceleration	Description	Commanded acceleration for the homing move						
	Data type	LREAL						
	Range	—						
	Unit	User unit/sec ²						
	Default	—						
Deceleration	Description	Commanded deceleration for the homing move						
	Data type	LREAL						
	Range	—						
	Unit	User unit/sec ²						
	Default	—						
Jerk	Description	Commanded jerk for the homing move (if zero, then trapezoidal acc/dec is used)						
	Data type	LREAL						
	Range	—						
	Unit	User unit/sec ³						
	Default	—						
TorqueLimit	Description	Maximum torque applied for the homing move entered in thousandths of maximum torque, e.g. "250" is 250/1000, or 25%.						
	Data type	LREAL						
	Range	—						
	Unit	User unit						
	Default	—						
TimeLimit	Description	Maximum time for homing move to complete. If exceeded the homing procedure will error out. 0= no time limit						
	Data type	TIME						
	Range	—						
	Unit	sec						
	Default	—						
DistanceLimit	Description	Maximum distance for homing move to complete. If exceeded the homing procedure will error out. 0= no distance limit						

Data type LREAL
 Range —
 Unit User unit
 Default —

Define the homing move start action

BufferMode

Description

Value	Description
0	abort
1	buffer
2	Blend to active
3	blend to next
4	blend to low velocity
5	blend to high velocity

Data type SINT
 Range [0 , 5]
 Unit n/a
 Default —

5.2.7.67.4.2 Output

Done

Description

Indicates the move completed successfully.
 The Command Position has reached the endpoint

Data type BOOL
 Unit n/a

Busy

Description

High from the moment the Execute input is one-shot to the time the move is ended

Data type BOOL
 Unit n/a

Active

Description

Indicates this move is the active move

Data type BOOL
 Unit n/a

CommandAborted

Description

Indicates the move was aborted

Data type BOOL
 Unit n/a

Error

Description

Indicates an invalid input was specified or the move was terminated due to an error

Data type BOOL
 Unit n/a

Indicates the error if Error output is set to TRUE

ErrorID

Description

Value	Description
1	TimeLimit exceeded
2	DistanceLimit exceeded
3	
4	axis error stop state
5	axis not enabled
6	invalid inputs for Velocity-Acceleration-Deceleration

Data type INT
 Unit n/a

5.2.7.68.5 Usage

Homing against a physical object, mechanically blocking the movement require adequate torque limits for not damaging mechanics during homing process. The StepBlock condition is that we have reached the torque limit and real velocity falls below 5% of demanded.

- Home is commanded by user in the desired homing direction at the selected Velocity
- Torque is limited.
- Time and Distance Limits can cause error if exceeded
- Process is finished when Torque is in limit condition and real velocity is below 5% of selected velocity.
- This Function Block doesn't modify actual position

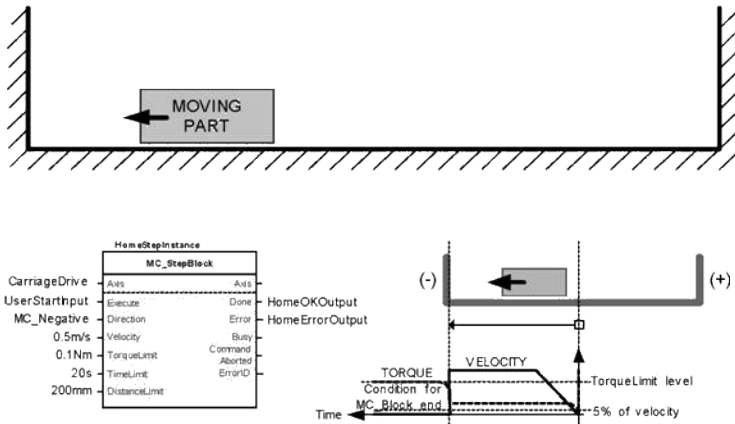

5.2.7.69.6 Related Functions

- [MCFB_StepAbsolute](#)
- [MCFB_StepRefPulse](#)
- [MCFB_StepAbsSwitch](#)
- [MCFB_StepLimitSwitch](#)

5.2.7.70.7 Example

5.2.7.71.8.1 Structured Text

```

PositiveDirection :=0;
Velocity :=10000.0;
TorqueLimit :=50.0;
TimeLimit :=T#10s;
DistanceLimit :=10000.0;
    
```

```

Inst_MCFB_StepBlock( True, Axis1, PositiveDirection, Velocity,
1000, 1000, 0, TorqueLimit, TimeLimit, DistanceLimit, 0 );
    
```

```

HomeComplete :=Inst_MCFB_StepBlock.Done;
HomeBusy :=Inst_MCFB_StepBlock.Busy;
HomeActive :=Inst_MCFB_StepBlock.Active;
HomeAborted :=Inst_MCFB_StepBlock.CommandAborted;
HomeError :=Inst_MCFB_StepBlock.Error;
HomeErrorID :=Inst_MCFB_StepBlock.ErrorID;
    
```

5.2.7.72.9.2 Ladder Diagram

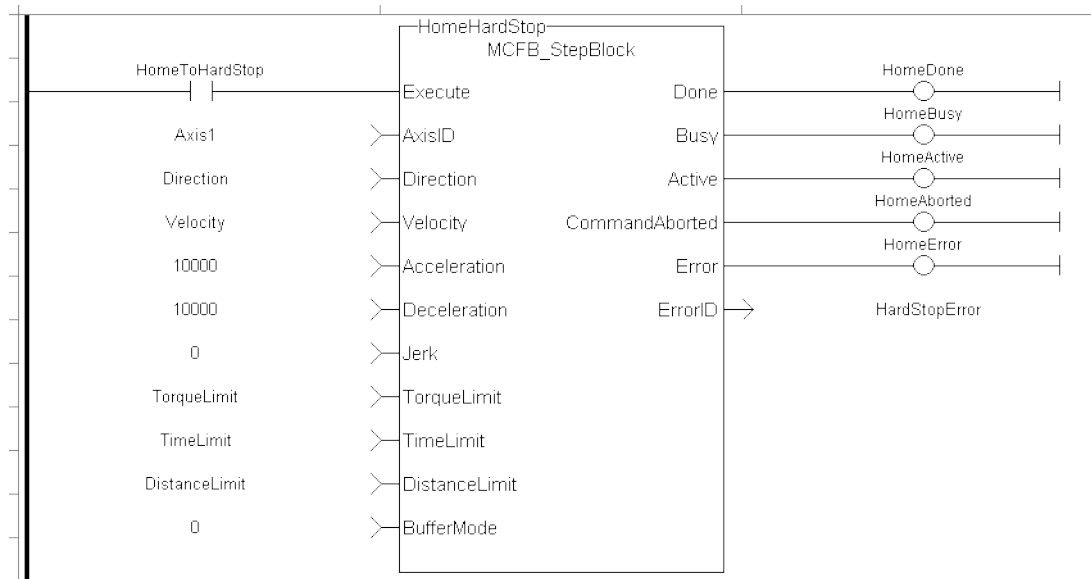

5.2.7.73.10.3 Function Block Diagram

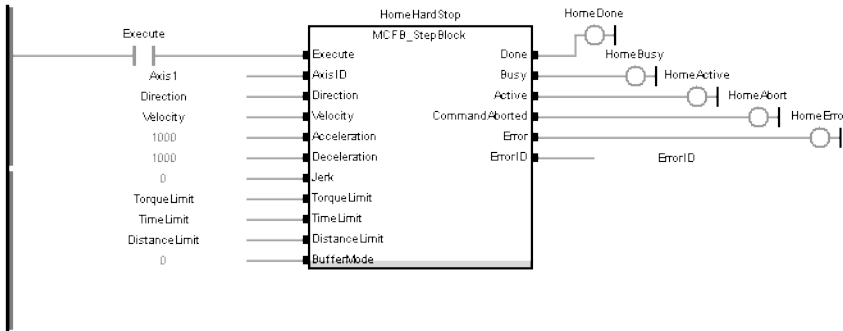

5.2.7.74 MCFB_StepLimitSwitch PLCopen ✓

5.2.7.75.1 Description

This function block performs a single-axis home to a limit switch. In this case the limit switches (always active once moving part working area has been surpassed) are used for homing procedure.

The following figure shows the function block I/O:

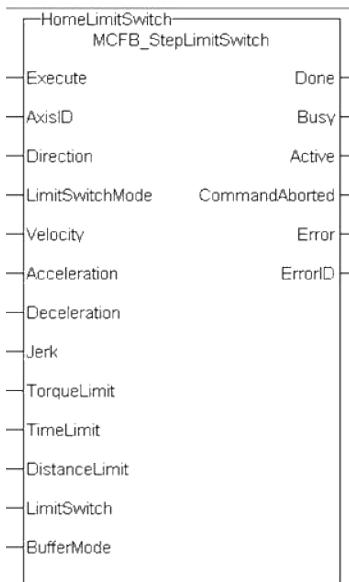

Figure 1-143: MCFB StepLimitSwitch

5.2.7.76.2 Arguments

5.2.7.77.3.1 Input

Execute	Description	Request the homing step procedure at rising edge. Outputs are reset when execute input is false.
	Data type	BOOL
	Range	[0 , 1]
	Unit	n/a
	Default	—
AxisID	Description	Name of a declared instance of the AXIS_REF library function
	Data type	AXIS_REF
	Range	[1 , 256]
	Unit	n/a
	Default	—

Define the axis homing direction												
Direction	Description	<table border="1"> <thead> <tr> <th>Value</th> <th>Description</th> </tr> </thead> <tbody> <tr> <td>0</td> <td>clockwise rotation</td> </tr> <tr> <td>1</td> <td>counterclockwise rotation</td> </tr> </tbody> </table>	Value	Description	0	clockwise rotation	1	counterclockwise rotation				
	Value	Description										
	0	clockwise rotation										
	1	counterclockwise rotation										
	Data type	BOOL										
Range	[0 , 1]											
Unit	n/a											
Default	—											
Limit switch state to complete homing												
LimitSwitchMode	Description	<table border="1"> <thead> <tr> <th>Value</th> <th>Description</th> </tr> </thead> <tbody> <tr> <td>0</td> <td>switch is on</td> </tr> <tr> <td>1</td> <td>switch if off</td> </tr> <tr> <td>2</td> <td>rising edge of switch</td> </tr> <tr> <td>3</td> <td>falling edge of switch</td> </tr> </tbody> </table>	Value	Description	0	switch is on	1	switch if off	2	rising edge of switch	3	falling edge of switch
	Value	Description										
	0	switch is on										
	1	switch if off										
	2	rising edge of switch										
3	falling edge of switch											
Data type	DINT											
Range	[0 , 3]											
Unit	n/a											
Default	—											
Velocity	Description	Commanded velocity for the homing move										
	Data type	LREAL										
	Range	—										
	Unit	User unit/sec										
	Default	—										
Acceleration	Description	Commanded acceleration for the homing move										
	Data type	LREAL										
	Range	—										
	Unit	User unit/sec ²										
	Default	—										
Deceleration	Description	Commanded deceleration for the homing move										
	Data type	LREAL										
	Range	—										
	Unit	User unit/sec ²										
	Default	—										
Jerk	Description	Commanded jerk for the homing move (if zero, then trapezoidal acc/dec is used)										
	Data type	LREAL										
	Range	—										
	Unit	User unit/sec ³										
	Default	—										
TorqueLimit	Description	Maximum torque applied for the homing move entered in thousandths of maximum torque, e.g. "250" is 250/1000, or 25%.										
	Data type	LREAL										
	Range	—										
	Unit	User unit										
	Default	—										

TimeLimit Description Maximum time for homing move to complete. If exceeded the homing procedure will error out. 0= no time limit
 Data type TIME
 Range —
 Unit sec
 Default —

DistanceLimit Description Maximum distance for homing move to complete. If exceeded the homing procedure will error out. 0= no distance limit
 Data type LREAL
 Range —
 Unit User unit
 Default —

LimitSwitch Description The limit switch input I/O point
 Data type BOOL
 Range [0 , 1]
 Unit n/a
 Default —

Define the homing move start action

BufferMode Description

Value	Description
0	abort
1	buffer
2	Blend to active
3	blend to next
4	blend to low velocity
5	blend to high velocity

 Data type SINT
 Range [0 , 5]
 Unit n/a
 Default —

5.2.7.78.4.2 Output

Done Description Indicates the move completed successfully.
 The Command Position has reached the endpoint
 Data type BOOL
 Unit n/a

Busy Description High from the moment the Execute input is one-shot to the time the move is ended
 Data type BOOL
 Unit n/a

Active Description Indicates this move is the active move
 Data type BOOL
 Unit n/a

CommandAborted Description Indicates the move was aborted
 Data type BOOL
 Unit n/a

Error Description Indicates an invalid input was specified or the move was terminated due to an error
 Data type BOOL

	Unit	n/a
	Description	Indicates the error if Error output is set to TRUE
ErrorID	Description	Value Description
		1 TimeLimit exceeded
		2 DistanceLimit exceeded
		3 TorqueLimit exceeded
		4 axis error stop state
		5 axis not enabled
6 invalid inputs for Velocity-Acceleration-Deceleration		
	Data type	INT
	Unit	n/a

5.2.7.79.5 Usage

This homing procedure performs a homing function searching for sensor using only LimitSwitches. (A LimitSwitch has 1 "Off" (or "On") area).

- Home is commanded by user in the desired homing direction at the selected Velocity.
- If LimitSwitch is found 'On' on rising 'Execute', then the process is started in the opposite direction as specified, LimitSwitch is search for 'Off' (or On, depending on LimitSwitchMode setting) Edge (released), and process is restarted again in original direction. This ensures that the end conditions are always the same.
- The torque is limited.
- The Time and Distance Limits can cause error if exceeded
- The Direction changes only when the specified Velocity is reached, this ensures acceleration and deceleration spaces are fixed
- This Function Block doesn't modify actual position

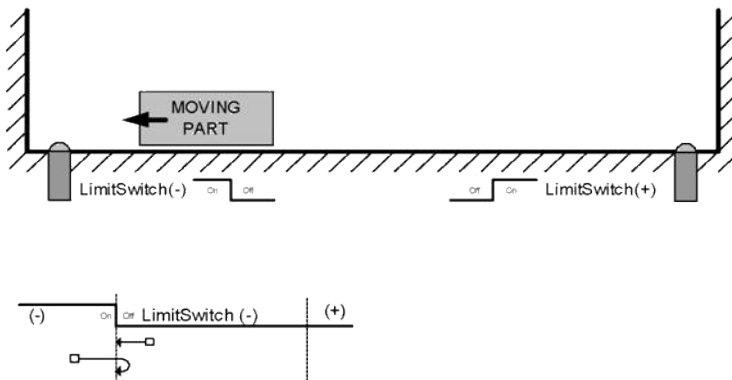

5.2.7.80.6 Related Functions

- [MCFB_StepAbsolute](#)
- [MCFB_StepRefPulse](#)
- [MCFB_StepBlock](#)
- [MCFB_StepAbsSwitch](#)

5.2.7.81.7 Example

5.2.7.82.8.1 Structured Text

```

PositiveDirection :=0;
RisingEdge :=2;
Velocity :=10000.0;
TorqueLimit :=50.0;
TimeLimit :=T#10s;
DistanceLimit :=10000.0;

Inst_MCFB_StepLimitSwitch( True, Axis1, PositiveDirection,
RisingEdge, Velocity, 1000, 1000, 0, TorqueLimit, TimeLimit,
DistanceLimit, LimitSwitch, 0 );

HomeComplete :=Inst_MCFB_StepLimitSwitch.Done;
HomeBusy :=Inst_MCFB_StepLimitSwitch.Busy;
HomeActive :=Inst_MCFB_StepLimitSwitch.Active;
HomeAborted :=Inst_MCFB_StepLimitSwitch.CommandAborted;
HomeError :=Inst_MCFB_StepLimitSwitch.Error;
HomeErrorID :=Inst_MCFB_StepLimitSwitch.ErrorID;

(* LimitSwitch is a declared I/O point *)
    
```

5.2.7.83.9.2 Ladder Diagram

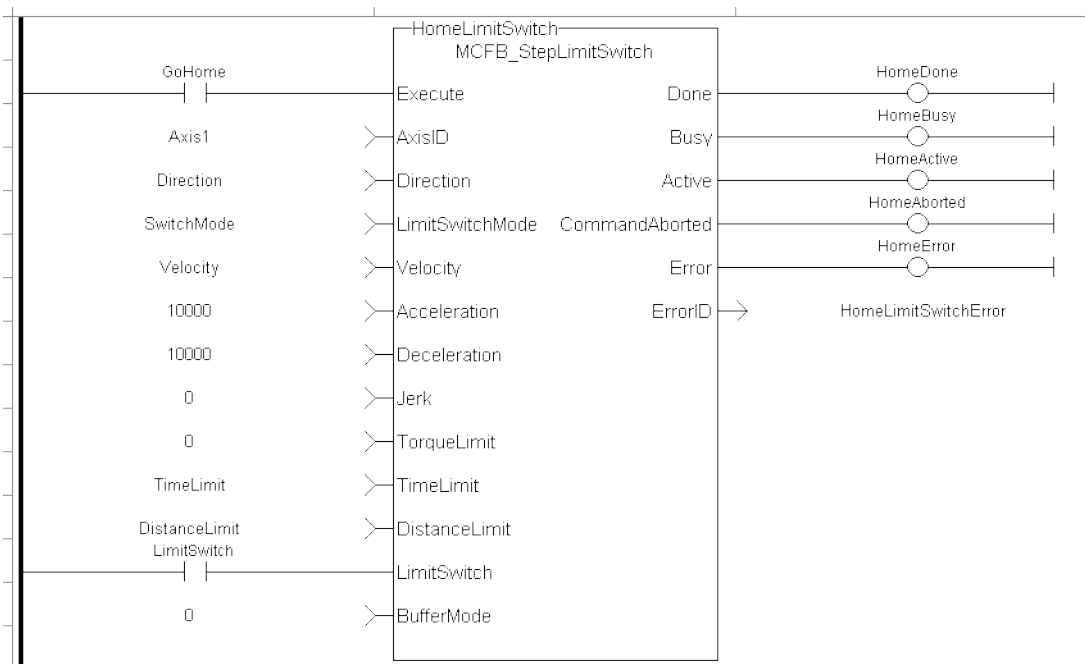

5.2.7.84.10.3 Function Block Diagram

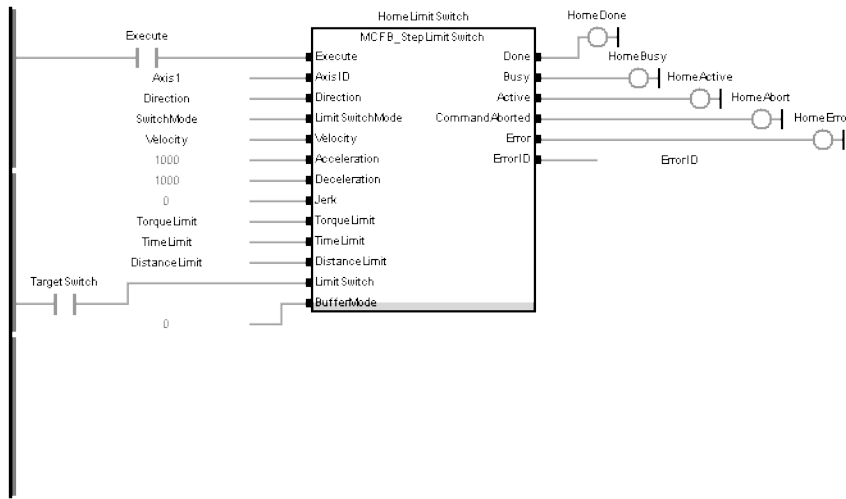

5.2.7.85 MCFB_StepRefPulse PLCopen ✔

5.2.7.86.1 Description

This function block performs homing by searching for Zero pulse (also called Marker or reference pulse) in encoder. The reference pulse appears once per encoder revolution. The advantage in using Reference Pulse for homing is the higher accuracy and precision that can be achieved compared to traditional optical, mechanical or magnetic sensors.

The following figure shows the function block I/O:

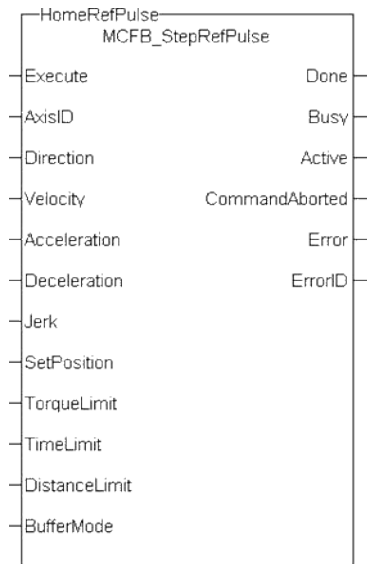

Figure 1-144: MCFB StepRefPulse

5.2.7.87.2 Arguments

5.2.7.88.3.1 Input

Execute	Description	Request the homing step procedure at rising edge										
	Data type	BOOL										
	Range	[0 , 1]										
	Unit	n/a										
	Default	—										
AxisID	Description	Name of a declared instance of the AXIS_REF library function										
	Data type	AXIS_REF										
	Range	[1 , 256]										
	Unit	n/a										
	Default	—										
		Define the axis homing direction										
Direction	Description	<table border="1"> <thead> <tr> <th>Value</th> <th>Description</th> </tr> </thead> <tbody> <tr> <td>0</td> <td>clockwise rotation</td> </tr> <tr> <td>1</td> <td>counterclockwise rotation</td> </tr> </tbody> </table>	Value	Description	0	clockwise rotation	1	counterclockwise rotation				
Value	Description											
0	clockwise rotation											
1	counterclockwise rotation											
	Data type	BOOL										
	Range	[0 , 1]										
	Unit	n/a										
	Default	—										
		Switch state to complete homing										
SwitchMode	Description	<table border="1"> <thead> <tr> <th>Value</th> <th>Description</th> </tr> </thead> <tbody> <tr> <td>0</td> <td>switch is on</td> </tr> <tr> <td>1</td> <td>switch if off</td> </tr> <tr> <td>2</td> <td>rising edge of switch</td> </tr> <tr> <td>3</td> <td>falling edge of switch</td> </tr> </tbody> </table>	Value	Description	0	switch is on	1	switch if off	2	rising edge of switch	3	falling edge of switch
Value	Description											
0	switch is on											
1	switch if off											
2	rising edge of switch											
3	falling edge of switch											
	Data type	DINT										
	Range	[0 , 3]										
	Unit	n/a										
	Default	—										
Velocity	Description	Commanded velocity for the homing move										
	Data type	LREAL										
	Range	—										
	Unit	User unit/sec										
	Default	—										
Acceleration	Description	Commanded acceleration for the homing move										
	Data type	LREAL										
	Range	—										
	Unit	User unit/sec ²										
	Default	—										
Deceleration	Description	Commanded deceleration for the homing move										
	Data type	LREAL										
	Range	—										
	Unit	User unit/sec ²										
	Default	—										
Jerk	Description	Commanded jerk for the homing move (if zero, then trapezoidal acc/dec is used)										
	Data type	LREAL										
	Range	—										

	Unit	User unit/sec ³
	Default	—
SetPosition	Description	Value of the absolute position to be set when the homing move is done
	Data type	LREAL
	Range	—
	Unit	User unit
	Default	—
TorqueLimit	Description	Maximum torque applied for the homing move
	Data type	LREAL
	Range	—
	Unit	User unit
	Default	—
TimeLimit	Description	Maximum time for homing move to complete. If exceeded the homing procedure will error out. 0= no time limit
	Data type	TIME
	Range	—
	Unit	sec
	Default	—
DistanceLimit	Description	Maximum distance for homing move to complete. If exceeded the homing procedure will error out. 0= no distance limit
	Data type	LREAL
	Range	—
	Unit	User unit
	Default	—

Define the homing move start action

		<table border="1"> <thead> <tr> <th>Value</th> <th>Description</th> </tr> </thead> <tbody> <tr> <td>0</td> <td>abort</td> </tr> <tr> <td>1</td> <td>buffer</td> </tr> <tr> <td>2</td> <td>Blend to active</td> </tr> <tr> <td>3</td> <td>blend to next</td> </tr> <tr> <td>4</td> <td>blend to low velocity</td> </tr> <tr> <td>5</td> <td>blend to high velocity</td> </tr> </tbody> </table>	Value	Description	0	abort	1	buffer	2	Blend to active	3	blend to next	4	blend to low velocity	5	blend to high velocity
Value	Description															
0	abort															
1	buffer															
2	Blend to active															
3	blend to next															
4	blend to low velocity															
5	blend to high velocity															
BufferMode	Description															
	Data type	SINT														
	Range	[0 , 5]														
	Unit	n/a														
	Default	—														

5.2.7.89.4.2 Output

Done	Description	Indicates the move completed successfully. The Command Position has reached the endpoint
	Data type	BOOL
	Unit	n/a
Busy	Description	High from the moment the Execute input is one-shot to the time the move is ended
	Data type	BOOL
	Unit	n/a
Active	Description	Indicates this move is the active move

CommandAborted	Data type	BOOL
	Unit	n/a
	Description	Indicates the move was aborted
Error	Data type	BOOL
	Unit	n/a
	Description	Indicates an invalid input was specified or the move was terminated due to an error

Indicates the error if Error output is set to TRUE

ErrorID	Description	Value	Description
		1	TimeLimit exceeded
		2	DistanceLimit exceeded
		3	TorqueLimit exceeded
		4	axis error stop state
		5	axis not enabled
		6	invalid inputs for Velocity-Acceleration-Deceleration
	Data type	INT	
	Unit	n/a	

5.2.7.90.5 Usage

This function Block performs homing by searching for Zero pulse (also called Marker or reference pulse) in encoder. The reference pulse appears once per encoder revolution.

- Home is commanded by user in the desired homing direction at the programmed velocity.
- First occurrence of the Reference Pulse, Homing is finished
- Torque is limited. Time and Distance Limits can cause error if exceeded
- This Function modifies actual position and sets to the "SetPosition" input value at the end

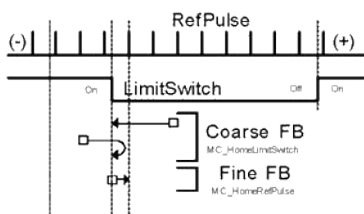
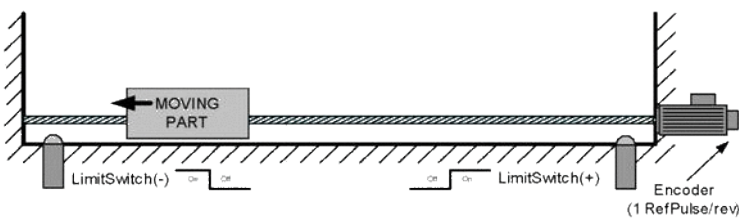

It is common that a first approach is performed against a mechanical sensor at higher velocity, and after a Reference Pulse, at a lower velocity. This is a traditional 2-Step homing (Coarse by external Switch in reverse and Fine by Reference Pulse in forward).

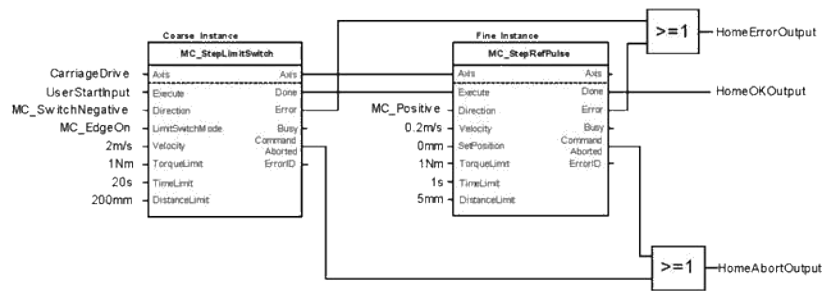

5.2.7.91.6 Related Functions

[MCFB_StepAbsolute](#)

[MCFB_StepAbsSwitch](#)

[MCFB_StepBlock](#)

[MCFB_StepLimitSwitch](#)

5.2.7.92.7 Example

5.2.7.93.8.1 Structured Text

```

PositiveDirection :=0;
Velocity :=10000.0;
SetPosition :=0.0;
TorqueLimit :=50.0;
TimeLimit :=T#10s;
DistanceLimit :=10000.0;

```

```

Inst_MCFB_StepRefPulse( True, Axis1, PositiveDirection,
Velocity, 1000, 1000, 0, SetPosition, TorqueLimit, TimeLimit,
DistanceLimit, 0 );

```

```

HomeComplete :=Inst_MCFB_StepRefPulse.Done;
HomeBusy :=Inst_MCFB_StepRefPulse.Busy;
HomeActive :=Inst_MCFB_StepRefPulse.Active;
HomeAborted :=Inst_MCFB_StepRefPulse.CommandAborted;
HomeError :=Inst_MCFB_StepRefPulse.Error;
HomeErrorID :=Inst_MCFB_StepRefPulse.ErrorID;

```

5.2.7.94.9.2 Ladder Diagram

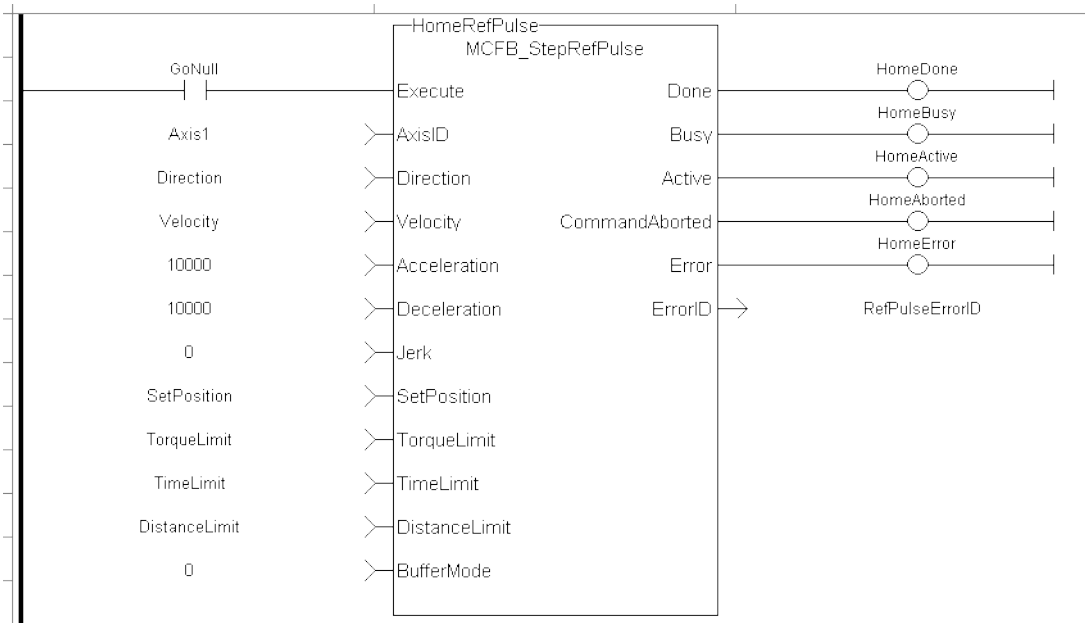

5.2.7.95.10.3 Function Block Diagram

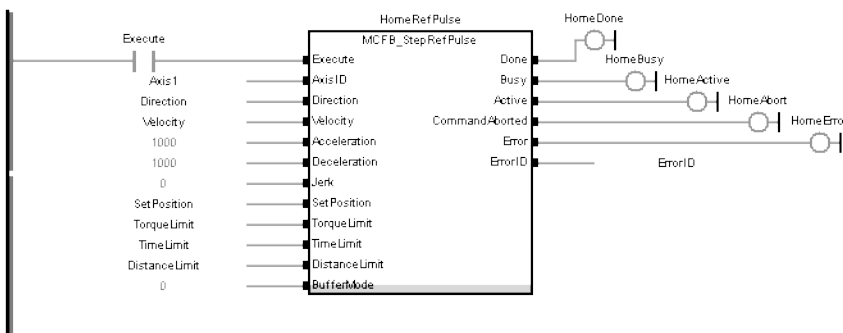

5.2.7.96 MCFB_StepAbsSwitchFastInput PLCopen ✔

5.2.7.97.1 Description

This function block performs a homing function by searching for an absolute positioned external physical switch. The switch must be connected to one of the two fast inputs on the Axis' AKD drive. (An Absolute Switch has two "Off" (or "On") areas.

The following figure shows the function block I/O:

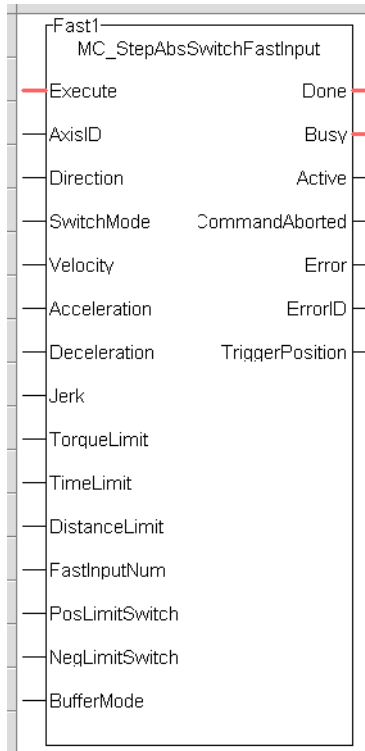

Figure 1-145: MCFB StepAbsSwitchFastInput

5.2.7.98.2.1 Input

Execute	Description	Request the homing step procedure at rising edge. Outputs are reset when execute input is false.						
	Data type	BOOL						
	Range	[0 , 1]						
	Unit	n/a						
	Default	—						
AxisID	Description	Structure for specified Axis desired to home						
	Data type	AXIS_REF						
	Range	[1 , 256]						
	Unit	n/a						
	Default	—						
Direction	Description	Define the axis homing direction						
		<table border="1"> <thead> <tr> <th>Value</th> <th>Description</th> </tr> </thead> <tbody> <tr> <td>0</td> <td>clockwise rotation</td> </tr> <tr> <td>1</td> <td>counterclockwise rotation</td> </tr> </tbody> </table>	Value	Description	0	clockwise rotation	1	counterclockwise rotation
Value	Description							
0	clockwise rotation							
1	counterclockwise rotation							

	Data type	BOOL										
	Range	[0 , 1]										
	Unit	n/a										
	Default	—										
SwitchMode	Description	Switch state to complete homing										
		<table border="1"> <thead> <tr> <th>Value</th> <th>Description</th> </tr> </thead> <tbody> <tr> <td>0</td> <td>when rising edge of sensor</td> </tr> <tr> <td>1</td> <td>when falling edge</td> </tr> <tr> <td>2</td> <td>rising edge when traveling in positive direction but falling edge in negative direction</td> </tr> <tr> <td>3</td> <td>falling edge when traveling in negative direction but rising edge in positive direction</td> </tr> </tbody> </table>	Value	Description	0	when rising edge of sensor	1	when falling edge	2	rising edge when traveling in positive direction but falling edge in negative direction	3	falling edge when traveling in negative direction but rising edge in positive direction
Value	Description											
0	when rising edge of sensor											
1	when falling edge											
2	rising edge when traveling in positive direction but falling edge in negative direction											
3	falling edge when traveling in negative direction but rising edge in positive direction											
	Data type	DINT										
	Range	[0 , 3]										
	Unit	n/a										
	Default	—										
Velocity	Description	Commanded velocity for the homing move										
	Data type	LREAL										
	Range	—										
	Unit	User unit/sec										
	Default	—										
Acceleration	Description	Commanded acceleration for the homing move										
	Data type	LREAL										
	Range	—										
	Unit	User unit/sec ²										
	Default	—										
Deceleration	Description	Commanded deceleration for the homing move										
	Data type	LREAL										
	Range	—										
	Unit	User unit/sec ²										
	Default	—										

Jerk	Description	Commanded jerk for the homing move (if zero, then trapezoidal acc/dec is used)
	Data type	LREAL
	Range	—
	Unit	User unit/sec ³
	Default	—
TorqueLimit	Description	Maximum torque applied for the homing move entered in thousandths of maximum torque, e.g. "250" is 250/1000, or 25%.
	Data type	LREAL
	Range	—
	Unit	User unit
	Default	—
TimeLimit	Description	Maximum time for homing move to complete. If exceeded the homing procedure will error out. 0= no time limit
	Data type	TIME
	Range	—
	Unit	sec
	Default	—
DistanceLimit	Description	Maximum distance for homing move to complete. If exceeded the homing procedure will error out. 0= no distance limit
	Data type	LREAL
	Range	—
	Unit	User unit
	Default	—
FastInputNum	Description	0 for first fast input (X7 Pin 10), 1 for second fast input (X7 pin 9)
	Data type	BOOL
	Range	[0 , 1]
	Unit	n/a
	Default	—
PosLimitSwitch	Description	The positive direction limit switch input I/O point

	Data type	BOOL														
	Range	[0 , 1]														
	Unit	n/a														
	Default	—														
NegLimitSwitch	Description	The negative direction limit switch input I/O point														
	Data type	BOOL														
	Range	[0 , 1]														
	Unit	n/a														
	Default	—														
BufferMode	Description	Define the homing move start action														
		<table border="1"> <thead> <tr> <th>Value</th> <th>Description</th> </tr> </thead> <tbody> <tr> <td>0</td> <td>abort</td> </tr> <tr> <td>1</td> <td>buffer</td> </tr> <tr> <td>2</td> <td>Blend to active</td> </tr> <tr> <td>3</td> <td>blend to next</td> </tr> <tr> <td>4</td> <td>blend to low velocity</td> </tr> <tr> <td>5</td> <td>blend to high velocity</td> </tr> </tbody> </table>	Value	Description	0	abort	1	buffer	2	Blend to active	3	blend to next	4	blend to low velocity	5	blend to high velocity
Value	Description															
0	abort															
1	buffer															
2	Blend to active															
3	blend to next															
4	blend to low velocity															
5	blend to high velocity															
	Data type	SINT														
	Range	[0 , 5]														
	Unit	n/a														
	Default	—														

5.2.7.99.3.2 Output

Done	Description	Indicates the move completed successfully. The Command Position has reached the endpoint
	Data type	BOOL
	Unit	n/a
Busy	Description	High from the moment the Execute input is one-shot to the time the move is ended
	Data type	BOOL
	Unit	n/a
Active	Description	Set when the function block is active
	Data type	BOOL

	Unit	n/a														
CommandAborted	Description	Indicates the move was aborted														
	Data type	BOOL														
	Unit	n/a														
Error	Description	Signals that an error has occurred within the function block														
	Data type	BOOL														
	Unit	n/a														
ErrorID	Description	Indicates the error if Error output is set to TRUE														
		<table border="1"> <thead> <tr> <th>Value</th> <th>Description</th> </tr> </thead> <tbody> <tr> <td>1</td> <td>TimeLimit exceeded</td> </tr> <tr> <td>2</td> <td>DistanceLimit exceeded</td> </tr> <tr> <td>3</td> <td>TorqueLimit exceeded</td> </tr> <tr> <td>4</td> <td>axis error stop state</td> </tr> <tr> <td>5</td> <td>axis not enabled</td> </tr> <tr> <td>6</td> <td>invalid inputs for Velocity-Accel-Decel</td> </tr> </tbody> </table>	Value	Description	1	TimeLimit exceeded	2	DistanceLimit exceeded	3	TorqueLimit exceeded	4	axis error stop state	5	axis not enabled	6	invalid inputs for Velocity-Accel-Decel
Value	Description															
1	TimeLimit exceeded															
2	DistanceLimit exceeded															
3	TorqueLimit exceeded															
4	axis error stop state															
5	axis not enabled															
6	invalid inputs for Velocity-Accel-Decel															
	Data type	INT														
	Unit	n/a														
TriggerPosition	Data type	LREAL														
	Range	-														
	Unit	User units														
	Default	-														

5.2.7.100.4 Usage

- The homing is commanded in the most likely direction were the sensor can be found. In this example (-).
- If any LimitSwitch is found during Homing (any of them), then a special process is started in the opposite direction, the AbsSwitch is searched to switch off (or On, depending on SwitchMode setting). The Edge (passed by), and homing process is restarted in the original direction and with the same conditions. This ensures that the end conditions are always same.

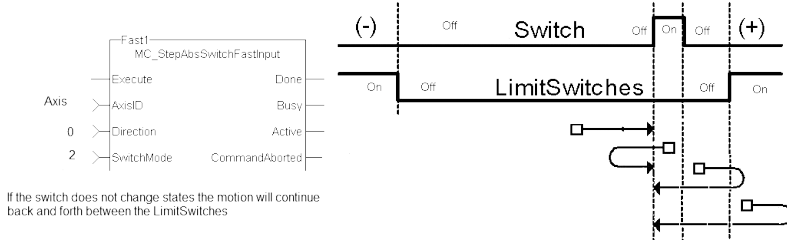
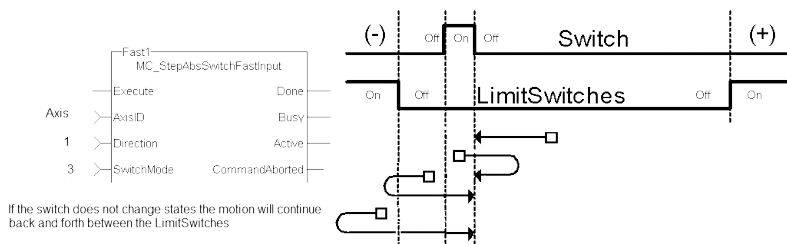
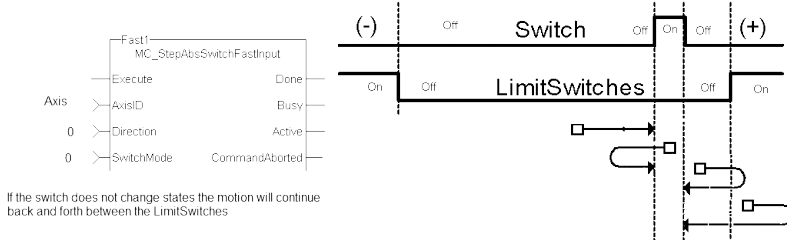
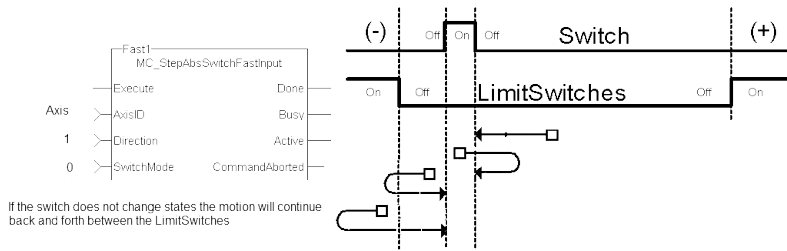

5.2.7.101.5 Related Functions

[MCFB_StepLimitSwitchFastInput](#)

5.2.7.102.6 Example

5.2.7.103.7.1 Structured Text

```
Execute_1 :=1;
```

```
(*Positive_Switch and Negitive_Switch are physical hardware in  
Dictionary. *)
```

```
Inst_MC_StepAbsSwitchFastInput( Execute_1, Axis1, 0, 0,  
10000.0,Acceleration:=10000.0, 10000.0, 0, 0, 0, 0,  
Positive_Switch , Negitive_Switch , 0)
```

```
HomeComplete := Inst_MC_StepAbsSwitchFastInput.Done;
```

```
HomeBusy := Inst_MC_StepAbsSwitchFastInput.Busy;
```

```
HomeActive := Inst_MC_StepAbsSwitchFastInput.Active;
```

```
HomeAborted := Inst_MC_StepAbsSwitchFastInput.CommandAborted;
```

```
HomeError := Inst_MC_StepAbsSwitchFastInput.Error;
```

```
HomeErrorID := Inst_MC_StepAbsSwitchFastInput.ErrorID;
```

```
HomeTriggerPosition := Inst_MC_  
StepAbsSwitchFastInput.TriggerPosition;
```

5.2.7.104.8.2 FBD

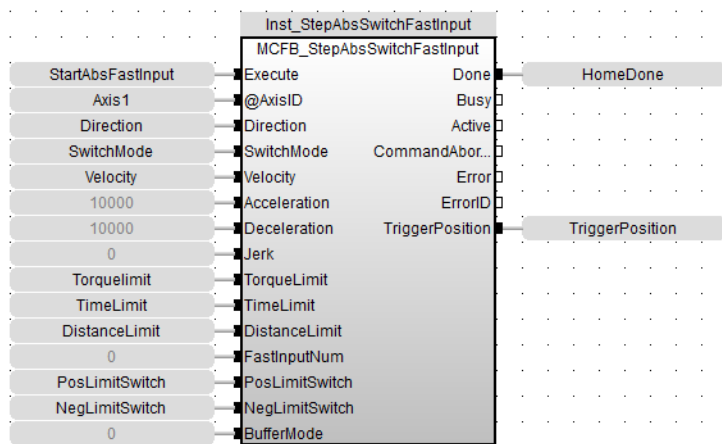

5.2.7.105.9.3 Ladder Diagram

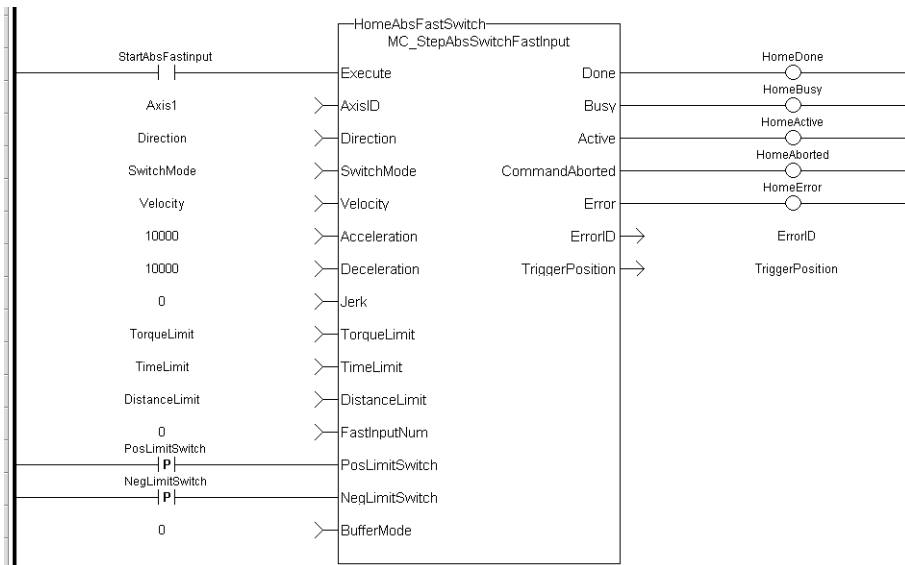

(* PosLimitSwitch, NegLimitSwitch are declared I/O points *)

5.2.7.106 MCFB_StepLimitSwitchFastInput PLCopen ✔

5.2.7.107.1 Description

This function block performs a homing function by searching for an external physical switch. The switch must be connected to one of the two fast inputs on the Axis' AKD drive. The Axis will move and when a fast input is triggered, the triggered axis will then perform an absolute move to the latched position.

The following figure shows the function block I/O:

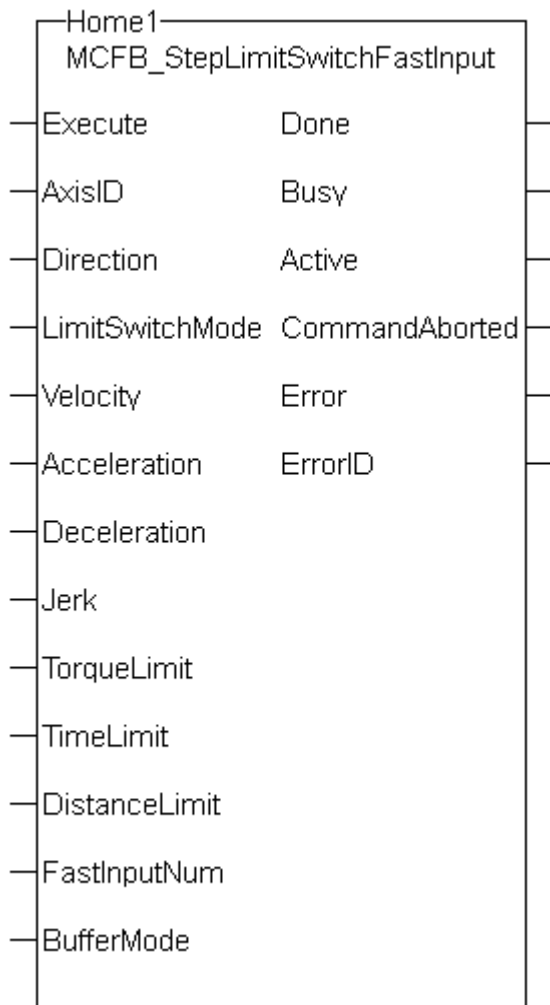

Figure 1-146: MCFB StepLimitSwitchFastInput

5.2.7.108.2.1 Input

Execute	Description	Request the homing step procedure at rising edge. Outputs are reset when execute input is false.
	Data type	BOOL
	Range	[0 , 1]
	Unit	n/a
	Default	—
AxisID	Description	Structure for specified Axis desired to home
	Data type	AXIS_REF
	Range	[1 , 256]
	Unit	n/a
	Default	—

Direction	Description	Define the axis homing direction						
		<table border="1"> <thead> <tr> <th>Value</th> <th>Description</th> </tr> </thead> <tbody> <tr> <td>0</td> <td>clockwise rotation</td> </tr> <tr> <td>1</td> <td>counterclockwise rotation</td> </tr> </tbody> </table>	Value	Description	0	clockwise rotation	1	counterclockwise rotation
	Value	Description						
	0	clockwise rotation						
	1	counterclockwise rotation						
Data type	BOOL							
Range	[0, 1]							
Unit	n/a							
	Default	—						
LimitSwitchMode	Description	Limit switch state to complete homing						
		<table border="1"> <thead> <tr> <th>Value</th> <th>Description</th> </tr> </thead> <tbody> <tr> <td>0</td> <td>when rising edge of sensor</td> </tr> <tr> <td>1</td> <td>when falling edge</td> </tr> </tbody> </table>	Value	Description	0	when rising edge of sensor	1	when falling edge
	Value	Description						
	0	when rising edge of sensor						
	1	when falling edge						
Data type	DINT							
Range	[0, 1]							
Unit	n/a							
	Default	—						
Velocity	Description	Commanded velocity for the homing move						
	Data type	LREAL						
	Range	—						
	Unit	User unit/sec						
	Default	—						
Acceleration	Description	Commanded acceleration for the homing move						
	Data type	LREAL						
	Range	—						
	Unit	User unit/sec ²						
	Default	—						
Deceleration	Description	Commanded deceleration for the homing move						
	Data type	LREAL						
	Range	—						
	Unit	User unit/sec ²						

	Default	—
Jerk	Description	Commanded jerk for the homing move (if zero, then trapezoidal acc/dec is used)
	Data type	LREAL
	Range	—
	Unit	User unit/sec ³
	Default	—
TorqueLimit	Description	Maximum torque applied for the homing move
	Data type	LREAL
	Range	—
	Unit	User unit entered in thousandths of maximum torque, e.g. "250" is 250/1000, or 25%.
	Default	—
TimeLimit	Description	Maximum time for homing move to complete. If exceeded the homing procedure will error out. 0= no time limit
	Data type	TIME
	Range	—
	Unit	sec
	Default	—
DistanceLimit	Description	Maximum distance for homing move to complete. If exceeded the homing procedure will error out. 0= no distance limit
	Data type	LREAL
	Range	—
	Unit	User unit
	Default	—
FastInputNum	Description	0 for first fast input (X7 Pin 10), 1 for second fast input (X7 pin 9)
	Data type	BOOL
	Range	[0, 1]
	Unit	n/a
	Default	—

BufferMode	Description	Define the homing move start action														
		<table border="1"> <thead> <tr> <th>Value</th> <th>Description</th> </tr> </thead> <tbody> <tr> <td>0</td> <td>abort</td> </tr> <tr> <td>1</td> <td>buffer</td> </tr> <tr> <td>2</td> <td>Blend to active</td> </tr> <tr> <td>3</td> <td>blend to next</td> </tr> <tr> <td>4</td> <td>blend to low velocity</td> </tr> <tr> <td>5</td> <td>blend to high velocity</td> </tr> </tbody> </table>	Value	Description	0	abort	1	buffer	2	Blend to active	3	blend to next	4	blend to low velocity	5	blend to high velocity
	Value	Description														
	0	abort														
	1	buffer														
	2	Blend to active														
	3	blend to next														
4	blend to low velocity															
5	blend to high velocity															
Data type	SINT															
Range	[0 , 5]															
Unit	n/a															
Default	—															

5.2.7.109.3.2 Output

Done	Description	Indicates the move completed successfully. The Command Position has reached the endpoint
	Data type	BOOL
	Unit	n/a
Busy	Description	High from the moment the Execute input is one-shot to the time the move is ended
	Data type	BOOL
	Unit	n/a
Active	Description	Set when the function block is active
	Data type	BOOL
	Unit	n/a
CommandAborted	Description	Indicates the move was aborted
	Data type	BOOL
	Unit	n/a
Error	Description	Signals that an error has occurred within the function block
	Data type	BOOL
	Unit	n/a

ErrorID	Description	Indicates the error if Error output is set to TRUE	
		Value	Description
		1	TimeLimit exceeded
		2	DistanceLimit exceeded
		3	TorqueLimit exceeded
		4	axis error stop state
		5	axis not enabled
		6	invalid inputs for Velocity-Accel-Decel
	Data type	INT	
	Unit	n/a	

5.2.7.110.4 Usage

The homing is commanded in the most likely direction were the sensor can be found. In this example (-).

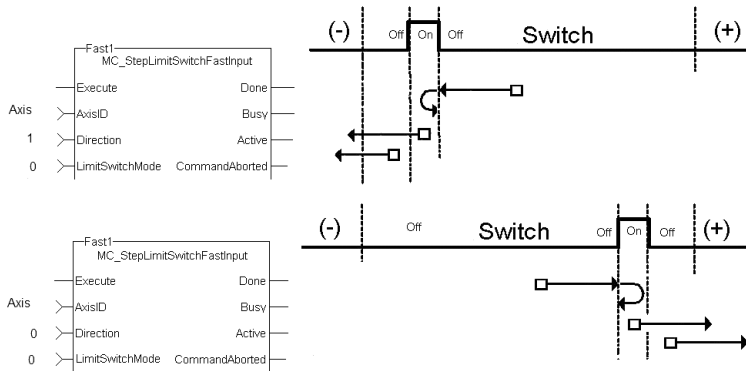

5.2.7.111.5 Related Functions

[MCFB_StepAbsSwitchFastInput](#)

5.2.7.112.6 Example

5.2.7.113.7.1 Structured Text

```

Execute_1 :=1;

Inst_MCFB_StepLimitSwitchFastInput( Execute_1, Axis1, 0, 0,
10000.0, 10000.0, 10000.0, 0, 0, 0, 0, 0, 0);

HomeComplete := Inst_MCFB_StepLimitSwitchFastInput.Done;
HomeBusy := Inst_MCFB_StepLimitSwitchFastInput.Busy;
HomeActive := Inst_MCFB_StepLimitSwitchFastInput.Active;
HomeAborted := Inst_MCFB_StepLimitSwitchFastInput.CommandAborted;
HomeError := Inst_MCFB_StepLimitSwitchFastInput.Error;
HomeErrorID := Inst_MCFB_StepLimitSwitchFastInput.ErrorID;
    
```

5.2.7.114.8.2 FBD

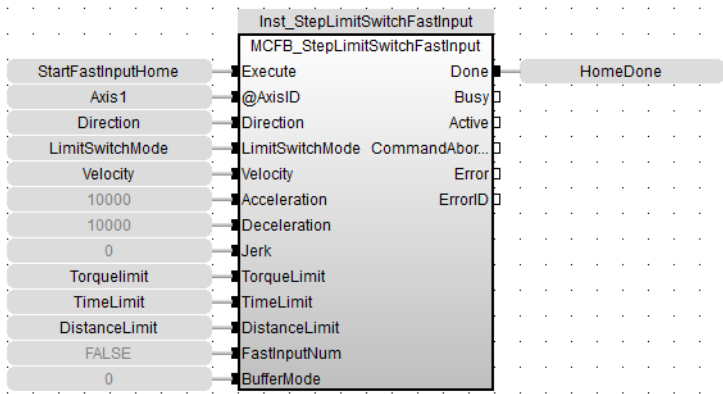

5.2.7.115.9.3 Ladder Diagram

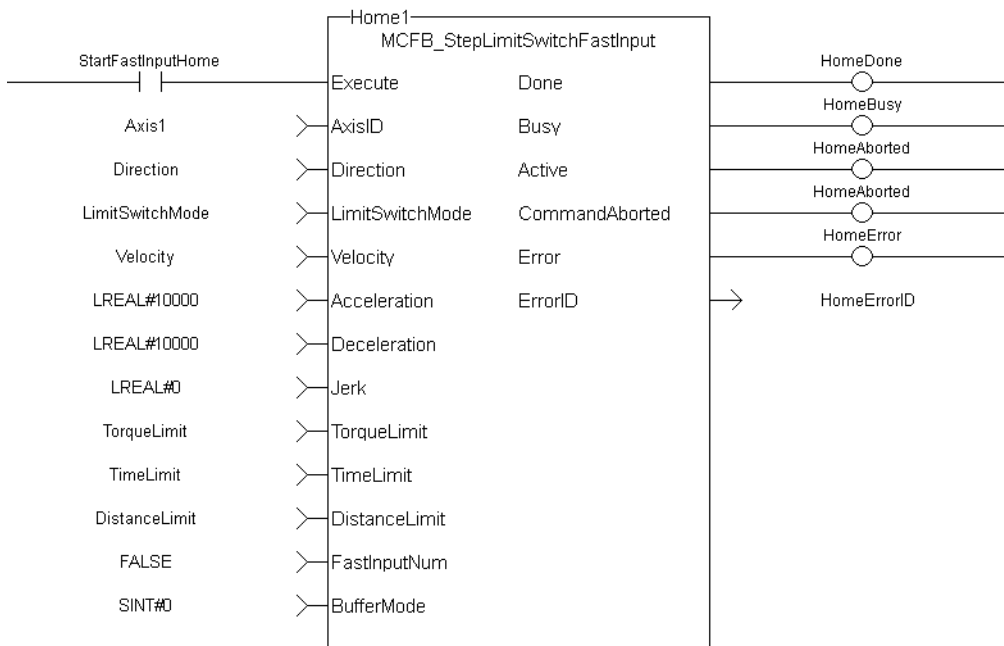

5.2.8 Jog for PLCopen PLCopen

5.2.8.1 Description

This function block is defined to jog an axis in the selected direction at a defined speed. The En input (FFLD editor only) must be high. Typically wired to the rail.

The AxisID selects the axis to jog. The JogPlus and JogMinus inputs select the direction the motion will occur in. Only one of these inputs should be enabled at a given time. If both are selected the motion will stop. If other motion is active when the jog is requested that motion will be aborted and the jog will start.

The following figure shows the function block I/O

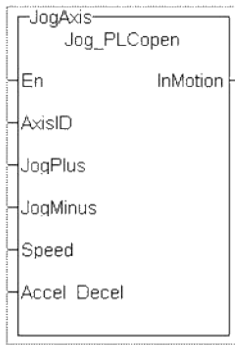

Figure 1-147: Jog for PLCopen

5.2.8.2 Arguments

5.2.8.3.1 Input

En	Description	Enables execution (FFLD only)
	Data type	BOOL
	Range	—
	Unit	n/a
	Default	—
AxisID	Description	ID Name of the Axis
	Data type	DINT
	Range	—
	Unit	n/a
	Default	—
JogPlus	Description	Enables a Jog in the plus direction
	Data type	BOOL
	Range	[0 , 1]
	Unit	n/a
	Default	—
JogMinus	Description	Enables a Jog in the Minus direction
	Data type	BOOL
	Range	[0 , 1]
	Unit	n/a
	Default	—
Speed	Description	Rate at which the axis will move
	Data type	LREAL
	Range	—
	Unit	User unit/sec
	Default	—
Accel Decel	Description	Linear Acc/Dec rate
	Data type	LREAL
	Range	—
	Unit	User unit/sec ²
	Default	—

5.2.8.4.2 Output

InMotion	Description	Jogging is active when TRUE
	Data type	BOOL
	Unit	n/a

5.2.8.5 Usage

This function Block is used to command motion in a designated direction at a defined rate. This may be used where continuous motion required as in a conveyor system, or in a setup mode for manually jogging the axis. Motion will start when the JogPlus or JogMinus input is true. It will stop when the input goes false.

5.2.8.6 Related Functions

[MC_MoveVelocity](#)

5.2.8.7 Example

5.2.8.8.1 Structured Text

```
InMotion := Inst_Jog_PLCoPen(Axis1, Switch_1, Switch_2, 600, 10000);
```

5.2.8.9.2 Ladder Diagram

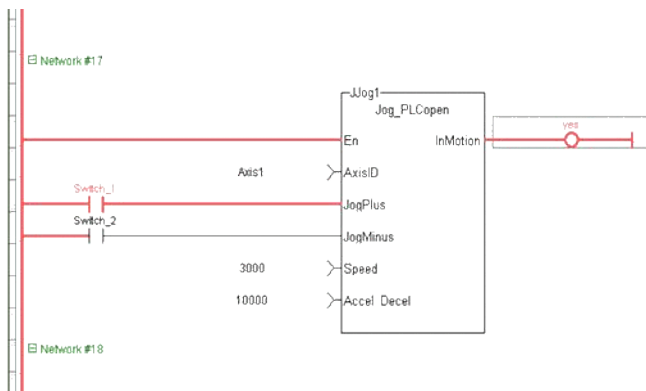

5.2.8.10.3 Function Block Diagram

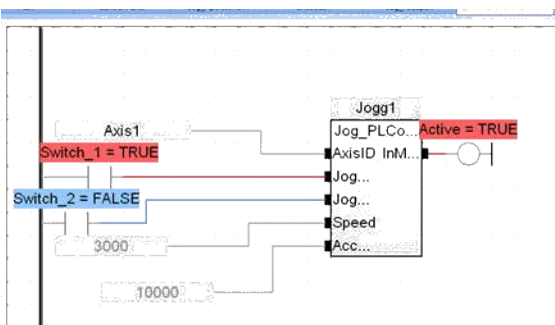

5.2.9 MCFB_GearedWebTension PLCopen

This Kollmorgen UDFB facilitates dancer and tension control in an electronic geared master/slave machine design. This is done by using the analog feedback from a LVDT, tension transducer, potentiometer, encoder, resolver or some other similar device. The analog feedback value is compared to a pre-determined analog set-point. The difference or error is used in a PID algorithm with the summed output driving changes to the master/slave gearing relationship. This results in the slave axis either speeding up or slowing down to maintain desired tension.

The following figure shows the function block I/O.

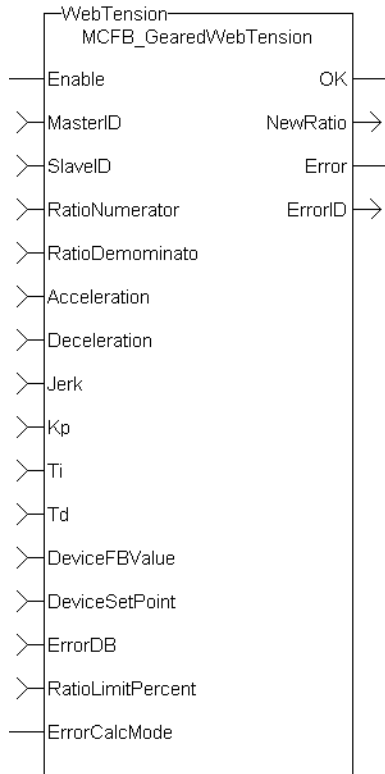

Figure 1-148: MCFB_GearedWebTension Function Block I/O

5.2.9.1 Arguments

5.2.9.2.1 Inputs

Enable	Description	Enables execution
	Data Type	BOOL
	Range	[0,1]
	Unit	n/a
	Default	-
MasterID	Description	Identifies the master axis
	Data Type	AXIS_REF
	Range	

	Unit	n/a
	Default	-
SlaveID	Description	Identifies the slave axis
	Data Type	AXIS_REF
	Range	
	Unit	n/a
	Default	-
RatioNumerator	Description	Numerator of the master/slave ratio
	Data Type	DINT
	Range	[-2147483648 to +2147483647]
	Unit	n/a
	Default	-
RatioDenominator	Description	Denominator of the master/slave ratio
	Data Type	DINT
	Range	[-2147483648 to +2147483647]
	Unit	n/a
	Default	-
Acceleration	Description	Trapezoidal: acceleration rate, S-Curve: maximum acceleration
	Data Type	LREAL
	Range	[-1.7E308 to 1.7E308 and -1.7E-308 to 1.7E-308 (14 to 15 significant digits of accuracy)]
	Unit	n/a
	Default	-
Deceleration	Description	Trapezoidal: deceleration rate, S-Curve: not used
	Data Type	LREAL
	Range	[-1.7E308 to 1.7E308 and -1.7E-308 to 1.7E-308 (14 to 15 significant digits of accuracy)]
	Unit	n/a
	Default	-
Jerk	Description	Trapezoidal: 0, S-Curve: constant jerk

	Data Type	LREAL
	Range	[-1.7E308 to 1.7E308 and -1.7E-308 to 1.7E-308 (14 to 15 significant digits of accuracy)]
	Unit	n/a
	Default	-
Kp	Description	Proportional gain
	Data Type	LREAL
	Range	[-1.7E308 to 1.7E308 and -1.7E-308 to 1.7E-308 (14 to 15 significant digits of accuracy)]
	Unit	n/a
	Default	-
Ti	Description	Integral gain
	Data Type	LREAL
	Range	[-1.7E308 to 1.7E308 and -1.7E-308 to 1.7E-308 (14 to 15 significant digits of accuracy)]
	Unit	n/a
	Default	-
Td	Description	Derivative gain
	Data Type	LREAL
	Range	[-1.7E308 to 1.7E308 and -1.7E-308 to 1.7E-308 (14 to 15 significant digits of accuracy)]
	Unit	n/a
	Default	-
DeviceFBValue	Description	Analog input
	Data Type	DINT
	Range	[-2147483648 to +2147483647]
	Unit	n/a
	Default	-
DeviceSetPoint	Description	Analog set point
	Data Type	DINT
	Range	[-2147483648 to +2147483647]

	Unit	n/a
	Default	-
ErrorDB	Description	Maximum or minimum error between DeviceFBValue and DeviceSetPoint before a change will take place.
	Data Type	LREAL
	Range	[-1.7E308 to 1.7E308 and -1.7E-308 to 1.7E-308 (14 to 15 significant digits of accuracy)]
	Unit	n/a
	Default	-
RatioLimitPercent	Description	Maximum and minimum master/slave ratio window
	Data Type	LREAL
	Range	[-1.7E308 to 1.7E308 and -1.7E-308 to 1.7E-308 (14 to 15 significant digits of accuracy)]
	Unit	n/a
	Default	-
ErrorCalcMode	Description	Not set: DeviceFBValue-DeviceSetPoint, Set: DeviceSetPoint-DeviceFBValue
	Data Type	BOOL
	Range	[0,1]
	Unit	n/a
	Default	-

5.2.9.3.2 Output

OK	Description	The output will have power flow after the enable input has been energized.
	Data Type	BOOL
	Range	[0,1]
	Unit	n/a
NewRatio	Description	New master/slave ratio
	Data Type	REAL
	Range	[-3.4E38 to 3.4E38 and -3.4E-38 to 3.4E-38 (6 to 7 significant digits of accuracy)]
	Unit	n/a

Error	Description	Function block error
	Data Type	BOOL
	Range	[0,1]
	Unit	n/a
ErrorID	Description	Function block error value
	Data Type	INT
	Range	[-32768 to +32767]
	Unit	n/a

5.2.9.4 Usage

This Kollmorgen UDFB is used in conjunction with the main ladder MC_GearIn function and it is assumed that the master/slave move is active. Internal to the Kollmorgen UDFB is another call to the MC_GearIn function therefore the MasterID, SlaveID, RatioNumerator, RatioDenominator, Acceleration, Deceleration, and Jerk inputs are the same values as the main ladder MC_GearIn function input values, both with the Buffer input of 0. This assures that the initial starting master/slave ratio will transition to the new Kollmorgen UDFB ratio smoothly.

This Kollmorgen UDFB will change the master/slave ratio that was defined by the MC_GearIn function based on the error between the analog input and the analog set-point. The magnitude of the ratio and the rate of the ratio change is defined by the Kp, Ti, Td PID gain values. The new ratio calculated is output at the NewRatio output.

The RatioLimitPercent input is the maximum and minimum theoretical new ratio that can be changed. This provides a +/- window limit around the running ratio to prevent unwanted motion in the event of a web break or analog feedback failure.

5.2.9.5.1 Example 1

NOTE

This example assumes that the analog feedback device is located *after* (or downstream in the process) the feedroll axis.

RatioNumerator = 1
 RatioDemominator = 2 Therefore the master/slave starting ratio is 0.500000
 ErrorCaclMode = 0
 DeviceFBValue = 6
 DeviceSetPoint = 4 Therefore error 6 – 4 = 2
 Kp = 0.005
 Ti = 0
 Td = 0

From the equation:

New RatioDemominator = (RatioDemoninator - Kp * error)

Therefore the new RatioDenominator = (2 - 0.005*2) = 1.99

Thus the new master/slave running ratio is 1 / 1.99 = 0.502512562

Since the master/slave ratio is greater that the previous ration the slave axis is going faster and the tension is reduced.

5.2.9.6.2 Example 2

NOTE

This example assumes that the analog feedback device is located *before* (or upstream in the process) the feedroll axis.

This is the same example as example 1 with the exception of the ErrorCalcMode input Boolean set.

RatioNumerator = 1

RatioDenominator = 2 Therefore the master/slave starting ratio is 0.5000000

ErrorCalcMode = 1

DeviceFBValue = 6

DeviceSetPoint = 4 Therefore error is $4 - 6 = -2$

$K_p = 0.005$

$T_i = 0$

$T_d = 0$

From the equation:

New RatioDenominator = (RatioDenominator – ($K_p * \text{error}$))

Therefore the new RatioDenominator = $(2 + 0.005 * 2) = 2.01$

Thus the new master/slave running ratio is $1 / 2.01 = 0.497512437$

Since the master/slave ratio is less than the previous ratio the slave axis is going slower and the tension is reduced.

5.2.9.7.3 PID Function in KAS:

There is a PID function in KAS that could be used for the PID control section in the Kollmorgen UDFB.

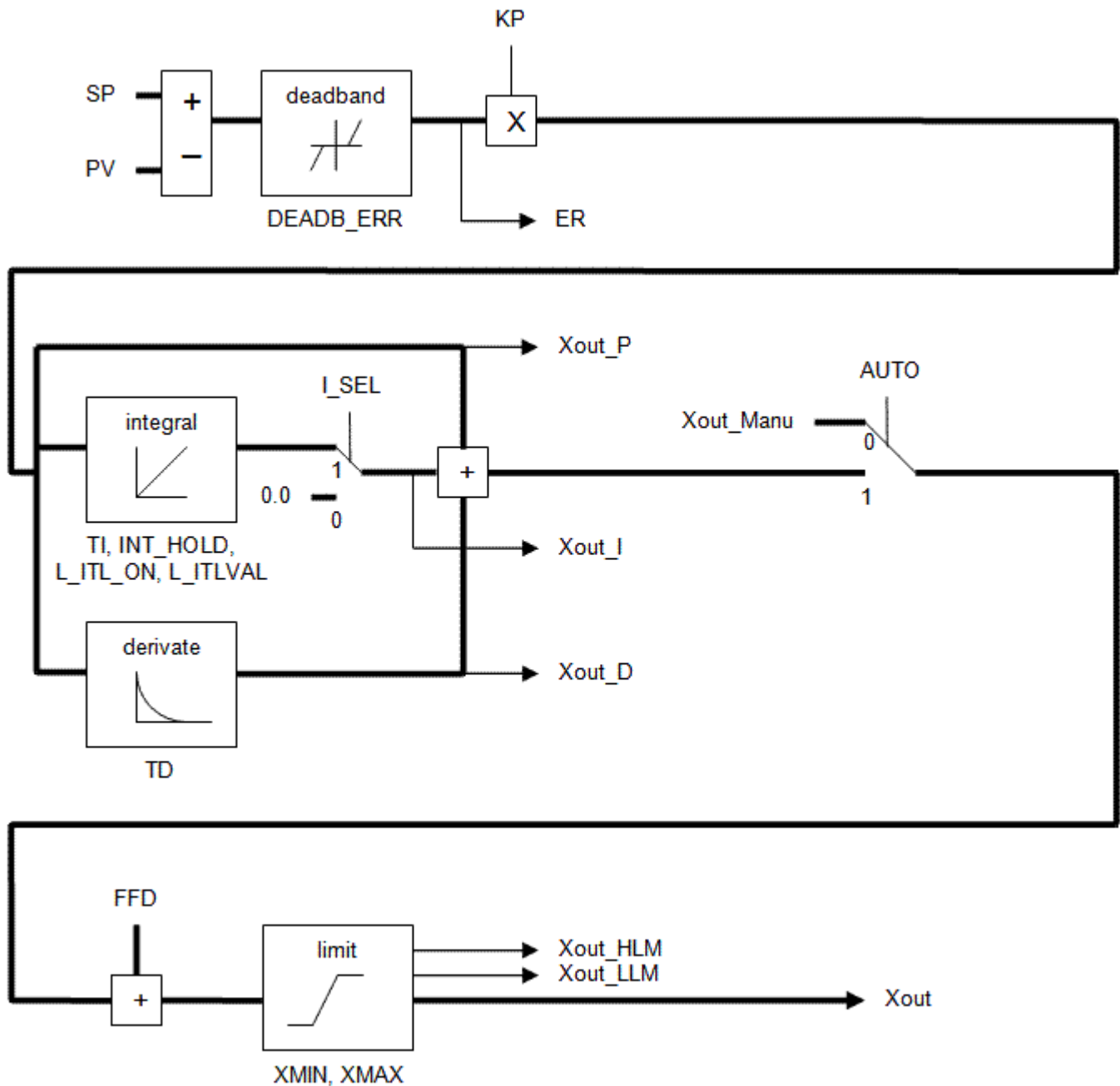

5.2.9.8.4 Programming tips:

The First Order Digital Filter Kollmorgen UDFB can be used to decrease excess dither on the analog input. The filtered analog value is then used at the DeviceFBValue input of the MCFB_GearedWebTension Kollmorgen UDFB .

The assumption is a MC_GearIn function block is first called in the main ladder and these initial values are then used at the inputs for the Kollmorgen UDFB. The resolution of the initial MC_GearIn the RatioNumerator and RatioDenominator inputs are directly related to the resolution of the calculated master/slave ratio (from the Kollmorgen UDFB inputs) and may need to be scaled accordingly.

5.2.9.9.5.1 Example 1

No scaling

Initial MC_GearIn input RatioNumerator = 2

Initial MC_GearIn input RatioDenominator = 1 then initial Master/Slave ratio = 2

Kollmorgen UDFB input RatioNumerator = 2
 Kollmorgen UDFB input RatioDenominator = 1 then Kollmorgen UDFB Master/Slave ratio = 2
 Kollmorgen UDFB input DeviceFBValue = 4
 Kollmorgen UDFB input DeviceFBSetpoint = 3 then Device PID error = 1 assume KP = 1, Ti and Td =0
 New Kollmorgen UDFB RatioNumerator = Current RatioNumerator – PID error = 2 – 1 = 1 then new
 Kollmorgen UDFB Master/Slave ratio = 1
 Resolution = Master/Slave ratio:PID Error ratio = 1:1

The resolution is so coarse that a change of 1 for the error output of the PID creates a Master/Slave ratio change of 1. This results is a significant change to the slave velocity that will probably cause excess slack or web breakage.

5.2.9.10.6.2 Example 2

Scaling value = 1000
 Initial MC_GearIn input RatioNumerator = 2
 Initial MC_GearIn input RatioDenominator = 1 then initial Master/Slave ratio = 2
 Kollmorgen UDFB input RatioNumerator = 2000
 Kollmorgen UDFB input RatioDenominator = 1000 then Kollmorgen UDFB Master/Slave ratio = 2
 Kollmorgen UDFB input DeviceFBValue = 4
 Kollmorgen UDFB input DeviceFBSetpoint = 3 then Device PID error = 1 assume KP = 1, Ti and Td =0
 New Kollmorgen UDFB RatioNumerator = Current RatioNumerator – PID error = 2000– 1 =1999 then new
 Kollmorgen UDFB Master/Slave ratio = 1999
 Resolution = Master/Slave ratio:PID Error ratio = 2000:1

This resolution is much finer than example 1 so for a change of 1 for the error output of the PID this creates a Master/Slave ratio change of 1999. This results is a slower rate of change to the slave velocity that the more suited to good tension in a machine process.

5.2.9.11 Related Functions

"FB_FirstOrderDigitalFilter" (→ p. 727)

5.2.9.12 Example

5.2.9.13.1 Ladder Example

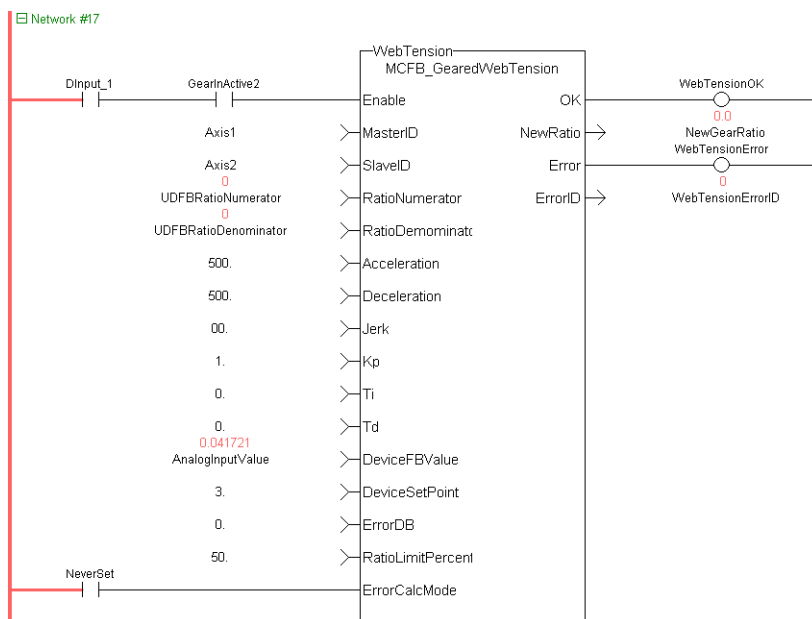

5.2.9.14.2 Function Block Diagram Example

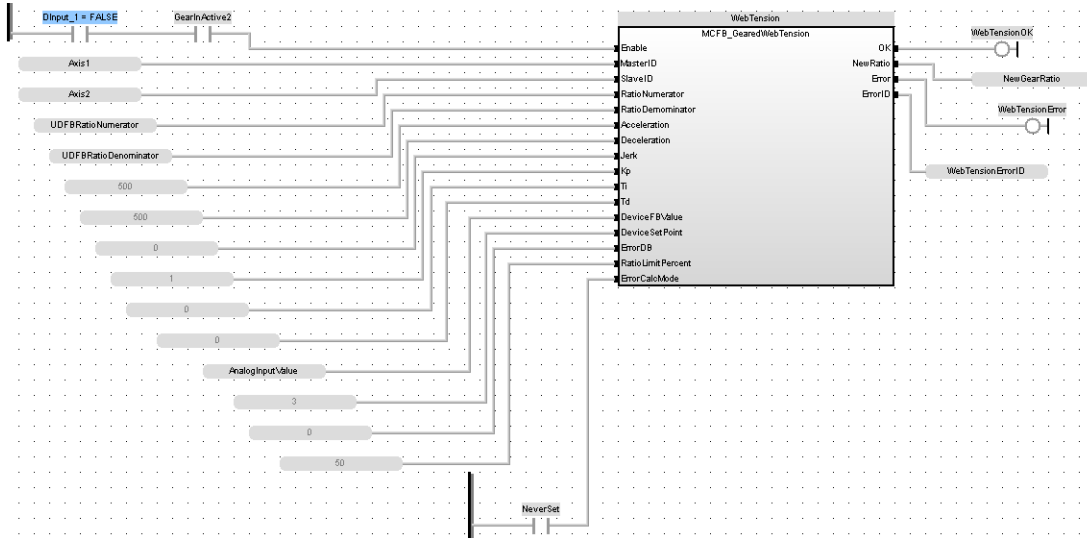

5.2.9.15.3 Structured Text Example

```

Inst_MCFB_GearedWebTension
( DInput_1 FALSE , Axis1, Axis2, UDFBRatioNumerator 0 , UDFBRatioDenominator 0 ,
500.0, 500.0, 0.0,1.0, 0.0,0.0, AnalogInputValue 0.0 , 3.0, 0.0, 50.0, NeverSet FALSE );
WebTensionOk FALSE :=Inst_MCFB_GearedWebTension.OK FALSE ;
NewGearRatio 0.0 :=Inst_MCFB_GearedWebTension.NewRatio 0.0 ;
WebTensionError FALSE :=Inst_MCFB_GearedWebTension.Error FALSE ;
WebTensionErrorID 0 :=Inst_MCFB_GearedWebTension.ErrorID 0 ;
    
```

5.2.10 FB_FirstOrderDigitalFilter

5.2.10.1 Description

This FB is defined to filter an Analog signal.

In any control system with an analog feedback signal present there is the risk of unwanted noise and jitter that can compromise the signal integrity yielding a less desirable system.

This Kollmorgen UDFB will provide a digital first order filter of an analog feedback signal from an LVDT, tension transducer, potentiometer, encoder, resolver, or some other like device. The amount of filtering is based on a gain value and can provide no filter to full filter conditioning.

The following figure shows the function block I/O

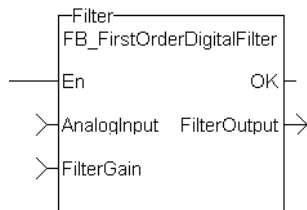

Figure 1-149: CBS First Order Digital Filter

5.2.10.2 Arguments

5.2.10.3.1 Inputs

EN	Description
	Enables execution (FFLD only)
Data type	BOOL

	Range	—
	Unit	n/a
	Default	
AnalogInput	Description	Analog Input from transducer
	Data type	INT
	Range	—
	Unit	n/a
	Default	
FilterGain	Description	Filter Gain
	Data type	REAL
	Range	[1 - 0.05]
	Unit	n/a
	Default	—

5.2.10.4.2 Outputs

OK	Description	Execution Complete
	Data type	BOOL
	Range	[0,1]
	Unit	
FilterOutput	Description	Filtered analog input value
	Data type	REAL
	Range	[0,1]
	Unit	

5.2.10.5 Usage

When using this UDFB, the Enable (EN) input should always be energized in order to provide the desired filtering.

- The AnalogInput input is the unfiltered “raw” analog feedback signal from an LVDT, tension transducer, potentiometer, or some other like device.
- The FilterGain defines the amount of filtering to be used. The range of the gain is from 1.0 or no filtering to 0.05 or the maximum filtering.
- The FilterOutput is the filtered analog input and is typically used as an input to some other function block or UDFB that has an analog input, for example the MCFB_GearedWebTension UDFB.
- The implementation of the digital first order filter is for PLCopen.

- The equation is defined as: $\text{Input} * \text{Gain} + \text{Output} * (1 - \text{Gain}) = \text{Output}$
- The steady state filter delay with a gain of 0.8 can be seen in the following table.

FilterGain	FilterInput	FilterOutput
0.8	0	0
	100	80
	100	96
	100	99.2
	100	99.84
	100	99.968
	100	99.9936
	100	99.99872
	100	99.999744
	100	99.9999488
	100	99.99998976
	100	99.99999795
	100	99.99999959
	100	99.99999992
	100	99.99999998
	100	100
	100	100
	100	100
	100	100
	100	100
	100	100
	100	100
	100	100

Table 1-13: Filter Input Delay Example

The range of the filter gain is between 1.00 and 0.05. From the table, for a filter gain of 0.8 there is a delay of 15 time constants with a time constant defined as the rate the UDFB is scanned or executed in the application. For example if the UDFB was executed every millisecond a gain of 0.8 would provide a filter delay of 15ms. Conversely a gain of 1.00 provides zero filtering and the output signal follows the input signal, and a gain of 0.05 provides the most filtering for 463 ms.

The numbers of filter delays for a steady state analog input at a given gain are shown in the table and graph below.

Gain	Filter Delay Tn
1.00	0
0.95	8
.90	11
.85	13
.80	15
.75	18
.70	20
.65	23

Gain	Filter Delay Tn
.60	26
.55	30
.50	35
.45	40
.40	47
.35	56
.30	66
.25	83
.20	107
.15	146
.10	226
.05	463

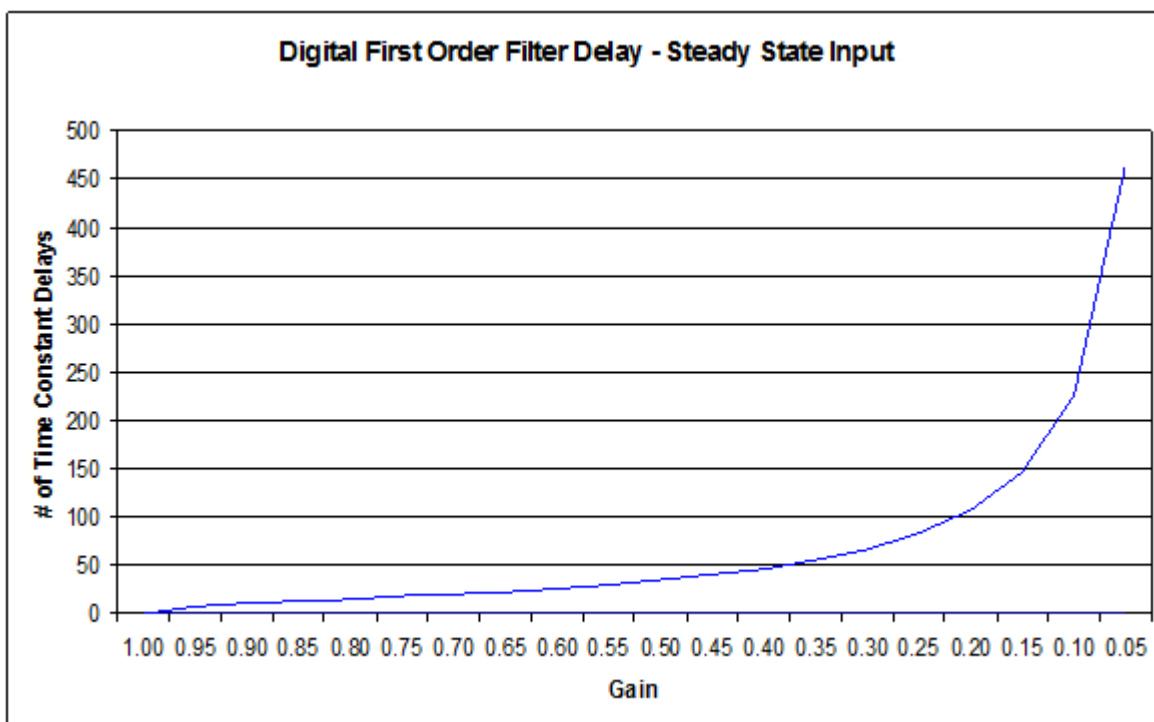

Of course a real world analog input is most always a varying feedback signal. In Table 2.3 this is shown with an initial input of 100, a gain of 0.8, and a random variability of 10%. Filter Input

Filter Input	Filter Current Output	Amount of Input Filtering	Random Filter % Variation
0	0	0	10%
100	80	-20	
97.38903813	93.9112305	-3.477807626	
92.67638093	92.92335084	0.246969915	
94.12988912	93.88858146	-0.241307655	
103.0835564	101.2445614	-1.838994993	
91.16845433	93.18367575	2.015221422	
93.23936976	93.22823096	-0.011138803	
94.90272089	94.56782291	-0.334897986	

Filter Input	Filter Current Output	Amount of Input Filtering	Random Filter % Variation
103.3070737	101.5592235	-1.747850153	
96.83149418	97.77704005	0.945545867	
96.35024002	96.63560002	0.285360007	
99.82417525	99.1864602	-0.637715045	
105.0792636	103.9007029	-1.178560685	
97.36988208	98.67604626	1.306164172	
107.82502	105.9952253	-1.829794752	
97.7886524	99.42996698	1.641314572	
108.2038024	106.4490353	-1.754767081	
91.58527607	94.55802792	2.972751845	
93.6783421	93.85427926	0.175937164	
102.8695349	101.0664838	-1.803051129	
93.95916817	95.3806313	1.421463121	
108.6579707	106.0025028	-2.655467871	
109.3425748	108.6745604	-0.668014397	
103.9066	104.8601921	0.953592077	
92.30112142	94.81293555	2.511814127	
109.4460726	106.5194452	-2.926627416	
94.88799896	97.21428821	2.326289251	
105.4738635	103.8219484	-1.651915057	
102.988167	103.1549233	0.166756284	
92.92925408	94.97438792	2.045133846	
95.58185568	95.46036213	-0.121493552	
109.414248	106.6234708	-2.790777178	
106.5661311	106.577599	0.011467953	
99.85857253	101.2023778	1.343805301	
107.865421	106.5328124	-1.332608643	
92.19683177	95.0640279	2.867196126	
104.8558146	102.8974573	-1.958357346	
104.5140236	104.1907104	-0.323313268	
104.3675014	104.3321432	-0.035358206	
109.2704266	108.2827699	-0.987656683	
101.4962729	102.8535723	1.35729941	
92.19199163	94.32430776	2.132316128	
99.13065312	98.16938405	-0.961269073	
103.5068114	102.4393259	-1.067485466	
109.502983	108.0902516	-1.412731426	
99.05504822	100.8620889	1.80704068	
94.97711299	96.15410817	1.176995182	
107.1063597	104.9159094	-2.190450308	
91.12245188	93.88114339	2.758691504	
108.130314	105.2804799	-2.849834129	

Filter Input	Filter Current Output	Amount of Input Filtering	Random Filter % Variation
104.2923832	104.4900025	0.197619344	
101.3775072	102.0000062	0.62249907	
100.5303014	100.0399168	-0.490384645	Averages

Table 1-14: Filter Input Lag Example - Random Input

5.2.10.6 Example

5.2.10.7.1 Structured Text

```
//Filter analog input signal with a gain of 0.8 to remove noise
FilteredOutput:= Inst_FB_FirstOrderDigitalFilter(
AnalogInput1Value, 0.8 );
```

5.2.10.8.2 Ladder Diagram

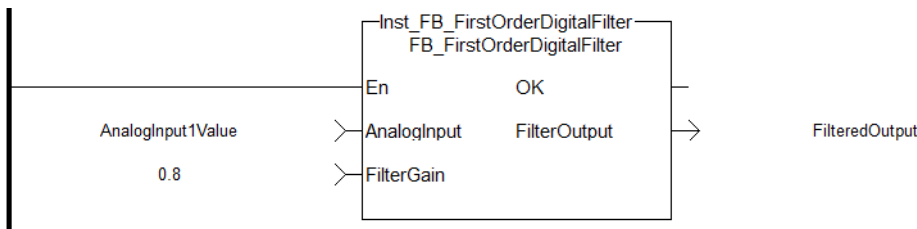

5.2.10.9.3 Function Block Diagram

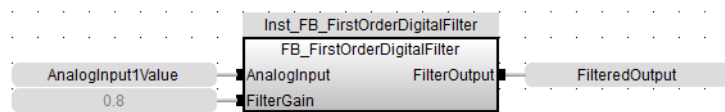

5.2.11 MCFB_AKDFault PLCopen ✓

5.2.11.1 Description

Outputs AKD drive fault Information. The FAULT output turns TRUE when the selected drive goes into a fault state. The fault number is the same number as reported on the display of the AKD drive. This function can be used with the PLCopen Motion engines. The following figure shows the function block I/O:

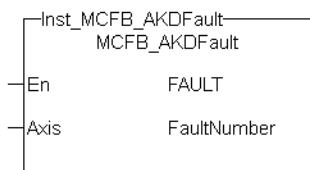

Figure 1-150: MCFB_AKDFault

5.2.11.2 Arguments

5.2.11.3.1 Input

EN	Description	ENABLES the Kollmorgen UDFB (used in FFLD editor only)
	Data type	BOOL
	Range	[0, 1]

	Unit	n/a
	Default	—
Axis	Description	Name of a declared instance of the AXIS_REF library function. For more details, About Axis Name and Number.
	Data type	AXIS_REF
	Range	[1, 256]
	Unit	n/a
	Default	—

5.2.11.4.2 Output

FAULT	Description	TRUE if selected drive currently has a Fault
	Data type	BOOL
	Range	[0, 1]
	Unit	n/a
FaultNumber	Description	Three digit AKD Fault identifier
	Data type	DINT
	Range	[100, 999]
	Unit	n/a

5.2.11.5 Usage

Typical usage for this UDFB are:

- Provide drive fault information that the application program uses to determine next steps such as perform a machine controlled stop or perform an immediate disable of the servo drives.
- In the application program send output fault information from this UDFB to the HMI for review by the machine operator.

Related Functions

"MCFB_AKDFaultLookup" (→ p. 734)

"FB_AKDFitRpt" (→ p. 738)

"MC_ReadStatus" (→ p. 358) (PLCopen Motion Engine)

5.2.11.6 Example

5.2.11.7.1 Structured Text

```
//Execute and Read the Function Block
Inst_MCFB_AKDFault( Axis1(*lib:AXIS_REF*) );
FaultDrive1 := Inst_MCFB_AKDFault.FAULT;
FaultDrive1Number := Inst_MCFB_AKDFault.FaultNumber;
```

```
FaultDrive1Description := MCFB_AKDFaultLookup( FaultDrive1Number
(*DINT*) );
```

5.2.11.8.2 Ladder Diagram

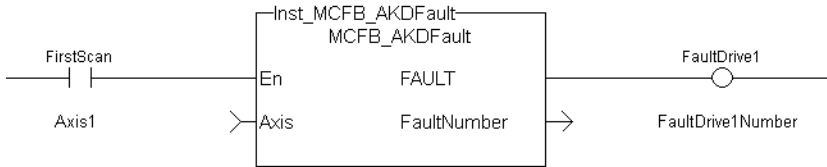

5.2.11.9.3 Function Block Diagram

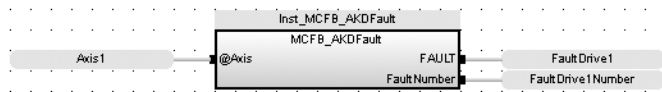

5.2.12 MCFB_AKDFaultLookup PLCopen ✔

5.2.12.1 Description

String message of the corresponding AKD drive fault number. The OK output turns TRUE when there is a match for the FaultNumber. The FaultDescription displays the corresponding text string. The FaultNumber is the same number as reported on the display of the AKD drive. This function can be used with the PLCopen Motion engines. The following figure shows the function I/O:

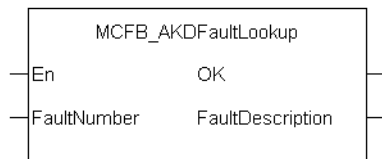

Figure 1-151: MCFB_AKDFaultLookup

5.2.12.2 Arguments

5.2.12.3.1 Input

EN	Description	ENABLES the Kollmorgen UDFB (used in FFLD editor only)
	Data type	BOOL
	Range	[0, 1]
	Unit	n/a
	Default	—
FaultNumber	Description	The AKD drive fault number
	Data type	DINT
	Range	—
	Unit	n/a
	Default	—

5.2.12.4.2 Output

OK	Description	TRUE if there is a match for the FaultNumber
	Data type	BOOL
	Range	[0, 1]
	Unit	n/a
FaultDescription	Description	Description of the Fault
	Data type	STRING
	Range	n/a
	Unit	n/a

5.2.12.5 Usage

Typical usage for this UDFB are:

- Provide drive fault information that the application program uses to determine next steps such as perform a machine controlled stop or perform an immediate disable of the servo drives.
- In the application program send output fault information from this UDFB to the HMI for review by the machine operator.

5.2.12.6 Related Functions

"MCFB_AKDFault" (→ p. 732)

"FB_AKDFltRpt" (→ p. 738)

"MC_ReadStatus" (→ p. 358) (PLCopen Motion Engine)

5.2.12.7 Example

5.2.12.8.1 Structured Text

```
//Execute and Read the Function Block
Inst_MCFB_AKDFault( Axis1(*lib:AXIS_REF*) );
FaultDrive1 := Inst_MCFB_AKDFault.FAULT;
FaultDrive1Number := Inst_MCFB_AKDFault.FaultNumber;

FaultDrive1Description := MCFB_AKDFaultLookup( FaultDrive1Number
(*DINT*) );
```

5.2.12.9.2 Ladder Diagram

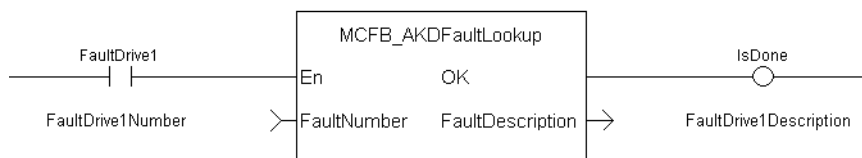

5.2.12.10.3 Function Block Diagram



5.2.13 FB_Cylinder

5.2.13.1 Description

This function block can be used to control a cylinder and the Limit Switches.

There are two inputs InA and InB to set the direction of the movement and the belonging LimSwitches LsA and LsB.

If InA is set to TRUE the output DirA is set to TRUE and after a time value defined by CtrlTime the LsA has to become TRUE otherwise a fault FaultLsA appears. Just as in direction B.

If both LsA and LsB are TRUE then a Fault depending of the output is set. If both InA and InB are given (e.g. to stop the cylinder movement) no limit switch is controlled.

All faults can be reset by input iResetFault.

5.2.13.2 Arguments

5.2.13.3.1 Input

iInA	Description	Set direction A
	Data type	BOOL
iInB	Description	Set direction B
	Data type	BOOL
iLsA	Description	Limit Switch at End of direction A
	Data type	BOOL
iLsB	Description	Limit Switch at End of direction B
	Data type	BOOL
iCtrlTime	Description	Max Time till Lim.Sw. has to be reached
	Data type	TIME
iResetFault	Description	Reset Fault (Is set to FALSE by UDFB!)
	Data type	BOOL

5.2.13.4.2 Output

oDirA	Description	Direction A
	Data type	BOOL
oDirB	Description	Direction B
	Data type	BOOL
oFaultLsA	Description	Fault of Lim.Sw. at End direction A
	Data type	BOOL
oFaultLsB	Description	Fault of Lim.Sw. at End direction B

Data type	BOOL
------------------	------

5.2.13.5 Usage

The signal flow is valid for both directions (A and B)

If oDirA AND oDirB are active there is no Fault Control.

The Fault can be reset by iRestFault = True.

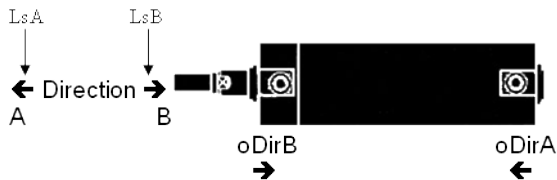

5.2.13.6 Example

5.2.13.7.1 ST

```

//Electric Cylinder with limit switch controls
Inst_FB_Cylinder( dirA, dirB, LimitSwitchA, LimitSwitchB,
CtrlTime, ResetFault );
A := Inst_FB_Cylinder.oDirA;
B := Inst_FB_Cylinder.oDirB;
FaultLimitSwitchA := Inst_FB_Cylinder.oFaultLsA;
FaultLimitSwitchB := Inst_FB_Cylinder.oFaultLsB;
    
```

5.2.13.8.2 Function Block Diagram

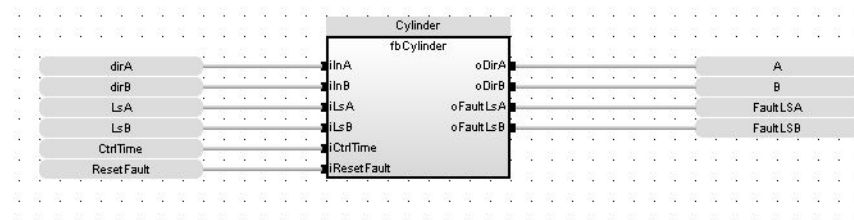

5.2.13.9.3 FFLD

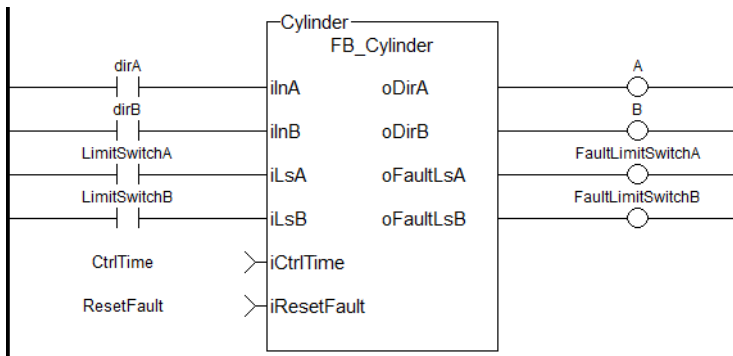

5.2.13.10 FB_AKDFItRpt PLCopen ✓ Pipe Network ✓

5.2.13.11.1 Description

Outputs AKD drive fault Information.

The oFAULT output turns TRUE when the selected drive goes into a fault state. This function block outputs the total number of faults in the AKD drive fault history variable (Pre-Defined Error Field Object 1003h), and the fault number and message for the last 3 drive faults.

Each fault has two outputs: the fault number and a fault message. The fault number is the same number as reported on the display of the AKD drive. The fault message provides a short description of the fault. For example if the first fault is a feedback error with a F401 displayed on the front of the drive, the output of this FB are:

- **oFirstFaultNumber** = 401
- **oFirstFaultMessage** = Failed To Set Feedback Type

The **iResetfaultHistory** Input resets the faults reported by the FB.

The **oDriveNotUsed** outputs a 1 (True) if the axis is configured to Simulated in the ProjectEthercat setup screen.

This function Block can be used with either the PipeNetwork or PLCopen Motion engines. The following figure shows the function block I/O:

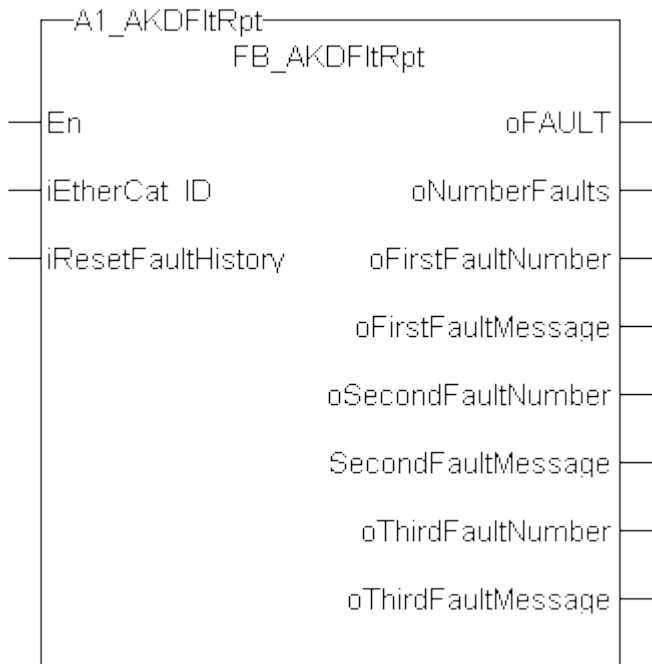

Figure 1-152: AKDFitRpt

5.2.13.12.2 Arguments

5.2.13.13.3.1 Input

EN	Description	ENABLES the Kollmorgen UDFB (used in FFLD editor only)
	Data type	BOOL
	Range	[0 , 1]
	Unit	n/a
	Default	—
iEtherCat_ID	Description	EtherCAT address desired AKD Drive ex. 1001 or AKD_1
	Data type	INT
	Range	—
	Unit	n/a
	Default	—
iRstFitHist	Description	When input is TRUE, clears all Faults saved to drives history
	Data type	BOOL
	Range	[0 , 1]
	Unit	n/a
	Default	—

5.2.13.14.4.2 Output

oFAULT	Description	TRUE if selected drive currently has a Fault
	Data type	BOOL
	Unit	n/a
oNumberFaults	Description	Number of faults saved in the Drive's history
	Data type	DINT
	Range	[0 , 10]
	Unit	n/a
oFirstFaultNumber	Description	Three digit AKD Fault identifier
	Data type	DINT
	Range	[100 , 999]

	Unit	n/a
oFirstFaultMessage	Description	Description of the Fault
	Data type	STRING
	Unit	n/a
oSecondFaultNumber	Description	Three digit AKD Fault identifier.
	Data type	DINT
	Range	[100 , 999]
	Unit	n/a
oSecondFaultMessage	Description	Description of the Fault
	Data type	STRING
	Unit	n/a
oThirdFaultNumber	Description	Three digit AKD Fault identifier
	Data type	DINT
	Range	[100 , 999]
	Unit	n/a
oThirdFaultMessage	Description	Description of the Fault
	Data type	STRING
	Unit	n/a
oDriveNotUsed	Description	Is this Drive Real (0) on Simulated (1)
	Data type	BOOL
	Unit	n/a

5.2.13.15.5 Usage

Typical usage for this UDFB are:

- Provide drive fault information that the application program uses to determine next steps such as perform a machine controlled stop or perform an immediate disable of the servo drives.
- In the application program send output fault information from this UDFB to the HMI for review by the machine operator.

5.2.13.16.6 Related Functions

[MC_ReadStatus](#) (PLCopen Motion Engine)

[MLAxisStatus](#) (Pipe Network Motion Engine)

5.2.13.17.7 Example

5.2.13.18.8.1 Structured Text

```

//Execute the Function Block
A1_AKDFltRpt (1001, resetFaultHistST);

//Read Function Block Outputs
AKD1_Fault:= A1_AKDFltRpt.oFault;
AKD1_NumFault:= A1_AKDFltRpt.oNumberFaults;
AKD1_FirstFaultNumber:= A1_AKDFltRpt.oFirstFaultNumber;
AKD1_FirstFaultMessage:= A1_AKDFltRpt.oFirstFaultMessage;
AKD1_SecondFaultNumber:= A1_AKDFltRpt.oSecondFaultNumber;
AKD1_SecondFaultMessage:= A1_AKDFltRpt.oSecondFaultMessage;
AKD1_ThirdFaultNumber:= A1_AKDFltRpt.oThirdFaultNumber;
AKD1_ThirdFaultMessage:= A1_AKDFltRpt.oThirdFaultMessage;

;
    
```

NOTE
 A1_FaultReporting is an instance of the FB_S700FltRpt function block.

5.2.13.19.9.2 Ladder Diagram

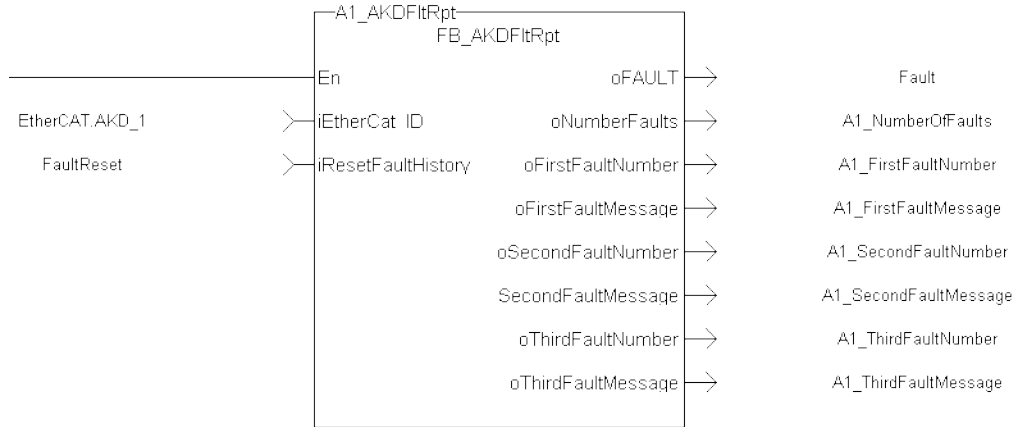

5.2.13.20.10.3 Function Block Diagram

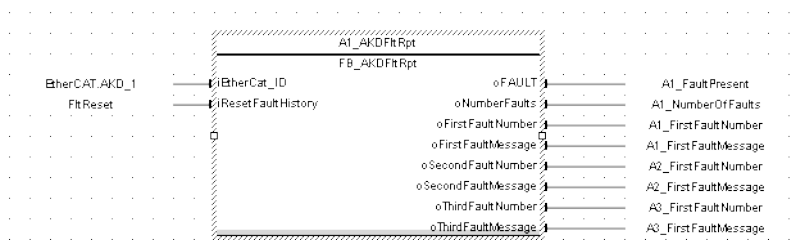

5.2.13.21 FB_S700FltRpt PLCopen ✓ Pipe Network ✓

5.2.13.22.1 Description

Outputs S700 drive fault Information.

The oFAULT output turns TRUE when the selected drive goes into a fault state. This function block outputs the total number of faults in the S700 drive fault history variable (FLTHIST), and the fault number and message for the last 3 drive faults.

Each fault has two outputs: the fault number and a fault message. The fault number is the same number as reported on the display of the S700 drive. The fault message provides a short description of the fault. For example if the first fault is a feedback error with a F04 is displayed on the front of the drive, the output of this FB are:

- **oFirstFaultNumber** = 04
- **oFirstFaultMessage** = Feedback Error

The **iResetfaultHistory** Input resets the faults reported by the FB.

The **oDriveNotUsed** outputs a 1 (True) if the axis is configured to Simulated in the ProjectEthercat setup screen.

This function Block can be used with either the PipeNetwork or PLCopen Motion engines.

The following figure shows the function block I/O:

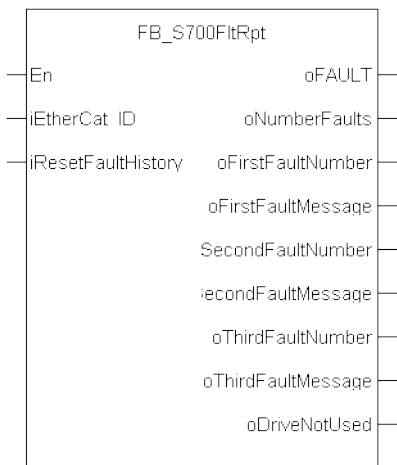

Figure 1-153: S700FltRpt

5.2.13.23.2 Arguments

5.2.13.24.3.1 Input

EN	Description Data type Range Unit Default	ENABLES the Kollmorgen UDFB (used in FFLD editor only) BOOL [0 , 1] n/a —
iEtherCat_ID	Description Data type Range Unit Default	EtherCAT address desired AKD Drive ex. 1001 or AKD_1 DINT — n/a —

iRstFltHist	Description	When input is TRUE, clears all Faults saved to drives history
	Data type	BOOL
	Range	[0 , 1]
	Unit	n/a
	Default	—

5.2.13.25.4.2 Output

oFAULT	Description	TRUE if selected drive currently has a Fault
	Data type	BOOL
	Unit	n/a
oNumberFaults	Description	Number of faults saved in the Drive's history
	Data type	DINT
	Range	[0 , 10]
	Unit	n/a
oFirstFaultNumber	Description	Two digit S700 drive Fault identifier
	Data type	DINT
	Range	[00 , 32]
	Unit	n/a
oFirstFaultMessage	Description	Description of the Fault
	Data type	STRING
	Unit	n/a
oSecondFaultNumber	Description	Two digit S700 drive Fault identifier
	Data type	DINT
	Range	[00 , 32]
	Unit	n/a
oSecondFaultMessage	Description	Description of the Fault
	Data type	STRING
	Unit	n/a
oThirdFaultNumber	Description	Two digit S700 drive Fault identifier
	Data type	DINT
	Range	[00 , 32]
	Unit	n/a
oThirdFaultMessage	Description	Description of the Fault
	Data type	STRING
	Unit	n/a
oDriveNotUsed	Description	Is this Drive Real (0) on Simulated (1)
	Data type	BOOL
	Unit	n/a

5.2.13.26.5 Usage

Typical usage for this UDFB are:

- Provide drive fault information that the application program uses to determine next steps such as perform a machine controlled stop or perform an immediate disable of the servo drives.
- In the application program send output fault information from this UDFB to the HMI for review by the machine operator.

5.2.13.27.6 Related Functions

[MC_ReadStatus](#) (PLCopen Motion Engine)

[MLAxisStatus](#) (Pipe Network Motion Engine)

5.2.13.28.7 Example

5.2.13.29.8.1 Structured Text

```
//Execute the Function Block
A1_FaultReporting (1001, 0);

//Read Function Block Outputs
A1_Fault:= A1_FaultReporting.oFault;
A1_NumFault:= A1_FaultReporting.oNumberFaults;
A1_FirstFaultNumber:= A1_FaultReporting.oFirstFaultNumber;
A1_FirstFaultMessage:= A1_FaultReporting.oFirstFaultMessage;
A1_SecondFaultNumber:= A1_FaultReporting.oSecondFaultNumber;
A1_SecondFaultMessage:= A1_FaultReporting.oSecondFaultMessage;
A1_ThirdFaultNumber:= A1_FaultReporting.oThirdFaultNumber;
A1_ThirdFaultMessage:= A1_FaultReporting.oThirdFaultMessage;
A1_Simulated:= A1_FaultReporting.oDriveNotUsed;
```

NOTE

A1_FaultReporting is an instance of the FB_S700FitRpt function block.

5.2.13.30.9.2 Ladder Diagram

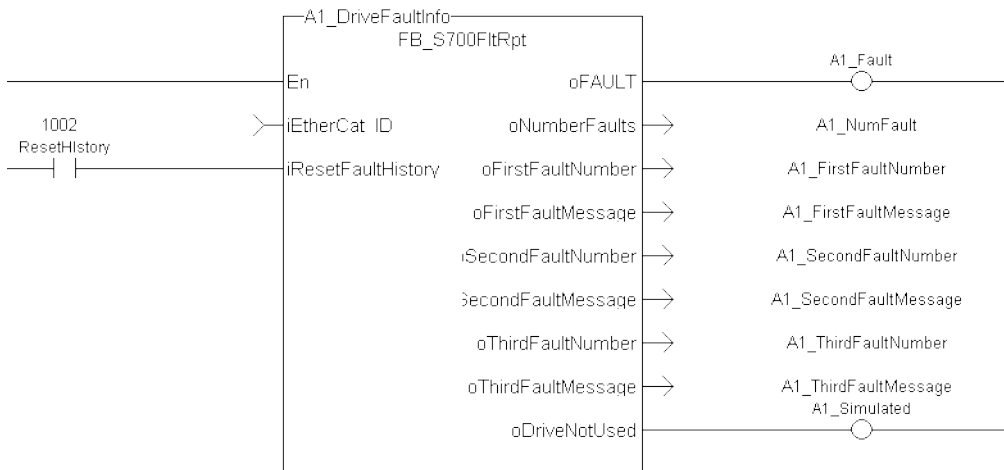

5.2.13.31.10.3 Function Block Diagram

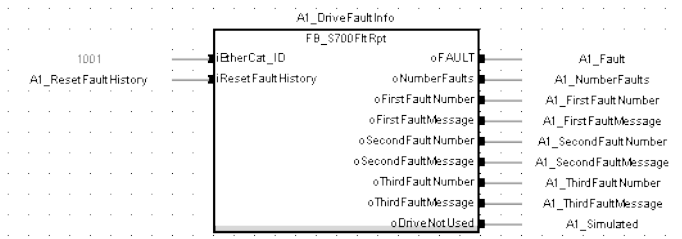

5.2.13.32 FB_AxisPLsPosModulo PLCopen ✓ Pipe Network ✓

5.2.13.33.1 Description

This function block can be used for any position of a modulo axis in both directions. The Boolean output oPLS is set to TRUE if the position has crossed the start position and is set to FALSE if the position has crossed the end position. The function block is executed cyclically. The function block has the possibility to compensate a delay time of the connected device, e. g. glue nozzles. It is also possible to define a hysteresis for switching on and off of the PLS.

5.2.13.34.2 Arguments

5.2.13.35.3.1 Input

ibExecute	Description	Enable PLS
	Data type	BOOL
iPosition	Description	Any position of a modulo axis
	Data type	LREAL
iModuloPosition	Description	Modulo position of axis
	Data type	LREAL
iStartPos	Description	Start position of PLS
	Data type	LREAL
iEndPos	Description	End position of PLS
	Data type	LREAL
iDelayTime	Description	Delay time for compensation
	Data type	TIME
iHysteresis	Description	Hysteresis
	Data type	LREAL
ibForce	Description	Force PLS
	Data type	BOOL

5.2.13.36.4.2 Output

oPLS	Description	Position limit switch
	Data type	BOOL

5.2.13.37.5 Example

5.2.13.38.6 Timing

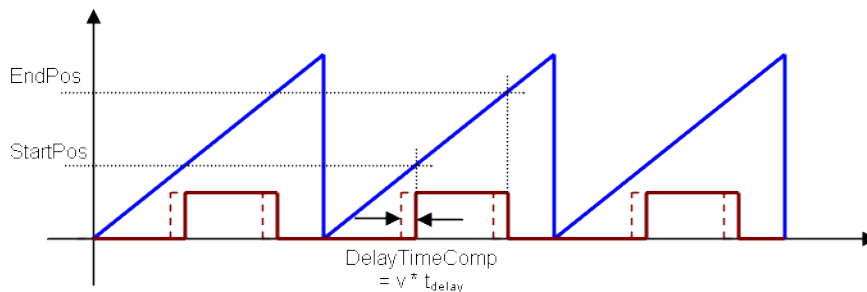

5.2.13.39.7 Hysteresis

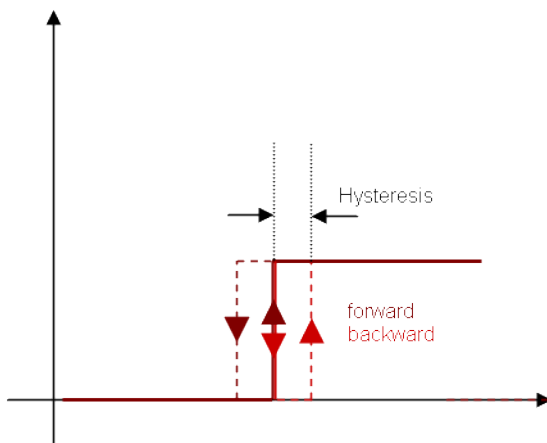

5.2.13.40.8.1 ST

```
//PLSOutput is True when position input is between 180 and 270
with a T#2ms delay
//Can also force the output to be true with ForceOutput variable
//Hysteresis is on for 3 user units in case direction changes
around start point
```

```
Inst_FB_AxisPlsPosModulo( EnablePLS, ActualPosition,
ModuloPosition, 180, 270, T#2ms, 3, ForcePLS );
```

```
PLSOutput := Inst_FB_AxisPlsPosModulo.oPLS;
```

5.2.13.41.9.2 Function Block Diagram

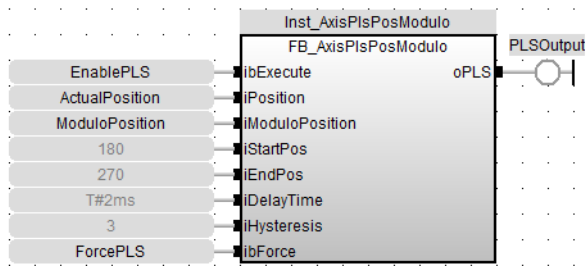

5.2.13.42.10.3 FFLD

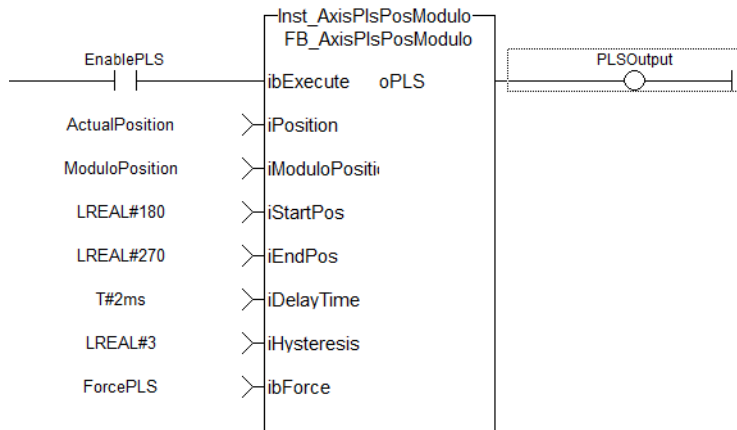

5.2.13.43 FB_AxisPlsPosNoModulo

PLCopen ✓

Pipe Network ✓

5.2.13.44.1 Description

This function block can be used for any position of a none-modulo axis in both directions. The Boolean output oPLS is set to TRUE if the position has crossed the start position and is set to FALSE if the position has crossed the end position. The function block has the possibility to compensate a delay time of the connected device, e.g. glue nozzles. It is also possible to define a hysteresis for switching on and off of the PLS.

5.2.13.45.2 Arguments

5.2.13.46.3.1 Input

ibExecute	Description	Enable PLS
	Data type	BOOL
iPosition	Description	Any position of a none-modulo axis
	Data type	LREAL
iStartPos	Description	Start position of PLS
	Data type	LREAL
iEndPos	Description	End position of PLS
	Data type	LREAL
iDelayTime	Description	Delay time for compensation
	Data type	TIME

iHysteresis	Description	Hysteresis
	Data type	LREAL
ibForce	Description	Force PLS
	Data type	BOOL

5.2.13.47.4.2 Output

oPLS	Description	Position limit switch
	Data type	BOOL

5.2.13.48.5 Example

5.2.13.49.6 Timing

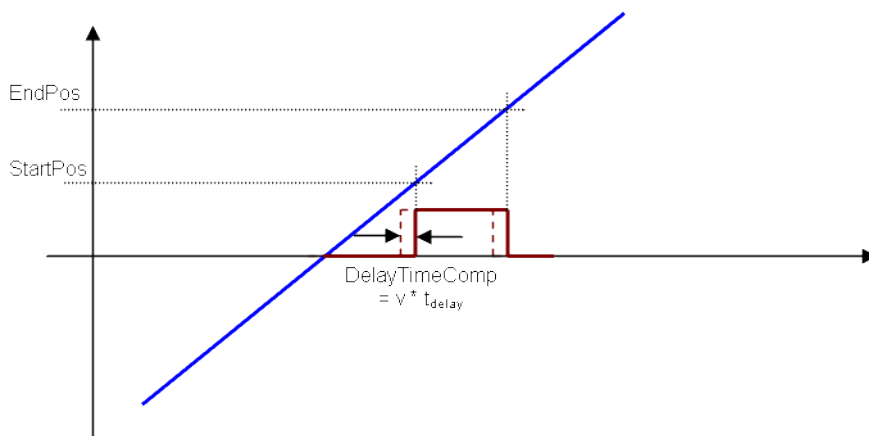

5.2.13.50.7 Hysteresis

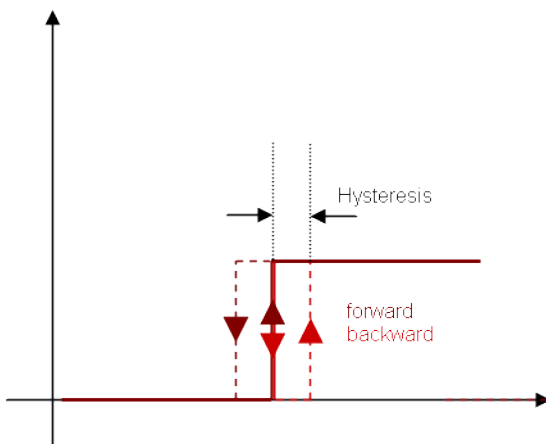

5.2.13.51.8.1 ST

```
//PLSOutput is True when position input is between 180 and 270
//with a T#2ms delay
//Can also force the output to be true with ForceOutput variable
//Hysteresis is on for 3 user units in case direction changes
```

around start point

```
Inst_FB_AxisPlsPosNoModulo( EnablePLS, ActualPosition, 180, 270,
T#2ms, 3, ForcePLS );
```

```
PLSOutput := Inst_FB_AxisPlsPosNoModulo.oPLS;
```

5.2.13.52.9.2 FBD

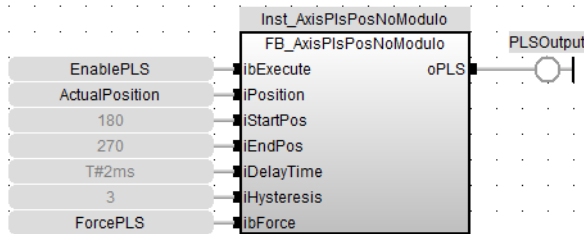

5.2.13.53.10.3 FFLD

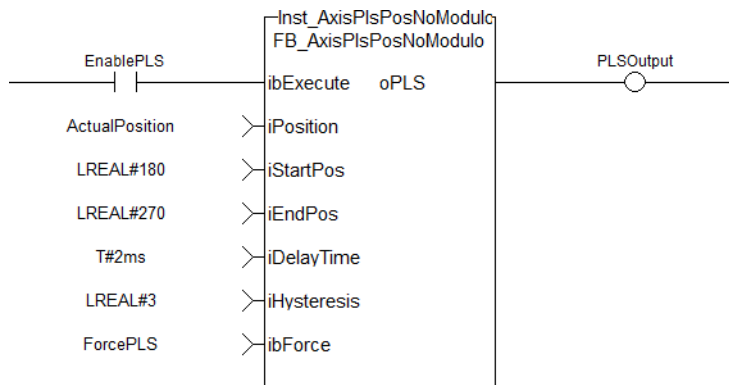

6 Index

A

Abort Camming	391
Abort Gearing	409, 413
actual position	
pipe network	172
actual velocity	353
AKDFaultLookup	
PLCopen	732, 734
AKDFItRpt	738
ASCII	570
AxisPlsPosModulo	745
AxisPlsPosNoModulo	747

C

Cam	
Aborting	391
Coordinated Motion	
Group Control items	480
Info items	506
List of Function Blocks	478
Motion items	525
Reference items	564
copyrights	2
CurrentPosition	
Pipe Network	172
curve	
synchronizer	308
cycle	
missed	570

D

debug	
EtherCAT	587
delay compensation	315
disclaimer	3
DriveParamRead	570
DriveParamWrite	575

E

ECATGetObjVal	590
ECATGetStatus	590
ECATReadData	586
ECATReadSdo	578
ECATSetControl	591
ECATWriteData	588
ECATWriteSdo	582
EtherCAT	
image	587-588
timeout	573
EtherCAT library	569

EtherCAT library function

DriveParamRead	570
DriveParamWrite	575
ECATGetObjVal	590
ECATGetStatus	590
ECATReadData	586
ECATReadSdo	578
ECATSetControl	591
ECATWriteData	588
ECATWriteSdo	582

F

falling edge	311
fast input	120, 316
fbCylinder	736
feed-forward	
torque-	203
feedback position	112, 172

G

Gear	
Aborting	409, 413
generator position	173
GetCtrlPerf	601

H

HomeFindHomeFastInput	650
HomeFindHomeFastInputModulo	655
HomeFindHomeInput	633
HomeFindHomeInputThenZeroAngle	636
HomeFindLimitFastInput	660
HomeFindLimitFastInputModulo	665
HomeFindLimitInput	638
HomeFindLimitInputThenZeroAngle	640
HomeFindZeroAngle	642
HomeMoveUntilPosErrExceeded	644
HomeMoveUntilPosErrExceededThenZeroAngle	646
HomeUsingCurrentPosition	648
homing	431

I

image EtherCAT	587-588
----------------------	---------

J

Jog	
Pipe Network	669
PLCopen	716

K

Kollmorgen UDFB	611, 617, 624, 727
AKDFaultLookup	732, 734
AKDFitRpt	738
AxisPlsPosModulo	745
AxisPlsPosNoModulo	747

fbCylinder	736
HomeFindHomeFastInput	650
HomeFindHomeFastInputModulo	655
HomeFindHomeInput	633
HomeFindHomeInputThenZeroAngle	636
HomeFindLimitFastInput	660
HomeFindLimitFastInputModulo	665
HomeFindLimitInput	638
HomeFindLimitInputThenZeroAngle	640
HomeFindZeroAngle	642
HomeMoveUntilPosErrExceeded	644
HomeMoveUntilPosErrExceededThenZeroAngle	646
HomeUsingCurrentPosition	648
Jog	669, 716
PlsPosFw	671
PlsPosFwBw	673
PlsTimeFw	675
S700FltRpt	742
ScaleInput	619
ScaleOutput	622
StepAbsolute	676
StepAbsSwitch	679
StepAbsSwitchFastInput	702
StepBlock	687
StepLimitSwitch	692
StepLimitSwitchFastInput	710
StepRefPulse	697
TemperaturePID	630

M

Mark-to-Machine	435
Mark-to-Mark	435
MC_AbortTrigger	343
MC_AddSuperAxis	449
MC_AxisSetDefaults	525
MC_CamIn	390
MC_CamOut	397
MC_CamResumePos	400
MC_CamStartPos	402
MC_CamTblSelect	406
MC_ClearFaults	325
MC_CreateAxesGrp	483
MC_CreateAxis	327
MC_ErrorDescription	337, 453
MC_EStop	330
MC_GearIn	409
MC_GearInPos	413
MC_GearOut	419
MC_GrpDisable	486
MC_GrpEnable	488
MC_GrpHalt	528
MC_GrpReadActAcc	506
MC_GrpReadActPos	509
MC_GrpReadActVel	511
MC_GrpReadBoolPar	490
MC_GrpReadCmdPos	514
MC_GrpReadCmdVel	517
MC_GrpReadError	519
MC_GrpReadStatus	521

MC_GrpReset	492
MC_GrpSetOverride	531
MC_GrpSetPos	564
MC_GrpStop	494
MC_GrpWriteBoolPar	497
MC_Halt	364
MC_InitAxesGrp	499
MC_InitAxis	332
MC_MachRegist	435
MC_MarkRegist	441
MC_MoveAbsolute	368
MC_MoveAdditive	373
MC_MoveCircAbs	533
MC_MoveCircRel	540
MC_MoveDirAbs	547
MC_MoveDirRel	550
MC_MoveLinAbs	553
MC_MoveLinRel	558
MC_MoveRelative	376
MC_MoveSuperimp	381
MC_MoveVelocity	385
MC_Phasing	422
MC_Power	335
MC_ReadActPos	350
MC_ReadActVel	352
MC_ReadAxisErr	353
MC_ReadBoolPar	355
MC_ReadParam	357
MC_ReadStatus	358
MC_Reference	427
MC_RemSuperAxis	451
MC_ResetError	339
MC_SetOverride	388
MC_SetPos	432
MC_SetPosition	435
MC_Stop	340
MC_StopRegist	447
MC_SyncSlaves	425
MC_TouchProbe	345
MC_UngroupAllAxes	504
MC_WriteBoolPar	361
MC_WriteParam	363
missing PLC cycles	570
MLAxisAbs	113
MLAxisActualPos	150
MLAxisAdd	117
MLAxisClrErrors	162
MLAxisGenStatus	153
MLAxisPowerOff	145
MLAxisPowerOn	145
MLAxisRefPos	123
MLAxisRun	143
MLAxisSetZero	174
MLCNVConECAT	205
MLPrfGetIRatio	182
MLPrfGetORatio	185
MLPrfSetIRatio	187
MLPrfSetORatio	190
MLProfileRelease	467
MLSmpConPLCAxis	297

MLSmpConPNAxis	298
MLTrigGetPos	318
MLTrigGetTime	320
motion library	81-82
adder	95
Axis	112
Block	88
CAM Profile	176
Comparator	191
Convertor	201
Delay	210
Derivator	211
Gear	216
Integrator	233
Master	236
Phaser	261, 569, 577, 586, 590
Pipe	82
PMP	269
Sampler	290
State Machine	469-470
Synchronizer	300
Trigger	309
motion library function	
MC_AbortTrigger	343
MC_CamIn	390
MC_CamOut	397
MC_CamTblSelect	406
MC_ClearFaults	325
MC_CreateAxis	327
MC_EStop	330
MC_GearIn	409
MC_GearInPos	413
MC_GearOut	419
MC_Halt	364
MC_InitAxis	332
MC_MachRegist	435
MC_MarkRegist	441
MC_MoveAbsolute	368
MC_MoveAdditive	373
MC_MoveRelative	376
MC_MoveSuperimp	381
MC_MoveVelocity	385
MC_Phasing	422
MC_Power	335
MC_ReadActPos	350
MC_ReadActVel	352
MC_ReadAxisErr	353
MC_ReadBoolPar	355
MC_ReadParam	357
MC_ReadStatus	358
MC_Reference	427
MC_ResetError	339
MC_SetOverride	388
MC_SetPos	432
MC_SetPosition	435
MC_Stop	340
MC_StopRegist	447
MC_SyncSlaves	425
MC_TouchProbe	345
MC_WriteBoolPar	361

MC_WriteParam	363
MLAxisAbs	113
MLAxisAdd	117
P	
phasing	
PLCopen	422
synchronizer pipe block	300
pipe position	173
PlsPosFw	671
PlsPosFwBw	673
PlsTimeFw	675
position	
actual position	172
feedback position	112, 172
generator position	173
pipe position	173
reference position	113, 173, 191
Position	
CurrentPosition	172
Power ON Delta Offset	173
Zero Offset	173
Power ON Delta Offset	
Pipe Network	173
PrintMessage	595
R	
reference position	113, 173, 191
registration	340, 435, 442
rising edge	311
S	
S-curve	281
S700FitRpt	742
ScaleInput	619
ScaleOutput	622
servo axis	332
state machine	
motion	470
stats	569-570, 578
StepAbsolute	676
StepAbsSwitch	679
StepAbsSwitchFastInput	702
StepBlock	687
StepLimitSwitch	692
StepLimitSwitchFastInput	710
StepRefPulse	697
SuperimposedCmdPos	449, 451
T	
TemperaturePID	630
timeout	
EtherCAT	573
torque feed-forward	203
trademarks	2

U**UDFB**

INOUT	611
out	611

V

Velocity, current	397, 419
--------------------------------	-----------------

Z**Zero Offset**

Pipe Network	173
--------------------	-----

About KOLLMORGEN

Kollmorgen is a leading provider of motion systems and components for machine builders. Through world-class knowledge in motion, industry-leading quality and deep expertise in linking and integrating standard and custom products, Kollmorgen delivers breakthrough solutions that are unmatched in performance, reliability and ease-of-use, giving machine builders an irrefutable marketplace advantage.



Join the [Kollmorgen Developer Network](#) for product support. Ask the community questions, search the knowledge base for answers, get downloads, and suggest improvements.

North America KOLLMORGEN

203A West Rock Road
Radford, VA 24141
USA

Web: www.kollmorgen.com
Mail: support@kollmorgen.com
Tel.: +1 - 540 - 633 - 3545
Fax: +1 - 540 - 639 - 4162

South America KOLLMORGEN

Avenida Tamboré, 1077 Tamboré - Barueri - SP Brasil
CEP: 06460-000

Web: www.kollmorgen.com
Mail: support@kollmorgen.com
Tel.: +55 11 4191-4771
Fax: +1 - 540 - 639 - 4162

Europe KOLLMORGEN Europe GmbH

Pempelfurtstraße 1
40880 Ratingen
Germany

Web: www.kollmorgen.com
Mail: technik@kollmorgen.com
Tel.: +49 - 2102 - 9394 - 0
Fax: +49 - 2102 - 9394 - 3155

China and SEA KOLLMORGEN

Room 202, Building 3, Lane 168,
Lin Hong Road, Changning District
Shanghai

Web: www.kollmorgen.cn
Mail: sales.china@kollmorgen.com
Tel.: +86 - 400 661 2802
Fax: +86 - 21 6128 9877