

# Kollmorgen Automation Suite

## Getting Started



**Document Edition: K, April 2018**

Valid for KAS Software Revision 3.0

Part Number: 959713

Keep all manuals as a product component during the life span of the product.  
Pass all manuals to future users / owners of the product.

**KOLLMORGEN**<sup>®</sup>

*Because Motion Matters™*

# Trademarks and Copyrights

## Copyrights

Copyright © 2009-2018 Kollmorgen™

Information in this document is subject to change without notice. The software package described in this document is furnished under a license agreement. The software package may be used or copied only in accordance with the terms of the license agreement.

This document is the intellectual property of Kollmorgen™ and contains proprietary and confidential information. The reproduction, modification, translation or disclosure to third parties of this document (in whole or in part) is strictly prohibited without the prior written permission of Kollmorgen™.

## Trademarks

- KAS and AKD are registered trademarks of [Kollmorgen™](#).
- [Kollmorgen™](#) is part of the [Fortive](#) Company.
- EnDat is a registered trademark of Dr. Johannes Heidenhain GmbH
- EtherCAT is a registered trademark and patented technology, licensed by Beckhoff Automation GmbH
- Ethernet/IP is a registered trademark of ODVA, Inc.
- Ethernet/IP Communication Stack: copyright (c) 2009, Rockwell Automation
- HIPERFACE is a registered trademark of Max Stegmann GmbH
- PROFINET is a registered trademark of PROFIBUS and PROFINET International (PI)
- SIMATIC is a registered trademark of SIEMENS AG
- Windows is a registered trademark of Microsoft Corporation
- [PLCopen](#) is an independent association providing efficiency in industrial automation.
- INtime® is a registered trademark of [TenAsys® Corporation](#).
- Codemeter is a registered trademark of [WIBU-Systems AG](#).
- SyCon® is a registered trademark of [Hilscher GmbH](#).
- Kollmorgen Automation Suite is based on the work of:
- [Qwt](#) project (distributed under the [terms](#) of the GNU Lesser General Public License - see also [GPL terms](#))
- [Zlib](#) software library
- [Curl](#) software library
- [Mongoose](#) software (distributed under the MIT License - [see terms](#))
- [JsonCpp](#) software (distributed under the MIT License – [see terms](#))
- [U-Boot](#), a universal boot loader is used by the PDMM (distributed under the [terms](#) of the GNU General Public License). The U-Boot source files, copyright notice, and readme are available on the distribution disk that is included with the PDMM.

All other product and brand names listed in this document may be trademarks or registered trademarks of their respective owners.

## Disclaimer

The information in this document (Version K published on 4/25/2018) is believed to be accurate and reliable at the time of its release. Notwithstanding the foregoing, Kollmorgen™ assumes no responsibility for any damage or loss resulting from the use of this help, and expressly disclaims any liability or damages for loss of data, loss of use, and property damage of any kind, direct, incidental or consequential, in regard to or arising out of the performance or form of the materials presented herein or in any software programs that accompany this document.

All timing diagrams, whether produced by Kollmorgen™ or included by courtesy of the PLCopen organization, are provided with accuracy on a best-effort basis with no warranty, explicit or implied, by Kollmorgen™. The user releases Kollmorgen™ from any liability arising out of the use of these timing diagrams.

# 1 Table of Contents

---

<b>1</b>	<b>Table of Contents</b>	<b>3</b>
<b>2</b>	<b>Introduction</b>	<b>4</b>
2.1	Related Documents	4
2.2	Alerts and Warnings	4
<b>3</b>	<b>System Overview</b>	<b>5</b>
3.1	Software Packages	5
3.2	Hardware Components	6
<b>4</b>	<b>Installing KAS IDE</b>	<b>7</b>
4.1	System Requirements	7
4.2	Download	7
4.3	Installation Procedure	8
4.3.1	User Data	9
<b>5</b>	<b>Installing KAS Runtime</b>	<b>10</b>
5.1	Updating the Runtime on PDMM & PCMM	10
<b>6</b>	<b>Installing Hardware</b>	<b>12</b>
6.1	HMI - Graphic Operator Interface	14
6.2	Install Controller - PDMM & PCMM	14
6.3	EtherCAT Motion Bus	14
6.4	Remote Input/Output - I/O Terminal	15
6.4.1	Installing Bus Terminals on mounting rails	16
6.4.1.1	Assembly	16
6.4.1.2	Disassembly	16
6.4.1.3	Connections within a bus terminal block	16
6.4.1.4	PE power contact	17
6.4.1.5	Wiring	17
6.4.2	Connection Details	17
6.5	Installing AKD Drive	18
6.6	Installing AKM Motor	18
<b>7</b>	<b>Updating Firmware</b>	<b>19</b>
7.1	AKD Firmware Update	20
<b>8</b>	<b>Installing Kollmorgen Visualization Builder</b>	<b>22</b>
8.1	Download	22
8.2	Installation Procedure	22
<b>9</b>	<b>Finalizing Installation</b>	<b>24</b>
9.1	Testing Installation	24
<b>10</b>	<b>Troubleshooting KAS</b>	<b>25</b>

## 2 Introduction

This guide covers the main following procedures to have your KAS system up and running:

- **Hardware Installation** (Connection and Wiring)  
Hardware details, connectors, system diagrams
- **Hardware Configuration**  
Basic configuration and settings needed to start the HW components  
(HMI + Industrial PC + Fieldbus + I/O)
- **KAS IDE Installation**  
KAS software setup

### 2.1 Related Documents

In addition to this Guide, you need the following manuals to install KAS

Title	Description
<a href="#">AKD Quick Start</a>	Contains all information needed to safely install and setup an AKD drive
<a href="#">AKD Installation Manual</a>	Covers the most important points to install the drive hardware and software. Provides instructions for basic drive setup and connection to a network
<a href="#">AKD EtherCAT Communication</a>	Describes the installation, setup, and software protocol for the EtherCAT AKD product series

### 2.2 Alerts and Warnings

When alert symbols are seen in a manual, be alert to the potential for personal injury. Follow the recommended precautions and safe operating practices included with the alert symbols. Safety notices in the manuals provide important information. Read and be familiar with these instructions before attempting to install, operate, or perform maintenance. The purpose of this section is to alert users to possible safety hazards associated with equipments and the precautions that need to be taken to reduce the risk of personal injury and damage to the equipment. Failure to observe these precautions could result in serious bodily injury, damage to the equipment, or operational difficulty.

## 3 System Overview

Kollmorgen Automation Suite is a complete system solution. This includes a variety of powerful software packages designed to give you complete control over your hardware.

### 3.1 Software Packages

Software	Description
<b>KAS IDE</b>	Provides you with all the necessary tools for designing, programming, configuring, debugging and maintaining machine applications
<b>KAS Runtime</b>	The KAS Runtime engine includes a soft PLC and a motion controller
<b>KVB (optional)</b>	This application is optional and assists in designing an HMI panel

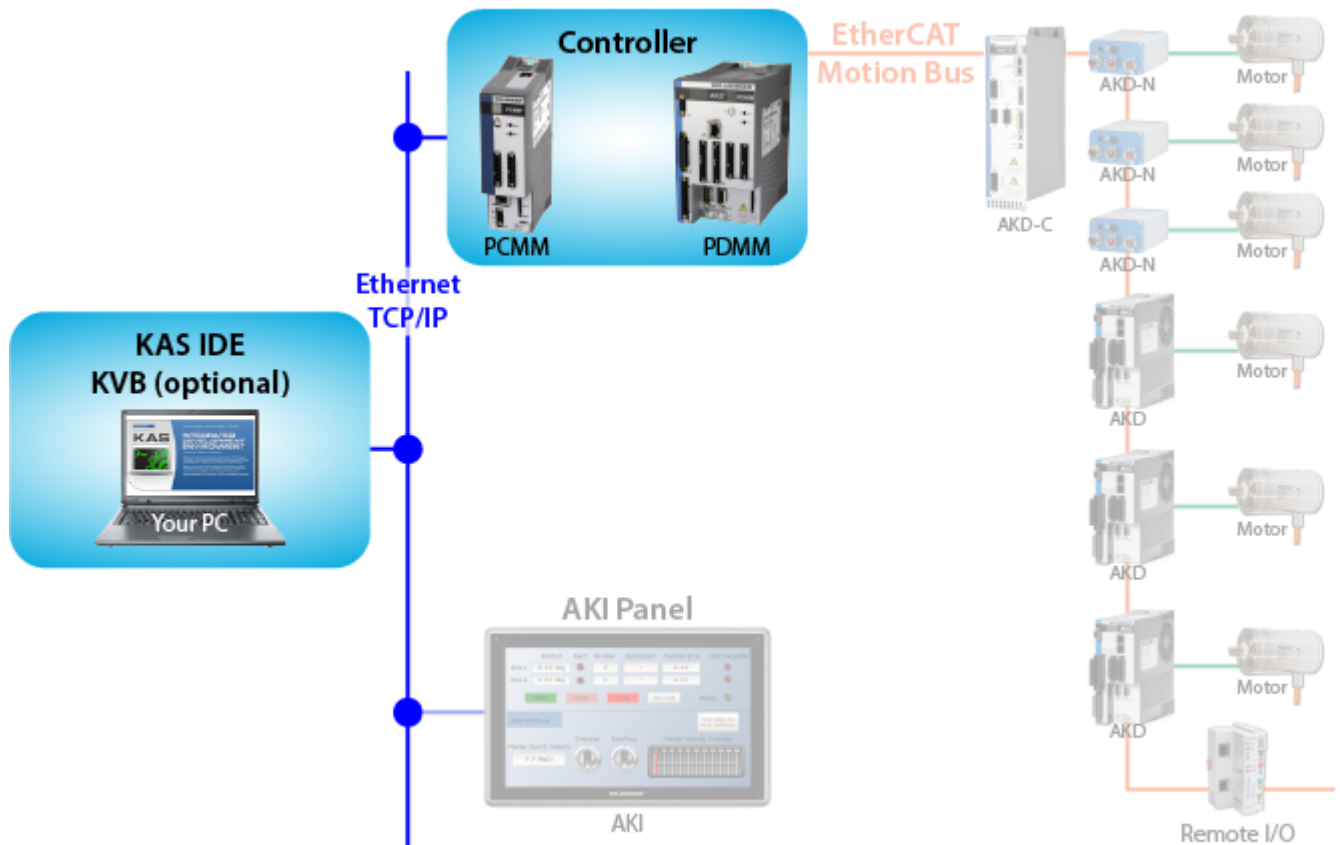

### 3.2 Hardware Components

The KAS system is comprised of the following hardware components.

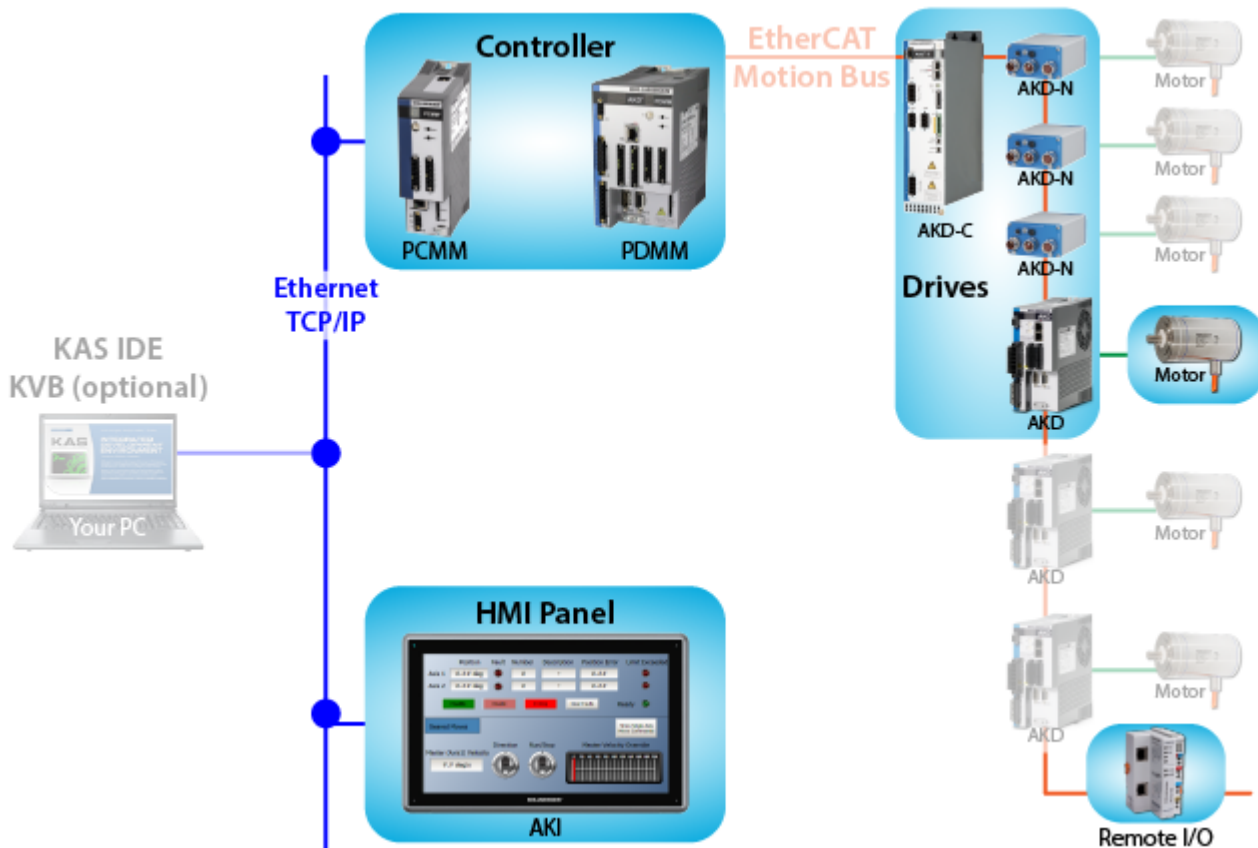

Component	Model(s)	Description
<b>Controller</b>	PCMM	Standalone programmable controller, providing a real-time platform with a PLC engine and motion engine to execute your application program and communicate with all network devices (remote I/O, drives, HMI, other PLCs, etc....).
<b>Controller + Drive</b>	PDMM	Integrated programmable controller and servo drive, providing a real-time platform with a PLC engine and motion engine to execute your application program and communicate with all network devices (remote I/O, drives, HMI, other PLCs, etc....).
<b>Remote I/O</b>	AKT	Digital and analog input and output signals that provide sensor feedback and actuation between your automation system and the physical world
<b>HMI</b>	AKI	Provides a graphical interface for the operator to manage the machine's operations.
<b>Drive</b>	AKD, AKD-C/N	Servo drives specifically designed with versatility, communications, and the power to expand machine performance
<b>Motor</b>	AKM	Servo motor is an actuator that allows for precise control of position, velocity, and acceleration by closing the control loop with a feedback device.



## 4 Installing KAS IDE

### 4.1 System Requirements

KAS IDE minimum system requirements:

Element	Description
<b>Operating System</b>	Microsoft® Windows® 7 SP1 (32 or 64-bit), Microsoft® Windows® 10 (32 or 64-bit). For optimal performance, please be sure your operating system is fully updated with the latest patches.
<b>Processor type</b>	Intel® Pentium® M or equivalent processor at 1.5 GHz or greater.
<b>Memory</b>	1 GB RAM (for 32-bit) or 2 GB RAM (for 64-bit) or greater (which is recommended for complex applications)
<b>Storage</b>	16 GB (for 32-bit) or 20 GB (for 64-bit) of free space on hard disk
<b>Display</b>	WXGA+ (1440 x 900) or higher-resolution monitor with 24-bit color. See Note #1 below.
<b>Connectivity</b>	1 Ethernet port, at either 100Mbps/s or 1Gbits/s. See Note #2 below.
<b>Web Browser</b>	A modern web browser is required to access the web server and online help. We recommend Internet Explorer (IE9 or later, see Note #3)  , Mozilla FireFox  , or Google Chrome  .

#### NOTE

1. Better results are achieved with OpenGL and 3D cards.
2. A 100Mb network is required in order to allow the IDE to Runtime communication to work in all conditions. The AKDWorkBench AutoTuner and Scope both require 100Mb of bandwidth to function properly.
3. IE9 should be considered a minimum. Later versions of the browser are more compliant with web standards and afford better performance and compatibility.

#### TIP

See the topic [Connect Remotely](#) for information about the ports used by KAS which may need to be opened to support connecting from an external network.

### 4.2 Download

The latest version of the Kollmorgen Automation Suite is available at [www.kollmorgen.com](http://www.kollmorgen.com).

## 4.3 Installation Procedure

### How to proceed if you have a CD/DVD

After inserting the installation CD or DVD, a web browser automatically displays the installation start page.

#### TIP

If the installation start page does not automatically display, double-click on the file **Index.html** file.

To start the installation of Kollmorgen Automation Suite, click the corresponding link and confirm that you want to execute **KAS-Setup.exe**.

Follow the procedure below to proceed with the KAS IDE software installation.

#### IMPORTANT

Installation of the KAS IDE can require you to change your firewall setting. If you do not have sufficient privileges to configure your firewall, you must stop the relevant Windows Service.

Once KAS has finished downloading, complete the following installation steps:

1. Double-click the **KAS-Setup.exe** file to run the installation Wizard.

#### NOTE

A Security Warning dialog displays as a result of security certification. Do not be alarmed.

2. Click **Run** to start the installation Wizard.
3. While the setup is loading, wait for the setup splash screen to vanish after being displayed.
4. If a previous version of the KAS IDE is installed then an uninstall notice is displayed. The previous version must be uninstalled before the installation can continue. All content of the previous repository is deleted during the uninstall.
5. The following Welcome Wizard displays with the version and build number of the KAS IDE. Click **Next** to continue.
6. Review the License Agreement and click "I Agree" to continue the installation.

#### NOTE

You must accept the agreement to install Kollmorgen Automation Suite.

7. Select the **Development Environment** installation type from the drop-down menu.

Installation type	Description
<b>Development Environment</b>	This kind of installation is typically used for creating and developing a new application. When you need to install the KAS IDE and the KAS Runtime Simulator, you can select Development Environment as the type of installation.
<b>Custom</b>	You can manually select the specific KAS components to install.

8. Click **Next** to access the destination folder.
9. Click **Browse** to specify a custom install directory or accept the recommended default location. When finished, click **Install** to continue.

#### TIP

Kollmorgen strongly recommends accepting the default destination folder under C:\Program Files\Kollmorgen\Kollmorgen Automation Suite\Kollmorgen Automation Suite.

10. The software installation begins. Wait until the installation process is complete.
11. You are done; click **Finish**.

#### TIP

Adding the **KAS IDE** application as an exception in your firewall settings is recommended to avoid security issues



### 4.3.1 User Data

User-generated data such as log files, project sources, field bus configurations, function blocks, etc. are stored in the Windows User directory and are maintained between installations. This applies to files on PDMMs, PCMMs, as well as Simulator files.

## 5 Installing KAS Runtime

The controller comes with all the necessary software already installed (including KAS Runtime).

### NOTE

KAS Runtime is only supported with Kollmorgen controllers.

### 5.1 Updating the Runtime on PDMM & PCMM

The KAS Runtime is contained in the PDMM and PCMM firmware, and comes pre-installed. Following is the procedure for updating the firmware and runtime using the KAS web server.

The firmware files are IMG files with the following name format:

`KAS-PCMM-M-{model-code}-{software-revision}.img`

`KAS-PDMM-M-{model-code}-{software-revision}.img`

The *model-code* reflects the CPU speed.

Model	CPU Speed	Cores
MCEC	800 MHz	single
M1EC	1.2 GHz	single
M2EC	1.2 GHz	dual

1. Download the latest drive firmware and/or runtime firmware from [Kollmorgen.com](http://Kollmorgen.com).
2. Open the controller's web server in your web browser by entering its IP address.
3. Select the **Settings** tabbed-page.
4. In the **Firmware** pane, click the **Choose File** button to select the new firmware image file for the KAS Runtime.

The recommended file is displayed in the **Current Information** section, as seen below.

#### Firmware Information

Firmware version `_2.10.0.54368`

Recommended File Name `_KAS-PDMM-M-MCEC-{version}.img`

5. Click **Upgrade** to start the update procedure.

#### TIP

If the Upgrade button is disabled, log into the webserver. Click on **Login** at the top of the web page and enter the password.

A message and a throbber are shown across the web page, indicating that maintenance is in progress. The device's 7-segment display will animate chasing lights.

#### Successful upgrade

A message similar to the following is shown upon a successful firmware upgrade:

**Upload of firmware KAS-PDMM-M-MCEC-2.10.0.54368.img successful.**

**Please reboot the unit in order to boot on the new firmware, and once reboot is performed, press CTRL+F5 in your web browser to force a page refresh.**

**Incompatible firmware** An error message similar to the following will be displayed if the wrong firmware file was downloaded:

**The file provided is not compatible with this device.**

**The file name should be...**

**"KAS-PDMM-M-MCEC-{version}.img"**

6. After the download is complete, click **Reboot**.

A message and a throbber are shown over the web server while the reboot is in progress. The login session will no longer be valid when the reboot is complete. The web server will display a message to indicate the user has been logged out.

#### **NOTE**

This step is not necessary if the controller automatically reboots during the upgrade (previous step).

7. Press **CTRL+F5** to force the web browser to refresh the page.

#### **ⓘ IMPORTANT**

Do not try to refresh the web page until firmware upgrade is done.

## 6 Installing Hardware

Before your motion application can be up and running, you first need to connect, wire and configure all your hardware components.

The **Getting Started** guide contains procedures for installing and configuring hardware components (HMI, controllers, I/O Terminals, EtherCAT Motion Bus, AKD Drive, and AKM Motor).

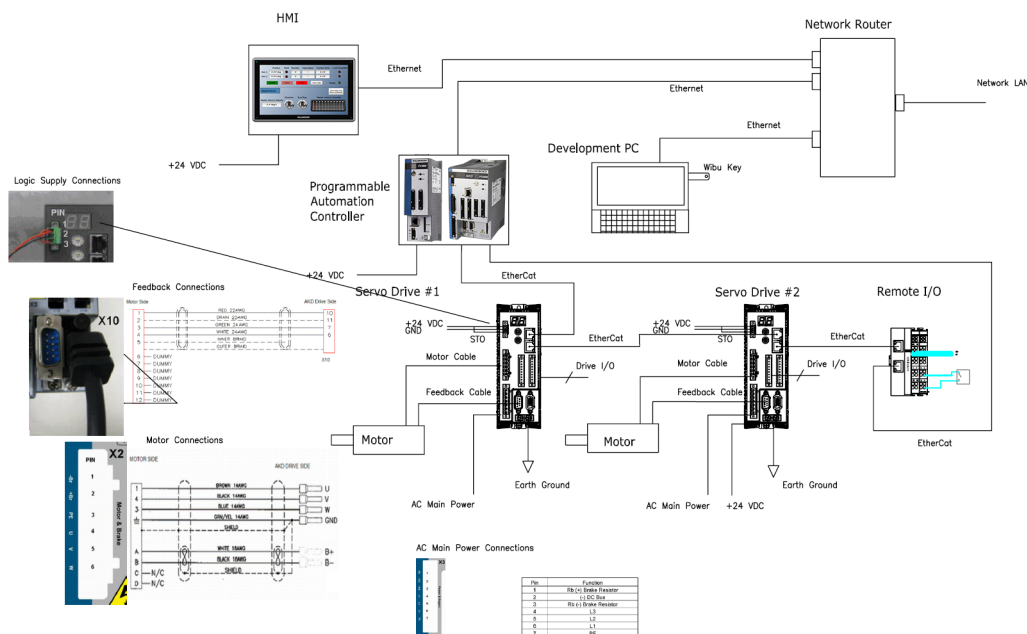

Figure 4-1: Connecting all the Hardware components

### NOTE

For extensive information about installing the different hardware components, see the relevant documentation available on:

- Kollmorgen [Website](#)
- KAS IDE online help (after it has been installed)

Links to installation instructions for hardware components can be found in the following table.

Component	Installation
HMI (Human-Machine Interface)	Install the graphic operator interface <a href="#">Install HMI</a>
Controller	Install the PCMM or PDMM controller "Install Controller - PDMM & PCMM" (p. 14)

Component		Installation
EtherCAT Motion Bus		Set up EtherCAT Motion Bus Communication See AKD™ EtherCAT Communication
I/O Terminal		Install the remote Input/Output Terminal <a href="#">Install I/O Terminals</a>
AKD Drive		Install the AKD Drive See AKD Installation Manual (and also AKD Quick Start)
AKM Motor		Install the AKM Motor Mechanical and Electrical installation Available from <a href="http://www.kollmorgen.com/">http://www.kollmorgen.com/</a>

Table 4-1: Kollmorgen Automation Suite Installation and Configuration

## 6.1 HMI - Graphic Operator Interface

Please find in the table below the list of each HMI component available:







HMI part number	Description	KVB	Tech. Manual
AKI2G-CDA-MOD-05T-000	Graphical Display 7" TFT LCD, Touchscreen	v2.20	
AKI2G-CDA-MOD-07T-000	Graphical Display 5" TFT LCD, Touchscreen	v2.20	
AKI2G-CDB-MOD-07T-000	Graphical Display 7" TFT LCD, Touchscreen	v2.20	
AKI2G-CDB-MOD-12T-000	Graphical Display 12" TFT LCD, Touchscreen	v2.20	
AKI-CDC-MOD-12T-000	Graphical Display 12.1" TFT LCD, Touchscreen	v2.0	
AKI-CDC-MOD-15T-000	Graphical Display 15.4" TFT LCD, Touchscreen	v2.0	
AKI-CDC-MOD-21T-000	Graphical Display 21.5" TFT LCD, Touchscreen	v2.0	

Table 4-2: List of KAS HMI

Please see the Kollmorgen website for specifications and Technical Manuals for more information.

## 6.2 Install Controller - PDMM & PCMM

The AKD PDMM and PCMM installation information may be found in the following locations.

Manual	Description
AKD PDMM Install Guide	 Covers the most important points to install the drive hardware and software. Provides instructions for basic drive setup and connection to a network
PCMM Install Guide	 Covers the most important points of the installation and setup of the controller.

## 6.3 EtherCAT Motion Bus

One EtherCAT master has to be connected with all the slaves (drives and I/O terminals) of your system. Please find all the details about the installation procedure for the EtherCAT Motion Bus in the following deliverable **AKD™ EtherCAT Communication** listed in the list of [References](#).

## 6.4 Remote Input/Output - I/O Terminal

Please find in the table below the list of each I/O component available.

I/O terminal part number	Description	Tech. Manual
AKT-AN-200-000	2 Channel Thermocouple Input Module	
AKT-AN-400-000	4 Channel Thermocouple Input Module	
AKT-AN-410-000	4 Channel Analog Input Module, 0-10 VDC	
AKT-AN-420-000	4 Channel Analog Input Module, 0-20 mA	
AKT-AN-810-000	8 Channel Analog Input Module, 0-10 VDC	
AKT-AN-820-000	8 Channel Analog Input Module, 0-20 mA	
ACCT-AT-220-000	2 Channel Analog Output Module, 0-20 mA	
AKT-AT-410-000	4 Channel Analog Output Module, 0-10 VDC	
AKT-AT-420-000	4 Channel Analog Output Module, 0-20 mA	
AKT-AT-810-000	8 Channel Analog Output Module, 0-10 VDC	
AKT-AT-820-000	8 Channel Analog Output Module, 0-20 mA	
AKT-DN-004-000	4 Channel Digital Input Module, 24 VDC 3ms	
AKT-DN-008-000	8 Channel Digital Input Module, 24 VDC 3ms	
AKT-DNH-004-000	4 Channel Digital Input Module, 24 VDC 0.2ms	
AKT-DNH-008-000	8 Channel Digital Input Module, 24 VDC 0.2ms	
AKT-DT-004-000	4 Channel Digital Output Module, 24 VDC 0.5A	
AKT-DT-008-000	8 Channel Digital Output Module, 24 VDC 0.5A	
AKT-DT-2RT-000	2 Channel Relay Output Module, 230 V AC 2.0A Rel.2NO Pot.-Free	
AKT-ECT-000-000	EtherCAT Bus Coupler	
AKT-EM-000-000	Standard-Bus End Terminal	
AKT-IM-000-000	Isolation / Separation Terminal	
AKT-PS-024-000	Power Supply, 24 VDC	
AKT-PSF-024-000	Fused Power Supply with diagnostics, 24 VDC	
AKT-SM-L15-000	Stepper Motor Terminal, 24 VDC, 1.5 A	

I/O terminal part number	Description	Tech. Manual
AKT-SM-L50-000	Stepper Motor Terminal, 50 VDC, 5 A	

**! IMPORTANT**

24-volt power is not passed through AKT-AN-200-000 and AKT-AN-400-000 thermocouple modules. To get 24VDC power to devices that need it (such as an AKT\_AT-410-000 Output module) there are two possible solutions. :

- Place the module requiring 24VDC before the thermocouple module.
- Add a power feed module (AKT-PS-024-000 or AKT-PSF-024-000) after the thermocouple module.

Table 4-3: List of KAS I/O Terminals

**6.4.1 Installing Bus Terminals on mounting rails****! CAUTION**

Bring the bus terminal system into a safe, powered down state before starting installation, disassembly or wiring of the Bus Terminals!

**6.4.1.1 Assembly**

The Bus Coupler and Bus Terminals are attached to commercially available 35 mm mounting rails (DIN rails according to EN 50022) by applying slight pressure:

1. First attach the Fieldbus Coupler to the mounting rail.
2. The Bus Terminals are now attached on the right-hand side of the Fieldbus Coupler. Join the components with tongue and groove and push the terminals against the mounting rail, until the lock clicks onto the mounting rail.  
If the Terminals are clipped onto the mounting rail first and then pushed together without tongue and groove, the connection is not operational! When correctly assembled, no significant gap is visible between the housings.

During the installation of the Bus Terminals, the locking mechanism of the terminals must not come into conflict with the fixing bolts of the mounting rail.

**6.4.1.2 Disassembly**

Each terminal is secured by a lock on the mounting rail, which must be released for disassembly:

1. Carefully pull the orange-colored lug approximately 1 cm out of the disassembled terminal, until it protrudes loosely. The lock with the mounting rail is now released for this terminal, and the terminal can be pulled from the mounting rail without excessive force.
2. Grasp the released terminal with thumb and index finger simultaneous at the upper and lower grooved housing surfaces and pull the terminal away from the mounting rail.

**6.4.1.3 Connections within a bus terminal block**

The electric connections between the Bus Coupler and the Bus Terminals are automatically realized by joining the components:

- The six spring contacts of the Standard/Performance Coupler deal with the transfer of the data and the supply of the Bus Terminal electronics.
- The power contacts deal with the supply for the field electronics and thus represent a supply rail within the bus terminal block. The power contacts are supplied via terminals on the Bus Coupler.

**NOTE**

During the design of a bus terminal block, the pin assignment of the individual Bus Terminals must be taken



account of, since some types (e.g. analog Bus Terminals or digital 4-channel Bus Terminals) do not or not fully loop through the power contacts. Power Feed Terminals (AKT-PS-024-000 or AKT-PSF-024-000) interrupt the power contacts and thus represent the start of a new supply rail.

#### 6.4.1.4 PE power contact

The power contact labeled PE can be used as a protective earth. For safety reasons this contact mates first when plugging together, and can ground short-circuit currents of up to 125 A.

#### **⚠ WARNING**

Note that, for reasons of electromagnetic compatibility, the PE contacts are capacitatively coupled to the mounting rail. It can lead to incorrect results during insulation testing or to damage on the terminal (e.g. disruptive discharge to the PE line during insulation testing of a consumer with a nominal voltage of 230 V).

For insulation testing, disconnect the PE supply line at the Bus Coupler or the Power Feed Terminal! In order to decouple further feed points for testing, these Power Feed Terminals can be released and pulled at least 10 mm from the group of terminals.

The PE power contact must not be used for other potentials!

#### 6.4.1.5 Wiring

Up to eight connections enable the connection of solid or finely stranded cables to the Bus Terminals. The terminals are implemented in spring force technology. Connect the cables as follows:

1. Open a spring-loaded terminal by slightly pushing with a screwdriver or a rod into the square opening above the terminal.
2. The wire can now be inserted into the round terminal opening without any force.
3. The terminal closes automatically when the pressure is released, holding the wire securely and permanently.

#### **NOTE**

Analog sensors and actors must always be connected with shielded, twisted paired wires.

### 6.4.2 Connection Details

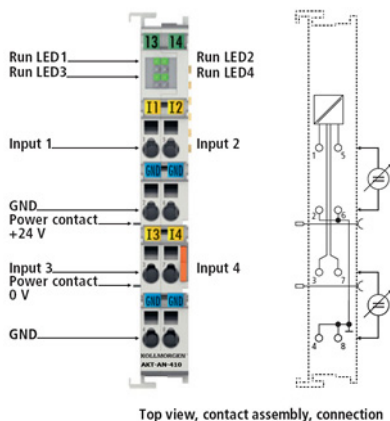

## 6.5 Installing AKD Drive

To install the AKD drive as well as the AKD GUI Views, refer to chapters 7 to 9 in the **AKD™ - Installation Manual**







Drives Guide	Description
<a href="#">AKD Quick Start</a>	 Contains all information needed to safely install and setup an AKD drive
<a href="#">AKD PDMM Installation Manual</a>	 Covers the most important points to install the drive hardware and software Provides instructions for basic drive setup and connection to a network
<a href="#">AKD User Manual</a>	 Describes how to use your drive in common applications. It also provides tips for maximizing your system performance with the AKD
<a href="#">AKD Accessories Manual</a>	 Includes technical data and dimensional drawings of accessories such as cables, brake resistors, and mains supplies
<a href="#">AKD EtherCAT Manual</a>	 Describes the installation, setup, range of functions, and software protocol for the EtherCAT AKD product series
<a href="#">S300 Reference Documentation</a>	 Kollmorgen website that gives access to all <b>S300</b> manuals
<a href="#">S700 Reference Documentation</a>	 Kollmorgen website that gives access to all <b>S700</b> manuals

Table 4-4: List of AKD Guides

## 6.6 Installing AKM Motor

To install rotary AKM Servomotors, refer to the following AKM deliverable:

- Chapters 17 to 19 in: **AKM™ Synchronous Servomotors - Product Manual**

### NOTE

This manual can be downloaded at  
[http://www.kollmorgen.com/uploadedfiles/Files/Document/Motors\\_and\\_Drives\\_Overview\\_Brochure.pdf](http://www.kollmorgen.com/uploadedfiles/Files/Document/Motors_and_Drives_Overview_Brochure.pdf)

## 7 Updating Firmware

Check the KAS software release notes to find the PDMM firmware version that matches with your KAS software version. The latest version of the firmware can be downloaded from the [Kollmorgen website](#).

To ensure your installation is correct, you have to:

- Check the current AKD drive firmware
- Download the official version, if necessary
- Update the firmware

### Check AKD Drive Firmware

To check PDMM Firmware with KAS IDE:

1. Create a new project
2. Set the controller type and IP address
3. In the Project Explorer, double-click the **EtherCAT** node to open the EtherCAT Devices summary window
4. In the Devices tab, click the **Scan Devices** button
5. Choose the **Create...** option to map the physical device to a new device

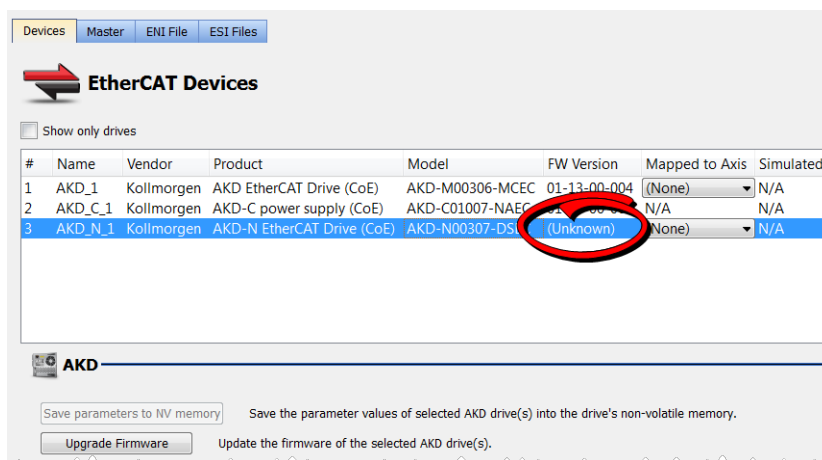

#### NOTE

If the firmware version is shown as "Unknown", the drive has valid resident firmware (from which to boot), but does not have valid operational firmware. Please download and install the latest operational firmware and reboot the AKD.



6. If the version is not correct, continue following with the procedure below
7. Compile the project
8. Connect to the controller
9. Download the project to the controller
10. If the version is not correct, download the new firmware ([click here](#)) and follow with the next procedure.

### Download PDMM Drive Firmware

Component	Firmware Version	Download
800MHz PDMM Drive FW	AKD-M-MCEC-V1.17-00-003.i00	
1.2GHz PDMM Drive FW	AKD-M-M1EC-V1.17-00-003.i00	

To upgrade PDMM drive Firmware with KAS IDE, continue from the previous procedure as follows:

1. In the toolbar, deactivate the Online Configuration Mode
2. Select the drives requiring the same firmware version to be updated  
(Note that the FW download is limited to 16 drives at a time)

**TIP**

Please note that the firmware download is limited to 16 drives at a time.

3. Click **Upgrade Firmware** button

**IMPORTANT**

Give careful attention to any warning dialog that appears at this point. These warnings usually include important information about preventing damage to the drives.

4. Browse to select the new AKD firmware file
5. Click **Open** to start the updating procedure

### 7.1 AKD Firmware Update

Based on the File Access over EtherCAT (FoE) protocol, the AKD drive Firmware can be downloaded as follows:

1. Scan the devices and make sure all devices are created
2. Compile the project
3. Connect to the controller
4. Download the project to the controller
5. Open the **EtherCAT Devices** summary form
6. Select the drives requiring the same firmware version to be updated
  - Multiple drives of the same type can be selected allowing the same firmware file to be downloaded to the selected drives simultaneously.
  - **AKD-P**: The last four letters of the model number must be the same for simultaneous firmware download.
  - **AKD-N**: The last four characters can be different. However, the firmware file selected to download must support all the selected models. The file `AKD-N-xxEC-*****.i00` supports multiple AKD-N models.
  - **AKD-C**: Devices with the product description "AKD-C String 2" do not support firmware download.

#	Name	Vendor	Product	Model	FW Version	Mapped to Axis	Simulated
1	AKD_1	Kollmorgen	AKD EtherCAT Drive (CoE)	AKD-M00306-MCEC-0000	01-14-00-002	(None)	N/A
2	AKD_C_1	Kollmorgen	AKD-C String 1 / Power supply/IO (CoE)	AKD-C00000-CBEC-E000	(Unknown)	N/A	N/A
3	AKD_N_1	Kollmorgen	AKD-N EtherCAT Drive (CoE)	AKD-N00307-DFEC-E000	01-14-00-002	(None)	N/A
4	AKD_C_2	Kollmorgen	AKD-C String 2	AKD-C00000-CBEC-0000	(Unknown)	N/A	N/A
5	AKD_N_2	Kollmorgen	AKD-N EtherCAT Drive (CoE)	AKD-N00307-DFEC-0000	01-14-00-002	(None)	N/A
6	AKD_N_3	Kollmorgen	AKD-N EtherCAT Drive (CoE)	AKD-N00307-DSEC-0000	01-14-00-002	(None)	N/A

7. Click the **Upgrade Firmware** button

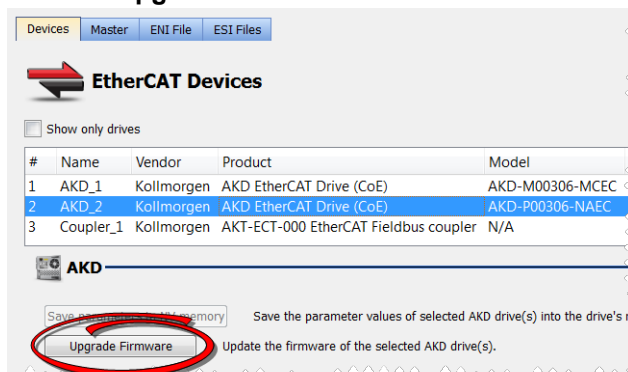

**ⓘ IMPORTANT**

Give careful attention to any warning dialog that appears at this point. These warnings usually include important information about preventing damage to the drives.

8. Browse to select the new AKD firmware file matching the AKD revision. Refer to the Release Notes for the latest supported firmware.
9. Click **Open** to start the updating procedure

**NOTE**

This procedure is not possible when applications are running and when the drive is in Online Configuration Mode.

During the firmware download, the AKD Firmware Update window displays a progress bar and the following messages are displayed:

- Uploading firmware to the drive  
During the download process, the drive LED displays [dL]. Additional codes may appear during the download; see 3.2 Display Codes for a description of codes related to the firmware download.
- Resetting the drive
- Firmware update is complete

**⚠ CAUTION**

While the firmware is downloading to your drive, do not remove the 24V logic power. If you remove the 24V logic power during a firmware download, a severe drive crash can occur. If a crash occurs, the drive will restart in a special mode and prompt you to reload the firmware.

**ⓘ IMPORTANT**

An AKD drive executing the resident firmware is detected as a different device than an AKD drive executing the operational firmware. Be sure to re-scan the network and compile it if a drive's executed firmware has changed since the last scan.

**👉 TIP**

Power cycling is recommended after completing the update for all drives.

## 8 Installing Kollmorgen Visualization Builder

Kollmorgen Visualization Builder (or KVB) allows you to design HMI running on AKI panels. KVB is an optional feature that is only included in some licenses.

### NOTE

Kollmorgen Visualization Builder contains the two following installation packages:

- Kollmorgen Visualization Builder(KVB IDE) for development PC
- Visualizer RT(KVB RT) for AKI panel runtime

### 8.1 Download

Component	Version	Download
<a href="#">Latest Version of Kollmorgen Visual Builder</a>	v.2.20	302.9 MB
Visualizer RT (KVB RT)	v. 1.20	78 MB

### 8.2 Installation Procedure

The following programs will automatically be installed during the KVB can be installed:

- Microsoft .NET Compact Framework 3.5
- Microsoft SQL Server Compact 3.5
- Microsoft Visual C++ 2013 - Redistributable Setup

Once Kollmorgen Visualization Builder has finished downloading, complete the following installation steps:

1. Double-click the **Setup.exe** file to run the installation Wizard

### NOTE

If KVB was already installed and you want to update to a new version, then running **NeoSetup.msi** is enough.

2. Select the check box to accept the License agreement and click **Next** to start installing **Kollmorgen Visualization Builder**.
3. Select where you want to install **Kollmorgen Visualization Builder** and the application language, then click **Next**

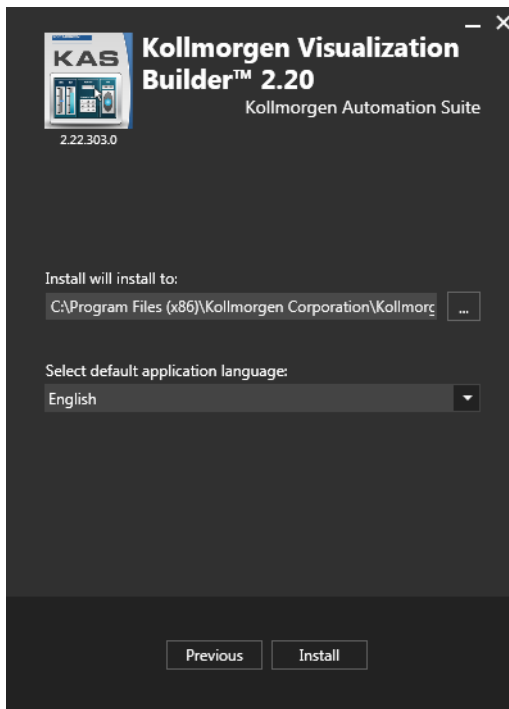

Kollmorgen strongly recommends accepting the default destination folder under C:\Program Files (x86)\Kollmorgen\Kollmorgen Visualization Builder\

4. Click **Install** to start **Kollmorgen Visualization Builder** installation
5. Click **Close** or to start using KVB right away, click **Launch**.

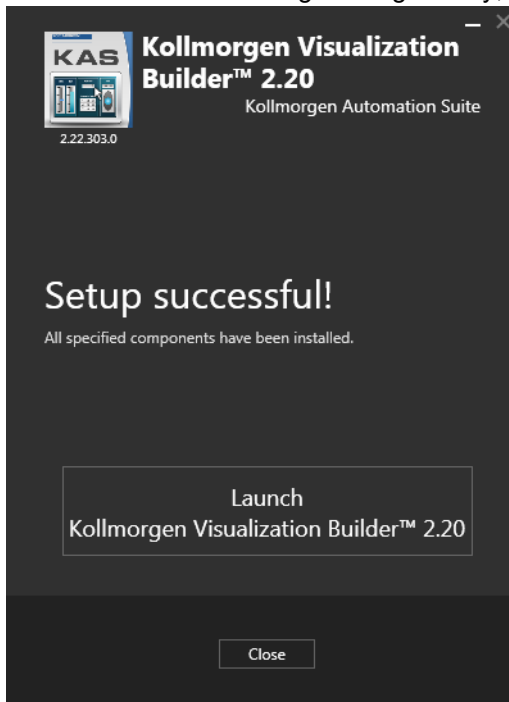

## 9 Finalizing Installation

To complete the KAS installation, you can optionally:

- Test the system
- Create a backup image

### 9.1 Testing Installation

To conclude your installation, the whole system has to be tested.

A test could be done with the standard Two-Axis Template that corresponds to a simple application (refer to **KAS 30 Minutes to Motion**).



## 10 Troubleshooting KAS

Faults occur for a variety of reasons, depending on the conditions in your installation. The causes of faults in multi-axis systems can be especially complex.

### **TIP**

You can find more details in:

- the **Troubleshooting** chapter in the online help
- the Faults and Warnings section of the online help
- searching KDN (Kollmorgen Developer Network at [KDN.Kollmorgen.com](https://kdn.kollmorgen.com)) for answers, or submit a question.

## About KOLLMORGEN

Kollmorgen is a leading provider of motion systems and components for machine builders. Through world-class knowledge in motion, industry-leading quality and deep expertise in linking and integrating standard and custom products, Kollmorgen delivers breakthrough solutions that are unmatched in performance, reliability and ease-of-use, giving machine builders an irrefutable marketplace advantage.



Join the [Kollmorgen Developer Network](#) for product support. Ask the community questions, search the knowledge base for answers, get downloads, and suggest improvements.

### North America KOLLMORGEN

203A West Rock Road  
Radford, VA 24141  
USA

**Web:** [www.kollmorgen.com](http://www.kollmorgen.com)  
**Mail:** [support@kollmorgen.com](mailto:support@kollmorgen.com)  
**Tel.:** +1 - 540 - 633 - 3545  
**Fax:** +1 - 540 - 639 - 4162

### South America KOLLMORGEN

Avenida Tamboré, 1077 Tamboré -  
Barueri - SP Brasil  
CEP: 06460-000

**Web:** [www.kollmorgen.com](http://www.kollmorgen.com)  
**Tel.:** +55 11 4191-4771

### Europe KOLLMORGEN Europe GmbH

Pempelfurtstraße 1  
40880 Ratingen  
Germany

**Web:** [www.kollmorgen.com](http://www.kollmorgen.com)  
**Mail:** [technik@kollmorgen.com](mailto:technik@kollmorgen.com)  
**Tel.:** +49 - 2102 - 9394 - 0  
**Fax:** +49 - 2102 - 9394 - 3155

### China and Southeast Asia KOLLMORGEN Asia

Floor 4, Building 9, No. 518,  
North Fuquan Road,  
Changning District  
Shanghai 200335, China

**Web:** [www.kollmorgen.cn](http://www.kollmorgen.cn)  
**Mail:** [sales.china@kollmorgen.com](mailto:sales.china@kollmorgen.com)  
**Tel.:** +86 - 400 - 661 - 2802  
**Fax:** +86 - 21 - 6071 - 0665

**KOLLMORGEN**<sup>®</sup>

*Because Motion Matters™*