

Kollmorgen Automation Suite

Getting Started



Document Edition: J, June 2017

Valid for KAS Software Revision 2.12

Part Number: 959713

Keep all manuals as a product component during the life span of the product.
Pass all manuals to future users / owners of the product.

Trademarks and Copyrights

Copyrights

Copyright © 2009-17 Kollmorgen™

Information in this document is subject to change without notice. The software package described in this document is furnished under a license agreement. The software package may be used or copied only in accordance with the terms of the license agreement.

This document is the intellectual property of Kollmorgen™ and contains proprietary and confidential information. The reproduction, modification, translation or disclosure to third parties of this document (in whole or in part) is strictly prohibited without the prior written permission of Kollmorgen™.

Trademarks

- KAS and AKD are registered trademarks of [Kollmorgen™](#).
- [Kollmorgen™](#) is part of the [Fortive](#) Company.
- EnDat is a registered trademark of Dr. Johannes Heidenhain GmbH
- EtherCAT is a registered trademark and patented technology, licensed by Beckhoff Automation GmbH
- Ethernet/IP is a registered trademark of ODVA, Inc.
- Ethernet/IP Communication Stack: copyright (c) 2009, Rockwell Automation
- HIPERFACE is a registered trademark of Max Stegmann GmbH
- PROFINET is a registered trademark of PROFIBUS and PROFINET International (PI)
- SIMATIC is a registered trademark of SIEMENS AG
- Windows is a registered trademark of Microsoft Corporation
- [PLCopen](#) is an independent association providing efficiency in industrial automation.
- INtime® is a registered trademark of [TenAsys® Corporation](#).
- Codemeter is a registered trademark of [WIBU-Systems AG](#).
- SyCon® is a registered trademark of [Hilscher GmbH](#).
- Kollmorgen Automation Suite is based on the work of:
 - [Qwt](#) project (distributed under the [terms](#) of the GNU Lesser General Public License - see also [GPL terms](#))
 - [Zlib](#) software library
 - [Curl](#) software library
 - [Mongoose](#) software (distributed under the MIT License - [see terms](#))
 - JsonCpp software (distributed under the MIT License – [see terms](#))
 - [U-Boot](#), a universal boot loader is used by the PDMM (distributed under the [terms](#) of the GNU General Public License). The U-Boot source files, copyright notice, and readme are available on the distribution disk that is included with the PDMM.

All other product and brand names listed in this document may be trademarks or registered trademarks of their respective owners.

Disclaimer

The information in this document (Version J published on 6/22/2017) is believed to be accurate and reliable at the time of its release. Notwithstanding the foregoing, Kollmorgen™ assumes no responsibility for any damage or loss resulting from the use of this help, and expressly disclaims any liability or damages for loss of data, loss of use, and property damage of any kind, direct, incidental or consequential, in regard to or arising out of the performance or form of the materials presented herein or in any software programs that accompany this document.

All timing diagrams, whether produced by Kollmorgen™ or included by courtesy of the PLCopen organization, are provided with accuracy on a best-effort basis with no warranty, explicit or implied, by Kollmorgen™. The user releases Kollmorgen™ from any liability arising out of the use of these timing diagrams.

1 Table of Contents

1	Table of Contents	3
2	Introduction	5
2.1	Related Documents	5
2.2	Alerts and Warnings	5
3	System Overview	6
3.1	Software Packages	6
3.2	Hardware Components	7
4	Installing KAS IDE	8
4.1	System Requirements	8
4.2	Download	8
4.3	Installation Procedure	9
4.3.1	User Data	10
5	Installing KAS Runtime	11
5.1	System Requirements	11
5.2	Installation Procedure	11
5.3	Updating the Runtime on PDMM & PCMM	12
6	Installing Hardware	14
6.1	HMI - Graphic Operator Interface	16
6.2	Install Controller - PDMM & PCMM	16
6.3	Controller - AKC (PAC)	16
6.3.1	Deploying AKC (PAC) standard image	17
6.3.2	Configuring INtime	18
6.4	EtherCAT Motion Bus	19
6.5	Remote Input/Output - I/O Terminal	19
6.5.1	Installing Bus Terminals on mounting rails	20
6.5.1.1	Assembly	20
6.5.1.2	Disassembly	20
6.5.1.3	Connections within a bus terminal block	20
6.5.1.4	PE power contact	21
6.5.1.5	Wiring	21
6.5.2	Connection Details	21
6.6	Installing AKD Drive	22
6.7	Installing AKM Motor	22
7	Updating Firmware	23
7.1	AKD Firmware Update	24
8	Installing Kollmorgen Visualization Builder	26
8.1	Download	26
8.2	Installation Procedure	26
9	Finalizing Installation	28
9.1	Testing Installation	28
9.2	Saving Installation	28
9.2.1	Backup AKC Image	28
9.2.1.1	Prepare the bootable USB Stick	28
9.2.1.2	Create the Backup	31

9.2.2 Enhanced Write Filter	31
9.2.2.1 Practical Applications	32
9.2.3 Enhanced Write Filter Operational Procedures Using the Application	32
9.2.3.1 Protect the PAC Image with EWF	32
9.2.3.2 Perform Changes on a Protected Volume	33
9.2.4 Enhanced Write Filter Operational Procedures using the command line	33
9.2.4.1 Protect the PAC Image with EWF	33
9.2.4.2 Perform Changes on a Protected Volume	34
9.2.4.3 Perform Small Changes on a Protected Volume	34
9.2.5 Restore AKC (PAC) Backup Image	34
10 Troubleshooting KAS	35

2 Introduction

This guide covers the main following procedures to have your KAS system up and running:

- **Hardware Installation** (Connection and Wiring)
Hardware details, connectors, system diagrams
- **Hardware Configuration**
Basic configuration and settings needed to start the HW components
(HMI + Industrial PC + Fieldbus + I/O)
- **KAS IDE Installation**
KAS software setup

2.1 Related Documents

In addition to this Guide, you need the following manuals to install KAS

Title	Description
AKD Quick Start	Contains all information needed to safely install and setup an AKD drive
AKD Installation Manual	Covers the most important points to install the drive hardware and software. Provides instructions for basic drive setup and connection to a network
AKD EtherCAT Communication	Describes the installation, setup, and software protocol for the EtherCAT AKD product series

2.2 Alerts and Warnings

When alert symbols are seen in a manual, be alert to the potential for personal injury. Follow the recommended precautions and safe operating practices included with the alert symbols. Safety notices in the manuals provide important information. Read and be familiar with these instructions before attempting to install, operate, or perform maintenance. The purpose of this section is to alert users to possible safety hazards associated with equipments and the precautions that need to be taken to reduce the risk of personal injury and damage to the equipment. Failure to observe these precautions could result in serious bodily injury, damage to the equipment, or operational difficulty.

3 System Overview

Kollmorgen Automation Suite is a complete system solution. This includes a variety of powerful software packages designed to give you complete control over your hardware.

3.1 Software Packages

Software	Description
KAS IDE	Provides you with all the necessary tools for designing, programming, configuring, debugging and maintaining machine applications
KAS Runtime	The KAS Runtime engine includes a soft PLC and a motion controller
KVB (optional)	This application is optional and assists in designing an HMI panel

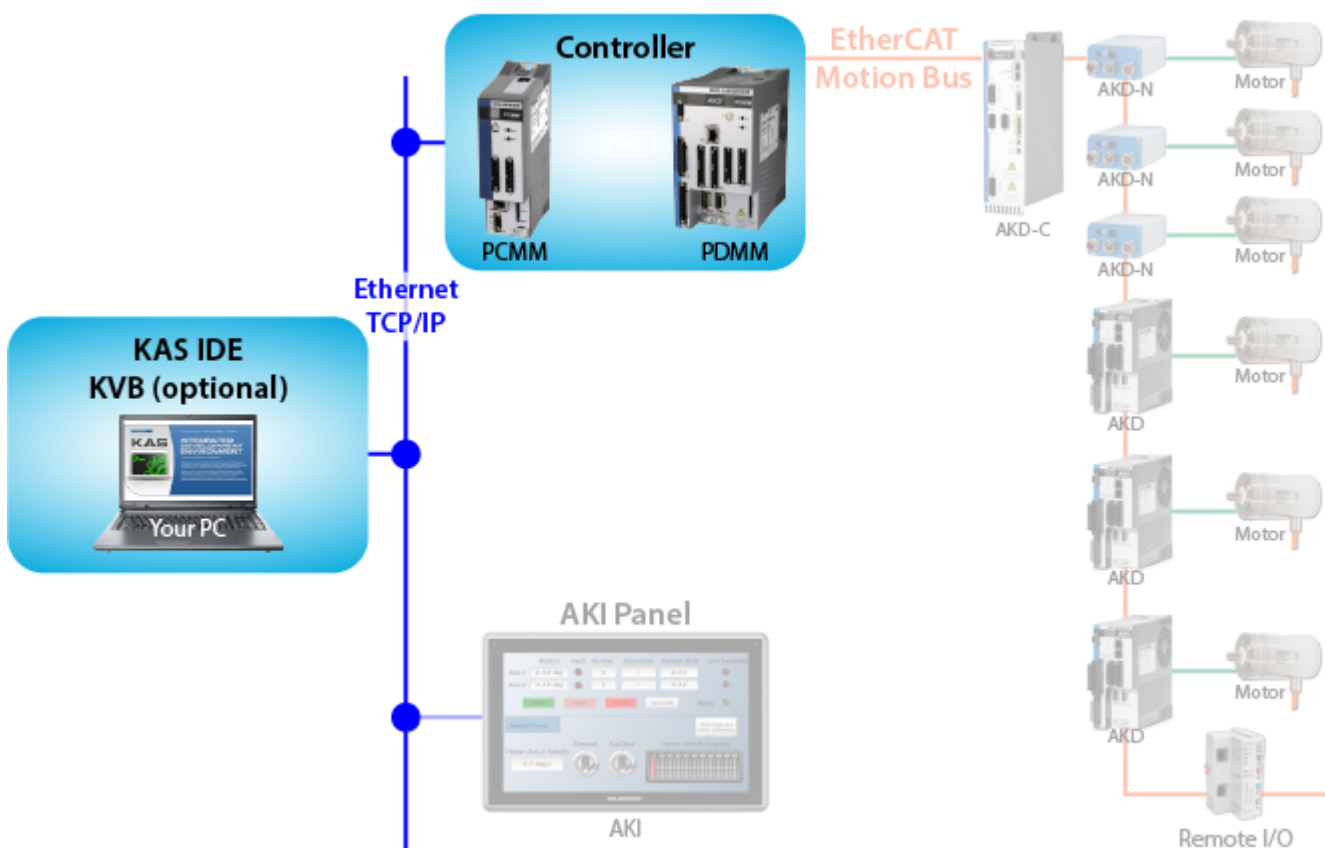

! IMPORTANT

Do not install KAS IDE on the Kollmorgen PAC controllers. The two are **not** compatible.

3.2 Hardware Components

The KAS system is comprised of the following hardware components.

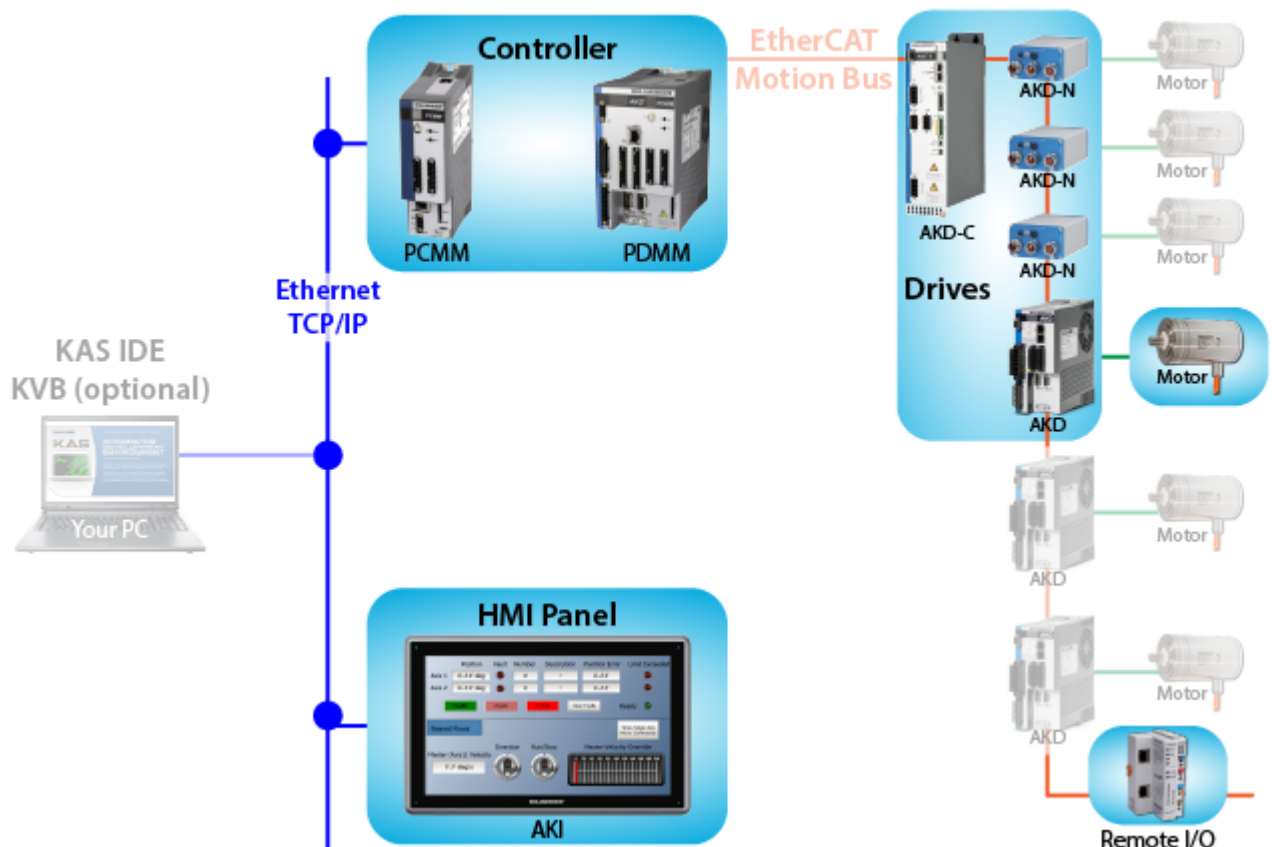

Component	Model(s)	Description
Controller	PCMM	Standalone programmable controller, providing a real-time platform with a PLC engine and motion engine to execute your application program and communicate with all network devices (remote I/O, drives, HMI, other PLCs, etc....).
Controller + Drive	PDMM	Integrated programmable controller and servo drive, providing a real-time platform with a PLC engine and motion engine to execute your application program and communicate with all network devices (remote I/O, drives, HMI, other PLCs, etc....).
Remote I/O	AKT	Digital and analog input and output signals that provide sensor feedback and actuation between your automation system and the physical world
HMI	AKI	Provides a graphical interface for the operator to manage the machine's operations.
Drive	AKD, AKD-C/N	Servo drives specifically designed with versatility, communications, and the power to expand machine performance
Motor	AKM	Servo motor is an actuator that allows for precise control of position, velocity, and acceleration by closing the control loop with a feedback device.



4 Installing KAS IDE

4.1 System Requirements

KAS IDE minimum system requirements:

Element	Description
Operating System	Microsoft® Windows® 7 SP1 (32 or 64-bit). For optimal performance, please be sure your operating system is fully updated with the latest patches.
Processor type	Intel® Pentium® M or equivalent processor at 1.5 GHz or greater.
Memory	1 GB RAM or greater (which is recommended for complex applications)
Storage	1 GB hard drive or compact flash space
Display	WXGA+ (1440 x 900) or higher-resolution monitor with 24-bit color. See Note #1 below.
Connectivity	1 Ethernet port, at either 100Mbps/s or 1Gbits/s. See Note #2 below.
Web Browser	A modern web browser is required to access the web server and online help. We recommend Internet Explorer (IE9 or later, see Note #3)  , Mozilla FireFox  , or Google Chrome  .

NOTE

1. Better results are achieved with OpenGL and 3D cards.
2. A 100Mb network is required in order to allow the IDE to Runtime communication to work in all conditions. The AKDWorkBench AutoTuner and Scope both require 100Mb of bandwidth to function properly.
3. IE9 should be considered a minimum. Later versions of the browser are more compliant with web standards and afford better performance and compatibility.

TIP

See the topic [Connect Remotely](#) for information about the ports used by KAS which may need to be opened to support connecting from an external network.

IMPORTANT

KAS IDE and KAS Simulator should not be installed on a Kollmorgen Industrial PC (PAC). The IDE and Simulator are for use on PCs only.

4.2 Download

The latest version of the Kollmorgen Automation Suite is available at www.kollmorgen.com.

4.3 Installation Procedure

How to proceed if you have a CD/DVD

After inserting the installation CD or DVD, a web browser automatically displays the installation start page.

TIP

If the installation start page does not automatically display, double-click on the file **Index.html** file.

To start the installation of Kollmorgen Automation Suite, click the corresponding link and confirm that you want to execute **KAS-Setup.exe**.

Follow the procedure below to proceed with the KAS IDE software installation.

IMPORTANT

Installation of the KAS IDE can require you to change your firewall setting. If you do not have sufficient privileges to configure your firewall, you must stop the relevant Windows Service.

Once KAS has finished downloading, complete the following installation steps:

1. Double-click the **KAS-Setup.exe** file to run the installation Wizard.

NOTE

A Security Warning dialog displays as a result of security certification. Do not be alarmed.

2. Click **Run** to start the installation Wizard.
3. While the setup is loading, wait for the setup splash screen to vanish after being displayed.
4. If a previous version of the KAS IDE is installed then an uninstall notice is displayed. The previous version must be uninstalled before the installation can continue. All content of the previous repository is deleted during the uninstall.
5. The following Welcome Wizard displays with the version and build number of the KAS IDE. Click **Next** to continue.
6. Review the License Agreement and click "I Agree" to continue the installation.

NOTE

You must accept the agreement to install Kollmorgen Automation Suite.

7. Select the **Development Environment** installation type from the drop-down menu.

Installation type	Description
Development Environment	This kind of installation is typically used for creating and developing a new application. When you need to install the KAS IDE and the KAS Runtime Simulator, you can select Development Environment as the type of installation.
Run-time Industrial PC	This installation is typically used when you have an AKC (PAC). You are able to view and run your application. You need to install Kollmorgen Visualization Builder and the KAS Runtime. Kollmorgen Visualization Builder is specially designed to view and control your application. The KAS Runtime only executes the application.
Custom	You can manually select the specific KAS components to install.

8. Click **Next** to access the destination folder.
9. Click **Browse** to specify a custom install directory or accept the recommended default location. When finished, click **Install** to continue.

 **TIP**

Kollmorgen strongly recommends accepting the default destination folder under C:\Program Files\Kollmorgen\Kollmorgen Automation Suite\Kollmorgen Automation Suite.

10. The software installation begins. Wait until the installation process is complete.
11. You are done; click **Finish**.

 **TIP**

Adding the **KAS IDE** application as an exception in your firewall settings is recommended to avoid security issues

4.3.1 User Data

User-generated data such as log files, project sources, field bus configurations, function blocks, etc. are stored in the Windows User directory and are maintained between installations. This applies to files on PACs, PDMs, PCMMs, as well as Simulator files.

5 Installing KAS Runtime

The controller comes with all the necessary software already installed (including KAS Runtime). The image version is displayed on the background image of the PAC desktop.

NOTE

KAS Runtime is only supported with Kollmorgen controllers.

5.1 System Requirements

Requirement	Description
Operating System	The KAS Runtime is supported under XP embedded (XPe) for the industrial PC.
Recommended network environment	Only a Local Network connection can ensure the communicate between the KAS IDE and the KAS Runtime.
Supported Kollmorgen Industrial PC	KAS Runtime is compatible with AKC hardware models

IMPORTANT

The KAS IDE is not able to communicate to the KAS Runtime through NAT connection.

5.2 Installation Procedure

Install the KAS Runtime software.

1. Double-click the **KAS-Setup.exe** file to run the installation Wizard
2. Click **Run** to launch the setup wizard
3. Wait for the setup splash screen to vanish after being displayed
4. The welcome wizard appears and show you the version and build number, click **Next** to continue the wizard
5. In the drop-down menu, choose the type of installation to deploy: **Run-time Industrial PC**

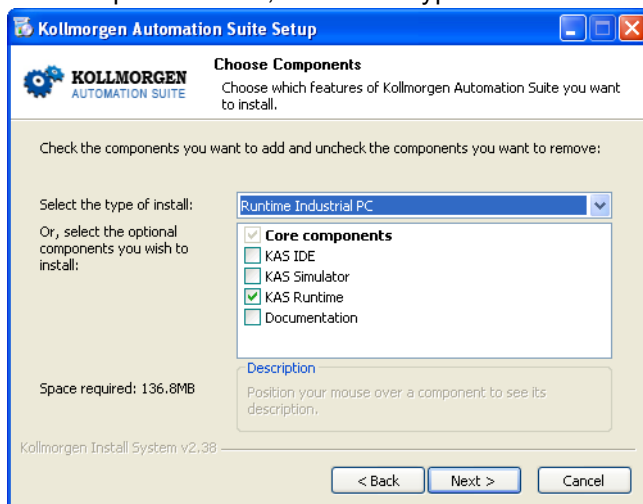

Figure 3-1: Install Run-time for Industrial PC

(See the different Types of Deployment in "Installing KAS IDE" (p. 8))

6. Click **Next** to access the destination folder

7. Select where you want to install KAS

Kollmorgen strongly recommends accepting the default destination folder under C:\Program Files\Kollmorgen\Kollmorgen Automation Suite

8. Keep the name proposed for the Start Menu Folder and click the **Install** button to install KAS

9. You have to wait until the end of the process

10. Wait until the installation is complete

NOTE

If your Wibu-Key driver is not already installed, a reminder is displayed saying that the WKRruntime.exe needs to be installed. If so, click **OK**.

11. Click **Finish**

NOTE

The EWF filter must be activated on the AKC (PAC) when everything is ready and must not change anymore. If a significant change happens (like a new KAS version or downloading a new application), the recommendation is to turn off the EWF filter, make the change, and then reactivate it. For more details about this procedure, "[Enhanced Write Filter](#)" (p. 31)

NOTE

After the KAS Runtime installation, you have to restart the AKC (PAC).

5.3 Updating the Runtime on PDMM & PCMM

The KAS Runtime is contained in the PDMM and PCMM firmware, and comes pre-installed. Following is the procedure for updating the firmware and runtime using the KAS web server.

The firmware files are IMG files with the following name format:

KAS-PCMM-M-*{model-code}*-*{software-revision}*.img

KAS-PDMM-M-*{model-code}*-*{software-revision}*.img

The *model-code* reflects the CPU speed.

Model	CPU Speed	Cores
MCEC	800 MHz	single
M1EC	1.2 GHz	single
M2EC	1.2 GHz	dual

1. Download the latest drive firmware and/or runtime firmware from Kollmorgen.com.
2. Open the controller's web server in your web browser by entering its IP address.
3. Select the **Settings** tabbed-page.
4. In the **Firmware** pane, click the **Choose File** button to select the new firmware image file for the KAS Runtime.

The recommended file is displayed in the **Current Information** section, as seen below.

Firmware Information

Firmware version _2.10.0.54368

Recommended File Name _KAS-PDMM-M-MCEC-{version}.img

5. Click **Upgrade** to start the update procedure.

TIP

If the Upgrade button is disabled, log into the webserver. Click on **Login** at the top of the web page and enter the password.

A message and a throbber are shown across the web page, indicating that maintenance is in progress. The device's 7-segment display will animate chasing lights.

Successful upgrade	<p>A message similar to the following is shown upon a successful firmware upgrade:</p> <p>Upload of firmware KAS-PDMM-M-MCEC-2.10.0.54368.img successful.</p> <p>Please reboot the unit in order to boot on the new firmware, and once reboot is performed, press CTRL+F5 in your web browser to force a page refresh.</p>
Incompatible firmware	<p>An error message similar to the following will be displayed if the wrong firmware file was downloaded:</p> <p>The file provided is not compatible with this device.</p> <p>The file name should be...</p> <p>"KAS-PDMM-M-MCEC-{version}.img"</p>

6. After the download is complete, click **Reboot**.

A message and a throbber are shown over the web server while the reboot is in progress. The login session will no longer be valid when the reboot is complete. The web server will display a message to indicate the user has been logged out.

NOTE

This step is not necessary if the controller automatically reboots during the upgrade (previous step).

7. Press **CTRL+F5** to force the web browser to refresh the page.

⚠ IMPORTANT

Do not try to refresh the web page until firmware upgrade is done.

6 Installing Hardware

Prior to have your motion application up and running, you first need to connect, wire and configure all your hardware components.

The [Getting Started](#) guide contains procedures for installing and configuring hardware components (HMI, PAC controllers, I/O Terminals, EtherCAT Motion Bus, AKD Drive, and AKM Motor).

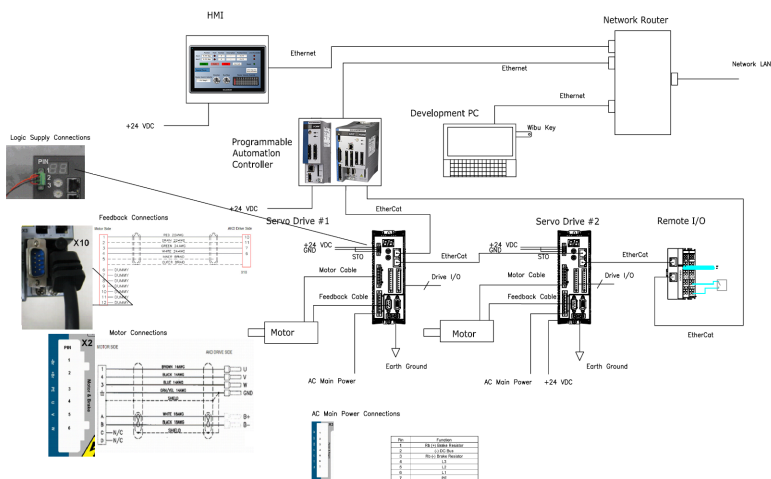

Figure 4-1: Connecting all the Hardware components

NOTE

For extensive information about installing the different hardware components, see the relevant documentation available on:

- Kollmorgen [Website](#)
- KAS IDE online help (after it has been installed)

Links to installation instructions for hardware components can be found in the following table.

Component	Installation
HMI (Human-Machine Interface)	Install the graphic operator interface Install HMI
Controller	Install the PCMM or PDMM controller "Install Controller - PDMM & PCMM" (p. 16)

Component	Installation
Controller	Install the Panel or Box Programmable Automation Control (PAC) Install Industrial PC
EtherCAT Motion Bus	Set up EtherCAT Motion Bus Communication See AKD™ EtherCAT Communication
I/O Terminal	Install the remote Input/Output Terminal Install I/O Terminals
AKD Drive	Install the AKD Drive See AKD Installation Manual (and also AKD Quick Start)
AKM Motor	Install the AKM Motor Mechanical and Electrical installation Available from http://www.kollmorgen.com/

Table 4-1: Kollmorgen Automation Suite Installation and Configuration

6.1 HMI - Graphic Operator Interface

Please find in the table below the list of each HMI component available:









HMI part number	Description	KVB	Tech. Manual
AKI2G-CDA-MOD-05T-000	Graphical Display 7" TFT LCD, Touchscreen	v2.20	
AKI2G-CDA-MOD-07T-000	Graphical Display 5" TFT LCD, Touchscreen	v2.20	
AKI2G-CDB-MOD-07T-000	Graphical Display 7" TFT LCD, Touchscreen	v2.20	
AKI2G-CDB-MOD-12T-000	Graphical Display 12" TFT LCD, Touchscreen	v2.20	
AKI-CDC-MOD-12T-000	Graphical Display 12.1" TFT LCD, Touchscreen	v2.0	
AKI-CDC-MOD-15T-000	Graphical Display 15.4" TFT LCD, Touchscreen	v2.0	
AKI-CDC-MOD-21T-000	Graphical Display 21.5" TFT LCD, Touchscreen	v2.0	

Table 4-2: List of KAS HMI

Please see the Kollmorgen website for specifications and Technical Manuals for more information.

6.2 Install Controller - PDMM & PCMM

The AKD PDMM and PCMM installation information may be found in the following locations.

Manual	Description
AKD PDMM Install Guide 	Covers the most important points to install the drive hardware and software. Provides instructions for basic drive setup and connection to a network
PCMM Install Guide 	Covers the most important points of the installation and setup of the controller.

6.3 Controller - AKC (PAC)

First connect the keyboard and the mouse to the AKC (PAC) (as well as the monitor if it is not built into the AKC) to be sure that the AKC correctly starts when it is powered by a supply voltage of 24v (not necessarily provided).

The box PAC is equipped with a DVI port, as seen to the right. DVI ports are backwards compatible for use with VGA monitors when using a DVI-to-VGA adapter. The first time the PAC is booted, an external monitor will only stay on for a brief time. The system needs to be configured from the keyboard, depending on what is connected to the DVI port. Press the keyboard combination shown below that matches your set-up. This configuration is automatically saved.



DVI cable	DVI-VGA adapter
CTRL-ALT-F4	CTRL-ALT-F1

How to recover when the monitor seems to be unplugged or switched off

The problem is probably due to the internal graphical card configuration and the currently known solution is the following:

- Restart the AKC (PAC) and press the **F8** key to enter the advanced XP start-up mode
- Select the **VGA mode enable start-up** option

- Reboot the AKC (PAC) and XP starts normally
- Ignore Windows comments on the screen
- Click the **Start** menu and select **Settings** then **Control Panel**
- Click the **System** command to explore the hardware configuration of the computer
- In the System Properties windows, select the **Device Manager** command in the **Hardware** tab
- In the Device Manager windows, expand the **Display Adapters** node
- Check that two Graphic Controllers are displayed
- Right-click on the first item and select the **Uninstall** command in the contextual menu
- Reboot your AKC (PAC) as requested to validate the modification

After the reboot operation, your AKC (PAC) should now work normally.

To be sure that the modification has been done properly, explore again the hardware configuration and compare it with the figure below.

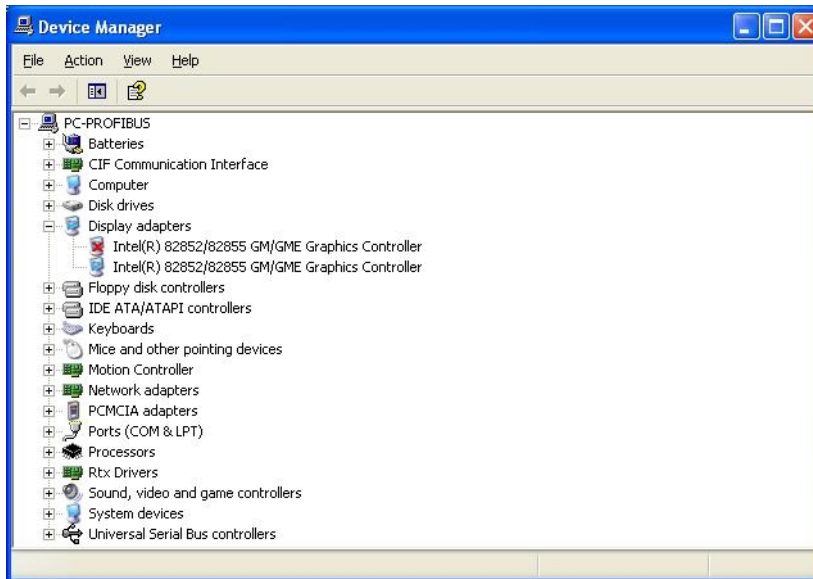

One of the controllers must be deactivated (see **red cross** on its icon).

Please find in the table below the list of each AKC (PAC) component available:

PAC part number	Description	Tech. Manual
AKC-PLC-C1-224-00N-00-000	Box Controller, Celeron 1.2GHz CPU, 2G RAM, 4G CF, 128KB NVRAM	
AKC-PLC-D2-224-00N-00-000	Box Controller, Dual Core 2.26GHz CPU, 2G RAM, 4G CF, 128KB NVRAM	
AKC-PNC-C1-224-10N-00-000	10" Panel Controller, Celeron 1.2GHz CPU, 2G RAM, 4G CF, 128KB NVRAM	
AKC-PNC-C1-224-15N-00-000	15" Panel Controller, Celeron 1.2GHz CPU, 2G RAM, 4G CF, 128KB NVRAM	
AKC-PNC-D1-224-15N-00-000	15" Panel Controller, C2D 1.86GHz CPU, 2G RAM, 4G CF, 128KB NVRAM	
AKC-PNC-D1-224-17N-00-000	17" Panel Controller, C2D 1.86GHz CPU, 2G RAM, 4G CF, 128KB NVRAM	
AKC-RMC-D2-224-00N-00-000	Rackmount Controller, Dual Core 2.26GHz CPU, 2G RAM, 4G CF, 128KB NVRAM	

Table 4-3: List of KAS PAC

6.3.1 Deploying AKC (PAC) standard image

The next step is to deploy the standard image that contains INtime Software with the correct settings for all the real-time part, as well as the EtherCAT option card settings. This step is done by Kollmorgen.

6.3.2 Configuring INtime

To finalize the INtime software installation, some fine tuning still has to be performed as follows:

1. Right-click on the INtime icon and select the **INtime Configuration** command in the contextual menu

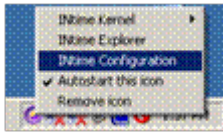

2. Double-click the **Miscellaneous** icon

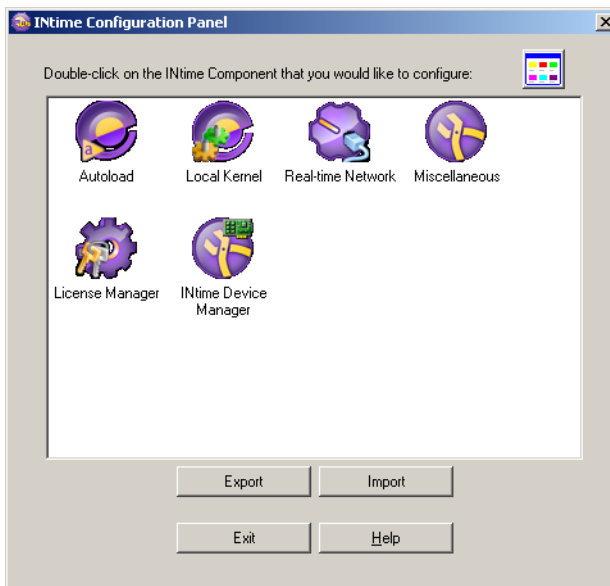

3. Select the **Display Fault Management Dialog** option

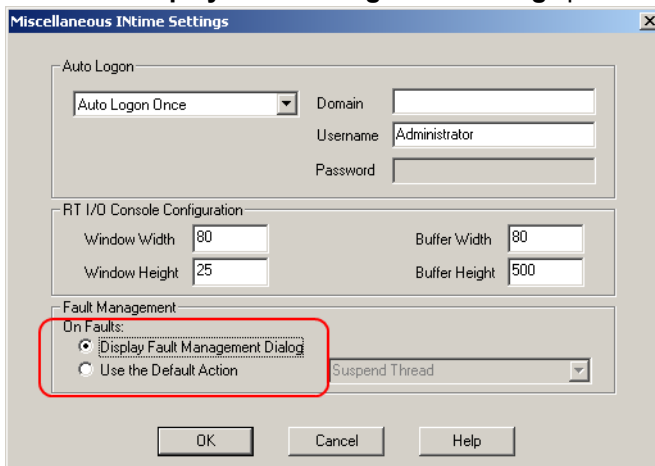

4. Click **OK**
5. Restart your AKC (PAC) for the changes to become effective

After these changes, INtime is now successfully configured to run on your AKC (PAC) .





6.4 EtherCAT Motion Bus

One EtherCAT master (e.g. PAC) has to be connected with all the slaves (drives and I/O terminals) of your system. Please find all the details about the installation procedure for the EtherCAT Motion Bus in the following deliverable **AKD™ EtherCAT Communication** listed in the list of [References](#).

6.5 Remote Input/Output - I/O Terminal

Please find in the table below the list of each I/O component available.

I/O terminal part number	Description	Tech. Manual
AKT-AN-200-000	2 Channel Thermocouple Input Module	
AKT-AN-400-000	4 Channel Thermocouple Input Module	
AKT-AN-410-000	4 Channel Analog Input Module, 0-10 VDC	
AKT-AN-420-000	4 Channel Analog Input Module, 0-20 mA	
AKT-AN-810-000	8 Channel Analog Input Module, 0-10 VDC	
AKT-AN-820-000	8 Channel Analog Input Module, 0-20 mA	
AKT-AT-220-000	2 Channel Analog Output Module, 0-20 mA	
AKT-AT-410-000	4 Channel Analog Output Module, 0-10 VDC	
AKT-AT-420-000	4 Channel Analog Output Module, 0-20 mA	
AKT-AT-810-000	8 Channel Analog Output Module, 0-10 VDC	
AKT-AT-820-000	8 Channel Analog Output Module, 0-20 mA	
AKT-DN-004-000	4 Channel Digital Input Module, 24 VDC 3ms	
AKT-DN-008-000	8 Channel Digital Input Module, 24 VDC 3ms	
AKT-DNH-004-000	4 Channel Digital Input Module, 24 VDC 0.2ms	
AKT-DNH-008-000	8 Channel Digital Input Module, 24 VDC 0.2ms	
AKT-DT-004-000	4 Channel Digital Output Module, 24 VDC 0.5A	
AKT-DT-008-000	8 Channel Digital Output Module, 24 VDC 0.5A	
AKT-DT-2RT-000	2 Channel Relay Output Module, 230 V AC 2.0A Rel.2NO Pot.-Free	
AKT-ECT-000-000	EtherCAT Bus Coupler	
AKT-EM-000-000	Standard-Bus End Terminal	
AKT-IM-000-000	Isolation / Separation Terminal	

I/O terminal part number	Description	Tech. Manual
AKT-PRB-000-000	PROFIBUS Coupler	
AKT-PS-024-000	Power Supply, 24 VDC	
AKT-PSF-024-000	Fused Power Supply with diagnostics, 24 VDC	
AKT-SM-L15-000	Stepper Motor Terminal, 24 VDC, 1.5 A	
AKT-SM-L50-000	Stepper Motor Terminal, 50 VDC, 5 A	

⚠ IMPORTANT

24-volt power is not passed through [AKT-AN-200-000](#) and [AKT-AN-400-000](#) thermocouple modules. To get 24VDC power to devices that need it (such as an [AKT_AT-410-000](#) Output module) there are two possible solutions. :

- Place the module requiring 24VDC before the thermocouple module.
- Add a power feed module ([AKT-PS-024-000](#) or [AKT-PSF-024-000](#)) after the thermocouple module.

Table 4-4: List of KAS I/O Terminals

6.5.1 Installing Bus Terminals on mounting rails**⚠ CAUTION**

Bring the bus terminal system into a safe, powered down state before starting installation, disassembly or wiring of the Bus Terminals!

6.5.1.1 Assembly

The Bus Coupler and Bus Terminals are attached to commercially available 35 mm mounting rails (DIN rails according to EN 50022) by applying slight pressure:

1. First attach the Fieldbus Coupler to the mounting rail.
2. The Bus Terminals are now attached on the right-hand side of the Fieldbus Coupler. Join the components with tongue and groove and push the terminals against the mounting rail, until the lock clicks onto the mounting rail.
If the Terminals are clipped onto the mounting rail first and then pushed together without tongue and groove, the connection is not operational! When correctly assembled, no significant gap is visible between the housings.

During the installation of the Bus Terminals, the locking mechanism of the terminals must not come into conflict with the fixing bolts of the mounting rail.

6.5.1.2 Disassembly

Each terminal is secured by a lock on the mounting rail, which must be released for disassembly:

1. Carefully pull the orange-colored lug approximately 1 cm out of the disassembled terminal, until it protrudes loosely. The lock with the mounting rail is now released for this terminal, and the terminal can be pulled from the mounting rail without excessive force.
2. Grasp the released terminal with thumb and index finger simultaneously at the upper and lower grooved housing surfaces and pull the terminal away from the mounting rail.

6.5.1.3 Connections within a bus terminal block

The electric connections between the Bus Coupler and the Bus Terminals are automatically realized by joining the components:

- The six spring contacts of the Standard/Performance Coupler deal with the transfer of the data and the supply of the Bus Terminal electronics.
- The power contacts deal with the supply for the field electronics and thus represent a supply rail within the bus terminal block. The power contacts are supplied via terminals on the Bus Coupler.

NOTE

During the design of a bus terminal block, the pin assignment of the individual Bus Terminals must be taken account of, since some types (e.g. analog Bus Terminals or digital 4-channel Bus Terminals) do not or not fully loop through the power contacts. Power Feed Terminals (AKT-PS-024-000 or AKT-PSF-024-000) interrupt the power contacts and thus represent the start of a new supply rail.

6.5.1.4 PE power contact

The power contact labeled PE can be used as a protective earth. For safety reasons this contact mates first when plugging together, and can ground short-circuit currents of up to 125 A.

⚠ WARNING

Note that, for reasons of electromagnetic compatibility, the PE contacts are capacitatively coupled to the mounting rail. It can lead to incorrect results during insulation testing or to damage on the terminal (e.g. disruptive discharge to the PE line during insulation testing of a consumer with a nominal voltage of 230 V).

For insulation testing, disconnect the PE supply line at the Bus Coupler or the Power Feed Terminal! In order to decouple further feed points for testing, these Power Feed Terminals can be released and pulled at least 10 mm from the group of terminals.

The PE power contact must not be used for other potentials!

6.5.1.5 Wiring

Up to eight connections enable the connection of solid or finely stranded cables to the Bus Terminals. The terminals are implemented in spring force technology. Connect the cables as follows:

1. Open a spring-loaded terminal by slightly pushing with a screwdriver or a rod into the square opening above the terminal.
2. The wire can now be inserted into the round terminal opening without any force.
3. The terminal closes automatically when the pressure is released, holding the wire securely and permanently.

NOTE

Analog sensors and actors must always be connected with shielded, twisted paired wires.

6.5.2 Connection Details

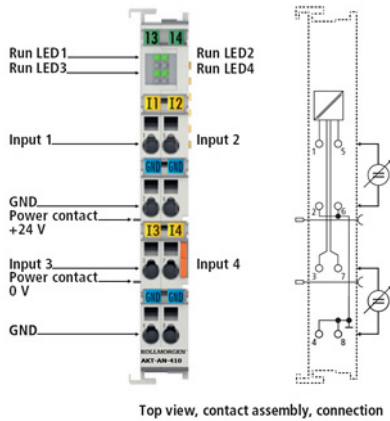

6.6 Installing AKD Drive

To install the AKD drive as well as the AKD GUI Views, refer to chapters 7 to 9 in the **AKD™ - Installation Manual**

Drives Guide	Description
AKD Quick Start	Contains all information needed to safely install and setup an AKD drive
AKD PDMM Installation Manual	Covers the most important points to install the drive hardware and software Provides instructions for basic drive setup and connection to a network
AKD User Manual	Describes how to use your drive in common applications. It also provides tips for maximizing your system performance with the AKD
AKD Accessories Manual	Includes technical data and dimensional drawings of accessories such as cables, brake resistors, and mains supplies
AKD EtherCAT Manual	Describes the installation, setup, range of functions, and software protocol for the EtherCAT AKD product series
S300 Reference Documentation	Kollmorgen website that gives access to all S300 manuals
S700 Reference Documentation	Kollmorgen website that gives access to all S700 manuals

Table 4-5: List of AKD Guides

6.7 Installing AKM Motor

To install rotary AKM Servomotors, refer to the following AKM deliverable:

- Chapters 17 to 19 in: **AKM™ Synchronous Servomotors - Product Manual**

NOTE

This manual can be downloaded at http://www.kollmorgen.com/uploadedfiles/Files/Document/Motors_and_Drives_Overview_Brochure.pdf

7 Updating Firmware

Check the KAS software release notes to find the PDMM firmware version that matches with your KAS software version. The latest version of the firmware can be downloaded from the [Kollmorgen web site](#).

To ensure your installation is correct, you have to:

- Check the current AKD drive firmware
- Download the official version, if necessary
- Update the firmware

Check AKD Drive Firmware

To check PDMM Firmware with KAS IDE:

1. Create a new project
2. Set the controller type and IP address
3. In the Project Explorer, double-click the **EtherCAT** node to open the EtherCAT Devices summary window
4. In the Devices tab, click the **Scan Devices** button
5. Choose the **Create...** option to map the physical device to a new device

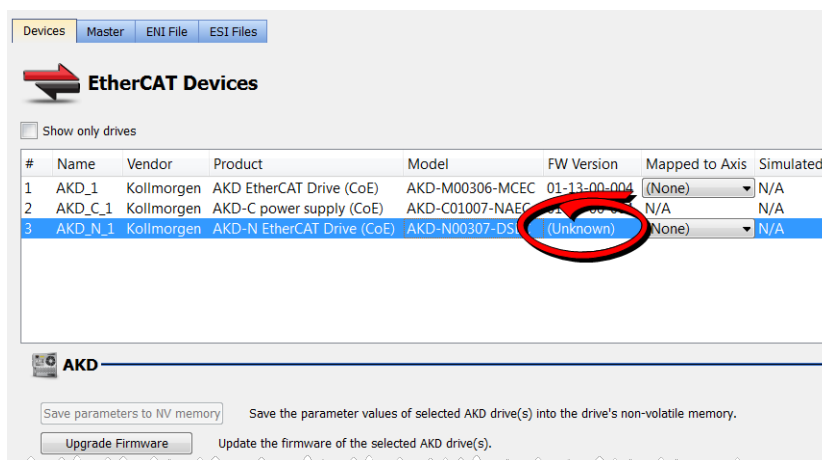

NOTE

If the firmware version is shown as "Unknown", the drive has valid resident firmware (from which to boot), but does not have valid operational firmware. Please download and install the latest operational firmware and reboot the AKD.



6. If the version is not correct, continue following with the procedure below
7. Compile the project
8. Connect to the controller
9. Download the project to the controller
10. If the version is not correct, download the new firmware ([click here](#)) and follow with the next procedure.

Download PDMM Drive Firmware

Component	Firmware Version	Download
800MHz PDMM Drive FW	AKD-M-MCEC-V1.16-00-003.i00	
1.2GHz PDMM Drive FW	AKD-M-M1EC-V1.16-00-003.i00	

To upgrade PDMM drive Firmware with KAS IDE, continue from the previous procedure as follows:

1. In the toolbar, deactivate the [Online Configuration Mode](#)
2. Select the drives requiring the same firmware version to be updated
(Note that the FW download is limited to 16 drives at a time)

TIP

Please note that the firmware download is limited to 16 drives at a time.

3. Click **Upgrade Firmware** button

IMPORTANT

Give careful attention to any warning dialog that appears at this point. These warnings usually include important information about preventing damage to the drives.

4. Browse to select the new AKD firmware file
5. Click **Open** to start the updating procedure

7.1 AKD Firmware Update

Based on the [File Access over EtherCAT \(FoE\)](#) protocol, the AKD drive Firmware can be downloaded as follows:

1. Scan the devices and make sure all devices are created
2. Compile the project
3. Connect to the controller
4. Download the project to the controller
5. Open the **EtherCAT Devices** summary form
6. Select the drives requiring the same firmware version to be updated
 - Multiple drives of the same type can be selected allowing the same firmware file to be downloaded to the selected drives simultaneously.
 - **AKD-P**: The last four letters of the model number must be the same for simultaneous firmware download.
 - **AKD-N**: The last four characters can be different. However, the firmware file selected to download must support all the selected models. The file `AKD-N-xxEC-*****.i00` supports multiple AKD-N models.
 - **AKD-C**: Devices with the product description "AKD-C String 2" do not support firmware download.

#	Name	Vendor	Product	Model	FW Version	Mapped to Axis	Simulated
1	AKD_1	Kollmorgen	AKD EtherCAT Drive (CoE)	AKD-M00306-MCEC-0000	01-14-00-002	(None)	N/A
2	AKD_C_1	Kollmorgen	AKD-C String 1 / Power supply/IO (CoE)	AKD-C00000-CBEC-E000	(Unknown)	N/A	N/A
3	AKD_N_1	Kollmorgen	AKD-N EtherCAT Drive (CoE)	AKD-N00307-DFEC-E000	01-14-00-002	(None)	N/A
4	AKD_C_2	Kollmorgen	AKD-C String 2	AKD-C00000-CBEC-0000	(Unknown)	N/A	N/A
5	AKD_N_2	Kollmorgen	AKD-N EtherCAT Drive (CoE)	AKD-N00307-DFEC-0000	01-14-00-002	(None)	N/A
6	AKD_N_3	Kollmorgen	AKD-N EtherCAT Drive (CoE)	AKD-N00307-DSEC-0000	01-14-00-002	(None)	N/A

7. Click the **Upgrade Firmware** button

IMPORTANT

Give careful attention to any warning dialog that appears at this point. These warnings usually include important information about preventing damage to the drives.

8. Browse to select the new AKD firmware file matching the AKD revision. Refer to the Release Notes for the latest supported firmware.
9. Click **Open** to start the updating procedure

NOTE

This procedure is not possible when applications are running and when the drive is in [Online Configuration Mode](#).

During the firmware download, the AKD Firmware Update window displays a progress bar and the following messages are displayed:

- Uploading firmware to the drive
During the download process, the drive LED displays [dL]. Additional codes may appear during the download; see 3.2 Display Codes for a description of codes related to the firmware download.
- Resetting the drive
- Firmware update is complete

⚠ CAUTION

While the firmware is downloading to your drive, do not remove the 24V logic power. If you remove the 24V logic power during a firmware download, a severe drive crash can occur. If a crash occurs, the drive will restart in a special mode and prompt you to reload the firmware.

⚠ IMPORTANT

An AKD drive executing the resident firmware is detected as a different device than an AKD drive executing the operational firmware. Be sure to re-scan the network and compile it if a drive's executed firmware has changed since the last scan.

👉 TIP

Power cycling is recommended after completing the update for all drives.

8 Installing Kollmorgen Visualization Builder

Kollmorgen Visualization Builder (or KVB) allows you to design HMI panels running either on AKI or panel PAC. KVB is an optional feature that is only included in some licenses.

NOTE

Kollmorgen Visualization Builder contains the two following installation packages:

- Kollmorgen Visualization Builder(KVB IDE) for development PC
- Visualizer RT(KVB RT) for AKI panel runtime

8.1 Download

Component	Version	Download
Latest Version of Kollmorgen Visual Builder	v.2.20	302.9 MB
Visualizer RT (KVB RT)	v.1.20	78 MB

8.2 Installation Procedure

The following programs will automatically be installed during the KVB can be installed:

- Microsoft .NET Compact Framework 3.5
- Microsoft SQL Server Compact 3.5
- Microsoft Visual C++ 2013 - Redistributable Setup

Once Kollmorgen Visualization Builder has finished downloading, complete the following installation steps:

1. Double-click the **Setup.exe** file to run the installation Wizard

NOTE

If KVB was already installed and you want to update to a new version, then running **NeoSetup.msi** is enough.

2. Select the check box to accept the License agreement and click **Next** to start installing **Kollmorgen Visualization Builder**.

NOTE

The Runtime (also named Visualizer RT) is dedicated to the PAC only

3. Select where you want to install **Kollmorgen Visualization Builder** and the application language, then click **Next**

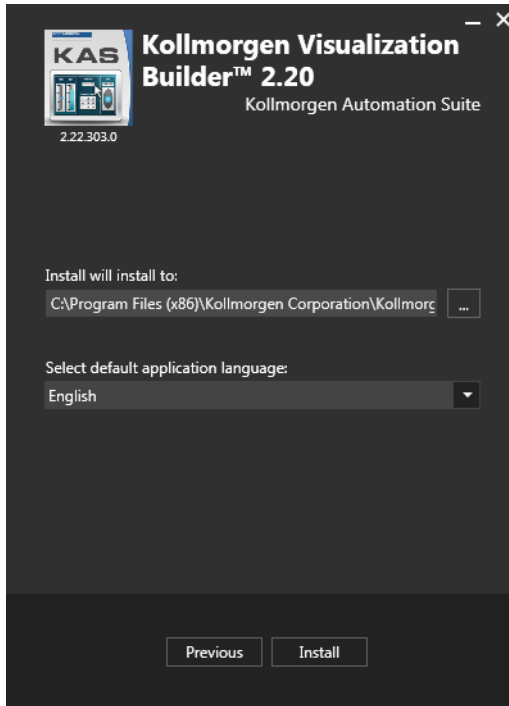

Kollmorgen strongly recommends accepting the default destination folder under C:\Program Files (x86)\Kollmorgen\Kollmorgen Visualization Builder\

4. Click **Install** to start **Kollmorgen Visualization Builder** installation
5. Click **Close** or to start using KVB right away, click **Launch**.

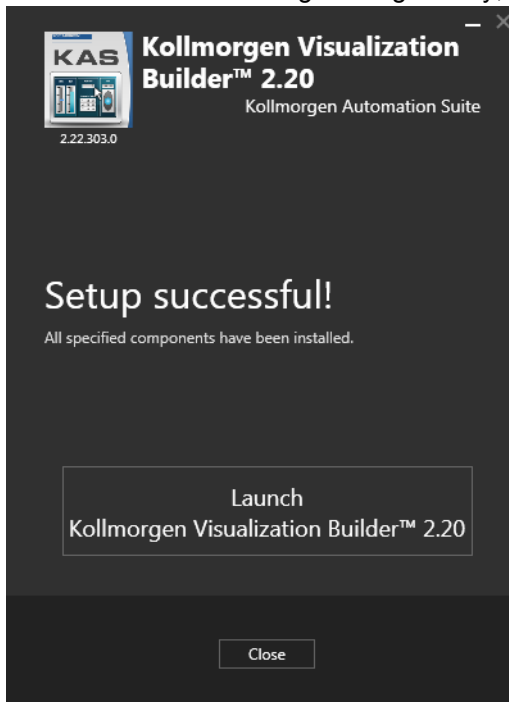

9 Finalizing Installation

To complete the KAS installation, you can optionally:

- Test the system
- Create a backup image

9.1 Testing Installation

To conclude your installation, the whole system has to be tested.

A test could be done with the standard Two-Axis Template that corresponds to a simple application (refer to **KAS 30 Minutes to Motion**).

9.2 Saving Installation

This chapter defines how to:

- Save the AKC (PAC) image on a CompactFlash card (aka USB memory stick)
- Prevents from files corruptions in the PC's CompactFlash memory

To prevent corruption and be able to quickly restore your AKC (PAC) image, Acronis SW and Microsoft Enhanced Write Filter (EWF) can be used. The procedure described below explains how to use these proposed tools.

NOTE

Acronis True Image software is **not** part of Kollmorgen Automation Suite. For more details, refer to: www.acronis.com.

EWF software is included in Windows® XP Embedded. For more details, refer to: msdn.microsoft.com/en-us/library/ms912915.aspx

9.2.1 Backup AKC Image

As soon as all the hardware has been tested and validated, you can proceed to a complete backup on a CompactFlash card (aka USB memory stick) with the **Acronis True Image** software.

9.2.1.1 Prepare the bootable USB Stick

You first need a USB Stick (with a minimum of 2GB capacity) to be prepared as follows:

- Install HP USB Disk Format Storage Tool (HP_USB Boot_Utility.exe)
- Create a folder for the system files
C:\Documents and Settings\Myname\My Documents\AKC Backup Files\HP_USB\DOS
- Copy the following system files in this folder

Name	Size	Type	Date Modified
COMMAND.COM	91 KB	MS-DOS Application	6/8/2000 5:00 PM
CONFIG.SYS	1 KB	System file	1/18/2008 9:30 AM
DISPLAY.SYS	17 KB	System file	6/8/2000 5:00 PM
EGA2.CPI	58 KB	CPI File	6/8/2000 5:00 PM
EGA3.CPI	58 KB	CPI File	6/8/2000 5:00 PM
EGA.CPI	58 KB	CPI File	6/8/2000 5:00 PM
KEYB.COM	22 KB	MS-DOS Application	6/8/2000 5:00 PM
KEYBOARD.SYS	34 KB	System file	6/8/2000 5:00 PM
KEYBRD2.SYS	32 KB	System file	6/8/2000 5:00 PM
KEYBRD3.SYS	31 KB	System file	6/8/2000 5:00 PM
KEYBRD4.SYS	13 KB	System file	6/8/2000 5:00 PM
MODE.COM	29 KB	MS-DOS Application	6/8/2000 5:00 PM

- Insert the USB stick into the USB port of your computer
- Launch the HP format tool program (HPUSBFW.EXE) from the installed directory

- Under the **device** drop-down list, make sure that your USB stick is selected

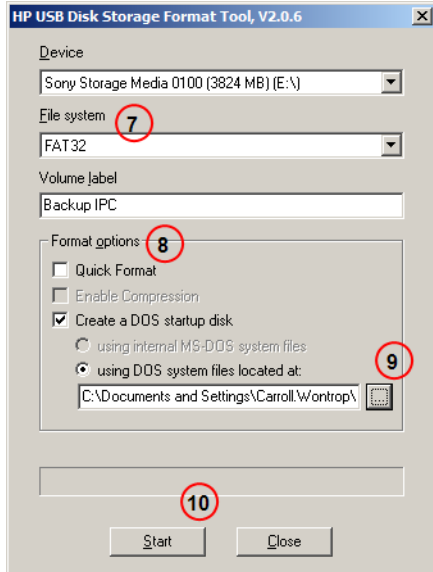

- Under the **File system** drop down list, select **FAT32**
- In the **Format options**, choose to **Create a DOS startup disk** and select **using DOS system files located at:**
- Specify the folder location created in step 2

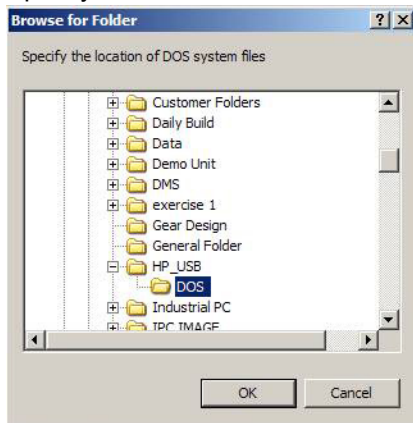

- Click the **Start** button to format as a Bootable device using DOS directory

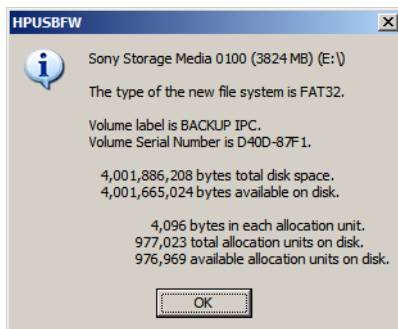

- Click the **Close** button once the operation is completed
- Install **Acronis True Image 11** on your AKC (PAC)

- Start **Acronis True Image** application

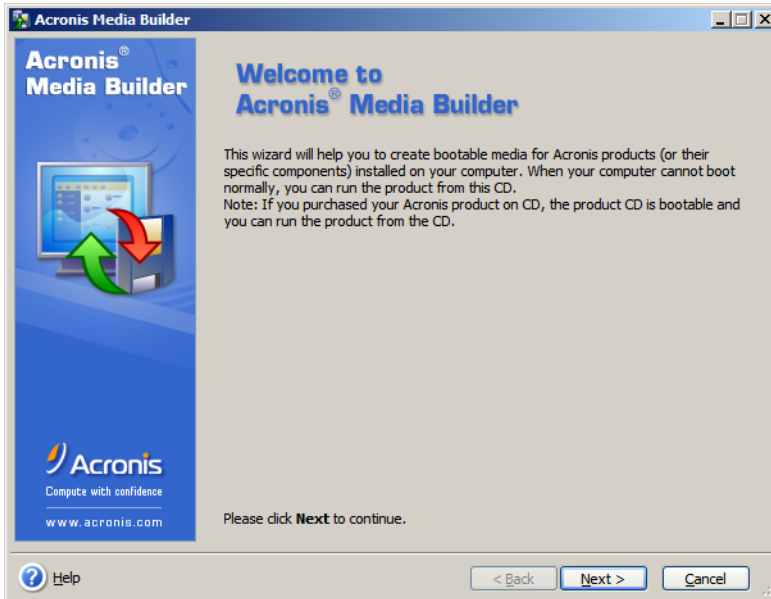

- Go to **Management tool**

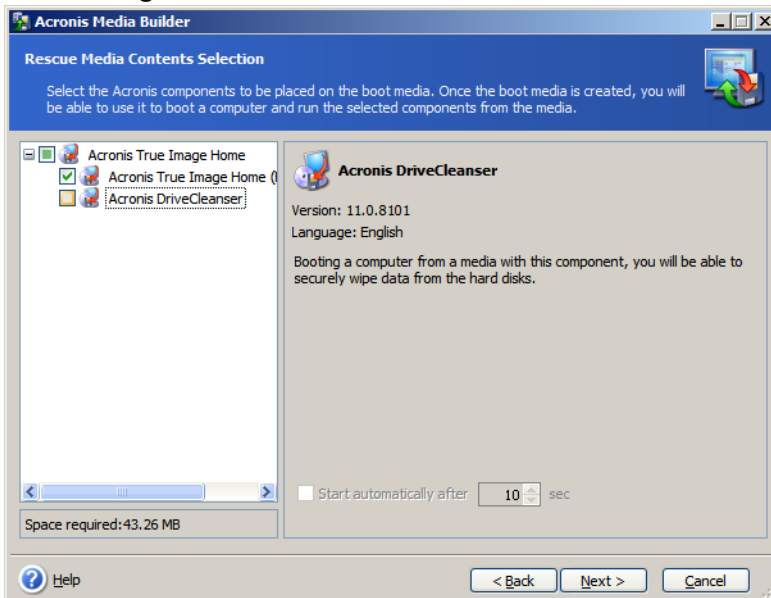

- Create Bootable Rescue Media

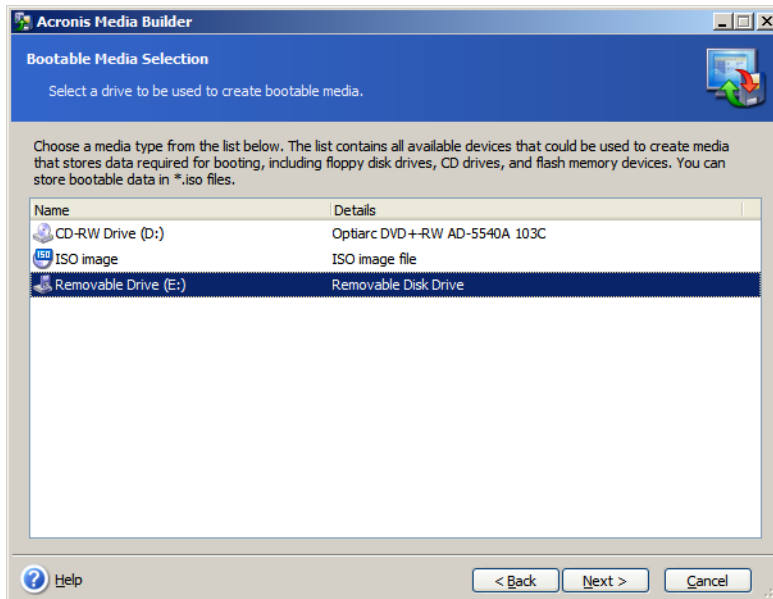

9.2.1.2 Create the Backup

To the complete backup, proceed as follows:

- Connect the keyboard and the mouse to the AKC (PAC) (as well as the monitor if it is not built into the AKC (PAC))
For more details, refer to "[Controller - AKC \(PAC\)](#)" (p. 16)
- Start your AKC (PAC)
- During startup press the **F2** key to enter the setup
- Set the priority by selecting the first boot device to look for the USB stick (you only need to do it once)
- Insert the USB stick into a free USB port
- Reboot your AKC (PAC)
- Start **Acronis True Image** application
- Select True Image Home
- Select **Backup**
- Select **My Computer**
- Select what is to be backed up (i.e. **Disk1: Volume C**)
- Exclude nothing (do not select any exclusions)
- Select the store location: A: Removable drive/Image/**FILENAME** (modify with a meaningful FILENAME)
- Select **Create a new full backup archive**
- Choose **Compression level** and set to the maximum
- Add notes if desired
- Store in file name xxxxx_Original (create a full backup)
- Do not have to enter password
- Compression level: Max
- Finally click **Proceed**

9.2.2 Enhanced Write Filter

The Enhanced Write Filter (EWF) is a Microsoft® Windows® XP embedded operating system feature which provides write-protection to a partition on the compact flash (CF) card. All write requests to the partition are redirected to RAM when EWF is enabled. The EWF feature protects the CF image from changes due to sudden power loss, improper shutdown, or other user configurations. When the EWF is active its icon is shown in the system tray, as seen to the right. When the EWF is disabled its system tray icon is a red slashed-circle .



The EWF should be activated on the PAC after the system is running and the PAC configuration is complete. If you want to change the CF image (such as a new KAS version or downloading a new application), then turn off the EWF filter, make the change, and then reactivate EWF.

There are two ways to manage the EWF:

- With the **EwfWinDllcaller.exe** application, located in `C:\WINDOWS\system32`. This is the preferred method. See "[Enhanced Write Filter Operational Procedures Using the Application](#)" (p. 32) for more information.
- From the command line interface. The command line offers more functions than the application *but is recommended only for advanced users*. See "[Enhanced Write Filter Operational Procedures using the command line](#)" (p. 33) for more information.

9.2.2.1 Practical Applications

- For the **KAS Runtime installation**, using the "commitanddisable" method (via either command line or the application) is strongly recommended. If some operations have been performed previously, the remaining memory will not be sufficient using another method.
- For a **New PLC application download**, the "[Perform Small Changes on a Protected Volume](#)" (p. 34)" method is convenient because the usual PLC application does not exceed 10 MB.

9.2.3 Enhanced Write Filter Operational Procedures Using the Application

9.2.3.1 Protect the PAC Image with EWF

The EWF must be activated to protect a stable version of the PAC image from data corruption.

1. Close all applications
2. Launch EwfWinDLLcaller.exe by pressing Start > Run and typing: EwfWinDLLcaller

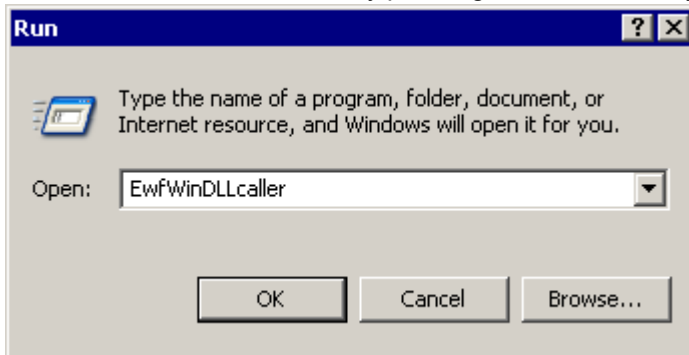

3. Click the Enable button

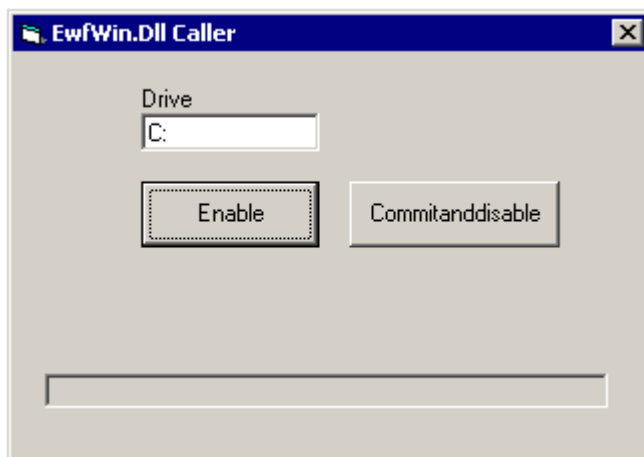

You will receive a message about the Enable being successful.

- Restart the computer
If the icon in the system tray is green  then EWF is active.

9.2.3.2 Perform Changes on a Protected Volume

The EWF has to be disabled to perform changes on a PAC.

- Close all applications.
- Launch EwfWinDLLcaller.exe
- Click on the **Commitanddisable** button
Any configuration change written to RAM will be committed to the CF and then EWF will be disabled. You will receive a message about the Disable being successful.
- Restart the computer.
If the icon in the system tray is a red slashed-circle  then EWF is disabled.

ⓘ IMPORTANT

After pressing the **Commitanddisable** button you *must restart the computer*. The EWF is not fully disabled until the computer is restarted and making any changes to the system in this state can be troublesome.

After changes are made to the system, the EWF should be re-enabled to protect the PAC image. See "[Protect the PAC Image with EWF](#)" (p. 32).

9.2.4 Enhanced Write Filter Operational Procedures using the command line

ⓘ IMPORTANT

Using the EWF from the command line should only be performed by advanced users. Using the [application](#) is easier and more reliable.

9.2.4.1 Protect the PAC Image with EWF

The EWF should be activated on the PAC after the system is running and the PAC configuration is complete. If you want to change the CF image (such as a new KAS version or downloading a new application), then turn off the EWF filter, make the change, and then reactivate EWF.

- Open a command prompt by pressing Start > Run and type: **cmd**
- From the command prompt, type: **ewfmgr C: -enable**
- Reboot the PAC to activate the EWF

To ensure that the command has been entered correctly, execute the DOS command shell `ewfmgr c:` prior to rebooting the PAC. Check the field `Boot Command`, which should be set to "ENABLE", as seen in the image below.

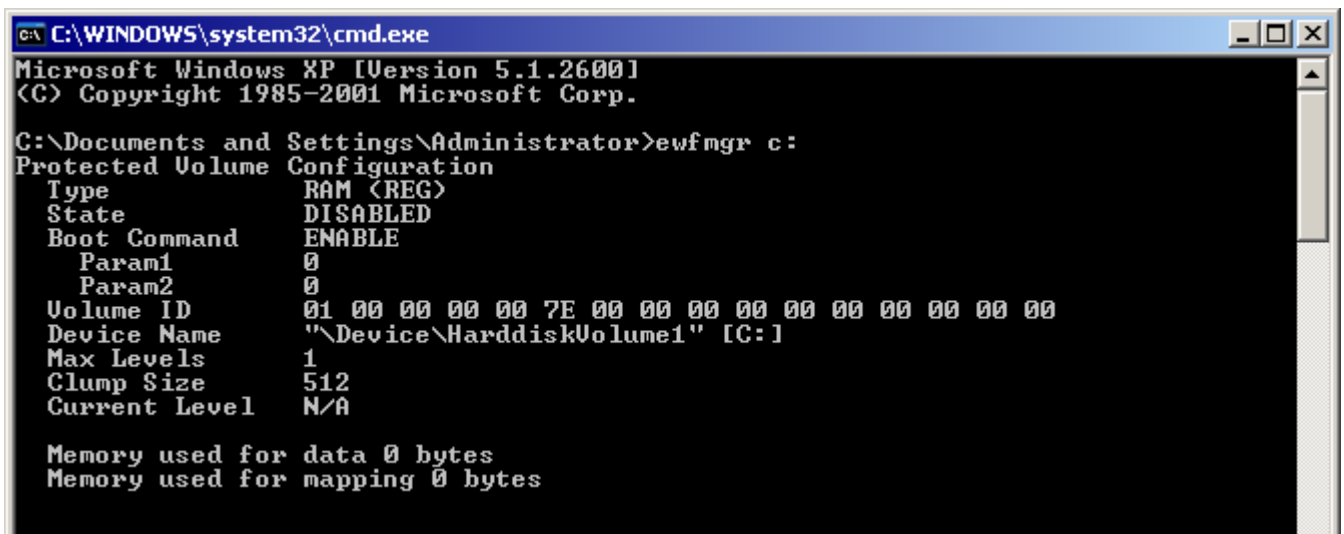

```

C:\WINDOWS\system32\cmd.exe
Microsoft Windows XP [Version 5.1.2600]
(C) Copyright 1985-2001 Microsoft Corp.

C:\Documents and Settings\Administrator>ewfmgr c:
Protected Volume Configuration
Type          RAM (REG)
State         DISABLED
Boot Command  ENABLE
  Param1      0
  Param2      0
Volume ID     01 00 00 00 00 7E 00 00 00 00 00 00 00 00 00
Device Name   "\Device\HarddiskVolume1" [C:]
Max Levels    1
Clump Size    512
Current Level N/A

Memory used for data 0 bytes
Memory used for mapping 0 bytes

```

ⓘ IMPORTANT

If several commands are executed, only the latest will take effect after the reboot. To be sure about the latest command, execute the process described above.

9.2.4.2 Perform Changes on a Protected Volume

The EWF has to be disabled to perform changes on a PAC. After the changes are made the EWF is re-enabled.

1. Open a command prompt by pressing Start > Run and type: **cmd**
2. From the command prompt, type: **ewfmgr C: -commitanddisable**
3. Reboot the PAC to commit the changes and disable EWF
4. Make the desired changes (program installation, files record, etc.)
5. From the command prompt, type: **ewfmgr C: -enable**
6. Reboot the PAC to activate the EWF

NOTE

It is important to note that the maximum overlay size is a little more than 300 MB. Windows runs out of memory and crashes if this available space is exceeded, resulting in the error "**Delayed Write Failed. Windows was unable to save all data for the file**". As a consequence, when making important changes or file copy actions, do not forget to disable EWF first, and re-enable it when the operations are complete.

9.2.4.3 Perform Small Changes on a Protected Volume

To commit changes without disabling and re-enabling EWF, a single commit can be commanded:

1. From the command prompt, type: **ewfmgr C: -commit**
2. Reboot the PAC to commit the changes (EWF remains active).

9.2.5 Restore AKC (PAC) Backup Image

To restore the complete backup, proceed as follows:

- Connect the keyboard and the mouse to the PAC (as well as the monitor if it is not built into the PAC)
For more details, refer to "[Controller - AKC \(PAC\)](#)" (p. 16)
- Insert the bootable USB stick into a free USB port
- Reboot your PAC
- Start **Acronis True Image** application
- Select **Restore**
- Select the restored backup file on the USB stick (.tib file)
- Choose Restoration Method
- Restore whole Disks and partitions
- Select both Volume C and Master Boot record (MBR)
- Select the Destination of Disk 1
- Select option **yes, I want to delete all the partitions on the destination hard drive before restoring**
- Then start the restore operation

10 Troubleshooting KAS

Faults occur for a variety of reasons, depending on the conditions in your installation. The causes of faults in multi-axis systems can be especially complex.

TIP

You can find more details in:

- the **Troubleshooting** chapter in the online help
- the Faults and Warnings section of the online help
- searching KDN (Kollmorgen Developer Network at KDN.Kollmorgen.com) for answers, or submit a question.

About KOLLMORGEN

Kollmorgen is a leading provider of motion systems and components for machine builders. Through world-class knowledge in motion, industry-leading quality and deep expertise in linking and integrating standard and custom products, Kollmorgen delivers breakthrough solutions that are unmatched in performance, reliability and ease-of-use, giving machine builders an irrefutable marketplace advantage.



Join the [Kollmorgen Developer Network](#) for product support. Ask the community questions, search the knowledge base for answers, get downloads, and suggest improvements.

North America

KOLLMORGEN

203A West Rock Road
Radford, VA 24141
USA

Web: www.kollmorgen.com
Mail: support@kollmorgen.com
Tel.: +1 - 540 - 633 - 3545
Fax: +1 - 540 - 639 - 4162

South America

KOLLMORGEN

Avenida Tamboré, 1077 Tamboré - Barueri - SP Brasil
CEP: 06460-000

Web: www.kollmorgen.com
Mail: support@kollmorgen.com
Tel.: +55 11 4191-4771

Europe

KOLLMORGEN Europe GmbH

Pempelfurtstraße 1
40880 Ratingen
Germany

Web: www.kollmorgen.com
Mail: technik@kollmorgen.com
Tel.: +49 - 2102 - 9394 - 0
Fax: +49 - 2102 - 9394 - 3155

China and SEA

KOLLMORGEN

Room 202, Building 3, Lane 168,
Lin Hong Road, Changning District
Shanghai

Web: www.kollmorgen.cn
Mail: sales.china@kollmorgen.com
Tel.: +86 - 400 661 2802