

# PiCPro<sup>TM</sup>

## Function/Function Block Reference Guide

Version 15.1

## NOTE

Progress is an on going commitment at G & L Motion Control Inc. We continually strive to offer the most advanced products in the industry; therefore, information in this document is subject to change without notice. The illustrations and specifications are not binding in detail. G & L Motion Control Inc. shall not be liable for any technical or editorial omissions occurring in this document, nor for any consequential or incidental damages resulting from the use of this document.

DO NOT ATTEMPT to use any G & L Motion Control Inc. product until the use of such product is completely understood. It is the responsibility of the user to make certain proper operation practices are understood. G & L Motion Control Inc. products should be used only by qualified personnel and for the express purpose for which said products were designed.

Should information not covered in this document be required, contact the Customer Service Department, G & L Motion Control Inc., 672 South Military Road, P.O. Box 1960, Fond du Lac, WI 54936-1960. G & L Motion Control Inc. can be reached by telephone at (920) 921-7100 or (800) 558-4808 in the United States or by e-mail at [glmotion.support@danahermotion.com](mailto:glmotion.support@danahermotion.com).

Release 1210

Catalog No. (Order No.) M.1300.7591

Version Part Number M.1302.8695

© 1995-2005 G & L Motion Control Inc.

IBM is a registered trademark of International Business Machines Corp.  
Microsoft® and MS-DOS® are registered trademarks of Microsoft Corporation.  
ARCNET® is a registered trademark of Datapoint  
PiC900, PiCPro, MMC, PiCServoPro, PiCTune, PiCProfile, LDOMerge, PiCMicroTerm, and PiC Programming Pendant are registered trademarks of G & L Motion Control Inc.

# Table of Contents: Function/Function Block Reference Guide

<b>CHAPTER 1-</b>	
<b>PiCPro Function/Blocks Overview.....</b>	<b>1-1</b>
<b>Introduction.....</b>	<b>1-1</b>
<b>Arithmetic Category .....</b>	<b>1-6</b>
ARITH group .....	1-6
DATETIME group .....	1-7
TRIG group .....	1-8
<b>Binary Category .....</b>	<b>1-9</b>
<b>Counters Category .....</b>	<b>1-10</b>
<b>Datatype Category .....</b>	<b>1-11</b>
BOOL2BYT group .....	1-11
DINTCONV group .....	1-12
DWORDCNV group .....	1-13
D_TCONV group .....	1-14
INTCONV group .....	1-15
LINTCONV group .....	1-16
LREALCNV group .....	1-17
LWORDCNV group .....	1-18
NUM2STR group .....	1-19
REALCONV group .....	1-20
SINTCONV group .....	1-21
SIZEOF group .....	1-22
STRCONV group .....	1-23
UDINTCNV group .....	1-24
UINTCONV group .....	1-25
ULINTCNV group .....	1-26
USINTCNV group.....	1-27
WORDCONV group .....	1-28
<b>Evaluate Category .....</b>	<b>1-28</b>
<b>Fbinter Category.....</b>	<b>1-30</b>
<b>Filter Category .....</b>	<b>1-30</b>
<b>I/O Category .....</b>	<b>1-31</b>
ANLGIN group .....	1-32
ANLGOUT group.....	1-33
BAT_OK? group.....	1-34
BIO_PERF group.....	1-35

COMM group .....	1-36
JKTHERM group.....	1-37
NETWORK group .....	1-38
PID group .....	1-39
READFDBK group .....	1-40
RTDTEMP group .....	1-41
SOCKETS group .....	1-42
STEPPER group .....	1-43
<b>Motion Category .....</b>	<b>1-43</b>
DATA group .....	1-44
ERRORS group .....	1-46
INIT group .....	1-48
MOVE group .....	1-49
MOVE_SUP group .....	1-50
QUE group .....	1-51
RATIOMOV group.....	1-52
REF group .....	1-53
SERC_SLV group .....	1-54
SERC_SYS group .....	1-55
<b>String Category .....</b>	<b>1-55</b>
<b>PID Category .....</b>	<b>1-56</b>
<b>Timers Category .....</b>	<b>1-56</b>
<b>Xclock Category .....</b>	<b>1-57</b>
<b>CHAPTER 2-</b>	
<b>Function/Block Descriptions .....</b>	<b>2-1</b>
ABRTALL .....	2-2
ABRTMOVE .....	2-2
ABS.....	2-3
ACC_DEC .....	2-4
ACC_JERK.....	2-5
ACOS.....	2-9
ADD.....	2-9
AND.....	2-10
ANLGINIT .....	2-11
ANLG_OUT .....	2-13
ARTDCHIT .....	2-17
ARTDCHRD .....	2-19
ARTDMDIT .....	2-21
ASIN.....	2-22
ASSIGN .....	2-23
ATAN .....	2-25
ATMPCHIT .....	2-26
ATMPCHRD .....	2-28
ATMPMDIT .....	2-30

A_DT_T.....	2-31
A_IN_MMC.....	2-32
A_INCHIT.....	2-33
A_INCHRD.....	2-36
A_INMDIT.....	2-40
A_TOD_T.....	2-41
BAT_OK?.....	2-42
BIO_PERF.....	2-43
BOOL2BYT.....	2-46
BTMPCHIT.....	2-47
BTMPCHRD.....	2-48
BTMPMGR.....	2-50
BYT2BOOL.....	2-51
BYTE2DW.....	2-52
BYTE2LW.....	2-52
BYTE2SI.....	2-53
BYTE2USI.....	2-53
BYTE2WO.....	2-54
CAM_OUT.....	2-55
CAPTINIT.....	2-59
CAPTSTAT.....	2-65
CLOCK.....	2-66
CLOSE.....	2-67
CLOSLOOP.....	2-68
CLSLOOP?.....	2-69
CONCAT.....	2-70
CONFIG.....	2-71
COORD2RL.....	2-74
COS.....	2-78
CTD.....	2-78
CTU.....	2-79
CTUD.....	2-80
C_ERRORS.....	2-81
C_RESET.....	2-83
C_STOP.....	2-83
C_STOP?.....	2-84
DATE2STR.....	2-85
DELETE.....	2-86
DELFIL.....	2-87
DINT2DW.....	2-88
DINT2INT.....	2-88
DINT2LI.....	2-89
DINT2RE.....	2-89
DINT2SI.....	2-90
DINT2UDI.....	2-90
DIRECT.....	2-91

DISTANCE.....	2-93
DIV .....	2-94
DLS_INIT.....	2-95
DLS_RECV .....	2-97
DLS_SEND .....	2-98
DLS_STAT.....	2-99
DPOSMODE .....	2-100
DRSETFLT.....	2-101
DSTRTSRV .....	2-102
DT2DATE .....	2-103
DT2STR.....	2-103
DT2TOD.....	2-104
DTORQCMD.....	2-105
DVELCMD.....	2-106
DWORD2BYT .....	2-107
DWOR2DI .....	2-108
DWOR2LW .....	2-108
DWOR2RE .....	2-109
DWOR2UDI .....	2-109
DWOR2WO.....	2-110
D_TOD2DT .....	2-110
EQ.....	2-111
EXP.....	2-112
E_ERRORS .....	2-113
E_RESET .....	2-115
E_STOP .....	2-115
E_STOP? .....	2-116
FAST_QUE .....	2-117
FAST_REF .....	2-120
FB_CLS .....	2-125
FB_OPN.....	2-126
FB_RCV .....	2-127
FB_SND.....	2-128
FB_STA .....	2-129
FIND .....	2-132
FRESPACE.....	2-133
FU2LU .....	2-134
GE .....	2-135
GETDAY .....	2-136
GR_END.....	2-137
GT .....	2-138
HOLD .....	2-138
HOLD_END .....	2-139
INSERT .....	2-140
INT2DINT .....	2-141
INT2LINT.....	2-141

INT2SINT .....	2-142
INT2UINT .....	2-142
INT2WORD .....	2-143
IN_POS? .....	2-143
IO_CFG .....	2-144
IPACCEPT .....	2-148
IPCLOSE .....	2-149
IPCONN .....	2-150
IPHOSTID .....	2-151
IPIP2NAM .....	2-152
IPLISTEN .....	2-153
IPNAM2IP .....	2-154
IPREAD .....	2-155
IPRECV .....	2-156
IPSEND .....	2-158
IPSOCK .....	2-159
IPSTAT .....	2-160
IPWRITE .....	2-161
Overview for Using the Ethernet -TCP/IP Function Blocks .....	2-162
Ethernet-TCP/IP Errors .....	2-164
LAD_REF .....	2-167
LE .....	2-170
LEFT .....	2-171
LEN .....	2-172
LIMIT .....	2-173
LINT2DI .....	2-174
LINT2INT .....	2-174
LINT2LR .....	2-175
LINT2LW .....	2-175
LINT2SI .....	2-176
LINT2ULI .....	2-176
LN .....	2-177
LOG .....	2-177
LREA2LI .....	2-178
LREA2LW .....	2-178
LREA2RE .....	2-179
LREA2ULI .....	2-179
LT .....	2-180
LU2FU .....	2-181
LWOR2BYT .....	2-181
LWOR2DW .....	2-182
LWOR2LI .....	2-182
LWOR2LR .....	2-183
LWOR2ULI .....	2-183
LWOR2WO .....	2-184
LWR_CASE .....	2-184

MAX.....	2-185
MEASURE.....	2-185
MID.....	2-186
MIN.....	2-187
MOD.....	2-187
MOVE.....	2-188
MUL.....	2-189
MUX.....	2-190
NE.....	2-191
NEG.....	2-191
NETCLS.....	2-192
NETFRE.....	2-192
NETMON.....	2-193
NETOPN.....	2-194
NETRCV.....	2-196
NETSND.....	2-198
NETSTA.....	2-200
NEWRATIO.....	2-201
NEW_RATE.....	2-203
NOT.....	2-204
NUM2STR.....	2-205
OK_ERROR.....	2-206
OPEN.....	2-207
OPENLOOP.....	2-209
OR.....	2-210
PART_CLR.....	2-211
PART_REF.....	2-212
PID.....	2-213
PID2.....	2-222
PLS.....	2-227
PLS_EDIT.....	2-231
POSITION.....	2-232
P_ERRORS.....	2-233
P_RESET.....	2-236
PWDTY.....	2-237
Q_AVAIL?.....	2-238
Q_NUMBER.....	2-239
RAMP.....	2-240
RATIOCAM.....	2-241
RATIOPRO.....	2-252
RATIOSCL.....	2-257
RATIOSLP.....	2-261
RATIOSYN.....	2-273
RATIO_GR.....	2-283
RATIO_RL.....	2-286
READ.....	2-295



READFDBK.....	2-297
READ_SV.....	2-308
READ_SVF.....	2-346
REAL2DI.....	2-347
REAL2DW.....	2-347
REAL2LR.....	2-348
REAL2UDI.....	2-348
REF_DNE?.....	2-349
REF_END.....	2-349
REGIST.....	2-350
RENAME.....	2-359
REPLACE.....	2-361
REP_END.....	2-362
RESMODE?.....	2-363
RESUME.....	2-364
RIGHT.....	2-366
ROL.....	2-367
ROR.....	2-368
R_PERCEN.....	2-369
SC_INIT.....	2-370
SCA_ACKR.....	2-371
SCA_CLOS.....	2-372
SCA_CTRL.....	2-373
SCA_ERST.....	2-376
SCA_PBIT.....	2-377
SCA_RCYC.....	2-379
SCA_RECV.....	2-381
SCA_REF.....	2-383
SCA_RFIT.....	2-385
SCA_SEND.....	2-388
SCA_STAT.....	2-390
SCA_WCYC.....	2-391
SCR_CONT.....	2-392
SCR_ERR.....	2-393
SCR_PHAS.....	2-396
SCS_ACKR.....	2-397
SCS_CTRL.....	2-398
SCS_RECV.....	2-400
SCS_REF.....	2-402
SCS_SEND.....	2-404
SCS_STAT.....	2-406
SCURVE.....	2-411
SEEK.....	2-416
SEL.....	2-418
SERVOCLK.....	2-419
SHL.....	2-420

SHR.....	2-421
SIN.....	2-422
SINT2BYT.....	2-422
SINT2DI.....	2-423
SINT2INT.....	2-423
SINT2LI.....	2-424
SINT2USI.....	2-424
SIZEOF.....	2-425
SQRT.....	2-427
STATUS.....	2-428
STATUSSV.....	2-429
STEPCTL.....	2-431
STEPINIT.....	2-435
STEPSTAT.....	2-437
STEP_CMD.....	2-440
STEP_POS.....	2-450
STR2D_T.....	2-451
STR2NUM.....	2-452
STR2USI.....	2-452
STRTSERV.....	2-453
SUB.....	2-456
SYN_END.....	2-457
S_DT_DT.....	2-458
S_DT_T.....	2-459
S_D_D.....	2-460
S_TOD_T.....	2-461
S_TOD_TO.....	2-462
TAN.....	2-463
TAUFFAC.....	2-463
TAUFILT.....	2-464
TIM2UDIN.....	2-464
TIME2STR.....	2-465
TME_ERR?.....	2-466
TOD2STR.....	2-466
TOF.....	2-467
TON.....	2-468
TP.....	2-469
TUNERead.....	2-470
TUNEWrit.....	2-471
UDIN2DI.....	2-474
UDIN2DW.....	2-474
UDIN2RE.....	2-475
UDIN2TIM.....	2-475
UDIN2UI.....	2-476
UDIN2ULI.....	2-476
UDIN2USI.....	2-477

UINT2INT .....	2-477
UINT2UDI.....	2-478
UINT2ULI .....	2-478
UINT2USI .....	2-479
UINT2WO .....	2-479
ULIN2LI .....	2-480
ULIN2LR.....	2-480
ULIN2LW.....	2-481
ULIN2UDI.....	2-481
ULIN2UI.....	2-482
ULIN2USI .....	2-482
UPR_CASE .....	2-483
USIN2BYT .....	2-483
USIN2SI.....	2-484
USIN2STR.....	2-484
USIN2UDI .....	2-485
USIN2UI.....	2-485
USIN2ULI .....	2-486
VEL_END .....	2-486
VEL_STRT.....	2-487
VFASTIN.....	2-488
WORD2BYT .....	2-489
WORD2DW.....	2-489
WORD2INT.....	2-490
WORD2LW .....	2-490
WORD2UI .....	2-491
WRITE.....	2-492
WRITE_SV.....	2-493
WRIT_SVF.....	2-494
XOR.....	2-495
<b>A.1 Operator Interface ASFB .....</b>	<b>A.1-1</b>
OI_SER.....	A.1-2
<b>B.1 OPC Server ASFB .....</b>	<b>B.1-1</b>
OPC_ENET .....	B.1-2
OPC_10.....	B.1-6
<b>C.1 Temperature Function Errors .....</b>	<b>C.1-1</b>
<b>INDEX.....</b>	<b>IND-1</b>

## NOTES

# PiCPro Function/Blocks Overview

---

## Introduction

---

Function and function blocks are the programming tools used to perform operations on data in PiCPro ladder diagram programs. They are similar to the subroutines of other programming languages.

The difference between functions and function blocks is that a function completes an operation in one scan whereas a function block may take more than one scan to complete an operation. Therefore, function blocks must have internal storage for their variables from scan to scan until their operation is complete. You must declare and assign a name to function blocks in the software declaration table so that PiCPro can reserve memory for them.

Chapter 1 of this reference manual presents a summary of all the standard functions and function blocks available within PiCPro. This summary will familiarize you with what is available for programming.

Chapter 2 presents descriptions of all the function/function blocks in alphabetical order.

### NOTE

You must have a math coprocessor (NPX) installed in the control to perform any functions involving logarithmic, exponential, trigonometric, and floating point mathematical operations. The PiC 904x series, PiC94x series, MMC, and MMC for PC CPUs already have an integrated math coprocessor. To determine if your control has a math coprocessor, start PiCPro and select **Online | Status**. The CPU line contains an “NPX” if you have a math coprocessor.

All functions and function blocks for PiCPro are stored in libraries according to the category of operations they perform. The list of the libraries appears under the Ladder/Functions menu.

Arith
Binary
Counters
Datatype
Evaluate
Fbinter
Filter
Io
Motion
PID
String
Timers
Xclock

**NOTE**

When you use the UDFB or TASK feature to create your own function blocks, another category appears called USER as shown below. This is not a library, but selecting it will bring up a list of any library you have created to store UDFBs or TASKs.

Arith
Binary
Counters
Datatype
Evaluate
Fbinter
Filter
Io
Motion
PID
String
Timers
USER
Xclock

When you create a Servo or SERCOS setup file, you create a library to store the setup function in. This library also shows up in the above list.

When you access a library one of two things happens.

- 1.** You are given a list of all the function/blocks available in that library. You select the function/block you want to insert into a network of your module from this list.

or

- 2.** You are given a list of groups into which all the function/blocks have been divided. You select the group that holds the function/block you want. This brings up the list of function/blocks in that group and now you can select the one you want to insert into the network of your module.

The table below shows all the lists that appear when a library is selected. Whether the list represents groups or function/blocks is indicated.

**Table 1-1. Library Lists**

<b>Arith Groups</b>	<b>Binary Functions</b>	<b>Counters Function blocks</b>	<b>Datatype Groups</b>	<b>Evaluate Functions</b>	<b>Fbinter Function Blocks</b>
<div style="border: 1px solid black; padding: 5px;">           ARITH DATETIME TRIG         </div>	<div style="border: 1px solid black; padding: 5px;">           AND NOT OR ROL ROR SHL SHR XOR         </div>	<div style="border: 1px solid black; padding: 5px;">           CTD CTU CTUD         </div>	<div style="border: 1px solid black; padding: 5px;">           BOOL2BYT BYTECONV DINTCONV DWORDCNV D_TCONV INTCONV LINTCONV LREALCNV LWORDCNV NUM2STR REALCONV SINTCONV SIZEOF STRCONV UDINTCNV UINTCONV ULINTCNV USINTCNV WORDCONV         </div>	<div style="border: 1px solid black; padding: 5px;">           EQ GE GT LE LT NE OK_ERROR         </div>	<div style="border: 1px solid black; padding: 5px;">           FB_CLS FB_OPN FB_RCV FB_SND FB_STA         </div>
<b>Filter Functions</b>	<b>Io Groups</b>	<b>Motion Groups</b>	<b>PID Function/ Blocks</b>	<b>String Functions</b>	<b>Timers Function Blocks</b>
<div style="border: 1px solid black; padding: 5px;">           LIMIT MAX MIN MOVE MUX SEL         </div>	<div style="border: 1px solid black; padding: 5px;">           ANLGIN ANLGOUT BAT_OK? BIO_PERF COMM JKTHERM NETWORK PID READFDBK RTDTEMP SOCKETS STEPPER         </div>	<div style="border: 1px solid black; padding: 5px;">           DATA ERRORS INIT MOVE MOVE_SUP QUE RATIOMOV REF SERC-SLV SERC_SYS         </div>	<div style="border: 1px solid black; padding: 5px;">           PID2 PWDTY RAMP TAUFFAC TAUFILT         </div>	<div style="border: 1px solid black; padding: 5px;">           CONCAT DELETE FIND INSERT LEFT LEN LWR_CASE MID REPLACE RIGHT UPR_CASE         </div>	<div style="border: 1px solid black; padding: 5px;">           TOF TON TP         </div>
<b>(USER) (Libraries)</b> (Contains library list when you use the UDFB or TASK fea- tures.)	<b>Xclock Functions</b>  <div style="border: 1px solid black; padding: 5px;">           CLOCK GETDAY SERVOCLK         </div>				

When you create SERCOS and/or Servo Setup files, a new library named by you is added alphabetically to the list of libraries.



In Table 1-2 the function/blocks found under the groups are shown. When there is no list of function/blocks shown, there is only one function in that group. Accessing that name inserts the function in your network. One example is the BOOL2BYT function in the datatype group.

**Table 1-2.**

**Arith groups**

ARITH	DATETIME	TRIG
ABS ADD DIV MOD MUL NEG SORT SUB	A_DT_T A_TOD_T S_DT_DT S_DT_T S_D_D S_TOD_T S_TOD_TO	ACOS ASIN ATAN COS EXP LN LOG SIN TAN

**Datatype groups**

BOOL2BYT	BYTECONV	DINTCONV	DWORD-CNV	D_TCONV	INTCONV	LINTCONV	LREALCNV	LWORD-CNV
	BYT2BOOL BYTE2DW BYTE2LW BYTE2SI BYTE2USI BYTE2WO	DINT2DW DINT2INT DINT2LI DINT2RE DINT2SI DINT2UDI	DWOR2BYT DWOR2DI DWOR2LW DWOR2RE DWOR2UDI DWOR2WO	DATE2STR DT2DATE DT2STR DT2TOD D_TOD2DT TIME2DIN TIME2STR TOD2STR	INT2DINT INT2LINT INT2SINT INT2UINT INT2WORD	LINT2DI LINT2INT LINT2LR LINT2LW LINT2SI LINT2ULI	LREA2LI LREA2LW LREA2RE LREA2ULI	LWOR2BYT LWOR2DW LWOR2LI LWOR2LR LWOR2ULI LWOR2WO

NUM2STR	SIZEOF	REALCONV	SINTCONV	STRCONV	UDINTCNV	UINTCONV	ULINTCNV	USINTCNV	WORD-CNV
		REAL2DI REAL2DW REAL2LR REAL2UDI	SINT2BYT SINT2DI SINT2INT SINT2LI SINT2USI	STR2D_T STR2NUM STR2USI	UDIN2DI UDIN2DW UDIN2RE UDIN2TIM UDIN2UI UDIN2ULI UDIN2USI	UIN2INT UIN2UDI UIN2ULI UIN2USI UIN2WO	ULIN2LI ULIN2LR ULIN2LW ULIN2UDI ULIN2UI ULIN2USI	USIN2BYT USIN2SI USIN2STR USIN2UDI USIN2UI USIN2ULI	WORD2BYT WORD2DW WORD2INT WORD2LW WORD2UI

**Io groups**

ANLGIN	ANLGOUT	BAT_OK?	BIO_PERF	COMM	JKTHE_RM	NET-WORK	P I D	R E A D B B K	RTDTEMP	SOCKETS	STEPPER
A_INCHIT A_INCHRD A_INMDIT A_IN_MMC	ANLGINIT ANLG_OUT		BIO_PERF IO_CFG	ASSIGN CLOSE CONFIG DELFIL DIRECT FRESpace OPEN READ RENAME SEEK STATUS WRITE	ATMPCHIT ATMPCHRD ATMPMDIT BTMPCHIT BTMPCHRD BTMPMGR	NETCLS NETFRE NETMON NETOPN NETRCV NETSND NETSTA			ARTDCHIT ARTDCHRD ARTDMIT	IPACCEPT IPCLOSE IIPCONN IIPHOSTID IPIP2NAM IPLISTEN IIPNAM2IP IPREAD IIPRECV IPSEND IPSOCK IPSTAT IPWRITE	STEPCTL STEPINIT STEPSTAT STEP_CMD STEP_POS

## ARITH group

### Motion groups

DATA	ERRORS	INIT	MOVE	MOVE_ SUP	QUE	RATIO- MOV	REF	SERC_SLV	SERC_SYS
CAPTINIT CAPSTAT COORD2RL DLS_INIT DLS_RECV DLS_SEND DLS_STAT FU2FU LU2FU READ_SV READ_SVF SCA_CTRL SCA_RCYC SCA_RECV SCA_SEND SCA_STAT SCA_WCYC STATUSV TUNERead TUNEWRT WRITE_SV WRT_SVF	C_ERRORS C_RESET C_STOP C_STOP? E_ERRORS E_RESET E_STOP E_STOP? P_ERRORS P_RESET RESMODE? RESUME SCA_ERST TME_ERR?	CLOSLOOP CLSLOOP? OPENLOOP SCA_CLOS STRTSRV DRSETFLT DSTRTSRV	DISTANCE DPOSMODE DTOROCMD DVELCMD POSITION VEL_END VEL_STRT	ACC_DEC ACC_JERK CAM_OUT HOLD HOLD_END IN_POS? MEASURE NEWRATIO NEW_RATE PLS PLS_EDIT RATIO_SCL REGIST R_PERCEN SCA_PBIT SCURVE VFASTIN	ABRTALL ABRTMOVE FAST_QUE Q_AVAIL? Q_NUMBER	GR_END RATIOCAM RATIOPRO RATIO_SLP RATIO_SYN RATIO_GR RATIO_RL REP_END SYN_END	FAST_REF LAD_REF PART_CLR PART_REF REF_DNE? REF_END SCA_ACKR SCA_RFIT SCA_REF	SCS_ACKR SCS_CTRL SCS_RECV SCS_REF SCS_SEND SCS_STAT	SCR_CONT SCR_ERR SCR_PHAS SC_INIT

## Arithmetic Category

### ARITH group

The functions in the ARITH group perform the familiar operations of addition, subtraction, multiplication, division, modulo (remainder), absolute value, square root, and negate (opposite) value.

#### CAUTION

If an underflow or overflow error occurs when one of these arithmetic functions executes, the output at OK will not energize. The value at OUT will be unpredictable.

Function	Description	Page
ABS	Gives the absolute value of a number.	2-3
ADD	Adds from 2 to 17 numbers.	2-9
DIV	Performs the division operation and returns the quotient.	2-94
MOD	Performs the division operation and returns the remainder.	2-187
MUL	Multiplies from 2 to 17 numbers.	2-189
NEG	Returns the opposite value of a number.	2-191
SQRT	Determines the square root of a number.	2-427
SUB	Performs the subtraction operation on 2 numbers.	2-456

## **DATETIME group**

The functions in the DATETIME group are used to add or subtract TIME duration and/or TIME\_OF\_DAY type variables or constants. The D#, T#, TOD#, and DT# characters are part of the result in the output variables, except for STRINGS.

When one of these functions executes, if an error occurs, the output at OK does not energize, and the value of the variable at OUT will be:

TIME duration: T#0 TIME\_OF\_DAY: TOD#0:0:0 DATE: D#1988-01-01  
 DATE\_AND\_TIME: DT#1988-01-01-00:00:00STRING: null (length 0)

For every output variable, its value cannot exceed the largest value allowed for the largest time increment, and it cannot be less than zero for the smallest time increment. Other values “roll over”.

For example, if the largest increment is days, the output value must not exceed 49. If the smallest increment is seconds, the output value must not be less than 0 seconds. However, 24 hours becomes 1 day for a DATE\_AND\_TIME variable (whose largest increment is years).

<b>Function</b>	<b>Description</b>	<b>Page</b>
A_DT_T	Adds DATE_AND_TIME to TIME and outputs a DATE_AND_TIME sum.	2-31
A_TOD_T	Adds TIME_OF_DAY to TIME and outputs a TIME_OF_DAY sum.	2-41
S_DT_DT	Subtracts a DATE_AND_TIME from a DATE_AND_TIME and outputs a TIME duration value.	2-458
S_DT_T	Subtracts TIME from a DATE_AND_TIME and outputs a DATE_AND_TIME.	2-459
S_D_D	Subtracts a DATE from a DATE and outputs a TIME duration value.	2-460
S_TOD_T	Subtracts TIME from TIME_OF_DAY and outputs TIME_OF_DAY.	2-461
S_TOD_TO	Subtracts TIME_OF_DAY from TIME_OF_DAY and outputs a TIME duration value.	2-462

---

---

## TRIG group

The functions in the TRIG group perform trigonometric or transcendental functions.

Function	Description	Page
ACOS	Calculates the arc cosine.	2-9
ASIN	Calculates the arc sine.	2-22
ATAN	Calculates the arc tangent.	2-25
COS	Calculates the cosine.	2-78
EXP	Calculates the exponent.	2-112
LN	Calculates the natural log.	2-177
LOG	Calculates the log.	2-177
SIN	Calculates the sine.	2-422
TAN	Calculates the tangent.	2-463

## Binary Category

---

The functions in the Binary library perform two types of operations:

1. Logical or Boolean operations
2. Bit shifting and rotating operations

### Logic functions

The logic functions evaluate the input values on a bit by bit basis, and place results for each bit into the corresponding bit of the output variable. In general, bit x of every input variable is evaluated and a result is put into bit x of the output variable.

### Bit shifting and rotating functions

The bit shifting and rotating functions “move” the values of bits. The values are shifted or rotated to the left or right.

Function	Description	Page
AND	Performs the boolean AND operation on from 2 to 17 numbers.	2-10
NOT	Complements the bits of a number.	2-204
OR	Performs the boolean inclusive OR operation on from 2 to 17 numbers.	2-210
ROL	Rotates n bits from left to right (most significant to least significant positions).	2-367
ROR	Rotates n bits from right to left (least significant to most significant positions).	2-368
SHL	Shifts all bits of a number n positions to the left, discarding n bits on the left (most significant), and inserting n 0s on the right (least significant).	2-420
SHR	Shifts all bits of a number n positions to the right, discarding n bits on the right (least significant), and inserting n 0s on the left (most significant).	2-421
XOR	Performs the boolean exclusive OR operation on from 2 to 17 numbers.	2-495

## Counters Category

---

The function blocks in the Counter library serve as counters.

<b>Function Block</b>	<b>Description</b>	<b>Page</b>
CTD	Counts down from a specified value and then energizes an output.	2-78
CTU	Counts up to a specified value and then energizes an output.	2-79
CTUD	Counts up or down from a specified value and then energizes the appropriate output.	2-80

## **Datatype Category**

---

The Datatype library contains all the functions that convert one data type to another.

### **BOOL2BYT group**

The BOOL2BYT group converts a boolean data type.

<b>Function</b>	<b>Description</b>	<b>Page</b>
BOOL2BYT	Changes the data type from boolean to byte.	2-46

### **BYTECONV group**

---

The BYTECONV group converts byte data types.

<b>Function</b>	<b>Description</b>	<b>Page</b>
BYT2BOOL	Changes the data type from byte to boolean	2-51
BYTE2DW	Changes the data type from byte to double word.	2-52
BYTE2LW	Changes the data type from byte to long word.	2-52
BYTE2SI	Changes the data type from byte to short integer.	2-53
BYTE2USI	Changes the data type from byte to unsigned short integer.	2-53
BYTE2WO	Changes the data type from byte to word.	2-54

## **DINTCONV group**

The DINTCONV group converts double integer data types.

<b>Function</b>	<b>Description</b>	<b>Page</b>
DINT2DW	Changes the data type from double integer to double word.	2-88
DINT2INT	Changes the data type from double integer to integer.	2-88
DINT2LI	Changes the data type from double integer to long integer.	2-89
DINT2RE	Changes the data type from double integer to real.	2-89
DINT2SI	Changes the data type from double integer to short integer.	2-90
DINT2UDI	Changes the data type from double integer to unsigned double integer.	2-90



---

---

**DWORDCNV group**

The DWORDCNV group converts double word data types.

<b>Function</b>	<b>Description</b>	<b>Page</b>
DWOR2BYT	Changes the data type from double word to byte.	2-107
DWOR2DI	Changes the data type from double word to double integer.	2-108
DWOR2LW	Changes the data type from double word to long word.	2-108
DWOR2RE	Changes the data type from double word to real.	2-109
DWOR2UDI	Changes the data type from double word to unsigned double integer.	2-109
DWOR2WO	Changes the data type from double word to word.	2-110

---

---

## **D\_TCONV group**

The D\_TCONV group converts date and time data types.

<b>Function</b>	<b>Description</b>	<b>Page</b>
DATE2STR	Changes the DATE value to a STRING value.	2-85
DT2DATE	Outputs the DATE from a DATE_AND_TIME value.	2-103
DT2STR	Changes the DATE_AND_TIME value to a STRING value.	2-103
DT2TOD	Outputs the TIME_OF_DAY from a DATE_AND_TIME value.	2-104
D_TOD2DT	Concatenates DATE and TIME_OF_DAY values and outputs a DATE_AND_TIME value.	2-104
TIM2UDIN	Changes the data type from TIME to unsigned double integer.	2-464
TIME2STR	Changes a TIME duration value to a STRING value.	2-465
TOD2STR	Changes a TIME_OF_DAY value to a STRING value.	2-466

---

---

## INTCONV group

The INTCONV group converts integer data types.

<b>Function</b>	<b>Description</b>	<b>Page</b>
INT2DINT	Changes the data type from integer to double integer.	2-141
INT2LINT	Changes the data type from integer to long integer.	2-141
INT2SINT	Changes the data type from integer to short integer.	2-142
INT2UINT	Changes the data type from integer to unsigned integer.	2-142
INT2WORD	Changes the data type from integer to word.	2-143

---

---

## **LINTCONV group**

The LINTCONV group converts long integer data types.

<b>Function</b>	<b>Description</b>	<b>Page</b>
LINT2DI	Changes the data type from long integer to double integer.	2-174
LINT2INT	Changes the data type from long integer to integer.	2-174
LINT2LR	Changes the data type from long integer to long real.	2-175
LINT2LW	Changes the data type from long integer to long word.	2-175
LINT2SI	Changes the data type from long integer to short integer.	2-176
LINT2ULI	Changes the data type from long integer to unsigned long integer.	2-176

---

---

**LREALCNV group**

The LREALCNV group converts long real data types.

<b>Function</b>	<b>Description</b>	<b>Page</b>
LREA2LI	Changes the data type from long real to long integer.	2-178
LREA2LW	Changes the data type from long real to long word.	2-178
LREA2RE	Changes the data type from long real to real.	2-179
LREA2ULI	Changes the data type from long real to unsigned long integer.	2-179

---

---

## **LWORDCNV group**

The LWORDCNV group converts long word data types.

<b>Function</b>	<b>Description</b>	<b>Page</b>
LWOR2BYT	Changes the data type from long word to byte.	2-181
LWOR2DW	Changes the data type from long word to double word.	2-182
LWOR2LI	Changes the data type from long word to long integer.	2-182
LWOR2LR	Changes the data type from long word to long real.	2-183
LWOR2ULI	Changes the data type from long word to unsigned long integer.	2-183
LWOR2WO	Changes the data type from long word to word.	2-184

---

---

## **NUM2STR group**

The NUM2STR group converts a numeric data type.

<b>Function</b>	<b>Description</b>	<b>Page</b>
NUM2STR	Changes the data type from numeric to STRING.	2-205

---

---

## **REALCONV group**

The REALCONV group converts real data types.

<b>Function</b>	<b>Description</b>	<b>Page</b>
REAL2DI	Changes the data type from real to double integer.	2-347
REAL2DW	Changes the data type from real to double word.	2-347
REAL2LR	Changes the data type from real to long real.	2-348
REAL2UDI	Changes the data type from real to unsigned double integer.	2-348



---

---

**SINTCONV group**

The SINTCONV group converts short integer data types.

<b>Function</b>	<b>Description</b>	<b>Page</b>
SINT2BYT	Changes the data type from short integer to byte.	2-422
SINT2DI	Changes the data type from short integer to double integer.	2-423
SINT2INT	Changes the data type from short integer to integer.	2-423
SINT2LI	Changes the data type from short integer to long integer.	2-424
SINT2USI	Changes the data type from short integer to unsigned short integer.	2-424

## *SIZEOF group*

### **SIZEOF group**

The SIZEOF group contains one function.

<b>Function</b>	<b>Description</b>	<b>Page</b>
SIZEOF	Reports the size in bytes of the variable name listed at the IN input.	2-425

**STRCONV group**

The STRCONV group converts string data types.

<b>Function</b>	<b>Description</b>	<b>Page</b>
STR2D_T	Changes the data type from STRING to date and time.	2-451
STR2NUM	Changes the data type from STRING to numeric.	2-452
STR2USI	Changes the first character of STRING to unsigned short integer (ASCII code).	2-452

---

---

## UDINTCNV group

The UDINTCNV group converts unsigned double integer data types.

Function	Description	Page
UDIN2DI	Changes the data type from unsigned double integer to double integer.	2-474
UDIN2DW	Changes the data type from unsigned double integer to double word.	2-474
UDIN2RE	Changes the data type from unsigned double integer to real.	2-475
UDIN2TIM	Changes the data type from unsigned double integer to time.	2-475
UDIN2UI	Changes the data type from unsigned double integer to unsigned integer.	2-476
UDIN2ULI	Changes the data type from unsigned double integer to unsigned long integer.	2-476
UDIN2USI	Changes the data type from unsigned double integer to unsigned short integer.	2-477

---

---

## UINTCONV group

The UINTCONV group converts unsigned integer data types.

<b>Function</b>	<b>Description</b>	<b>Page</b>
UINT2INT	Changes the data type from unsigned integer to integer.	2-477
UINT2UDI	Changes the data type from unsigned integer to unsigned double integer.	2-478
UINT2ULI	Changes the data type from unsigned integer to unsigned long integer.	2-478
UINT2USI	Changes the data type from unsigned integer to unsigned short integer.	2-479
UINT2WO	Changes the data type from unsigned integer to word.	2-479

---

---

## ULINTCNV group

The ULINTCONV group converts unsigned long integer data types.

<b>Function</b>	<b>Description</b>	<b>Page</b>
ULIN2LI	Changes the data type from unsigned long integer to long integer.	2-480
ULIN2LR	Changes the data type from unsigned long integer to long real.	2-480
ULIN2LW	Changes the data type from unsigned long integer to long word.	2-481
ULIN2UDI	Changes the data type from unsigned long integer to unsigned double integer	2-481
ULIN2UI	Changes the data type from unsigned long integer to unsigned integer	2-482
ULIN2USI	Changes the data type from unsigned long integer to unsigned short integer	2-482

---

---

**USINTCNV group**

The USINTCNV group converts unsigned short integer data types.

<b>Function</b>	<b>Description</b>	<b>Page</b>
USIN2BYT	Changes the data type from unsigned short integer to byte.	2-483
USIN2SI	Changes the data type from unsigned short integer to short integer.	2-484
USIN2STR	Changes the data type from unsigned short integer (ASCII code) to the first character in STRING.	2-484
USIN2UDI	Changes the data type from unsigned short integer to unsigned double integer.	2-485
USIN2UI	Changes the data type from unsigned short integer to unsigned integer.	2-485
USIN2ULI	Changes the data type from unsigned short integer to unsigned long integer.	2-486

---



---

## WORDCONV group

The WORDCONV group converts word data types.

Function	Description	Page
WORD2BYT	Changes the data type from word to byte.	2-489
WORD2DW	Changes the data type from word to double word.	2-489
WORD2INT	Changes the data type from word to integer.	2-490
WORD2LW	Changes the data type from word to long word.	2-490
WORD2UI	Changes the data type from word to unsigned integer.	2-491

---

## Evaluate Category

The functions in the Evaluate library compare numbers. The comparisons are:

equal to =	greater than >	greater than or equal to $\geq$
not equal to $\neq$	less than <	less than or equal to $\leq$

Function	Description	Page
EQ	Compares from 2 to 17 numbers and energizes an output if all numbers are equal to each other.	2-111
GE	Compares from 2 to 17 numbers and energizes an output if all numbers are greater than or equal to successive numbers.	2-135
GT	Compares from 2 to 17 numbers and energizes an output if all numbers are greater than successive numbers.	2-138
LE	Compares from 2 to 17 numbers and energizes an output if all numbers are less than or equal to successive numbers.	2-170
LT	Compares from 2 to 17 numbers and energizes an output if all numbers are less than successive numbers.	2-180
NE	Compares 2 numbers and energizes an output if they are not equal to each other.	2-191
OK_ERROR	Evaluates the condition of the OK outputs of all functions from the beginning of the network to this function.	2-206



**NOTES ON STRING EVALUATIONS**

If String 1 = 1 2 9  
and String 2 = 1 2 3 4

then String 1 > String 2

If two strings have different lengths and the characters in the shorter string match the characters in the longer string, then the shorter string is less than the longer one.

If String 1 = 1 2 3  
and String 2 = 1 2 3 4

then String 1 < String 2

Another example is shown below. String 1 is less than String 2 because the ASCII value of upper case letters is less than the value of lower case letters.

If String 1 = TIME  
and String 2 = Time

then String 1 < String 2

## Fbinter Category

---

The function/function blocks in the Fbinter library allow you to interface with field bus communications via the DeviceNet hardware module.

Function	Description	Page
FB_CLS	Closes communications with the field bus.	2-125
FB_OPN	Opens communications with the field bus placing the DeviceNet module in the RUN mode.	2-126
FB_RCV	Receives all data from the configurator file indicated by Tag names.	2-127
FB_SND	Sends data indicated by Tag names in the configurator file.	2-128
FB_STA	Allows you to check if the DeviceNet module is communicating with the nodes and to check field bus information.	2-129

## Filter Category

---

The functions in the Filter library act as filters or sorters. They move the value of one of the inputs into an output variable.

Function	Description	Page
LIMIT	Evaluates a number and outputs the number if it is within specified limits, or outputs the upper or lower limit if the number is greater than or less than the limit, respectively.	2-173
MAX	Compares from 2 to 17 numbers and outputs the largest number.	2-185
MIN	Compares from 2 to 17 numbers and outputs the smallest number.	2-187
MOVE	Places from 1 to 17 numbers into output variables of the same type(s).	2-188
MUX	Evaluates from 2 to 17 numbers and outputs one of the numbers based on the value of an independent number.	2-190
SEL	Evaluates 2 numbers and outputs one of them based on the state of a boolean input.	2-418

## **I/O Category**

---

The functions in the I/O library initialize and send/receive data to/from:

- Analog input module
- Analog and 4-20mA output modules
- Controls, ports, files, devices, serial communications module
- J-K thermocouple module
- PID loops
- Encoder module (background read)
- RTD module
- Sockets
- Stepper module

---

---

## **ANLGIN group**

The ANLGIN group contains functions that work with the analog input module.

<b>Function</b>	<b>Description</b>	<b>Page</b>
A_INCHIT	Initializes a channel on an analog input module.	2-33
A_INCHRD	Reads or samples the voltage or current occurring at a channel on an analog input module.	2-36
A_INMDIT	Initializes an analog input module.	2-40
A_IN_MMC	Outputs the digital value of an analog input for the MMC.	2-32

---

---

## ANLGOUT group

The ANLGOUT group contains functions that work with the analog or 4-20mA output module.

Function	Description	Page
ANLGINIT	Initializes an analog or 4-20mA output module.	2-11
ANLG_OUT	Sends a value (to be converted to voltage or current) to a channel on an analog or 4-20mA output module.	2-13

---

---

## **BAT\_OK? group**

The BAT\_OK? group has one function that allows you to check the battery of the control from the ladder.

<b>Function</b>	<b>Description</b>	<b>Page</b>
BAT_OK?	Checks the battery from the ladder.	2-42

---

---

**BIO\_PERF group**

The BIO\_PERF group has two function/function blocks: one that allows you to check the performance of the block I/O modules in your system and one that initializes the configuration of the block system.

<b>Function</b>	<b>Description</b>	<b>Page</b>
BIO_PERF	Checks the performance of block I/O modules.	2-43
IO_CFG	Initializes the block I/O configuration, checks the status, and inhibits the block system when blocks are added or removed.	2-144

## COMM group

The function blocks in the COMM group are used to transfer (read/write) data between any of the following:

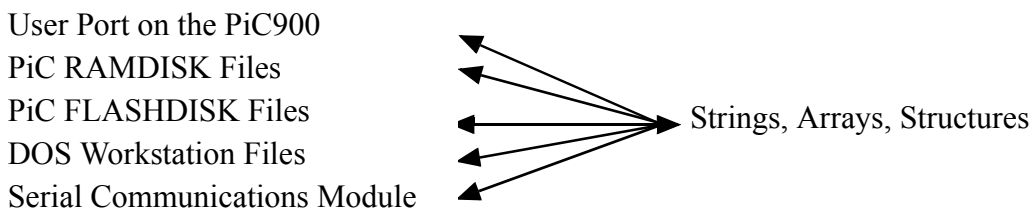

Function Block	Description	Page
ASSIGN	Sets up the channels on the serial communications module to work like the User Port for communications.	2-23
CLOSE	Closes the communication channel between the LDO and a DOS file, RAMDISK file, FLASHDISK file, User Port, or a serial communications channel.	2-67
CONFIG	Establishes protocol between the LDO and User Port or a serial communications channel. Must execute after OPEN and before READ, WRITE, or STATUS.	2-71
DELFIL	Deletes files from the PiC900 RAMDISK or PiCPro.	2-87
DIRECT	Reads PiC RAMDISK or FLASHDISK directory information.	2-91
FRESPACE	Checks amount of available disk space there is on the PiC RAMDISK or FLASHDISK.	2-133
OPEN	Opens the communication channel between the LDO and a DOS file, RAMDISK file, FLASHDISK file, User Port, or a serial communications channel. Must execute before CONFIGURE, READ, WRITE, STATUS, or SEEK.	2-207
READ	Reads data from a DOS, RAMDISK, or FLASHDISK file, User Port, or a serial communications channel and places it into a STRING, Array, Structure, Array Element, or Structure member.	2-295
RENAME	Renames a file on the PiC RAMDISK or PiCPro.	2-359
SEEK	Positions a pointer in a RAMDISK or FLASHDISK file before a read/write is performed.	2-416
STATUS	Outputs the number of bytes in the input buffer of User Port or a serial communications channel.	2-428
WRITE	Writes data from a memory area to a DOS file, RAMDISK file, User Port, or a serial communications channel.	2-492



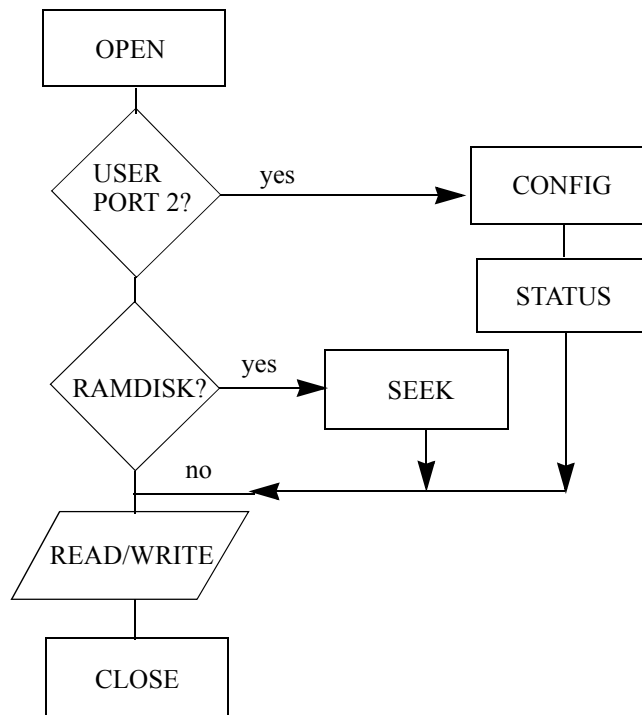

---

## JKTHERM group

The JKTHERM group contains functions that work with the JK thermocouple module.

Function	Description	Page
ATMPCHIT	Initializes a channel on a J-K thermocouple module.	2-26
ATMPCHRD	Reads or senses the temperature or voltage occurring at a channel on a J-K thermocouple module.	2-28
ATMPMDIT	Initializes Block I/O thermocouple or A/D channel.	2-30
BTMPCHIT	Initializes Block I/O thermocouple or A/D initialization.	2-47
BTMPCHRD	Reads or senses the temperature or A/D value.	2-48
BTMPMGR	Communicates with a J-K thermocouple Block I/O module.	2-50

## NETWORK group

The function blocks in the NETWORK group are used to perform communication operations among NEXNET networked PiC900s.

Function	Description	Page
NETCLS	Closes the communication channel between the PiC900 in which it is executed and all other networked PiC900s.	2-192
NETFRE	Used after data from a transaction has been received (NETRCV) to clear the input buffer.	2-192
NETMON	Monitors network activity for diagnostic purposes.	2-193
NETOPN	Opens the communication channel between the PiC900 in which it is executed and all other networked PiC900s.	2-194
NETRCV	Receives or reads data that was sent by another PiC900.	2-196
NETSND	Sends data to another PiC900 or all PiC900s in the network.	2-198
NETSTA	Tells how many bytes are in the input buffer to be received by one or more NETRCVs.	2-200

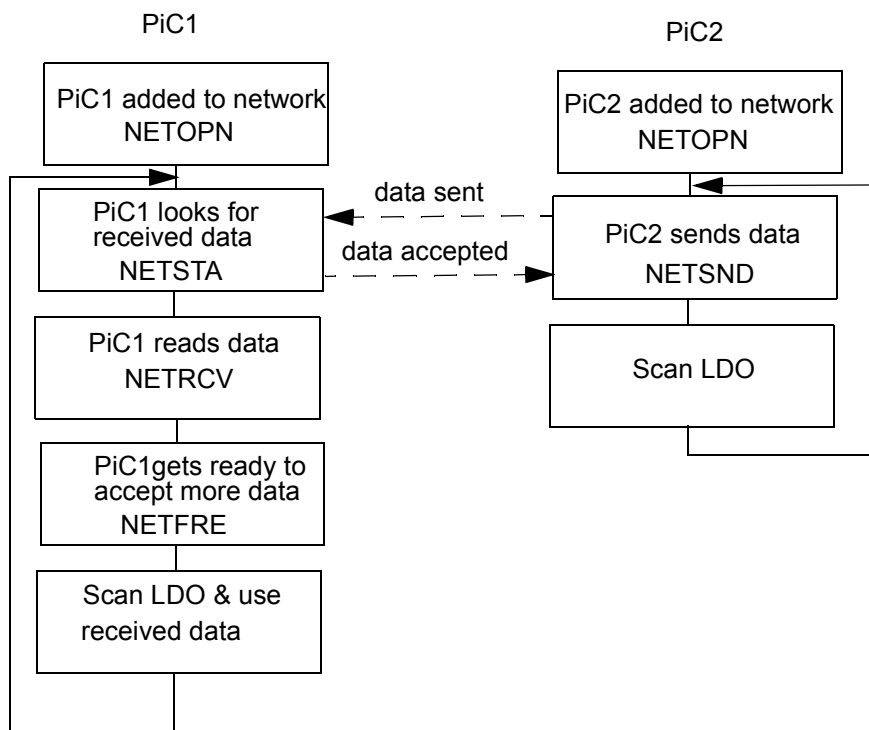

---

---

## **PID group**

The PID group has one function block that performs PID control.

<b>Function</b>	<b>Description</b>	<b>Page</b>
PID	Performs proportional, integral, and derivative control.	2-213

---

---

## **READFDBK group**

The READFDBK group has one function that reads an encoder or 12 channel resolver module on a scan time basis (background).

<b>Function</b>	<b>Description</b>	<b>Page</b>
READFDBK	Performs background read on encoder or 12 channel resolver module.	2-297

---

---

**RTDTEMP group**

The RTDTEMP group contains functions that work with the RTD module.

<b>Function</b>	<b>Description</b>	<b>Page</b>
ARTDCHIT	Initializes a channel on a RTD module.	2-17
ARTDCHRD	Reads or senses the temperature occurring at a channel on a RTD module.	2-19
ARTDMDIT	Initializes a RTD module.	2-21

## **SOCKETS group**

The socket function blocks are used to communicate from application to application using G&L Motion Control's implementation of the BSD socket interface.

---

<b>Function</b>	<b>Description</b>	<b>Page</b>
IPACCEPT	Used by the TCP server to accept incoming connect requests.	2-148
IPCLOSE	Used by an application to terminate a communication session for the socket specified at HNDL.	2-149
IPCONN	Used by a client application to connect to a remote server by specifying the remote endpoint address for a socket.	2-150
IPHOSTID	Optional and not required to be used.	2-151
IPIP2NAM	Allows the application to obtain the host name when you supply the IP address.	2-152
IPLISTEN	Used to make a socket passive.	2-153
IPNAM2IP	Allows the application to obtain an IP address when you supply the host name.	2-154
IPREAD	Allows you to read input data sent between a client function and a remote server.	2-155
IPRECV	Used to get a packet of data sent between a client function and a remote server.	2-156
IPSEND	Used to send data between client function and remote servers.	2-158
IPSOCK	Used to obtain a data structure and assign it to a specific communication resource.	2-159
IPSTAT	Called on a periodic basis with the RES input not energized whenever it is desired to know the status of the resources provided by the Windows NT operating system.	2-160
IPWRITE	Used to send data between client function and remote servers.	2-161

## STEPPER group

The STEPPER group contains functions that work with the stepper module.

Function	Description	Page
STEPCNTL	Sends a control word to the stepper motion control module (SMCM).	2-431
STEPINIT	Initializes an axis as a stepper axis.	2-435
STEPSTAT	Reads the data on the status of the stepper axis.	2-437
STEP_CMD	Sends a profile command and its related data to the command queue of the SMCM to run a step profile.	2-440
STEP_POS	Reads the position of a stepper axis.	2-450

## Motion Category

---

The motion functions are available with PiCServoPro. They allow you to perform motion control tasks.

In addition to the standard motion functions, there are two servo functions made by you with the Servo setup program and the PiC Profile program. Refer to those chapters for additional information.

### IMPORTANT

For parameters in these functions such as feedrates, accelerations, decelerations, position, distance, etc., you must enter ladder units (LU). Ladder units were defined by you for your application in the scaling data section of setup.

When you have ladder units equal to feedback units (FU) in setup, then you are entering feedback units in the ladder.

Often a range of values in FU is listed with function inputs. (See individual functions in Chapter 2.) If ladder units  $\neq$  to feedback units, be sure to convert LU to FU to check that you are in range.

---



---

**DATA group**

The data functions allow you to read, write, or check the status of certain variables and characteristics.

<b>Function</b>	<b>Description</b>	<b>Page</b>
CAPTINIT	Initializes what data is to be captured each servo interrupt and where it is to be stored.	2-59
CAPTSTAT	Provides the ability to start and stop the capturing of data from the ladder.	2-65
COORD2RL	Calculates profile segments used for circular/linear interpolation. Used with the RATIO_RL function.	2-74
FU2LU	Converts feedback units to ladder units.	2-134
LU2FU	Converts ladder units to feedback units.	2-181
DLS_INIT	Starts and monitors DLS communications	2-95
DLS_RECV	Reads most recent send data from MMC for PC	2-97
DLS_SEND	Indicates value of DATA	2-98
DLS_STAT	Indicates bit array and communication errors	2-99
READ_SV (read servo)	Allows you to read variables in your ladder. See the READ_SV function description for a list of variables.	2-308
READ_SVF (read servo fast)	Allows you to read any of the READ_SV variables faster. All values that involve velocity or distance are in feedback units and updates rather than ladder units and minutes.	2-346
SCA_CTRL	Writes control bits to the MDT for a servo axis.	2-373
SCA_RCYC	Reads cyclic data from the AT for a servo axis.	2-379
SCA_RECV	Allows you to receive information from the service channel section of SERCOS communication for a servo axis.	2-381
SCA_SEND	Allows you to send information to the service channel section of SERCOS communication for a servo axis.	2-388
SCA_STAT	Monitors the ready-to-operate drive mode, diagnostic troubleshooting, or two real-time status bits returned from the drive.	2-390
SCA_WCYC	Writes cyclic data to the MDT for a servo axis.	2-391
STATUSSV (status servo)	Allows you to check the status of the following characteristics from the word output of the STATUSSV function:  <ul style="list-style-type: none"> <li>move started</li> <li>fast input occurred</li> <li>fast input on</li> <li>good mark detected</li> <li>bad mark detected</li> <li>DIST + TOLR exceeded</li> <li>fast input rising</li> </ul>	2-429
TUNEREAD	Provides the ability to read tuning parameters from the ladder. (See TUNEWRIT for list of parameters.)	2-470



TUNEWRT	<p>Provides the ability to write the following tuning parameters from the ladder.</p> <ul style="list-style-type: none"> <li>Proportional Gain</li> <li>Integral Gain</li> <li>Derivative Gain</li> <li>Offset</li> <li>Slow Speed Filter</li> <li>Feed Forward Percent</li> </ul>	2-471
WRITE_SV (write servo)	<p>Allows you to write the following variables from your ladder:</p> <ul style="list-style-type: none"> <li>1 actual position (Time axis only)</li> <li>6 command velocity (Time axis only)</li> <li>11 consecutive bad marks</li> <li>12 rollover on position</li> <li>13 slave offset incremental</li> <li>14 master offset incremental</li> <li>15 slave offset absolute</li> <li>16 master offset absolute</li> <li>17 slave offset filter</li> <li>18 master offset filter</li> <li>19 fast input direction</li> <li>21 reversal not allowed</li> <li>23 position (SW) w fast in</li> <li>24 registration switch</li> <li>25 fast queuing</li> <li>26 synchronized slave start</li> <li>27 backlash compensation</li> <li>28 TTL feedback</li> <li>30 filter time constant</li> <li>31 filter error limit</li> <li>32 velocity compensation flag</li> <li>34 position change over several interrupts</li> <li>36 software upper limit</li> <li>37 software lower limit</li> <li>39 following error limit</li> <li>40 in-position band</li> <li>44 set iteration command</li> <li>45 user iteration command</li> <li>46 set PID command</li> <li>47 user PID command</li> <li>48 Disable servo software</li> <li>50 Override endlimit check</li> </ul>	2-493
WRIT_SVF (write servo fast)	<p>Allows you to write any of the WRITE_SV variables faster. All values that involve velocity or distance are in feedback units and updates rather than ladder units and minutes.</p>	2-494

---

---

## **ERRORS group**

There are three types of errors that affect an axis as described below.

**1.** C-stop (controlled-stop) errors

When a C-stop occurs, the following happens:

- The axis remains in servo lock and the axis is brought to a controlled stop at the rate specified by the controlled stop ramp in setup.
- The active and next queues are cleared.
- The FAST\_QUE mode is canceled when the C-stop is reset.

**2.** E-stop (Emergency-stop) errors

When an E-stop occurs, the following happens:

- The system is out of servo lock.
- zero voltage is sent to the analog outputs.
- The active and next queues are cleared.
- The FAST\_QUE mode is canceled when the E-stop is reset.
- If it is a loss of feedback E-stop error, then the machine reference must be redone.

In most respects, you are in a condition immediately following initialization with the exception of the queue number. The queue number does not start over but continues from where it left off when the E-stop occurred.

Remember that the queue number is assigned by the software from 1 to 255. When 255 is reached, it rolls over to 1.

**3.** Programming errors

These errors occur during master/slave moves or a FAST\_QUE call. They may prevent the move from being placed in the queue (or if the move is in the queue, abort the move) or they may prevent the OK on the function from being set.

There is a fourth type of error connected to the entire system called a timing error. It is monitored by the TME\_ERR? function.

**4.** Timing error

All the servo calculations for one interrupt must be completed in the time frame selected by you in setup before the next interrupt can perform its calculations. If they are not, this timing error occurs and the ERR output of the TME\_ERR? function is set.

<b>IMPORTANT</b>
Always set an E-stop on all axes when a timing error occurs.

<b>NOTE</b>
The C-stop, E-stop, and Programming errors can all be viewed in the tune section of the Servo setup program. See Appendix C in the PiCPro Online Help for more information.

<b>Function</b>	<b>Description</b>	<b>Page</b>
C_STOP (controlled stop)	Sets a controlled stop on the axis.	2-83
C_ERRORS (controlled stop errors)	Indicates what C-errors have occurred at the word output.	2-81
C_RESET (controlled stop reset)	Resets a C-stop error.	2-83
C_STOP? (controlled stop?)	Asks if there is a C-stop in effect for designated axis.	2-84
E_STOP (emergency stop)	Sets an emergency stop on the axis.	2-115
E_ERRORS (emergency stop errors)	Indicates what E_errors have occurred at the word output.	2-113
E_RESET (emergency stop reset)	Resets an E-stop error.	2-115
E_STOP? (emergency stop?)	Asks if there is an E-stop in effect for designated axis.	2-116
P_ERRORS (programming errors)	Indicates what programming errors have occurred at the word output.	2-233
P_RESET (programming error reset)	Resets a programming error.	2-236
RESMODE? (axis in resume mode?)	Asks if the axis is in Resume Mode.	2-363
RESUME (resume to normal interpolator path)	Commands the axis to move back to the Normal Interpolator's command position at velocity specified by RATE after Resumable E-Stop.	2-364
SCA_ERST	Resets internal E-errors for a SERCOS system.	2-376
TME_ERR? (timing error)	Asks if the time required to carry out the servo calculations exceeds the allotted interrupt time.	2-466

---

---

**INIT group**

The functions in the INIT group allow you to initialize the servos and be ready for motion commands from the ladder.

<b>Function</b>	<b>Description</b>	<b>Page</b>
CLOSLOOP (close loop)	Closes the position loop for the designated axis.	2-68
CLSLOOP? (close loop?)	Asks if the position loop for the designated axis is closed.	2-69
DRSETFLT	Commands the digital drive, specified by the AXIS input, to reset the drive faults. Only applicable to an MMCD system.	2-101
DSTRTSRV	Initializes the axes of an MMCD system.	2-102
OPENLOOP (open loop)	Opens the position loop for the designated axis.	2-209
SCA_CLOS	Closes the position loop in a SERCOS system.	2-372
STRTSERV (start servo)	Used with the user-defined setup function to initialize setup data.	2-453

## MOVE group

The functions in the MOVE group cause motion to begin or end. The moves are not master/slave moves.

The other functions that can cause motion are found in the RATIOMOV and REF groups. They are the master/slave moves and the fast input (FAST\_REF) and ladder (LAD\_REF) reference functions used to perform a machine reference.

Function	Description	Page
DISTANCE (distance)	Moves an axis a specified distance at a specified feedrate.	2-93
DPOSMODE (digital drive position mode)	Switches the digital drive to Position Mode.	2-100
DTORQCMD (digital drive torque mode command)	Issues a command current to a digital drive in Torque Mode.	2-105
DVELCMD (digital drive velocity mode command)	Issues a command velocity to a digital drive in Velocity Mode.	2-106
POSITION (position)	Moves an axis at a specified feedrate to an endpoint.	2-232
VEL_STRT (velocity start)	Moves an axis at a specified feedrate and direction.	2-487
VEL_END (velocity end)	Ends a velocity start move.	2-486

## MOVE\_SUP group

The functions in the MOVE\_SUP group allow you to make adjustments to the moves.

Function	Description	Page
ACC_DEC (acceleration/ deceleration)	Allows you to change the acc/dec rates entered in setup from the ladder.	2-4
CAM_OUT (cam output)	Allows you to turn on discrete I/O points for a specified distance during the rollover on position cycle.	2-55
HOLD (feedhold)	Stops the iteration of the current move.	2-138
HOLD_END (feedhold end)	Resumes the move that was halted with the HOLD function.	2-139
IN_POS? (in position?)	Asks the question “Is the active move in position?”	2-143
MEASURE (measure)	Enables the fast input response when not using registration or referencing.	2-185
NEWRATIO	Allows you to change the ratio of a RATIO_GR or RATIOSYN move or the default ratio of the RATIOSLP move.	2-201
NEW_RATE (new feedrate)	Allows you to change the feedrate of the moves in the active queue.	2-203
PLS	Used to turn on a discrete output for specified ranges of axis positions.	2-227
PLS_EDIT	Used to edit an ON/OFF pair of values used by a PLS function while PLS is active.	2-231
RATIOSCL	Allows you to scale the slave and/or master axis in RATIOCAM, RATIOSLP, and the master axis in RATIO_RL moves.	2-257
REGIST (registration)	Sets the axis position to a defined value when a fast input occurs.	2-350
R_PERCEN (feedrate percent)	Allows you to change the feedrate by a percentage for all moves connected to an axis.	2-369
SCA_PBIT	Initializes the SERCOS fast input.	2-377
SCURVE	Allows a master time axis to follow an s-curve velocity profile minimizing the amount of jerk that can occur in a trapezoidal velocity profile.	2-411
VFASTIN (virtual fast input)	Allows you to generate a virtual fast input for a virtual axis.	2-488

## QUE group

There are two queues used by the servo software to manage moves for an axis. One is the active queue which holds the move that is currently active. The other is the next queue which is the move that is ready and waiting to proceed when the active queue move is completed. The functions in this group affect the moves in the queues.

The servo software assigns a queue number to any motion function which has a QUE output. The numbers are assigned sequentially from 1 to 255. When 255 is reached, the number rolls over to 1.

Function	Description	Page
ABRTMOVE (abort move)	Aborts the move identified by the number entered in its QUE input.	2-2
ABRTALL (abort all)	Aborts the moves in both queues.	2-2
FAST_QUE (fast input queue)	Manages the queues based on the occurrence of a fast input.	2-117
Q_NUMBER (queue number)	Gives the number of the move that is in the active queue.	2-239
Q_AVAIL? (queue available?)	Asks the question “Is a queue available for the specified axis?”	2-238

## RATIOMOV group

The functions in this group cause motion to begin or end. They involve master/slave ratio moves. The RATIOPRO function requires another function (or functions) made by you with the PiC Profile program that defines the ratio profile you want to use.

**NOTE:** The RATIOPRO function can be used in PiCPro but it can only be edited in PiCPro for DOS. The profile editor is not included in PiCPro.

The other functions that can cause motion are found in the MOVE and REF group.

Function	Description	Page
GR_END (gear end)	Ends a ratio gear (or ratio syn) move.	2-137
RATIOCAM (ratio cam profile)	A master/slave move where each segment of the profile has a constant ratio.	2-241
RATIOPRO (ratio profile)	A master/slave move where the slave axis will follow the master axis at a varied ratio and a positional relationship is established.	2-251
RATIOSLP (ratio slope)	A master/slave move where the ratio in each segment of the profile can vary linearly.	2-261
RATIOSYN (ratio synchronization)	A master/slave move where the slave axis will follow the master axis at a constant ratio and a positional relationship between the master and slave axes is established.	2-273
RATIO_GR (ratio gear)	A master/slave move where the slave axis will follow the master axis at a constant ratio.	2-283
RATIO_RL (ratio real)	A master/slave move where the slave axis will follow the master axis in a profile that can be a trigonometric function or a polynomial using floating point variables.	2-286
REP_END (repeat end)	Ends profiles set up to repeat in the RATIOPRO function.	2-362
SYN_END (synchronization end)	Ends a ratio syn (or ratio gear) move by specifying a drop point for the slave axis.	2-457



---



---

## REF group

The functions in the reference group allow you to do machine or part referencing. A machine reference provides position information to the PiC900 with respect to the machine. It is a fixed dimensional reference used to establish a repeatable point of reference between servo initializations. The PiC900 bases its position calculations on this position information. Motion may occur when performing a machine reference.

A part reference is a floating dimensional reference. It establishes a position based on the location of a part, not the machine. No motion occurs when performing a part reference. The axis has been moved into position before the reference occurs.

Function	Description	Page
FAST_REF (fast input reference)	Performs a machine reference based on a fast input.	2-120
LAD_REF (ladder reference)	Performs a machine reference from the ladder.	2-167
PART_CLR (part reference clear)	Cancels the part reference dimension supplied by the PART_REF function.	2-211
PART_REF (part reference)	Performs a part reference on the designated axis.	2-212
REF_DNE? (reference done?)	Asks the question “Is the machine reference cycle complete?”	2-349
REF_END (ladder reference end)	Ends the ladder machine reference.	2-349
SCA_ACKR	Acknowledges the reference cycle for a servo SERCOS axis.	2-371
SCA_REF	Runs a reference cycle on a servo SERCOS axis.	2-383
SCA_RFIT	Initializes the fast input on a SERCOS drive and monitors the reference switch or index mark position.	2-385

---



---

**SERC\_SLV group**

The functions in the SERCOS slave group allow you to work with the SERCOS slave function/function blocks.

<b>Function</b>	<b>Description</b>	<b>Page</b>
SCS_ACKR (SERCOS slave acknowledge reference)	Acknowledges the SERCOS reference cycle.	2-402
SCS_CTRL (SERCOS slave control)	Controls the bits in the MDT control word.	2-398
SCS_RECV (SERCOS slave receive)	Receives information from the service channel section of the SERCOS communication.	2-400
SCS_REF (SERCOS slave refer- ence)	Runs a reference cycle on the SERCOS slave axis.	2-402
SCS_SEND (SERCOS slave send)	Sends information to the service channel section of the SERCOS communication.	2-404
SCS_STAT (SERCOS slave status)	Monitors the ready-to-operate drive mode, diagnostic troubleshooting, or two real-time data bits returned from the drive.	2-406

---



---

## SERC\_SYS group

The functions in the SERCOS system group allow you to work with SERCOS rings and to start the SERCOS system.

Function	Description	Page
SCR_CONT (SERCOS ring continue)	Allows you to continue through SERCOS phases if you have halted after phase 2 to send additional IDNs.	2-392
SCR_ERR (SERCOS ring error)	Identifies ring errors that can occur during the transfer of IDNs.	2-393
SCR_PHAS (SERCOS ring phase)	Identifies the current SERCOS phase.	2-396
SC_INIT (SERCOS start)	Copies the initialization data into all interface boards.	2-370

---

## String Category

The functions in this group operate on variables which have a STRING data type. Most of these functions return a STRING as an output. The variable assigned to receive this output STRING must be specified as an input variable - on the left side. Assigning the variable on the right side is optional, but if used, it must be the same variable as the input variable. This characteristic is unique to all functions which have a STRING as an output, including functions not in this group.

The output at OK will not energize and the output STRING will be null (have length zero) if an error occurs. A list of errors is in Appendix B of the PicPro Online Help.

Function	Description	Page
CONCAT	Concatenates 2 STRINGs.	2-70
DELETE	Deletes characters from a STRING.	2-86
FIND	Searches for a STRING within another STRING and if found, outputs its location.	2-132
INSERT	Inserts a STRING into another STRING.	2-140
LEFT	Places a specified number of characters from the left side of a STRING into a variable.	2-171
LEN	Returns the length of a STRING.	2-172

LWR_CASE	Converts all the characters in a string to lower case characters.	2-184
MID	Places a specified number of characters from the middle of a STRING into a variable.	2-186
REPLACE	Places a STRING within another STRING, replacing one or more characters.	2-361
RIGHT	Places a specified number of characters from the right side of a STRING into a variable.	2-366
UPR_CASE	Converts all the characters in a string to upper case characters.	2-483

## **PID Category**

---

<b>Function</b>	<b>Description</b>	<b>Page</b>
PID2	Simplified version of the PID function block.	2-222
PWDTY	Accepts input value and converts to duty cycle percentage.	2-237
RAMP	Generates ramp outputs from step inputs.	2-240
TAUFFAC	Calculates a first order filter for TAUFILT.	2-463
TAUFILT	Provides a first order filter response.	2-464

## **Timers Category**

---

The function blocks in the Timer library are used to energize and de-energize outputs (coils and control relays) after a duration of time. The time, as it elapses, can be viewed on the monitor with real time animation. The elapsed time value can be used (elsewhere) in the module but its value cannot be reset.

<b>Function Block</b>	<b>Description</b>	<b>Page</b>
TOF	De-energizes an output after a duration of time.	2-467
TON	Energizes an output after a duration of time.	2-468
TP	Energizes an output for a duration of time.	2-469

## **Xclock Category**

---

The two functions in the Xclock library are used for clock or calendar functions.

<b>Function</b>	<b>Description</b>	<b>Page</b>
CLOCK	Outputs from the PiC900 the current time and date, or sets the PiC900s time and date.	2-66
GETDAY	Outputs the number of the day of the week or day of the year.	2-136
SERVO-CLK	Allows a task to run on the servo clock when no servos are running.	2-419

**NOTES**

## Function/Block Descriptions

---

Chapter 2 describes all the functions available with PiCPro/PiCServoPro in alphabetical order. Each heading contains:

- The name of the function as it appears in PiCPro
- The title of the function (underneath the name)
- The name of the function menu group (in right-hand corner) to which each function belongs.

Below the heading is an illustration of each function. To the right are listed the inputs and outputs for the function with data types in parentheses. The description of each function is beneath this information.

### PROGRAMMING NOTE

Functions with an EN input are usually enabled either by a transitional (one-shot) contact if the function should execute one time *or* by logic that will hold the function on if it should execute every scan.

Typically, one-shot any function in the Motion library that affects or causes motion.

Also, one-shot any function that has a request (REQ) instead of an enable (EN) input. REQ inputs are found on function blocks. A function block may not complete its operation in one scan.

The EN or REQ inputs that are typically transitioned are labeled “Typically one-shot” and those that should always be transitioned are labeled “One-shot” in the descriptions that follow.

### NOTE

You must have a math coprocessor installed on your PiC900//90 CPU module to perform any functions involving any 64 bit registers, logarithmic, exponential, trigonometric, and floating point mathematical operations.

### NOTE ON ALPHABETICAL ORDER

When an underscore character ( `_` ) occurs within the name of a function, that function is placed *after* those without an underscore. For example, `RATIO_GR` will be found *after* `RATIOSYN`.

## ABRTALL

Abort All

Motion/QUE

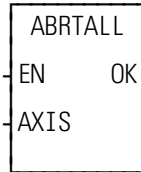

**Inputs:** EN (BOOL) - enables execution (**Typically one-shot**)  
 AXIS (USINT) - identifies axis (servo)  
**Outputs:** OK (BOOL) - execution completed without error

ABRTALL(AXIS := <<USINT>>, OK => <<BOOL>>)

The ABRTALL function aborts the moves in both queues for the specified axis.

It is also used to ensure that no move can begin unexpectedly when a programming error occurs with the FAST\_QUE function. See also the FAST\_QUE entry.

## ABRTMOVE

Abort Move

Motion/QUE

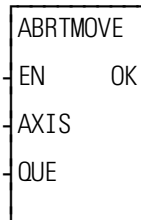

**Inputs:** EN (BOOL) - enables execution (**Typically one-shot**)  
 AXIS (USINT) - identifies axis (servo)  
 QUE (USINT) - number of move to abort from queue  
**Outputs:** OK (BOOL) - execution completed without error

ABRTMOVE(AXIS := <<USINT>>, QUE := <<USINT>>, OK => <<BOOL>>)

The ABRTMOVE function aborts the move identified by the number at QUE.

If the move to be aborted is in the active queue, it will be removed freeing that queue for another move. If there is a move in the next queue, it will begin executing immediately. If there is no move in the next queue, the axis will decel to a stop at the rate specified in servo setup. If the move to be aborted is in the next queue, it will be removed freeing that queue for another move. If the move is not in either queue, it cannot be aborted.

### IMPORTANT

When aborting a move, it is important to note that the aborted move is abandoned at the point it is at and the next move is entered immediately. This is different than ending a move such as velocity start (VEL\_STRT) with a velocity end (VEL\_END) as illustrated in Comparing velocity end and abort move functions



**Figure 2-1. Comparing velocity end and abort move functions**

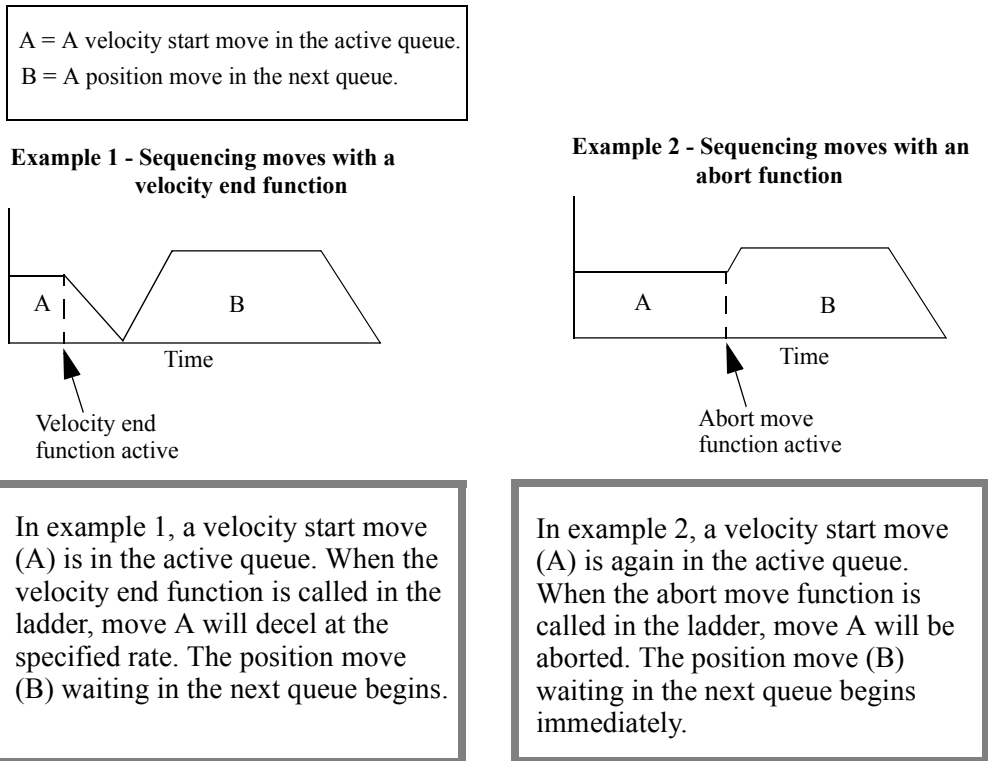

---



---

## ABS

*Absolute Value*

**Arith/ARITH**

---



---

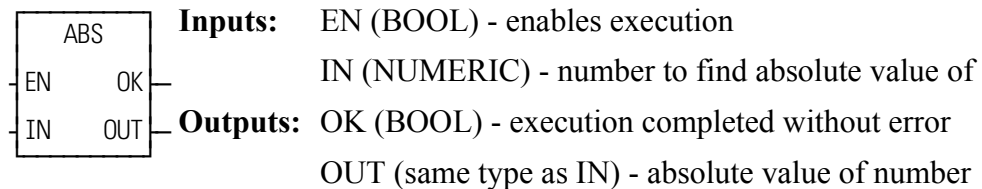

ABS(IN := <<NUMERIC>>, OK => <<BOOL>>, OUT => <<NUMERIC>>)

The ABS function places the absolute value (non-negative value) of the variable or constant at IN into the variable at OUT. For example,

If IN = -5, then OUT = 5

If IN = 10, then OUT = 10

The absolute value  $|x|$  of a number, x, is:

$$|x| = x \quad \text{if } x \geq 0$$

$$|x| = -x \quad \text{if } x < 0$$

**ACC\_DEC**

Acceleration/Deceleration

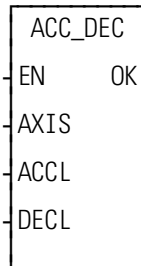
**Motion/MOVE\_SUP**

**Inputs:** EN (BOOL) - enables execution (**Typically one-shot**)  
 AXIS (USINT) - identifies axis (servo)  
 ACCL (UDINT) - acceleration rate for axis (entered in LU/MIN/SEC)  
 DECL (UDINT) - deceleration rate for axis (entered in LU/MIN/SEC)

**Outputs:** OK (BOOL) - execution complete

ACC\_DEC(AXIS := <<USINT>>, ACCL := <<UDINT>>, DECL := <<UDINT>>, OK => <<BOOL>>)

The ACC\_DEC function allows the acc/dec rates for the specified axis to be changed. When used in your ladder program, the acc/dec values in this function override those entered in setup. If the STRTSERV function is called again reinitializing the servo data, then the system will default to the setup values.

This function does not affect the move in progress. It only applies to moves that have not been queued.

**IMPORTANT**

If you are only changing one of the rates (acceleration or deceleration) and want to maintain the setup rate for the other, you *must* enter the setup value for the rate you do not want to change at the ACCL or DECL input of the function.

There are some limits on setting the acc/dec rates so that invalid data is not entered.

- The acc/dec rate is limited to 536,870,911 FU/iteration/iteration. If a larger number is entered, the default is 536,870,911 FU/iteration/iteration.
- The acc/dec rate cannot be set to 0. If a 0 is entered, the default is to 1 FU/iteration/iteration.
- The acc rate cannot be more than 10 times the dec rate. If this is attempted, the dec rate is increased to 1/10 the acc rate.
- The resolution of the internal conversion of LU/MIN/SEC is 1 FU/ITER/ITER. This resolution is adequate for most applications. However, if your application requires long accel or decel rates, you may notice some inaccuracies in the rates due to this resolution.

**ACC\_JERK**

Acceleration/Jerk

Motion/MOVE\_SUP

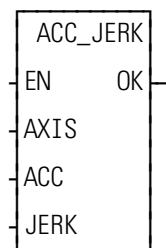

**Inputs:** EN (BOOL) - enables execution (**One-shot**)  
 AXIS (USINT) - the axis (servo or time axis)  
 ACC (LREAL) - the maximum acceleration rate in ladder units/min/sec for servo axis or feedback units/min/sec for time axis  
 JERK(LREAL) - the constant jerk in ladder units/min/sec<sup>2</sup> for servo axis or feedback units/min/sec<sup>2</sup> for time axis

**Outputs:** OK (BOOL) - execution complete without errors

ACC\_JERK(AXIS := <<USINT>>, ACC := <<LREAL>>, JERK := <<LREAL>>, OK => <<BOOL>>)

**NOTE:** A math coprocessor is required to use the ACC\_JERK function.

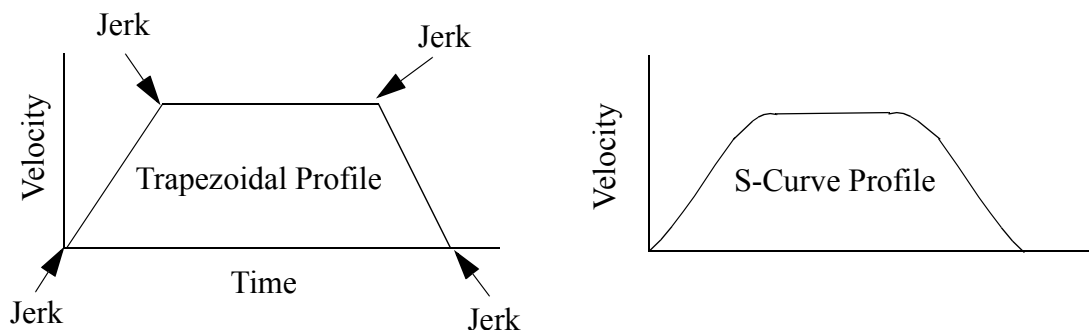

The ACC\_JERK function can be used with both Servo and Time axes. When used with Time axes, the function behaves the same as the SCURVE function, with the exception that the units for acceleration and jerk are different. See the SCURVE function for use of ACC\_JERK with time axes. The remainder of the information on ACC\_JERK refers to its use on a servo axis.

## ACC\_JERK

The ACC\_JERK function when used with Servo axes is used to modify the maximum acceleration and jerk values for that axis, from the values specified in Servo Setup. The ACC\_JERK function does not enable the “SCURVE” mode of acceleration and deceleration. There are separate rates of acceleration and jerk for acceleration/deceleration while performing programmed moves, and rates of acceleration and jerk for C-Stop deceleration. The ACC\_JERK function can only modify the rates for programmed moves.

The enabling of the “SCURVE” or “RAMP” mode of operation is performed in Servo Setup, or by writing to servo variable 60 with WRITE\_SV. Unless specified in Servo Setup, ‘RAMP’ acceleration/deceleration is the default mode of operation. The mode of operation may be changed with the WRITE\_SV function while an axis is in motion, but the change will not take affect until the next move in the queue is performed. C-Stop and Abort deceleration is always performed using the currently programmed mode of operation.

Once the ‘SCURVE’ mode of operation has been enabled, the DISTANCE, POSITION, and VEL\_STR/VEL\_END functions are used to move an axis utilizing the “SCURVE” acceleration/deceleration.

### Notes on Determining ACC and JERK Inputs

The following guidelines may help you determine the maximum acceleration [ACC input ( $A_m$ )] and the constant jerk [JERK input ( $J$ )] for your application. The two examples below present two ways to approach this.

#### Example 1

In the first example, assume that when going from 0 to maximum velocity ( $V_m$ ) the first third of the velocity change is spent in constant jerk, the second third is spent in constant acceleration, and the final third is spent in constant jerk as shown below.

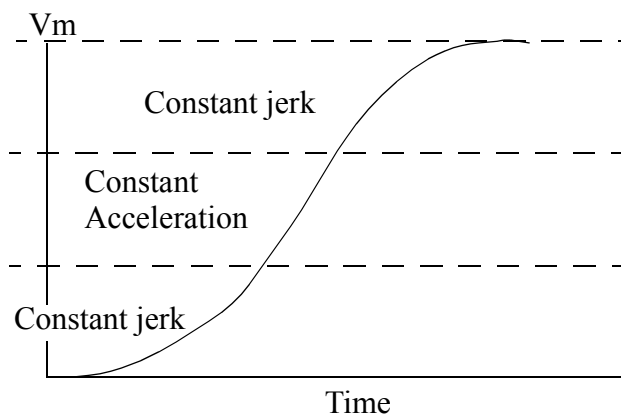

When this 1/3 relationship is true, the relationship between acceleration, jerk, velocity and time can be expressed as follows:

$$J = \frac{3}{2} \frac{Am^2}{Vm} \quad \text{and} \quad Am = \frac{5}{3} \frac{Vm}{time}$$

If you select an approximate time for acceleration from 0 to Vm (left column) and a value for the maximum velocity (top row), then the table provides the value for constant jerk (first line) and maximum acceleration (second line) in each row. Typically, you set the ACC and JERK inputs once based on the maximum your application can handle.

Time (sec)	Velocity (FU/min) 1x10 <sup>3</sup>	Velocity (FU/min) 1x10 <sup>4</sup>	Velocity (FU/min) 1x10 <sup>5</sup>	Velocity (FU/min) 1x10 <sup>6</sup>	Velocity (FU/min) 1x10 <sup>7</sup>	
<b>0.01</b>	4.2x10 <sup>7</sup> 1.7x10 <sup>5</sup>	4.2x10 <sup>8</sup> 1.7x10 <sup>6</sup>	4.2x10 <sup>9</sup> 1.7x10 <sup>7</sup>	4.2x10 <sup>10</sup> 1.7x10 <sup>8</sup>	4.2x10 <sup>11</sup> 1.7x10 <sup>9</sup>	JERK (LU/min/ sec <sup>2</sup> ) ACC (LU/min/ sec)
<b>0.1</b>	4.2x10 <sup>5</sup> 1.7x10 <sup>4</sup>	4.2x10 <sup>6</sup> 1.7x10 <sup>5</sup>	4.2x10 <sup>7</sup> 1.7x10 <sup>6</sup>	4.2x10 <sup>8</sup> 1.7x10 <sup>7</sup>	4.2x10 <sup>9</sup> 1.7x10 <sup>8</sup>	JERK (LU/min/ sec <sup>2</sup> ) ACC (LU/min/ sec)
<b>1</b>	4.2x10 <sup>3</sup> 1.7x10 <sup>3</sup>	4.2x10 <sup>4</sup> 1.7x10 <sup>4</sup>	4.2x10 <sup>5</sup> 1.7x10 <sup>5</sup>	4.2x10 <sup>6</sup> 1.7x10 <sup>6</sup>	4.2x10 <sup>7</sup> 1.7x10 <sup>7</sup>	JERK (LU/min/ sec <sup>2</sup> ) ACC (LU/min/ sec)
<b>10</b>	4.2x10 <sup>1</sup> 1.7x10 <sup>2</sup>	4.2x10 <sup>2</sup> 1.7x10 <sup>3</sup>	4.2x10 <sup>3</sup> 1.7x10 <sup>4</sup>	4.2x10 <sup>4</sup> 1.7x10 <sup>5</sup>	4.2x10 <sup>5</sup> 1.7x10 <sup>6</sup>	JERK (LU/min/ sec <sup>2</sup> ) ACC (LU/min/ sec)
<b>100</b>	4.2x10 <sup>-1</sup> 1.7x10 <sup>1</sup>	4.2x10 <sup>0</sup> 1.7x10 <sup>2</sup>	4.2x10 <sup>1</sup> 1.7x10 <sup>3</sup>	4.2x10 <sup>2</sup> 1.7x10 <sup>4</sup>	4.2x10 <sup>3</sup> 1.7x10 <sup>5</sup>	JERK (LU/min/ sec <sup>2</sup> ) ACC (LU/min/ sec)

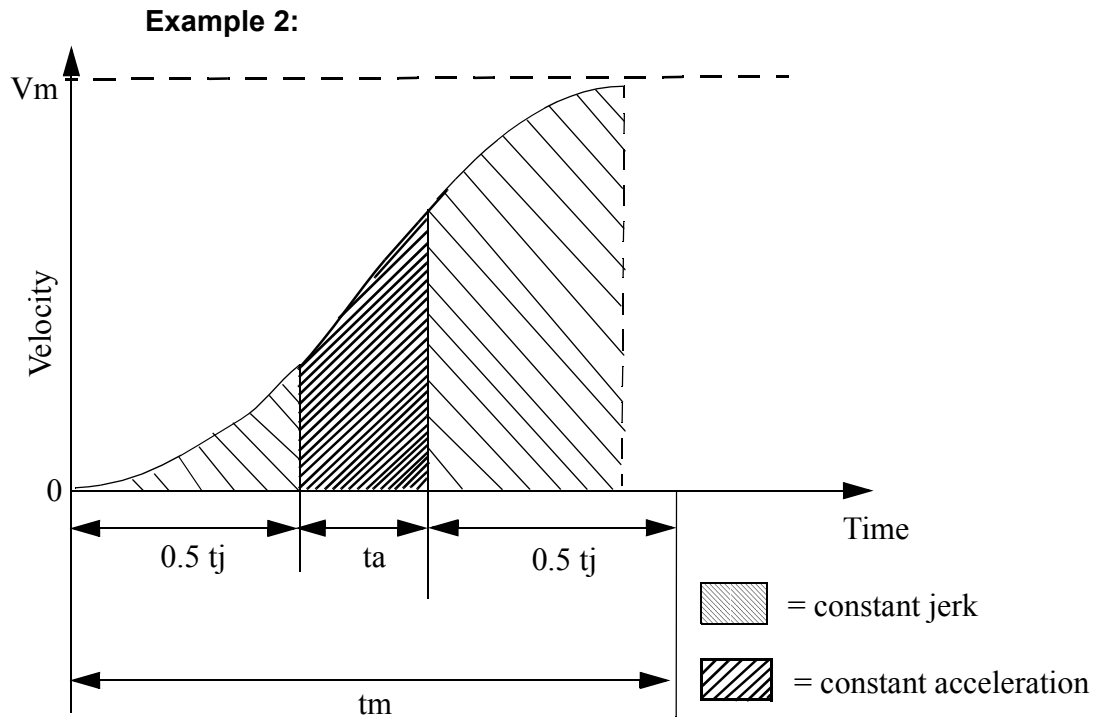

$V_m$  = Maximum velocity

$t_m$  = The total time to reach velocity  $V_m$  if the axis starts at 0

$t_j$  = The total constant jerk time

$t_a$  = The total constant acceleration time

$s$  = The fraction of time spent in constant jerk calculated by:

$$s = \frac{t_j}{t_m}$$

If you know  $V_m$ ,  $t_m$ , and  $s$ , then you can calculate jerk and acceleration using the following formulas.

$$JERK = \frac{2 \times V_m}{s \times t_m^2 (1 - 0.5 \times s)}$$

$$ACCL = \frac{V_m}{t_m (1 - 0.5 \times s)}$$

The units for JERK are ladder units per minute/second<sup>2</sup>; therefore,  $V_m$  is in ladder units per minute and  $t_m$  is in seconds. The units for ACCL are ladder units per second<sup>2</sup>.

**ACOS**

Arc Cosine

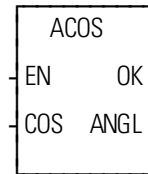
**Arith/TRIG****Inputs:** EN (BOOL) - enables execution

COS (REAL/LREAL) - cosine value

**Outputs:** OK (BOOL) - execution completed without error

ANGL (REAL/LREAL) - angle calculated (in radians)

NOTE: The data types entered at COS and ANGL must match, i.e. if COS is REAL, then ANGL must be REAL.

ACOS(COS := <<REAL/LREAL>>, OK => <<BOOL>>, ANGL => <<REAL/LREAL>>)

The ACOS function calculates the arc cosine of the cosine entered at COS. The result is the angle at ANGL.

**ADD**

Addition

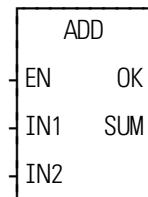
**Arith/ARITH****Inputs:** EN (BOOL) - enables execution

IN1 (NUMERIC or TIME duration) - addend

IN2 (same type as IN1) - addend

**Outputs:** OK (BOOL) - execution completed without error

SUM (same type as IN1) - sum of addends

ADD(IN1 := <<NUMERIC/TIME>>, IN2 := <<NUMERIC/TIME>>, OK => <<BOOL>>, SUM => <<NUMERIC/TIME>>)

The ADD function adds the value of the variable or constant at IN2 to the value of the variable or constant at IN1, and places the result in the variable at SUM. This is an extensible function that can add up to 17 numbers.

$$\begin{array}{r} X \\ + Y \\ \hline Z \end{array} \qquad \begin{array}{r} IN1 \\ + IN2 \\ \hline SUM \end{array}$$

**AND**

And

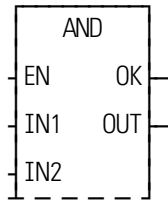
**Binary/AND****Inputs:** EN (BOOL) - enables execution

IN1 (BITWISE) - number to be ANDed

IN2 (same type as IN1) - number to be ANDed

**Outputs:** OK (BOOL) - execution completed without error

OUT (same type as IN1) - ANDed number

ADD(IN1 := <<BITWISE>>, IN2 := <<BITWISE>>, OK => <<BOOL>>, OUT => <<BITWISE>>)

The AND function ands the variable or constant at IN1 with the variable or constant at IN2, and places the results in the variable at OUT. This is an extensible function which can AND up to 17 inputs.

The AND function places a one in bit x of the output variable when bit x of all input variables (first variable and second variable and, etc.) equals 1. In all other cases (bit x of one or more operands equals 0), a 0 is placed in bit x of the output variable.

**Example of AND function (on three inputs)**

11000011	value at IN1
11111111	value at IN2
<u>10001111</u>	<u>value at IN3</u>
10000011	value at OUT



**ANLGINIT**

Analog Initialization

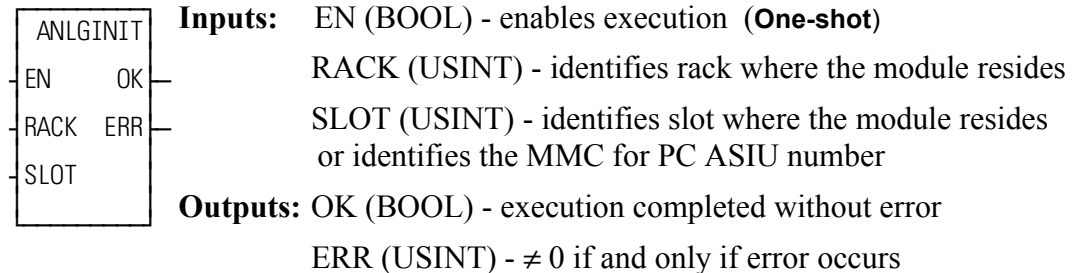
**I<sub>o</sub>/ANLGOUT**

ANLGINIT(RACK := <<USINT>>, SLOT := <<USINT>>, OK => <<BOOL>>, ERR => <<USINT>>)

The ANLGINIT function is used to initialize either a ±10 VDC output module, a 4-20 mA output module, a block 4-20 mA output module, or a block ±10 VDC output module.

The input value at RACK specifies the rack in which the module resides. For a standard analog output module, the master or CPU rack is #0. Expansion racks are numbered consecutively from one where # 1 is the rack connected to the master, #2 is the rack connected to # 1, etc.

For a block analog output module, RACK must be set to 100.

For the MMC, RACK must be set to 0.

For an MMC for PC analog output, RACK must be set to 200.

For the standard analog output module, the input value at SLOT (3 up to 13) specifies in which slot the module resides. Slots are numbered left to right when facing the PiC. Slot 1 is reserved for the CSM module. Slot 2 is reserved for either the CPU or I/O driver module.

For block analog output modules, the input value at SLOT (1 - 77) is set to 1 for the module connected to the PiC CPU, 2 for the module connected to module #1, 3 for the module connected to module #2, etc. For the MMC, SLOT must be set to 1. For the MMC-Plus, SLOT may be set to 1, 3, 4, 5, or 6. For an MMC for PC ASIU, the slot must be the ASIU number. The valid range is (1 - 8).

If an error occurs the output at OK is not energized; output at ERR equals 1 - 4:

ERR	Description
1	The input at RACK is out of range
2	The input at SLOT is out of range
3	Not used
4	The module at the location specified is not an analog output module or the MMC for PC ASIU does not exist

## ***ANLGINIT***

### **Output $\pm 10$ VDC Module**

If the channels on the output  $\pm 10$  VDC module will be used for open loop control only, then it is necessary to initialize the module with the ANLGINIT function. It is not necessary to enter a user-defined setup function containing all the setup data needed for closed loop control or input only axes.

If some of the channels are used for closed loop control or input only and some for output only, then the servo initialization procedure is followed and the ANLGINIT function is not used.

### **Output 4-20 mA Module**

The ANLGINIT function must always be called to initialize the 4-20mA module and the block 4-20 mA output module.

**ANLG\_OUT**

Analog Output

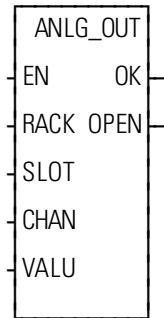
**IO/ANLGOUT**

**Inputs:** EN (BOOL) - enables execution  
 RACK (USINT) - identifies rack where the module resides  
 SLOT (USINT) - identifies slot where the module resides or identifies the MMC for PC number  
 CHAN (USINT) - identifies channel  
 VALU (INT) - output value (entered in output units as defined below)

**Outputs:** OK (BOOL) - execution completed without error  
 OPEN (BOOL) - set if the current loop is opened (applies to 4-20mA module only)

```
ANLG_OUT(RACK := <<USINT>>, SLOT := <<USINT>>, CHAN :=
  <<USINT>>, VALU := <<INT>>, OK => <<BOOL>>, OPEN => <<BOOL>>)
```

The ANLG\_OUT function identifies the rack and slot locations of the  $\pm 10$  VDC output module and the channel (1 - 8), the 4-20 mA output module and the channel (1 - 6), the block 4-20 mA output module and the channel (1 - 4), or the  $\pm 10$  VDC output block module to be used.

The input value at RACK specifies the rack in which the module resides. For a standard analog output module, the master or CPU rack is #0. Expansion racks are numbered consecutively from one where # 1 is the rack connected to the master, #2 is the rack connected to # 1, etc.

For block analog output modules, RACK must be set to 100.

For an MMC analog output, RACK must be set to 0.

For an MMC for PC analog output, RACK must be set to 200.

For the standard analog output module, the input value at SLOT (3 up to 13) specifies in which slot the module resides. Slots are numbered left to right when facing the PiC. Slot 1 is reserved for the CSM module. Slot 2 is reserved for either the CPU or I/O driver module.

## ANLG\_OUT

For block analog output modules, the input value at SLOT (1 - 77) is set to 1 for the module connected to the PiC CPU, 2 for the module connected to module #1, 3 for the module connected to module #2, etc.

For an MMC analog output, SLOT must be set to 1.

For the MMC-Plus, SLOT may be set to 1, 3, 4, 5, or 6.

For the MMC for PC ASIU, the SLOT must be the ASIU number. Valid range is (1-8).

The input value at CHAN (1 - 8 for the output  $\pm 10$  VDC module, 1 - 6 for the 4-20 mA module, and 1 - 4 for the block 4-20 mA module, the block input/output analog module, the MMC, and the MMC for PC ASIU) specifies the number of the channel to write.

### Output $\pm 10$ V DC Module

The analog output value at VALU is entered in  $\pm 10$  V DC output units according to the chart below:

<i>Enter</i>	<u><math>\pm 10</math> VDC output units</u>	<i>to get</i>	<u>Output volts</u>
	+32767		+11V
	+29790		+10V
	+14894		+5V
	0		0V
	-14894		-5V
	-29790		-10V
	-32767		-11V

There are 2979 output units per volt. Use this number to calculate the number of analog output units you need for any voltage not listed above between  $\pm 11$  volts.

The OPEN output is never set with an analog output module.

**MMC, MMC for PC ASIU, Block Output  $\pm 10$  VDC Module, and Block Input/Output Analog Module**

The analog output value at VALU is entered in  $\pm 10$  VDC output units according to the chart below:

<i>Enter</i>	<u><math>\pm 10</math>VDC output units</u>	<i>to get</i>	<u>Output volts</u>
	+32767		+10V
	+16384		+5V
	0		+0V
	-16384		-5V
	-32767		-10V

There are 3276.7 output units per volt. Use this number to calculate the number of analog output units you need for any voltage not listed above between  $\pm 10$  volts.

The OPEN output is never set with an analog output module.

**Output 4-20 mA Module**

The analog output value at VALU is entered in 4-20mA output units according to the chart below:

<i>Enter</i>	<u>4-20ma output units</u>	<i>to get</i>	<u>Output mA</u>
	+32767		+20mA
	+22527		+15mA
	+12288		+10mA
	0 to -32768		4mA

There are 2048 output units per mA. Use this number to calculate the number of output units you need for any current not listed above between 4 and 20 mA.

## ***ANLG\_OUT***

The OPEN output is set with a 4-20mA module whenever the current loop is opened. This will occur when the load impedance exceeds the resistance calculated as follows:

**For the Block 4-20 mA Output Module:**

$$\frac{V_{EXT} - 2.5V}{20mA} = R_{LOAD}$$

**For the 4-20 mA Module:**

$$\frac{V_{EXT} - 3.6V}{20mA} = R_{LOAD}$$

# ARTDCHIT

Analog RTD Channel Initialization

Io/RTDTEMP

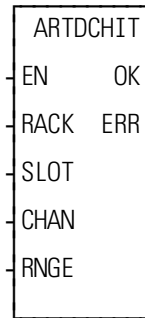

**Inputs:** EN (BOOL) - enables execution (**One-shot**)  
 RACK (USINT) - rack where module resides  
 SLOT (USINT) - slot where module resides  
 CHAN (USINT) - channel to initialize  
 RNGE (USINT) - temperature range

**Outputs:** OK (BOOL) - energized if and only if ERR = 0  
 ERR (USINT) - ≠ 0 if and only if error occurs

ARTDCHIT(RACK := <<USINT>>, SLOT := <<USINT>>, CHAN := <<USINT>>, RNGE := <<USINT>>, OK => <<BOOL>>, ERR => <<USINT>>)

The ARTDCHIT function initializes a channel on the analog input RTD (resistance temperature detector) module. It establishes the sensitivity of the channel.

The input value at RACK specifies the rack in which the module resides. The master or CPU rack is #0. Expansion racks are numbered consecutively from one where # 1 is the rack connected to the master, # 2 is the rack connected to # 1, etc.

The input value at SLOT (3 up to 13) specifies in which slot the module resides. Slots are numbered left to right when facing the PiC. Slot 1 is reserved for the CSM module. Slot 2 is reserved for either the CPU or I/O driver module.

The input value at CHAN (1 - 6) specifies the number of the channel to read.

The input at RNGE (1 - 3) specifies the temperature range at this channel.

Value to enter at RNGE	50 Ohm RTD	100 Ohm RTD
1	N/A	-200°C to 50°C (-328°F to 1562°F)
2	-200°C to 850°C (-328°F to 1562°F)	-200°C to 266°C (-328°F to 510.85°F)
3	-200 to 266°C (-328°F to 510.8°F)	-200°C to 0°C (-328°F to 32°F)

## **ARTDCHIT**

If an error occurs, the OK output will not be energized and the ERR output will return the error code. See Appendix C Temperature Function Errors for the list of error codes.

NOTE: This function works in conjunction with the ARTDMDIT and ARTDCHRD functions.

The ARTDCHIT function must be executed once (the input at EN should be a one-shot) after the ARTDMDIT function is executed, and before the ARTDCHRD function is executed.



**ARTDCHRD**

Analog RTD Channel Read

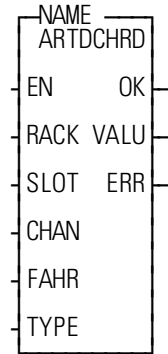
**Io/RTDTEMP**

**Inputs:** EN (BOOL) - enables execution  
 RACK (USINT) - rack where module resides  
 SLOT (USINT) - slot where module resides  
 CHAN (USINT) - channel to read  
 FAHR (BOOL) - Fahrenheit or Celsius  
 TYPE (USINT) - 50 Ohm or 100 Ohm RTD

**Outputs:** OK (BOOL) - energized if and only if ERR = 0  
 VALU (INT) - temperature  
 ERR (USINT) - ≠ 0 if and only if error occurs

```
<<INSTANCE NAME>>:ARTDCHRD(EN := <<BOOL>>, RACK :=
  <<USINT>>, SLOT := <<USINT>>, CHAN := <<USINT>>, FAHR :=
  <<BOOL>>, TYPE := <<USINT>>, OK => <<BOOL>>, VALU => <<INT>>,
  ERR => <<USINT>>);
```

The ARTDCHRD function block must be declared in the software declaration table. You assign a name (*NAME*) to it at that time. This function block outputs the temperature sensed at a channel of the RTD module.

The input value at RACK specifies the rack in which the module resides. The master or CPU rack is #0. Expansion racks are numbered consecutively from one where # 1 is the rack connected to the master, # 2 is the rack connected to # 1, etc.

The input value at SLOT (3 up to 13) specifies in which slot the module resides. Slots are numbered left to right when facing the PiC. Slot 1 is reserved for the CSM module. Slot 2 is reserved for either the CPU or I/O driver module.

The input value at CHAN (1 - 6) specifies the number of the channel to read.

The input at FAHR specifies degrees Fahrenheit if it is enabled. If it is not enabled then the output will be in degrees Celsius. ( $F = 1.8C + 32$ )

The input at TYPE (0 - 1) specifies the type of RTD you are using.

0 = 50 Ohm RTD

1 = 100 Ohm RTD

The output at VALU holds the temperature in the degrees \* 10 specified.

## **ARTDCHRD**

If an error occurs, the OK output will not be energized and the ERR output will return the error code. See Appendix C Temperature Function Errors for the list of error codes.

NOTE: Values outside the temperature limits (defined by ARTDCHIT) may be read but should not be used for control purposes.

NOTE: This function works in conjunction with the ARTDCHIT and ARTDMDIT functions.

The ARTDCHIT function must be executed once after the ARTDMDIT function is executed, and before the ARTDCHRD function block is executed.

**ARTDMDIT**

Analog RTD Module Initialization

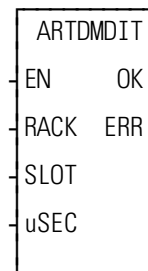
**Io/RTDTEMP****Inputs:** EN (BOOL) - enables execution (**One-shot**)

RACK (USINT) - rack where module resides

SLOT (USINT) - slot where module resides

μSEC (UINT) - frequency of read

**Outputs:** OK (BOOL) - energized if and only if ERR = 0

ERR (USINT) - ≠ 0 if and only if an error occurs

ARTDMDIT(RACK := <<USINT>>, SLOT := <<USINT>>, μSEC := <<UINT>>, OK => <<BOOL>>, ERR => <<USINT>>)

The ARTDMDIT function initializes an RTD module. It establishes the frequency at which the module reads its inputs.

The input value at RACK specifies the rack in which the module resides. The master or CPU rack is #0. Expansion racks are numbered consecutively from one where # 1 is the rack connected to the master, # 2 is the rack connected to # 1, etc.

The input value at SLOT (3 up to 13) specifies in which slot the module resides. Slots are numbered left to right when facing the PiC. Slot 1 is reserved for the CSM module. Slot 2 is reserved for either the CPU or I/O driver module.

The input at μSEC (2000 - 65535) specifies in microseconds how frequently the module samples the input (the sample frequency in hertz equals  $10^6/\mu\text{SEC}$ ).

If an error occurs, the OK output will not be energized and the ERR output will return the error code. See Appendix C Temperature Function Errors for the list of error codes.

NOTE: This function works in conjunction with the ARTDCHIT and ARTDCHRD functions.

The ARTDCHIT function must be executed once after the ARTDMDIT function is executed, and before the ARTDCHRD function block is executed.

---

---

**ASIN**

Arc Sine

**Arith/TRIG**

---

---

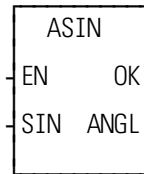

**Inputs:** EN (BOOL) - enables execution  
SIN (REAL/LREAL) - sine value

**Outputs:** OK (BOOL) - execution completed without error  
ANGL (REAL/LREAL) - angle calculated (in radians)

NOTE: The data types entered at SIN and ANGL must match, i.e. if SIN is REAL, then ANGL must be REAL.

ASIN(SIN := <<REAL/REAL>>, OK => <<BOOL>>, ANGL => <<REAL/LREAL>>)

The ASIN function calculates the arc sine of the sine entered at SIN. The result is the angle at ANGL.

**ASSIGN**

Assignment

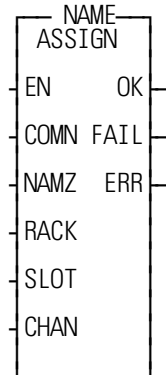
**I<sub>o</sub>/COMM**

**Inputs:** EN (BOOL) - enables execution (**Typically one-shot**)  
 COMN (STRUCT) - common to the ASSIGN function blocks. Used by the software to count the number of assignments made by the function block. The structure has one member with data type INT (the default).  
 NAMZ (STRING) - name of device  
 RACK (USINT) - master rack where serial communication module resides (0)  
 SLOT (USINT) - slot where module resides (3-13)  
 CHAN (USINT) - channel on the module (1-4)

**Outputs:** OK (BOOL) - execution complete  
 FAIL (BOOL) - energized if ERR= 1-7; deenergized if ERR = 0  
 ERR (INT) - 0 if no errors occur; 1-7 if an error occurs

```
<<INSTANCE NAME>>:ASSIGN(EN := <<BOOL>>, COMN := <<MEMORY AREA>>, NAMZ := <<STRING>>, RACK := <<USINT>>, SLOT := <<USINT>>, CHAN := <<USINT>>, OK => <<BOOL>>, FAIL => <<BOOL>>, ERR => <<INT>>);
```

The ASSIGN function block is designed to work with the two or four channel serial communications module. It assigns the name at the NAMZ input to a serial communication device at the location designated at RACK, SLOT, and CHAN.

The name you place in the string at NAMZ can have up to eight characters and is entered in the following format. For the example, the device is called Channel1.

**CHANNEL1:S00**

This name is then used at the NAMZ input of the OPEN function block to assign a handle to the device. The remaining I/O communication function blocks use this handle to identify the device.

## ASSIGN

The important note below provides a list of names that *cannot* be used at NAMZ input.

<b>IMPORTANT</b>
The following device names are reserved and may not be used in the ASSIGN function block at the NAMZ input. <b>USER, RAMDISK, ERR, AUXCOM, CO, PRN, PICPRO, FMDISK, AUX, MONCON, CI</b>

The input value at RACK (0) specifies the rack in which the module resides. The master or CPU rack is #0. The serial communications module is always located in the master rack.

The input value at SLOT (3 up to 13) specifies in which slot the module resides. Slots are numbered left to right when facing the PiC. Slot 1 is reserved for the CSM module. Slot 2 is reserved for either the CPU or I/O driver module.

The input value at CHAN (1 - 4) specifies the number of the channel on the module to read.

After the ASSIGN function block is called, each channel on the serial communications module functions like the USER port on the CPU module.

The COMN input is a structure declared in the software declarations table with one member (INT data type). This is used by the software to count the occurrences of the ASSIGN function block. If you exceed the number allowed by the serial communications module, an error will occur.

The errors that can occur at the ERR output are listed below.

<b>ERR</b>	<b>Description</b>
<b>0</b>	No error
<b>1</b>	Attempted to assign more than four devices
<b>2</b>	Name length either equals zero characters or has more than 10 characters including the two characters ":" and "\$00"
<b>3</b>	Device creation error, operating system could not create this device
<b>4</b>	Vector not initialized; the system EPROM does not support the ASSIGN function.
<b>5</b>	Hardware already assigned
<b>6</b>	Not enough channels; attempted to assign channel 3 or 4 to a two channel module.
<b>7</b>	No module at assigned location

---



---

## ATAN

Arc Tangent

Arith/TRIG

---



---

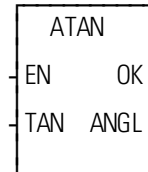

**Inputs:** EN (BOOL) - enables execution

TAN (REAL/LREAL) - tangent value

**Outputs:** OK (BOOL) - execution completed without error

ANGL (REAL/LREAL) - angle calculated (in radians)

NOTE: The data types entered at TAN and ANGL must match, i.e. if TAN is REAL, then ANGL must be REAL.

ATAN(TAN := <<REAL/LREAL>>, OK => <<BOOL>>, ANGL => <<REAL/LREAL>>)

The ATAN function calculates the arc tangent of the tangent entered at TAN. The result is the angle at ANGL. The range of ANGL is:

$$-\frac{\pi}{2} \leq ANGL \leq \frac{\pi}{2}$$

---



---

## ATMPCHIT

Analog Temperature Channel Initialization

Io/JK THERM

---



---

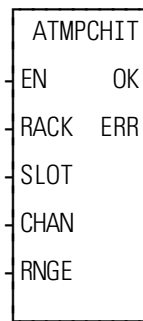

**Inputs:** EN (BOOL) - enables execution (**One-shot**)  
 RACK (USINT) - rack where module resides  
 SLOT (USINT) - slot where module resides  
 CHAN (USINT) - channel on the module  
 RNGE (USINT) - range of temperatures or channel sensitivity

**Outputs:** OK (BOOL) - energized if and only if ERR = 0  
 ERR (USINT) - ≠ 0 if and only if an error occurs

```
ATMPCHIT(RACK := <<USINT>>, SLOT := <<USINT>>, CHAN :=
    <<USINT>>, RNGE := <<USINT>>, OK => <<BOOL>>, ERR =>
    <<USINT>>)
```

The ATMPCHIT function initializes a channel on a J-K Thermocouple module. It establishes the sensitivity for the channel.

The input value at RACK specifies the rack in which the module resides. The master or CPU rack is #0. Expansion racks are numbered consecutively from one where # 1 is the rack connected to the master, # 2 is the rack connected to # 1, etc.

The input value at SLOT (3 up to 13) specifies in which slot the module resides. Slots are numbered left to right when facing the PiC. Slot 1 is reserved for the CSM module. Slot 2 is reserved for either the CPU or I/O driver module.

The input value at CHAN (1 -12) specifies the number of the channel to read.

The input at RNGE (1 - 4) specifies the temperature or voltage range that can be read (the following table also applies to the BTMPCHIT function block) where:

Value to enter	Range of values for J type thermocouple*	Range of values for K type thermocouple*
1	-10° C to 280° C 14° F to 536° F	-35° C to 415° C -31° F to 779° F
2	-35° C to 620° C -31° F to 1148° F	-80° C to 820° C -112° F to 1508° F
3	-150° C to 1200° C -238° F to 2192° F	-200° C to 1300° C -328° F to 2372° F
4	± 100 mV	



\*The temperature ranges apply over the temperature rating of the module. Temperature values outside the specified range should not be used for control purposes.

If an error occurs, the OK output will not be energized and the ERR output will return the error code. See Appendix C Temperature Function Errors for the list of ERR errors.

NOTE: This function works in conjunction with the ATMPMDIT and ATMPCHRD functions.

The ATMPCHIT function must be executed once (the input at EN should be a one-shot) after the ATMPMDIT function is executed, and before the ATMPCHRD function block is executed.

**ATMPCHRD**

Analog Temperature Channel Read

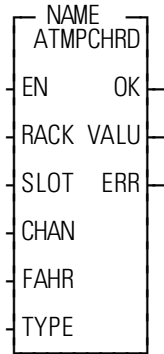
**Io/JK THERM**

**Inputs:** EN (BOOL) - enables execution  
 RACK (USINT) - rack where module resides  
 SLOT (USINT) - slot where module resides  
 CHAN (USINT) - channel on the module  
 FAHR (BOOL) - Fahrenheit or Celsius  
 TYPE (USINT) - type of thermocouple or mV

**Outputs:** OK (BOOL) - energized if and only if ERR = 0  
 VALU (INT) - temperature or digital value of mV  
 ERR (USINT) - ≠ 0 if and only if an error occurs

```
<<INSTANCE NAME>>:ATMPCHRD(EN := <<BOOL>>, RACK :=
  <<USINT>>, SLOT := <<USINT>>, CHAN := <<USINT>>, FAHR :=
  <<BOOL>>, TYPE := <<USINT>>, OK => <<BOOL>>, VALU => <<INT>>,
  ERR => <<USINT>>);
```

The ATMPCHRD function block must be declared in the software declaration table. You assign a name (*NAME*) to it at that time. This function block outputs the temperature or the voltage range sensed at a channel of the J-K Thermocouple module.

The input value at RACK specifies the rack in which the module resides. The master or CPU rack is #0. Expansion racks are numbered consecutively from one where # 1 is the rack connected to the master, # 2 is the rack connected to # 1, etc.

The input value at SLOT (3 up to 13) specifies in which slot the module resides. Slots are numbered left to right when facing the PiC. Slot 1 is reserved for the CSM module. Slot 2 is reserved for either the CPU or I/O driver module.

The input value at CHAN (1 - 12) specifies the channel to be sampled or read.

The input at FAHR specifies degrees Fahrenheit if it is enabled. If it is not enabled then the output will be in degrees Celsius. ( $F = 1.8C + 32$ )

The input at TYPE (0 - 2) specifies the type of thermocouple or specifies millivolts.

- 0 = J type
- 1 = K type
- 2 = mV

If J or K type has been selected, then the VALU output holds the temperature (in tenth of degrees) in either F or C.

If mV is selected, the VALU output holds the interpolated digital value (-2048 to 2047) of the analog signal (-100 to +100mV).

Counts at VALU	mV	
-2048	-100	The following formula can be used to calculate the mV (n) value from the counts at the VALU output.
.	.	$n = [VALU - (-2048)] \times \frac{[100 - (-100)]}{2047 - (-2048)} + (-100)$
.	.	For example, if the value at VALU was 1023 counts, then the mV are calculated as follows:
.	n	$n = [1023 + 2048] \times \frac{200}{4095} - 100$
.	.	or
.	.	$n = +49.98 \text{ mV}$
+2047	+100	

If an error occurs, the OK output will not be energized, the VALU output will be undefined and the ERR output will return the error code. See Appendix C Temperature Function Errors for the list of ERR errors.

NOTE: Values outside the temperature limits (defined by ATMPCHIT) can be read but should not be used for control purposes.

NOTE: This function works with the ATMPCHIT and ATMPMDIT functions.

The ATMPCHIT function must be executed once after the ATMPMDIT function is executed, and before the ATMPCHRD function block is executed.

---



---

## ATMPMDIT

Analog Temperature Module Initialization

Io/JK THERM

---



---

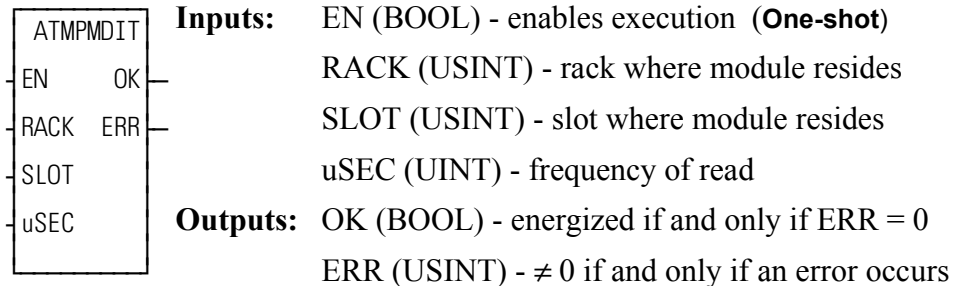

```
ATMPMDIT(RACK := <<USINT>>, SLOT := <<USINT>>, uSEC :=
  <<(UINT)>>, OK => <<BOOL>>, ERR => <<USINT>>)
```

The ATMPMDIT function initializes a J-K Thermocouple module. It establishes the frequency at which the module reads its inputs.

The input value at RACK specifies the rack in which the module resides. The master or CPU rack is #0. Expansion racks are numbered consecutively from one where # 1 is the rack connected to the master, # 2 is the rack connected to # 1, etc.

The input value at SLOT (3 up to 13) specifies in which slot the module resides. Slots are numbered left to right when facing the PiC. Slot 1 is reserved for the CSM module. Slot 2 is reserved for either the CPU or I/O driver module.

The input at uSEC (5000 - 65535) specifies in microseconds how frequently the module samples the input. (The sample frequency in hertz equals  $10^6/uSEC$ ).

If an error occurs, the OK output will not be energized and the ERR output will return the error code. See Appendix C Temperature Function Errors for the list of ERR errors.

NOTE: This function works in conjunction with the ATMPCHIT and ATMPCHRD functions.

The ATMPCHIT function must be executed once after the ATMPMDIT function is executed, and before the ATMPCHRD function block is executed.

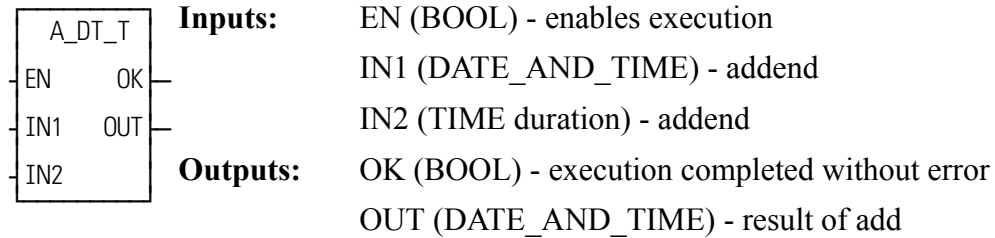
**A\_DT\_T***Add date and time to time***Arith/DATETIME**

A\_DT\_T(IN1 := <<DATE\_AND\_TIME>>, IN2 := <<TIME>>, OK =>  
 <<BOOL>>, OUT => <<DATE\_AND\_TIME>>)

The A\_DT\_T function adds the value of the constant or variable at IN1 to the value of the constant or variable at IN2. The result is a DATE\_AND\_TIME value that is put in the variable at OUT.

**Table 2-1. Examples of Add DATE\_and\_TIME to TIME**

Value at IN1	Value at IN2	Value at OUT
DT#1990-09-25-00:00:00	T#239s	DT#1990-09-25-00:03:59
DT#1991-07-04-14:14:23	T#23d10h22m	DT#1991-07-28-00:36:23

**A\_IN\_MMC**

Analog input for the MMC

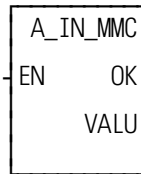
**Io/ANLGIN**

**Inputs:** EN (BOOL) - enables execution

**Outputs:** OK (BOOL) - execution completed

VALU (INT) - digital value of analog input

A\_IN\_MMC(OK => <<BOOL>>, VALU => <<INT>>)

NOTE: This function can only be used with the MMC, not a PiC CPU. The OK will not be set if a PiC CPU is selected.

The A\_IN\_MMC function outputs the digital value of an analog input for the MMC. The VALU output contains the counts of the analog input. You can convert these counts to a voltage value using the formula shown below.

Counts at VALU	V
+2047	+10
.	.
+1024	+5
.	.
0	0
.	.
-1024	+5
.	.
-2048	-10

The following formula can be used to calculate the voltage value from the counts at the VALU output.

$$Voltage = VALU \left( \frac{10V}{2048 Counts} \right)$$

**A\_INCHIT**

Analog Input Channel Initialize

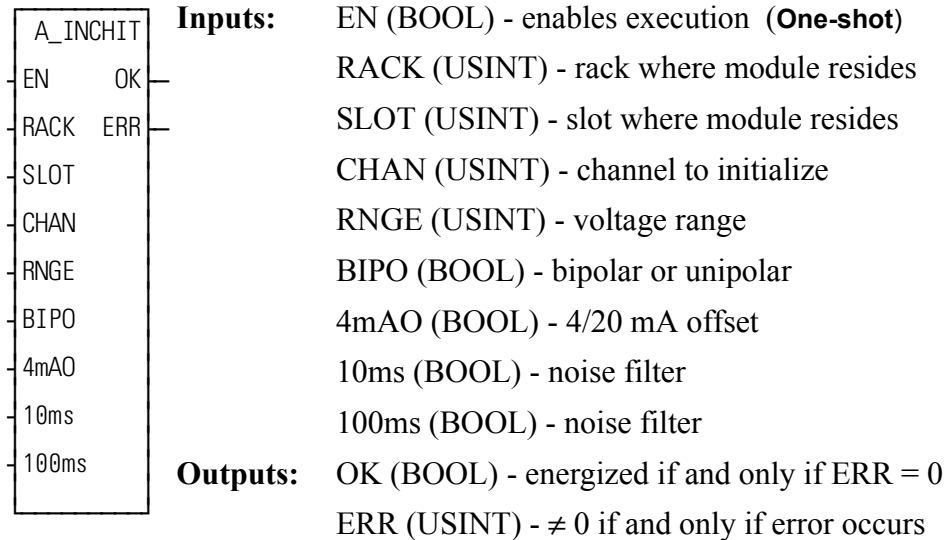
**Io/ANLGIN**

```
A_INCHIT(RACK := <<USINT>>, SLOT := <<USINT>>, CHAN :=
<<USINT>>, RNGE := <<USINT>>, BIPO := <<BOOL>>, 4mA O := BOOL,
10ms := <<BOOL>>, 100ms := <<BOOL>>, 100ms := <<BOOL>>, OK =>
<<BOOL>>, ERR => <<USINT>>)
```

The A\_INCHIT function initializes a channel on an analog input module. It establishes the range of voltage or current to be sampled and the amount of hardware filter to be applied.

This function is not required when using the MMC Analog Input, a MMC for PC ASIU analog input, or an analog input on a Block Input/Output Analog Module.

The input value at RACK specifies the rack in which the module resides. For a standard analog input module, the master or CPU rack is #0. Expansion racks are numbered consecutively from one where # 1 is the rack connected to the master, #2 is the rack connected to # 1, etc.

For a block analog input module, RACK must be set to 100.

For a standard analog input module, the input value at SLOT (3 up to 13) specifies in which slot the module resides. Slots are numbered left to right when facing the PiC. Slot 1 is reserved for the CSM module. Slot 2 is reserved for either the CPU or I/O driver module.

For block analog input modules, the input value at SLOT (1 - 77) is set to 1 for the module connected to the PiC CPU, 2 for the module connected to module #1, 3 for the module connected to module #2, etc.

The input value at CHAN (1 - 8 for the standard analog input module and 1 - 4 for the block analog input module) specifies the number of the channel to read.

The input at RNGE (1 - 8 for the standard analog input module and 1 - 2 for the block analog input module) specifies the input voltage range at this channel as shown below.

<b>Enter</b>	<b>Unipolar Range</b>	<b>Bipolar Range</b>
<b>1</b>	0 - 10V	-10 - 10V
<b>2</b>	0 - 5V	-5 - 5V
<b>3</b>	0 - 2.5V	-2.5 - 2.5V
<b>4</b>	0 - 1.25V	-1.25 - 1.25V
<b>5</b>	0 - 1V	-1 - 1V
<b>6</b>	0 - .5V	-.5 - .5V
<b>7</b>	0 - .25V	-.25 - .25V
<b>8</b>	0 - .125V	-.125 - .125V

The input at BIPO specifies bipolar if enabled. It specifies unipolar if it is not enabled.

The input at 4mA0 specifies that current is to be sampled. To read current (instead of voltage) it is required that:

1. A jumper be connected from the (-) input to the 250 ohm resistor input, as described in the Hardware Manual.
2. The input at RNGE equal 2 and the input at BIPO be a normally open contact that is never set.

The input at 4mA0 should have a wire or short connected to it for 4 to 20mA. The input at 4mA0 should not be enabled for 0 to 20 mA. These inputs are pictured below.

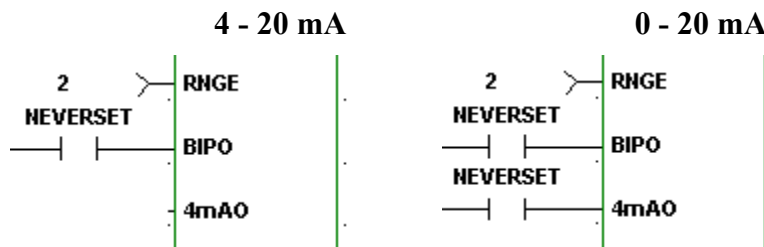

The inputs at 10ms and 100ms specify the amount of noise filter. If neither input is enabled then the default filter of 1 millisecond is applied. If the input at 10ms is enabled then a 10ms filter is applied. If the input at 100ms is enabled then a 100ms filter is applied. If both inputs are enabled then a 110ms filter is applied.



**Note:** The 10, 100, and 110 ms filters are not available for the block analog input modules.

If an error occurs the output at OK is not energized and the output at ERR equals 1 - 7:

<b>ERR</b>	<b>Description</b>
<b>1</b>	The input at RACK is out of range.
<b>2</b>	A rack hardware fault occurred.
<b>3</b>	The input at SLOT is out of range.
<b>4</b>	The module at the location specified is not an analog input module.
<b>5</b>	The input at CHAN is out of range.
<b>6</b>	There is a channel hardware fault.
<b>7</b>	The input at RANG is out of range.

**Note:** This function works in conjunction with the A\_INMDIT (module initialize) and A\_INCHRD (channel read) functions.

The A\_INMDIT and the A\_INCHIT functions must execute one time (the input at EN should be a one-shot), in either order, before the A\_INCHRD function block executes.

**A\_INCHRD**

Analog Input Channel Read

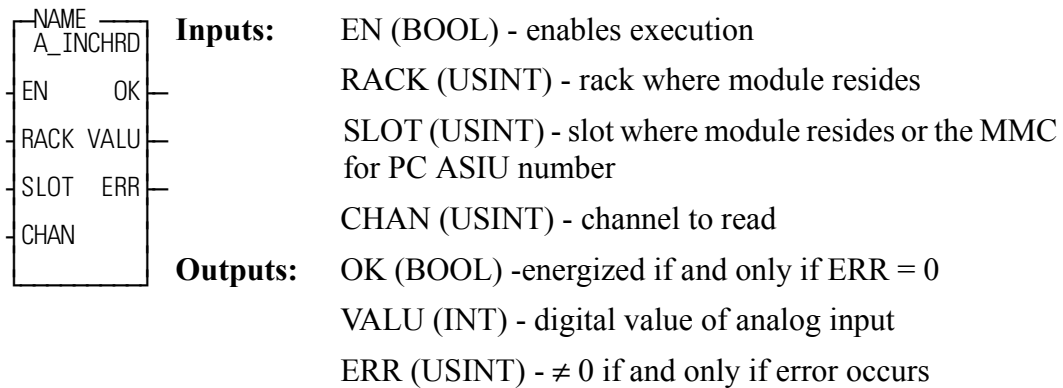
**Io/ANLGIN**

```
<<INSTANCE NAME>>:A_INCHRD(EN := <<BOOL>>, RACK :=
  <<USINT>>, SLOT := <<USINT>>, CHAN := <<USINT>>, OK =>
  <<BOOL>>, VALU => <<INT>>, ERR => <<USINT>>);
```

The A\_INCHRD function block outputs the digital value of an analog input to a channel on the analog input module.

The input value at RACK specifies the rack in which the module resides. For a standard analog input module, the master or CPU rack is #0. Expansion racks are numbered consecutively from one where # 1 is the rack connected to the master, #2 is the rack connected to # 1, etc.

For block analog input modules, RACK must be set to 100.

For the MMC analog input, RACK must be set to 0.

For an MMC for PC ASIU analog input, RACK must be set to 200.

For a standard analog input module, the input value at SLOT (3 up to 13) specifies in which slot the module resides. Slots are numbered left to right when facing the PiC. Slot 1 is reserved for the CSM module. Slot 2 is reserved for either the CPU or I/O driver module.

For block analog input modules, the input value at SLOT (1 - 77) is set to 1 for the module connected to the PiC CPU, 2 for the module connected to module #1, 3 for the module connected to module #2, etc.

For the MMC analog input, SLOT must be set to 1.

For an MMC-Plus analog input, SLOT may be set to 1, 3, 4, 5, or 6.

For the MMC for PC ASIU, SLOT must be the ASIU number. The valid range is (1 - 8).

The input value at CHAN (1 - 8 for a standard analog input module, 1 - 4 for block analog input modules, 1 for an MMC for PC and 1 for the MMC for PC ASIU) specifies the number of the channel to read.

The output at VALU holds the digital value of the signal occurring when this function block is enabled. The range of values is shown below:

Analog Input Module	Unipolar	Bipolar
12-bit resolution	0 to 4095	-2048 to 2047
14-bit resolution	0 to 16383	-8192 to 8191

This value is interpolated for the voltage or current range specified by the A\_INCHIT function.

**Note:** Analog inputs on the MMC and the MMC-Plus are -10V to +10V, 12-bit resolution, bipolar inputs. The MMC has 1 analog input. The MMC-Plus has 1 analog input per servo interface board.

**Note:** The analog input on the MMC for PC ASIU is a -10V to +10V, 12-bit resolution, bipolar input. There is 1 analog input per ASIU.

**Note:** Analog inputs on a Block Input/Output Analog Module are -10V to +10V, 14-bit resolution, bipolar inputs.

If an error occurs the output at OK is not energized and the output at ERR = 1 - 7.

ERR	Description
1	The input at RACK is out of range.
2	A rack hardware fault occurred.
3	The input at SLOT is out of range.
4	The module at the location specified is not an analog input module.
5	The input at CHAN is out of range.
6	Either there is a channel hardware problem, the module was not initialized, or the module is being continually initialized.
7	Initialization is not complete.

NOTE: This function works in conjunction with the A\_INMDIT (module initialize) and A\_INCHIT (channel initialize) functions.

The A\_INMDIT and A\_INCHIT functions must execute one time, in either order, before the A\_INCHRD function block executes (see the descriptions for A\_INMDIT and A\_INCHIT for cases in which these functions are not required).

## Examples

The information below will help you to calculate the device signal if you know the value at VALU or to calculate the VALU if you know the device signal.

Input Range	Resolution	Device Signal	VALU=
4-20mA	12 bits	$I = 16\text{mA} (\text{VALU}/4095) + 4\text{mA}$	$(I - 4\text{mA}) 4095/16\text{mA}$
4-20mA	14 bits	$I = 16\text{mA} (\text{VALU}/16383) + 4\text{mA}$	$(I - 4\text{mA}) 16383/16\text{mA}$
0-20mA	12 bits	$I = 20\text{mA} (\text{VALU}/4095)$	$I (4095/20\text{mA})$
0-20mA	14 bits	$I = 20\text{mA} (\text{VALU}/16383)$	$I (16383/20\text{mA})$
Any voltage	12 bits	$V = \text{Range}^* (\text{VALU}/4095)$	$V (4095/\text{Range}^*)$
range*	14 bits	$V = \text{Range}^* (\text{VALU}/16383)$	$V (16383/\text{Range}^*)$

\*The voltage ranges for unipolar and bipolar inputs are listed below.

Unipolar Input	Range	Bipolar Input	Range
0 to 10 V	10 V	-10 to 10 V	20V
0 to 5 V	5 V	-5 to 5 V	10 V
0 to 2.5 V	2.5 V	-2.5 to 2.5 V	5V
0 to 1.25 V	1.25 V	-1.25 to 1.25 V	2.5 V
0 to 1 V	1 V	-1 to 1 V	2 V
0 to 0.5 V	0.5 V	-0.5 to 0.5 V	1 V
0 to 0.25 V	0.25 V	-0.25 to 0.25	0.5 V
0 to 0.125 V	0.125 V	-0.125 to 0.125 V	0.25 V

For a 12-bit unipolar example, if the value at VALU was 2948 counts and the range is .125 (0 to .125), then the voltage is calculated as follows:

$$V = \frac{0.125 \times 2948}{4095} = 0.09V$$

For a 14-bit unipolar example, if the value at VALU was 11796 counts and the range is .125 (0 to .125), then the voltage is calculated as follows:

$$V = \frac{0.125 \times 11796}{16383} = 0.09V$$

For the 12-bit bipolar example, if the value at VALU was -1228 counts and the range is 10 (-5 to +5), then the voltage is calculated as follows:

$$V = \frac{10 \times -1228}{4095} = -3V$$

For the 14-bit bipolar example, if the value at VALU was -4915 counts and the range is 10 (-5 to +5), then the voltage is calculated as follows:

$$V = \frac{10 \times -4915}{16383} = -3V$$

For a 4-20 mA example, if the value at VALU was 2047 counts, then the current is calculated as follows:

$$I = 16mA(2047 \div 4095) + 4mA = 12mA$$

---



---

## A\_INMDIT

Analog Input Module Initialization

Io/ANLGIN

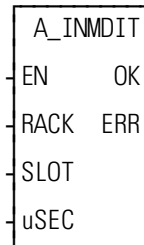

**Inputs:** EN (BOOL) - enables execution (**One-shot**)  
 RACK (USINT) - rack where module resides  
 SLOT (USINT) - slot where module resides  
 uSEC (UINT) - frequency of read

**Outputs:** OK (BOOL) - energized if and only if ERR = 0  
 ERR (USINT) - ≠ 0 if and only if an error occurs

```
A_INMDIT(RACK := <<USINT>>, SLOT := <<USINT>>, uSEC :=
  <<UINT>>, OK => <<BOOL>>, ERR => <<USINT>>)
```

The A\_INMDIT function initializes an analog input module when using a PiC CPU. It establishes how frequently the module samples or reads voltage or current input.

**Note:** This function is not required when using the MMC analog input, an MMC for PC ASIU analog input, or an analog input on a Block Input/Output Analog Module.

The input value at RACK specifies the rack in which the module resides. For a standard analog input module, the master or CPU rack is #0. Expansion racks are numbered consecutively from one where # 1 is the rack connected to the master, #2 is the rack connected to # 1, etc.

For a block analog input module, RACK must be set to 100.

For a standard analog input module, the input value at SLOT (3 up to 13) specifies in which slot the module resides. Slots are numbered left to right when facing the PiC. Slot 1 is reserved for the CSM module. Slot 2 is reserved for either the CPU or I/O driver module.

For block analog input modules, the input value at SLOT (1 - 77) is set to 1 for the module connected to the PiC CPU, 2 for the module connected to module #1, 3 for the module connected to module #2, etc.

The input at uSEC (800 - 65535) specifies in microseconds how frequently the module reads or samples the input. The sample frequency in hertz equals  $10^6 / \text{uSEC}$ .

**Note:** When using the Servo Module Encoder with Analog Input or the block analog input module the range is 800 - 32767.

If an error occurs the output at OK is not energized and the value at ERR equals 1 - 5:

ERR	Description
1	The input at RACK is out of range.
2	A rack hardware fault occurred.
3	The input at SLOT is out of range.
4	The module at the location specified is not an analog input module.
5	The input at uSEC is out of range.

NOTE: This function works in conjunction with the A\_INCHIT (channel initialize) and A\_INCHRD (channel read) functions.

A\_INMDIT and A\_INCHIT must execute one time (the input at EN should be a one-shot), in either order, before A\_INCHRD executes.

---



---

## A\_TOD\_T

Add time of day to time

**Arith/DATETIME**

---



---

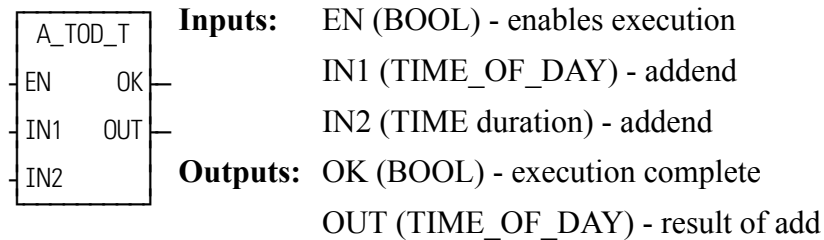

A\_TOD\_T(IN1 := <<TIME\_OF\_DAY>>, IN2 := <<TIME>>, OK => <<BOOL>>, OUT => <<TIME\_OF\_DAY>>)

The A\_TOD\_T function adds the value of the constant or variable at IN1 to the value of the constant or variable at IN2. The result is a TIME\_OF\_DAY value that is put in the variable at OUT. The number of days in the TIME value at IN2 must equal 0 or an error occurs. Any value for milliseconds is truncated.

Examples of add TIME_OF_DAY to TIME		
Value at IN1	Value at IN2	Value at OUT
TOD#11:43:12	T#0d4h10m36ms	TOD#15:53:12
TOD#23:59:54	T#3s	TOD#23:59:57

---

---

## BAT\_OK?

Battery OK?

I<sub>o</sub>/BAT\_OK?

---

---

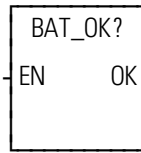

**Inputs:** EN (BOOL) - enables execution

**Outputs:** OK (BOOL) - execution completed without error

BAT\_OK(OK => <<BOOL>>)

The BAT\_OK? function tests the condition of the battery during the ladder scan. When there is power flow to the EN and the battery is good, the OK will be set.



**BIO\_PERF**

Block I/O Performance

Io/BIO\_PERF

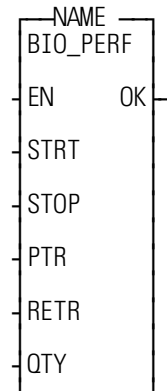

**Inputs:**

- EN (BOOL) - enables execution
- STRT (BOOL) - starts the capture of performance information
- STOP (BOOL) - stops the capture of performance information
- PTR - a pointer to an array of structures holding performance information for up to 77 block modules
- RETR (BOOL) - enables the retry quantity
- QTY (USINT) - number of retries for the system to use when attempting to communicate with each block

**Outputs:**

OK (BOOL) - execution completed

```
<<INSTANCE NAME>>:BIO_PERF(EN := <<BOOL>>, STRT := <<BOOL>>,
  STOP := <<BOOL>>, PTR := <<ARRAY OF STRUCTURES>>, RETR :=
  <<BOOL>>, QTY := <<USINT>>, OK => <<BOOL>>);
```

The BIO\_PERF function block assists you in troubleshooting a block I/O system. The function block monitors the number of good read/writes versus the number of bad read/writes to the block modules. It also allows you to change the default number of four times that the system attempts to read/write a given block module before a failure occurs.

As an example of troubleshooting, if one block module in your system has several more retries than the others, check to see if the module is wired correctly or is located near a source of excessive noise.

NOTE: You can decrease the effect of transient noise by increasing the retry count. However, remember that excessive retries can result in system degradation.

**Data Structure Members**

The members of the structure required for the array of structures at the PTR input are described below.

<b>IMPORTANT</b>	
<p>The structure entered in the software declarations table for the PTR input must have the members entered in the order listed in the table that follows. The data type entered in the <b>Type</b> column for each member of the structure must be as shown in order for the software to recognize the information.</p>	

<b>Member</b>	<b>Type</b>	<b>Description</b>
<b>TOTREAD</b> <b>(Total Reads)</b>	<b>UDINT</b>	The number of reads attempted for this block module
<b>BADREAD</b> <b>(Bad Reads)</b>	<b>UDINT</b>	The number of retries made while reading from this block module
<b>TOTWRITE</b> <b>(Total Writes)</b>	<b>UDINT</b>	The number of writes attempted for this block module
<b>BADWRITE</b> <b>(Bad Writes)</b>	<b>UDINT</b>	The number of retries made while writing to this block module

The following ladder example illustrates how the BIO\_PERF function block can be incorporated into your ladder. Note that the retry quantity (QTY) is enabled *after* the performance monitor has been enabled and consequently will take effect during the second scan of the ladder.

Figure 2-2. Network Example using BIO\_PERF Function Block

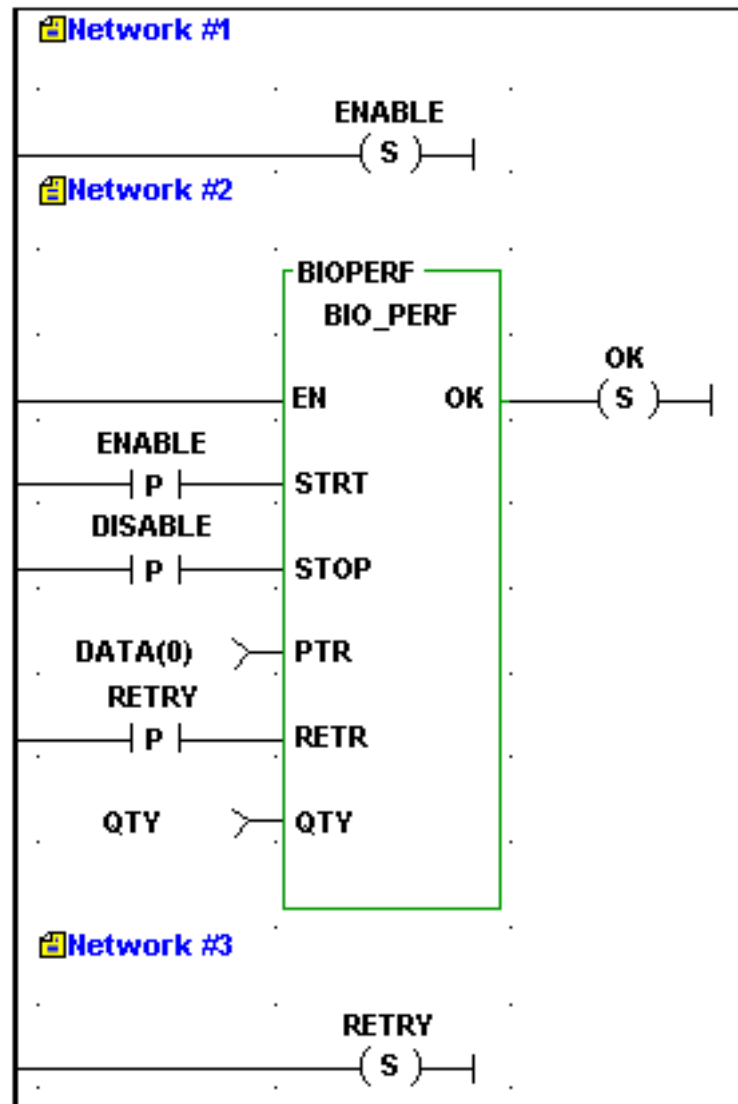

---



---

## BOOL2BYT

Boolean to Byte

**Datatype/BOOL2BYT**

---



---

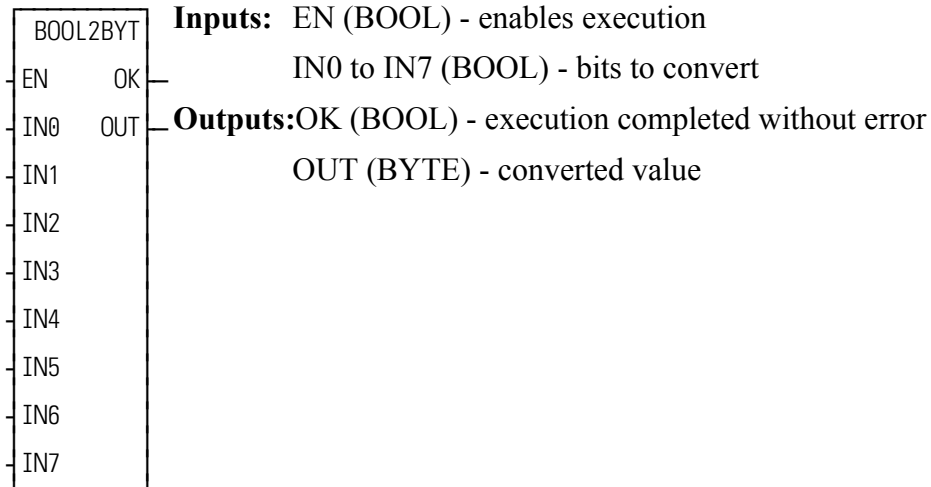

BOOL2BYT(IN0 to IN7 := <<BOOL>>, OK => <<BOOL>>, OUT => <<BYTE>>)

The BOOL2BYT function transfers the values of the 8 bits at IN0 through IN7 into the byte variable at OUT. The value at IN0 becomes the least significant (right-most) bit of the output variable.

### Example

IN7	IN6	IN5	IN4	IN3	IN2	IN1	IN0	OUT
0	0	0	0	1	1	1	1	00001111

**BTMPCHIT**

Block I/O Thermocouple or A/D Initialization

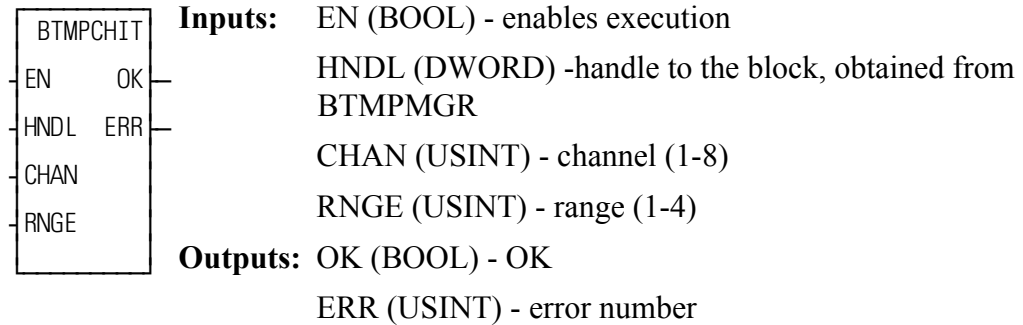
**Io/JK THERM**

```
BTMPCHIT(HNDL := <<USINT>>, SLOT := <<USINT>>, CHAN :=
<<USINT>>, RNGE := <<USINT>>, OK => <<BOOL>>, ERR =>
<<USINT>>)
```

This function initializes a Block I/O J-K Thermocouple or A/D channel. It will set up the range for the channel. This function should only be called to setup the range of the thermocouple channel. The range may be changed anytime after a handle has been obtained from the BTMPMGR function block.

The HNDL input specifies the block. Use the value obtained from the HNDL output of BTMPMGR. The CHAN input specifies the number (1 to 8) of the channel. The RNGE input specifies the temperature or voltage range (1 to 4) that can be read, where:

RNGE	Range of values for J type thermocouple*	Range of values for K type thermocouple*
1	-10° C to 280° C 14° F to 536° F	-35° C to 415° C -31° F to 779° F
2	-35° C to 620° C -31° F to 1148° F	-80° C to 820° C -112° F to 1508° F
3	-150° C to 1200° C -238° F to 2192° F	-200° C to 1300° C -328° F to 2372° F
4	±100mV	n/a

\* The temperature ranges apply over the temperature rating of the module. Temperature values outside the specified range should not be used for control purposes.

If an error occurs, the OK output will not be energized and the ERR output will return the error code. See Appendix C Temperature Function Errors for the list of ERR errors.

**BTMPCHRD**

Read temperature or A/D value from hardware

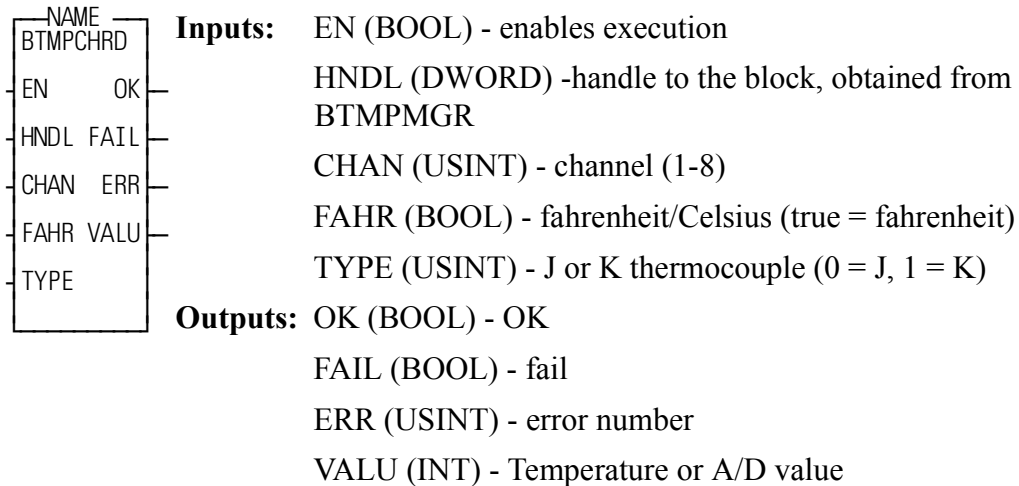
**Io/JK THERM**

```

<<INSTANCE NAME>>BTMPCHRD(EN := <<BOOL>>, HNDL :=
  <<DWORD>>, CHAN := <<USINT>>, FAHR := <<BOOL>>, TYPE :=
  <<USINT>>, OK => <<BOOL>>, FAIL => <<BOOL>>, ERR =>
  <<USINT>>, VALU => <<INT>>);

```

Use this function block to read the temperature or A/D value from the hardware. This function block will read the A/D and correct for offset and gain errors. If the channel requested is set to range 1, 2, or 3 (refer to the BTMPCHIT function), the corrected A/D value will be converted to a temperature and also compensated for the cold junction temperature. If the requested channel is in range 4, the corrected A/D value will be returned.

The HNDL input specifies the block. Use the value obtained from the HNDL output of BTMPMGR. The CHAN input specifies the channel (1 to 8) to be read. The FAHR input specifies if the temperature value returned in VALU is Fahrenheit or Celsius. Energized = Fahrenheit, de-energized = Celsius. (Fahrenheit = 1.8 x Celsius + 32). The type input specifies the type of thermocouple: 0 = J type, 1 = K type. If temperature was selected by BTMPCHIT (RNGE = 1, 2, or 3), then the VALU output returns the temperature in tenths of a degree.

If  $\pm 100\text{mV}$  was selected by BTMPCHIT (RNGE = 4), the VALU output will return a value in the range [-8192,8191] to represent an analog signal in the range [-100mV,  $\pm 100\text{mV}$ ].

Counts at VALU	mV	
- 8192	- 100	<p>The following formula can be used to calculate the mV (n) value from the counts at the VALU output.</p> $n = (\text{VALU} + 8192) * 200 / 16383 - 100$ <p>For example, if the value at VALU was 4095 counts, then the mV are calculated as follows:</p> $n = (4095 + 8192) * 200 / 16383 - 100$ $n = 50.00 \text{ mV}$
.	.	
.	.	
.	.	
.	.	
.	.	
+ 8191	+100	

If an error occurs, the FAIL output will be energized, the VALU output will be undefined, and the ERR output will return the error code. See Appendix C Temperature Function Errors for the list of error codes.

---



---

## BTMPMGR

Communicate with J-K Thermocouple Block I/O Module

Io/JK THERM

---



---

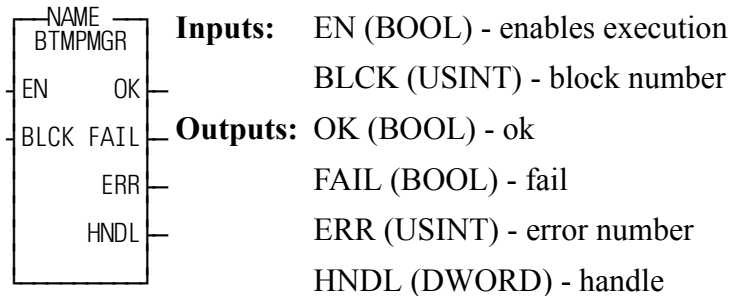

```
<<INSTANCE NAME>>BTMPMGR(EN := <<BOOL>>, BLCK :=
  <<USINT>>, OK => <<BOOL>>, FAIL => <<BOOL>>, ERR =>
  <<USINT>>, HNDL => <<DWORD>>);
```

This function block performs periodic communication with the J-K thermocouple Block I/O module. Additionally, it performs periodic calculation of temperature compensations and scale factors. This is done to reduce the ladder execution time.

This function block must be enabled every scan, with the exception of any ladder scans where block I/O is not configured or is in the process of re-configuring. This function block also performs basic block initialization. When enabled for the first time, the HNDL output will contain a handle to the block. This handle is used by BTMPCHIT and BTMPCHRD to identify the block.

The BLCK input specifies the block (1 to 77).

If an error occurs, the FAIL output will be set, the HNDL output will be undefined, and the ERR output will return the error code. See Appendix C Temperature Function Errors for the list of error codes.

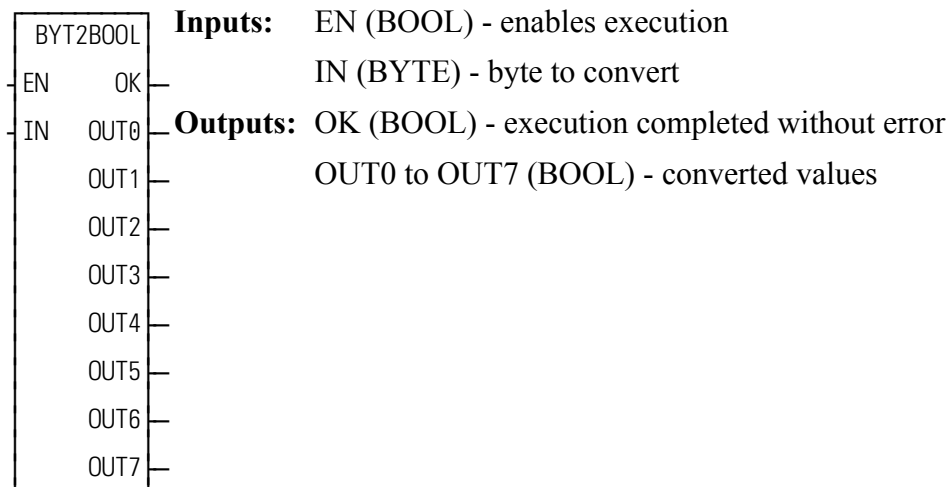

**BYT2BOOL***Byte to Boolean***Datatype/BYTECONV**

BYT2BOOL(IN := <<BYTE>>, OK => <<BOOL>>, OUT0 to OUT7 => <<BOOL>>)

The BYT2BOOL function transfers the 8-bit value of the input at IN into the 8 boolean variables specified at OUT0 through OUT7. The least significant (right-most) bit becomes OUT0.

**Example**

IN	OUT7	OUT6	OUT5	OUT4	OUT3	OUT2	OUT1	OUT0
11110000	1	1	1	1	0	0	0	0

---



---

## BYTE2DW

Byte to Double Word

**Datatype/BYTECONV**

---



---

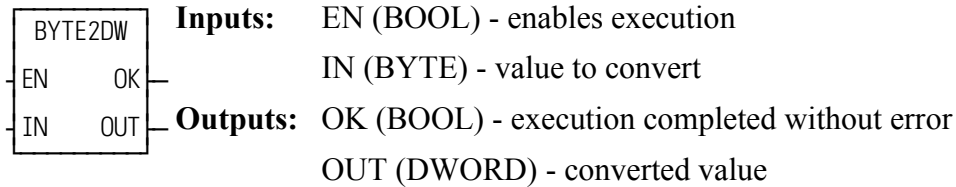

BYTE2DW(IN := <<BYTE>>, OK => <<BOOL>>, OUT => <<DWORD>>)

The BYTE2DW function changes the data type of the value at IN from a byte to a double word. The leftmost 24 bits of the double word are filled with zeros. The result is placed in the variable at OUT.

---



---

## BYTE2LW

Byte to Long Word

**Datatype/BYTECONV**

---



---

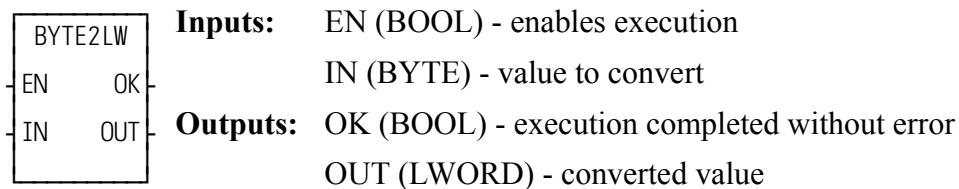

BYTE2LW(IN := <<BYTE>>, OK => <<BOOL>>, OUT => <<LWORD>>)

The BYTE2LW function converts a byte into a long word. The leftmost 56 bits of the long word are filled with zeros. The result is placed in a variable at OUT.

## BYTE2SI

Byte to Short Integer

**Datatype/BYTECONV**

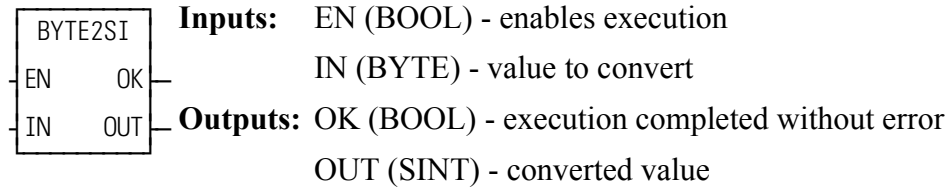

BYTE2SI(IN := <<BYTE>>, OK => <<BOOL>>, OUT => <<SINT>>)

The BYTE2SI function changes the data type of the value at IN from a byte to a short integer. The result is placed in the variable at OUT.

## BYTE2USI

Byte to Unsigned Short Integer

**Datatype/BYTECONV**

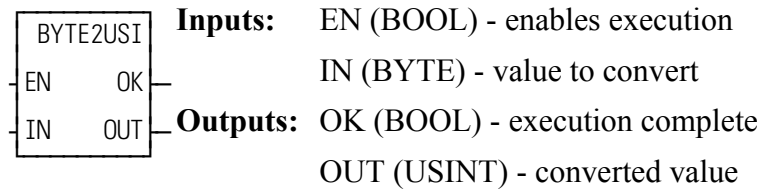

BYTE2USI(IN := <<BYTE>>, OK => <<BOOL>>, OUT => <<USINT>>)

The BYTE2USI function changes the data type of the value at IN from a byte to an unsigned short integer. The result is placed in the variable at OUT.

---



---

## BYTE2WO

Byte to Word

**Datatype/BYTECONV**

---



---

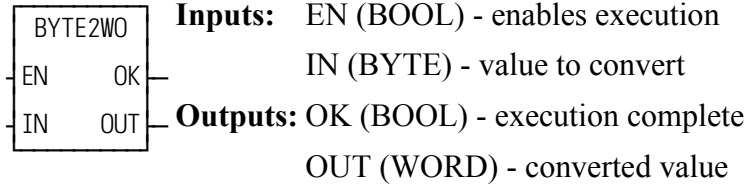

BYTE2WO(IN := <<BYTE>>, OK => <<BOOL>>, OUT => <<WORD>>)

The BYTE2WO function changes the data type of the value at IN from a byte to a word. The leftmost eight bits of the word are filled with zeros. The result is placed in the variable at OUT.

**CAM\_OUT**

Cam Output (Programmable Logic Switch)

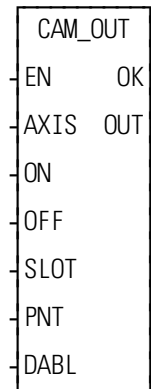
**Motion/MOVE\_SUP**

- Inputs:**
- EN (BOOL) - enables execution
  - AXIS (USINT) - identifies axis (servo, digitizing, or time)
  - ON (DINT) - value the output is to turn on at (entered in LU)  
If ON is outside the range of -536,870,912 to 536,870,911 FU, the OK will not be set.
  - OFF (DINT) - value the output is to turn off at (entered in LU)  
If OFF is outside the range of -536,870,912 to 536,870,911 FU, the OK will not be set.
  - SLOT (USINT) - identifies output module slot or MMC for PC ASI number
  - PNT (USINT) - identifies output point (1 - 16 or 1 - 32) on the output module or ASI specified by SLOT  
NOTE: When calling CAM\_OUT more than once for the same slot, be sure the point number is unique. Never enter a point number more than once for the same slot.
  - DABL (BOOL) - disables the cam output when set
- Outputs:**
- OK (BOOL) - execution completed without error
  - OUT (BOOL) - gives the logic status of the output

```
CAM_OUT(AXIS := <<USINT>>, ON := <<DINT>>, OFF := <<DINT>>,
        SLOT := <<USINT>>, DABL := <<BOOL>>, OK => <<BOOL>>, OUT =>
        <<BOOL>>)
```

The CAM\_OUT function is used to turn on a discrete output point for a specified distance during the rollover on position cycle for the axis. It performs like a programmable logic switch (PLS). The outputs are updated on an interrupt basis.

## CAM\_OUT

With a PiC CPU, the following conditions must be met in order to turn an output on using the CAM\_OUT function. The CAM\_OUT function can also be used with the MMC CPU and the MMC for PC Analog CPU. Even though the outputs can be shared, they cannot be used in more than one place.

- 16 or 32 point output module must be in the PiC location identified in SLOT.

NOTE: If you have a PiC CPU with firmware prior to version 10.2, the outputs on these modules can be used for cam outputs only. Choose “Empty” as the output module used with the CAM\_OUT function in the hardware declarations table. This ensures that the outputs will not be turned off at the end of each scan.

**Note:** Do not declare the CAM\_OUT output point (specified by SLOT and PNT) in the software declarations.

- SLOT must be a valid slot number for your PiC900/90 or MMC configuration. For a PiC900/90 rack, from 3 up to 13 depending on the size of the rack you have. For the MMC, SLOT must be 2. For the MMC for PC SLOT must be 1 through 8, specifying the ASI number.

NOTE: The CAM\_OUT function works on output modules only. It does not work on input/output modules.

- If SLOT equals zero, no physical output will be used.
- Rollover on position must be on for the axis identified in AXIS.
- The ON and OFF values must be less than the rollover on position value. ON must not equal OFF.
- A zero must be entered in DABL.

**Note:** The CAM\_OUT function does not support controlling expansion rack outputs, block outputs, DeviceNet outputs, or SERCOS drive outputs.

When using 32 points with the CAM\_OUT, the table below shows the values to enter at PNT.

	32 pt module	2 - 16 pt modules	
	Enter at PNT	Enter at PNT	
For SLOT ≠ 0	1	1	1
	2	2	2
	.	.	.
	.	.	.
	32	16	16

RR1145-0598

You can use less than 32 or 16 points on any module.

Three possible combinations for the CAM\_OUT function inputs are shown in the table that follows. The first combination is what is required to turn both the function and module output on.

The second combination will turn the function output on but not the module output because SLOT = 0.

The third combination with DABL set to “1” disables the output from both the function and the module and also removes it from any foreground calculations. This is the recommended way to disable a cam output since it saves CPU time. AXIS, SLOT, and PNT must have valid data entered before a cam output can be disabled.

Each of these combinations assume that ON ≠ OFF. If ON = OFF, then there would be no function or module output but CPU time would be used.

**NOTE**

Once a point is assigned to an axis it cannot be reassigned to a different axis unless the servos are reinitialized.

**Table 2-2. Cam input combinations and results**

If these Cam function inputs are:		Then the function OUT, module output, and CPU time use are:		
SLOT	DABL	Function OUT	Module Output	Use CPU time
SLOT ≠ 0	DABL = 0	YES	YES	YES
SLOT = 0	DABL = 0	YES	NO	YES
*	DABL = 1	NO	NO	NO

An \* means that any valid data may be entered at the designated input.

Outputs are updated on an interrupt basis.

From 1 to 32 outputs (identified at PNT) can be turned on by calling the CAM\_OUT function once for each output desired. The distance during which each output remains on can vary by changing the values in ON and OFF in each function.

Examples of turning on an output for varying distances is illustrated in Cam ON/OFF representation. If the rollover on position cycle equals 1,000 LU and the value entered in ON is 100 and the value entered in OFF is 200, then the output will remain on during 100 units of travel as shown on the left.

If the value entered in ON is 200 and the value entered in OFF is 100, then the output will remain on for 900 units as shown on the right.

**Figure 2-3. Cam ON/OFF representation**

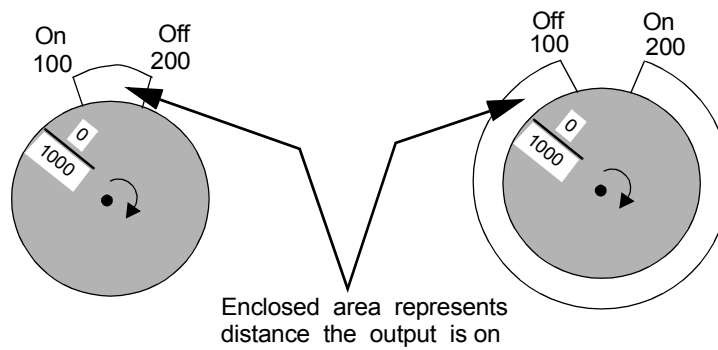



---



---

**CAPTINIT**

Data Capture Initialization

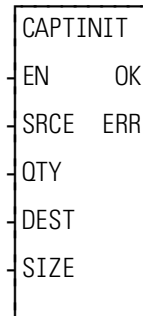
**Motion/DATA**

**Inputs:** EN (BOOL) - enables execution (**One-shot**)

SRCE (ARRAY OF STRUCT) - an array of structures to define what data is to be captured.

QTY (USINT) - the number of variables (from 1 to 8) to be captured. (Same as the number of array elements in SRCE or the number of structure members in DEST.)

DEST (ARRAY OF STRUCT) - an array of structures to store the captured data.

SIZE (UINT) - the number of array elements in DEST which represents the number of data samples to take.

**Outputs:** OK (BOOL) - set if no errors in structure data

ERR (USINT) - no error if ERR = 0; error if ERR ≠ 0. Errors are listed below.

CAPTINIT(SRCE := <<MEMORY AREA>>, QTY := <<USINT>>, DEST := <<MEMORY AREA>>, SIZE := <<UINT>>, OK => <<BOOL>>, ERR => <<USINT>>)

This section contains information on how to capture data in the PiC ladder so that it can be displayed on the workstation screen. If you are capturing data directly from the ladder once per scan, then the variables can be put into an array of structures using the READ\_SV function. If you are capturing data from servo interrupts, then you use the two functions, CAPTINIT and CAPTSTAT, to get the variables into an array of structures, as shown in Tasks for data capture

The communication function blocks are used to create a binary file that can be sent to the PiC RAMDISK or the workstation.

Figure 2-4. Tasks for data capture

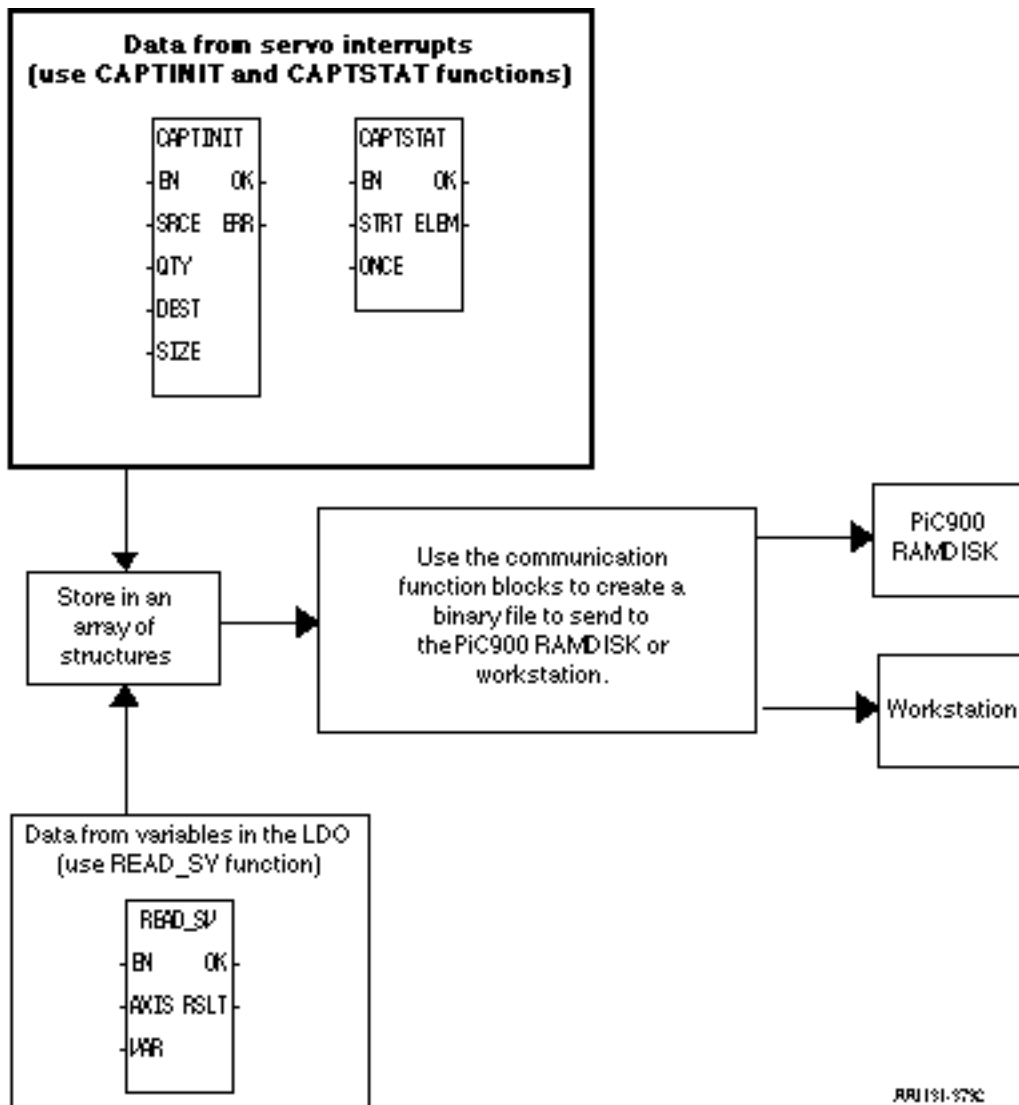

The CAPTINIT function defines the data you want to capture each servo interrupt and where the data will be stored.

<b>CAUTION</b>	
It is very important that the values entered at QTY and SIZE equal the number of variables you are capturing and the number of samples you are taking respectively. If not, the results are unpredictable.	

<b>ERR #</b>	<b>Description</b>
<b>0</b>	No error
<b>1</b>	The CAPTSTAT function has not stopped capturing data from a previous data capture initialization.
<b>2</b>	An axis number in the structure is invalid.
<b>3</b>	The limit of eight variables in the array of structures has been exceeded.
<b>4</b>	Parameter number in the structure is out of range.
<b>5</b>	The CAPTINIT function was called before the STRTSERV function was called.

**The SRCE input array of structures**

An array of structures is used at the SRCE input of the CAPTINIT function. There is one array element for each variable to capture. Each array element is a structure with two members; AXIS which identifies the servo or digitizing axis the variable applies to and VAR which identifies the variable you want to capture. A maximum of eight variables can be captured within one array of structures. The variables are described in the table below.

Table 2-3. Data Capture

Var	Name	Type
1	<b>Actual position</b> The actual position of the device with reference reset applied. Units are feedback units. (Variable 1 in READ_SV.)	DINT
2	<b>Fast input occurred</b> On for one interrupt. Bit 00001000 of this byte. (Same as bit 00000010 out of STATUSSV.)	BYTE
3	<b>Commanded position</b> The commanded position sent to the servo upgrade. Units are feedback units. (Variable 3 in READ_SV.) NOTE: This is the same as actual for a digitizing axis.	DINT
4	<b>Position error</b> The error between the filtered output and the actual. Units are feedback units. (Variable 4 in READ_SV.)  NOTE: With a SERCOS axis, this value will differ from servo variable 4 by the number of feedback units traveled in four servo updates. For an exact reading of position error with a SERCOS axis, read Following Distance IDN 189 from the drive.	DINT
5	<b>Slow Velocity Filter error</b> The accumulated value in the slow velocity filter. Units are feedback units. (Variable 5 in READ_SV.)	DINT
6	<b>Command change</b> The command delta for this interrupt after filter. Units are feedback units per upgrade. (Variable 6 in READ_SV.)	INT
7	<b>Position change</b> The change in actual position for this upgrade. Units are feedback units per upgrade. (Variable 7 in READ_SV.)	INT
8	<b>Feedback position</b> The 24 bit counter from the hardware. Top byte is always 0. Units are feedback units. (Variable 8 in READ_SV.)	DINT
9	<b>Prefilter commanded position</b> The commanded position prior to the filter. Units are feedback units. NOTE: This is the same as actual for a digitizing axis.	DINT
10	<b>Prefilter command change</b> The command delta for this interrupt before filter. Units are feedback units.	INT

11	<b>Remaining master offset</b> The accumulated master offset. Units are feedback units.	DINT
12	<b>Remaining slave offset</b> The accumulated slave offset. Units are feedback units.	DINT
13	<b>Command change</b> The command delta for this interrupt after filter. Units are feedback units per upgrade. (Variable 6 in READ_SV.)	DINT
14	<b>Position change</b> The change in actual position for this upgrade. Units are feedback units per upgrade. (Variable 7 in READ_SV.)	DINT
15	<b>Prefilter command change</b> The command delta for this interrupt before filter. Units are feedback units.	DINT

<b>IMPORTANT</b>	
<p>The structure you enter in the software declarations table for the SRCE input must have the members entered in the order shown below. The data type for each member of the structure must be as shown in the <b>Type</b> column in order for the software to recognize the information.</p>	

In the example shown below, there are three variables to be read; the actual position of Axis 1 (1), the position change of Axis 1 (7), and the actual position of Axis 49 (1).

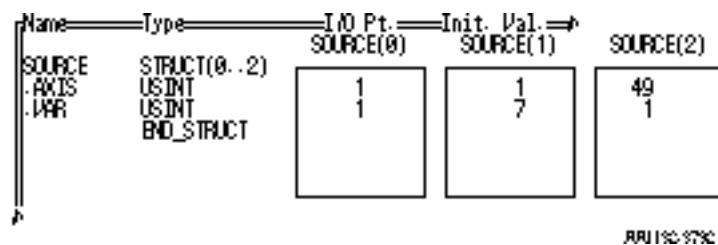

**The DEST input array of structures**

DEST is the array of structures which is the destination of the captured data. There is one array element for each data sample. A data sample occurs each interrupt and will capture as many variables as indicated at SRCE. Each structure contains one member for each variable captured. In the above example, there are three variables and therefore there needs to be three structure members. Each structure member must be the correct type to accommodate the variable captured. The type of each variable is listed under the Type column in the variable table above.

In the example, the array of structures could look like this:

	<b>Name</b>	<b>Type</b>	<b>A.</b>	<b>I/O Point</b>	<b>li</b>
	DESTIN	STRUCT(0..99)			
	.POS1	DINT			
	.DELTA	INT			
	.POS49	DINT			
		END_STRUCT			
	.....	..			

This array of structures accommodates 100 data samples. Captured data is stored sequentially into the array until the end is reached (element 99 in the example). Then the data will wrap around and begin to fill the array again unless ONCE has been set in the CAPTSTAT function. Use the ELEM output of the CAPTSTAT function to find out the next element in the array that will be written to.

---



---

**CAPTSTAT**

Data Capture Status

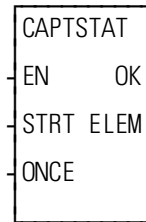
**Motion/DATA**

**Inputs:** EN (BOOL) - enables execution

STRT (BOOL) - a positive transition will start the data capture process. A zero will stop the data capture process.

ONCE (BOOL) - set to fill the array of structures one time.

**Outputs:** OK (BOOL) - set if no errors in structure data

ELEM (UINT) - the number of the next array element that will be written to. (0 is the first element in an array.)

```
CAPTSTAT(STRT := <<BOOL>>, ONCE := <<BOOL>>, OK => <<BOOL>>,
          ELEM => <<UINT>>)
```

NOTE: If the CAPTINIT function is not called before this function, the OK will not be set and ELEM will = 0.

The CAPTSTAT function provides the ability to start and stop the capturing of data from the ladder.

---



---

# CLOCK

Clock

**Xclock/CLOCK**

---



---

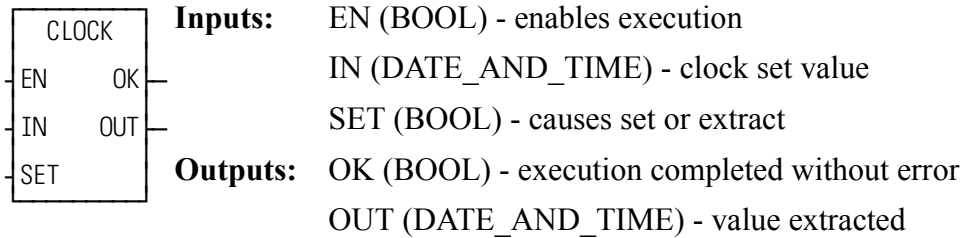

CLOCK(IN := <<DATE\_AND\_TIME>>, SET := <<BOOL>>, OK =>  
 <<BOOL>>, OUT => <<DATE\_AND\_TIME>>)

The CLOCK function is used to get the current date and time from the PiC, or to enter a date and time into the PiC. It is also used to apply a Date and Time stamp to begin a control event (e.g. to energize a switch).

If power flow exists at SET, then the PiC clock is set with the value of the variable at IN. The value at IN is also placed into the variable at OUT.

If power flow does not exist at SET, then the (current) PiC date and time are extracted from the PiC clock and placed in the variable at OUT.

Typically, the CLOCK function is used in a read only mode. The example below shows how to set this up. Put the same variable name on IN and OUT. Place a Normally Open contact that is never set at the SET input.

### Example

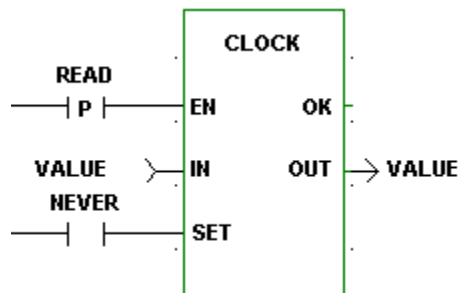



**CLOSE**

Close

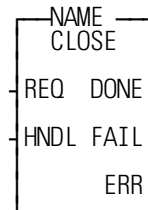
**I<sub>o</sub>/COMM**

**Inputs:** REQ (BOOL) - enables execution (**One-shot**)  
 HNDL (INT) - output from OPEN function block

**Outputs:** DONE (BOOL) - energized if ERR = 0  
 not energized if ERR ≠ 0  
 FAIL (BOOL) - energized if ERR ≠ 0  
 not energized if ERR = 0  
 ERR (INT) - 0 if data transferred successfully;  
 ≠ 0 if data transfer unsuccessful

*See Appendix B in the PiCPro Online Help for ERR codes.*

```
<<INSTANCE NAME>>:CLOSE(REQ := <<BOOL>>, HNDL := <<INT>>,
  DONE => <<BOOL>>, FAIL => <<BOOL>>, ERR => <<INT>>);
```

The CLOSE function block closes the communication channel between the LDO and either a workstation file, a PiC RAMDISK file, a PiC FMSDISK file, or User Port.

The device or file at HNDL is closed, terminating the transfer of data from/to the file/device. Execution of this function block frees a mode (or 2 modes for read and write or append). It also empties the read and write buffers.

CLOSE is used in conjunction with the CONFIG, OPEN, READ, SEEK, STATUS, and WRITE I/O function blocks.

---



---

## CLOSLOOP

**Close Loop**

**Motion/INIT**

---



---

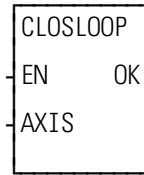

**Inputs:** EN (BOOL) - enables execution (**One-shot**)

AXIS (USINT) - identifies axis (servo)

**Outputs:** OK (BOOL) - execution completed without error

CLOSLOOP(AXIS := <<USINT>>, OK => <<BOOL>>)

The position loop for the designated axis is closed when the CLOSLOOP function is activated. The commanded position of the axis will be compared to the actual position of the axis. The difference between the two is the following error. The PID calculations will respond to the error by telling the analog output to send a corrective voltage signal to the drive. The drive will move the axis toward the commanded position. Any further disturbance in axis position will initiate a similar corrective response. This function must be included in any closed loop servo application. See also OPENLOOP.

### Digital Drive Notes:

When calling CLOSLOOP with a digital drive axis, the digital drive's hardware enable line must be high for the loop to close.

If CLOSLOOP is called while the digital drive is in Velocity Mode, the drive will be enabled, the velocity loop will be closed, and the axis will be ready to accept velocity commands via DVELCMD. At the time the loop is closed, the command velocity will be zero since it was zeroed when the loop was opened and is held at zero while the loop is open.

If CLOSLOOP is called while the digital drive is in Torque Mode, the drive will be enabled, the torque loop will be closed, and the axis will be ready to accept current commands via DTORQCMD. At the time the loop is closed, the command current will be zero since it was zeroed when the loop was opened and is held at zero while the loop is open.

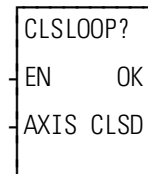
**CLSLOOP?***Close Loop?***Motion/INIT****Inputs:** EN (BOOL) - enables execution

AXIS (USINT) - identifies axis (servo)

**Outputs:** OK (BOOL) - set if axis is closed loop and initialized

CLSD (BOOL) - set if the axis loop is closed, cleared if the axis loop is open or the OK is not set

CLSLOOP(RACK := &lt;&lt;USINT&gt;&gt;, OK =&gt; &lt;&lt;BOOL&gt;&gt;, CLSD =&gt; &lt;&lt;BOOL&gt;&gt;)

The CLSLOOP? function allows you to inquire whether or not the loop for an axis is closed. The axis you are inquiring about is identified at the AXIS input. The CLSD output indicates whether the axis loop is closed or not.

The axis will be closed only if you have previously called the CLOSLOOP function for this axis. The axis will be open if you have called the OPENLOOP function or an E-stop error is in effect. This function may be called at any time and in any task.

NOTE: If the axis is a SERCOS axis, the CLSD output will be set if both the SERCOS drive *and* the motion.lib indicate the loop is closed. Otherwise, CLSD will be reset.

## CONCAT

Concatenate

String/**CONCAT**

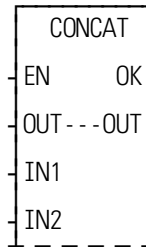

**Inputs:** EN (BOOL) - enables execution  
 OUT (STRING) - concatenated STRING  
 IN1 (STRING) - STRING input  
 IN2 (STRING) - STRING input

**Outputs:** OK (BOOL) - execution completed without error  
 OUT (same variable as OUT input)

```
CONCAT(OUT := <<STRING>>, IN1 := <<STRING>>, IN2 := <<STRING>>,
    OK => <<BOOL>>, OUT => <<STRING>>);
```

The CONCAT function merges two STRING variables together. The variable at IN2 is placed directly after the variable at IN1 and the resulting STRING is placed in the variable at OUT.

This is an extensible function which can concatenate up to 17 STRINGS. The STRING at IN17 is placed after the STRING at IN16, which is placed after the STRING at IN15, etc. The variables at IN2 through IN17 must be unique from the variable at OUT.

An error occurs:

- If the length of IN1 > length of OUT
- If the length of IN2 > length of OUT
- If the length of IN1 + length of IN2 > length of OUT
- If IN2, or IN3, ... or IN17 = OUT

### Example of Concatenate Function

Var at IN1	Value at IN2	Value at IN3	Var at OUT
string1	string2	string3	string1string2string3

**CONFIG**

Configure

**IO/COMM**

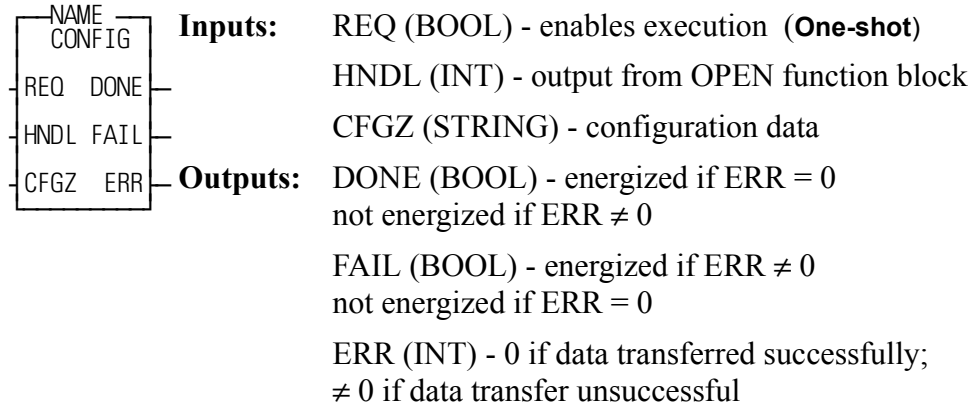

```
<<INSTANCE NAME>>:CONFIG(REQ := <<BOOL>>, HNDL := <<INT>>,
    CFGZ := <<STRING>>, DONE => <<BOOL>>, FAIL => <<BOOL>>, ERR
    => <<INT>>);
```

The CONFIG function block establishes the communication parameters for the PiC User Port (only) and the handle specified by the input at HNDL. To configure User Port, create a STRING variable and connect it at the CFGZ input. Enter the parameters in the order shown. Each parameter value must be separated by a command.

Baud rate	Parity	Data bits	Stop bits	Synch mode	Terminator
9600,	N,	8,	1,	N	\$00

String = 9600,N,8,1,N\$00

NOTE: To use all default values, create a string variable of length 0 with no initial value. To use one or more (but not all default values), insert a comma for each value that is omitted as shown below.

Baud rate	Parity	Data bits	Stop bits	Synch mode	Terminator
,	N,	,	,	N	\$00

String = ,N,,N\$00

Table 2-4. Parameters for CONFIG string

Parameter	Acceptable values	Default value	Description
<b>Baud Rate</b>	110, 300, 600, 1200, 2400, 4800, 9600, 19200 (Contact G&L Motion Control for acceptable MMC-D baud rates. )	9600	Number of bits per second that are transferred - a baud rate above 9600 requires hardware sync mode
<b>Parity</b>	E - Even O -Odd N - None	N	E - if # of 1s in lower 7 bits is odd, then bit 8 is set to 1 O - if # of 1s in lower 7 bits is even, then bit 8 is set to 1 N - no parity checking
<b>Data Bits</b>	7 or 8	8	Number of bits that are to be interpreted as data
<b>Stop Bits</b>	1 or 2	2(for 110 baud) 1(for other bauds)	After the transmission of every byte, pause for the time it takes to send 1 or 2 bits before transmitting the next byte
<b>Synch Mode</b>	N - None S - Send R - Receive B - Both S & R H - Hardware	N	R - the PiC will stop sending if <CTRL-S> or XOFF is received and resume sending when <CTRL-Q> or XON is received. S - the PiC will send a <CTRL-S> when input needs to be suspended and a <CTRL-Q> when input is to resume. H - clear to send (CTS) and request to send (RTS) are connected between the devices to prevent overruns.
<b>RS422/485 Mode</b>	T - Transmitter Disabled	None	T -When using RS422/485 communications and the 2- or 4-channel serial communications module, including a "T" in the CFGZ string as shown below disables the transmitter when there are no characters to transmit. String = 9600,N,8,1,N,T\$00 This allows implementation of a two-wire party line configuration with RS485 communication links.
<b>Terminator</b>	\$00	None	Characters that signal end of data.

CONFIG is used in conjunction with the CLOSE, OPEN, READ, SEEK, STATUS, and WRITE I/O function blocks.

**COORD2RL**

Coordinate to Real

**Motion/DATA**

COORD2RL
EN      OK
CNFG    ERR
MOVE
ACTV
SEG1
-----

**Inputs:** EN (BOOL) - enables execution  
 CNFG (STRUCTURE) - provides setup data for move  
 MOVE (STRUCTURE) - provides part program data for move  
 ACTV (WORD) - identifies axis for each segment output  
 SEG1 (STRUCTURE) - provides segment output for the first axis. Function can be extended for 15 additional axes SEG outputs.

**Outputs:** OK (BOOL) - execution completed without error  
 ERR (INT) -  $\neq 0$  if and only if an error occurs.

COORD2RL(CNFG := <<MEMORY AREA>>, MOVE := <<MEMORY AREA>>, ACTV := <<WORD>>, SEG1 := <<MEMORY AREA>>, OK => <<BOOL>>, ERR => <<INT>>)

The COORD2RL function is a math conversion function requiring servo initialization and a math coprocessor on the PiC CPU. It is an extensible function that calculates a profile segment (output SEG1 through SEG16) for up to 16 axes from the information provided in the CNFG and MOVE inputs.

NOTE: Of the 32 servo axes available, only servo axes numbered 1 through 16 can be used with this function.

The CNFG input is a structure holding setup data. The MOVE input is a structure containing part program information such as endpoints, velocities, move times, circle centerpoints, etc.

The COORD2RL math conversion function is used with the RATIO\_RL function.

**IMPORTANT**

The structures entered in the software declarations table for CNFG, MOVE, and SEG1 must have the members entered in the order listed in the tables that follow. The data type entered in the **Type** column for each member of the structure must be as shown in order for the software to recognize the information.



Table 2-5. COORD2RL structure members at the CNFG input

Member	Type	Description
<b>TMAXRT</b> (time axis rate)	<b>DINT</b>	Enter the time axis rate. 1000 units/sec is recommended for most applications.
<b>TOLR</b> (tolerance)	<b>DINT</b>	Enter in ladder units the limit on the circle endpoint your application will accept before an error is reported.
<b>FLAGS</b> (flags)	<b>WORD</b>	Bit 0 is the only bit currently in use.
<p>15 14 13 12 11 10 9 8 7 6 5 4 3 2 1 0    0 = no velocity check  1 = velocity check  All remaining bits (1-15) should be set to zero.  APR110:019C</p>		

Table 2-6. COORD2RL structure members at the MOVE input

Member	Type	Description
<b>LINEAR</b> (linear axes)	<b>WORD</b>	Identify from 1 to 16 axes that will be used for linear moves.
<b>CIRCLE</b> (circular axes)	<b>WORD</b>	Identify two axes that will be used for circular moves.
<b>DEPART</b> (departure axes)	<b>WORD</b>	Identify from 1 to 16 axes that will be used for third axis departure moves.  NOTE: Third axis departure is accomplished by slaving the third axis to the same time axis as the two axes doing the circle.
<b>RTTM</b> (rate or time)	<b>BYTE</b>	Selects rate or time. 00 = rate 80 (hex) = time
<b>DIR</b> (direction)	<b>BYTE</b>	Selects the direction a circular move will take. 00 = CW 80 (hex) = CCW
<b>VALUE</b> (rate or time value)	<b>DINT</b>	Define the rate or time (based on what was selected at RTTM above). Rate is entered in LU/min. Time is entered in msec.
<b>AX1CP</b> (First axis centerpoint)	<b>DINT</b>	Enter the centerpoint for the first axis (lowest number) entered in CIRCLE.
<b>AX2CP</b> (Second axis centerpoint)	<b>DINT</b>	Enter the centerpoint for the second axis (highest number) entered in CIRCLE.
<b>ENDPTS</b> (1-16 endpoints)	<b>DINT (0-15)</b>	Enter in an array the endpoints for all axes being used.

Table 2-7. COORD2RL structure members at the SEG output

Member	Type	Description
<b>MASTER</b> (master distance)	<b>DINT</b>	The segment master distance
<b>SLAVE</b> (slave distance)	<b>DINT</b>	The segment slave distance
<b>LEN</b> (cycle length/K <sub>1</sub> )	<b>LREAL</b>	The length of the cycle
<b>AMPL</b> (amplitude/K <sub>2</sub> )	<b>LREAL</b>	The amplitude of the wave
<b>STANGL</b> (starting angle/K <sub>3</sub> )	<b>LREAL</b>	The starting angle of the wave
<b>SPARE</b> (unused)	<b>LREAL</b>	Declare this in your structure since it may be used in the future for additional features.
<b>FLAGS</b> (flags)	<b>DWORD</b>	Bits 0 through 4 are currently being used. (See explanation at the REAL input of RATIO_RL.)

The table below defines the outputs that can appear at the ERR output of the COORD2RL function.

**Table 2-8. COORD2RL ERRs**

<b>#</b>	<b>ERR Output</b>
<b>0</b>	No error
<b>1</b>	No bits were set in the LINEAR, CIRCLE, or DEPART members of the MOVE structure.
<b>2</b>	Bits were set in both the LINEAR and CIRCLE members of the MOVE structure. Bits can be set in only one of these members.
<b>3</b>	The same bit was set in the DEPART and CIRCLE members of the MOVE structure. An axis cannot be departure and circular at the same time.
<b>4</b>	The same bit was set in the LINEAR and DEPART members of the MOVE structure. An axis cannot be linear and departure at the same time.
<b>5</b>	Set if other than 0 or 2 bits were set in CIRCLE. Two bits must always be set in order to do a circular move.
<b>6</b>	The ACTV input indicated a fewer number of axes than the number connected to the inputs labeled at SEG.
<b>7</b>	A bit is set in LINEAR, CIRCLE, or DEPART that does not have a corresponding bit in ACTV.
<b>8</b>	The time or rate value is negative. These must be positive numbers only.
<b>9</b>	The time or rate value is zero.
<b>10</b>	The rate was too high or the time was too low to calculate.
<b>11</b>	The rate was too low or the time was too high to calculate.
<b>12</b>	An axis that was selected was not initialized by the user function.
<b>13</b>	The STRTSERV function was not called. No axes have been initialized.
<b>14</b>	The circle endpoint limit you entered in the CNFG structure for TOLR has been exceeded.
<b>1xx</b>	Distance calculated using scaling was too positive to fit in the 32 bit value. xx is the axis number.
<b>2xx</b>	Distance calculated using scaling was too negative to fit in the 32 bit value. xx is the axis number.
<b>3xx</b>	Velocity exceeded the maximum feedrate defined in servo setup. NOTE: Valid profile data is still produced if this error occurs.

**COS**

Cosine

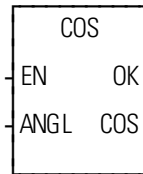
**Arith/TRIG**

**Inputs:** EN (BOOL) - enables execution  
 ANGL (REAL/LREAL) - angle value (in radians)

**Outputs:** OK (BOOL) - execution completed without error  
 COS (REAL/LREAL) - cosine calculated

NOTE: The data types entered at ANGL and COS must match, i.e. if ANGL is REAL, then COS must be REAL.

COS(ANGL := <<REAL/LREAL>>, OK => <<BOOL>>, COS => <<REAL/LREAL>>)

The COS function calculates the cosine of the angle entered at ANGL. The result is placed at COS.

**CTD**

Count Down

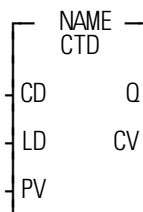
**Counters/CTD**

**Inputs:** CD (BOOL) - initiate count down  
 LD (BOOL) - load PV to CV  
 PV (INT) - preset value to count down from

**Outputs:** Q (BOOL) - execution completed for count down to 0  
 CV (INT) - count value

<<INSTANCE NAME>>:CTD(CD := <<BOOL>>, LD := <<BOOL>>, PV := <<INT>>, Q => <<BOOL>>, CV => <<INT>>);

The CTD function block counts down to -32768 from the preset value in the variable or constant at PV. The count value at CV is decremented by one whenever a 0 to 1 transition occurs at CD.

Whenever the count is  $\leq$  zero, the output at Q is energized.

The value at PV is loaded into the value at CV when power flow occurs at LD.

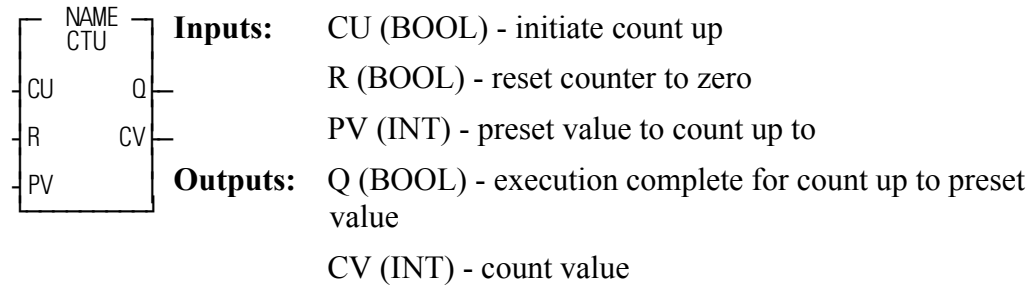
**CTU***Count Up***Counters/CTU**

```
<<INSTANCE NAME>>:CTU(CU := <<BOOL>>, R := <<BOOL>>, PV :=
  <<INT>>, Q => <<BOOL>>, CV => <<INT>>);
```

The CTU function block counts up from zero to +32767. The count value at CV is incremented by one whenever a 0 to 1 transition occurs at CU.

Whenever the count is  $\geq$  the preset value at PV, the output at Q is energized.

The value at CV is reset to zero when power flow occurs at R.

**CTUD**

Count Up/Count Down

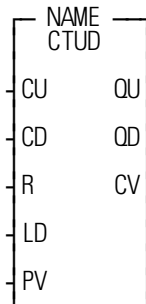
**Counters/CTUD**

**Inputs:** CU (BOOL) - initiate count up  
 CD (BOOL) - initiate count down  
 R (BOOL) - reset counter to zero  
 LD (BOOL) - load PV to CV  
 PV (INT) - preset value to count up to and down to

**Outputs:** QU (BOOL) - execution complete for count up  
 QD (BOOL) - execution complete for count down  
 CV (INT) - count value

```
<<INSTANCE NAME>>:CTUD(CU := <<BOOL>>, CD := <<BOOL>>, R :=
  <<BOOL>>, LD := <<BOOL>>, PV := <<INT>>, QU => <<BOOL>>, QD =>
  <<BOOL>>, CV := <<INT>>);
```

The CTUD function block counts between +32767 and -32768.

The count value at CV increments by one whenever a transition occurs at CU. The count value at CV decrements by one whenever a 0 to 1 transition occurs at CD.

Whenever CV is  $\geq$  PV, QU is energized; whenever CV is  $\leq$  0, QD is energized.

When power flow occurs at R, the value at CV resets to zero and QD is energized. When power flow occurs at LD, the value at PV is loaded into CV and QU is energized.

**Note:** Only one boolean input at a time should be energized.

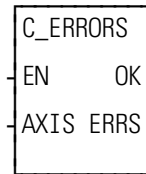
**C\_ERRORS***Controlled Stop Errors***Motion/ERRORS**

**Inputs:** EN (BOOL) - enables execution  
 AXIS (USINT) - identifies axis (servo)

**Outputs:** OK (BOOL) - execution complete  
 ERRS (WORD) - indicates errors

C\_ERRORS(AXIS := <<USINT>>, OK => <<BOOL>>, ERRS => <<WORD>>)

The ERRS output on the C\_ERRORS function is a word, or two bytes, as shown below. The MSB bit (indicated by the “x”) in the high byte word indicates that there is an error. The low byte of the word is where the individual errors are located.

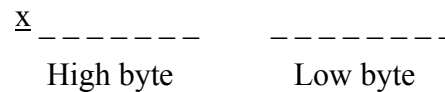

The table that follows gives the C-stop errors and their locations.

NOTE: The C\_ERRORS can also be viewed from the tune section of the Servo setup program. The “E” is what appears on the tune screen in Servo setup.

The **Bit Location** column indicates which bit is set in the low or high byte of the word connected to each error.

The **Hex Value** column represents the form the error is returned in while monitoring the ERRS output of the function in your ladder program.

Table 2-9. Controlled stop errors

Error	Description	Bit Location (low byte)								Hex Value (Decimal)*	
		8	7	6	5	4	3	2	1	(in LDO)	
Part reference error	Move was in progress when a part reference or a part clear function was called.	E									8080 (32896)
Part reference dimension error	When the dimension for the part reference was converted to feedback units, it was too big to fit into 29 bits.		E								8040 (32832)
Distance or position move dimension error	When the dimension for the move was converted to feedback units, it was too big to fit into 31 bits.			E							8020 (32800)
Feedrate error**	When the feedrate for the move was converted to feedback units per servo up-grade, it was too big to fit into 32 bits or it exceeds the velocity limit entered in setup.				E						8010 (32784)
Machine reference dimension error	When the dimension for the machine reference was converted to feedback units, it was too big to fit into 29 bits.					E					8008 (32776)
User-defined C-stop	When this bit is set, a user-defined C-stop has occurred.						E				8004 (32772)
Negative software limit exceeded	The command position exceeded the user-defined negative software end limit.							E			8002 (32770)
Positive software limit exceeded	The command position exceeded the user defined positive software end limit.								E		8001 (32769)

\*When more than one error occurs, the hex values are OR'd. For example, if 8001 and 8004 occur, the result is 8005 hex (32773 decimal).

\*\*This error can occur with feedrate override, new feedrate, position, distance, velocity, or machine reference moves.

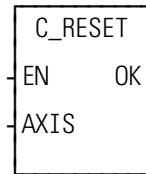

**C\_RESET***Controlled Stop Reset***Motion/ERRORS**

**Inputs:** EN (BOOL) - enables execution (**Typically one-shot**)  
 AXIS (USINT) - identifies axis (servo)

**Outputs:** OK (BOOL) - execution completed without error

C\_RESET(AXIS := <<USINT>>, OK => <<BOOL>>)

The C\_RESET function resets the controlled stop condition and the errors that caused it. You must always reset any C-stop error that occurs.

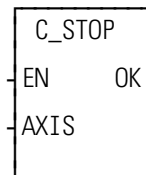
**C\_STOP***Controlled Stop***Motion/ERRORS**

**Inputs:** EN (BOOL) - enables execution  
 AXIS (USINT) - identifies axis (servo)

**Outputs:** OK (BOOL) - execution completed without error

C\_STOP(AXIS := <<USINT>>, OK => <<BOOL>>)

The C\_STOP function will bring the specified axis to a controlled stop based on the controlled stop ramp entered in setup. Any further movement by the axis will be prevented until the C-stop condition is reset.

---

---

## C\_STOP?

Controlled Stop?

**Motion/ERRORS**

---

---

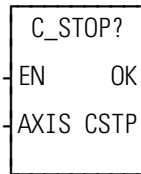

**Inputs:** EN (BOOL) - enables execution

AXIS (USINT) - identifies axis (servo)

**Outputs:** OK (BOOL) - execution completed without error

CSTP (BOOL) - indicates a C-stop is active when set

C\_STOP?(AXIS := <<USINT>>, OK => <<BOOL>>, CSTP => <<BOOL>>)

The C\_STOP? function asks if there is a C-stop in effect for this axis.

---

---

**DATE2STR***Date to String***Datatype/D\_TCONV**

---

---

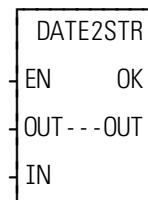

**Inputs:** EN (BOOL) - enables execution  
 OUT (STRING) - output STRING  
 IN (DATE) - value to be converted

**Outputs:** OK (BOOL) - execution completed without error  
 OUT (same variable as OUT input)

DATE2STR(OUT := <<STRING>>, IN := <<DATE>>, OK => <<BOOL>>,  
 OUT => <<STRING>>)

The DATE2STR function converts the value in the variable or constant at IN to a STRING and places the result in the variable at OUT.

**Example of DATE to STRING**

Var at IN	Value at OUT
D#1995-11-01	1995-11-01

**DELETE**

Delete

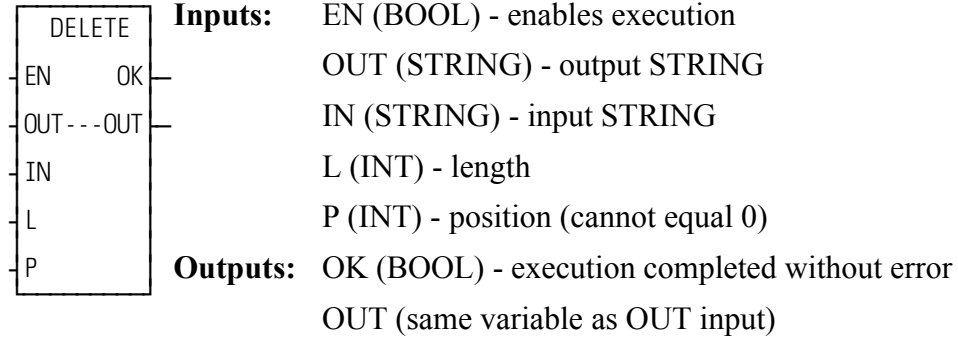
**String/DELETE**

DELETE(OUT := <<STRING>>, IN := <<STRING>>, L := <<INT>>, P := <<INT>>, OK => <<BOOL>>, OUT => <<STRING>>)

The DELETE function is used to delete characters from a STRING. It deletes characters from the variable at IN. The input at L specifies how many characters to delete, starting at the position specified by the input at P. The resulting (left-over) STRING is placed into the variable at OUT.

An error occurs if any of the following is true:

- P = 0
- P > 255
- P > length of IN
- L > 255
- Length of IN - L > length of OUT

**Example of delete function**

Var at IN	Value at L	Value at P	Var at OUT
stringlong	4	7	string

## DELFIL

Delete File

Io/COMM

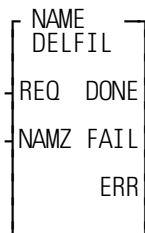

**Inputs:** REQ (BOOL) - enables execution (**One-shot**)  
 NAMZ (STRING) - a string containing the complete pathname

**Outputs:** DONE (BOOL) - energized if ERR = 0  
 not energized if ERR ≠ 0  
 FAIL (BOOL) - energized if ERR ≠ 0  
 not energized if ERR = 0

ERR (INT) - 0 if data transferred successfully  
 ≠ 0 if data transfer unsuccessful

*See Appendix B in the PiCPro Online Help for error codes.*

```
<<INSTANCE NAME>>:DELFIL(REQ := <<BOOL>>, NAMZ :=
    <<STRING>>, DONE => <<BOOL>>, FAIL => <<BOOL>>, ERR =>
    <<INT>>);
```

The DELFIL function block allows you to delete a file from the RAMDISK or from PiCPro.

At the NAMZ input, enter the complete pathname to delete a file in PiCPro.

With a subdirectory, Without a subdirectory,  
**PICPRO:c:\sub\filename.ext\$00**    or    **PICPRO:c:filename.ext\$00**

Or enter the following to delete a file on the RAMDISK.

With a subdirectory, Without a subdirectory,  
**RAMDISK:sub\filename.ext\$00**    or    **RAMDISK:filename.ext\$00**

An empty subdirectory can be deleted with the DELFIL function also.

NOTE: The DELFIL function block cannot be used with the FMSDISK.

---



---

## DINT2DW

*Double Integer to Double Word*

**Datatype/DINTCONV**

---



---

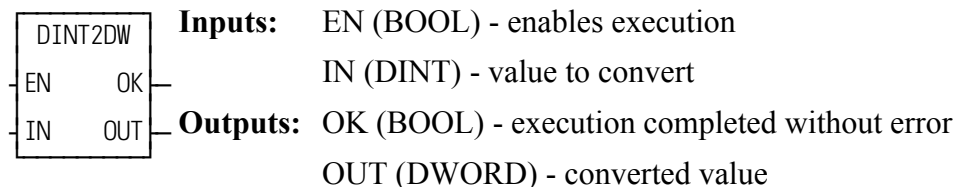

DINT2DW(IN := <<DINT>>, OK => <<BOOL>>, OUT => <<DWORD>>)

The DINT2DW function changes the data type of the value at IN from a double integer to a double word. The result is placed in the variable at OUT.

---



---

## DINT2INT

*Double Integer to Integer*

**Datatype/DINTCONV**

---



---

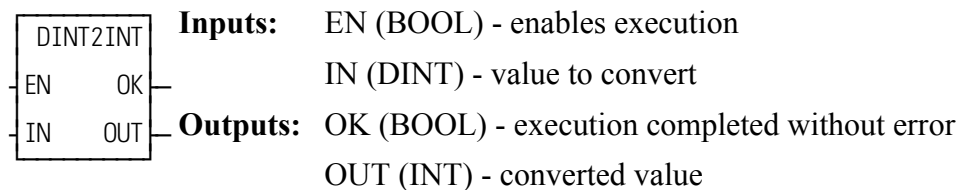

DINT2INT(IN := <<DINT>>, OK => <<BOOL>>, OUT => <<INT>>)

The DINT2INT function changes the data type of the value at IN from a double integer to an integer. The leftmost 16 bits of the double integer are truncated. The result is placed in the variable at OUT.

---



---

## DINT2LI

*Double Integer to Long Integer*

**Datatype/DINTCONV**

---



---

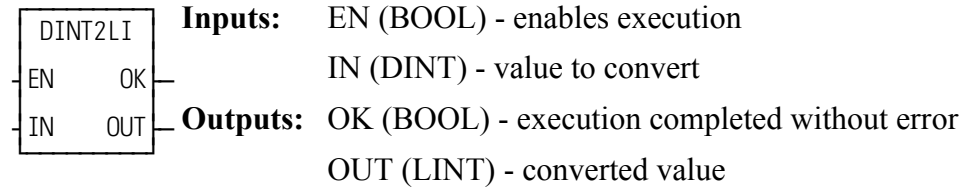

DINT2LI(IN := <<DINT>>, OK => <<BOOL>>, OUT => <<LINT>>)

The DINT2LI function converts a double integer into a long integer. The sign bit of the DINT is extended into the leftmost 32 bits of the long integer. The result is placed in a variable at OUT.

---



---

## DINT2RE

*Double Integer to Real*

**Datatype/DINTCONV**

---



---

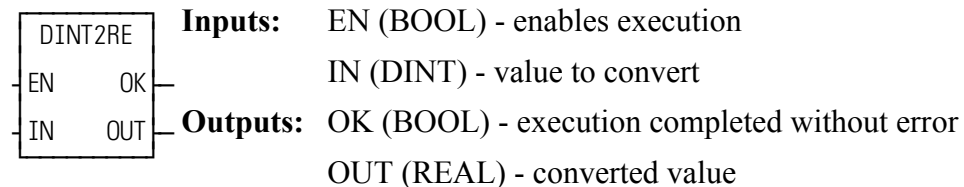

DINT2RE(IN := <<DINT>>, OK => <<BOOL>>, OUT => <<REAL>>)

The DINT2RE function converts a double integer into a real. The result is placed in a variable at OUT.

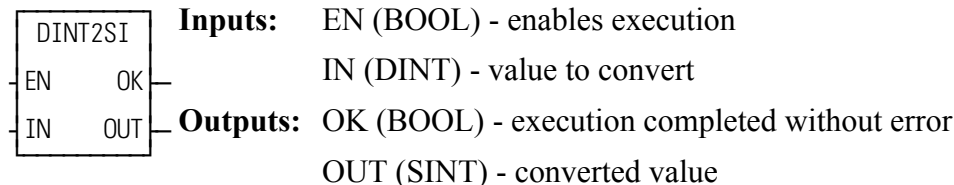
**DINT2SI***Double Integer to Short Integer***Datatype/DINTCONV**

DINT2SI(IN := <<DINT>>, OK => <<BOOL>>, OUT => <<SINT>>)

The DINT2SI function changes the data type of the value at IN from a double integer to a short integer. The leftmost 24 bits of the double integer are truncated. The result is placed in the variable at OUT.

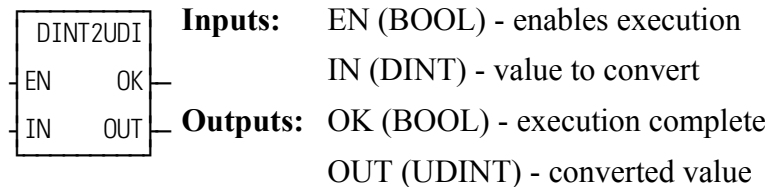
**DINT2UDI***Double Integer to Unsigned Double Integer***Datatype/DINTCONV**

DINT2UDI(IN := <<DINT>>, OK => <<BOOL>>, OUT => <<UDINT>>)

The DINT2UDI function changes the data type of the value at IN from a double integer to an unsigned double integer. The result is placed in the variable at OUT.



**DIRECT**

Directory

Io/COMM

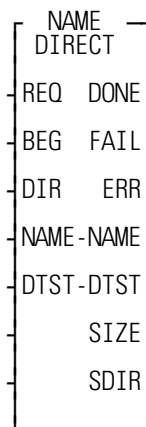

**Inputs:** REQ (BOOL) - enables execution (**One-shot**)  
 BEG (BOOL) - enable to start at beginning of directory. Disable to step through directory.  
 DIR (STRING) - a string containing the directory name  
 NAME (STRING) - (see below)  
 DTST (STRING) - (see below)

**Outputs:** DONE (BOOL) - energized if ERR = 0  
 not energized if ERR ≠ 0  
 FAIL (BOOL) - energized if ERR ≠ 0  
 not energized if ERR = 0  
 ERR (INT) - 0 if data transferred successfully  
 ≠ 0 if data transfer unsuccessful  
 NAME (STRING) - a string containing the filename  
 DTST (STRING) - a string containing the date/time string  
 SIZE (DINT) - gives the size of the file  
 SDIR (BOOL) - set if NAME output is a subdirectory

*See Appendix B in the PiCPro Online Help for error codes.*

```
<<INSTANCE NAME>>.DIRECT(REQ := <<BOOL>>, BEG := <<BOOL>>,
  DIR := <<STRING>>, NAME := <<STRING>>, DTST := <<STRING>>,
  DONE => <<BOOL>>, FAIL => <<BOOL>>, ERR => <<INT>>, NAME =>
  <<STRING>>, DTST => <<STRING>>, SIZE => <<DINT>>, SDIR
  :=<<BOOL>>);
```

The DIRECT function block allows you to read RAMDISK or FMSDISK file directory information from the ladder.

The directory name is entered at DIR using one of the formats shown below.

When using:	To list contents of a subdirectory, enter the name of the subdirectory at <b>sub</b> in the following:	To list the contents of the current directory, enter the following:	When the main directory is not the current directory and you want to list the contents of the main directory , enter the following:
<b>RAM-DISK</b>	<b>RAMDISK:sub\%00</b>	<b>RAMDISK:%00</b>	<b>RAMDISK:\*.*%00</b>
<b>FMSDISK</b>	<b>FMSDISK:sub\%00</b>	<b>FMSDISK:%00</b>	<b>FMSDISK:\*.*%00</b>

Set the BEG input in order to start at the beginning of the directory.

Transition the REQ input. This places the first file in NAME, the date/time in DTST, and the file size in SIZE. (SDIR is set when the name at the NAME output is a subdirectory.)

Turn the BEG off to step through the remaining files in the directory. When the last file is reached, you can go back to the beginning by setting BEG again.

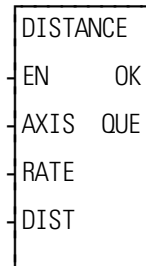
**DISTANCE***Distance***Motion/MOVE**

**Inputs:** EN (BOOL) - enables execution (**One-shot**)  
 AXIS (USINT) - identifies axis (servo or time)  
 RATE (UDINT) - feedrate at which motion occurs  
 (entered in LU/MIN)  
 DIST (DINT) - indicates incremental move distance  
 (entered in LU)

**Outputs:** OK (BOOL) - execution completed without error  
 QUE (USINT) - number of distance move for queue

```
DISTANCE(AXIS := <<USINT>>, RATE := <<UDINT>>, RATE :=
  <<UDINT>>, DIST := <<DINT>>, OK => <<BOOL>>, QUE => <<USINT>>)
```

The DISTANCE function moves an axis a specified distance at a specified feedrate. When the distance move is used with a time axis, the S\_CURVE function must be called first.

When used on a servo axis, the ACC/DEC will be a ramp, unless S-Curve interpolation is enabled via Servo-Setup or the WRITE\_SV function.

**DIV**

Divide

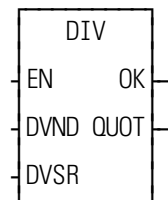
**Arith/ARITH**

**Inputs:** EN (BOOL) - enables execution  
 DVND (NUMERIC or TIME duration) - dividend  
 DVSR (same type as DVND if DVND is numeric;  
 DINT if DVND is TIME) - divisor

**Outputs:** OK (BOOL) - execution completed without error  
 QUOT (same type as DVND) - quotient

DIV(DVND := <<NUMERIC/TIME>>, DVSR := <<NUMERIC/DINT>>, OK  
 => <<BOOL>>, QUOT => <<NUMERIC/TIME>>)

The DIV function divides the value of the variable or constant at DVND by the value of the variable or constant at DVSR, and places the result in the variable at QUOT. If there is a remainder it is not returned. See the MOD function.

X	DVND
$\div$ Y	DVSR
Z	QUOT

**DLS\_INIT**

Start and monitor DLS communications

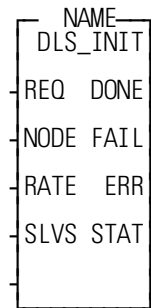
**Motion/DATA**

**Inputs:** REQ (BOOL) - starts initialization of DLS network (one-shot)  
 NODE (USINT) - the node number of this MMC for PC, 0 = Master, 1-7 = Slave  
 RATE (USINT) - SERCOS/DLS interrupt rate, 1-8 ms  
 SLVS (USINT) - bit array of returned slaves (not used on slave, Master only)

**Outputs:** DONE (BOOL) - energized if ERR = 0  
 not energized if ERR ≠ 0  
 FAIL (BOOL) - energized if ERR ≠ 0  
 not energized if ERR = 0  
 ERR (INT) - error number if function failed  
 STAT (INT) - initialization status

```
<<INSTANCE NAME>>:DLS_INIT(REQ := <<BOOL>>, NODE :=
  <<USINT>>, RATE := <<USINT>>, SLVS := <<USINT>>, DONE =>
  <<BOOL>>, FAIL => <<BOOL>>, ERR => <<INT>>, STAT => <<INT>>);
```

As Communication Master:

The role of this function block as a communication master is to define the node number and the interrupt rate, start the DLS communications and then monitor the communications to determine if all other MMC for PCs have also started up. When programmed in the ladder of an MMC for PC communication master, it will indicate the progress of the initialization of the slaves.

The ladder in the DLS master must receive a DONE set indication from DLS\_INIT prior to calling SERCOS initialization. The NODE input must be zero for a master, the RATE is the update rate of the communication and the SLVS input is a bit pattern indicating which slaves must be ready and operational in order for the DONE to be set. When the initialization of all slaves is complete, DONE will be set with ERR equal to zero. The top eight bits of the STAT output indicate the progress of individual slaves and the master.

Bit #	15	14-8	7	6	5	4	3	2	1	0
MMC for PC node yet to initialize	master	X	X	node 7	node 6	node 5	node 4	node 3	node 2	node 1

### As Communication Slave:

The role of this function block as a communication slave is to start the DLS communications and then monitor the communications to determine if all other MMC for PCs have also started interrupts.

The ladder in the DLS slave must receive a DONE set indication from DLS\_INIT prior to calling SERCOS initialization. When programmed in the ladder of an MMC for PC communication slave, it will indicate the progress of the initialization of the master and all other slaves. The inputs are the communication node of this slave (NODE), and the update rate (RATE). The SLVS input is not used in the slave MMC for PC. When the initialization of the master and all slaves is complete, DONE will be set with both STAT and ERR equal to zero. If the master is not yet initialized, bit 15 will be clear. The status of bit 14 indicates the progress of all slaves, but is only valid if bit 15 is set, indicating the master is initialized.

Bit #	15	14	13	12	11	10	9	8	5-7	0-4
MMC for PC node yet to initialize	master	all other slaves							master update rate	X

DLS\_INIT will report an error if the DLS module is not installed or the MMC for PC does not support DLS.

Possible errors returned by this Function Block are as follows:

Error No.	Description
1	Error with node number input
2	DLS board not present
3	Bad DLS Network link
4	Firmware not compatible (update your firmware)
5	Hardware not compatible (update MMC for PC)
6	Servos not running yet
7	Error with DLS communications
8	DLS rate error

**DLS\_RECV**

Read most recent send data from MMC for PC DLS Slave Master

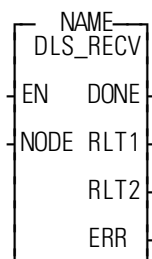
**Motion/DATA**

**Inputs:** EN (BOOL) - enables execution  
 NODE (USINT) - node to receive from

**Outputs:** OK (BOOL) - energized if ERR = 0  
 not energized if ERR ≠ 0

RLT1 (DWORD) - result 1

RLT2 (DWORD) - result 2

ERR (INT) - error number

```
<<INSTANCE NAME>>:DLS_RECV(EN := <<BOOL>>, NODE :=
  <<USINT>>, DONE => <<BOOL>>, RLT1 => <<DWORD>>, RLT2 =>
  <<DWORD>>, ERR => <<INT>>);
```

As Communication Master:

When programmed in the ladder of an MMC for PC communication master, this function block will read the most recent send data from the MMC for PC slave indicated by NODE. NODE is the communication slave number (from 0-7) used in the DLS\_INIT function in the slave ladder.

As Communication Slave:

When programmed in the ladder of an MMC for PC communication slave, this function will read the most recent broadcast of data from the MMC for PC master. NODE must be set to 0 when receiving broadcast data from the master.

Possible errors returned by this Function Block are as follows:

Error No.	Description
1	Error with node number input
2	DLS board not present
3	Bad DLS Network link
4	Firmware not compatible (update your firmware)
5	Hardware not compatible (update MMC for PC)
6	Servos not running yet
7	Error with DLS communications
8	DLS rate error

Note: RLT1 and RLT2 will be from the same ladder scan on the Remote node.

**DLS\_SEND**

Send data to DLS Slave/Master

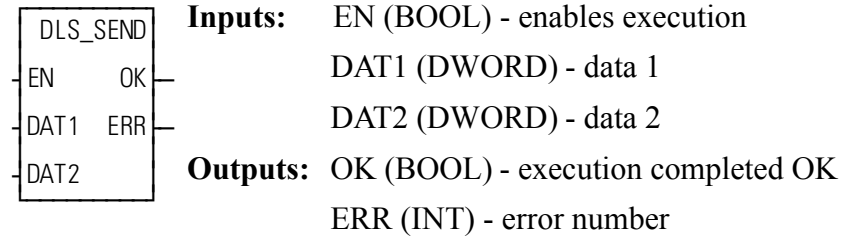
**Motion/DATA**

```
DLS_SEND(DAT1 := <<DWORD>>, DAT2 => <<DWORD>>, OK =>
  <<BOOL>>, ERR => <<INT>>);
```

As Communication Master:

When programmed in the ladder of an MMC for PC communication master, this function will broadcast the value of DATA to all communication slaves. This function may be called in the ladder task or the servo task. The data stored by this function is buffered in hardware and will be sent on the following update.

As Communication Slave:

When programmed in the ladder of an MMC for PC communication slave, this function will send the value of DATA to the communication master. This function may be called in the ladder task or the servo task. The data stored by this function is buffered in hardware and will be sent on the following update.

Possible errors returned by this Function Block are as follows:

Error No.	Description
1	Error with node number input
2	DLS board not present
3	Bad DLS Network link
4	Firmware not compatible (update your firmware)
5	Hardware not compatible (update MMC for PC)
6	Servos not running yet
7	Error with DLS communications
8	DLS rate error



---



---

## DLS\_STAT

Indicate bit array of DLS status and communication errors

**Motion/DATA**

---



---

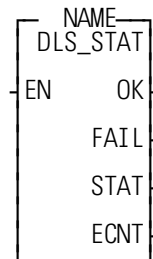

**Inputs:** EN (BOOL) - starts initialization of DLS network (one-shot)

**Outputs:** OK (BOOL) - energized if execution completed  
 FAIL (BOOL) - execution failed  
 STAT (INT) - bit array of slaves present/error code  
 ECNT (INT) - number of COMMO errors since initialization

```
<<INSTANCE NAME>>:DLS_STAT(EN := <<BOOL>>, OK => <<BOOL>>,
  FAIL => <<BOOL>>, STAT => <<INT>>, ECNT => <<INT>>);
```

As a Communication Master:

When programmed in the ladder of an MMC for PC communications master, STAT will contain a bit array of all slaves communicating. ECNT will contain the number of communications errors that have occurred.

The communication error count is the number of CRC errors that corrupted master data since servo initialization, as well as lost or missed packets.

As a Communication Slave:

When programmed in the ladder of an MMC for PC communication slave, STAT will be non-zero if the master is communicating. ECNT will contain the number of communication errors that have occurred.

---



---

## DPOSMODE

Digital Drive Position Mode

**Motion/MOVE**

---



---

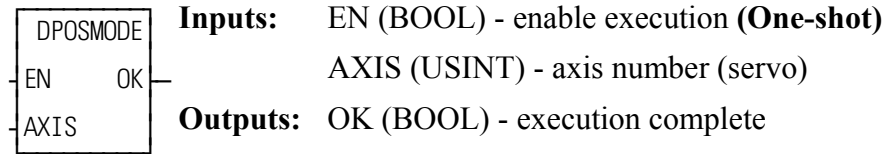

DPOSMODE(AXIS := <<USINT>>, OK => <<BOOL>>);

The DPOSMODE function will switch the digital drive to Position Mode. The axis number is specified by the AXIS input. This function will perform a smooth transition to Position Mode from Torque Mode or Velocity Mode. The MMCD defaults to Position Mode. This function is only applicable to an MMCD system.

---

---

**DRSETFLT***Reset Digital Drive Faults***Motion/INIT**

---

---

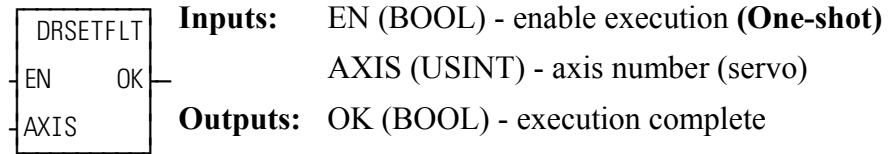

```
DRSETFLT(AXIS := <<USINT>>, OK => <<BOOL>>);
```

The DRSETFLT function will command the digital drive, specified by the AXIS input, to reset the drive faults. This function is only applicable to an MMCD system.

**DSTRTSRV**

Digital Start Servo

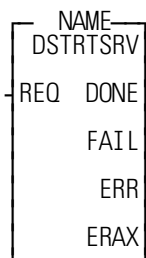
**Motion/INIT**

**Inputs:** REQ (BOOL) - enable execution (**One-shot**)

**Outputs:** DONE (BOOL) - initialization complete

FAIL (BOOL) - initialization failed

ERR (INT) - error code

ERAX (INT) - axis number of the axis in error if

ERR = 10, 11, 12, or 13

DSTRTSRV(REQ := <<BOOL>>, DONE => <<BOOL>>, FAIL => <<BOOL>>, ERR => <<INT>>, ERAX => <<INT>>);

The DSTRTSRV function block will initialize the axes of an MMCD system. All other CPUs should use STRTSERV. The user-defined servo setup function must be executed prior to executing DSTRTSRV. After DSTRTSRV completes successfully, all axes are initialized, the servo interrupts are running, and any axis-related functions or function blocks can now be executed. A typical method for programming the user-defined servo setup function and DSTRTSRV is shown below.

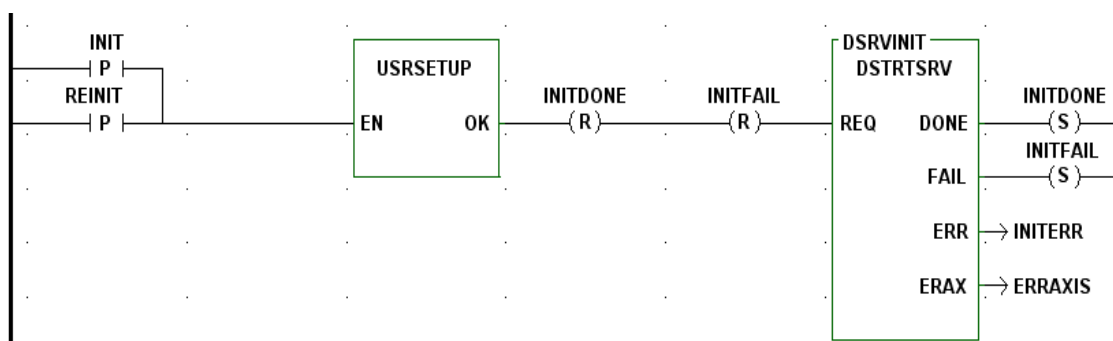

The DONE output will be energized when the axis initialization completes successfully. The FAIL output indicates a failure occurred attempting to initialize the axes. The ERR output will indicate the error. The possible values for ERR are listed in Table 2-14 Servo Initialization Errors. If the ERR output is 10, 11, 12, or 13, the ERAX output will indicate which axis is in error. Otherwise, the ERAX output will be 0.

**Note:** If a Digital Drive Communication Error E-Stop 800H occurs, DSTRTSRV must be called again to reset the E-stop and restart communication with the digital drives. E\_RESET will not reset this E-stop.

---



---

## DT2DATE

Date and Time to Date

Datatype/D\_TCONV

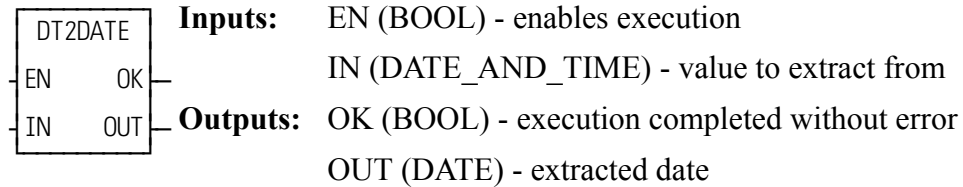

DT2DATE(IN := <<DATE\_AND\_TIME>>, OK => <<BOOL>>, OUT => <<DATE>>)

The DT2DATE function extracts the DATE from the DATE\_AND\_TIME value in the variable or constant at IN, and places it into the variable at OUT. Any time values (hours, minutes, seconds) are truncated.

### Example of DATE\_AND\_TIME to DATE

Var at IN	Value at OUT
DT#1993-05-13:00:37:44	D#1993-05-13

---



---

## DT2STR

Date and Time to String

Datatype/D\_TCONV

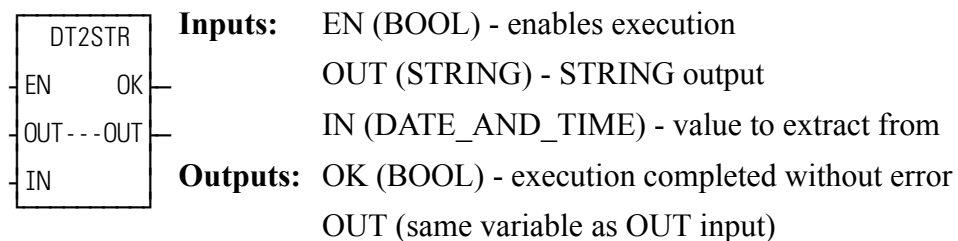

DT2STR(OUT := <<STRING>>, IN := <<DATE\_AND\_TIME>>, OK => <<BOOL>>, OUT => <<STRING>>)

The DT2STR function converts the value in the variable or constant at IN into a STRING, and places the result in the variable at OUT.

### Example of DATE\_AND\_TIME to STRING

Var at IN	Value at OUT
DT#1993-05-13:00:37:44	1993-05-13:00:37:44

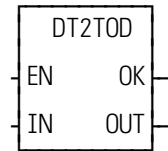
**DT2TOD***Date and Time to Time of Day***Datatype/D\_TCONV**

**Inputs:** EN (BOOL) - enables execution  
 IN (DATE\_AND\_TIME) - value to extract from

**Outputs:** OK (BOOL) - execution completed without error  
 OUT (TIME\_OF\_DAY) - extracted value

DT2TOD(IN := <<DATE\_AND\_TIME>>, OK => <<BOOL>>, OUT => <<TIME\_OF\_DAY>>)

The DT2TOD function extracts the TIME\_OF\_DAY from the variable or constant at IN, and places the result in the variable at OUT. Any date values (year, month, day) are truncated.

**Example of DATE\_AND\_TIME to TIME\_OF\_DAY**

Var at IN	Value at OUT
DT#1993-05-13:00:37:44	TOD#00:37:44

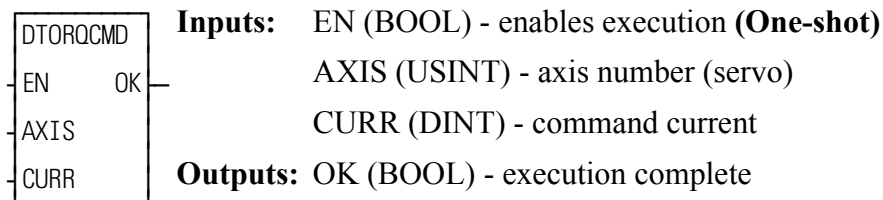
**DTORQCMD***Digital Drive Torque Mode Command***Motion/MOVE**

```
DTORQCMD(AXIS := <<USINT>>, CURR := <<DINT>>, <<OK =>
  <<BOOL>>)
```

The DTORQCMD function will issue a command current to a digital drive in Torque Mode. The axis number is specified by the AXIS input. The command current is specified by the CURR input in units of 0.01 amps. For example, a value of 3475 at the CURR input would command 34.75 amps. The CURR input must be in the range of [-25500, 25500]. If the digital drive is not in Torque Mode, this function will switch the digital drive to Torque Mode and immediately apply the current specified at CURR. To provide a smooth transition to Torque Mode from either Position Mode or Velocity Mode, the ladder should specify, at CURR, the value returned from READ\_SV Variable 73 "Digital Drive Current". This function is only applicable to an MMCD system.

**Note:** When switching from Position Mode to Torque Mode, all Position Mode moves in the queue will be aborted similar to executing an ABRTALL. While in Torque Mode, any attempts by the ladder to queue a Position Mode move (i.e. DISTANCE, POSITION, RATIO\_GR, etc.) will be ignored and the OK output will not be energized.

**Note:** If DTORQCMD is called while the loop is open, the OK output will be energized, the digital drive will switch to Torque Mode if it's not currently in Torque Mode, and the command current will remain zero regardless of the value at CURR.

---



---

## DVELCMD

Digital Drive Velocity Mode Command

**Motion/MOVE**

---



---

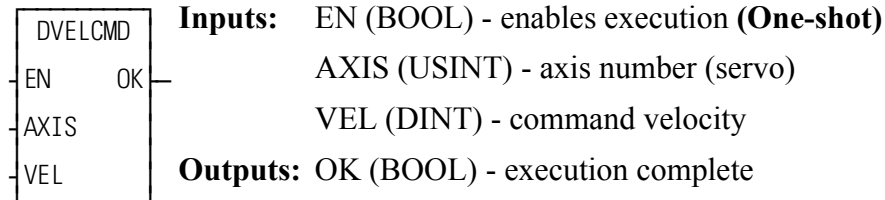

DVELCMD(AXIS := <<USINT>>, VEL := <<DINT>>, <<OK => <<BOOL>>)

The DVELCMD function will issue a command velocity to a digital drive in Velocity Mode. The axis number is specified by the AXIS input. The command velocity is specified by the VEL input in RPM (motor revolutions / minute). The VEL input must be in the range [-32768, 32767]. If the digital drive is not in Velocity Mode, this function will switch the drive to Velocity Mode and immediately apply the command velocity specified at VEL. To provide a smooth transition to Velocity Mode from either Position Mode or Torque Mode, the ladder should specify, at VEL, the value returned from READ\_SV Variable 89 "Digital Drive Predicted Command Velocity". This function is only applicable to an MMCD system.

**Note:** When switching from Position Mode to Velocity Mode, all Position Mode moves in the queue will be aborted similar to executing an ABRTALL. While in Velocity Mode, any attempts by the ladder to queue a Position Mode move (i.e. DISTANCE, POSITION, RATIO\_GR, etc.) will be ignored and the OK output will not be energized.

**Note:** If DVELCMD is called while the loop is open, the OK output will be energized, the digital drive will switch to Velocity Mode if it's not currently in Velocity Mode, and the command velocity will remain zero regardless of the value at VEL.

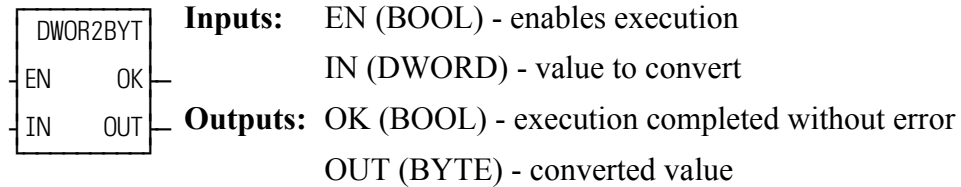

**DWORD2BYT***Double Word to Byte***Datatype/DWORDCNV**

DWOR2BYT(IN := <<DWORD>>, OK => <<BOOL>>, OUT => <<BYTE>>)

The DWOR2BYT function changes the data type of the value at IN from a double word to a byte. The leftmost 24 bits of the double word are truncated. The result is placed in the variable at OUT.

---



---

## DWOR2DI

*Double Word to Double Integer*

**Datatype/DWORDCNV**

---



---

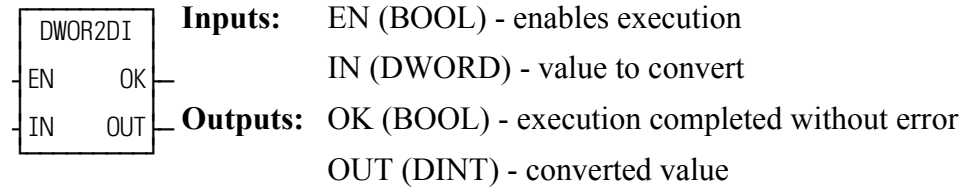

DWOR2DI(IN := <<DWORD>>, OK => <<BOOL>>, OUT => <<DINT>>)

The DWOR2DI function changes the data type of the value at IN from a double word to a double integer. The result is placed in the variable at OUT.

---



---

## DWOR2LW

*Double Word to Long Word*

**Datatype/DWORDCNV**

---



---

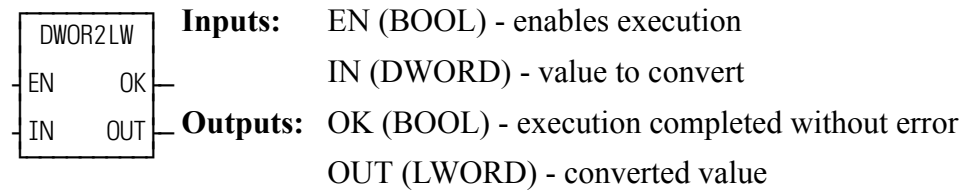

DWOR2LW(IN := <<DWORD>>, OK => <<BOOL>>, OUT => <<LWORD>>)

The DWOR2LW function converts a double word into a long word. The left-most 32 bits of the long word are filled with zeros. The result is placed in a variable at OUT.

---



---

## DWOR2RE

*Double Word to Real*

**Datatype/DWORDCNV**

---



---

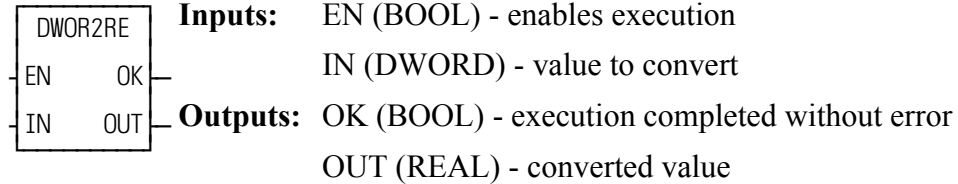

DWOR2RE(IN := <<DWORD>>, OK => <<BOOL>>, OUT => <<REAL>>)

The DWOR2RE function converts a double word into a real. The result is placed in a variable at OUT.

---



---

## DWOR2UDI

*Double Word to Unsigned Double Integer*

**Datatype/DWORDCNV**

---



---

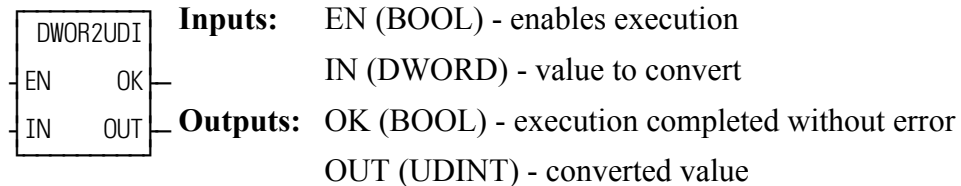

DWOR2UDI(IN := <<DWORD>>, OK => <<BOOL>>, OUT => <<UDINT>>)

The DWOR2UDI function changes the data type of the value at IN from a double word to an unsigned double integer. The result is placed in the variable at OUT.

---



---

## DWOR2WO

Double Word to Word

**Datatype/DWORDCNV**

---



---

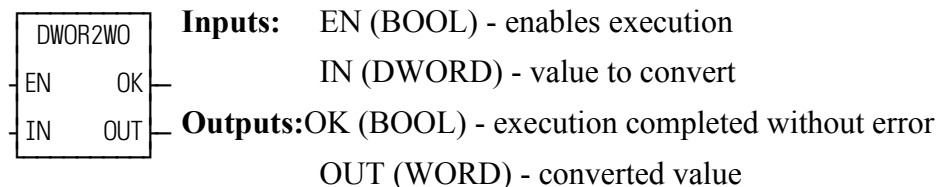

DWOR2WO(IN := <<DWORD>>, OK => <<BOOL>>, OUT => <<WORD>>)

The DWOR2WO function changes the data type of the value at IN from a double word to a word. The leftmost 16 bits of the double word are truncated. The result is placed in the variable at OUT.

---



---

## D\_TOD2DT

Concatenate Date and Time of Day

**Datatype/D\_TCONV**

---



---

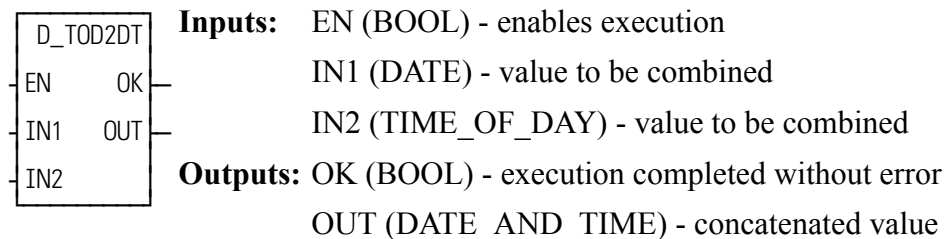

D\_TOD2DT(IN1 := <<DATE>>, IN2 := <<TIME\_OF\_DAY>>, OK => <<BOOL>>, OUT => <<DATE\_AND\_TIME>>)

The D\_TOD2DT function concatenates (combines) the value of the variable or constant at IN1 with the value of the variable or constant at IN2. The result is a DATE\_AND\_TIME value that is placed in the variable at OUT.

### Example of concatenate DATE and TIME\_OF\_DAY

Var at IN	Value at IN2	Value at OUT
D#1995-01-02	TOD#03:04:05	DT#1995-01-02-03:04:05

**EQ**

Equal To

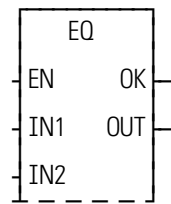
**Evaluate/EQ****Inputs:** EN (BOOL) - enables execution

IN1 (ANY except BOOL or STRUCT) - value to be compared

IN2...IN17 (same type as IN1) - value to be compared

**Outputs:** OK (BOOL) - execution completed without error

OUT (BOOL) - indicates if values are equal

EQ(IN1 := <<ANY>>, IN2 := <<ANY>>, IN1 := <<ANY>>, IN2 := <<ANY>>, IN3 := <<ANY>> ... IN17 := <<ANY>>, <<OK => <<BOOL>>, OUT => <<BOOL>>)

This is an extensible function which can compare up to 17 inputs.

If all the input values at IN1, IN2, ... IN17 are equal, the coil at OUT is energized. If one or more values are not equal, the coil at OUT is not energized.

The variable or constants at IN1 through IN17 are compared as follows:

IN1 is compared to IN2, then IN2 is compared to IN3, then IN3 is compared to IN4, ..., finally, IN16 is compared to IN17. If all of these comparisons are not equal, then the coil at OUT will be energized, otherwise the coil at OUT is not energized.

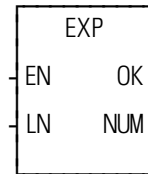
**EXP***Exponential***Arith/TRIG****Inputs:** EN (BOOL) - enables execution

LN (REAL/LREAL) - natural log value

**Outputs:** OK (BOOL) - execution completed without error

NUM (REAL/LREAL) - the number whose natural log is entered at LN

NOTE: The data types entered at LN and NUM must match, i.e. if LN is REAL, then NUM must be REAL.

EXP(LN := <<REAL/LREAL>>, OK => <<BOOL>>, NUM => <<REAL/LREAL>>)

The EXP function is the inverse of the LN function which calculates the natural log of a number.

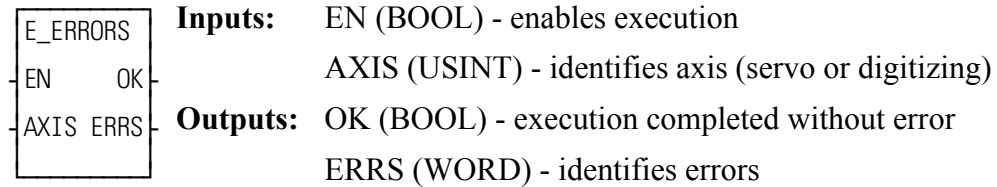
**E\_ERRORS***Emergency Errors***Motion/ERRORS**

E\_ERRORS(AXIS := <<USINT>>, OK => <<BOOL>>, ERRS => <<WORD>>)

The E\_ERRORS function returns 16 bits at the ERRS output that indicate what emergency-stop (E-stop) errors are currently active for the axis specified at the AXIS input. If there are no E-stop errors, ERRS will return 0. If there is an E-stop error, the uppermost bit (bit location 15) will be set indicating that an E-stop error exists plus one or more of the low 9 bits will be set indicating the type of E-stop error(s). Table 2-10 describes each of the E-stop errors represented by these bits. The **Hex Value** column shows the hexadecimal (and decimal) value that is returned at the ERRS output. Note that multiple E-stop bits could be set resulting in a value that is not listed in the table. For example, if an Excess Error E-stop and a User-set E-stop exist, bit locations 1 and 3 (and also 15) will be set, resulting in a returned value of 800A hexadecimal or 32778 decimal.

NOTE: If an E-stop error occurs using the stepper axis module, the command to the stepper will be zeroed. There is no loss of feedback or excess error with the stepper axis.

Table 2-10. Emergency Stop Errors.

Error	Description	Bit Location										Hex Value (Decimal) (in LDO)	
		8	7	6	5	4	3	2	1	0			
Digital Drive Communication Error	Two consecutive CRC errors were detected in the data transferred between the MMCD and the digital drive. This E-stop cannot be reset with E_RESET. The ladder must call DSTRTSRV again to restart communication and reset this E-stop.	E											8100 (33024)
Digital Drive Fault	A drive fault was reported from the digital drive	E											8080 (32896)
ASIU Update Error	The MMC-for-PC did not receive the servo update data from the ASIU in time			E									8040 (32832)
SERCOS error	Cyclic data synchronization error				E								8020 (32800)
SERCOS error	SERCOS drive E-stop - Status word bit 13 = 1.					E							8010 (32784)
User-set	The ladder called the E-stop function.						E						8008 (32776)
Overflow error	A slave delta overflow during runtime has occurred. This problem is most likely to occur if you are moving at a high rate of speed and/or the slave distance is very large compared to the master distance.  There are two conditions that can set this bit.  1. In FU, if the master moved position times the slave distance entered is greater than 31 bits.  2. In FU, if the $\frac{\text{mastermoved} \times \text{SDIS}}{\text{MDIS}}$ is greater than 16 bits.							E					8004 (32772)
Excess error	The Position Error has exceeded the Following Error limit.									E			8002 (32770)
Loss of feedback	A loss of feedback from the feedback device has occurred.										E		8001 (32769)



---



---

## E\_RESET

Emergency Stop Reset

Motion/ERRORS

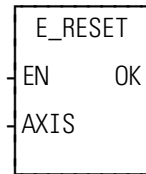

**Inputs:** EN (BOOL) - enables execution (**Typically one-shot**)

AXIS (USINT) - identifies axis (servo or digitizing)

**Outputs:** OK (BOOL) - execution completed without error

E\_RESET(AXIS := <<USINT>>, OK => <<BOOL>>)

The E\_RESET function resets the E-stop condition and all the errors that caused it. After an E-stop error occurs, you must always reset it. If the E-Stop being reset is a Resumable E-Stop (see READ\_SV Variable 63), the moves in the active and next queues will remain intact. If it is not a Resumable E-Stop, the active and next queues will be cleared.

**Note:** The E\_RESET function will close the loop if a CLOSLOOP function is executed before the E\_STOP.

**Note:** If the axis is a digital drive servo axis, E\_RESET will also reset the digital drive faults.

**Note:** E\_RESET will not reset a Digital Drive Communication Error E-stop 8100H. The ladder must call DSTRTSRV again to reset this E-stop and restart communication.

---



---

## E\_STOP

Emergency Stop

Motion/ERRORS

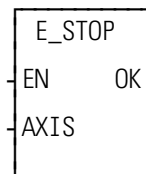

**Inputs:** EN (BOOL) - enables execution (**Typically one-shot**)

AXIS (USINT) - identifies axis (servo)

**Outputs:** OK (BOOL) - execution completed without error

E\_STOP(AXIS := <<USINT>>, OK => <<BOOL>>)

The E\_STOP function will open the servo loop and zero the analog output.

If Resumable E-Stop Allow is set (Servo Setup or WRITE\_SV Variable 63), this function will also cause the axis to go into Resume Mode. See READ\_SV Variable 63 & 64, RESMODE?, and RESUME.

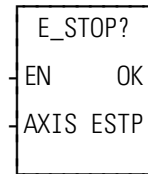
**E\_STOP?***Emergency Stop?***Motion/ERRORS****Inputs:** EN (BOOL) - enables execution

AXIS (USINT) - identifies axis (servo or digitizing)

**Outputs:** OK (BOOL) - execution completed without error

ESTP (BOOL) - indicates an E-stop is active when set

E\_STOP(AXIS := <<USINT>>, OK => <<BOOL>>, ESTP => <<BOOL>>)

The E\_STOP? function asks if there is a E-stop in effect for this axis.

**FAST\_QUE**

Fast Input Queue

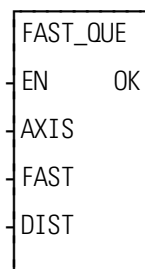
**Motion/QUE**

**Inputs:** EN (BOOL) - enables execution (**One-shot**)

AXIS (USINT) - identifies axis to be affected by the fast input (servo)  
This can either be the same axis as FAST or a second axis.

FAST (USINT) - identifies axis with fast input  
NOTE: Fast input on axis feedback required.  
NOTE: Entering a zero will cancel the FAST\_QUE's holding mode

DIST (DINT) - the distance the fast input axis must travel *after* the fast input occurs (entered in LU)  
Range of  $\pm 4,194,303$  FU (A "0" may be entered if no distance needs to be covered by the fast input axis.)  
NOTE: A programming error will be generated if the axis moves more than 65,535 FU in the opposite direction of what is entered at DIST.

**Outputs:** OK (BOOL) - execution completed without error

FAST\_QUE (AXIS := <<USINT>>, FAST := <<USINT>>, DIST := <<DINT>>, OK => <<BOOL>>)

The FAST\_QUE function allows you to manage the queues based on the occurrence of a fast input to the feedback module for an axis.

**SERCOS NOTE:** The function block SCA\_PBIT must be called and completed successfully prior to calling the FAST\_QUE function with a SERCOS axis.

This function can be used to:

1. Start a move
2. Go from one move to another  
If the first move completes before the fast input occurs, the second move will begin just as if the FAST\_QUE function had not been called.
3. End a move  
If the fast input does not occur, the move will end in the normal way.

Using the fast input to trigger one of the above provides a faster response time than is possible when managing the queues from the ladder.

The update rate entered in setup for the axis identified at AXIS and the axis identified at FAST must be the same.

NOTE: An internal bit remains on for eight updates after a fast input event occurs. If the FAST\_QUE is called during those eight updates, the bit is ignored until it changes state again. Therefore, to ensure that you do not miss a fast input event, there should always be nine or more updates between events. (One iteration equals eight updates.)

When the FAST\_QUE is called, a “holding” mode for any of the three actions is in effect until the following two conditions are met:

- The fast input on the axis identified at FAST occurs.
- The FAST axis has moved the designated distance entered at DIST.

The holding mode is cleared when both of these conditions are met and it is then possible to manipulate the moves in the queue(s) in one of the following ways.

#### TO START A MOVE:

**Step 1.** Call the FAST\_QUE function.

**Step 2.** Put the move to occur on the fast input in the active queue.

The move will start after the fast input occurs and the FAST axis has moved the specified distance. If the fast input occurs before the FAST\_QUE is called, it will be ignored. You must call the FAST\_QUE before the fast input occurs.

#### TO MOVE FROM ONE MOVE TO ANOTHER:

**Step 1.** Put the first move in the active queue. It will begin.

**Step 2.** Call the FAST\_QUE function.

**Step 3.** Put the second move in the next queue.

The first move will be aborted and the second move will begin after the fast input occurs and the fast input axis has moved the specified distance. Again, the FAST\_QUE function must be called before the fast input occurs or it will be ignored until the next fast input.

#### TO END A MOVE:

**Step 1.** Put the move in the active queue. It will begin.

**Step 2.** Call the FAST\_QUE function.

The move will end when the fast in occurs and the axis moves the distance entered at DIST. Do not put any move in the next queue until after the fast input occurs. If you do, the second move will begin when the fast input occurs as described above.

A programming error (P\_ERRORS function) will occur on the axis identified at AXIS on the FAST\_QUE function if the fast axis travels in the wrong direction more than 65,535 FU. If the axis continued to move in the wrong direction, a move could be started unexpectedly.

It is important that you ensure this does not occur. Do this by programming an ABORTALL function at the occurrence of this programming error to remove all moves from the queues.

The programming error must be reset with the P\_RESET function.

**Note:** The move will travel the distance specified in DIST and then you abort the move. The total distance traveled beyond the fast input will equal the DIST value plus whatever distance it takes to decel.

The holding mode can be cancelled by calling the FAST\_QUE function with a zero on the function input labeled “FAST”. Cancelling the holding mode will cause the axis to behave as if no FAST\_QUE had been called. Note that if a queued move is waiting on a fast input to begin, canceling the holding mode will cause the move to begin.

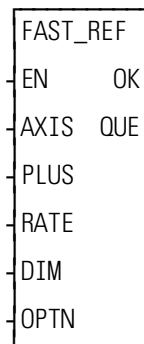
**FAST\_REF***Fast Input Reference (Machine Reference)***Motion/REF**

- Inputs:**
- EN (BOOL) - enables execution (**One-shot**)
  - AXIS (USINT) - identifies axis (servo or digitizing)  
NOTE: Fast input on axis feedback required.
  - PLUS (BOOL) - indicates direction of motion to reference switch
  - RATE (UDINT) - feedrate at which motion occurs (entered in LU/MIN)
  - DIM (DINT) - reference dimension for the nearest resolver null or the next encoder index mark after the fast input occurs. It is entered in LU. If DIM is outside the range of -536,870,912 to 536,870,911 FU, the OK will not be set.
  - OPTN (WORD) - provides referencing options
- Outputs:**
- OK (BOOL) - execution completed without error
  - QUE (USINT) - number of reference move for queue

```
FAST_REF(AXIS := <<USINT>>, PLUS := <<BOOL>>, RATE := <<UDINT>>,
  DIM := <<DINT>>, OPTION := <<WORD>>, OK => <<BOOL>>, QUE =>
  <<USINT>>)
```

The fast input reference is a machine reference. It will cause a servo axis to move in the direction (PLUS) and at the feedrate (RATE) specified to the reference switch. The reference switch is connected to the fast input on the feedback module. When the switch closes, the position of the axis is recorded based on the nearest null of the resolver or the next index mark of the encoder. The value entered at DIM is assigned to this position. If the axis is a digitizing axis or if “no motion” has been selected at OPTN (see below), this function does not cause motion. You must use other methods of moving the axis to the reference switch. The inputs PLUS and RATE are ignored when no motion is selected.

A fast reference done with the FAST\_REF function monitors the axis until a fast input on the feedback module occurs. How the fast input responds is defined by variable 19 in the WRITE\_SV function. The default is to respond to the rising edge. In contrast, the ladder reference (see LAD\_REF and REF\_END functions) monitors the axis until the REF\_END function is called in your ladder program.

When using a SERCOS axis, the function block SCA\_RFIT must be called and completed successfully prior to calling the FAST\_REF function.

**Note:** If an encoder is the feedback device, the axis will continue to move after the switch closes until the next index mark is seen.

The OPTN input provides the following options:

Option	Binary value	Hex value
1. Ignore index/null	00000000 00000001	0001
2. No motion	00000000 00000010	0002
3. Null setup	00000000 00000100	0004

If no option is desired, enter a “0.”

## Option inputs

### Ignore the index/null

Choosing this option allows a reference to occur which ignores the index mark of an encoder or the null of a resolver during the reference cycle. If bit 0 is set to “1,” the reference position assigned by DIM will be assigned to the position the axis is at when the fast input makes its transition.

With an encoder, the axis will stop immediately after the fast input transitions. The axis does not continue movement until the index mark is reached. NOTE: This makes the reference switch position given with the READ\_SV function invalid. With a resolver, the reference switch position available with the READ\_SV function is valid.

### No motion

The no motion option allows a reference to occur without any motion. The axis is put into a mode whereby it is watching for the conditions of a reference cycle. Even though no move is placed in the queue, a queue must be available. A move will be initiated by the ladder following the reference cycle.

Once the call is made, the reference complete flag goes low until the fast input occurs and the index mark (unless “ignore index” option is active) is received. The reference complete flag goes high once these events occur and the axis position takes on the reference value at DIM.

If the move type is VEL, RATIO\_GR, LAD\_REF, or FAST\_REF, the new axis position assigned by the no-motion reference has no effect on the move itself. With a DISTANCE move, the actual distance covered will be the same. If a no-motion reference occurs during a position move, the endpoint will be reached.

If a no-motion reference is used during a RATIO\_PRO move, the lock on point of the slave axis to the master axis may be undefined. This is not recommended.

**Note:** A fast reference can also be performed on a digitizing axis. You must cause the axis to move and the fast input to occur. Use variable 29 with the READ\_SV function to read the reference switch position. REF\_DNE? can also be used with digitizing axes.

**Null Setup**

This option will establish a null position for a digital drive axis with resolver feedback or single-turn Stegmann encoder feedback in addition to performing the fast reference. The null position will be stored in the digital drive's flash memory and will be retained through power cycles. This feature allows the user to omit the setup process of physically positioning the reference switch to be near the null. To provide repeatable references, this option bit should be set with the first call to FAST\_REF and should be reset for subsequent calls.



## Setting up a machine reference switch

A reference switch is needed for each axis requiring a machine reference. When the switch is tripped, the position of the axis is indicated by the signal from the feedback device coupled to the axis. The PiC references to the nearest null of a resolver or the next index mark of an encoder. If the switch is improperly placed in relation to the feedback device, a reference could take place that was one revolution off of the previous reference. To ensure that you will always get an accurate repeatable reference, there are certain factors to keep in mind when setting up the reference switch:

- With encoders - the software calculations assign the reference value of the function to the first index mark following switch closure. The reference switch should be positioned so that the count bandwidth is within the range of 25 to 75% of the total count. If the total count is 1000 per rev, the switch location should be between 250 and 750 counts. See A in Referencing positions for encoders and resolvers below.
- With resolvers - the software calculations assign the reference value of the function to the nearest null following the switch closure. The reference switch should be positioned so that the count is greater than 3000 or less than 1000. The switch location is incorrect if the resolver signal is between 10001 and 2999. See Figure 2-5 below.

**Figure 2-5. Referencing positions for encoders and resolvers**

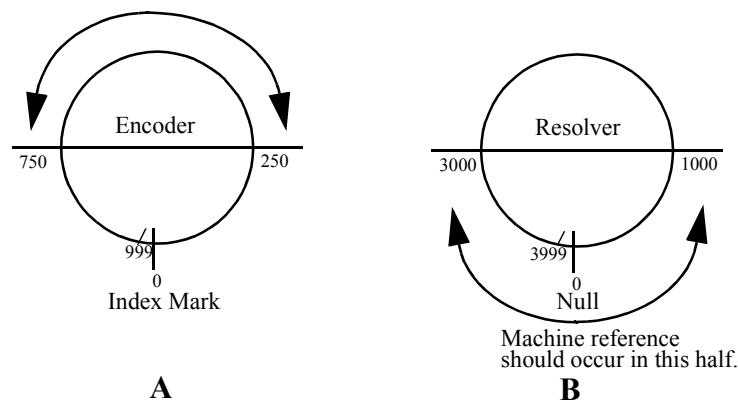

Note that the referencing position is in different halves for the encoder and resolver. That is because the encoder references to the *next* index mark and you want to avoid referencing in the same half of the encoder revolution as the index mark. The resolver references to the *nearest* null so you want to avoid referencing around the half-rev point.

- After a machine reference is completed, the READ\_SV function (see servo data functions) can be used to read the reference switch position after the switch closes by entering variable 29 in the VAR input and viewing the RSLT output (in feedback units) in PiCPro. An encoder reference switch position is the distance between the switch closure and the index mark. A resolver reference switch position is the position of the resolver when the switch is closed.

If the reference switch position read from the READ\_SV function is between 25% and 75% for the total encoder count or less than 1000 or more than 3000 for a resolver, than your reference switch is positioned properly to ensure accurate, repeatable referencing. If the position read is outside of these ranges you can change the position of the feedback device when the switch transitions by either moving the reference switch or the feedback device. Perform the machine reference again and read the reference switch position to see if it is within the range.

#### NOTE

If in adjusting the location of the reference switch or the feedback device, you find that the result of variable 29 increases when you expect it to decrease after performing the machine reference, move the device in the opposite direction until the reading is acceptable.

One factor to keep in mind when performing a machine reference from the ladder with the LAD\_REF function is there can be a lag time between the actual closing of the reference switch and the software calculations. This is caused by up to 32 ms of update time and up to 200 ms of scan time. (200 ms is the maximum time limit for one scan before a loss of scan occurs.) This could affect the repeatability of your reference especially when referencing at high velocities.

The example which follows illustrates this. Assume an axis using resolver feedback is moving at a velocity of 50000 counts per minute (NOTE: 50000 C/MIN = .83333 C/ms). Looking at an example with the maximum update and scan time:  $(32 \text{ ms} + 200 \text{ ms}) * .83333 \text{ C/ms} = 193.333$  or 193 C. If the READ\_SV function gave a reading of 1000 C for the reference switch position, the actual position of the device when the switch closed could be up to 1193 counts (or 807 counts if referencing in the negative direction). By using a lower velocity, the number of counts is lowered. For example, if the velocity is 5000 C/MIN, then the count is as follows (NOTE: 5000 C/MIN = .08333 C/ms):  $(32 \text{ ms} + 200 \text{ ms}) * .08333 \text{ C/ms} = 193.33$  or 193 C.

The actual position of the reference could be up to 1019 counts (981 counts if referencing in the negative direction). When the machine reference is done using the fast input with the FAST\_REF function, the recording of the reference switch transition is not affected by what the ladder scan is executing at the time. There is virtually no lag between the time the reference occurs and the time it is recorded. This is a very accurate method of referencing. The only time consideration for the fast input is a short (50  $\mu\text{s}$ ) turn-on time.

**Note:** This function cannot be used with the stepper axis module.

## FB\_CLS

Field Bus Close

Fbinter/FB\_CLS

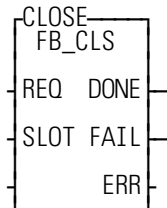

**Inputs:** REQ (BOOL) - enables execution (**one-shot**)  
 SLOT (USINT) - slot number (use same slot number entered for FB\_OPN)

**Outputs:** DONE (BOOL) - set when communications with the field bus are closed  
 FAIL (BOOL) - set if an error occurred  
 ERR (INT) - error number

```
<<INSTANCE NAME>>:FB_CLS(REQ := <<BOOL>>, SLOT := <<USINT>>,
    DONE => <<BOOL>>, FAIL => <<BOOL>>, ERR => <<INT>>);
```

The FB\_CLS function block is used to close communications with the Field Bus. You must call the FB\_OPN function block to re-establish field bus communications.

The ERR output will be ≠ 0 if an error occurred.

ERR#	Description	What to do/check
0	No error	
1	No Fieldbus module was found at the slot number entered at SLOT input.	Ensure that a Fieldbus module is installed in the correct slot.

# FB\_OPN

Field Bus Open

**Fbinter/FB\_OPN**

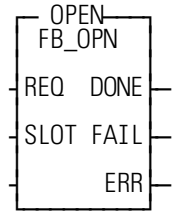

**Inputs:** REQ (BOOL) - enables execution (**one-shot**)  
 SLOT (USINT) - slot number (for PiC 3 - 13 main rack only available, for MMC for PC any value, for MMC 3 or 4)

**Outputs:** DONE (BOOL) - set when Fieldbus module is in RUN mode.  
 FAIL (BOOL) - set if an error occurred  
 ERR (INT) - error number

```
<<INSTANCE NAME>>:FB_OPN(REQ := <<BOOL>>, SLOT := <<USINT>>,
    DONE => <<BOOL>>, FAIL => <<BOOL>>, ERR => <<INT>>);
```

The FB\_OPN function block is used to open communications with the field bus placing the Fieldbus module in the RUN mode.

The ERR output will be ≠ 0 if an error occurred.

ERR#	Description	What to do/check
0	No error	
1	No Fieldbus module was found at the slot number entered at SLOT input.	Ensure that the Fieldbus module is installed in the correct slot.
2	No configuration file for this slot.	Ensure that you have a .UCT (configuration) file with the same name as your .LDO file.

---



---

## FB\_RCV

Field Bus Receive

**Fbinter/FB\_RCV**

---



---

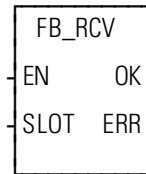

**Inputs:** EN (BOOL) - enables execution  
 SLOT (USINT) - slot number (use same slot number as entered for FB\_OPN)

**Outputs:** OK (BOOL) - execution completed without error  
 ERR (INT) - error number

FB\_RCV(SLOT := <<USINT>>, OK => <<BOOL>>, ERR => <<INT>>)

The FB\_RCV function receives all data from the configurator file indicated by Tag names.

The ERR output will be ≠ 0 if an error occurred.

ERR#	Description	What to do/check
0	No error	
1	No Fieldbus module was found at the slot number entered at SLOT input.	Ensure that the Fieldbus module is installed in the correct slot.

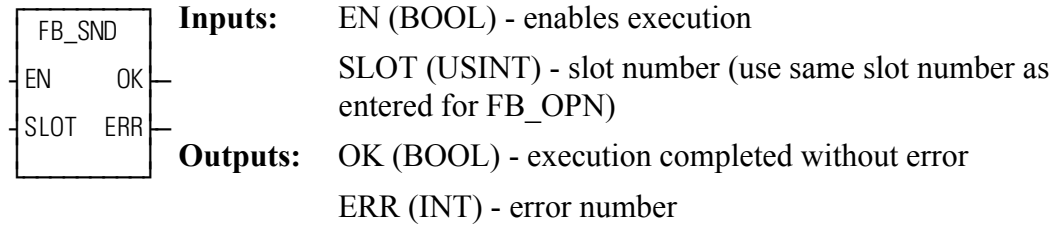
**FB\_SND***Field Bus Send***Fbinter/FB\_SND**

FB\_SND(SLOT := <<USINT>>, OK => <<BOOL>>, ERR => <<INT>>)

The FB\_SND function is used to send data indicated by Tag names in the configurator file.

The ERR output will be  $\neq 0$  if an error occurred.

ERR#	Description	What to do/check
0	No error	
1	No Fieldbus module was found at the slot number entered at SLOT input.	Ensure that the Fieldbus module is installed in the correct slot.

## FB\_STA

Field Bus Status

Fbinter/FB\_STA

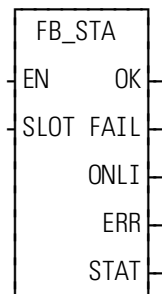

**Inputs:** EN (BOOL) - enables execution  
 SLOT (USINT) - slot number (use same slot number as entered for FB\_OPN)

**Outputs:** OK (BOOL) - execution completed without error  
 FAIL (BOOL) - set if an error occurred  
 ONLI (BOOL) - set if the Fieldbus module is communicating with nodes.  
 ERR (USINT) - number of error  
 STAT (DWORD) - status information

```
<<INSTANCE NAME>>.FB_STA(EN := <<BOOL>>, SLOT := <<USINT>>,
    OK => <<BOOL>>, FAIL => <<BOOL>>, ONLI => <<BOOL>>, ERR =>
    <<INT>>, STAT => <<DWORD>>);
```

The FB\_STA function block allows you to check if the Fieldbus module is communicating with nodes and to check field bus status information.

The ERR output will be ≠ 0 if an error occurred.

ERR#	Description	What to do/check
0	No error	
1	No Fieldbus module was found at the slot number entered at SLOT input.	Ensure that the Fieldbus module is installed in the correct slot.

The following tables define the value of status information that can appear at the STAT output based on the double word format shown below.

MSB	LSB2	LSB1	LSB0
NET_STATUS_FLAGS	NET_STATUS_CODE	IF_STATUS_FLAGS	IF_STATUS_CODE

**NET\_STATUS\_FLAGS**

NET\_STATUS\_FLAGS indicates various conditions related to the Fieldbus module network interface. Each Fieldbus module supports a subset of the status flags as appropriate.

Bit	Name	Description
0	Warning	The communication error warning threshold has been exceeded.
1	NO_POWER	Bus power is not present.
2	NO_BUS	Bus is not connected.
3 - 7		(Reserved)

**NET\_STATUS\_CODE**

NET\_STATUS\_CODE indicates the status of the Fieldbus module network interface. Each Fieldbus module supports a subset of the status codes as appropriate.

Value	Name	Description
00	OFFLINE	Network interface is offline.
01	OFFLINE_FAULT	Network interface is offline due to a network fault.
02	OFFLINE_BAD_CFG	Network interface is offline due to a configuration fault (invalid or duplicate station address, invalid baud rate, invalid DIP-switch data, etc.)
03	ONLINE	Network interface is online, no faults detected.
04	ONLINE_FAULT	Network interface is online, one or more network services has failed.
05	ONLINE_ACTIVE	Network interface is online and is exchanging data, no faults detected. Any failure of a secure service is reported.
06	ONLINE_IDLE	Network interface is online and is exchanging data, one or more services is receiving an idle indication, no faults detected.
07	ONLINE_INACTIVE	Network interface is online, one or more previously active services has been suspended, no faults detected.
08-0FFh		(Reserved)



**IF\_STATUS\_FLAGS**

IF\_STATUS\_FLAGS indicates various conditions related to the Fieldbus module end of the data exchange interface.

Bit	Name	Description
0	EVENT_LOST	An event was lost due to a full event queue. This flag is cleared when the data exchange interface is closed.
1 - 7		(Reserved)

**IF\_STATUS\_CODE**

IF\_STATUS\_CODE indicates various conditions related to the Fieldbus module data exchange interface.

Value	Name	Description
00	CLOSED	Data exchange interface is closed.
01	OPEN	Data exchange interface is open.
02	HEARTBEAT_FAULT	Data exchange interface is faulted due to heartbeat timeout. (Same behavior as closed.)
03h - 0FFh		(Reserved)

NOTE: FB\_XXX functions can be used with either a DeviceNet or Profibus network. Fieldbus is used as a generic term.

---



---

# FIND

Find

**String/FIND**

---



---

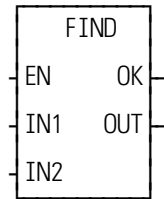

**Inputs:** EN (BOOL) - enables execution  
 IN1 (STRING) - STRING to search  
 IN2 (STRING) - STRING to find

**Outputs:** OK (BOOL) - execution completed without error  
 OUT (INT) - position

FIND(IN1 := <<STRING>>, IN2 := <<STRING>>, OK => <<BOOL>>, OUT => <<INT>>)

The FIND function is used to find a STRING that is contained in another STRING. It searches within the variable at IN1 for the first occurrence of the variable at IN2. If the STRING is found, the position of its first character is placed into the variable at OUT. If the STRING is not found a zero is placed in the variable at OUT.

An error occurs if:

Length of IN1 = 0

Length of IN2 = 0

Length of IN2 > length of IN1

### Example of find function

Var at IN1	Var at IN2	Var at OUT
string1 string2	ring	3

**FRESPACE**

Free Space

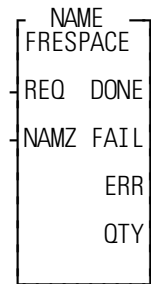
**IO/COMM**

**Inputs:** REQ (BOOL) - enables execution (**One-shot**)  
 NAMZ (STRING) - a string containing the complete pathname

**Outputs:** DONE (BOOL) - energized if ERR = 0  
 not energized if ERR ≠ 0

FAIL (BOOL) - energized if ERR ≠ 0  
 not energized if ERR = 0

ERR (INT) - 0 if data transferred successfully  
 ≠ 0 if data transfer unsuccessful

QTY (DINT) - number of bytes available on the RAMDISK or FMSDISK

*See Appendix B in the PiCPro Online Help for error codes.*

```
<<INSTANCE NAME>>:FRESPACE(REQ := <<BOOL>>, NAMZ :=
  <<STRING>>, DONE => <<BOOL>>, FAIL => <<BOOL>>, ERR =>
  <<INT>>, QTY => <<DINT>>);
```

The FRESPACE function block allows you to read at the QTY output how many bytes of memory are available on the RAMDISK or FMSDISK.

At the NAMZ input, enter the following to check the available free space on the RAMDISK or FMSDISK:

For RAMDISK    **RAMDISK:\$00**

For FMSDISK    **FMSDISK:\$00**

---



---

## FU2LU

*Feedback Units to Ladder Units*

**Motion/DATA**

---



---

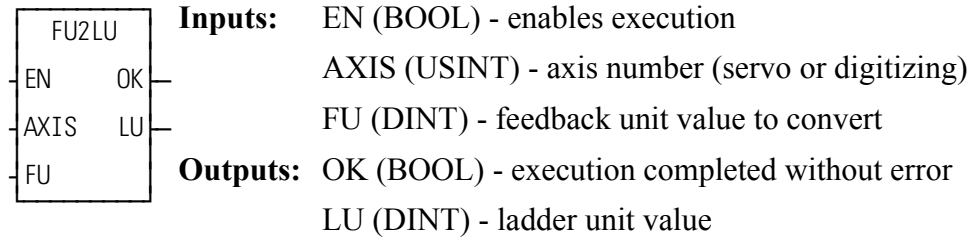

FU2LU(Axis := <<USINT>>, FU := <<DINT>>, OK => <<BOOL>>, LU => <<DINT>>)

The FU2LU function converts the feedback unit value at FU to its equivalent ladder unit value and places the result at LU.

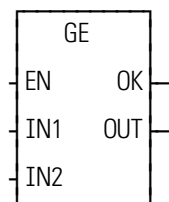
**GE***Greater Than or Equal To***Evaluate/GE**

**Inputs:** EN (BOOL) - enables execution  
 IN1 (ANY except BOOL or STRUCT) - value to be compared  
 IN2 (same type as IN1) - value to be compared

**Outputs:** OK (BOOL) - execution completed without error  
 OUT (BOOL) - indicates if values are greater than or equal to successive values

GE(IN1 := <<ANY>>, IN2 := <<ANY>>, OK => <<BOOL>>, OUT => <<BOOL>>)

The GE function compares the value of the variable or constant at IN1 with the value of the variable or constant at IN2. This is an extensible function which can compare up to 17 inputs.

**For the inputs at IN1, IN2, ...IN17**

If  $IN1 \geq IN2 \geq IN3 \geq \dots \geq IN17$ , the coil at OUT is energized.

Otherwise the coil at OUT is not energized.

---

---

**GETDAY***Get Day***Xclock/GETDAY**

---

---

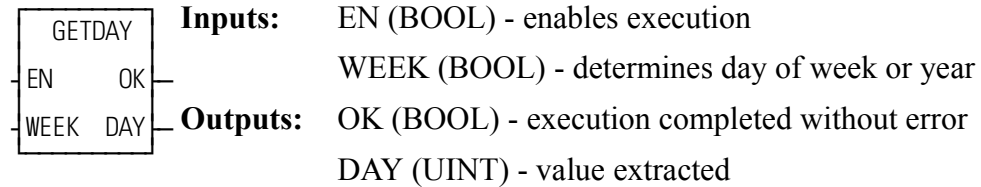

GETDAY(WEEK := <<BOOL>>, OK => <<BOOL>>, DAY => <<UINT>>)

The GETDAY function outputs the day of the week or the day of the year.

If power flow exists at WEEK, the (number of) the day of the week is output to the variable at DAY. The numbers 0 - 6 correspond to Sunday - Saturday.

If power flow does not exist at WEEK, the (number of) the day of the year is output to the variable at DAY. The numbers are from 1 - 365 or 366.

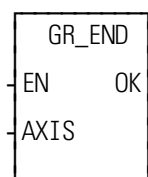
**GR\_END***Gear End***Motion/RATIOMOV****Inputs:** EN (BOOL) - enables execution (**One-shot**)

AXIS (USINT) - identifies axis (servo)

**Outputs:** OK (BOOL) - execution completed without error

GR\_END(AXIS := &lt;&lt;USINT&gt;&gt;, OK =&gt; &lt;&lt;BOOL&gt;&gt;)

The GR\_END function ends the ratio gear move. When it is called in the ladder, the slave axis will stop moving immediately with no ramping.

A ratio gear move may also be stopped by aborting the move:

- with no move in the queue. The ratio gear move will ramp down at the default deceleration rate and motion will stop.

OR

- with another move in the queue. The velocity will ramp to the new move rate and continue with the new move or the velocity will step and continue if a master/slave move is next.

NOTE: A gear ratio move may also be ended with a SYN\_END function. It is possible to specify the point at which the slave should drop out of synchronization with SYN\_END.

**GT**

Greater Than

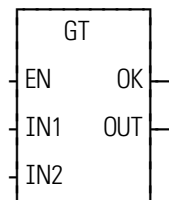
**Evaluate/GT**

- Inputs:** EN (BOOL) - enables execution  
 IN1 (ANY except BOOL or STRUCT) - value to be compared  
 IN2 (same type as IN1) - value to be compared
- Outputs:** OK (BOOL) - execution completed without error  
 OUT (BOOL) - indicates if values are greater than successive values

GT(IN1 := <<ANY>>, IN2 := <<ANY>>, OK => <<BOOL>>, OUT => <<BOOL>>)

The GT function compares the value of the variable or constant at IN1 with the value of the variable or constant at IN2. This is an extensible function which can compare up to 17 inputs.

**For the inputs at IN1, IN2, ...IN17**

If  $IN1 > IN2 > IN3 > \dots > IN17$ , the coil at OUT is energized.

Otherwise the coil at OUT is not energized.

**HOLD**

Feed Hold

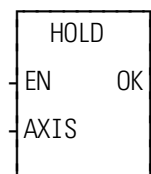
**Motion/MOVE\_SUP**

- Inputs:** EN (BOOL) - enables execution (**Typically one-shot**)  
 AXIS (USINT) - identifies axis (servo)
- Outputs:** OK (BOOL) - execution completed without error

HOLD(AXIS := <<USINT>>, OK => <<BOOL>>)

The HOLD function tells the iterator to stop iterating the current move on the specified axis. It will ramp down at the set decel rate. This function works with the distance, velocity, and position moves.



---

---

## HOLD\_END

*Feed Hold End*

**Motion/MOVE\_SUP**

---

---

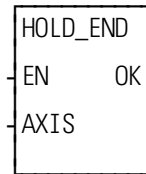

**Inputs:** EN (BOOL) - enables execution (**Typically one-shot**)

AXIS (USINT) - identifies axis (servo)

**Outputs:** OK (BOOL) - execution completed without error

HOLD(AXIS := <<USINT>>, OK => <<BOOL>>)

The HOLD\_END function tells the iterator to resume iterating the current move on the specified axis. It will ramp up at the set accel rate. This function works with the distance, velocity, and position moves.

It works in conjunction with the feed hold function listed previously.

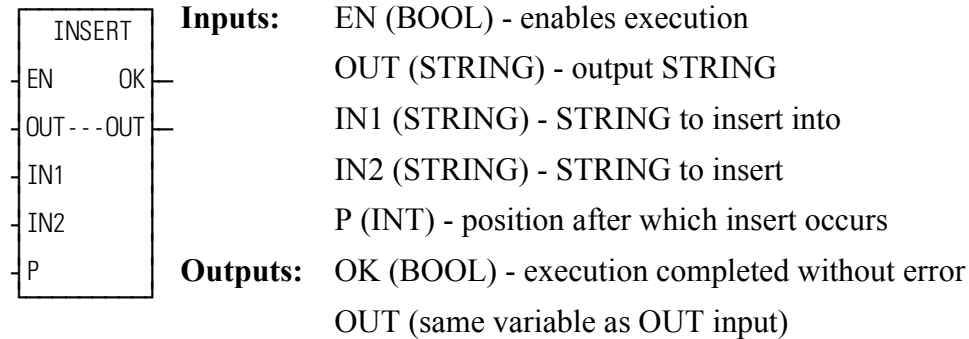
**INSERT***Insert***String/INSERT**

INSERT(OUT := <<STRING>>, IN1 := <<STRING>>, IN2 := <<STRING>>, P := <<INT>>, OK => <<BOOL>>, OUT => <<STRING>>)

The INSERT function is used to insert a STRING into another STRING. The variable at IN2 is placed within the variable at IN1, starting after the position specified by P. The resulting STRING is placed into the variable at OUT.

The variable at IN2 must be unique from the variable at OUT, or an error will occur.

An error will also occur if:

$P > 255$

$P > \text{length of IN1}$

$\text{IN2} = \text{OUT}$

$\text{Length of IN1} + \text{length of IN2} > \text{length of OUT}$

**Examples of insert function**

var at IN1	value at IN2	value at P	var at OUT
stringstring2	1	6	string1string2
stringstring2	1	0	1stringstring2

---



---

## INT2DINT

*Integer to Double Integer*

**Datatype/INTCONV**

---



---

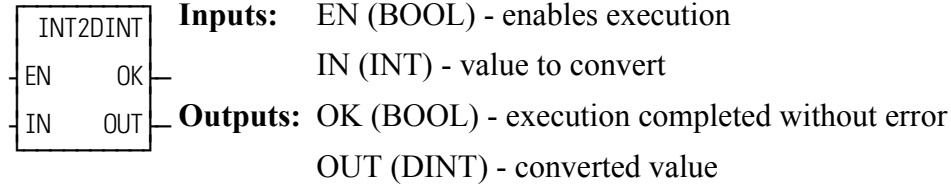

INT2DINT(IN := <<INT>>, OK => <<BOOL>>, OUT => <<DINT>>)

The INT2DINT function changes the data type of the value at IN from an integer to a double integer. The sign of the integer is extended into the leftmost 16 bits of the double integer. The result is placed in the variable at OUT.

---



---

## INT2LINT

*Integer to Long Integer*

**Datatype/INTCONV**

---



---

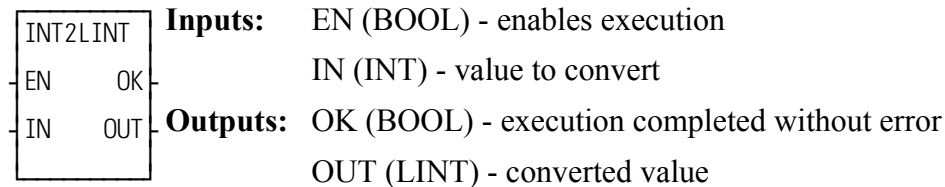

INT2LINT(IN := <<INT>>, OK => <<BOOL>>, OUT => <<BOOL>>)

The INT2LINT function converts an integer into a long integer. The sign bit of the INT is extended into the leftmost 48 bits of the long integer. The result is placed in a variable at OUT

---



---

## INT2SINT

*Integer to Short Integer*

**Datatype/INTCONV**

---



---

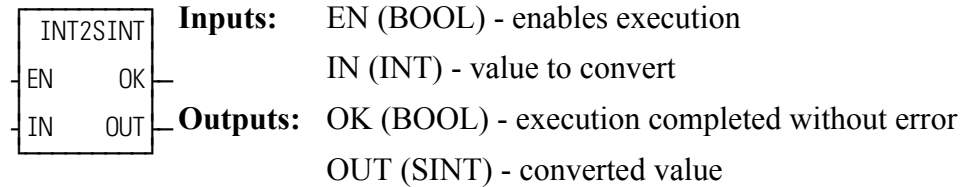

INT2SINT(IN := <<INT>>, OK => <<BOOL>>, OUT => <<SINT>>)

The INT2SINT function changes the data type of the value at IN from an integer to a short integer. The leftmost 8 bits of the integer are truncated. The result is placed in the variable at OUT.

---



---

## INT2UINT

*Integer to Unsigned Integer*

**Datatype/INTCONV**

---



---

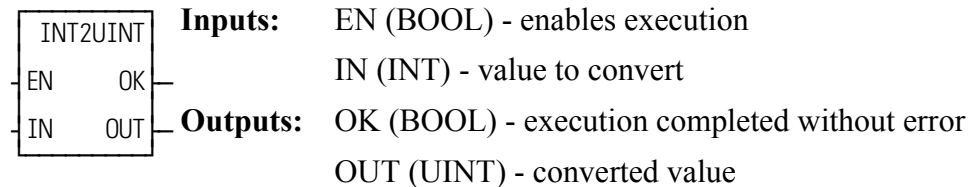

INT2UINT(IN := <<INT>>, OK => <<BOOL>>, OUT => <<UINT>>)

The INT2UINT function changes the data type of the value at IN from an integer to an unsigned integer. The result is placed in the variable at OUT.

---



---

## INT2WORD

Integer to Word

Datatype/INTCONV

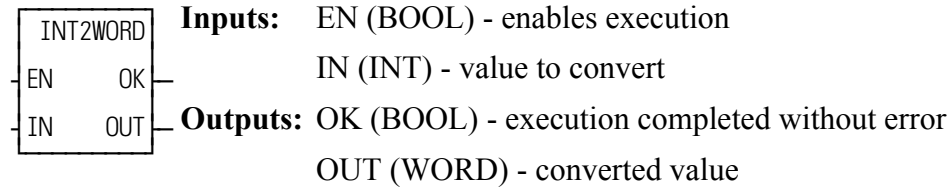

INT2WORD(IN := <<INT>>, OK => <<BOOL>>, OUT => <<WORD>>)

The INT2WORD function changes the data type of the value at IN from an integer to a word. The result is placed in the variable at OUT.

---



---

## IN\_POS?

In Position

Motion/MOVE\_SUP

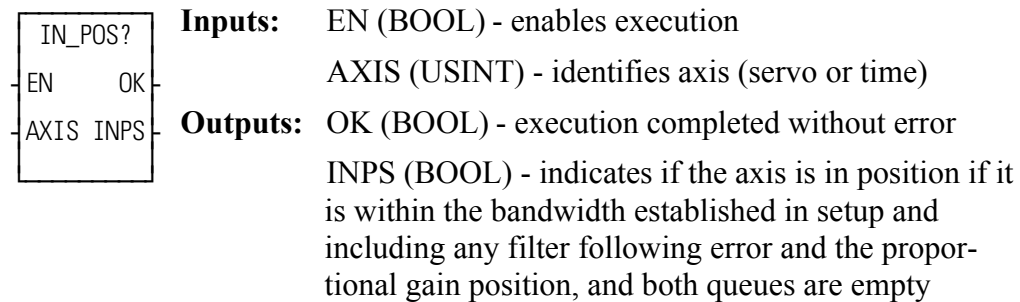

IN\_POS?(AXIS := <<USINT>>, OK => <<BOOL>>, INPS => <<BOOL>>)

The IN\_POS? function asks the question “Are both the active and the next queue empty and is the position within the setup parameter?” If the output at INPS is set, the axis is in position. If not, the axis is not in position.

For a TIME axis, the output at INPS will be set if a Distance, Position, or Velocity move is not in progress.

**IO\_CFG**

IO Configuration

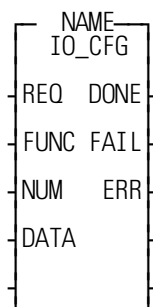
**Io/IO\_CFG**

**Inputs:** REQ (BOOL) - enables execution  
 FUNC (USINT) - number of function desired  
 NUM (USINT) - number of missing blocks in DATA  
 DATA (BYTE ARRAY) - array of missing blocks

**Outputs:** DONE (BOOL) - set if the block I/O or ASIU system is configured  
 FAIL (BOOL) - set if the block I/O or ASIU system is not configured  
 ERR (UINT) - error number if function failed

```
<<INSTANCE NAME>>:IO_CFG(REQ := <<BOOL>>, FUNC := <<USINT>>,
  NUM := <<USINT>>, DATA := <<BYTE ARRAY>>, DONE => <<BOOL>>,
  FAIL => <<BOOL>>, ERR => <<UINT>>);
```

The IO\_CFG function block monitors the status of I/O systems and initialize the configuration of the Block I/O and the ASIU systems. It can also be used to inhibit the Block I/O system allowing you to add or remove blocks. Enter one of the following numbers in the FUNC input to select what the function block will do:

<b>FUNC Input Number</b>	<b>Function</b>
1	Initialize the block I/O configuration
2	Check the status of the block I/O system
3	Inhibit the block I/O system
10	Restart/Configure the ASIU system
11	Check the status of the ASIU system

<b>State of the DONE, FAIL and ERR outputs based on FUNC input</b>			
<b>FUNC #</b>	<b>DONE (if set)</b>	<b>FAIL (If set)</b>	<b>ERR (If FAIL is set)</b>
1(Initiate)	Configured	Cannot be configured	Code for first I/O module that cannot be configured
2(Evaluate)	Configured and operational	Cannot be configured or is not operational	Code for first I/O module that cannot be configured or is not operational
3(Inhibit)	NA	Not operational	0
10(Initiate)	Configured	Cannot be configured	Code for first ASIU that cannot be configured
11(Evaluate)	Configured and operational	Cannot be configured or is not operational	Code for first ASIU that cannot be configured or is not operational

The error number at the ERR output can be a master rack diagnostic code (22\_) or an expansion rack diagnostic code (3\_) or an MMC for PC ASIU diagnostic code (24\_), (25\_), (260), where the \_ indicates the number of the module or ASIU.

**Note:** Only the -01 or later block I/O modules are capable of changing their initial configuration. Any block I/O modules in your system with a part number ending with -00 cannot be used with this function block to change the configuration of modules (function 1). These -00 modules must be addressed consecutively in the hardware declarations starting with “1” and all declared blocks must be physically in the system before scanning can occur.

The IO\_CFG function block is used in conjunction with the **I/O Config/Scan Options** radio buttons on the hardware declarations page of the main ladder. If the radio button is checked for **Reconfigurable I/O and continue to scan with Master Rack, Remote Rack or Block I/O failures**, the CPU will no longer indicate a blink code when an I/O configuration error or failure is detected. This function block provides that blink code to the ladder. If the operator needs that code, then the ladder must make it available to the operator. Otherwise, the operator can use PiCPro to do an **Online | Status...** to get the error information in the Run Time Failure description (a message that indicates which module or connection has failed). If the radio button is checked for **Reconfigurable I/O and continue to scan with Master Rack, Remote Rack, Block or ASIU failures**, the CPU will no longer indicate a blink code when an I/O configuration error or failure is detected; and additionally, ASIU failures will not cause a ladder to stop scanning. This function block provides that blink code to the ladder. **Note:** A separate instance of IO\_CFG is required for the Master Rack/Block/Remote I/O system and a separate instance is required for the ASIU system as different FUNC inputs are required to monitor each system.

When the programmer checks any of these radio buttons, a dialog is immediately displayed reminding the programmer of the IO\_CFG function block in the ladder. When this feature is enabled, the CPU will continue to scan with an I/O or ASIU failure. If this feature is enabled, the ladder must have an IO\_CFG function block to monitor the I/O systems, and an IO\_CFG function block to monitor the ASIU system (if used). This allows the ladder to react to any failures.

**IMPORTANT**

If the ladder Configurable I/O box is enabled on the Hardware Declarations page, the ladder will continue to scan even if a run time I/O or ASIU failure occurs. If the failure occurs in either Remote I/O (in expansion racks) or in block I/O, the main rack I/O will continue to function. If the I/O failure occurs in the main rack then all I/O will be non-functional. Note that this applies only to discrete I/O. A communications module will not be affected by this status so the CPU is still capable of communicating with other processors unless it is the communications module itself that failed.

With the respective I/O/Config/Scan Option enabled, it is the main ladder's responsibility to use the IO\_CFG function block to obtain the state of the I/O system and the ASIU system (two instances of the function block). Based on the state of the I/O system and the ASIU system, the ladder must take the appropriate actions.

If the FUNC input is 1 and REQ is one-shot then the ladder is telling the CPU which block modules are missing. The DATA input is a byte array that indicates which block I/O modules are missing in the configuration; NUM is the number of missing blocks in DATA. The last item in the array will have a value of 0. For example, if the 4th block will be missing from however many blocks are normally there, the array would consist of 4, 0 and NUM would be 1. A non-zero value for ERR (and FAIL set) indicates that a failure exists in the I/O system. If the FAIL is set then the set of missing blocks apparently did not result in a valid block I/O configuration based on the ladder's hardware declarations.

When using the FUNC value of 1, the ladder's hardware declarations will include all of the block I/O modules that can exist in any configuration. For a specific configuration, the DATA array indicates which of those blocks are currently missing. If a machine has one variation with block 4 missing but another variation has blocks 3, 5, and 8 missing, then the DATA array is configured for the correct list of missing blocks when the IO\_CFG REQ is made. In the first case, the DATA array would have 4, 0 and NUM is 1. In the second case, the DATA array would have 3, 5, 8, 0 and NUM is 3. The DATA array can be sized for the longest list of missing modules and the NUM value indicates the number of blocks in the list at the time of the request.

If the FUNC input is 1 then the block I/O modules that are in the list as missing blocks really must be missing. If the modules are actually connected, then the CPU will try to reconfigure them to subsequent locations (based on the DATA array). This request can result in an odd ERR value because the modules are not really missing. If the correct blocks are connected, do not try to configure them as missing.



If the FUNC input is 2 then the ladder is asking the CPU to provide the state of the I/O system. A non-zero value for ERR (and FAIL set) indicates that a failure exists in the I/O system. This value is the blink code that would be sent by the CPU if this PiCPro feature is not used. If the FAIL is set then the ladder must react appropriately to the failure in its I/O system.

If the FUNC input is 3 then the remote I/O system is inhibited (for all block I/O modules and any remote expansion racks). The main rack I/O remains operational in this state. Block I/O modules may be moved or removed without causing an I/O failure. The FAIL output is set indicating the I/O system is not operational but the ERR output will be zero. To enable the I/O system after inhibiting the block I/O chain in this manner, the IO\_CFG must be triggered (with REQ) with the FUNC at 1 so that the block I/O system is configured again.

If the FUNC input is 10 then the ladder is requesting the CPU to restart the ASIUs. This is used after a ASIU failure or power loss. After the ASIUs are restarted, it will be necessary for the ladder to perform the servo start up sequence with SV\_INIT etc.

If the FUNC input is 11, the ladder is requesting the CPU to provide the state of the ASIU system. A non-zero value for ERR (and FAIL set) indicates that a failure still exists in the ASIU system. This value is the blink code that would be sent by the CPU if this PiCPro feature was not used. If the FAIL is set, the ladder must react appropriately to the failure in the ASIU system.

For the FUNC inputs of 1, 2, 10, and 11 the ERR output is the blink code value. The default animation display for a UINT variable will be decimal. By entering an initial value of 16#0 for this variable, the animation will display the value in hexadecimal format. For example, if the first block I/O module failed or was not connected, the ERR output would be shown as 929 in decimal or 3A1 in hexadecimal (depending on an initial value, if any). The 3A1 hex value is read as 3-10-1, which corresponds to a blink code of 3-10-1. This blink code sequence indicates the first block I/O module. To make this important data easier to reference using animation, the initial value of 16#0 for the ERR output variable is recommended.

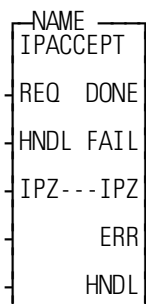
**IPACCEPT***(IP Accept)***Io/SOCKETS**

**Inputs:** REQ (BOOL) - requests execution (One-shot)  
 HNDL (UINT) - socket handle from IPSOCK function block  
 IPZ (STRING) - holds the remote node IP address

**Outputs:** DONE (BOOL) - execution completed without error  
 FAIL (BOOL) - energized if and only if err is  $\neq 0$   
 IPZ (STRING) - same area as IPZ input, with zero terminated string inserted  
 ERR (INT) - error number if FAIL is set  
 HNDL (UINT) - new socket handle for connection

```
<<INSTANCE NAME>>:IPACCEPT(REQ := <<BOOL>>, HNDL :=
  <<UINT>>, IPZ := <<STRING>>, DONE => <<BOOL>>, FAIL =>
  <<BOOL>>, IPZ => <<STRING>>, ERR => <<INT>>, IPZ => <<STRING>>,
  HNDL => <<UINT>>);
```

The IPACCEPT function block is used by the TCP server to accept incoming connect requests. It is used after the IPSOCK and the IPLISTEN function blocks. It removes the next connect request from the queue (or waits for one), creates a new socket for the connection, and returns a handle to that new socket.

The TCP/IP stack will check for an available connect request assigned to the socket specified in HNDL. If a request is found, a new socket will be created. If no request is found, the scan will continue until a request is found.

If a new socket cannot be created, the scan will continue until there is a socket available.

The Host node address will be returned at IPZ.

Once the new socket is no longer needed, the application must call the IPCLOSE function block in order to free that socket.

Refer to the IPWRITE function block for an Overview for Using the Ethernet-TCP/IP Function Blocks and for a list of Ethernet-TCP/IP Errors.

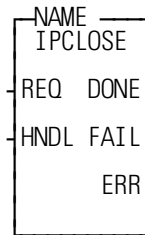
**IPCLOSE***(IP Close)***Io/SOCKETS**

**Inputs:** REQ (BOOL) - requests execution (One-shot)  
 HNDL (UINT) - socket handle from the IPSOCK function block

**Outputs:** DONE (BOOL) - execution completed without error  
 FAIL (BOOL) - energized if and only if err is  $\neq 0$   
 ERR (INT) - error number if FAIL is set

```
<<INSTANCE NAME>>:IPCLOSE(REQ := <<BOOL>>, HNDL := <<UINT>>,
  DONE => <<BOOL>>, FAIL => <<BOOL>>, ERR => <<INT>>);
```

The IPCLOSE function block is used by an application to terminate a communication session for the socket specified at HNDL. Any unread data at a socket will be discarded. Once the IPCLOSE function block is called, the socket handle is no longer valid and free to be reused by a subsequent IPSOCK or IPACCEPT call.

Refer to the IPWRITE function block for an Overview for Using the Ethernet-TCP/IP Function Blocks and for a list of Ethernet-TCP/IP Errors.

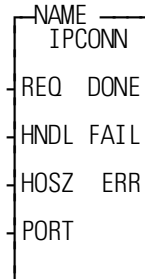
**IPCONN***(IP Connection)***IO/SOCKETS**

**Inputs:** REQ (BOOL) - requests execution (One-shot)  
 HNDL (UINT) - socket handle from the IPSOCK function block  
 HOSZ (STRING) - name or address of the target host, zero terminated  
 PORT (UINT) - port number on the target host

**Outputs:** DONE (BOOL) - execution completed without error  
 FAIL (BOOL) - energized if and only if err is  $\neq 0$   
 ERR (INT) - error number if FAIL is set

```
<<INSTANCE NAME>>.IPCONN(REQ := <<BOOL>>, HNDL := <<UINT>>,
  HOSZ := <<STRING>>, PORT := <<UINT>>, DONE => <<BOOL>>, FAIL
  => <<BOOL>>, ERR => <<INT>>);
```

The IPCONN function block is used by a client application to connect to a remote server by specifying the remote endpoint address for a socket. If used with a TCP socket, the three-way TCP handshake is initiated. If used with a UDP socket, it simply fills in the target endpoint (address and protocol port).

The TCP/IP protocol stack will obtain the endpoint address for the named host and connect to the requested protocol port (if the preceding call to the IPSOCK function block had the TYPE set to 1 for TCP).

In the absence of DNS/DHCP, the TCP/IP protocol stack will keep its own route table to nearby neighbors for peer-to-peer connections.

Refer to the IPWRITE function block for an Overview for Using the Ethernet-TCP/IP Function Blocks and for a list of Ethernet-TCP/IP Errors.

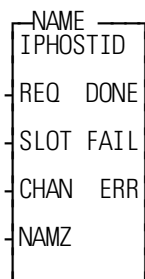
**IPHOSTID***(IP Host Identification)***IO/SOCKETS**

**Inputs:** REQ (BOOL) - requests execution (One-shot)  
 SLOT (USINT) - slot number of the resource  
 CHAN (USINT) - channel number for this NAME  
 NAMZ (STRING) - name of this resource, zero terminated

**Outputs:** DONE (BOOL) - execution completed without error  
 FAIL (BOOL) - energized if and only if err is  $\neq 0$   
 ERR (INT) - error number if FAIL is set

```
<<INSTANCE NAME>>:IPHOSTID(REQ := <<BOOL>>, SLOT :=
  <<USINT>>, CHAN := <<USINT>>, NAMZ := <<STRING>>, DONE =>
  <<BOOL>>, FAIL => <<BOOL>>, ERR => <<INT>>);
```

The IPHOST function block is optional and not required to be used. It assigns a name to a communication resource. If there are multiple communication resources in use, the IPHOST function block must be called for each one so that a different name is assigned to each resource.

The SLOT input is used to select the physical location of the TCP/IP communication module to use. There may be up to two in the system.

The CHAN input is used to select one of several possible communication resources. The actual assignments will be an on-going, upward compatible assignment of numeric assignment to a physical communication resource.

Channel	Description
0	Default ethernet connection (currently BNC)
1	10-Base-T connection (twisted pair)
2	10-Base-5 connection (15-pin AUI)
3	10-Base-2 connection (BNC coax)
4	Modem port

The NAMZ input is used to assign a TCP/IP address to this resource. If a Domain Name Server (DNS) or DHCP is in operation, a name may be inserted. Otherwise, an IP address in dotted decimal notation is required. This input variable must be a zero terminated string. The loop-back resource shall be predefined and named localhost at address 127.0.0.1. Implementation of the localhost resource still requires a TCP/IP protocol stack running on a communication module or ethernet module. Refer to the IPWRITE function block for an Overview for Using the Ethernet-TCP/IP Function Blocks and for a list of Ethernet-TCP/IP Errors.

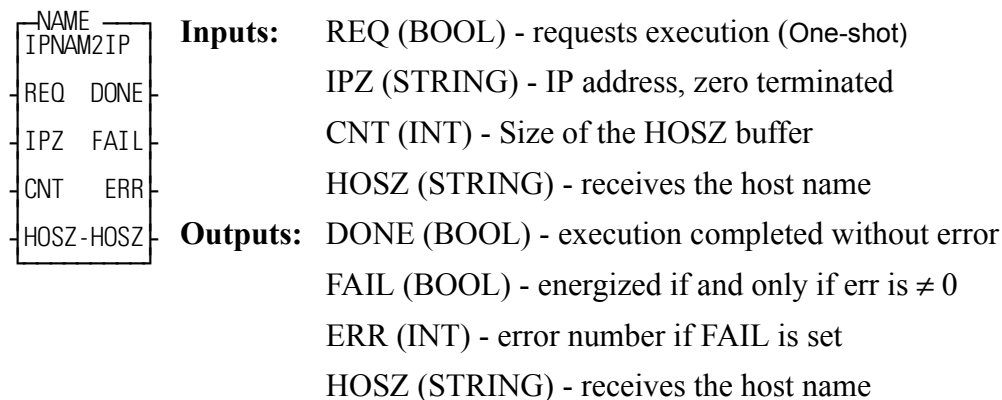
**IPIP2NAM***(IP IP to Name)***Io/SOCKETS**

```
<<INSTANCE NAME>>:IPIP2NAM(REQ := <<BOOL>>, IPZ :=
  <<STRING>>, CNT := <<INT>>, HOSZ := <<STRING>>, DONE =>
  <<BOOL>>, FAIL => <<BOOL>>, ERR => <<INT>>, HOSZ =>
  <<STRING>>);
```

The IPIP2NAM function block allows the application to obtain the host name when you supply the IP address.

NOTE: You must have a DNS (Domain Name Server) configured in the system and available on the network to use this function block.

Refer to the IPWRITE function block for an Overview for Using the Ethernet-TCP/IP Function Blocks and for a list of Ethernet-TCP/IP Errors.

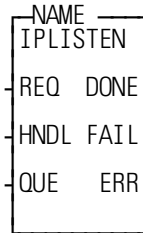
**IPLISTEN***(IP Listen)***Io/SOCKETS**

**Inputs:** REQ (BOOL) - requests execution (One-shot)  
 HNDL (UINT) - socket handle from the IPSOCK function block  
 QUE (UINT) - depth of queue (maximum of 5)

**Outputs:** DONE (BOOL) - execution completed without error  
 FAIL (BOOL) - energized if and only if err is  $\neq 0$   
 ERR (INT) - error number if FAIL is set

```
<<INSTANCE NAME>>:IPLISTEN(REQ := <<BOOL>>, HNDL := <<INT>>,
  QUE := <<UINT>>, DONE => <<BOOL>>, FAIL => <<BOOL>>, ERR =>
  <<INT>>);
```

The IPLISTEN function block is used to make a socket passive (i.e., ready to accept incoming connect requests). It binds the socket defined in HNDL to the port defined by the protocol port (PROT) when the socket is created with the IPSOCK function block. For UDP it binds and for TCP it binds and also prepares for connects. It also sets the size of a queue used to buffer multiple connect requests while a server processes the first one.

The socket specified in HNDL is prepared to service remote requests for a TCP connection. The number of connect requests that may be buffered is defined by the QUE input. The IPACCEPT function block can be used to remove connect requests from the queue.

Refer to the IPWRITE function block for an Overview for Using the Ethernet-TCP/IP Function Blocks and for a list of Ethernet-TCP/IP Errors.

---

---

**IPNAM2IP***(IP Name to IP)***Io/SOCKETS**

---

---

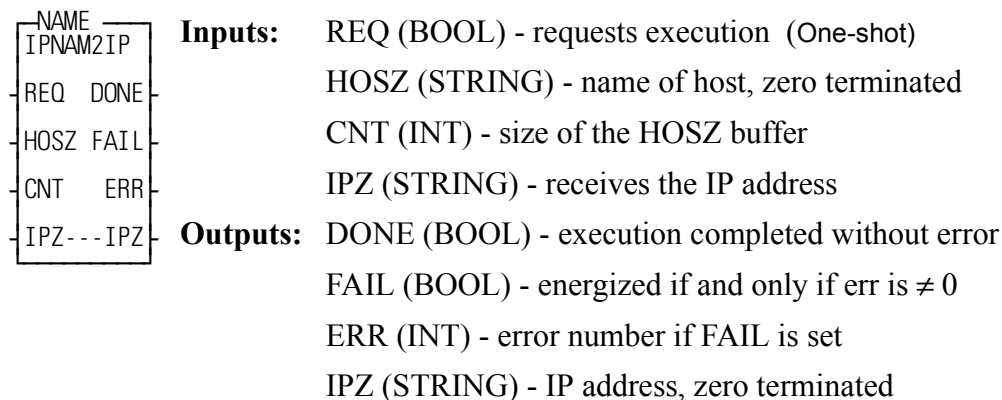

```
<<INSTANCE NAME>>:IPNAM2IP(REQ := <<BOOL>>, HOSZ :=
<<STRING>>, CNT := <<INT>>, IPZ := <<STRING>>, DONE =>
<<BOOL>>, FAIL => <<BOOL>>, ERR => <<INT>>, IPZ =><<STRING>> );
```

The IPNAM2IP function block allows the application to obtain an IP address when you supply the host name.

NOTE: You must have a DNS (Domain Name Server) configured in the system and available on the network to use this function block.

Refer to the IPWRITE function block for an Overview for Using the Ethernet-TCP/IP Function Blocks and for a list of Ethernet-TCP/IP Errors.



**IPREAD**

(IP Read)

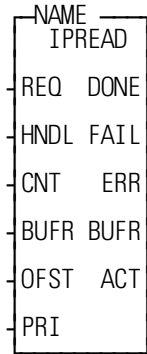
**IO/SOCKETS**

**Inputs:** REQ (BOOL) - enables execution (One-shot)  
 HNDL (UINT) - socket handle from the IPSOCK function block  
 CNT (INT) - size of the buffer  
 BUFR (MEMORY AREA) - buffer to contain data  
*MEMORY AREA* is a STRING, ARRAY, STRUCTURE, ARRAY ELEMENT, or STRUCTURE MEMBER

OFST (UINT) - offset into buffer for data

PRI (BOOL) -priority of the function block

**Outputs:** DONE (BOOL) - execution completed without error  
 FAIL (BOOL) - energized if and only if err is  $\neq 0$   
 ERR (INT) - error number if FAIL is set  
 BUFR (MEMORY AREA) - same area as BUFR input  
 ACT (INT) - number of bytes stored in buffer

```
<<INSTANCE NAME>>:IPREAD(REQ := <<BOOL>>, HNDL := <<UINT>>,
  CNT := <<INT>>, BUFR := <<MEMORY AREA>>, OFST := <<UINT>>, PRI
  := <<BOOL>>, DONE => <<BOOL>>, FAIL => <<BOOL>>, ERR =>
  <<INT>>, BUFR => <<MEMORY AREA>>, ACT => <<INT>>);
```

The IPREAD function block allows you to read input data sent between a client function and a remote server. The data content is a stream of octets. As data is received by the TCP/IP stack, it is appended to this stream. A read of this stream will return the CNT number of octets or the entire stream if it contains fewer octets than CNT. The IPREAD function block is used with a TCP or UDP (connected) socket. NOTE: When the socket is a UDP (connectionless) socket, use the IPRECV function block to get a packet of octets from a UDP socket.

The PRI input sets the priority level at which the function block will be handled. A high priority is indicated when PRI is set. To affect a high priority, the function block should be in a ladder task.

The ACT output will not always equal CNT and nothing can be learned if they are not equal. ACT = 0 also means nothing.

Refer to the IPWRITE function block for an Overview for Using the Ethernet-TCP/IP Function Blocks and for a list of Ethernet-TCP/IP Errors.

**IPRECV**

(IP Receive)

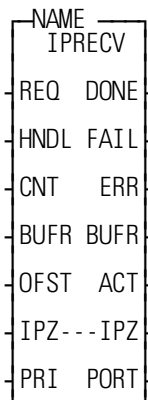
**Io/SOCKETS**

**Inputs:** REQ (BOOL) - requests execution (One-shot)  
 HNDL (UINT) - socket handle from the IPSOCK function block  
 CNT (INT) - size of buffer area  
 BUFR (MEMORY AREA\*) - buffer to contain message  
 OFST (UINT) - offset into message  
 IPZ (STRING) - place to receive node IP address  
 PRI (BOOL) - priority of the function

**Outputs:** DONE (BOOL) - execution completed without error  
 FAIL (BOOL) - energized if and only if err is  $\neq 0$   
 ERR (INT) - error number if FAIL is set  
 BUFR (MEMORY AREA\*) - same area as BUFR input  
 ACT (INT) - number of bytes stored in BUFR  
 IPZ (STRING) - same as IPZ input but holds the IP address of the sending node  
 PORT (UINT) - port number in sending node

\*MEMORY AREA is a STRING, ARRAY, STRUCTURE, ARRAY ELEMENT, or STRUCTURE MEMBER

```
<<INSTANCE NAME>>:IPRECV(REQ := <<BOOL>>, HNDL := <<UINT>>,
CNT := <<INT>>, BUFR := <<MEMORY AREA>>, OFST := <<UINT>>, IPZ
:= <<STRING>>, PRI := <<BOOL>>, DONE => <<BOOL>>, FAIL =>
<<BOOL>>, ERR => <<INT>>, BUFR => <<MEMORY AREA>>, ACT =>
<<INT>>, IPZ => <<STRING>>, PORT => <<UINT>>);
```

The IPRECV function block is used to get a packet of data sent between a client function and a remote server. The data content is a complete packet of octets.

If there is a UDP packet waiting on the TCP/IP stack, this packet will be returned. If there is no packet available, this function block will wait indefinitely until a packet is received. Any time-out function must be implemented in the application software. The IPRECV function block may be cancelled by closing the socket.

The PRI input sets the priority level at which the function block will be handled. A high priority is indicated when PRI is set. To affect a high priority, the function block should be in a ladder task

The IPRECV function block is used with a UDP (connectionless) socket. NOTE: When the socket is a TCP or UDP (connected) socket, use the IPREAD function block.

Refer to the IPWRITE function block for an Overview for Using the Ethernet-TCP/IP Function Blocks and for a list of Ethernet-TCP/IP Errors.

**IPSEND**

(IP Send)

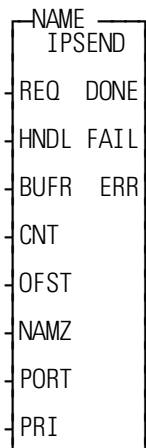
**IO/SOCKETS**

**Inputs:** REQ (BOOL) - requests execution (One-shot)  
 HNDL (UINT) - socket handle from the IPSOCK function block  
 BUFR (MEMORY AREA) - buffer containing datagram  
*MEMORY AREA* is a STRING, ARRAY, STRUCTURE, ARRAY ELEMENT, or STRUCTURE MEMBER  
 CNT (INT) - size of buffer  
 OFST (UINT) - offset into message  
 NAMZ (STRING) - name or address of target node, zero terminated  
 PORT (UINT) - port number in target node  
 PRI (BOOL) - priority

**Outputs:** DONE (BOOL) - execution completed without error  
 FAIL (BOOL) - energized if and only if err is  $\neq 0$   
 ERR (INT) - error number if FAIL is set

```
<<INSTANCE NAME>>.IPSEND(REQ := <<BOOL>>, HNDL := <<UINT>>,
CNT := <<INT>>, BUFR := <<MEMORY AREA>>, CNT := <<INT>>, OFST :=
<<UINT>>, NAMZ := <<STRING>>, PORT := <<UINT>>, PRI := <<BOOL>>,
DONE => <<BOOL>>, FAIL => <<BOOL>>, ERR => <<INT>>);
```

The IPSEND function block is used to send data between client function and remote servers. The data content is a packet of octets.

The PRI input sets the priority level at which the function block will be handled. A high priority is indicated when PRI is set. To affect a high priority, the function block should be in a ladder task.

The IPSEND function block is used with a UDP (connectionless) socket. NOTE: When the socket is a TCP or UDP (connected) socket, use the IPWRITE function block.

Refer to the IPWRITE function block for an Overview for Using the Ethernet-TCP/IP Function Blocks and for a list of Ethernet-TCP/IP Errors.

**IPSOCK**

(IP Socket)

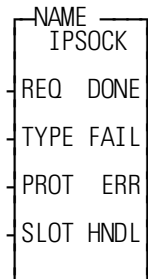
**IO/SOCKETS**

**Inputs:** REQ (BOOL) - requests execution (One-shot)  
 TYPE (USINT) - 0 = UDP CLIENT, 1 = TCP, 4 = UDP SERVER  
 PROT (UINT) - protocol port number  
 SLOT (USINT) - slot number

**Outputs:** DONE (BOOL) - execution completed without error  
 FAIL (BOOL) - energized if and only if err is  $\neq 0$   
 ERR (INT) - error number if FAIL is set  
 HNDL (UINT) - unique socket handle

```
<<INSTANCE NAME>>:IPSOCK(REQ := <<BOOL>>, TYPE := <<USINT>>,
PROT := <<UINT>>, SLOT := <<USINT>>, DONE => <<BOOL>>, FAIL =>
<<BOOL>>, ERR => <<INT>>, HNDL => <<UINT>>);
```

The IPSOCK function block is used to obtain a data structure and assign it to a specific communication resource. When the REQ input is set, the input parameters will be passed to the TCP/IP protocol stack defined by the SLOT input. The function will then wait for a response to the request. This may take multiple scans.

If a socket data structure is allocated, the DONE output will be set. The HNDL output can then be used for further operations with this socket data structure. If an error occurs, the FAIL output will be set and the ERR output will be set to the error number.

The type of service (TCP, UDP Client, or UDP Server) and Protocol (PROT) are required to bind the protocol to the socket. NOTE: Bind is done by the IPLISTEN function block using the data entered in the TYPE and PROT inputs of the IPSOCK function block. The TCP/IP community assigns protocols via RFC 1060 (Assigned Numbers).

Refer to the IPWRITE function block for an Overview for Using the Ethernet-TCP/IP Function Blocks and for a list of Ethernet-TCP/IP Errors.

**NOTE**

If ERR has a value of 1005 (TCP/IP Failure) a ladder program change is needed. A ladder with Ethernet functions loaded on an MMC for PC requires the IPSTAT function to reset the connection to the host. The other PiC CPU models have an external Ethernet module (with it's own TCP/IP stack) and do not require IPSTAT.

**IPSTAT**

IP Status

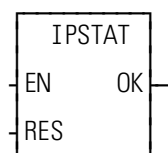
**IO/SOCKETS**

**Inputs:** EN (BOOL) - enables function  
RES (BOOL) - indicates reset Blue Screen of Death (BSOD) status is requested

**Outputs:** OK (BOOL) - Indicates OK status of the Windows NT resources

IPSTAT(RES := <<BOOL>>, OK => <<BOOL>>)

This function should be called on a periodic basis with the RES input not energized whenever it is desired to know the status of the resources provided by the Windows NT operating system. Should these resources become unavailable the OK output will not be energized. If the resources are available, the OK output will be energized.

After a loss of resources, it will be necessary to call this function with the RES input energized. This will re-arm the detection of the BSOD. The reset functionality is provided to allow the ladder application to ensure that all required application code that requires the detection of the loss has seen the loss of resources. Furthermore, it allows the application ladder to ensure that all appropriate actions have been completed before the BSOD flag is reset. Therefore, it is recommended to wait until all TCP/IP function blocks have executed at least once before a reset is requested. This “wait” could be simply be implemented by use of a timer that ensures that all tasks containing TCP/IP function blocks have executed, or by contacts indicating that all appropriate actions have been taken and that active TCP/IP function blocks have terminated.

Because the MMC for PC may be run regardless of the state of the Windows NT operating system or the power status of the PC from which it is run, the status output OK may or may not be energized upon the first scan of the application ladder. It cannot be assumed that the status is OK initially. If the status is not OK, the application ladder is required to perform the RESET functionality of this function.

This function is specifically for use on the MMC for PC. However, it can be used in any other 486 based PiC without causing any problems. In this case the status will always be OK, regardless of the status of the TCP/IP stack.

Refer to the IPWRITE function block for an Overview for Using the Ethernet-TCP/IP Function Blocks and for a list of Ethernet-TCP/IP Errors.

**IPWRITE**

(IP Write)

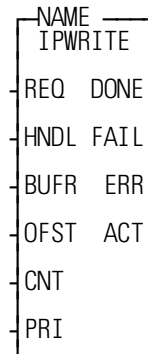
**IO/SOCKETS**

- Inputs:**
- REQ (BOOL) - requests execution (One-shot)
  - HNDL (UINT) - socket handle from the IPSOCK function block
  - BUFR (MEMORY AREA) - buffer containing data  
*MEMORY AREA* is a STRING, ARRAY, STRUCTURE, ARRAY ELEMENT, or STRUCTURE MEMBER
  - OFST (UINT) - offset into the buffer for data
  - CNT (INT) - number of bytes in the buffer
  - PRI (BOOL) - priority of the function
- Outputs:**
- DONE (BOOL) - execution completed without error
  - FAIL (BOOL) - energized if and only if err is  $\neq 0$
  - ERR (INT) - error number if FAIL is set
  - ACT (INT) - number of bytes appended

```
<<INSTANCE NAME>>.IPWRITE(REQ := <<BOOL>>, HNDL := <<UINT>>,
  BUFR := <<MEMORY AREA>>, OFST := <<UINT>>, CNT := <<INT>>, PRI
  := <<BOOL>>, DONE => <<BOOL>>, FAIL => <<BOOL>>, ERR =>
  <<INT>>, ACT => <<INT>>);
```

The IPWRITE function block is used to send data between client function and remote servers. The data content is a sequence of octets. That sequence will be appended to the stream of any other octets that have previously been sent via this function block.

The PRI input sets the priority level at which the function will be handled. A high priority is indicated when PRI is set. To affect a high priority, the function block should be in a ladder task.

The IPWRITE function block is used with a TCP or UDP (connected) socket.

**Note:** When the socket is a UDP (connectionless) socket, use the IPSEND function block.

## Overview for Using the Ethernet -TCP/IP Function Blocks

---

The following procedures summarize the various ways of using the IP function blocks to accomplish certain operations with TCP or UDP.

### Creating a TCP Server

The following procedure is used to setup a TCP server.

1. Call the IPSOCK function block. Enter a “1” (TCP) in the TYPE input of the IPSOCK function block. This creates a data structure that will be used to associate this server with a specific TCP based protocol.
2. Call the IPLISTEN function block. This marks the socket as used by the server. Incoming connect requests will be buffered up to the depth of the queue. They are removed by an accept request.
3. Call the IPACCEPT function block. This obtains a new socket that can be passed to a server TASK or used by the server in the application. The IPZ value may be used to determine who issued the connect request.
4. When the server is done using IPREAD and IPWRITE function blocks, the IPCLOSE function block should be called to free the new socket that was created.
5. Steps 3 and 4 can then be repeated. Step 3 can be called again before step 4 is called if multiple connections are required. However it is the application’s responsibility to make sure that each server uses the correct socket.
6. Once the ladder decides that the socket created by the IPACCEPT function block is no longer required, call the IPCLOSE function block to free this socket.
7. Also, once the ladder decides that the server is no longer required, the IPCLOSE operation should be called to free the original socket obtained in step 1.

### Creating a TCP Client

The following procedure is used to setup a TCP client connection to a server. The server must already be running for the operation to work.

1. Call the IPSOCK function block. Enter a “1” (TCP) in the TYPE input of the IPSOCK function block. This creates a data structure that allows the client to use a specific protocol.
2. Call the IPCONN function block. This connects the client with the requested server on the requested node.
3. Call the IPREAD and IPWRITE function blocks to transfer data between the client and the server.
4. When done transferring data, call the IPCLOSE function block to free the socket obtained in step 1.



### Creating a UDP Server (Connectionless)

The following procedure is used to setup a UDP server.

1. Call the IPSOCK function block. Enter a “4” (UDP Server) in the TYPE input of the IPSOCK function block. This creates a data structure that will be used to associate this server with a specific UDP based protocol.
2. Call the IPLISTEN function block.
3. Call the IPRECV function block. This provides a buffer that an incoming datagram can be read into. Upon receipt of a datagram, the response (if any) may be generated and sent using the IPSEND function block. The sending node name and port (IPZ and PORT) are available to be used in a response.
4. Call the IPSEND function block if necessary and return to step 3 or go to step 5.
5. When done using the IPRECV and IPSEND function blocks, the IPCLOSE function block can be called to free the socket that was created in step 1.

### Creating a UDP Client (Connectionless)

The following procedure is used to setup a UDP client.

1. Call the IPSOCK function block. Enter a “0” (UDP Client) in the TYPE input of the IPSOCK function block. This creates a data structure that will be used to associate this client with a specific UDP based protocol.
2. Call the IPSEND function block with a message to be sent to the server.
3. Call the IPRECV function block if a response is expected. Go back to step 2 or on to step 4. If a time-out occurs, decide whether to call the IPRECV function block again.
4. When done using the IPRECV and IPSEND function blocks, the IPCLOSE function block can be called to free the socket that was created in step 1.

NOTE: If there are multiple messages in transit, UDP clients and servers are not guaranteed that messages will be received or received in the same order as sent.

### UDP Client (Connected)

1. Call the IPSOCK function block. Enter a “0” (UDP Client) in the TYPE input of the IPSOCK function block.
2. Call the IPCONN function block to connect the client to the server.
3. Call the IPREAD and IPWRITE function blocks to read and write data to the server.

The UDP server is implemented in the same manner as a connectionless UDP server (see above).

#### NOTE

The following books may be helpful as references when working with TCP/IP:

- Comer, D.E. (1991), *Internetworking with TCP/IP Vol.I: Principals, Protocols, and Architecture*. Prentice-Hall, Englewood Cliffs, New Jersey. ISBN 0-13-468505-9
- Comer, D.E. (1993), *Internetworking with TCP/IP Vol. III: Client-Server Programming and Applications*. Prentice-Hall, Englewood Cliffs, New Jersey. ISBN 0-13-474222-2

## Ethernet-TCP/IP Errors

---

The following errors can be reported out of the ERR output on the IPXXXX function blocks.

ERR#	Description
-35	Detected hardware failure
-34	Can't find a reasonable interface
-33	Can't find a reasonable next IP hop
-32	Bad header at upper layer (for upcalls)
-31	No ARP for a given host
-30	Send to net failed at low layer
-24	TCP layer timeout error
-23	TCP layer state error
-22	Ran out of other queue-able resource
-21	Ran out of free packets
-20	Malloc or calloc failed
0	No error
1	Not owner
2	No such file or directory
3	No such process
4	Interrupted system call
5	I/O error
6	No such device or address
7	Arg list too long
8	Exec format error
9	Bad file number
10	No children
11	No more processes
12	Not enough core
13	Permission denied
14	Bad address
15	Directory not empty
16	Mount device busy
17	File exists
18	Cross-device link
19	No such device
20	Not a directory
21	Is a directory
22	Invalid argument
23	File table overflow

24	Too many files open
25	Not a typewriter
26	File name too long
27	File too large
28	No space left on device
29	Illegal seek
30	Read-only file system
31	Too many links
32	Broken pipe
33	Resource deadlock avoided
34	No locks available
35	Unsupported value
36	Message size
37	Argument too large
38	Result too large
40	Destination address required
41	Protocol wrong type for socket
42	Protocol not available
43	Protocol not supported
44	Socket type not supported
45	Operation not supported on socket
46	Protocol family not supported
47	Address family not supported
48	Address already in use
49	Can't assign requested address
50	Socket operation on non-socket
51	Network is unreachable
52	Network dropped connection on reset
53	Software caused connection abort
54	Connection reset by peer
55	No buffer space available
56	Socket is already connected
57	Socket is not connected
58	Can't send after socket shutdown
59	Too many references: can't splice
60	Connection timed out
61	Connection refused
62	Network is down
63	Text file busy

<b>64</b>	Too many levels of symbolic links
<b>65</b>	No route to host
<b>66</b>	Block device required
<b>67</b>	Host is down
<b>68</b>	Operation now in progress
<b>69</b>	Operation already in progress
<b>70</b>	Operation would block
<b>71</b>	Function not implemented
<b>72</b>	Operation cancelled
<b>1000</b>	There is a non-zero terminated string which requires zero termination.
<b>1001</b>	There is a CNT input which is too large.
<b>1002</b>	The SLOT number requested does not contain an Ethernet board.
<b>1003</b>	Either the firmware does not support TCP/IP or there is no Ethernet board in the rack.
<b>1004</b>	The IPZ buffer is too small.
<b>1005</b>	The PC operating system has reset the TCP/IP stack. See IPSTAT.

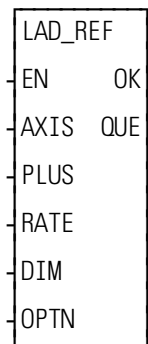
**LAD\_REF***Ladder Reference (Machine Reference)***Motion/REF**

- Inputs:**
- EN (BOOL) - enables execution (**One-shot**)
  - AXIS (USINT) - identifies axis to be referenced (servo or digitizing)
  - PLUS (BOOL) - indicates direction of motion to reference switch
  - RATE (UDINT) - feedrate at which motion occurs (entered in LU/MIN)
  - DIM (DINT) - reference dimension for the nearest resolver null or the next encoder index mark when reference switch is set. It is entered in LU. If DIM is outside the range of -536,870,912 to 536,870,911 FU, the OK will not be set.
  - OPTN (WORD) - provides referencing options
- Outputs:**
- OK (BOOL) - execution completed without error
  - QUE (USINT) - queue number for reference move

```
ANLG_OUT(AXIS := <<USINT>>, PLUS := <<BOOL>>, RATE :=
  <<UDINT>>, DIM := <<DINT>>, OPTN := <<WORD>>, OK => <<BOOL>>,
  QUE => <<USINT>>)
```

The ladder reference is a machine reference done from the ladder. It will cause a servo axis to move in the direction (PLUS) and at the feedrate (RATE) specified to the reference switch\* until the REF\_END function is called in your ladder program. In your ladder logic, the closing of the reference switch should enable REF\_END. When the switch closes, the position of the axis is recorded based on the nearest null of the resolver or the next index mark of the encoder. The value entered at DIM is assigned to this position.

If the axis is a digitizing axis or if 'no motion' has been selected at OPTN (see below), this function does not cause motion. You must use other methods of moving the axis to the reference switch. The inputs PLUS and RATE are ignored when no motion is selected.

The ladder reference monitors the axis until the REF\_END function is called in your ladder program. In contrast, a fast reference (see FAST\_REF) monitors the axis until a fast input on the feedback module occurs. When using a SERCOS axis, the function block SCA\_RFIT must be called and completed successfully prior to calling the LAD\_REF function.

NOTE: If an encoder is the feedback device, the axis will continue to move after the switch closes until the next index mark is seen.

The OPTN input provides the following options:

Option	Binary value	Hex value
Ignore index/null	00000000 00000001	0001
No motion	00000000 00000010	0002
Null setup	00000000 00000100	0004

If no option is desired, enter a “0.”

\*See FAST\_REF function for information on setting up a reference switch.

## Option inputs

### Ignore the index/null

Choosing this option allows a reference to occur which ignores the index mark of an encoder or the null of a resolver during the reference cycle. If bit 0 is set to “1,” the reference position assigned by DIM will be assigned to the position the axis is at when REF\_END is enabled.

With an encoder, the axis will stop immediately after the fast input transitions. The axis does not continue movement until the index mark is reached. NOTE: This makes the reference switch position given with the READ\_SV function invalid.

With a resolver, the reference switch position available with the READ\_SV function is valid.

### No motion

The no motion option allows a reference to occur without any motion. The axis is put into a mode whereby it is watching for the conditions of a reference cycle.

Even though no move is placed in the queue, a queue must be available. A move will be initiated by the ladder following the reference cycle.

Once the call is made, the reference complete flag goes low until the reference switch input occurs and the index mark (unless “ignore index” option is active) is received. The reference complete flag goes high once these events occur and the axis position takes on the reference value at DIM.

If the move type is VEL, RATIO\_GR, LAD\_REF, or FAST\_REF, the new axis position assigned by the no-motion reference has no effect on the move itself. With a DISTANCE move, the actual distance covered will be the same. If a no-motion reference occurs during a position move, the endpoint will be reached.

If a no-motion reference is used during a RATIO\_PRO move, the lock on point of the slave axis to the master axis may be undefined. This is not recommended.

**Note:** A ladder reference can also be performed on a digitizing axis. You must cause the axis to move and the fast input to occur. Use variable 29 with the READ\_SV function to read the reference switch position. REF\_DNE? can also be used with digitizing axes. This function cannot be used with the stepper axis module.

**Null Setup**

This option will establish a null position for a digital drive axis with resolver feedback or single-turn Stegmann encoder feedback in addition to performing the reference. The null position will be stored in the digital drive's flash memory and will be retained through power cycles. This feature allows the user to omit the setup process of physically positioning the reference switch to be near the null. To provide repeatable references, this option bit should be set with the first call to LAD\_REF and should be reset for subsequent calls.

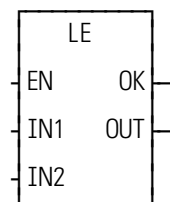
**LE***Less Than or Equal To***Evaluate/LE****Inputs:** EN (BOOL) - enables execution

IN1 (ANY except BOOL or STRUCT) - value to be compared

IN2 (same type as IN1) - value to be compared

**Outputs:** OK (BOOL) - execution completed without error

OUT (BOOL) - indicates if values are less than or equal to successive values

LE(IN1 := <<ANY>>, IN2 := <<ANY>>, OK => <<BOOL>>, OUT => <<BOOL>>)

The LE function compares the value of the variable or constant at IN1 with the value of the variable or constant at IN2. This is an extensible function which can compare up to 17 inputs.

**For the inputs at IN1, IN2, ...IN17**

If  $IN1 \leq IN2 \leq IN3 \leq \dots \leq IN17$ , the coil at OUT is energized.

Otherwise the coil at OUT is not energized.

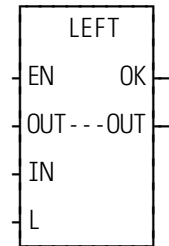

**LEFT***Left String***String/LEFT**

**Inputs:** EN (BOOL) - enables execution  
 OUT (STRING) - output STRING  
 IN (STRING) - STRING to extract from  
 L (INT) - length

**Outputs:** OK (BOOL) - execution completed without error  
 OUT (same variable as OUT input)

LEFT(OUT := <<STRING>>, IN := <<STRING>>, L := <<INT>>, OK =>  
 <<BOOL>>, OUT => <<STRING>>)

The LEFT function is used to extract characters from the left side of a STRING.  
 The number of characters specified by the input at L are extracted from the left side of the variable at IN and placed into the variable at OUT.

An error occurs if:  
 L > 255  
 L > length of OUT

**Example of left function**

Var at IN	Value at L	Var at OUT
string1string2	7	string1

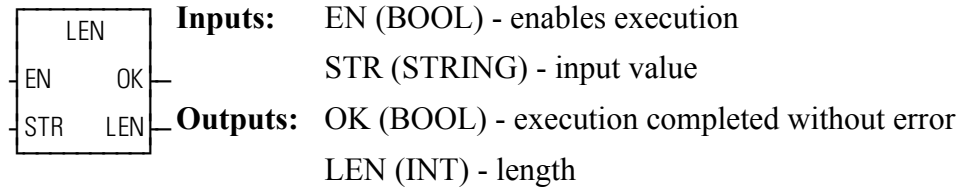
**LEN***Length***String/LEN**

LEN(STR := <<STRING>>, OK => <<BOOL>>, LEN => <<INT>>);

The LEN function is used to return the length of a STRING. The number of characters in the variable at STR is placed in the variable at LEN.

**Example of length function**

Declared length of string	Value at STR	Value at LEN
10	string	6

**LIMIT**

Limit

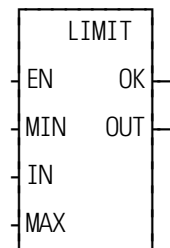
**Filter/LIMIT**

**Inputs:** EN (BOOL) - enables execution  
 MIN (ANY except BOOL and STRUCT) - minimum value  
 IN (same type as MIN) - value to be limited  
 MAX (same type as MIN) - maximum value

**Outputs:** OK (BOOL) - execution completed without error  
 OUT (same type as MIN) - value within limits

LIMIT(MIN := <<ANY>>, IN := <<ANY>>, MAX := <<ANY>>, OK =>  
 <<BOOL>>, OUT => <<ANY>>)

The LIMIT function assigns a value to the variable at OUT that is within the lower and upper limits you enter. The value at MIN (lower limit) must be less than the value at MAX (upper limit). The value at OUT will be the value of the input at either 1) IN, 2) MIN, or 3) MAX.

**For the variables or constants assigned at IN, MIN, and MAX if:**

$MIN \leq IN \leq MAX$ , then  $OUT = IN$

$IN > MAX$ , then  $OUT = MAX$

$IN < MIN$ , then  $OUT = MIN$

---



---

## LINT2DI

*Long Integer to Double Integer*

**Datatype/LINTCONV**

---



---

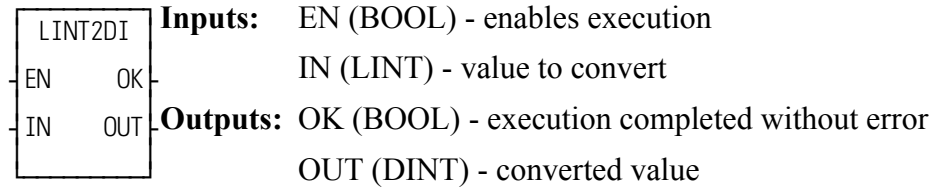

LINT2DI(IN := <<LINT>>, OK => <<BOOL>>, OUT => <<DINT>>)

The LINT2DI function converts a long integer into a double integer. The left most 32 bits of the long integer are truncated. The result is placed in a variable at OUT.

---



---

## LINT2INT

*Long Integer to Integer*

**Datatype/LINTCONV**

---



---

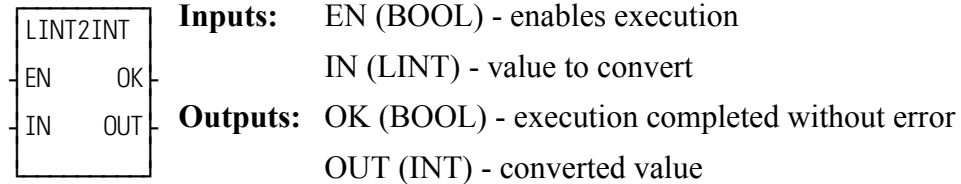

LINT2INT(IN := <<LINT>>, OK => <<BOOL>>, OUT => <<INT>>)

The LINT2INT function converts a long integer into a double integer. The left most 48 bits of the long integer are truncated. The result is placed in a variable at OUT.

---



---

## LINT2LR

*Long Integer to Long Real*

**Datatype/LINTCONV**

---



---

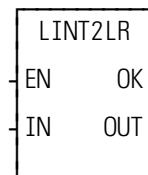

**Inputs:** EN (BOOL) - enables execution

IN (LINT) - value to convert

**Outputs:** OK (BOOL) - execution completed without error

OUT (LREAL) - converted value

LINT2LR(IN := <<LINT>>, OK => <<BOOL>>, OUT => <<LREAL>>)

The LINT2LR function converts a long integer into a long real. The result is placed in a variable at OUT.

---



---

## LINT2LW

*Long Integer to Long Word*

**Datatype/LINTCONV**

---



---

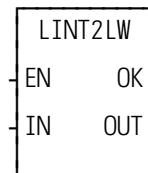

**Inputs:** EN (BOOL) - enables execution

IN (LINT) - value to convert

**Outputs:** OK (BOOL) - execution completed without error

OUT (LWORD) - converted value

LINT2LW(IN := <<LINT>>, OK => <<BOOL>>, OUT => <<LWORD>>)

The LINT2LW function converts a long integer into a long word. The result is placed in a variable at OUT.

---



---

## LINT2SI

*Long Integer to Short Integer*

**Datatype/LINTCONV**

---



---

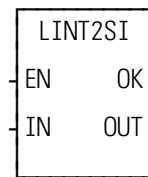

**Inputs:** EN (BOOL) - enables execution

IN (LINT) - value to convert

**Outputs:** OK (BOOL) - execution completed without error

OUT (SINT) - converted value

LINT2SI(IN := <<LINT>>, OK => <<BOOL>>, OUT => <<SINT>>)

The LINT2SI function converts a long integer into a short integer. The left most 56 bits of the long integer are truncated. The result is placed in a variable at OUT.

---



---

## LINT2ULI

*Long Integer to Unsigned Long Integer*

**Datatype/LINTCONV**

---



---

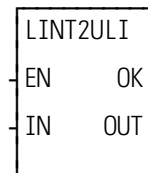

**Inputs:** EN (BOOL) - enables execution

IN (LINT) - value to convert

**Outputs:** OK (BOOL) - execution completed without error

OUT (ULINT) - converted value

LINT2ULI(IN := <<LINT>>, OK => <<BOOL>>, OUT => <<ULINT>>)

The LINT2ULI function converts a long integer into an unsigned long integer. The result is placed in a variable at OUT.

**LN**

Natural Log

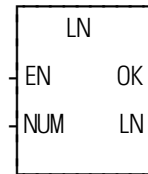
**Arith/TRIG****Inputs:** EN (BOOL) - enables execution

NUM (REAL/LREAL) - value

**Outputs:** OK (BOOL) - execution completed without error

LN (REAL/LREAL) - natural log

NOTE: The data types entered at NUM and LN must match, i.e. if NUM is REAL, then LN must be REAL.

LN(NUM := <<REAL/LREAL>>, OK => <<BOOL>>, LN => <<REAL/LREAL>>)

The LN function calculates the natural log of the number entered at NUM. The result is placed at LN.

**LOG**

Log

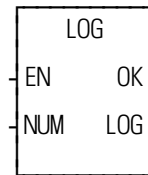
**Arith/TRIG****Inputs:** EN (BOOL) - enables execution

NUM (REAL/LREAL) - value

**Outputs:** OK (BOOL) - execution completed without error

LOG (REAL/LREAL) - log of NUM

NOTE: The data types entered at NUM and LOG must match, i.e. if NUM is REAL, then LOG must be REAL.

LOG(NUM := <<REAL/LREAL>>, OK => <<BOOL>>, LOG => <<REAL/LREAL>>)

The LOG function calculates the log of the number entered at NUM. The result is placed at LOG.

---



---

## LREA2LI

*Long Real to Long Integer*

**Datatype/LREALCNV**

---



---

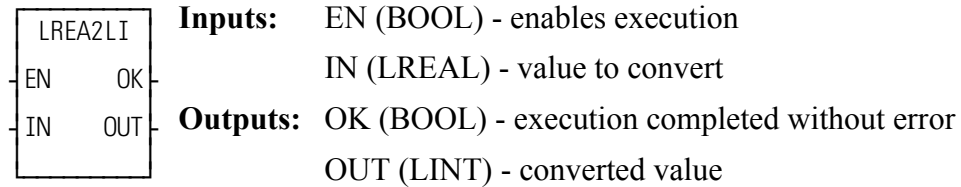

LREA2LI(IN := <<LREAL>>, OK => <<BOOL>>, OUT => <<LINT>>)

The LREA2LI function converts a long real into a long integer. The result is placed in a variable at OUT.

---



---

## LREA2LW

*Long Real to Long Word*

**Datatype/LREALCNV**

---



---

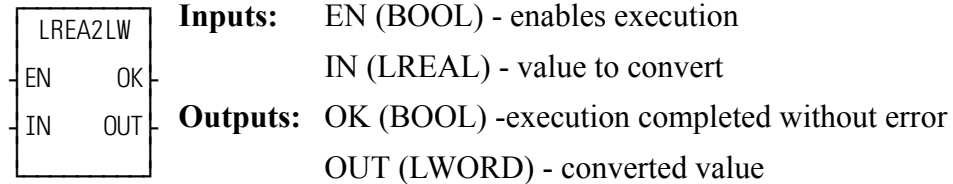

LREA2LW(IN := <<LREAL>>, OK => <<BOOL>>, OUT => <<LWORD>>)

The LREA2LW function converts a long real into a long word. The result is placed in a variable at OUT.



---



---

## LREA2RE

*Long Real to Real*

**Datatype/LREALCNV**

---



---

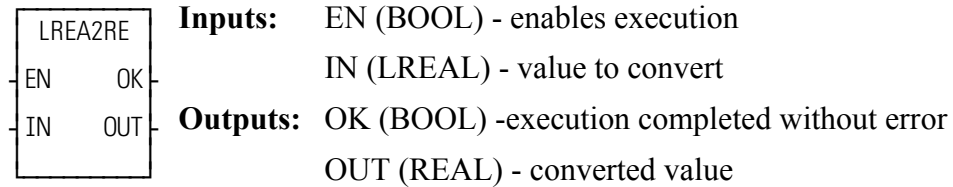

LREA2RE(IN := <<LREAL>>, OK => <<BOOL>>, OUT => <<REAL>>)

The LREA2RE function converts a long real into a real. The result is placed in a variable at OUT.

---



---

## LREA2ULI

*Long Real to Unsigned Long Integer*

**Datatype/LREALCNV**

---



---

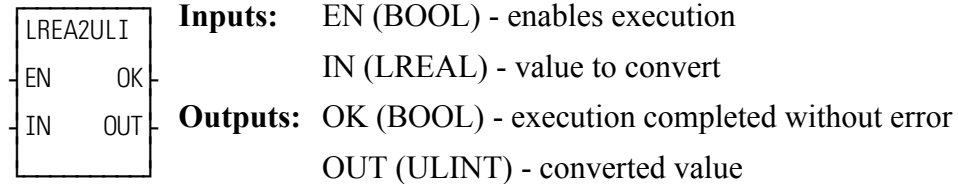

LREA2ULI(IN := <<LREAL>>, OK => <<BOOL>>, OUT => <<ULINT>>)

The LREA2ULI function converts a long real into a unsigned long integer. The result is placed in a variable at OUT.

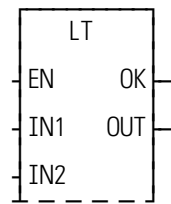
**LT***Less Than***Evaluate/LT**

**Inputs:** EN (BOOL) - enables execution  
 IN1 (ANY except BOOL or STRUCT) - value to be compared  
 IN2 (same type as IN1) - value to be compared

**Outputs:** OK (BOOL) - execution completed without error  
 OUT (BOOL) - indicates if values are less than successive values

LT(IN1 := <<ANY>>, IN2 := <<ANY>>, OK => <<BOOL>>, OUT => <<BOOL>>)

The LT function compares the value of the variable or constant at IN1 with the value of the variable or constant at IN2. This is an extensible function which can compare up to 17 inputs.

**For the inputs at IN1, IN2, ...IN17**

If  $IN1 < IN2 < IN3 < \dots < IN17$ , the coil at OUT is energized.

Otherwise the coil at OUT is not energized.

---



---

## LU2FU

Ladder Units to Feedback Units

**Motion/DATA**

---



---

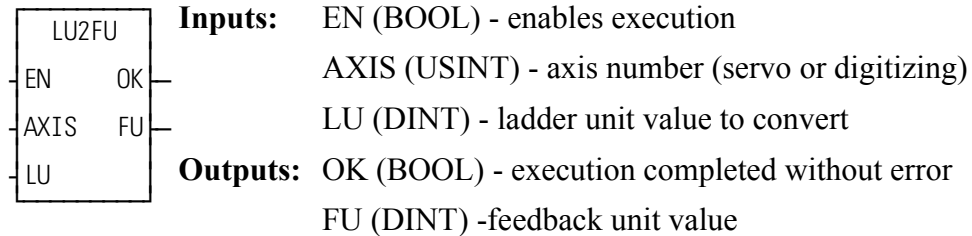

LU2FU(AXIS := <<USINT>>, LU := <<DINT>>, OK => <<BOOL>>, FU => <<DINT>>)

The LU2FU function converts the ladder unit value at LU to its equivalent feedback unit value and places the result at FU.

---



---

## LWOR2BYT

Long Word to Byte

**Datatype/LWORDCNV**

---



---

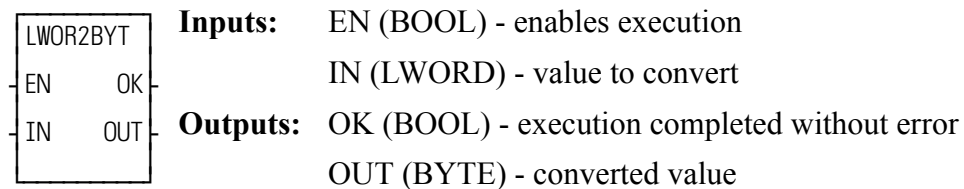

LWOR2BYT(IN := <<LWORD>>, OK => <<BOOL>>, OUT => <<BYTE>>)

The LWOR2BYT function converts a long word into a byte. The leftmost 56 bits of the long word are truncated. The result is placed in a variable at OUT.

---



---

## LWOR2DW

*Long Word to Double Word*

**Datatype/LWORDCNV**

---



---

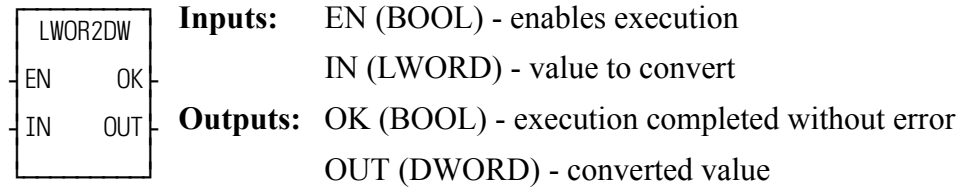

LWOR2DW(IN := <<LWORD>>, OK => <<BOOL>>, OUT => <<DWORD>>)

The LWOR2DW function converts a long word into a double word. The leftmost 32 bits of the long word are truncated. The result is placed in a variable at OUT.

---



---

## LWOR2LI

*Long Word to Long Integer*

**Datatype/LWORDCNV**

---



---

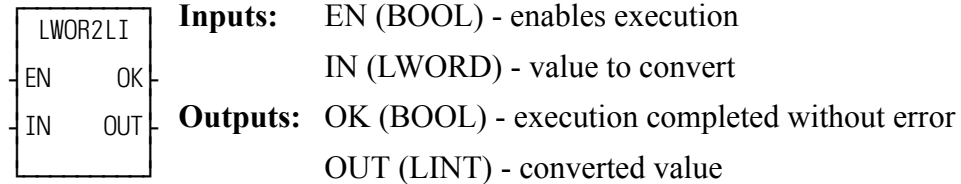

LWOR2LI(IN := <<LWORD>>, OK => <<BOOL>>, OUT => <<LINT>>)

The LWOR2LI function converts a long word into a long integer. The result is placed in a variable at OUT.

---



---

## LWOR2LR

*Long Word to Long Real*

**Datatype/LWORDCNV**

---



---

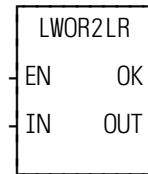

**Inputs:** EN (BOOL) - enables execution

IN (LWORD) - value to convert

**Outputs:** OK (BOOL) - execution completed without error

OUT (LREAL) - converted value

LWOR2LR(IN := <<LWORD>>, OK => <<BOOL>>, OUT => <<LREAL>>)

The LWOR2LR function converts a long word into a long real. The result is placed in a variable at OUT.

---



---

## LWOR2ULI

*Long Word to Unsigned Long Integer*

**Datatype/LWORDCNV**

---



---

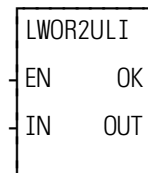

**Inputs:** EN (BOOL) - enables execution

IN (LWORD) - value to convert

**Outputs:** OK (BOOL) - execution completed without error

OUT (ULINT) - converted value

LWOR2ULI(IN := <<LWORD>>, OK => <<BOOL>>, OUT => <<ULINT>>)

The LWOR2ULI function converts a long word into an unsigned long integer. The result is placed in a variable at OUT.

---



---

## LWOR2WO

Long Word to Word

**Datatype/LWORDCNV**

---



---

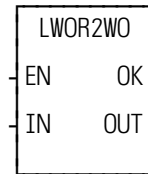

**Inputs:** EN (BOOL) - enables execution

IN (LWORD) - value to convert

**Outputs:** OK (BOOL) - execution completed without error

OUT (WORD) - converted value

LWOR2WO(IN := <<LWORD>>, OK => <<BOOL>>, OUT => <<WORD>>)

The LWOR2WO function converts a long word into a word. The leftmost 48 bits of the long word are truncated. The result is placed in a variable at OUT.

---



---

## LWR\_CASE

Lower Case

**String/LWR\_CASE**

---



---

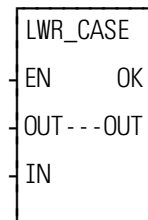

**Inputs:** EN (BOOL) - enables execution

IN (STRING) - string of characters to convert to lower case

**Outputs:** OK (BOOL) - execution completed without error

OUT (STRING) - converted string

LWR\_CASE(EN := <<BOOL>>, IN := <<STRING>>, OK => <<BOOL>>, OUT => <<STRING>>)

The LWR\_CASE function converts the characters in a string to all lower case characters. The result is placed in the string at OUT.

The OK will not be set if the number of characters in the string at IN is larger than the maximum number of characters you have declared in the string at OUT. See also UPR\_CASE function.

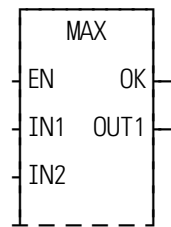
**MAX***Maximum***Filter/MAX**

**Inputs:** EN (BOOL) - enables execution  
 IN1 (ANY except BOOL and STRUCT) - value to be compared/moved  
 IN2 (same type as IN1) - value to be compared/moved

**Outputs:** OK (BOOL) - execution completed without error  
 OUT1 (same type as IN1) - moved value

MAX(IN1 := <<ANY>>, IN2 := <<ANY>>, OK => <<BOOL>>, OUT1 := <<ANY>>)

The MAX function determines which input at IN1 or IN2 has the largest (maximum) value, and places the value of that variable or constant into the variable at OUT. This is an extensible function which can output the maximum value of up to 17 variables.

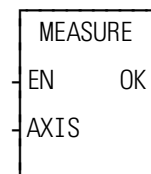
**MEASURE***Measure***Motion/MOVE\_SUP**

**Inputs:** EN (BOOL) - enables execution (**Typically one-shot**)  
 AXIS (USINT) - identifies axis (servo or digitizing)  
 NOTE: Fast input on axis feedback required.

**Outputs:** OK (BOOL) - execution completed without error

MEASURE(AXIS := <<USINT>>, OK => <<BOOL>>)

If registration or referencing are not being used but you still want the fast input to be read, the MEASURE function is used. It enables the module to respond to the fast input. It must be called once before variable 20 (Fast input distance) is read.

SERCOS NOTE: The function block SCA\_PBIT must be called and completed successfully prior to calling the MEASURE function with a SERCOS axis.

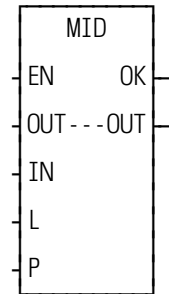
**MID***Middle String***String/MID**

**Inputs:** EN (BOOL) - enables execution  
 OUT (STRING) - output STRING  
 IN (STRING) - STRING to extract from  
 L (INT) - length  
 P (INT) - position

**Outputs:** OK (BOOL) - execution completed without error  
 OUT (same variable as OUT input)

MID(OUT := <<STRING>>, IN := <<STRING>>, L := <<INT>>, P := <<INT>>, OK => <<BOOL>>, OUT => <<STRING>>)

The MID function is used to extract characters from (the middle of) a STRING. The number of characters specified by the input at L are extracted from the variable at IN, starting at the position specified by the input at P. The resulting STRING is placed in the variable at OUT.

An error occurs if:

P = 0  
 P > 255  
 P > length of IN  
 L > 255  
 L > length of OUT

**Example of MID Function**

The value at L is 4 so four characters will be extracted from the string at IN and placed in the string at OUT. In the example below, start counting from the left.

Var at IN	Value at L	Value at P	Var at OUT
abcdefghij	4	3	cdef

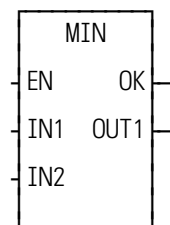

**MIN***Minimum***Filter/MIN****Inputs:** EN (BOOL) - enables execution

IN1 (ANY except BOOL and STRUCT) - value to be compared/moved

IN2 (same type as IN1) - value to be compared/moved

**Outputs:** OK (BOOL) - execution completed without error

OUT1 (same type as IN1) - moved value

MID(IN1 := <<ANY>>, IN2 := <<ANY>>, OK => <<BOOL>>, OUT1 => <<ANY>>)

The MIN function determines which input at IN1 or IN2 has the lowest (minimum) value, and places the value of that variable or constant into the variable at OUT. This is an extensible function which can output the minimum value of up to 17 variables.

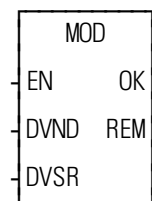
**MOD***Modulo (Remainder)***Arith/ARITH****Inputs:** EN (BOOL) - enables execution

DVND (NUMERIC or TIME dur) - dividend

DVSR (same type as DVND if DVND is numeric; DINT if DVND is TIME) - divisor

**Outputs:** OK (BOOL) - execution completed without error

REM (same type as DVND) - remainder

MOD(DVND := <<NUMERIC or TIME dur>>, DVSR := <<NUMERIC or TIME if DVND is NUMERIC, DINT if DVND is TIME>>, OK => <<BOOL>>, REM => NUMERIC or TIME dur<<)

The MOD function divides the value of the variable or constant at DVND by the value of the variable or constant at DVSR, and places the remainder in the variable at REM. If there is no remainder, zero is placed in the variable. The quotient is not returned. See the DIV function.

---

---

**MOVE***Move***Filter/MOVE**

---

---

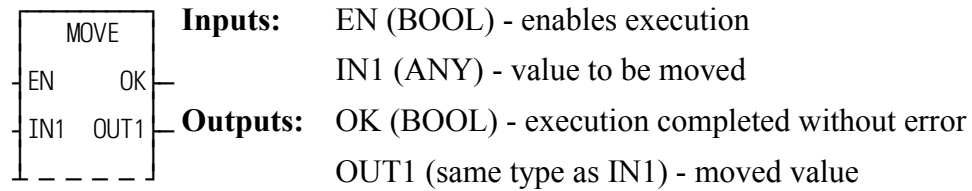

MOVE(IN1 := <<ANY>>, OUT1 => <<ANY>>)

The MOVE function puts the value of the constant or variable at IN1 into the variable at OUT1, the value of the variable or constant at IN2 into the variable at OUT2, etc. 1 to 16 inputs can be moved.

The input variables or constants to this function can be of different types. An output variable must be of the same type as its corresponding input (on the same line).

**Note:** In this extensible function, each input is moved to its corresponding output sequentially. Other extensible functions look at all the inputs first and then go to the outputs.

# MUL

Multiply

**Arith/ARITH**

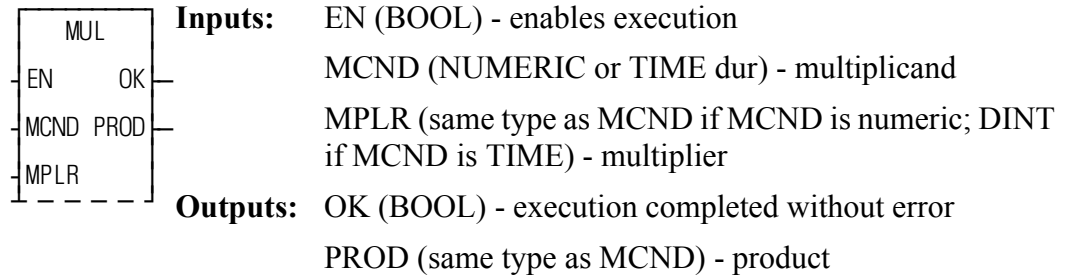

MUL(MCND := <<NUMERIC or TIME dur>>, MPLR := <<NUMERIC or TIME dur if MCND is NUMERIC, DINT if MCND is TIME >>, OK => <<BOOL>>, PROD => <<NUMERIC or TIME dur>>)

The MUL function multiplies the value of the variable or constant at MCND by the value of the variable or constant at MPLR, and places the result in the variable at PROD. This is an extensible function that can multiply up to 17 numbers.

$$\begin{array}{r} X \quad MCND \\ * Y \quad MPLR \\ \hline Z \quad PROD \end{array}$$

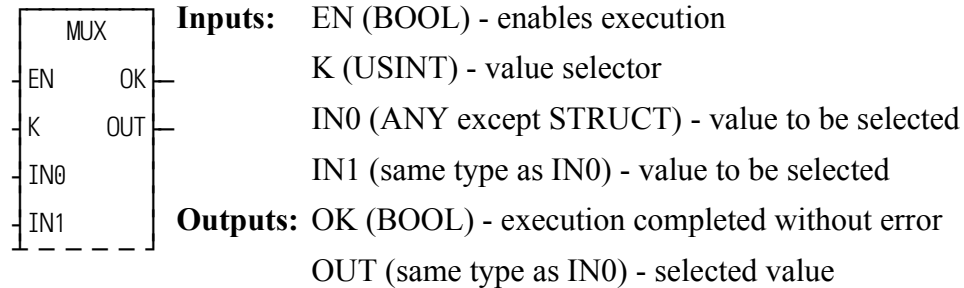
**MUX***Multiplex***Filter/MUX**

MUX(K := <<USINT>>, IN0 := <<ANY>>, IN1 := <<ANY >>, OK => <<BOOL>>, OUT => <<ANY>>)

The MUX function is used to select one of two (or more) values and place it into the output variable. The selection is based on the value of the NUMERIC input at K.

If the value at K equals 0, then the value of the variable or constant at IN0 is placed into the variable at OUT. If the input at K equals 1, then the value of the input at IN1 is placed into the variable at OUT.

This is an extensible function. Up to 17 inputs can be specified. If the value of the input at K equals 2, 3, ...16, then the value of the input at IN2, IN3, ...IN16 is placed into the variable at OUT.

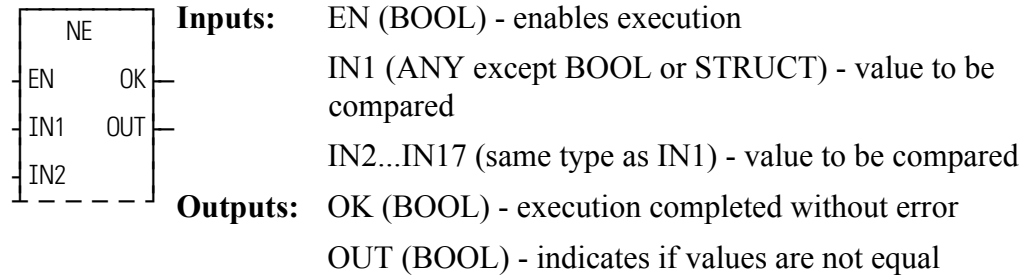
**NE***Not Equal To***Evaluate/NE**

NE(IN1 := <<ANY>>, IN2 := <<ANY>>, IN1 := <<ANY>>, IN2 := <<ANY>>, IN3 := <<ANY>> ... IN17 := <<ANY>>, OK => <<BOOL>>, OUT => <<BOOL>>)

The NE function compares the value of the variable or constant at IN1 with the value of the variable or constant at IN2.

This is an extensible function that can compare up to 17 inputs. For the inputs IN1, IN2, ... IN17, if  $IN1 \neq IN2 \neq IN3 \neq \dots \neq IN17$ , the coil at OUT is energized. Otherwise, the coil at OUT is not energized. The variable or constants at IN1 through IN17 are compared as follows:

IN1 is compared to IN2, then IN2 is compared to IN3, then IN3 is compared to IN4, ..., finally, IN16 is compared to IN17. If all of these comparisons are not equal, then the coil at OUT will be energized, otherwise the coil at OUT is not energized.

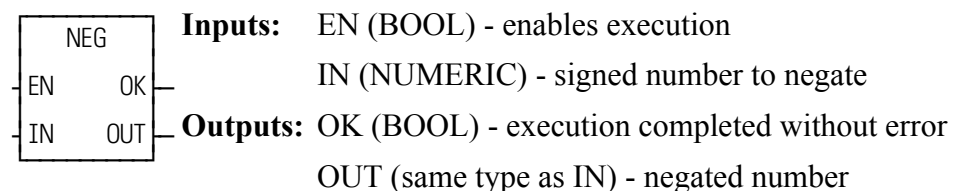
**NEG***Negate Value***Arith/ARITH**

NE(IN := <<NUMERIC>>, OK => <<BOOL>>, OUT => <<NUMERIC>>)

The NEG function negates (finds the opposite) value of the signed number at IN and places the result into the variable at OUT. The negate function on a number, x, is:  $f(x) = -x$

---



---

## NETCLS

NEXNET Network Close

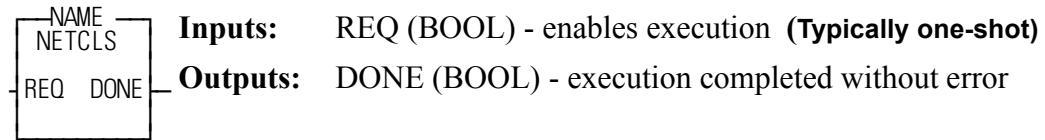
**Io/NETWORK**

```
<<INSTANCE NAME>>:NE(REQ := <<BOOL>>, DONE => <<BOOL>>);
```

The NETCLS function block closes the communication channel for this PiC, removing the node from the NEXNET network.

NETCLS should not be executed before the DONE output of the NETOPN function block has been set. If NETCLS has been executed, the NETOPN function block must execute again to re-enable communication.

---



---

## NETFRE

NEXNET Network Free

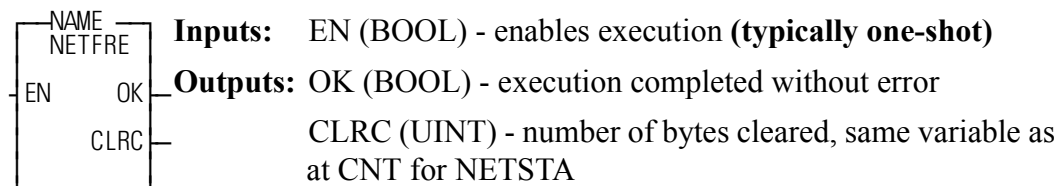
**Io/NETWORK**

```
<<INSTANCE NAME>>:NETFRE(EN := <<BOOL>>, OK => <<BOOL>>,
  CLRC => <<UINT>>);
```

The NETFRE function block clears the input buffer of data involved in the most recent receipt transaction, telling the communications daughter board that data can be received again.

NETFRE zeros the output at CLRC, which should be the same variable that is at the CNT output of the NETSTA function block.

This function block should be executed after all data for a transaction has been received. Until NETFRE executes, receipt of new data is inhibited.

**NETMON**

NEXNET Network Monitor

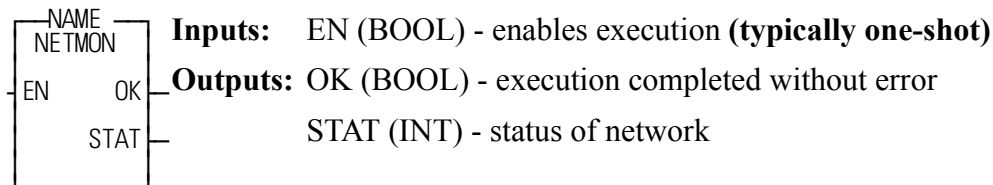
**Io/NETWORK**

```
<<INSTANCE NAME>>.NE(EN := <<BOOL>>, OK => <<BOOL>>, STAT =>
<<INT>>);
```

The NETMON function block monitors and outputs the status of the PiC network. *NETMON is for diagnostic purposes only.* Do not use it in your application LDO. Never enable the NETMON function all the time.

The status of the network is placed in the variable at STAT:

<b>STAT = 0</b>	If No receive activity and transmitter is enabled. The transmitter and/or receiver are not functioning properly.
<b>STAT = 3</b>	The node sees receive activity and sees the token. The transmitter is enabled. The network and node are operating properly.
<b>STAT = 8</b>	The node sees receive activity, but is not seeing the token. Possible causes are listed below. <ol style="list-style-type: none"> <li>1. No other nodes exist on the network.</li> <li>2. Data corruption exists.</li> <li>3. The media driver is not functioning properly.</li> <li>4. The topology is set up incorrectly.</li> <li>5. There is noise on the network.</li> <li>6. A reconfiguration is occurring.</li> </ol>

**NETOPN**

NEXNET Network Open

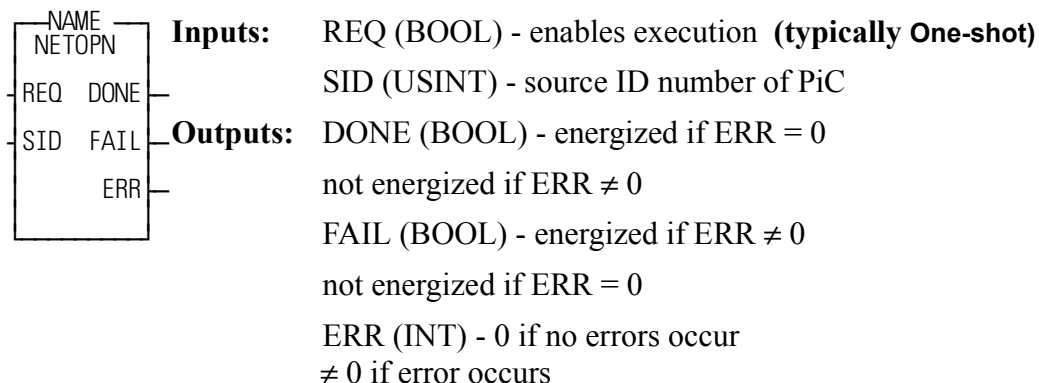
**Io/NETWORK**

```
<<INSTANCE NAME>>:NETOPN(REQ := <<BOOL>>, SID := <<USINT>>,
  DONE => <<BOOL>>, FAIL => <<BOOL>>, ERR => <<INT>>);
```

The NETOPN function block prepares the PiC (in which it is executed) for communication with another PiC. It performs the following:

1. Checks and initializes communications.
2. Assigns a unique network node number to this PiC.
3. Opens the communication channel if no errors occur.

The value at SID (Source IDentification) is assigned to this PiC as a unique node number. The value at SID should be from 1 - 255. This number is used by other PiCs in the network to reference this PiC.

If no errors occur, the output at DONE is energized, the output at FAIL is not energized, and the output at ERR equals zero.

If an error occurs, it occurs during the checking and initialization of the daughter board. The output at DONE is not energized, the output at FAIL is energized, and the output at ERR ≠ 0 as shown in the following table.



<b>ERR = 1</b>	The ARCNET hardware ID check failed.
<b>ERR = 2</b>	The transmitter is not available. An ARCNET communications failure has occurred.
<b>ERR = 3</b>	The power-on reset flag cannot be cleared. An ARCNET communications failure has occurred.
<b>ERR = 4</b>	The SID specified is assigned to another node. Check SID numbers.
<b>ERR = 5 to 44</b>	Check Appendix B in the PiCPro Online Help for errors connected to the OPEN function block.
<b>ERR &gt; 1XXX</b>	The node number has been set by PiCPro and is different than the number you entered at the SID input. The XXX holds the PiCPro node number 001 through 255.

All PiCs in a network should execute the NETOPN function block one time (the input at REQ should be a one-shot) before they execute any other NEXNET function blocks.

Other NEXNET function blocks are: NETCLS, NETFRE, NETMON, NETRCV, NETSND, and NETSTA.

If a PiC has executed a NETCLS, it must execute NETOPN again to re-enable communications.

**NETRCV**

NEXNET Network Receives

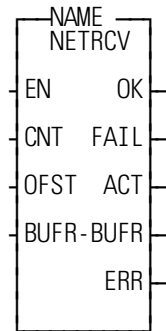
**Io/NETWORK**

**Inputs:** EN (BOOL) - enables execution (**Typically one-shot**)  
 CNT (INT) - number of bytes to read  
 OFST (UINT) -offset from start of BUFR  
 BUFR (memory area) - destination of data  
*memory area* is a STRING, ARRAY, or STRUCTURE

**Outputs:** OK (BOOL) -energized immediately after enable if  
 ERR = 0  
 not energized if ERR = 1 or 2  
 FAIL (BOOL) - energized if ERR = 1 or 2  
 not energized if ERR = 0  
 ACT (INT) - number of bytes received  
 BUFR (same variable as BUFR input)  
 ERR (INT) - 0 if no errors occur  
 1 or 2 if an error occurs

```
<<INSTANCE NAME>>:NETRCV(EN := <<BOOL>>, CNT := <<INT>>,
  OFST := <<UINT>>, BUFR := <<MEMORY AREA>>, OK => <<BOOL>>,
  FAIL => <<BOOL>>, ACT => <<INT>>, BUFR => <<INT>>, ERR =>
  <<INT>>);
```

The NETRCV function block “reads” data from the input buffer (of the communications hardware) and places it in a data memory area.

The number of bytes specified by the value at CNT are read and placed within the memory area specified at BUFR. The value of CNT should be such that:

$$1 \leq \text{CNT} \leq 494.$$

**IMPORTANT**

When receiving a STRING, the length specified should be the number of characters indicated by the CNT output of NETSTA.

The data is placed in BUFR starting at OFST bytes past the first byte of BUFR. (If OFST equals 0, 1, 2, etc. the data starts at 0, 1, 2, etc. bytes past the beginning of BUFR).

The number of bytes actually read is placed in the variable at ACT. The value of ACT will be less than the value of CNT when an error occurs. Otherwise the value of ACT will equal the value of CNT.

Multiple NETRCV function blocks may be executed to sequentially read the data from one transaction, allowing for the separation of the data into different memory areas. The total number of bytes read by one or more NETRCVs should equal the value of the CNT output of the NETSTA function block.

If an error occurs the output at DONE is not energized, the output at FAIL is energized, the value at ACT equals 0, the value at BUFR is unchanged, and the output at ERR equals 1 or 2.

<b>ERR = 1</b>	There is no data in the input buffer to receive.
<b>ERR = 2</b>	The value of CNT is greater than the number of bytes in the input buffer.  NOTE: The NETFRE function block should be executed after all data (for one transaction) has been read from the input buffer.

---

---

**NETSND**

NEXNET Network Sends

**I<sup>o</sup>/NETWORK**

---

---

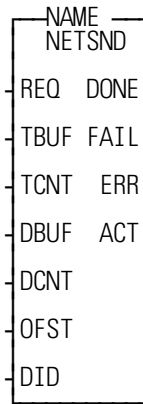

**Inputs:** REQ (BOOL) - enables execution (**typically one-shot**)  
TBUF (memory area\*) - optional protocol data  
TCNT (INT) - # of bytes to send from TBUF  
DBUF (memory area\*) - data to be sent  
DCNT (INT) - # of bytes to send from DBUF  
OFST (UINT) - offset from start of DBUF  
DID (USINT) - destination PiCs  
*\*memory area* is a STRING, ARRAY, or STRUCTURE

**Outputs:** DONE (BOOL) - energized if ERR = 0  
not energized if ERR ≠ 0  
FAIL (BOOL) - energized if ERR ≠ 0  
not energized if ERR = 0  
ERR (INT) - 0 if transfer successful  
≠ 0 if transfer unsuccessful  
ACT (INT) - actual number of bytes sent

```
<<INSTANCE NAME>>:NETSND(REQ := <<BOOL>>, TUBF := <<MEMORY AREA>>, TCNT := <<INT>>, DBUF := <<MEMORY AREA>>, DCNT := <<INT>>, OFST := <<UINT>>, DID := <<USINT>>, DONE => <<BOOL>>, FAIL => <<BOOL>>, ERR => <<INT>>, ACT => <<INT>>);
```

The NETSND function block sends data from this PiC to another PiC or all networked PiCs (broadcast message). NETSND transfers protocol data from the memory area specified at TBUF and/or data from the memory area specified at DBUF.

Protocol data is not required. If protocol data is created, the value of TCNT should specify the number of bytes of protocol (at TBUF). If protocol data is not used, there should be a null input at TBUF and the value at TCNT should be 0.

The value at DCNT specifies the number of bytes to send from the entry at DBUF.

The data that is transferred from within DBUF starts at OFST bytes past the beginning of DBUF. (If OFST equals 0, 1, 2, etc. then the data sent starts at 0, 1, 2, etc. bytes past the first byte of DBUF.)

It is required that  $TCNT + DCNT \leq 494$ .

The receiving PiCs should have a memory area that is equivalent to the data being sent defined at the BUFR input to the NETRCV function block(s).

**IMPORTANT**

When sending a STRING, the length specified should be the number of characters plus 2 (bytes).

The value at DID should be from 0 - 255. If the value at DID is 0, the data is sent to all other PiCs in the network. If the value at DID is 1 - 255, the data is sent to the PiC with that SID.

If an error occurs, the output at DONE is not energized, the output at FAIL is energized, the value at ERR equals an error number (see below) and the value at ACT is 0.

<b>ERR = 1</b>	The transmitter is unavailable. A previous send has not completed.
<b>ERR = 2</b>	The message failed to be acknowledged as received within 900 milliseconds.
<b>ERR = 3</b>	An attempt was made to send more than 494 bytes.
<b>ERR = 4</b>	There is no TBUF input to the function block when protocol data is created.
<b>ERR = 5</b>	There is no DBUF input to the function block.
<b>ERR = 6 to 44</b>	Check Appendix B in the PiCPro Online Help for errors connected to the WRITE function block.

**Note:** This PiC should execute the NETSND function only after it has set the DONE output of the NETOPN function block.

---

---

**NETSTA**

NEXNET Network Status

**Io/NETWORK**

---

---

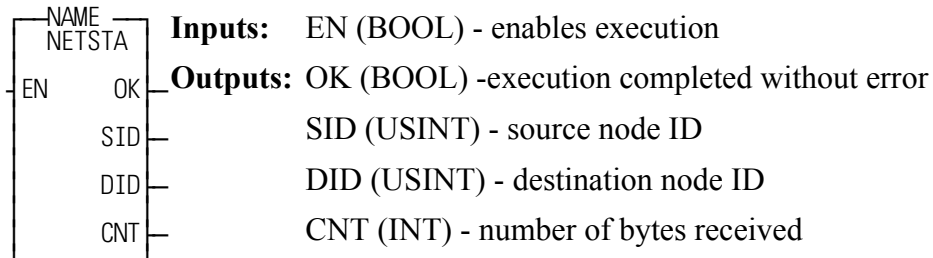

```
<<INSTANCE NAME>>:NETSTA(EN := <<BOOL>>, OK => <<BOOL>>, SID
=> <<USINT>>, DID => <<USINT>>, CNT => <<INT>>);
```

The NETSTA function block outputs the number of bytes that are in this PiC's daughter board input buffer (sent by another PiC). It also outputs the node number of the sending PiC and the node number of this (receiving) PiC.

The number of the sending PiC (1 - 255) is placed in the variable at SID. The value at SID equals 0 if there is no data in the buffer.

The number of this PiC is placed in the variable at DID. The value at DID equals 0 if the data is a broadcast or if there is no data in the buffer.

The number of bytes in the input buffer is placed in the variable at CNT. This value indicates how many bytes should be read or received (by one or more NETRCV function blocks). The value at CNT equals 0 if there is no data in the buffer.

If only one NETRCV function block is executed to read the data from the input buffer, then the CNT output value of NETSTA should equal the CNT input value to the NETRCV.

If more than one NETRCV function block is executed to read the data from the input buffer, then the sum of the bytes read by the NETRCVs should equal the CNT value from NETSTA.

**Note:** Ensure that the DONE output of the NETOPN function block is set (the communication channel is open) before NETSTA executes.

---

---

**NEWRATIO***New Ratio***Motion/MOVE\_SUP**

---

---

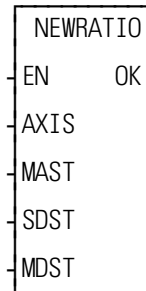

**Inputs:** EN (BOOL) - enables execution  
 AXIS (USINT) - identifies the slave axis (servo)  
 MAST (USINT) - identifies the master axis the slave axis follows in the ratio move  
 SDST (DINT) - (slave distance) indicates the new distance the slave should move for each MDST distance (entered in LU\*)  
 MDST (DINT) - (master distance) indicates the new distance the master axis will move during each SDST (entered in LU\*)

\*NOTE: The range of values entered in SDST and MDST is -536870912 to +536870911 FU (excluding 0 for the MDST input.) If you are using ladder units, make sure they do not exceed this range when converted to feedback units.

**Outputs:** OK (BOOL) - execution complete without errors

NEWRATIO(AXIS := <<USINT>>, MAST := <<USINT>>, SDST := <<DINT>>, MDST := <<DINT>>, OK => <<BOOL>>)

The NEWRATIO function allows you to change the current constant ratio in a RATIO\_GR or a RATIOSYN move and change the default ratio in a RATIOSLP move.

**Changing the ratio in RATIO\_GR and RATIOSYN**

You define a constant ratio when using the RATIO\_GR or RATIOSYN moves. The NEWRATIO function is called after the RATIO\_GR or RATIOSYN move is active and allows you to change this constant ratio. The new ratio takes effect after the next servo interrupt.

The function does not use the queue but changes the ratio of the move in the active queue.

**Changing the default ratio in RATIOSLP and RATIO\_RL**

The RATIOSLP and RATIO\_RL moves have a default ratio of 1:1. The NEWRATIO function is normally called before the move is active and allows you to change this default ratio.

## NEWRATIO

If the NEWRATIO function is called after the move, the current ratio of the move is used initially and the ratio defined by NEWRATIO takes effect after the next servo interrupt.

The OK will not be set if any of the following programming errors occur:

1. Master axis not available
2. Master distance not valid
3. Slave distance not valid.

### **IMPORTANT**

Whenever the NEWRATIO function is called, it *always* sets the default ratio for a RATIOSLP move.

If, for example, the NEWRATIO function is called for a RATIO\_GR or RATIOSYN move, and later a RATIOSLP move is called, the RATIOSLP move will also use the ratio established in the NEWRATIO function as its default ratio.

If you do not want to use this ratio, call the NEWRATIO function again.



---

---

**NEW\_RATE***New Rate***Motion/MOVE\_SUP**

---

---

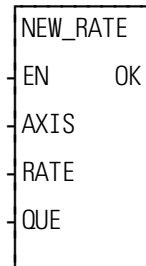

**Inputs:** EN (BOOL) - enables execution  
 AXIS (USINT) - identifies axis (servo)  
 RATE (UDINT) - new feedrate (entered in LU/MIN)  
 QUE (USINT) - number of move whose rate you want to change

**Outputs:** OK (BOOL) - execution completed without error

NEW\_RATE(AXIS := <<USINT>>, RATE := <<UDINT>>, QUE := <<USINT>>, OK => <<BOOL>>)

The NEW\_RATE function allows the rate of the move identified by the queue number to be changed. The move identified by the queue number can be in the active or next queue.

If a “0” is entered in QUE, the new feedrate only affects the move in the active queue.

---

---

**NOT**

Not

**Binary/NOT**

---

---

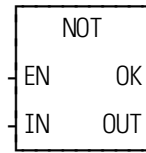
**Inputs:** EN (BOOL) - enables execution

IN (BITWISE) - number to be complemented

**Outputs:** OK (BOOL) - execution completed without error

OUT (same type as IN) - complemented number

NOT(IN := <<BITWISE>>, OK => <<BOOL>>, OUT => <<BITWISE>>)

The NOT function *complements* the variable or constant at IN and places the result in the variable at OUT. The net effect of this function is that the bits of the output variable are the reverse of the bits of the input variable or constant.

If bit x of the input is 0 then bit x of the output is 1. If bit x of the input is 1 then bit x of the output is 0.

**Example of NOT function:**

Value at IN	Value at OUT
11001010	00110101

# NUM2STR

Numeric to String

Datatype/NUM2STR

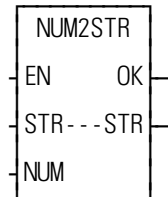

**Inputs:** EN (BOOL) - enables execution  
 STR (STRING) - output STRING  
 NUM (NUMERIC) - number to convert (may include plus (+) or minus (-) sign)

**Outputs:** OK (BOOL) - execution completed without error  
 STR (same variable as STR input) - output STRING

NUM2STR(STR := <<STRING>>, NUM := <<NUMERIC>>, OK => <<BOOL>>, STR => <<STRING>>)

The NUM2STR function converts the numeric variable or constant at NUM into a STRING, and places the result into the variable at STR. If the length of the variable at STR is not adequate to hold the value (from NUM), the output at OK will not energize and the value of the variable at STR will be null (STRING length of zero).

When converting REAL or LREAL floating point numbers, the output follows the following format.

	REAL	LREAL
<b>Minimum size of string</b>	13 characters	23 characters
<b>String output</b>	<p style="text-align: center;">                     Sign of the mantissa                      Single digit to left of decimal point                      6 digits to right of decimal point                      Sign of the exponent                      2 digits of the exponent                      +1.234567 E + 10                      Mantissa      Exponent                 </p>	<p style="text-align: center;">                     Sign of the mantissa                      Single digit to left of decimal point                      15 digits to right of decimal point                      Sign of the exponent                      3 digits of the exponent                      +1.234567890123456 E + 123                      Mantissa      Exponent                 </p>

---



---

## OK\_ERROR

Any Function OK error in existing network

**Evaluate/OK\_ERROR**

---



---

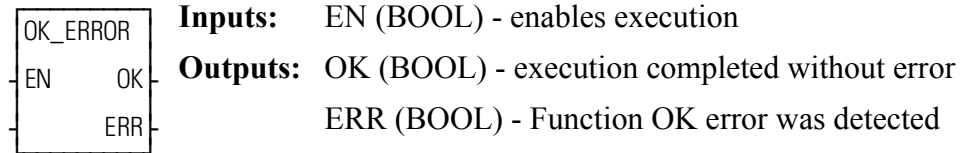

OK\_ERROR(OK => <<BOOL>>, ERR => <<BOOL>>)

The OK\_ERROR function evaluates the condition of the OK outputs of all functions from the beginning of the network to this function. If the OK of all the included functions are set, the ERR output of the OK\_ERROR function will be energized. If the OK of any of the included functions is not set, the ERR output will be energized.

**Note:** All Function Blocks and Functions whose EN is not energized, are not evaluated and are ignored by the OK\_ERROR function.

The primary purpose of this function is to detect runtime errors in expressions used in Structured Text networks. Typical runtime errors that might occur are Overflow, divide by zero, etc. In a Ladder network these run-time errors are detected by examining the output at OK on functions such as ADD, MULT, etc. Since Structured Text expressions do not have this output directly accessible, the OK\_ERROR function should be called to detect these runtime errors.

**Example:**

```
FORCE := MASS * ACCEL;
OK_ERROR(ERROR:=ERROR);
```

If a runtime error occurs in the calculation MASS \* ACCEL, then ERROR will be energized, otherwise it will not be energized.

**OPEN**

Open

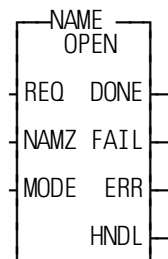
**I<sup>o</sup>/COMM**

**Inputs:** REQ (BOOL) - enables execution (**One-shot**)  
 NAMZ (STRING) - name of file/device  
 MODE (INT) - mode in which to open channel

**Outputs:** DONE (BOOL) - energized if ERR = 0  
 not energized if ERR ≠ 0  
 FAIL (BOOL) - energized if ERR ≠ 0  
 not energized if ERR = 0  
 ERR (INT) - 0 if data transfer successful  
 ≠ 0 if data transfer not successful  
 HNDL (INT) - unique communication number

*See Appendix B in the PiCPro Online Help for ERR codes.*

```
<<INSTANCE NAME>>:OPEN(REQ := <<BOOL>>, NAMZ := <<STRING>>,
  MODE := <<INT>>, DONE => <<BOOL>>, FAIL => <<BOOL>>, ERR =>
  <<INT>>, HNDL => <<INT>>);
```

The OPEN function block prepares a file or device for a sequential read/write. It performs three functions.

1. It accepts the name of the file or device from the input at NAMZ.
2. It accepts the mode in which the file/device should be opened from the input at MODE.
3. It assigns a unique number (called a *handle*) for the file/device and mode, and places the number into the variable at HNDL.

A maximum of 10 modes can be assigned for files/devices at one time. A READ and WRITE or an APPEND equals two modes. All others equal one.

Input variable	Enter this	To do this
NAMZ*	PICPRO:c:\sub\filename.ext\$00 RAMDISK:sub\filename.ext\$00 FMSDISK:filename.ext\$00*** USER:\$00	open workstation DOS files** open RAMDISK files open FMSDISK files open User Port
MODE**	16#601 16#602 16#603 16#604	READ ONLY WRITE ONLY**** READ and WRITE APPEND (READ and WRITE - start write at end of file)

## **OPEN**

\* PICPRO, RAMDISK, FMSDISK, and USER must be entered in capital letters, followed by a colon (:). A full (directory) path must be specified for files. The \$00 characters are required at the end. NOTE: The total number of characters is limited to 77.

\*\* Workstation files can be opened only in the read (16#601) or write (16#602) mode; and only one workstation file at a time can be open.

\*\*\* FMSDISK files can be opened only in the read mode.

\*\*\*\* If there is an existing file, opening it in the write only mode will delete the existing data. The new data will then be written to it. A subdirectory can be created by opening in the WRITE ONLY mode. If the subdirectory and filename do not exist when the OPEN is performed, both will be created.

OPEN is used in conjunction with the CLOSE, CONFIG, READ, SEEK, STATUS, and WRITE I/O function blocks.

---



---

## OPENLOOP

Open Loop

**Motion/INIT****Inputs:** EN (BOOL) - enables execution (**One-shot**)

AXIS (USINT) - identifies axis (servo)

**Outputs:** OK (BOOL) - execution completed without error

```
OPENLOOP(AXIS := <<USINT>>, OK => <<BOOL>>)
```

The position loop for the designated axis is opened when the OPENLOOP function is activated. The servo software instructs the analog output to send a zero-volt signal to the drive.

If the drive has been properly adjusted, the zero-volt signal will cause it to hold the motor at zero velocity. If the drive has not been adjusted properly, the motor may “drift.”

No other commands can be sent until the loop is closed again. See also CLOSLOOP.

### Digital Drive Notes:

If OPENLOOP is called while the digital drive is in Velocity Mode, the software drive enable will be reset, the velocity loop will be opened, and the command velocity will be set to zero. While the loop is open, the command velocity will be held at zero.

If OPENLOOP is called while the digital drive is in Torque Mode, the software drive enable will be reset, the torque loop will be opened, and the command current will be set to zero. While the loop is open, the command current will be held at zero.

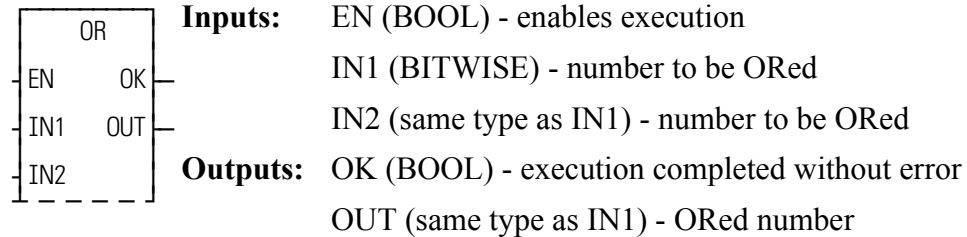
**OR***Or (Inclusive)***Binary/OR**

OR(IN1 := <<BITWISE>>, IN2 := <<BITWISE>>, OK => <<BOOL>>, OUT => <<BITWISE>>)

The OR function ORs the variable or constant at IN1 with the variable or constant at IN2, and places the results in the variable at OUT. This is an extensible function which can OR up 17 inputs.

The OR function places a 1 in bit x of the output variable when bit x of one or more (including all) input variables equals 1. A zero is placed in bit x of the output variable if bit x of all input variables equals 0.

**Example of OR function (on three inputs):**

11000011	value at IN1
10101010	value at IN2
<u>11001100</u>	<u>value at IN3</u>
<u>11101111</u>	<u>value at OUT</u>



---



---

## PART\_CLR

Part Reference Clear

**Motion/REF**

---



---

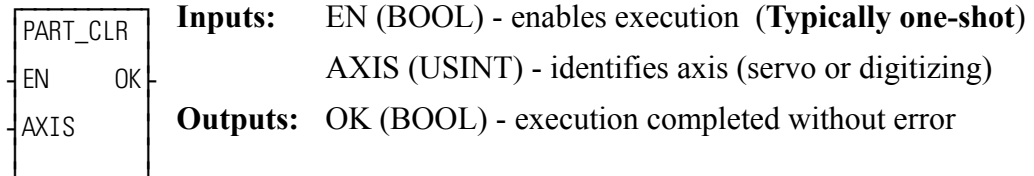

PART\_CLR(AXIS := <<USINT>>, OK => <<BOOL>>)

The PART\_CLR function cancels the part reference dimension (See PART\_REF below). The axis reverts to the original reference value.

An axis can be “part referenced” several times. The PART\_CLR function will cancel all part references as if no part reference had occurred.

**Note:** This function can be used with the stepper axis module.

---

---

**PART\_REF***Part Reference***Motion/REF**

---

---

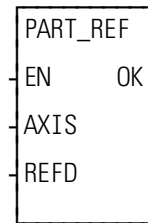

**Inputs:** EN (BOOL) - enables execution (**One-shot**)  
 AXIS (USINT) - identifies axis to be part referenced (servo or digitizing)  
 REFD (DINT) - reference dimension entered in LU. If REFD is outside the range of: -536,870,910 to 536,870,911 FU, the OK will not be set.

**Outputs:** OK (BOOL) - execution completed without error

PART\_REF(AXIS := <<USINT>>, REFD := <<DINT>>, OK => <<BOOL>>)

The part reference function allows you to change the current position of an axis. No motion occurs when a part reference is performed. The reference dimension value at REFD will become the new current position for the axis specified at AXIS. This reference dimension will remain in effect until it is canceled using the PART\_CLR function or replaced by a new part reference.

A servo axis must be at rest when a part reference is performed. A digitizing axis can be in motion when a part reference is performed.

This function can be used with the stepper axis module.

---



---

**PID**

Proportional, Integral, Derivative

**Io/PID**

---

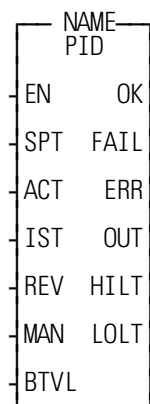

**Inputs:** EN (BOOL) - enables execution (timer output)  
 SPT (DINT) - setpoint value of the control variable specified as a scaled value between  $\pm 2,147,483,646$   
 ACT (DINT) - actual value of the control variable in same units as setpoint value  
 IST (STRUCT) - structure holding PID variables  
 REV - (BOOL) - reverse sign on output  
 MAN - (BOOL) - Manual/auto mode  
 BTVL - (DINT) - bumpless transfer value

**Outputs:** OK (BOOL) - execution completed without error  
 FAIL (BOOL) - set if  $ERR \neq 0$   
 ERR (SINT) - 0 = no error; 1 = math overflow error  
 OUT (DINT) - value of the output in the range of  $\pm 2,147,483,646$   
 HILT (BOOL) - set if output was limited by the HIGH limit  
 LOLT (BOOL) - set if output was limited by the LOW limit

```
<<INSTANCE NAME>>:PID(EN := <<BOOL>>, SPT := <<DINT>>, ACT :=
  <<DINT>>, IST := <<MEMORY AREA>>, REV := <<BOOL>>, MAN :=
  <<BOOL>>, BTVL := <<DINT>>, OK => <<BOOL>>, FAIL => <<BOOL>>,
  ERR => <<SINT>>, OUT => <<DINT>>, HILT => <<BOOL>>, LOLT =>
  <<BOOL>>);
```

**Background information on PID control**

When a process characteristic such as level, speed, temperature, pressure, flow, etc. is being monitored and controlled, the PID function block can be used to maintain the desired or setpoint value for the process. The actual process characteristic could deviate from the desired setpoint due to disturbances in the system. This deviation is the error.

$$E = \text{setpoint (SPT)} - \text{actual (ACT)}$$

or

$$E = \text{actual (ACT)} - \text{setpoint (SPT)}$$

Once an error is detected, the PiC will modify the output to the process in an attempt to force the error to zero. The purpose of the PID function is to act on this error in one or a combination of the ways listed below.

	<b>Definition</b>	<b>Characteristics</b>
Proportional	establishes an output whose value is proportional to the value of the instantaneous error. (P)	<ul style="list-style-type: none"> <li>* Fast response</li> <li>* Easy to use</li> <li>* Always some error (offset) between setpoint and actual</li> </ul>
Integral or reset	establishes an output whose value is proportional to the error over a period of time. (I)	<ul style="list-style-type: none"> <li>* Provides most correction for slowly changing processes</li> <li>* Eliminates the inherent offset of proportional only control</li> <li>* Adversely affects stability</li> </ul>
Derivative or rate	establishes an output whose value is proportional to the rate of change of the error. (D)	<ul style="list-style-type: none"> <li>* Provides most correction for rapidly changing processes</li> <li>* Almost anticipates correction needed</li> <li>* Cannot be used alone</li> <li>* Does not reduce the inherent offset</li> </ul>

The process output can be controlled by using P, PI, PID, or PD depending on the desired response for the process.

The PID function block is designed to provide proportional, integral, and derivative control for processing applications. There are two PID algorithms available to use in a PID control loop. The function block must be declared in the software declaration table.

The desired setpoint for the process variable is entered at SPT (setpoint). The actual (ACT) input specifies the measured value of the process variable.

If REV input is set, the sign on the PID output is reversed.

A bumpless transfer feature is available with the MAN and BTVL inputs. The MAN is a manual/automatic boolean switch. When it is set, the value at the BTVL input is the value at the OUT output. The algorithm updates the integral accumulator. This prevents the accumulation of an integral error during the manual mode. Then when the MAN input is cleared, the transfer to PID control is smooth.

The FAIL output will be set if a math overflow error occurs. A 1 appears at the ERR output. The function output will be the output of the last iteration that did not fail.

The IST is an input structure to the PID function block. The members are described below.

**IMPORTANT**

The structure you enter in the software declarations table for the IST input must have the members entered in the order shown below. The data type for each member of the structure must be as shown in the **Type** column in order for the software to recognize the information.

Put initial values for the following structure members in the Init. Val column: KP, KI, KD, TS, KDFT, FP, FD, DBPLUS, DBMINUS, HIGH, LOW, and EXOP.

The software assigns values to PROP, INTG, and DERV.

*The initial values for these three structure members must be 0.*

**Structure for the IST input of PID function block**

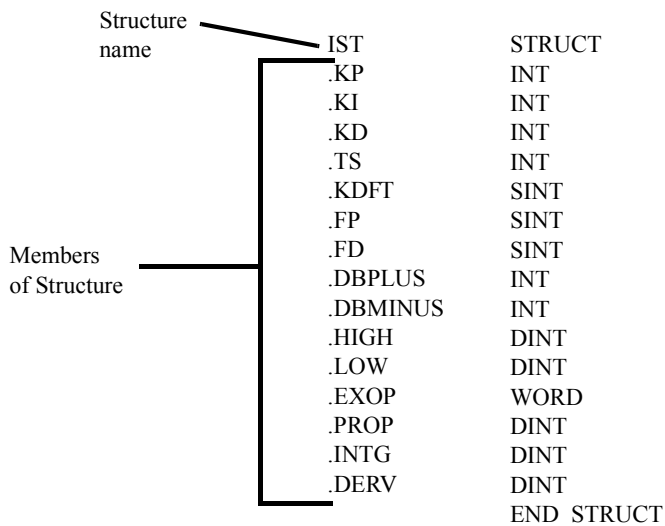

### The IST structure members

<b>KP</b> (proportional)	<b>INT</b> (write) Proportional gain ( $K_p$ ) * 100 [For example, P of 0.55 entered as 55]
<b>KI</b> (integral)	<b>INT</b> (write) Reciprocal of the integral time ( $f(1, T_i)$ ) * 100 (time units)
<b>KD</b> (derivative)	<b>INT</b> (write) Derivative time ( $T_d$ ) * 100 (time units)
<b>TS</b> (sample time)	<b>INT</b> (write) PID sample time in seconds * 100  TS represents the sample time used to calculate the integral and derivative gains for the PID loop as shown in the equations below.  NOTE: The TS value is the product of the PID sample time (the PID enable period) times 100. For example, a 10 ms sample results in a TS value of 1 ( $0.010 * 100$ ) and a 200 ms sample results in a TS value of 20 ( $0.200 * 100$ ).

A filter value for the derivative term can be entered at KDFT. Filters for the proportional and derivative errors can be entered at FP and FD respectively.

<b>KDFT</b> (derivative filter)	<b>SINT</b> (write) Filter value for the derivative term in percent (derivative change limit)
<b>FP</b> (proportional filter)	<b>SINT</b> (write) Proportional error filter in percent (100% = no filtering)
<b>FD</b> (derivative error filter)	<b>SINT</b> (write) Derivative error filter in percent (100% = no filtering)

A deadband is used to set up a range on either side of the setpoint where the output does not change if the error remains within the range or band. This allows you to control how close the actual value will match the setpoint value without changing the output. The range is entered in DBPLUS and DBMINUS.

<b>DBPLUS</b> (positive deadband)	<b>INT</b> (write) Deadband in the positive direction of out (OUT + DB)
<b>DBMINUS</b> (negative deadband)	<b>INT</b> (write) Deadband in the negative direction of out (OUT - DB)

An anti-reset windup feature is available with the HIGH and LOW limits. It prevents the integral gain from becoming excessive or winding up when the limits are reached. The output will be held at the value it was during the previous iteration whenever the high or low limit is encountered.

(The HILT and LOLT outputs are set respectively if the HIGH or LOW limits are encountered.)

<b>HIGH</b> (high limit)	<b>DINT</b> (write) Output high limit used for integral accumulator high saturation limit. Same units as setpoint.
<b>LOW</b> (low limit)	<b>DINT</b> (write) Output low limit used for integral accumulator high saturation limit. Same units as setpoint.  NOTE: HIGH and LOW are used for anti-reset windup.

The word available with the EXOP gives you four options.

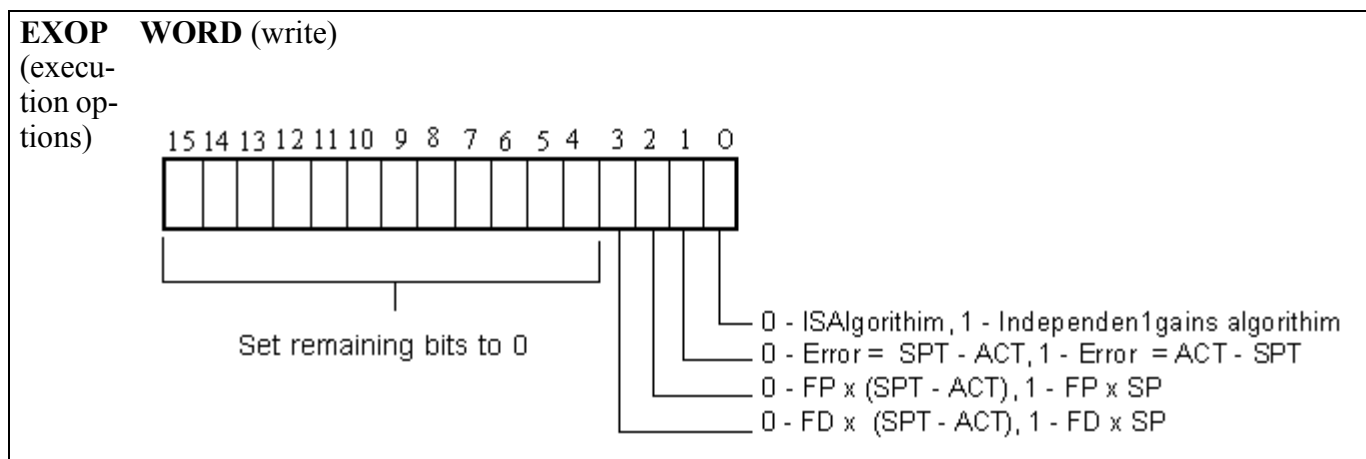

**EXOP Bit 0**

The PID function block gives you a choice of two algorithms in the EXOP member of the IST structure at bit 0.

1. The ISA algorithm
2. The independent gains algorithm

The terms used in the following equations are described here:

<b>Equation Term</b>	<b>(Function Term)</b>	<b>Description</b>
Mn	(OUT)	= output
Kp	(KP)	= proportional gain constant
Ts	(TS)	= sample rate
Ki	(KI)	= integral gain constant
Kd	(KD)	= derivative gain constant
Ej	-----	= error the jth iteration
DCL	(KDFT)	= derivative change limit
D (j - 1)	-----	= derivative from previous iteration

The following continuous equation performs the calculation with the ISA algorithm:

$$M(t) = Kp \left\{ e(t) + Ki \cdot \int^t e(t) dt + Kd \cdot \frac{de(t)}{dt} \right\}$$



The discrete equation is shown below:

$$M_j = K_p \left\{ E_j + T_s \cdot K_i \cdot \sum_{j=0}^{j=n} \frac{E_j + E(j-1)}{2} + \frac{K_d}{T_s} [E_j - E(j-1)] \cdot DCL + [D(j-1) \cdot (1 - DCL)] \right\}$$

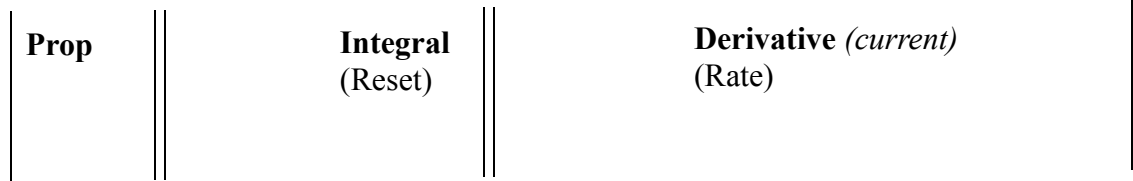

The block diagram below illustrates the ISA algorithm.

**Figure 2-6. Block diagram of ISA algorithm**

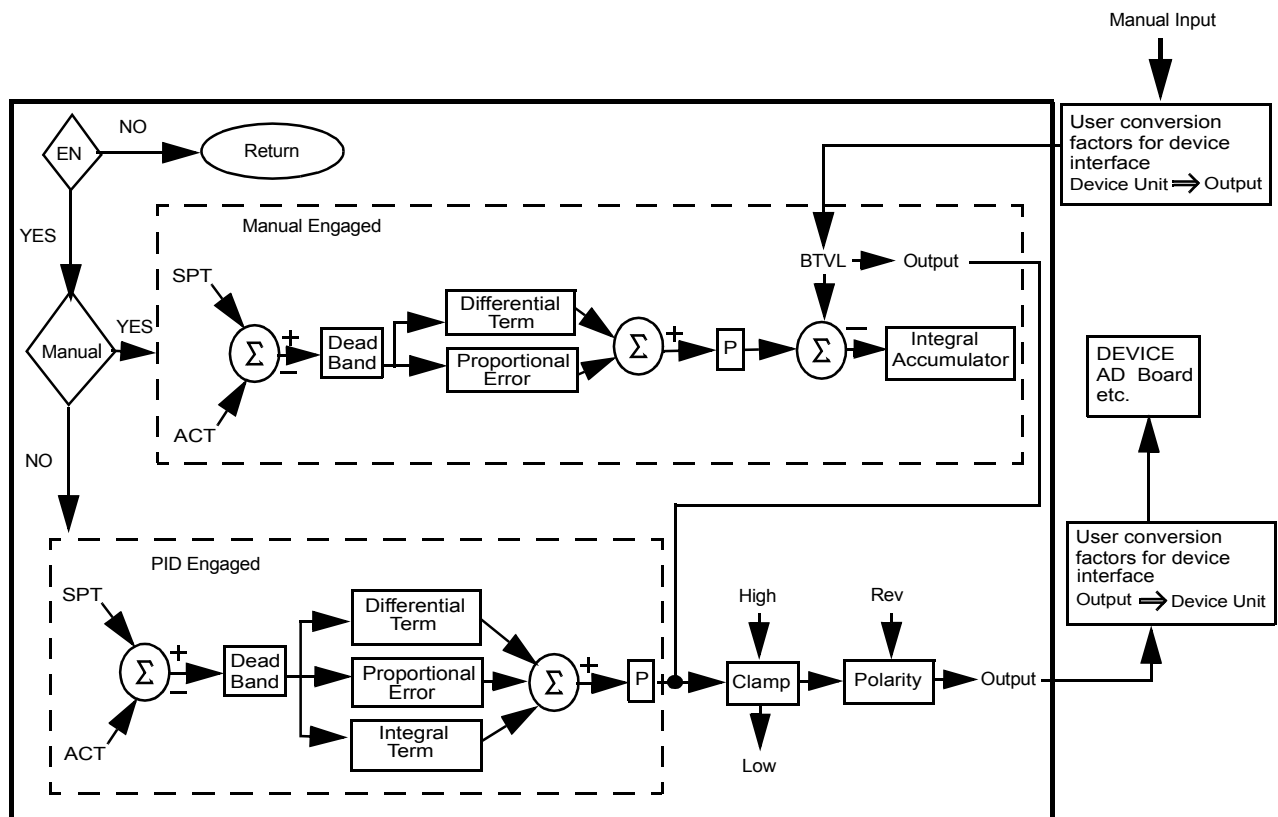

The following continuous equation performs the calculation with the independent gains algorithm:

$$M(t) = Kp \cdot e(t) + Ki \cdot \int_0^t e(t) dt + Kd \cdot \frac{de(t)}{dt}$$

The discrete equation is shown below:

$$M_j = Kp \cdot E_j + KiTs \cdot \sum_{j=0}^{j=n} \frac{E_j + E_{(j-1)}}{2} + \frac{Kd}{Ts} \cdot [E_j - E_{(j-1)}] \cdot DCL + D(j-1) \cdot (1 - DCL)$$

The block diagram below illustrates the independent gains algorithm.

**Figure 2-7. Block diagram of Independent gains algorithm**

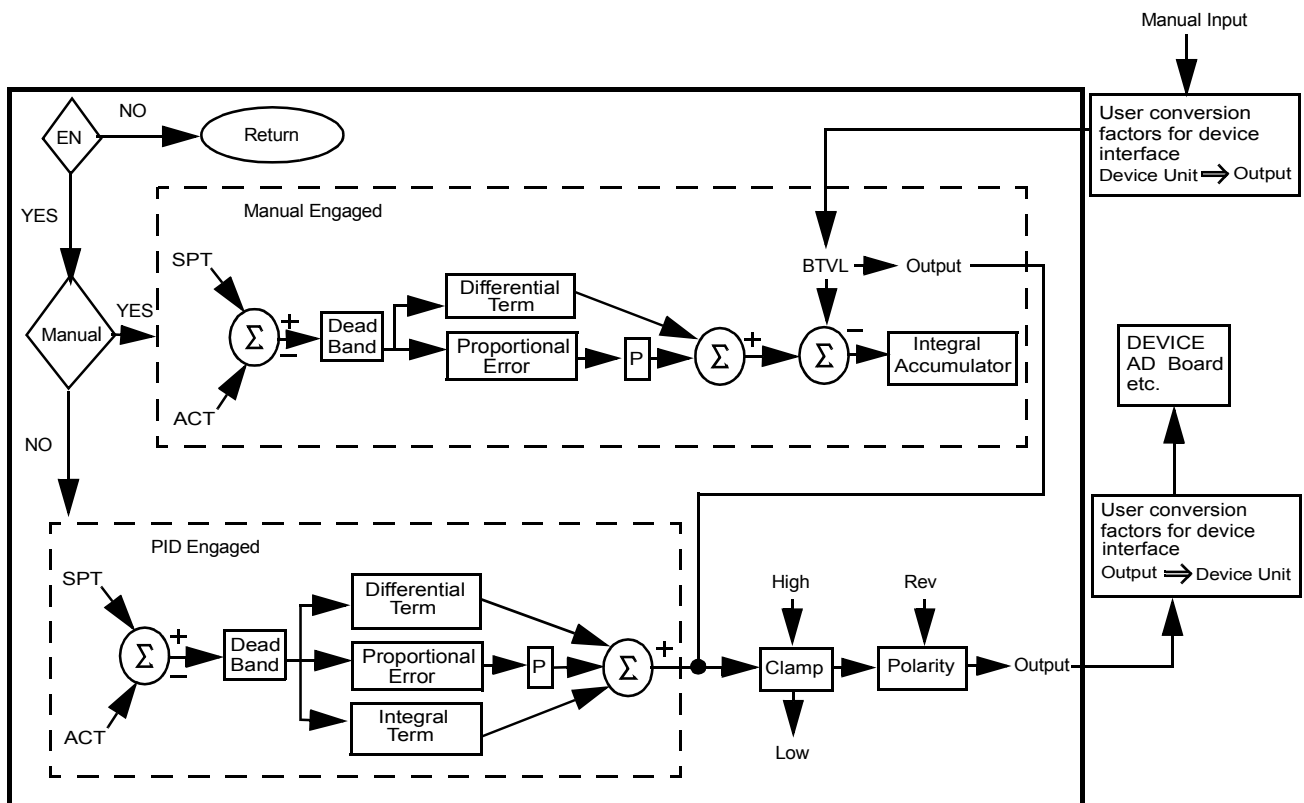

**EXOP Bit 1**

With bit 1, you can choose to have the error calculated by the setpoint minus the actual or by the actual minus the setpoint.

**EXOP Bit 2**

With bit 2, you can choose to have the proportional filter multiplied by the setpoint minus the actual or by the setpoint only.

**EXOP Bit 3**

With bit 3, you can choose to have the derivational filter multiplied by the setpoint minus the actual or by the setpoint only.

The values of the proportional, integral, and derivative terms for the current step can be read with members PROP, INTG, and DERV. Add them to your View list in PiCPro.

<b>PROP</b> (proportional gain)	<b>DINT</b> (read) The value of the proportional term at this step.
<b>INTG</b> (integral gain)	<b>DINT</b> (read) The value of the integral term at this step.
<b>DERV</b> (derivative gain)	<b>DINT</b> (read) The value of the derivative term at this step.

You may execute the PID loop every scan or trigger it at your own update rate by using the timer TON function block at the EN input (see below). Total update time is the timer value plus the time required for one ladder scan.

**Figure 2-8. Example PID network using a timer**

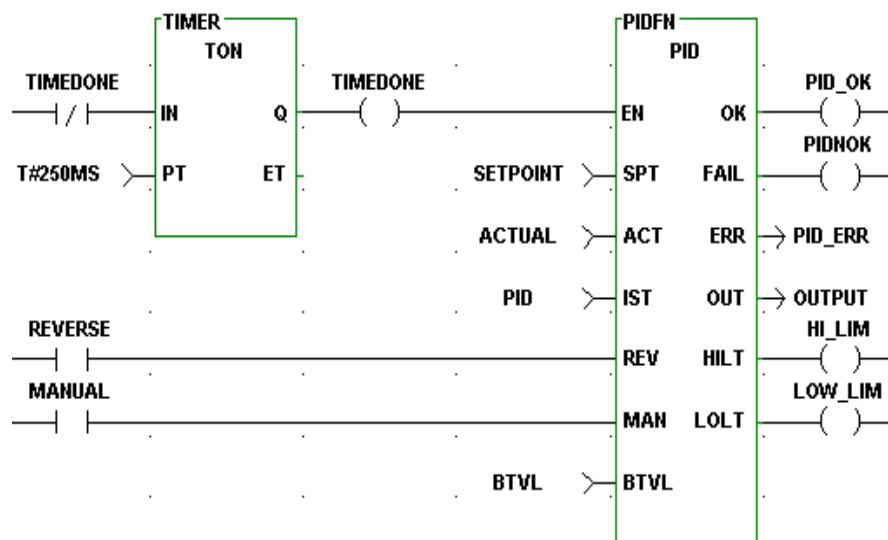

---



---

**PID2**

Proportional, Integral, Derivative

**PID/PID2**

---

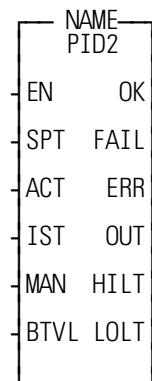

**Inputs:** EN (BOOL) - enables execution (timer output)  
 SPT (DINT) - setpoint value of the control variable specified as a scaled value between  $\pm 2,147,483,646$   
 ACT (DINT) - actual value of the control variable in same units as setpoint value  
 IST (STRUC) - structure holding PID variables  
 MAN - (BOOL) - Manual/auto mode  
 BTVL - (DINT) - bumpless transfer value

**Outputs:** OK (BOOL) - execution completed without error  
 FAIL (BOOL) - set if ERR 0  
 ERR (SINT) - 0 = no error; 1 = math overflow error  
 OUT (DINT) - value of the output in the range of  $\pm 2,147,483,646$   
 HILT (BOOL) - set if output was limited by the HIGH limit  
 LOLT (BOOL) - set if output was limited by the LOW limit

```
<<INSTANCE NAME>>:PID2(EN := <<BOOL>>, SPT := <<DINT>>, ACT :=
  <<DINT>>, IST := <<STRUC>>, MAN := <<BOOL>>, BTVL := <<DINT>>,
  OK => <<BOOL>>, FAIL => <<BOOL>>, ERR => <<SINT>>, OUT =>
  <<DINT>>, HILT => <<BOOL>>, LOLT => <<BOOL>>);
```

The PID2 function block is a simplified version of the PID function block. There is significantly less configuration information because many of the filtering options have been omitted. However, it should be noted that many of the filtering and algorithm options omitted may be effectively performed on the data input to the Function Block yielding similar or improved results. The PID2 function block utilizes the Independent gains algorithm.

The PID2 function block is designed to provide proportional, integral, and derivative control for processing applications. This function block must be declared in the software declaration table.

The desired setpoint for the process variable is entered at SPT (setpoint). The actual (ACT) input specifies the measured value of the process variable.

A bumpless transfer feature is available with the MAN and BTVL inputs. The MAN is a manual/automatic boolean switch. When it is set, the value at the BTVL input is the value at the OUT output. The algorithm updates the integral accumulator. This prevents the accumulation of an integral error during the manual mode. Then when the MAN input is cleared, the transfer to PID2 control is smooth.

The FAIL output will be set if an error occurs. A 1 appears at the ERR output. The function output will be the output of the last iteration that did not fail.

An error value of 1 indicates a math error. An error value of 2 indicates a parameter error.

The HIGH and LOW limits are used for “Anti-Reset Windup”. The range of the output value of the PID2 is limited by the HIGH or LOW limits. If the output is limited, the amount of limitation is fed back to the integrator to prevent continued integration, thereby limiting windup. The HIGH and LOW limits do not directly limit the integral term, but rather, indirectly limit the integral (reset windup) from integrating the output into saturation.

The HILT and LOLT outputs are set respectively if the HIGH or LOW limits are encountered.

The integral and derivative gains in this function block are dependent on the frequency upon which it is executed. Therefore, it becomes important to ensure that the rate at which the function is executed is as consistent as necessary for the application. This can be accomplished by placing the PID2 function block in a Time Tick Task, or by enabling the function block with a timer output in the main ladder. If the function block is enabled by a timer, the rate at which it is enabled should be significantly longer than the scan time for best results. It is also important to ensure that TS is set equal to the rate at which the function block is enabled.

The IST is an input structure to the PID2 function block. The members are described below.

### IMPORTANT

IST is an input structure to the PID2 Function Block. The structure and members are described as follows:

The structure you enter in the software declarations table for the IST input must have the members entered in the order shown below. The data type for each member of the structure must be as shown in the **Type** column in order for the software to recognize the information.

Put initial values for the following structure members in the Init. Val column: KP, KI, KD, DBPLUS, DBMINUS, HIGH, LOW, and OPT.

The software assigns values to PROP, INTG, and DERV.

*The initial values for these three structure members must be 0.*

**Structure for the IST input of PID2 function block**

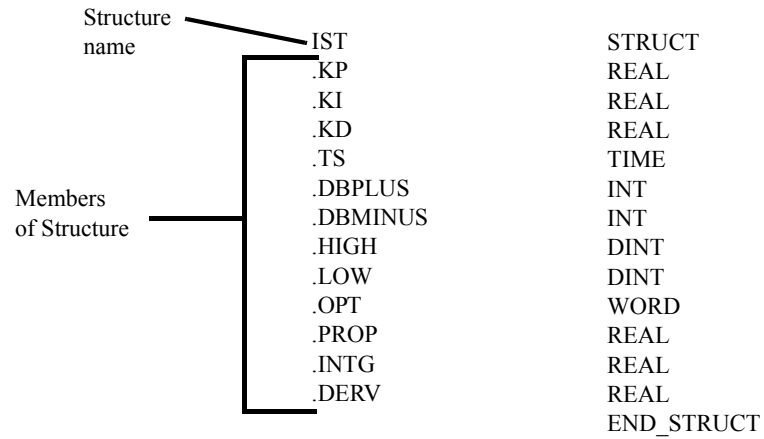

**The IST structure members**

<b>KP</b> (proportional)	<b>REAL</b> (write) Proportional gain, (counts output/counts error)
<b>KI</b> (integral)	<b>REAL</b> (write) Integral gain or reset rate (1/reset time) [I/P] 1/seconds
<b>KD</b> (derivative)	<b>REAL</b> (write) Derivative gain seconds
<b>TS</b> (sample time)	<b>TIME</b> (write) Sample time

A deadband is used to set up a range on either side of the setpoint where the output does not change if the error remains within the range or band. This allows you to control how close the actual value will match the setpoint value without changing the output. The range is entered in DBPLUS and DBMINUS.

<b>DBPLUS</b> (positive dead-band)	<b>INT</b> (write) Positive Deadband (enter as positive number)
<b>DBMINUS</b> (negative deadband)	<b>INT</b> (write) Negative Deadband (enter as a negative number)

An anti-reset windup feature is available with the HIGH and LOW limits. It prevents the integral gain from becoming excessive or winding up when the limits are reached. The output will be held at the value it was during the previous iteration whenever the high or low limit is encountered.

(The HILT and LOLT outputs are set respectively if the HIGH or LOW limits are encountered.)

<b>HIGH</b> (high limit)	<b>DINT</b> (write) Output high limit used for integral accumulator high saturation limit. Same units as setpoint.
<b>LOW</b> (low limit)	<b>DINT</b> (write) Output low limit used for integral accumulator high saturation limit. Same units as setpoint.  NOTE: HIGH and LOW are used for anti-reset windup.
<b>OPT</b>	<b>WORD</b> (write) PID2 options. This is for future use and should be set to 0.
<b>PROP</b>	<b>REAL</b> Current Proportional Term
<b>INTG</b>	<b>REAL</b> Current Integral Term
<b>DERV</b>	<b>REAL</b> Current Derivative Term

<b>PROP</b> (proportional gain)	<b>REAL</b> The value of the proportional term at this step.
<b>INTG</b> (integral gain)	<b>REAL</b> The value of the integral term at this step.
<b>DERV</b> (derivative gain)	<b>REAL</b> The value of the derivative term at this step.

You must trigger the PID2 function block at your own update rate by using the timer TON function block at the EN input (see below). Total update time is the timer value plus the time required for one ladder scan.

**Figure 2-9. Example PID2 network using a timer**

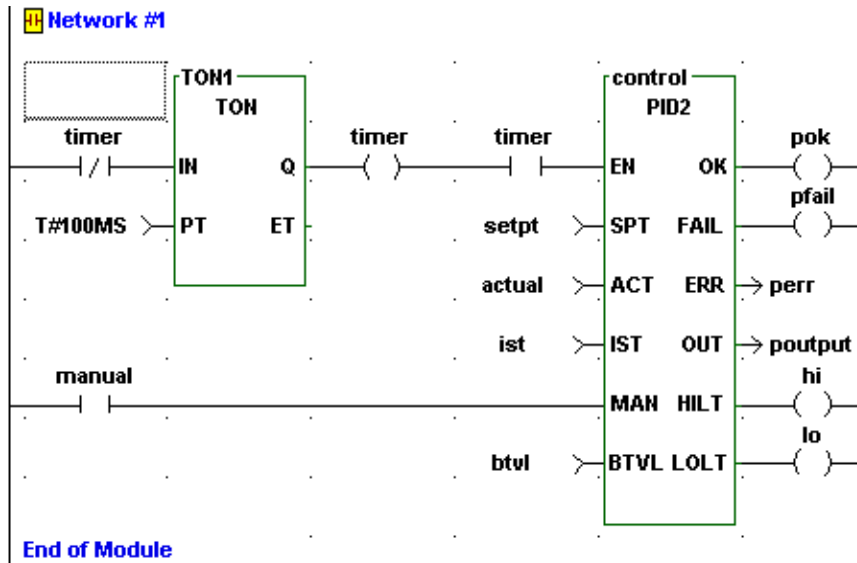



**PLS**

Programmable Logic Switch

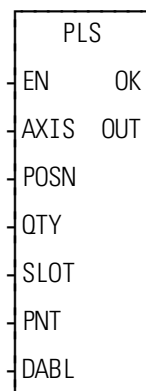
**Motion/MOVE\_SUP**

**Inputs:** EN (BOOL) - enables execution  
 AXIS (USINT) - axis number (servo, digitizing or time)  
 POSN (Array of STRUCTURE) - list of ON/OFF positions  
 QTY (USINT) - number of ON/OFF positions  
 SLOT (USINT) - slot number of output module or MMC for PC ASIU number  
 PNT (USINT) - output point  
 DABL (BOOL) - disable control of output

**Outputs:** OK (BOOL) - execution completed without error  
 OUT (BOOL) - output state

```
PLS(AXIS := <<USINT>>, POSN := <<MEMORY AREA>>, QTY :=
  <<USINT>>, SLOT := <<USINT>>, PNT := <<USINT>>, DABL :=
  <<BOOL>>, OK => <<BOOL>>, OUT => <<BOOL>>)
```

The PLS function is used to turn on a discrete output for specified ranges of axis positions. These ranges are specified by the list of ON/OFF positions pointed to by the POSN input. If the axis' current position is within any of the ranges specified, the output will be turned on. If the axis' current position is in none of the ranges specified, the output will be turned off.

The EN input enables execution of the function block. A one-shot is all that is required to activate the PLS. The EN input may be left enabled to update the OUT output each scan.

The AXIS input specifies the axis whose position will control the state of the output. This may be a servo axis, digitizing axis, or time axis. The POSN input is an array of structures specifying the axis position ranges in which the output is to be turned on. The array of structures must be in the following format:

```
POSN                                STRUCT (0..n-1)
.ON                                  DINT
.OFF                                  DINT
END STRUCT
(where n = number of ranges)
```

The ON and OFF values are axis positions expressed in ladder units. When PLS is active, the following logic is used to determine if the axis' current position is within an ON/OFF range:

If  $ON < OFF$ , CP is in the range if  $CP \geq ON$  and  $CP < OFF$ .

If  $ON > OFF$ , CP is in the range if  $CP \geq ON$  or  $CP < OFF$ .

If  $ON = OFF$ , the range is ignored.

(where CP is the axis' current position)

If the axis' current position is within any of the ranges specified, the output will be turned on. If the axis' current position is in none of the ranges specified, the output will be turned off. Examples of turning on an output for varying distances is illustrated in Figure 2-10.

**Figure 2-10. Examples of PLS ON/OFF**

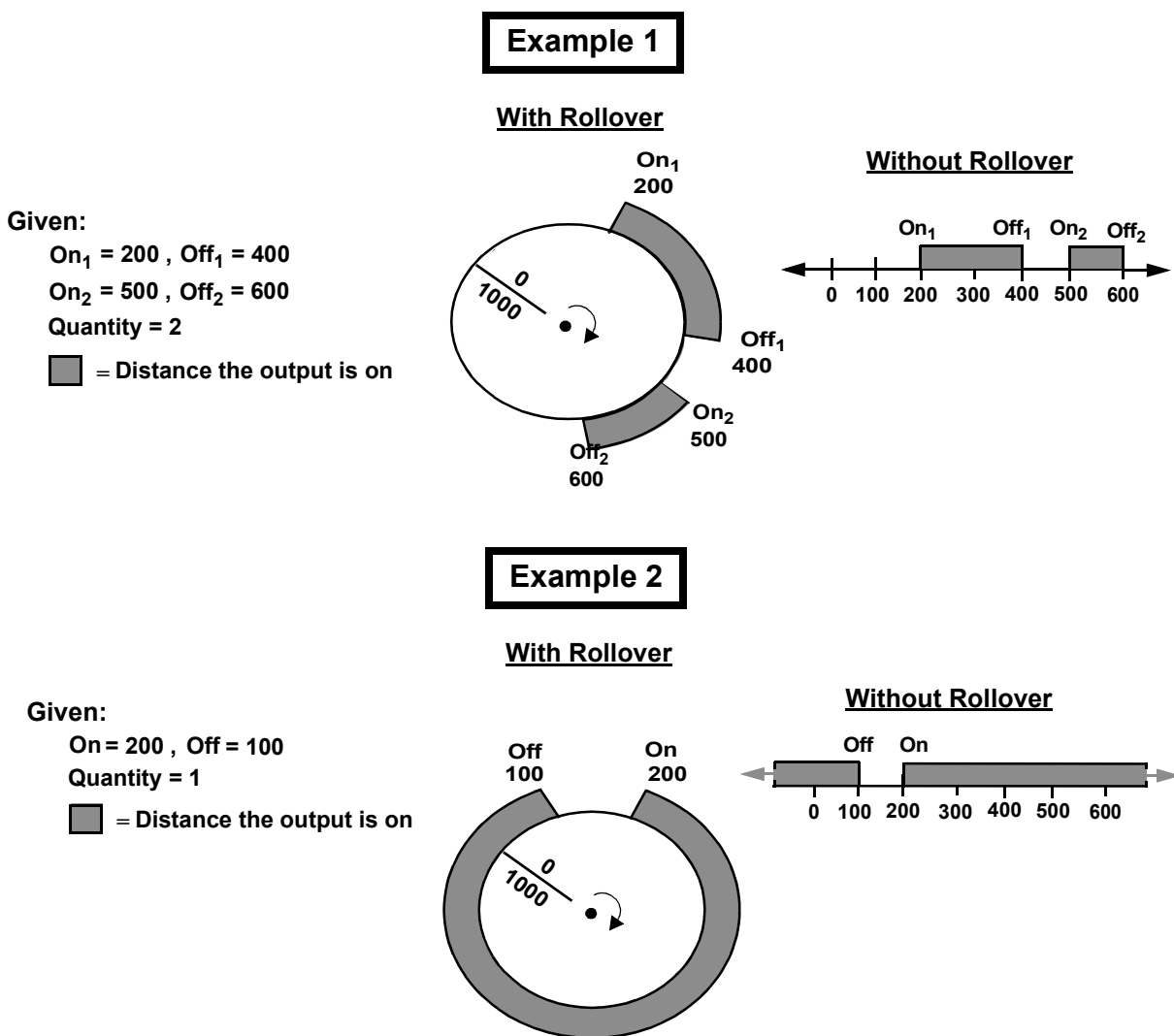

The QTY input specifies the number for ranges in the POSN array of structures. Valid input values are 1 through 255.

With a PiC control, the SLOT input specifies the slot number of the output module. Valid input values are 0 and 3 through 13. If SLOT = 0, only the OUT output will be controlled; no discrete outputs will be controlled. No more than two different slots may be specified by multiple calls to PLS. If output points among 1-16 and among 17-32 are specified on a 32-point output module, only that one slot may be specified by multiple calls to PLS.

With an MMC control, the SLOT input specifies the slot number of the output module. Valid input values are 0 and 2. If SLOT = 0, only the OUT output will be controlled; no discrete outputs will be controlled.

With an MMC for PC Analog control, the SLOT input specifies the ASI number. Valid input values are 0 through 8. If SLOT = 0, only the OUT output will be controlled; no discrete outputs will be controlled.

With a PiC control, the PNT input specifies the output to be controlled. Valid input values are 1 through 32. Multiple calls to PLS should never attempt to control a single output point with more than one axis. However, a single axis can control multiple output points. Up to 32 output points can be controlled. This can be 32 points on a single 32-point output module or 16 points on each of 2 output modules.

With MMC and MMC for PC Analog controls, the PNT input specifies the output to be controlled. The valid input values are 1 through 16.

The DABL input will disable the PLS function. If PLS is called with DABL set, the discrete output and the function's OUT output will be turned off and will no longer be controlled by PLS.

The OK output indicates the function block executed successfully. If the OK output is reset, any of the following errors occurred:

- AXIS input is invalid
- SLOT input is invalid
- PNT input is invalid
- Too many slots have been specified by multiple calls to PLS functions

The OUT output is set when the axis' current position is within is any of the ON/OFF ranges and the DABL input is reset. The OUT output is reset when the axis' current position is none of the ON/OFF ranges. It is also reset when the DABL input is set.

The distance during which each output remains on can vary by changing the values in ON and OFF in each function.

Notes:

1. PLS will operate with or without rollover-on-position specified for the axis.
2. The outputs being controlled by PLS are updated every servo interrupt.

- 3.** While the PLS is active, the ON/OFF values may only be modified via the PLS\_EDIT function. Modifying these values by any other means while the PLS is active may cause outputs to unexpectedly turn on or off. If the DABL input is set or if the EN input has never been set, the ON/OFF values may be modified by conventional means (i.e. MOVE function).
- 4.** Do not declare the PLS output point (specified by SLOT and PNT) in the software declarations.

**PLS\_EDIT**

Programmable Logic Switch Editor

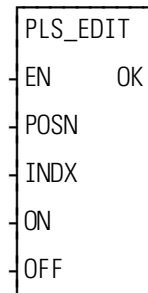
**Motion/MOVE\_SUP**

**Inputs:** EN (BOOL) - enables execution (**one-shot**)  
 POSN (Array of STRUCTURE) - list of ON/OFF positions  
 INDX (USINT) - index of ON/OFF positions to change  
 ON (DINT) - new ON position  
 OFF (DINT) - new OFF position

**Outputs:** OK (BOOL) - execution completed without error

```
PLS_EDIT(POSN := <<MEMORY AREA>>, INDX := <<USINT>>, ON :=
  <<DINT>>, OFF := <<DINT>>, OK => <<BOOL>>)
```

The PLS EDIT function is used to edit an ON/OFF pair of values used by a PLS function while PLS is active. Since the PLS function accesses the ON/OFF values on an interrupt basis, the ladder must not attempt to change these values with any other function (i.e. MOVE function) while PLS is active. PLS\_EDIT will protect the integrity of the ON/OFF values when changing them.

The EN input enables execution of the function.

The POSN input is the array of structures containing the list of ON/OFF positions. The array of structures must be in the following format:

```

      POSN                               STRUCT (0..n-1)
      .ON                                 DINT
      .OFF                                DINT
      END STRUCT
      (where n = number of ranges)
```

The INDX input specifies the ON/OFF range to edit. Valid input values are 0 through 254.

The ON input specifies the new value for the ON position of the range.

The OFF input specifies the new value for the OFF position of the range.

The OK output indicates the function executed successfully.

---



---

**POSITION**

Position

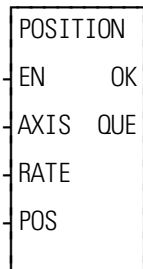
**Motion/MOVE****Inputs:** EN (BOOL) - enables execution (**One-shot**)

AXIS (USINT) - identifies axis (servo or time)

RATE (UDINT) - feedrate at which motion occurs  
(entered in LU/MIN)POS (DINT) - indicates absolute position endpoint  
(entered in LU)**Outputs:** OK (BOOL) - execution completed without error

QUE (USINT) - number of position move for queue

POSITION(AXIS := <<USINT>>, RATE := <<UDINT>>, POS := <<DINT>>,  
  OK => <<BOOL>>, QUE => <<USINT>>)

The POSITION function moves an axis to an endpoint at a specified feedrate. When the position move is used with a time axis, the S\_CURVE function must be called first.

When used on a servo axis, the ACC/DEC will be a ramp, unless S-Curve interpolation is enabled via Servo-Setup or the WRITE\_SV function.

---



---

## P\_ERRORS

Programming Errors

Motion/ERRORS

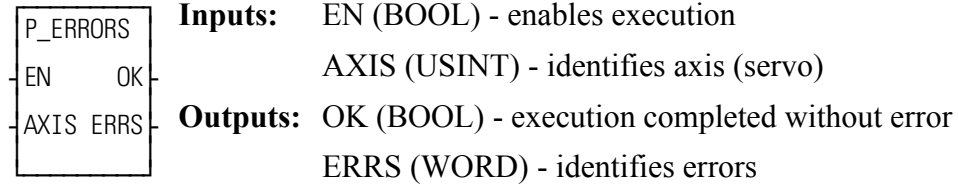

P\_ERRORS(AXIS := <<USINT>>, OK => <<BOOL>>, ERRS => <<WORD>>)

The ERRS output on the P\_ERRORS function is a word, or two bytes, as shown below. The MSB bit (indicated by the “x”) in the high byte word indicates that there is an error.

$\underline{x}$  \_ \_ \_ \_ \_ \_ \_ \_ \_ \_  
 High byte                  Low byte

The programming errors listed in the tables below can be divided into two categories--those connected to the FAST\_QUE function and those connected to the master/slave moves.

**Note:** The P\_ERRORS can also be viewed from the tune section of the Servo setup program.

The **Bit Location** column indicates which bit is set in the low or high byte of the word connected to each error. The “E” is what appears on the tune screen in Servo setup.

The **Hex Value** column represents the form the error is returned in while monitoring the ERRS output of the function in your ladder program.

The first error listed (bit location 8 of low byte) is connected to the FAST\_QUE function. The remaining errors are connected to the master/slave moves.

**Programming errors (Low byte)**

Error	Description	Bit Location (low byte)								Hex * Value (Decimal)	
		8	7	6	5	4	3	2	1	(in LDO)	
The FAST axis in the FAST_QUE function moved too far in wrong direction	The axis traveled more than 65,535 FU in the opposite direction of the value entered in DIST of the FAST_QUE function.	E									8080 (32896)
Profile number not found	Data for a profile move is not valid.		E								8040 (32832)
Master axis not available	This error can occur when using the FAST_QUE function or the functions for master/slave moves (RATIO_GR, RATIOSYN, or RATIOPRO). The conditions that can set this bit:  <ol style="list-style-type: none"> <li>1. Master axis or fast axis not initialized</li> <li>2. Interrupt rates different for axes</li> <li>3. Axis at slave input is the same as axis at master input in master/slave move.</li> <li>4. The master/slave move has requested to use the master's command position and the master axis is not a servo axis. Choosing to use the master's command position is achieved with the OPTN input for RATIOCAM, RATIOSLP, and RATIO_RL or WRITE_SV Variable 59 for RATIO_GR, RATIOSYN, and RATIOPRO.</li> </ol>			E							8020 (32800)
(not used)											
(not used)											
(not used)											
(not used)											
Master start position for lock on	When the dimension for the lock position was converted to feedback units, it was too big to fit into 32 bits.									E	8001 (32769)



## Programming errors (High byte)

Error	Description	Bit Location (high byte)								Hex* Value (Decimal)
		8	7	6	5	4	3	2	1	
		X								(in LDO)
	This bit is set whenever any of the remaining 15 bits is set.									8000 (32768)
(not used)										
(not used)										
(not used)										
Master axis beyond start point	The master axis is beyond its starting point for a ratio move.					E				8800 (34816)
Slave axis beyond start point	The slave axis is beyond its starting point for a ratio move.						E			8400 (33792)
Master distance not valid	When the master distance is converted to feedback units, it is greater than 16 bits.							E		8200 (33280)
Slave distance not valid	When the slave distance is converted to feedback units, it is greater than 16 bits.								E	8100 (33024)

\*When more than one error occurs, the hex values are OR'd. For example, if 8100 and 8200 occur, the result is 8300 hex (33536 decimal)

---

---

## P\_RESET

Programming Reset

**Motion/ERRORS**

---

---

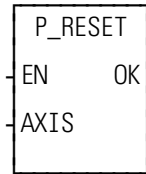

**Inputs:** EN (BOOL) - enables execution (**Typically one-shot**)  
AXIS (USINT) - identifies axis (servo)

**Outputs:** OK (BOOL) - execution completed without error

P\_RESET(AXIS := <<USINT>>, OK => <<BOOL>>)

Use the P\_RESET function to reset any programming errors that occur.

---



---

## PWDTY

Accepts input value and converts to duty cycle percentage

**PID/PWDTY**

---



---

PWDTY	
EN	OK
IN	ON
PER	DUTY
MAXR	
MINR	
MAXT	
MINT	

**Inputs:** EN (BOOL) - enables execution

IN (DINT) - duty cycle input

PER (TIME) - period of duty cycle

MAXR (DINT) - maximum input range

MINR (DINT) - minimum input range

MAXT (TIME) - maximum ON time

MINT (TIME) - minimum ON time

**Outputs:** OK (BOOL) - function block OK

ON (BOOL) - duty cycle ON

DUTY (TIME) - current duty cycle ON time

```
PWDTY(IN := <<DINT>>, PER := <<TIME>>, MAXR := <<DINT>>, MINR :=
<<DINT>>, MAXT := <<TIME>>, MINT := <<TIME>>, OK => <<BOOL>>,
ON => <<BOOL>>, DUTY => <<TIME>>)
```

The Pulse Width Duty Cycle function block accepts an input value between the minimum and maximum input range and converts this to a duty cycle percentage. The output is then cycled on and off over the input duty cycle period proportionally to this duty cycle percentage. If it is desired to have the output ON time range from 0 to the duty cycle period, the minimum should be set to zero, and the maximum to the duty cycle period.

If there is a programming error, the output will remain OFF.

If the calculated duty cycle based on the input and range values is less than minimum ON time (MINT), the output will not come on. This guarantees that the output will come on for very short periods of time as long as the minimum ON time is greater than zero.

If the calculated duty cycle is between or equal to the range values, the output is cycled by the duty cycle.

If the calculated duty cycle is greater than the maximum ON time (MAXT), the output will remain on. This will ensure that the output cannot turn off for brief periods of time unless the maximum ON time is set equal to the time period.

---

---

**Q\_AVAIL?**

Queue Available?

**Motion/QUE**

---

---

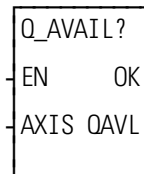
**Inputs:** EN (BOOL) - enables execution

AXIS (USINT) - identifies axis (servo)

**Outputs:** OK (BOOL) - execution completed without error

QAVL (BOOL) - queue available if set

Q\_AVAIL?(AXIS := <<USINT>>, OK => <<BOOL>>, QAVL => <<BOOL>>)

The queue available function asks the question “Is a queue available for the specified axis?” If QAVL is set, then a queue is available. If not, no queue is available.

The Q\_AVAIL? inquiry cannot be set until the servo loop is closed.

---



---

## Q\_NUMBER

Queue Number

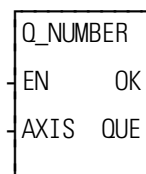
**Motion/QUE****Inputs:** EN (BOOL) - enables execution

AXIS (USINT) - identifies axis (servo)

**Outputs:** OK (BOOL) - execution completed without error

QUE (USINT) - the number of the move in the active queue

Q\_NUMBER(AXIS := <<USINT>>, OK => <<BOOL>>, QUE => <<USINT>>)

The Q\_NUMBER function gives the number of the move that is in the active queue. A queue number is assigned to each move by the software when the move function OK output is set. Queue numbers are assigned to the moves sequentially from 1 to 255. A “0” at the QUE output indicates that there is no move in the queue.

---

---

**RAMP**

Generate ramp outputs from step inputs

**PID/RAMP**

---

---

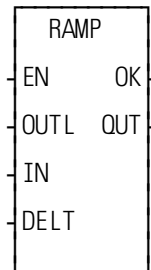

**Inputs:** EN (BOOL) - enables execution  
 OUTL (DINT) - generator output last (previous value)  
 IN (DINT) - generator input  
 DELT (DINT) - generator delta

**Outputs:** OK (BOOL) - execution completed without error  
 OUT (DINT) - generator output (current value)

```
RAMP(OUTL := <<DINT>>, IN := <<DINT>>, DELT := <<DINT>>, OK =>
<<BOOL>>, OUT =><<DINT>>)
```

The function RAMP generates a ramp output from step inputs. The output of the function will “ramp” to the input of the function, at the rate defined by the DELT (delta) input. This function should be called on a periodic basis. The input OUTL must be set to the previous value of the output OUT. The variable to be ramped is IN. The output will simply increase or decrease by the difference between IN and OUT, or it will increase or decrease by the DELT, whichever is less.

## RATIOCAM

Ratio Cam

Motion/RATIOMOV

RATIOCAM	
EN	OK
AXIS	QUE
MAST	
CAM	
SSTR	
MSTR	
OPTN	

- Inputs:**
- EN (BOOL) - enables execution (**One-shot**)
  - AXIS (USINT) - identifies slave axis (servo)
  - MAST (USINT) - identifies master axis
  - CAM (ARRAY OF STRUCTURES) - points to the first element in the array of structures defining the profile to run  
NOTE: Each segment of the profile is entered in FUs. If you are entering equal master segments, then you enter a STRUCTURE WITH AN ARRAY here.
  - SSTR (DINT) - Slave starting point in LU  
If SSTR is outside the range of -536,870,912 to 536,870,911 FU, the OK will not be set.
  - MSTR (DINT) - Master starting point in LU  
If MSTR is outside the range of -536,870,912 to 536,870,911 FU, the OK will not be set
  - OPTN (WORD) - provides five options: repeat, ignore master start, ignore slave start, equal master segments, and use master command position
- Outputs:**
- OK (BOOL) - execution completed without error
  - QUE (USINT) - number of the cam profile move for the queue.

### MASTER AXIS NOTE

The master axis for any master/slave move can be one of three types available:

**A servo axis**

(Range of numbers available to enter at MAST for servo axes is 1 through 16.)

A servo axis must be set up with the Servo setup and tuning program.

**A time axis**

(Range of numbers available to enter at MAST for time axes is 25 through 28.)

A time axis creates a time basis for slave axes to follow. It provides the ability to generate velocity profiles. It is set up and monitored using the S\_CURVE function and/or variables 1, 6, 12, and 26 with the READ\_SV and WRITE\_SV functions.

**A digitizing axis**

(Range of numbers available to enter at MAST for digitizing axes is 49 through 64.)

A digitizing axis must be set up with the Servo setup and tuning program.

## RATIOCAM

```
RATIOCAM(Axis := <<USINT>>, MAST := <<USINT>>, CAM := <<MEMORY AREA>>, SSTR := <<DINT>>, MSTR := <<DINT>>, OPTN := <<WORD>>, OK => <<BOOL>>, QUE =><<USINT>>)
```

With RATIO\_GR and RATIOSYN functions, the slave distance/master distance ratio is constant.

With the RATIOCAM function, the slave distance/master distance ratio can vary in steps or *segments* over the course of the profile as shown below in Figure 2-9. There are 10 segments in the example profile.

NOTE: Each square equals 10 feedback units.

In each individual segment, you define the slave distance/master distance ratio by determining how far the slave axis will move while the master axis covers its segment distance.

The master moves five units in each segment (NOTE: It is not required that the master axis move the same distance each segment).

**Figure 2-11. A ratiocam profile with 10 segments**

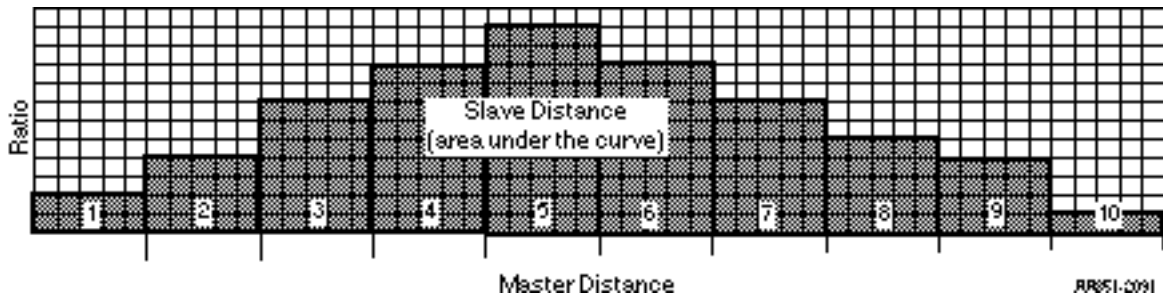

An example of a profile where the master distance varies over the course of the ratiocam profile is shown in Figure 2-10.

**Figure 2-12. A ratiocam profile with 9 segments**

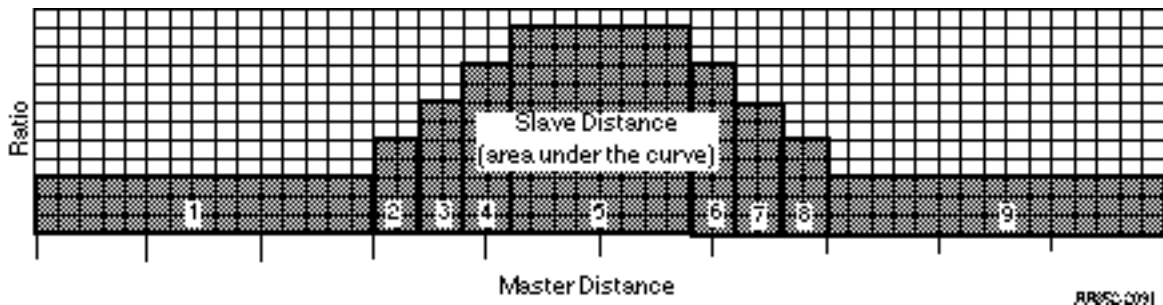

An example of a profile where the slave axis is moving in a negative direction during the last four segments of the ratiocam profile is shown in Figure 2-11.



Figure 2-13. A ratiocam profile with 10 segments

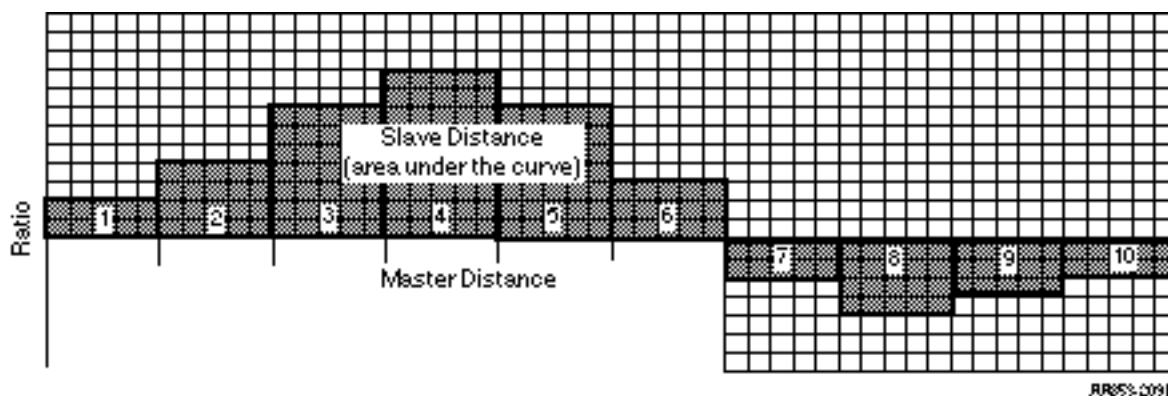

### The SSTR, MSTR, and OPTN inputs

When the SSTR input is used, it defines the slave axis position at the beginning of the profile.

When the MSTR input is used, it defines the master axis position at the beginning of the profile.

The OPTN input provides the following options.

Bit #	Option	Binary Value	Hex Value Entered
0	Repeat profile	0000000000000001	0001
1	Ignore master start	0000000000000010	0002
2	Ignore slave start	0000000000000100	0004
3	Equal master segments	0000000000001000	0008
4	Use master command position	0000000000010000	0010

If you want to follow the master's command position instead of the master's actual position, set bit 4.

Velocity Compensation should be inhibited (WRITE\_SV Variable 32 = 1) prior to executing RATIOCAM with this bit set.

The Equal master segments option can be used if the master distance for each segment is the same. It provides a way of saving memory. Instead of entering an array of structures to hold the profile data, you enter a structure with an array. Information on equal master segments can be found at the end of this RATIOCAM description.

If you want the profile to repeat continuously, set bit 0.

If you choose to ignore the master start (bit 1 set), any value you enter in MSTR has no effect. The cam profile will begin executing as soon as the function is called. During the first cycle, the slave axis may be located within the profile depending on its current position and the value in SSTR.

## RATIOCAM

If you choose to ignore the slave start (bit 2 set), any value entered in SSTR has no effect and the profile will execute at the beginning when the master axis reaches its starting point (MSTR).

If you choose to ignore both MSTR and SSTR (bits 1 and 2 set), the profile will execute immediately at the beginning from wherever the master and slave axes are currently located.

The four examples that follow illustrate what affect ignoring or using the SSTR and MSTR inputs via OPTN have on what the beginning position for each axis will be.

Three segments of a ratiocam profile (shown on the right) will be used in each example. The master axis moves 100 units in each segment. The slave axis moves 50, 75, and 100 units in the first, second, and third segments respectively.

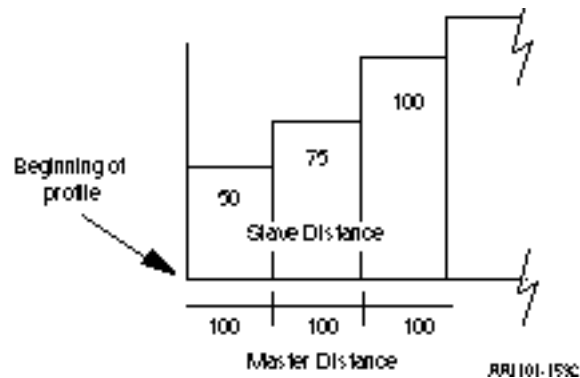

### Example 1 - Ignore SSTR and MSTR

Entering a 7 in the OPTN input sets all three bits. The value at the SSTR and MSTR inputs (xxx) will be ignored. The profile will repeat, the master start will be ignored, and the slave start will be ignored.

When the RATIOCAM function is called, the axes lock on immediately and the slave begins moving. The current positions of the axes become the positions at the beginning of the profile.

RATIOCAM	Current Axes Positions	Portion of Cam Profile
xxx    SSTR xxx    MSTR 7      OPTN	Slave Axis @ 100 Master Axis @ 400	

**Example 2 - Ignore SSTR**

The value in the SSTR input is ignored since a 5 has been entered in the OPTN input setting bits 0 and 2. The profile will repeat, the master start will not be ignored, and the slave start will be ignored.

When the RATIOCAM function is called, the master must move from its current position to 100 (the MSTR value) before lock on occurs and the slave begins moving. The positions at the beginning of the profile are the MSTR value for the master axis and the current position (100) for the slave axis.

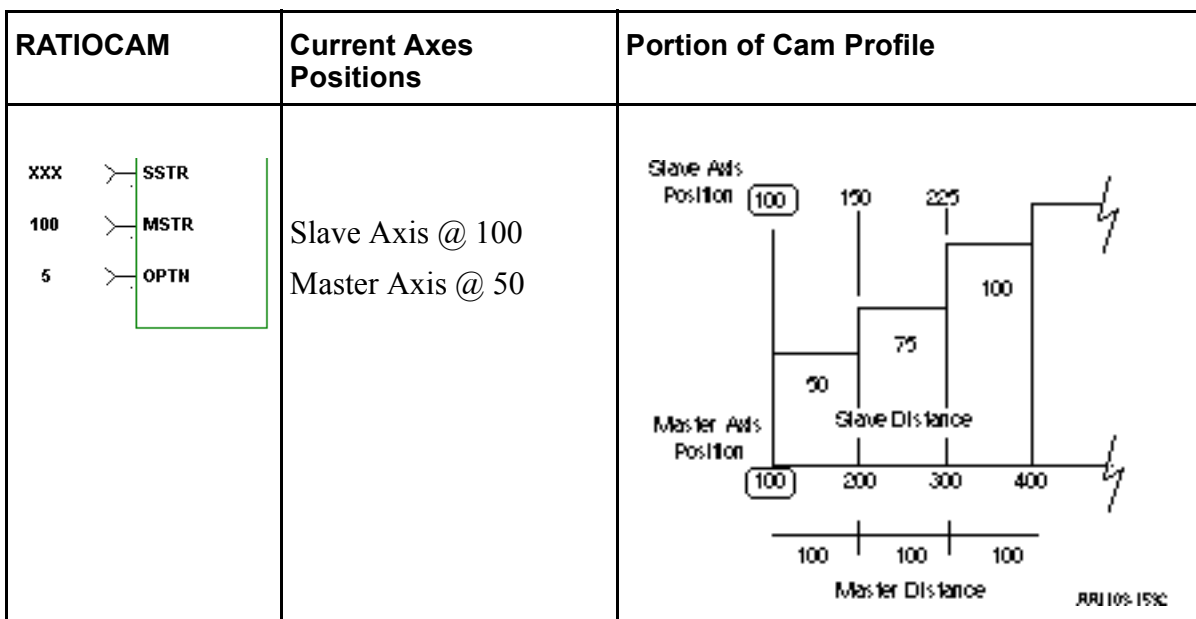

**Example 3 - Ignore MSTR**

The value in the MSTR input is ignored since a 3 is entered in the OPTN input setting bits 0 and 1. The profile will repeat, the master start will be ignored, and the slave start will not be ignored.

When the RATIOCAM function is called, the slave is at 150 within the profile. Lock on occurs immediately and the slave begins to move. The beginning positions of the axes are based on the value in SSTR (50) for the slave axis and the current master position minus how far the master has moved in the profile (200 - 167) or 33 for the master axis.

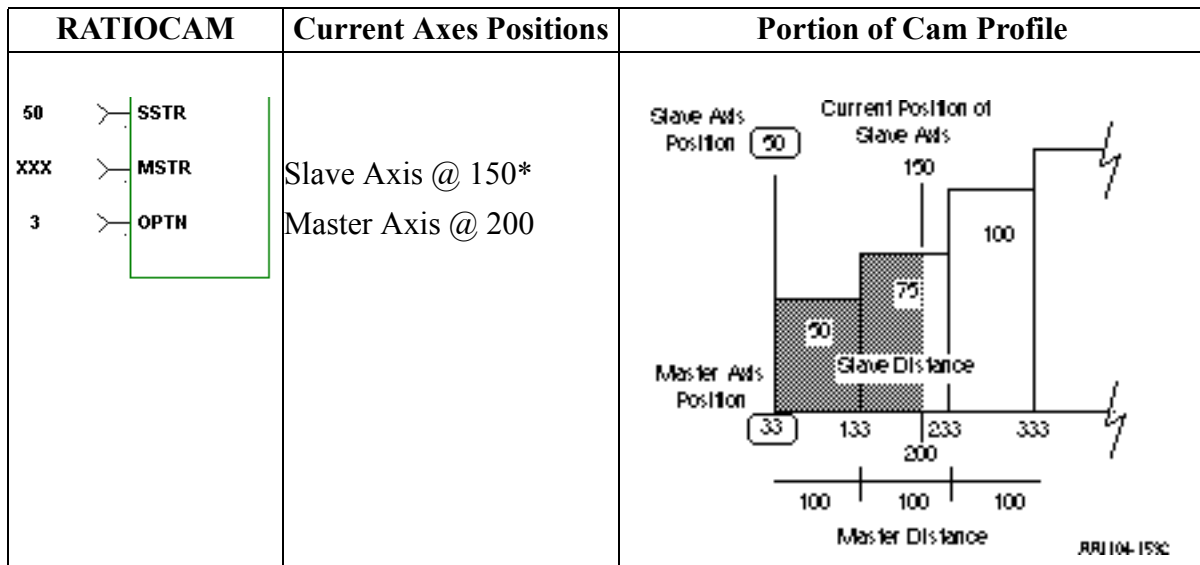

**Example 4 - Use both SSTR and MSTR**

The SSTR and the MSTR inputs are not ignored. A 1 is entered in the OPTN input setting bit 0. The profile will repeat, the master start will not be ignored, and the slave start will not be ignored.

When the RATIOCAM function is called, the slave is at 250 within the profile. The master axis is at 100 and must move to 425 within the profile to lock on. The beginning positions of the axes at the start of the profile are based on the value in the SSTR (50) and the MSTR (150) inputs .

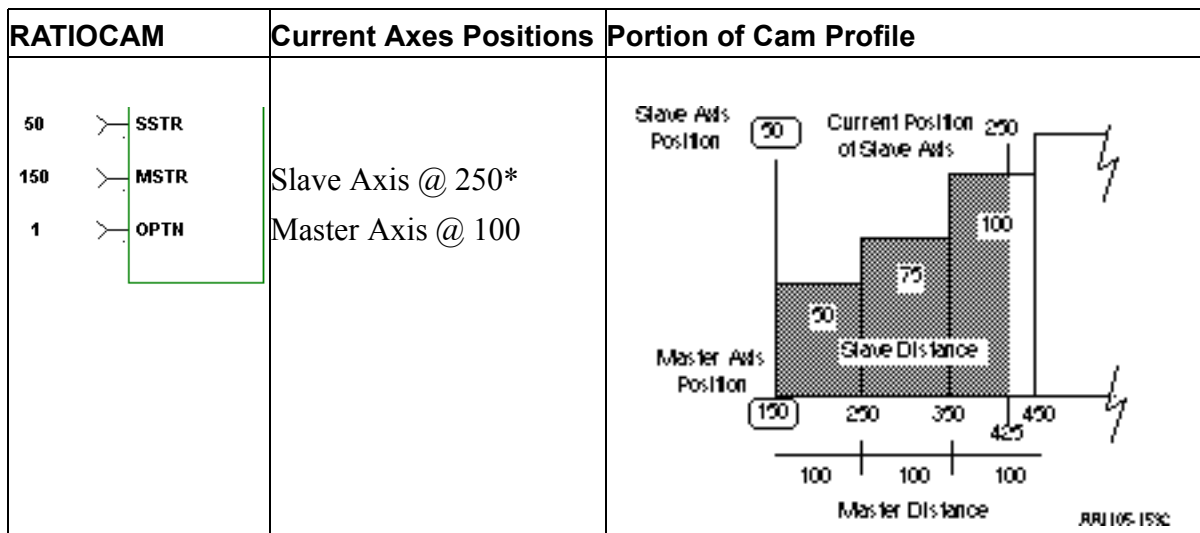

\*Typically, the position of the slave axis in examples 3 and 4 must be within the profile (> 50), unless rollover on position is on.

Other characteristics of the ratiocam move include:

- Affects the slave axis only.
- The slave axis may be a master axis to another axis.
- More than one slave axis may be connected to the master axis.
- The master axis may be a servo, a time, or a digitizing axis.
- If the master axis reverses direction, the slave axis will follow. A positional relationship has been established for each segment and the software will maintain that relationship. If, for example, the master axis would change direction during the profile, the slave axis would move backwards through the profile so that when the master axis reaches a certain position the slave axis will be at its corresponding position as defined in the array of structures.
- If it is not desirable to have the slave axis follow the master axis when the master reverses direction, variable 21 (reversal not allowed) of the WRITE\_SV function can be set. (The state of variable 21 can also be read with the READ\_SV function.) The WRITE\_SV function must always be called *before* the RATIOCAM function.
- Inverted ratios are possible by entering negative slave segment elements in the array of structures defining your profile. (NOTE: The sign on the master elements entered in the array of structures must all be the same.)
- Starting points for the master axis and slave axis may be entered.
- Both the master and slave axes must be at the same interrupt rate.
- Registration can be used with the RATIOCAM function.
- The ratiocam function move will repeat continuously if the repeat option is set until either the move is aborted or a REP\_END function is called. With the abort move function, the move will stop wherever it is in the profile. With the repeat end function, the move will stop at the end of the current profile.  
A new ratio cam profile can then be called.

- Some conditions for which the OK will not be set and the queue will be “0” include:
  1. Master axis not available (P-error) [Master axis not initialized, master and slave interrupts different, the same axis was entered as master and slave, or OPTN bit 4 is set and the master axis is not a servo axis.]
  2. Profile error (P-error) [A number less than two entered as the size of the profile, a master segment is zero, or not all master segments have the same sign]
  3. Slave start value is out of range, current slave position is not within profile, or not ignoring slave start with both queues not available (NOTE: Rollover on position will not be used by the servo software to correct this condition.)]
  4. Master start value is out of range.
  5. Slave axis (AXIS) not initialized during setup
- A P-error will occur if the master axis is beyond it’s start point.
- A P-error will occur if the slave axis is beyond it’s start point.
- An E-error will occur if there is a slave delta overflow during runtime. The hex code 0004 indicates this error on the ERRS output of the E\_ERRORS function.  
 To ensure that this E-error will not occur, calculate the worst case for your application as explained below. With feedback units equal to ladder units,  $master\ distance/interrupt\ (velocity) \times largest\ slave\ array\ value < 32\ bits$

**Creating a profile with an array of structures**

<b>NOTE</b>
<p>An array of structures is always used to create the ratio cam profile if the master distance varies with each segment. It can also be used if the master distance for each segment is equal as shown in the example that follows. However, if you want to save memory, you can set option bit 3 and enter a structure with an array.</p>

Each segment or step in the cam profile is defined by you in PiCPro by creating an array of structures in the software declarations table. (More information on arrays and structures can be found in the PiCPro Online Help.)

There are two members of the structure--the master distance and the slave distance. These distances are entered in feedback units. Each element in the array represents the master distance and the slave distance for one segment of the cam profile.

In order to create the array of structures, you need to know:

1. The master distance and the slave distance for each segment. The table on the left that follows contains this information for the example in Figure 2-9.

2. The number of segments the profile contains.

**Note:** Add “1” to this number to calculate the length of the array you will declare. For the example which contains 10 segments, the length of the array is “11” as seen in Figure 2-9. The servo software uses the first element in the array to determine the size of the profile.

The table below on the right contains the array information for the example in Figure 2-9.

DISTANCE DATA FOR EXAMPLE PROFILE		
Segment #	Master	Slave
1	50	100
2	50	200
3	50	350
4	50	450
5	50	550
6	50	450
7	50	350
8	50	250
9	50	150
10	50	50

ARRAY DATA FOR EXAMPLE PROFILE		
Element	.Master (FU)	.Slave (FU)
0	+11*	+0*
1	+50	+100
2	+50	+200
3	+50	+350
4	+50	+450
5	+50	+550
6	+50	+450
7	+50	+350
8	+50	+250
9	+50	+150
10	+50	+50

\*See note that follows.

NOTE
<p>Remember that the first element (0) in the array determines the size of the cam profile.</p> <p>The .MASTER line of the first element must contain the number of segments in the profile plus one.</p> <p>It is not necessary to enter any value in the SLAVE line. It will default to zero.</p>

By entering the name of the array and the first element at the CAM input, the desired profile can be accessed by the RATIOCAM function.

**CAUTION**

Never attempt to change the values in the array elements while the move is being executed.

The example below shows how the RATIOCAM function can be entered in your LDO.

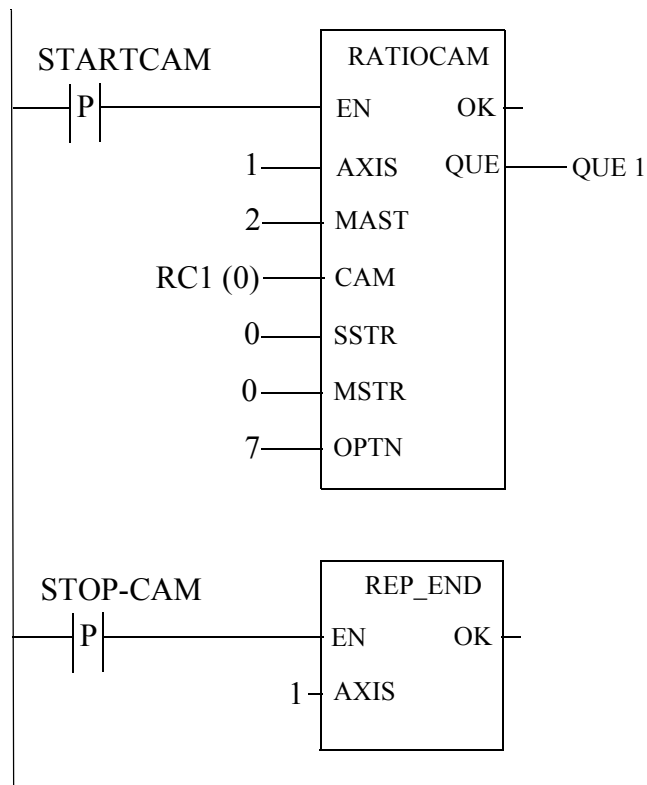



## Equal Master Segments

If the master distance for all the segments in the RATIOCAM profile is the same, you can define the profile in the software declarations table with a structure with an array as shown below in order to save memory.

### Structure with an array (if master distance for all segments is equal)

```
RC1                STRUCT
.SIZE              INT
.MASTER            INT
.SLAVE             INT (0..9)
```

In this structure with an array,

.SIZE is the number of slave segments in the profile plus 2

.MASTER is the master distance for all segments

.SLAVE is an array holding the slave distances for each segment (In this example, there are 10 slave segments.)

Bit 3 of the option bits must be set when you use this structure with an array.

The array of structures used in the previous examples (shown below) must be used if the master distance for all the segments varies in the RATIOCAM profile. It can also be used when the master distance for each segment is equal but it uses more memory than using the structure with an array above.

### Array of Structures (if master distance for all segments varies)

```
RC1                STRUCT (0..10)
.MASTER            INT
.SLAVE             INT
```

**RATIOPRO**

Ratio Profile

**Motion/RATIOMOV**

RATIOPRO
EN    OK
AXIS  QUE
MAST
PNUM
MSTR
RPTP
RVAL
BKPR

**Inputs:** EN (BOOL) - enables execution (**One-shot**)

AXIS (USINT) - identifies slave axis to move (servo)

MAST (USINT) - identifies master axis

PNUM (USINT) - profile number to be run

MSTR (DINT) - master start position (entered in LU)

RPTP (BOOL) - repeat profile

RVAL (BOOL) - reversal allowed

BKPR (BOOL) - back to back profiles

**Outputs:** OK (BOOL) - execution completed without error

QUE (USINT) - indicates the number of the ratiopro move for the queue

**MASTER AXIS NOTE**

The master axis for any master/slave move can be one of three types available:

**A servo axis**

(Range of numbers available to enter at MAST for servo axes is 1 through 16.)

A servo axis must be set up with the Servo setup and tuning program.

**A time axis**

(Range of numbers available to enter at MAST for time axes is 25 through 28.)

A time axis creates a time basis for slave axes to follow. It provides the ability to generate velocity profiles. It is set up and monitored using the S\_CURVE function and/or variables 1, 6, 12, and 26 with the READ\_SV and WRITE\_SV functions.

**A digitizing axis**

(Range of numbers available to enter at MAST for digitizing axes is 49 through 64.)

A digitizing axis must be set up with the Servo setup and tuning program.

RATIOPRO(AXIS := <<USINT>>, MAST := <<USINT>>, PNUM := <<USINT>>, MSTR := <<DINT>>, RPTP := <<BOOL>>, RVAL := <<BOOL>>, BKPR := <<BOOL>>, OK => <<BOOL>>, QUE =><<USINT>>)

## Ratiopro function summary

The ratio profile function enables the slave axis to start a ratio move where the slave axis moves at a variable ratio relative to the position of an independent master axis.

When the master axis (MAST) passes through the master start position (MSTR) in the positive direction, the slave axis will start executing a profile (PNUM). This profile has been created by you using the PiC Profile program as explained in Chapter 7.

To run the profile repeatedly, RPTP is set.

To stop a repeating profile the REP\_END function is used.

If it is desirable to have the slave axis follow the master axis when the master reverses direction, then set reversal allowed (RVAL).

If it is desirable to have two different profiles run back to back, set back to back profile (BKPR). When two profiles are run back to back, the last segment of the profile in the active queue and the first segment of the profile in next queue is dropped.

If WRITE\_SV Variable 59 = 0 (default), RATIOPRO will use the master's actual position. If Variable 59 = 1, RATIOPRO will use the master's command position.

The execution of the function will not be OK if any of the following occurs:

- An invalid input is entered.
- When the servo software converts your axis units to feedback units in order to perform its calculations, the number is out of range.
- The queues are full.
- WRITE\_SV Variable 59 = 1 and the master axis is not a servo axis.

A number for the move (QUE) is assigned by the software to identify the move for the queue.

### Profile number

This is the number of the profile made by you using the PiC Profile program that you want this move to execute. The number assigned to PNUM must be from 1 to 18.

**Figure 2-14. User-defined profile**

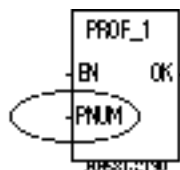

**IMPORTANT**

Be sure to follow the two steps listed below *in the order listed* when using profiles:

1. Initialize the servo data.
2. Initialize the profile data by including the profile function in your LDO before calling the RATIOPRO function that uses it.

Enter the position of the master at which the slave will lock onto the master and be synchronized. This will be handled during the first segment of the profile.

For example, if you know that the master axis should be at 10,000 units at the end of the first segment and also it moves 5000 units in that first segment, then the value entered at MSTR would be 5000 ( $10,000 - 5000 = 5000$ ).

The slave has to be moved into position before the RATIOPRO move begins. In this example, you know that the slave should be at 8000 at the end of the first segment and that it moves 2500 units in the first segment. Then you would use the position move function to move the slave axis to 5500 ( $8000 - 2500 = 5500$ ).

**Repeating profiles**

If you want the profile you are using in the RATIOPRO move function to run continuously, enter a “1” at the RPTP input. What happens when RPTP is set is shown in Figure 2-15. Note that the first and last segments are dropped when the profile repeats.

When using repeating profiles, it is important to have the ending ratio of the first segment match as close as practical the starting ratio of the last segment. This prevents any large steps for the slave axis. This was achieved by dividing segment 4 and 5 in Figure 2-15. If this was not a repeating profile, segments 4 and 5 could have been one segment.

Figure 2-15. Repeating profile

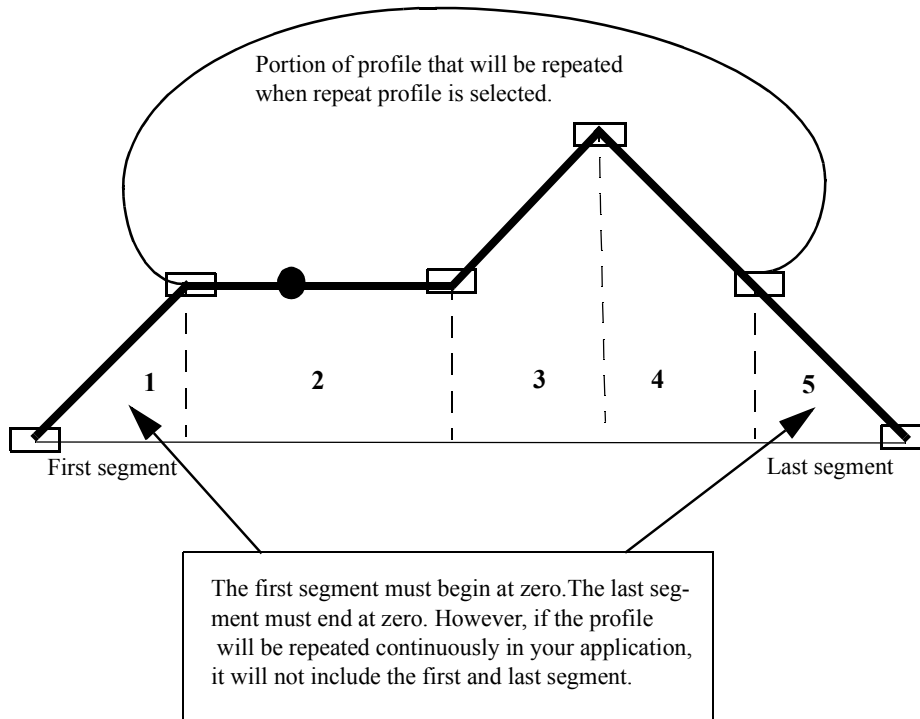

To stop repeating profiles, enter a REP\_END function.

#### Reversal of the slave axis allowed

If the RVAL input is set, the slave axis will follow the master axis if it reverses direction during the profile.

The slave will follow the master in a reverse direction until it reaches the MSTR dimension. At that point, the slave will stop and the two axes are no longer synchronized.

If the RVAL input is not set, the slave axis will stop and wait for the master to move in a positive direction again. It will begin to move forward again when the master axis position calls for it.

If the master axis reverses back to the MSTR dimension, synchronization is lost.

**Back to back profiles**

It is possible to run two profiles back to back if the BKPR input is set to a "1." The second profile is called in a second RATIOPRO function. When this is done, the last segment of the first profile and the first segment of the second profile are dropped as shown below.

**Figure 2-16. Back to back profiles**

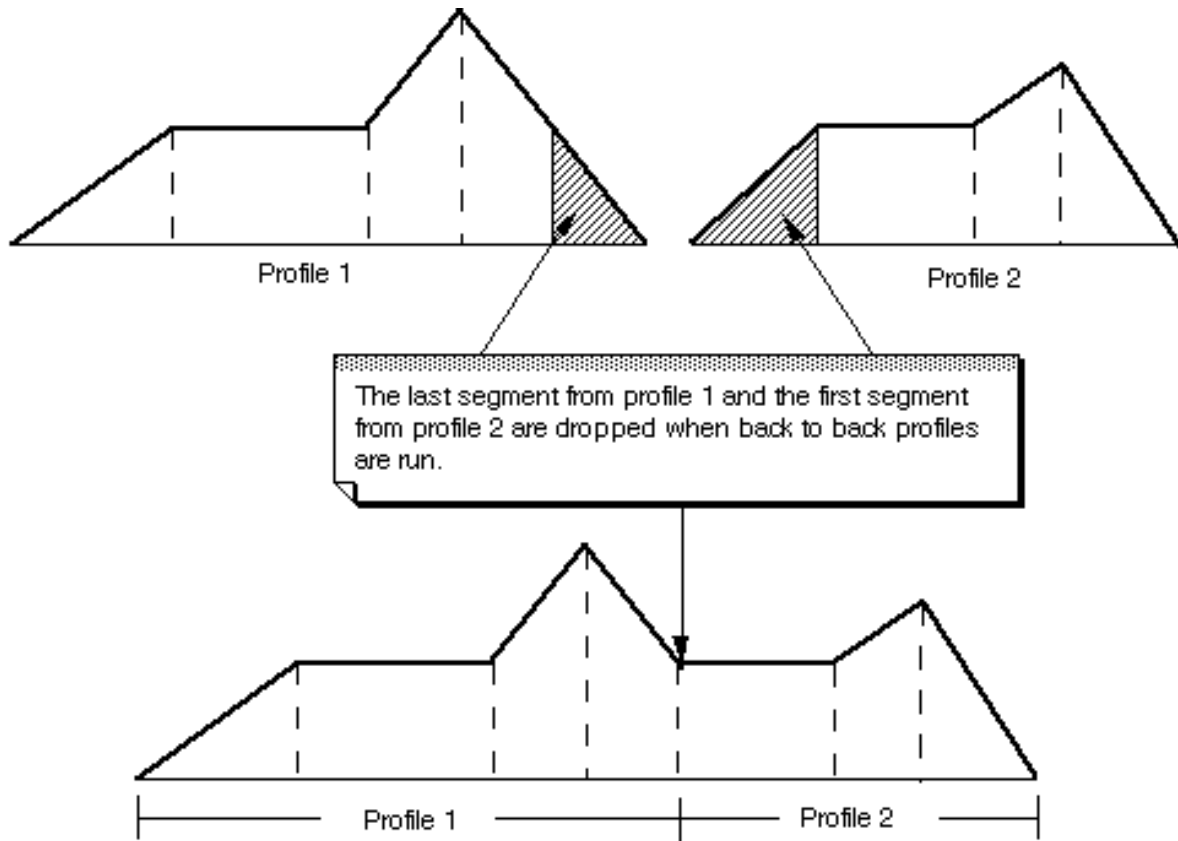

Profiles 1 and 2 run back to back

AP554-1790

---



---

## RATIOSCL

Ratio Scale

Motion/MOVSUP

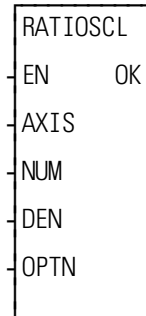

**Inputs:** EN (BOOL) - enables execution (**One-shot**)

AXIS (USINT) - identifies the slave axis associated with the scaling (servo)

NUM (INT) - numerator of the scale factor

DEN (INT) - denominator of the scale factor

NOTE: Range for NUM and DEN inputs is [1,32767].

OPTN (WORD) - set the LSB to zero for slave scaling; set the LSB to one for master scaling

NOTE: Master and slave scaling are independent. To scale both, the function must be called twice.

**Outputs:** OK (BOOL) - execution complete without errors .

RATIOSCL(AXIS := <<USINT>>, NUM := <<INT>>, DEN := <<INT>>, OPTN := <<WORD>>, OK => <<BOOL>>)

The RATIOSCL function allows you to scale the slave and/or master axis in RATIOCAM and RATIOSLP, and the master axis in RATIO\_RL moves. The profiles generated by these moves will be scaled by the amount defined in the numerator (NUM) and denominator (DEN) inputs to the RATIOSCL function. To turn off scaling, call this function again with equal numbers entered in NUM and in DEN.

Ratio move functions called *before* calling the RATIOSCL function are not affected by the scaling. Only the ratio move functions called *after* the RATIOSCL function will be scaled by the value in NUM and DEN. Scaling will be in effect on any RATIOCAM, RATIOSLP, and RATIO\_RL move in your program.

Scaling resolution is maintained throughout the profile. An example of the effect this has is if you have an original profile with equal positive and negative distances, then the scaled profile will also have equal positive and negative distances.

## RATIOSCL

To change the scaling of an already repeating ratio move, follow these steps in order.

1. Call the RATIOSCL function with a new ratio. This will change the scaling for subsequent moves.
2. Call the ratio move again. This will queue the move with the new scaling.
3. Call the REP\_END function. This will end the first move and blend into the second profile with the new scaling.

An overflow in the calculations will cause an E-stop error to be set. Overflows can be caused by a profile segment and/or scaling that is extremely large.

The scaling does not affect the default gear ratio that can be used with the RATIO\_SLP and RATIO\_RL functions. Use the NEWRATIO function to change the default gear ratio value.

It is important to remember that the scaling affects the master/slave relationship, not the individual axes. Multiple slave axes following the same master can each have different master scaling.

With slave scaling, the slave distance is multiplied by the scaling factor. With master scaling, the master distance *as viewed by the slave* is multiplied by the scaling factor as it occurs. This is illustrated by the examples for a RATIOCAM and a RATIOSLP move that follow.



**Ratio Cam Profile**

The RATIOCAM move with no scaling is shown on the left. When you enter a 2/1 slave scaling factor as shown in the center, each original slave distance is multiplied by the scaling factor of 2/1. When you use a 2/1 master scaling factor as shown on the right, the slave axis views the actual master travel as multiplied by the scaling factor of 2/1 as it occurs; i.e., a master travel of 50 counts is actually the 100 counts of the profile.

**RatioCam  
No scaling**

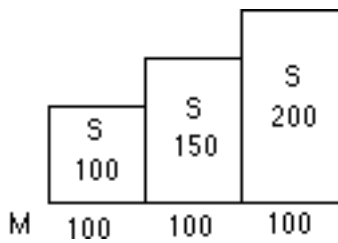

**RatioCam  
Effective profile with slave  
scaling (2/1)**

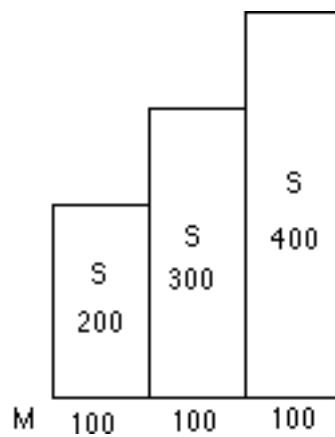

**RatioCam  
Effective profile with  
master scaling (2/1)**

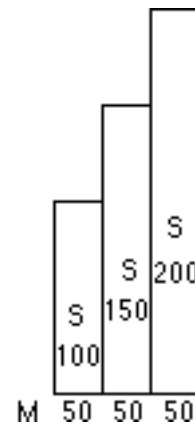

**Ratio Slope Profile**

The RATIOSLP move with no scaling is shown on the left. When you enter a 2/1 slave scaling factor as shown in the center, each original slave distance is multiplied by the scaling factor of 2/1. When you use a 2/1 master scaling factor as shown on the right, the slave axis views the actual master travel as multiplied by the 2/1 scaling factor as it occurs; i.e., a master travel of 50 counts is actually the 100 counts of the profile.

**Ratio Slope  
No scaling**

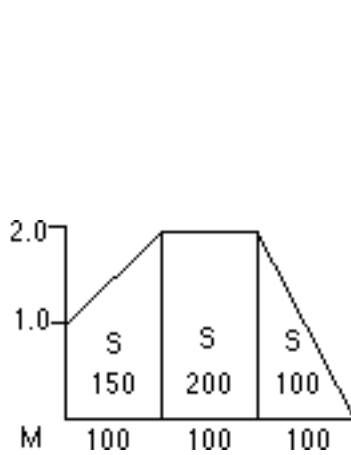

**Ratio Slope  
Effective profile with slave  
scaling (2/1)**

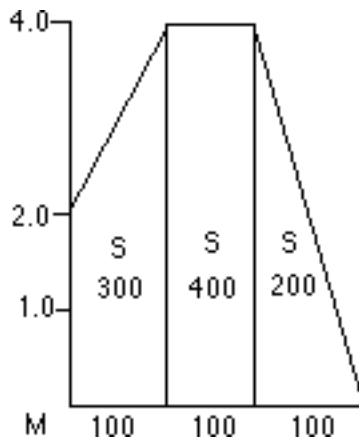

**Ratio Slope  
Effective profile with  
master scaling (2/1)**

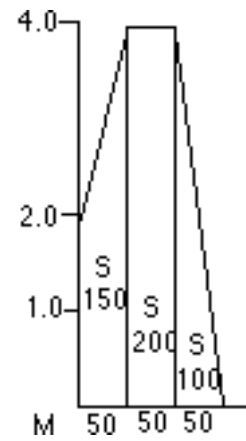

**RATIOSLP**

Ratio Slope

**Motion/RATIOMOV**

RATIOSLP
EN    OK
AXIS  QUE
MAST
SLPE
MSTR
OPTN

**Inputs:** EN (BOOL) - enables execution (**One-shot**)

AXIS (USINT) - identifies the slave axis (servo)

MAST (USINT) - identifies the master axis the slave axis follows

SLPE (ARRAY OF STRUCTURES) - data to define the profile

MSTR (DINT) - Master starting point entered in LU  
If MSTR is outside the range of -536,870,912 to 536,870,911 FU, the OK will not be set

OPTN (WORD) - provides three options: repeat, ignore master start, and use master command position

**Outputs:**OK (BOOL) - execution complete without errors

QUE (USINT) - number of the RATIOSLP move for the queue

**MASTER AXIS NOTE**

The master axis for any master/slave move can be one of three types available:

**A servo axis**

(Range of numbers available to enter at MAST for servo axes is 1 through 16.)

A servo axis must be set up with the Servo setup and tuning program.

**A time axis**

(Range of numbers available to enter at MAST for time axes is 25 through 28.)

A time axis creates a time basis for slave axes to follow. It provides the ability to generate velocity profiles. It is set up and monitored using the S\_CURVE function and/or variables 1, 6, 12, and 26 with the READ\_SV and WRITE\_SV functions.

**A digitizing axis**

(Range of numbers available to enter at MAST for digitizing axes is 49 through 64.)

A digitizing axis must be set up with the Servo setup and tuning program.

## RATIOSLP

RATIOSLP(Axis := <<USINT>>, MAST := <<USINT>>, SLPE := <<MEMORY AREA>>, MSTR := <<DINT>>, OPTN := <<WORD>>, OK => <<BOOL>>, QUE => <<USINT>>)

The RATIOSLP function is similar to the RATIOPRO and RATIOCAM functions. It allows a ratio to be established between a slave axis and a master axis which varies over the course of the profile. The table below compares the three types of moves.

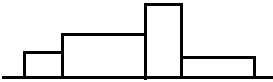
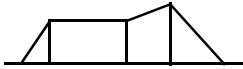
<b>Comparison of RATIOSLP, RATIOCAM and RATIOPRO</b>			
	<b>RATIOSLP</b>	<b>RATIOCAM</b>	<b>RATIOPRO</b>
<b>Setup</b>	Array of structures in ladder Structure members Master distance Slave distance Slope Starting ratio Flags	Array of structures in ladder Structure members Master distance Slave distance	Axis profile setup with PiCPFL editing program
<b>Limit of M/S distances/segment</b>	16-bit (FU)	16-bit (FU)	32-bit (FU)
<b>Profile ratios</b>	Ratios can change linearly within each segment.  Ending ratio of previous segment does not have to equal starting ratio of next segment.	Ratio is constant within each segment. 	Ratios can change linearly within each segment.  Ending ratio of previous segment must equal starting ratio of next segment.
<b>Default ratio</b>	Has a default ratio of 1:1 (Can change default with NEWRATIO function)	No default ratio	No default ratio

With the RATIOSLP function, the slave distance/master distance ratio can vary linearly in segments over the course of the profile.

The data required for creating a slope profile is entered in an array of structures at the SLPE input of the RATIOSLP function. More information on this is covered in the sections on the RATIOSLP structure members and Creating an array of structures.

The master starting point is entered in the MSTR input. The profile will begin executing at the beginning with the master and slave axes locked on when the master reaches its starting position.

**Note:** If the ratio slope move is queued with no master starting position and the master axis is moving in the opposite direction of that indicated in the profile segments, the direction of the master will have to be reversed and the accumulated distance covered before the move will execute.

The OPTN input provides the following options

Bit #	Option	Binary Value	Hex Value Entered
0	Repeat profile	0000000000000001	0001
1	Ignore master start	0000000000000010	0002
4	Use master command position	0000000000010000	0010

If you want the profile to repeat continuously, bit 0 is set. If bit 0 is not set, the profile will execute once and then stop.

If you choose to ignore the master start (bit 1 set), any value you have entered in MSTR has no effect. The slope profile will begin executing as soon as the function is called.

If you want to follow the master's command position instead of the master's actual position, set bit 4.

Velocity Compensation should be inhibited (WRITE\_SV Variable 32 = 1) prior to executing RATIOSLP with this bit set.

Other characteristics of the ratio slope move include:

- Affects the slave axis only.
- The slave axis may be a master axis to another axis.
- More than one slave axis may be connected to the master axis.
- The master axis may be a servo, a time, or a digitizing axis.
- If the master axis reverses direction, the slave axis will follow. A positional relationship has been established for each segment and the software will maintain that relationship. If, for example, the master axis would change direction during the profile, the slave axis would move backwards through

the profile so that when the master axis reaches a certain position the slave axis will be at its corresponding position as defined in the array of structures.

- If it is not desirable to have the slave axis follow the master axis when the master reverses direction, variable 21 (reversal not allowed) of the WRITE\_SV function can be set. (The state of variable 21 can also be read with the READ\_SV function.) The WRITE\_SV function must always be called *before* the RATIOSLP function.
- Inverted ratios are possible by entering negative slave segment elements in the array of structures defining your profile. (NOTE: The sign on the master elements entered in the array of structures must all be the same.)
- An individual segment of the profile may pass through zero. Segment 3 in the profile on the left passes through zero to cover the slave distance (shaded areas). The profile on the right uses two segments to accomplish the same thing.

Segment passing through zero

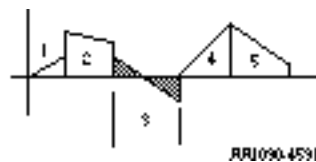

Two separate segments

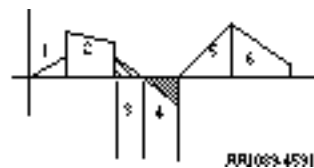

- The starting point for the master axis may be entered. If the move is queued with no master start and the master axis is moving in the opposite direction as defined by the profile segments, the distance will be accumulated. This distance must be recovered before motion will start.
- Both the master and slave axes must be at the same interrupt rate.
- Registration can be used with the RATIOSLP function.
- The profile can be changed on the fly by queuing up a new ratio slope move and aborting the current one. Any remainder from the previous move is cleared.
- The default ratio of the function is executed whenever an empty segment is encountered and/or the flag is set. The default ratio is 1:1. This can be changed with the NEWRATIO function.  
NOTE: It is possible to set up a default ratio with no motion on the slave axis by entering a 0 in the SDST input of the NEWRATIO function.
- The ratioSLP function move will repeat continuously if bit 0 of the OPTN input is set until either the move is aborted or a REP\_END function is called. With the abort move function, the move will stop wherever it is in the profile. With the repeat end function, the move will stop at the end of the current profile.

- Some conditions for which the OK will not be set and the queue will be “0” include:
  1. Master axis not available (P-error) [Master axis not initialized, master and slave interrupts different, the same axis was entered as master and slave, or OPTN bit 4 is set and the master axis is not a servo axis.]
  2. Profile error (P-error) [A number less than two entered as the size of the profile, a master segment is zero, or not all master segments have the same sign]
  3. Master start value is out of range.
  4. Slave axis (AXIS) not initialized during setup
- A P-error will occur if the master axis is beyond its start point.
- An E-error will occur if there are calculation errors during runtime. The hex code 0004 indicates this error on the ERRS output of the E\_ERRORS function.

**RATIOSLP structure members**

The five members of the structure required for the array of structures at the SLPE input are described below.

<b>MASTER</b> (master distance)	<b>INT</b> Range -32768 to 32767 FU	The MASTER member specifies the distance (in feedback units) the master travels during a segment. The values of the master distance entered in feedback units must all be the same sign for each segment.
<b>SLAVE</b> (slave distance)	<b>INT</b> Range -32786 to 32787 FU	The SLAVE member specifies the distance (in feedback units) the slave travels while the master travels its distance during a segment. The values of the slave distance entered in feedback units can be either sign.
<b>SLOPE</b> (slope)	<b>DINT</b> Range -2147483648 to 2147483647 scaled by $2^{24}$ (Range -127 to 127 unscaled)	The SLOPE member specifies the slope of the segment.
<b>SRATIO</b> (starting ratio)	<b>DINT</b> Range -2147483648 to 2147483647 scaled by $2^{24}$ (Range -127 to 127 unscaled)	The SRATIO member specifies the starting ratio of the segment.



**FLAGS**  
(flags)

**DWORD** (32 bits; 0-31)

31 30 29 28 27 26 25 24 23 22 21 20 19 18 17 16 15 14 13 12 11 10 9 8 7 6 5 4 3 2 1 0



**Bit 1:**

0 = copy a 0 to bit 0 after segment execution;

1 = copy a 1 to bit 0 after segment execution

**Bit 0:**

0 = execute valid data for segment;

1 = execute default ratio

If bit 1 is set to 0, the segments of the slope profile will execute in sequence as entered in the array of structures.

If bit 0 is set to 1, the segment is considered empty. The default ratio will be in effect until bit 0 is set to 0 and a valid slope profile data is entered in the array of structures.



NOTE: The default ratio of the RATIOSLP function is 1:1. The NEWRATIO function allows you to change the default to another value.

As each segment completes its execution, whatever value is in bit 1 is copied into bit 0.

All remaining bits (2-15) should be set to zero.

**Working with the FLAGS member**

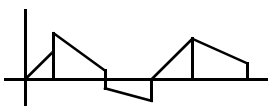
The FLAGS member of the structure provides the capability of using the default ratio with the RATIOSLP function. Once the default ratio is running it is possible to use the array of structures like a rotary queue with data moving in from the ladder and out via servos in sequence.

Bit 1	Bit 0		Example
0	0	With both bits set to zero, the RATIOSLP function will execute like RATIOCAM. If repeat is set on the OPTN input, the profile will repeat continuously.	
1	1	With both bits set to one, the RATIOSLP function will execute at the default ratio until the ladder places data in the array of structures and clears bit 0.	<b>Default Ratio</b> 

When each segment of the profile completes its execution, whatever is in bit 1 is copied into bit 0.

NOTE: Whenever the default ratio is used, set the reversal not allowed flag using variable 21 of the WRITE\_SV function before calling the RATIOSLP function.

**Creating a profile with an array of structures**

Each segment in the slope profile is defined by you in PiCPro by creating an array of structures in the software declarations table. (More information on arrays and structures can be found in Chapters 2 and 3. See also the RATIOCAM function.)

There are five members of the structure--the master distance, the slave distance, the slope, the starting ratio, and flags. Each element in the array represents these five items for one segment of the slope profile.

In order to enter the data for the array of structures, you need to know:

1. The master distance, the slave distance, the slope, the starting ratio, and the ending ratio for each segment.
2. Whether or not you want to turn the array of structures into a rotary queue and make use of default ratio capability. This is done with the FLAGS member of the structure.
3. The number of segments the profile contains. NOTE: Add "1" to this number to calculate the length of the array to determine the size of the profile.

### Example

A simplified example of a ratio slope profile is shown in Figure 2-17. It has six segments.

**Figure 2-17. Slope profile**

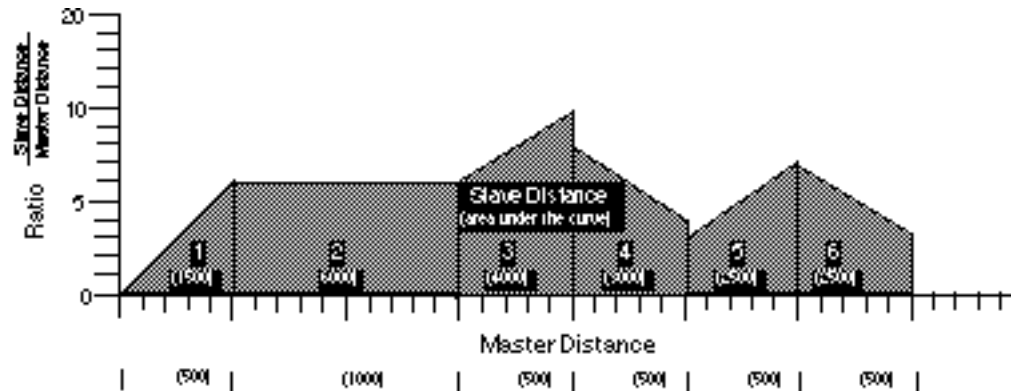

NOTE: Each division on the horizontal axis equals 100 units.  
Each division on the vertical axis equals 1 unit.

RR1060-4591

For each individual segment, you determine how far the slave axis will move while the master axis covers its segment distance. This establishes the slave distance/ master distance ratio for the segment. You also need to know the starting ratio of each segment. With this information, an ending ratio can be calculated. Once this is known, the slope for the segment can be calculated.

The following steps illustrate how to determine this data for one segment from the profile as shown in Figure 2-18.

**Figure 2-18. Segment 3 of the ratio slope profile**

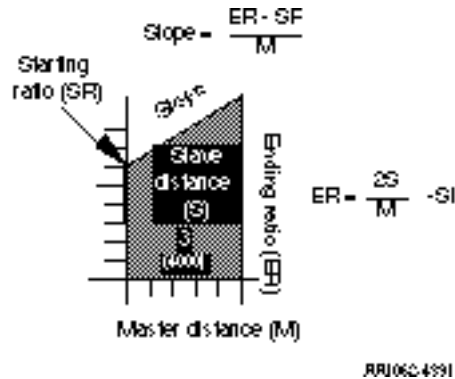

- Step 1. Master Distance** - The master distance for segment 3 is 500 units.
- Step 2. Slave Distance** - The slave distance is determined by calculating the area under the curve. This is 4000 units.
- Step 3. Starting Ratio** - The starting ratio from the vertical axis is 6. The starting ratio must be scaled by  $2^{24}$  or 16777216 before entering the array element.

$$6 \times 2^{24} = 100663296$$

- Step 4. Ending Ratio** - The ending ratio is calculated from the following formula:

$$ER = \frac{2S}{M} + SR = \left( \frac{2 \times 4000}{500} + 6 \right) = 10$$

**where:**

- ER = ending ratio  
 S = slave distance  
 M = master distance  
 SR = starting ratio

**Note:** The ending ratio is needed in order to calculate the slope. It is not entered into the structure.

**Step 5. Slope** - The slope is calculated from the following formula.

$$Slope = \frac{ER - SR}{M}$$

$$Slope = \frac{10 - 8}{500}$$

$$Slope = .004$$

The slope must be scaled by  $2^{24}$  or 16777216 before entering in the array element.

$$0.004 \times 2^{24} = 67109$$

<b>DATA REQUIRED FOR RATIO SLOPE PROFILE</b>						
<b>Segment #</b>	<b>1</b>	<b>2</b>	<b>3</b>	<b>4</b>	<b>5</b>	<b>6</b>
<b>Master</b>	500	1000	500	500	500	500
<b>Slave</b>	1500	6000	4000	3000	2500	2500
<b>Slope</b>	.012	0	.008	-.008	.008	-.008
<b>Starting Ratio</b>	0	6	6	8	3	7
<b>(Ending Ratio*)</b>	(6)	(6)	(10)	(4)	(7)	(3)

\*The ending ratio is needed in order to calculate the slope. It is not entered into the structure.

DATA TO ENTER INTO ARRAY OF STRUCTURE							
Element #	0	1	2	3	4	5	6
Master	7	500	1000	500	500	500	500
Slave	0	1500	6000	4000	3000	2500	2500
Slope (Scaled)	0	67108	0	134218	-134218	134218	-134218
Starting Ratio (Scaled)	0	0	100663296	100663296	134217728	50331648	117440512
Flag	0	0	0	0	0	0	0

### IMPORTANT

Remember that the first element in the array determines the size of the profile.

The .MASTER line of the first element must contain the number of segments in the profile plus one.

It is not necessary to enter any value in the remaining lines. They will default to zero.

By entering the name of the array and the first element at the SLPE input, the desired profile can be accessed by the RATIOSLP function.

### CAUTION

Never attempt to change the values in the array elements while the move is being executed unless the rotary queue is in effect.

**RATIOSYN**

Ratio Synchronization

**Motion/RATIOMOV**

RATIOSYN	
EN	OK
AXIS	QUE
MAST	
SDST	
MDST	
SSTR	
MSTR	

- Inputs:** EN (BOOL) - enables execution (**One-shot**)
- AXIS (USINT) - identifies the slave axis which will move at a constant ratio depending on the master axis movement (servo)
- MAST (USINT) - identifies the master axis that the slave axis is to follow
- SDST (DINT) - (slave distance) indicates the distance the slave should move for each MDST distance (entered in LU\*)
- MDST (DINT) - (master distance) indicates the distance the master axis will move during each SDST (entered in LU\*)
- \*NOTE: The range of values entered in SDST and MDST is -536,870,912 to 536,870,911 FU excluding 0. If you are using ladder units be sure they do not exceed this range when converted to feedback units.
- SSTR (DINT) - Slave starting point entered in LU  
If SSTR is outside the range of -536,870,912 to 536,870,911 FU, the OK will not be set.
- MSTR (DINT) - Master starting point entered in LU  
If MSTR is outside the range of -536,870,912 to 536,870,911 FU, the OK will not be set.
- Outputs:** OK (BOOL) - execution completed without error
- QUE (USINT) - number of ratio syn move for queue

```
RATIOSYN(AXIS := <<USINT>>, MAST := <<USINT>>, SDST := <<DINT>>,
MDST := <<DINT>>, SSTR := <<DINT>>, OK => <<BOOL>>, QUE =>
<<USINT>>)
```

The ratio syn move function, like the ratio gear move, establishes a constant ratio between a slave axis and a master axis.

In addition, a positional relationship between the master and slave is defined. The master starting point (MSTR) and the slave starting point (SSTR) are entered. The sign on the number entered in MDST dictates the direction the axis must approach its starting point.

If the slave axis should move 2 units every time the master axis moves 3 units, enter “2” in SDST and “3” in MDST.

If there is a remainder as a result of the software division,  $\frac{\text{slave distance}}{\text{master distance}}$  the software includes it in its calculations preventing any drifting from the desired ratio.

<b>MASTER AXIS NOTE</b>	
<p>The master axis for any master/slave move can be one of three types available:</p>	
<p>1. <b>A servo axis</b></p>	<p>(Range of numbers available to enter at MAST for servo axes is through 16.) A servo axis must be set up with the Servo setup and tuning program.</p>
<p>2. <b>A time axis</b></p>	<p>(Range of numbers available to enter at MAST for time axes is 25 through 28.) A time axis creates a time basis for slave axes to follow. It provides the ability to generate velocity profiles. It is set up and monitored using the S_CURVE function and/or variables 1, 6, 12, and 26 with the READ_SV and WRITE_SV functions.</p>
<p>3. <b>A digitizing axis</b></p>	<p>(Range of numbers available to enter at MAST for digitizing axes is 49 through 64.) A digitizing axis must be set up with the Servo setup and tuning program.</p>

**A. Mechanical Representation**

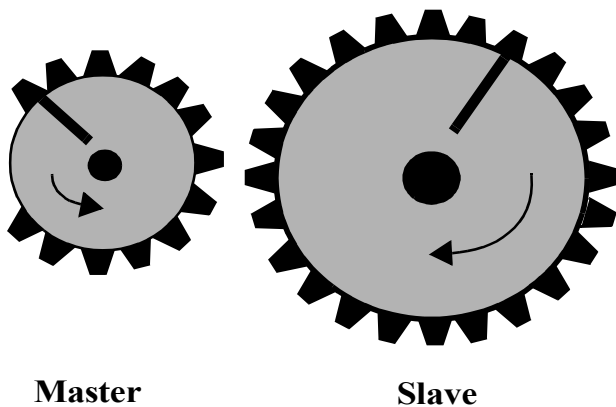

The ratiosyn move is similar to the ratio gear move in that the gears will move at a constant ratio. In addition, a positional relationship between the master and slave axes is established.

The profile of the move would look like that shown to the right of example C. Note that the A, B, and C points correspond to the gear positioning in diagrams A, B, and C on the left.

When the function is executed (A), the master is in motion. From A to B in the profile, the positional relationship is established.



B.

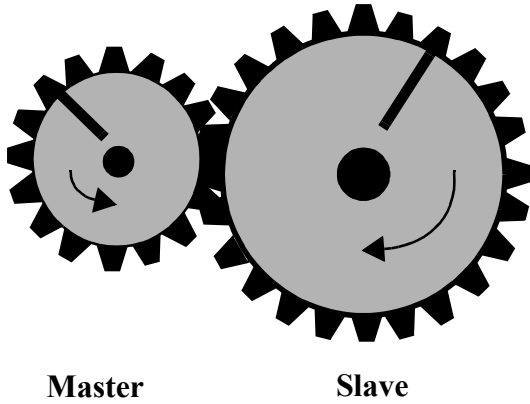

At B, the axes move together and are locked on. The slave axis began to move at a point that ensured that it will reach SSTR when the master axis reaches MSTR.

In the profile, the shaded area represents the distance the slave moved in anticipation of arriving at SSTR when the master reached MSTR. It represents the difference between SSTR and the actual position of the slave. The slave starts out at the constant ratio.

When the axes arrive at C, their positions are aligned as shown in C below left. This positional relationship will be maintained throughout the move.

C.

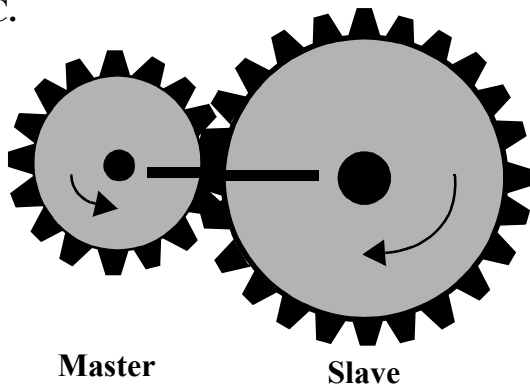

Ratio Syn Profile

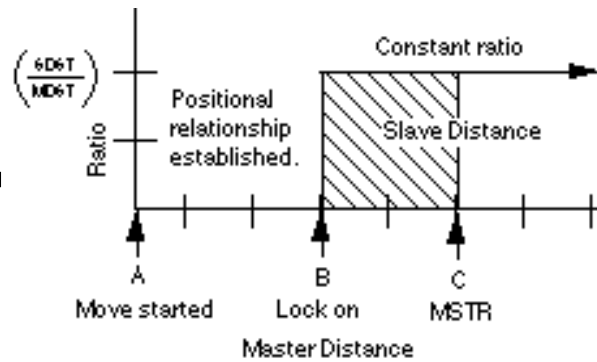

AM53-5190

Some characteristics of the ratio syn move include:

- Affects the slave axis only.
- The slave axis may be a master axis to another axis.
- More than one slave axis may be connected to the master axis.
- The master axis may be a servo or a digitizing axis.
- If the master axis reverses direction, the slave will follow.
- Inverted ratios are possible by making *either* SDST or MDST negative. (Making both signs negative has the same affect as making both signs positive.)
- Starting points for the master axis and slave axis are entered. (See the explanation that follows for conditions necessary to ensure that a ratio syn move will begin.)
- Both the master and slave axes must be at the same interrupt rate.
- The ratio can be changed on the fly by using the NEWRATIO function
- If WRITE\_SV Variable 59 = 0 (default), RATIOSYN will use the master's actual position. If Variable 59 = 1, RATIOSYN will use the master's command position. Also, if Variable 59 = 1, the master axis must be a servo axis.

### Master and slave axes starting points

For a RATIOSYN move to occur, the slave axis must start at a point so that when the master axis arrives at the value entered in MSTR, the slave axis will be at the value entered at SSTR. The following guidelines ensure that this will happen.

- Both axes must be below their respective starting points.
- The master axis must be moving in the correct direction to reach its starting points. Direction is defined by the sign of the number entered in MDST.
- The master axis must be a greater distance from its MSTR position than the slave axis is from its SSTR position.

When you enter a value in SSTR, the software uses that information plus what it knows about the slave's actual position to calculate the ratio syn starting position for the master. Several examples of how the master start is calculated follow. The first three follow the guidelines listed above.

Examples 4 and 5 show the effect of rollover on position in allowing the guidelines to be "stretched."

**Example 1 - Slave axis at SSTR**

In this example:

SDST = 1  
 MDST = 1  
 SSTR = 100  
 MSTR = 200

The slave/master ratio is 1:1. A slave starting point (SSTR) of 100 and a master starting point (MSTR) of 200 has been entered. The slave axis is at SSTR. In this case, the calculated master start will equal the value at MSTR.

ms (calculated master start) = MSTR

SC (slave current position) = 100  
 ROP (rollover on position) = Off

When the master axis reaches 200, the slave axis begins to move. The axes are locked and synchronized.

**Figure 2-19. Slave axis at SSTR**

This symbol represents lock on for the axes.

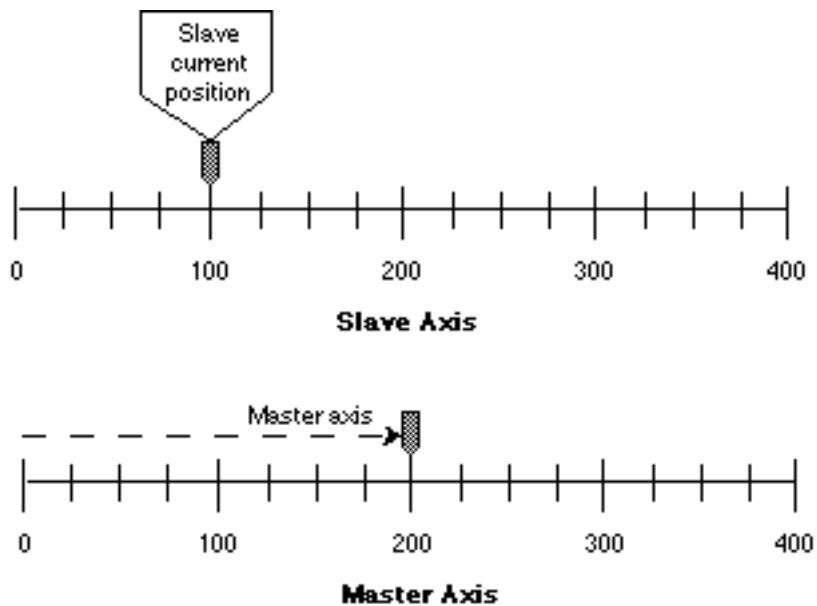

RR00:0591

**Example 2 - Slave axis below SSTR**

In this example:

SDST = 1  
 MDST = 1  
 SSTR = 100  
 MSTR = 200

The slave/master ratio is 1:1, the slave start is 100 and a master start is 200. The slave's current position is 25. The calculation is:

$$ms = MSTR - (SSTR - SC)$$

$$ms = 200 - (100 - 25)$$

$$ms = 125$$

SC (slave current position) = 25  
 ROP (rollover on position) = Off

When the master axis reaches 125, the slave axis will begin to move toward 100 so that when the master reaches 200 the slave will be at 100.

**Figure 2-20. Slave axis below SSTR**

 This symbol represents lock on for the axes.

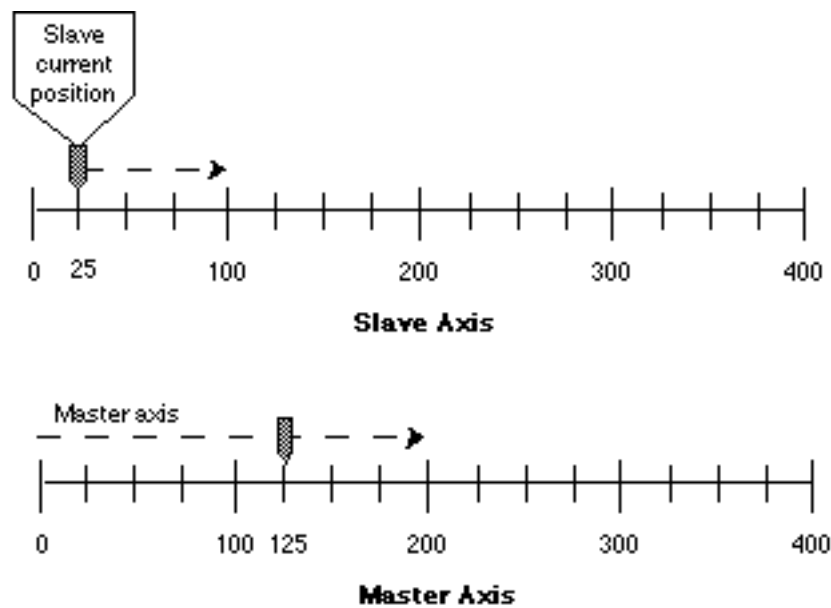

RR005-0591

**Example 3 - Slave/master ratio in not 1:1**

In this example:

SDST = 2  
 MDST = 1  
 SSTR = 100  
 MSTR = 200

SC (slave current position) = 25  
 ROP (rollover on position) = Off

Rotary axes will be used to show a ratio of 2:1. The slave start is 100 and the master start is 200. The slave's current position is 25. The calculation is:

$$ms = \frac{(SSTR - SC) \times MDST}{SDST}$$

$$ms = \frac{(100 - 25) \times 1}{2}$$

$$ms = 37.5$$

$$ms = MSTR - ms$$

$$ms = 200 - 37.5$$

$$ms = 162.5$$

When the master axis reaches 162.5, the slave axis will begin to move to 100 so that when the master reaches 200 the slave will be at 100.

Figure 2-21. S/M ratio not 1:1

 This symbol represents lock on for the axes.

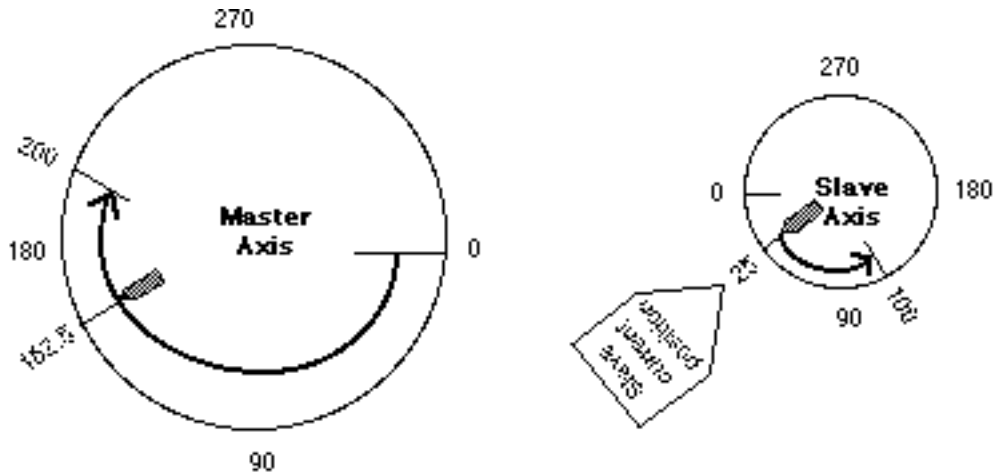

RR804-0531

In any of these examples, it would be impossible to perform a ratio syn move if the slave axis was past SSTR or the master axis was past the calculated master start position.

However, if rollover on position is applied to the master and/or slave axis, it may still be possible to lock on and synchronize.

**Example 4 - Rollover on position on the slave axis; the slave is past the SSTR**

In this example:

SDST = 1  
 MDST = 1  
 SSTR = 50  
 MSTR = 200

The current slave position is past its SSTR value.

Without using rollover on position, the ratio syn move could not be started.

With rollover on position set at 100, the calculated master start is as follows:

$$ms = MSTR - (SSTR - SC + ROP)$$

SC (slave current position) = 75

$$ms = 200 - (50 - 75 + 100)$$

ROP (rollover on position) = 100

$$ms = 125$$

(slave)

**Figure 2-22. ROP on slave; slave past SSTR**

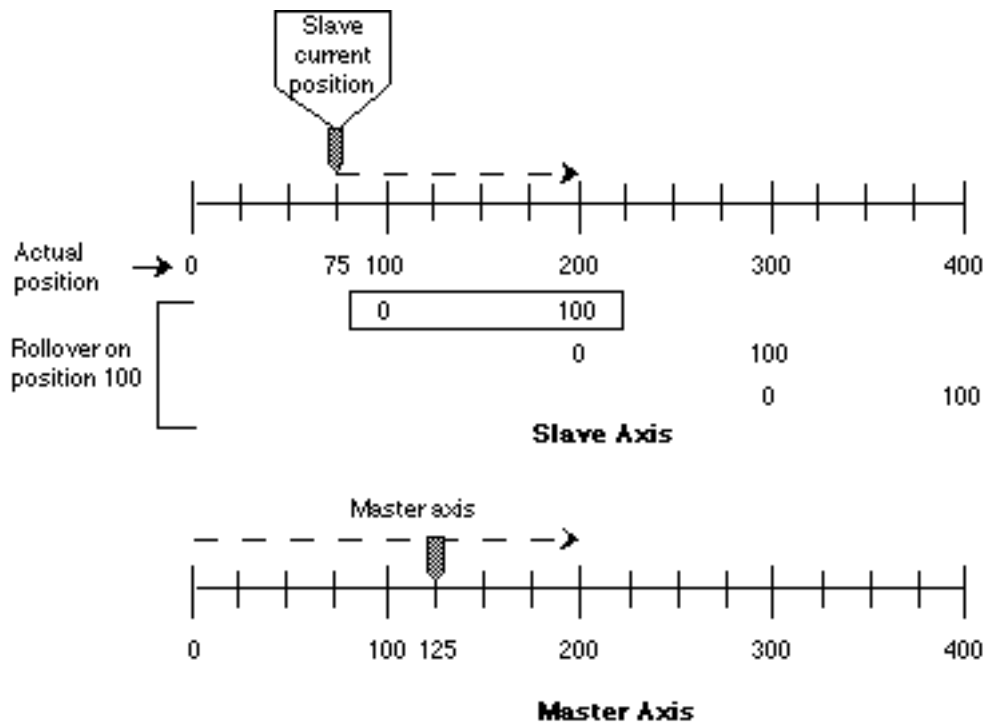

RR05-0591

**Example 5 - Rollover on position on the master axis; master is past the MSTR**

In this example:

SDST = 1  
 MDST = 1  
 SSTR = 100  
 MSTR = 75

SC (slave current position) = 50  
 MC (master current position) = 175  
 ROP (rollover on position) = 200  
 (master)

The current master position is past its MSTR value. Without using rollover on position, the ratio syn move could not be started.

With rollover on position set at 200, the calculated master start is as follows:

$$ms = (MSTR - MC + ROP) - (SSTR - SC)$$

$$ms = (75 - 175 + 200) - (100 - 50)$$

$$ms = 50$$

Since the master is already past 50, A ROP is added to ms to ensure start.

**Figure 2-23. ROP on master; master past MSTR**

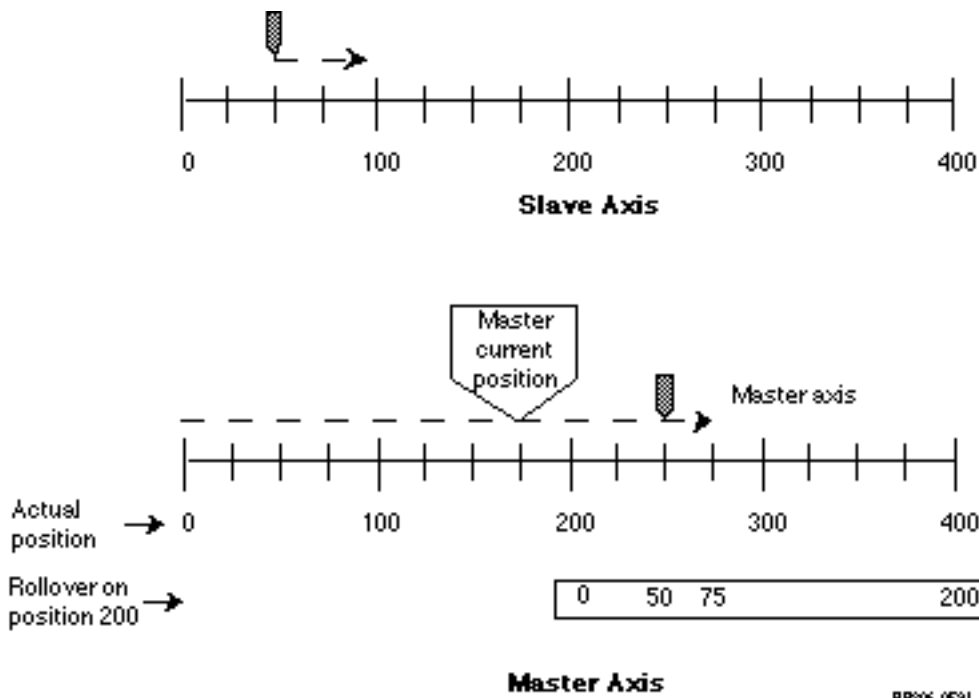

AR06-0591

**NOTE**

Master and slave offsets will also have an effect on the starting of a ratio syn move. They would be added into (or subtracted out of) the calculations with MSTR and SSTR respectively.



**RATIO\_GR**

Ratio Gear

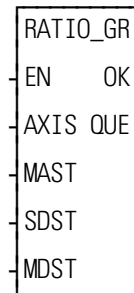
**Motion/RATIOMOV**

**Inputs:** EN (BOOL) - enables execution (**One-shot**)

AXIS (USINT) - identifies the slave axis which will move at a constant ratio depending on the master axis movement. (servo)

MAST (USINT) - identifies the master axis that the slave axis is to follow (See master axis note below.)

SDST (DINT) - (slave distance) indicates the distance the slave should move for each MDST distance (entered in LU\*)

MDST (DINT) - (master distance) indicates the distance the master axis will move during each SDST (entered in LU\*)

\*NOTE: The range of values entered in SDST and MDST is -536870912 to +536870911 FU (excluding 0 for the MDST input.) If you are using ladder units, make sure they do not exceed this range when converted to feedback units.

**Outputs:** OK (BOOL) - execution completed without error

QUE (USINT) - number of ratio gear move for queue

GR(AXIS := <<USINT>>, MAST := <<USINT>>, SDST := <<DINT>>, MDST := <<DINT>>, OK => <<BOOL>>, QUE => <<USINT>>)

The ratio gear move function establishes a constant ratio between a slave axis (AXIS) and a master axis (MAST).

NOTE: The master axis cannot be entered in AXIS. This will generate a P-error if attempted.

If the slave axis should move 2 units every time the master axis moves 3 units, enter “2” in SDST and “3” in MDST.

If there is a remainder as a result of the software division of slave distance divided by master distance, the software includes it in its calculations preventing any drifting from the desired ratio.

See also RATIOSYN.

### MASTER AXIS NOTE

The master axis for any master/slave move can be one of three types available:

1. **A servo axis**  
(Range of numbers available to enter at MAST for servo axes is 1 through 16.)  
A servo axis must be set up with the Servo setup and tuning program.
2. **A time axis**  
(Range of numbers available to enter at MAST for time axes is 25 through 28.)  
A time axis creates a time basis for slave axes to follow. It provides the ability to generate velocity profiles. It is set up and monitored using the S\_CURVE function and/or variables 1, 6, 12, and 26 with the READ\_SV and WRITE\_SV functions.
3. **A digitizing axis**  
(Range of numbers available to enter at MAST for digitizing axes is 49 through 64.)  
A digitizing axis must be set up with the Servo setup and tuning program.

#### A. Mechanical Representation

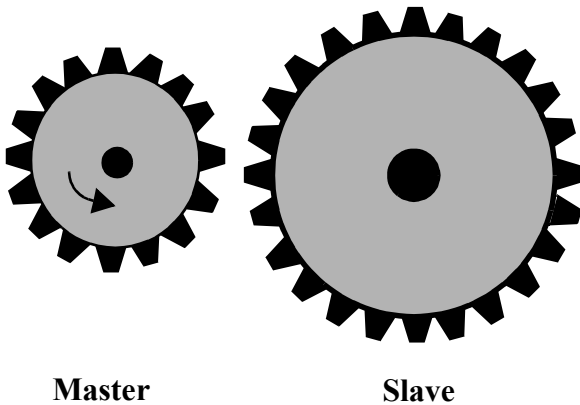

A ratio gear move can be represented mechanically by two gears as shown on the left. The master gear is in motion.

When the function is executed, imagine the gears moving together as shown in B. The slave begins its motion from whatever position it is at and follows the master at a constant ratio until the move is ended.

The profile of the move would look like that shown to the right of example B.

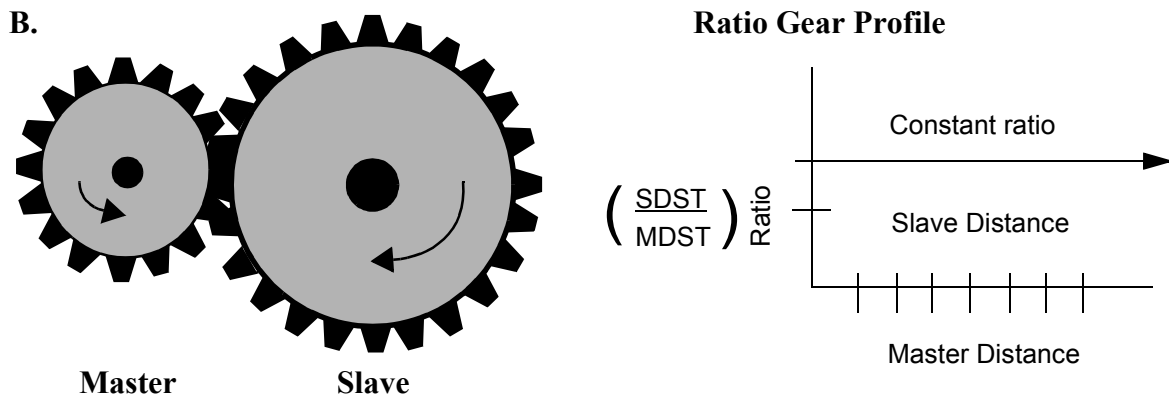

Some characteristics of the gear ratio move include:

- Affects the slave axis only.
- The slave axis may be a master axis to another axis.
- More than one slave axis may be connected to the master axis.
- The master axis may be a servo or a digitizing axis.
- If the master axis reverses direction, the slave will follow.
- Inverted ratios are possible by making *either* SDST or MDST negative. (Making both signs negative has same affect as making both signs positive.)
- No starting or stopping points are entered.
- Both the master and slave axes must be at the same interrupt rate.
- The ratio can be changed on the fly by:
  - Calling the NEWRATIO function
  - Queuing up a new ratio move and aborting the current one. Any remainder from the previous move is cleared.
- If WRITE\_SV Variable 59 = 0 (default), RATIO\_GR will use the master's actual position. If Variable 59 = 1, RATIO\_GR will use the master's command position.
- Some conditions for which OK will not be set and the queue is "0" include:
  - Master axis not available (P-error) [Master axis not initialized, master and slave interrupts different, same axis entered as master and slave, or variable 59 = 1 and the master axis is not a servo axis.]
  - Slave distance not valid (P-error)
  - Master distance not valid (P-error)
  - Slave axis (AXIS) not initialized during setup
- An E-error will occur if there is a slave delta overflow during runtime. The hex code 0004 indicates this error on the ERRS output of the E\_ERRORS function.

---

---

**RATIO\_RL***Ratio Real***Motion/RATIOMOV**

---

---

RATIO_RL	
EN	OK
AXIS	QUE
MAST	
REAL	
MSTR	
OPTN	

**Inputs:** EN (BOOL) - enables execution (**One-shot**)  
 AXIS (USINT) - identifies slave axis (servo)  
 MAST (USINT) - identifies master axis  
 REAL (ARRAY OF STRUCTURES) - points to the first element in the array of structures defining the profile to run  
 MSTR - (DINT) - master starting point of the move entered in LU  
 If MSTR is outside the range of -536,870,912 to 536,870,911 FU, the OK will not be set.  
 OPTN - (WORD) - provides three options: repeat, ignore master start, and use master's command position

**Outputs:** OK (BOOL) - execution completed without error  
 QUE (USINT) - number of real profile move for the queue

RATIO\_RL(AXIS := <<USINT>>, MAST := <<USINT>>, REAL := <<MEMORY AREA>>, MSTR := <<DINT>>, OPTN := <<WORD>>, OK => <<BOOL>>, QUE => <<USINT>>)

The RATIO\_RL function is an axis control function requiring servo initialization and a math coprocessor on the PiC CPU. It is similar to the function. The difference is that the data defining the slave axis profile for RATIO\_RL uses floating point numbers. Each segment of the profile can be a trigonometric function or a polynomial. A trigonometric function requires that the radius, starting angle, and segment length be entered in a structure.

RATIO\_RL can be used in conjunction with the math conversion COORD2RL function.

The AXIS and MAST inputs are used to identify the slave and master axes respectively.

### MASTER AXIS NOTE

The master axis for any master/slave move can be one of three types available:

**A servo axis**

(Range of numbers available to enter at MAST for servo axes is 1 through 16.)

A servo axis must be set up with the Servo setup and tuning program.

**A time axis**

(Range of numbers available to enter at MAST for time axes is 25 through 28.)

A time axis creates a time basis for slave axes to follow. It provides the ability to generate velocity profiles. It is set up and monitored using the S\_CURVE function and/or variables 1, 6, 12, and 26 with the READ\_SV and WRITE\_SV functions.

**A digitizing axis**

(Range of numbers available to enter at MAST for digitizing axes is 49 through 64.)

A digitizing axis must be set up with the Servo setup and tuning program.

When the MSTR input is used, it defines the master axis position at the beginning of the profile.

The OPTN input provides the following options:

Bit #	Option	Binary Value	Hex Value Entered
0	Repeat profile	0000000000000001	0001
1	Ignore master start	0000000000000010	0002
4	Use master command position	0000000000010000	0010

If you want the profile to repeat continuously, bit 0 is set. If bit 0 is not set, the profile will execute once and then stop.

If you choose to ignore the master start (bit 1 set), any value you have entered in MSTR has no effect. The slope profile will begin executing as soon as the function is called.

If you want to follow the master's command position instead of the master's actual position, set bit 4.

Velocity Compensation should be inhibited (WRITE\_SV Variable 32 = 1) prior to executing RATIO\_RL with this bit set.

Some characteristics of the ratio real move include:

- Affects the slave axis only.
- The slave axis may be a master axis to another axis.
- More than one slave axis may be connected to the master axis.
- The master axis may be a servo, a time, or a digitizing axis.
- If the master axis reverses direction, the slave axis will follow. A positional relationship has been established for each segment and the software will maintain that relationship. If, for example, the master axis would change direction during the profile, the slave axis would move backwards through the profile so that when the master axis reaches a certain position the slave axis will be at its corresponding position as defined in array of structures.
- If it is not desirable to have the slave axis follow the master axis when the master reverses direction, variable 21 (reversal not allowed) of the WRITE\_SV function can be set. (The state of variable 21 can also be read with the READ\_SV function.) The WRITE\_SV function must always be called *before* the RATIO\_RL function.
- Inverted ratios are possible by entering negative slave segment elements in the array of structures defining your profile. (NOTE: The sign on the master elements entered in the array of structures must all be the same.)
- The starting point for the master axis may be entered. If the move is queued with no master start and the master axis is moving in the opposite direction as defined by the profile segments, the distance will be accumulated. This distance must be recovered before motion will start.
- Both the master and slave axes must be at the same interrupt rate.
- Registration can be used with the RATIO\_RL function.
- The ratio\_RL function move may repeat continuously if the repeat option is set until either the move is aborted or a REP\_END function is called. With the abort move function, the move will stop wherever it is in the profile. With the repeat end function, the move will stop at the end of the current profile.
- Some conditions for which the OK will not be set and the queue will be “0” include
  1. Master axis not available (P-error) [Master axis not initialized, master and slave interrupts different, the same axis was entered as master and slave, or OPTN bit 4 is set and the master axis is not a servo axis.]
  2. Profile error (P-error) [A number less than two entered as the size of the profile, a master segment is zero, or not all master segments have the same sign]
  3. Master start value is out of range.
  4. Slave axis (AXIS) not initialized during setup.
- A P-error will occur if the master axis is beyond its start point.
- An E-error will occur if there is a slave delta overflow during runtime.

**RATIO\_RL structure members for the REAL input**

The members of the structure required for the array of structures at the REAL input are described below.

**IMPORTANT**

The structure entered in the software declarations table for the REAL input must have the members entered in the order listed in the table that follows. The data type entered in the **Type** column for each member of the structure must be as shown in order for the software to recognize the information.

**NOTE**

Remember that the first (0) element in the array determines the size of the profile. The .MASTER line of the first element must contain the number of segments in the profile plus one.  
It is not necessary to enter any value in the other lines. They will default to zero.

<b>MASTER</b> (master distance)	<b>DINT</b> (Range -536,870,912 to +536,870,911 FU)	The MASTER member specifies the distance (in feedback units) the master travels during a segment. The values of the master distance must all be the same sign for each segment.
<b>SLAVE</b> (slave distance)	<b>DINT</b> (Range -536,870,912 to +536,870,911 FU)	The SLAVE member specifies the distance (in feedback units) the slave travels while the master travels its distance during a segment. The values of the slave distance can be either sign.
<b>LEN</b> (length/ $K_1$ )	<b>LREAL</b>	For a circular move, LEN holds the number of master counts in one radian. For a linear move, LEN holds the value of $K_1$ .
<b>AMPL</b> (amplitude/ $K_2$ )	<b>LREAL</b>	For a circular move, AMPL holds the wave amplitude. For a linear move, AMPL holds the value of $K_2$ .
<b>STANGL</b> (starting angle/ $K_3$ )	<b>LREAL</b>	For a circular move, STANGL holds the value of the starting angle in radians. For a linear move, STANGL holds the value of $K_3$ .
<b>SPARE</b> (spare)	<b>LREAL</b>	Declare this in your structure since it may be used in the future for additional features.
<b>FLAGS</b> (flags)	<b>DWORD</b>	Bits 0 through 4 are currently being used.



**FLAGS**  
(flags)

**DWORD** Bits 0 through 4 are currently being used.

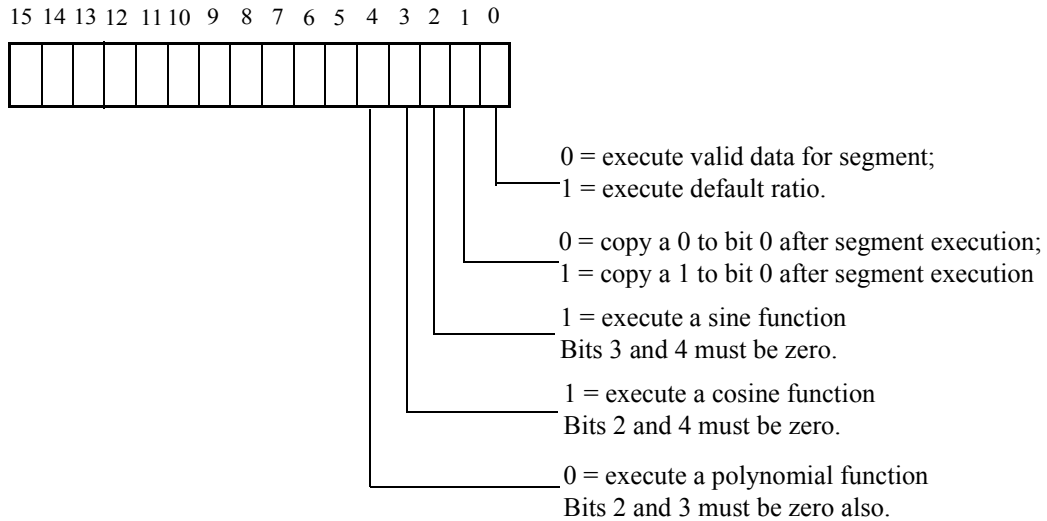

If bit is set to 0, the segments of the real profile will execute in sequence as entered in the array of structures.

**Bit 0** If bit 0 is set to 1, the segment is considered empty. The default ratio will be in effect until bit 0 is set to 0 and valid real profile data is entered in the array of structures

NOTE: The default ratio of the RATIO\_RL function is 1:1. The NEWRATIO function allows you to change the default to another value.

**Bit 1** As each segment completes its execution, whatever value is in bit 1 is copied into bit 0.

**Bit 2** If bit 2 is set to 1 and bits 3 and 4 are 0, a sine wave is executed. The slave distance into the segment is calculated as follows:

$$\text{Distance} = A \sin\left(\frac{m}{LEN} + \theta_s\right) - A \sin \theta_s$$

where:

- A = amplitude
- m = master distance into segment
- LEN = number of master counts in one radian
- $\theta_s$  = starting angle in radians

**FLAGS (Cont.)**      **DWORD** Bits 0 through 4 are currently being used.  
(flags)

**Bit 3** If bit 3 is set to 1 and bits 2 and 4 are 0, a cosine wave is executed. The slave distance into the segment is calculated as follows:

$$\text{Distance} = A \cos\left(\frac{m}{LEN} + \theta_s\right) - A \cos \theta_s$$

where:

A = amplitude

m = master distance into segment

LEN = number of master counts in one radian

$\theta_s$  = starting angle in radians

**Bit 4** If bits 2, 3, and 4 are 0, a polynomial is executed. The slave distance into the segment is calculated as follows:

$$\text{Distance} = K_1 m + K_2 m^2 + K_3 m^3$$

where:  $K_1, K_2, K_3$  = long reals

m = master distance into segment

All remaining bits (5-15) should be set to zero.

### Working with the FLAGS and the default ratio

The FLAGS member of the structure provides the capability of using the default ratio with the RATIO\_RL function. Once the default ratio is running it is possible to use the array of structures like a rotary queue with data moving in from the ladder and out via servos in sequence.

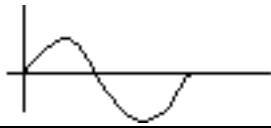
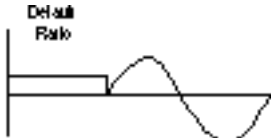
Bit 1	Bit 0		Example
0	0	With both bits set to zero, the RATIO_RL function will execute the segment beginning at the defined starting angle. If repeat is set on the OPTN input, the profile will repeat continuously.	
1	1	With both bits set to one, the RATIO_RL function will execute at the default ratio until the ladder places data in the array of structures and clears bit 0.	

When each segment completes its execution, whatever is in bit 1 is copied into bit 0.

**Note:** Whenever the default ratio is used, set the reversal not allowed flag using variable 21 of the WRITE\_SV function before calling the RATIO\_RL function.

The master starting point is entered in the MSTR input. The profile will begin executing at the beginning with the master and slave axes locked on when the master reaches its starting position.

**Note:** If the ratio real move is queued with no master starting position and the master axis is moving in the opposite direction of that indicated in the profile segments, the direction of the master will have to be reversed and the accumulated distance covered before the move will execute.

**Comparison of some ratio moves**

The table below shows how the RATIO\_RL works compared to the RATIOCAM and RATIOSLP functions. RATIO\_RL relies on the distance calculations. RATIOCAM and RATIOSLP rely on the velocity calculations (indicated by the dark boxes).

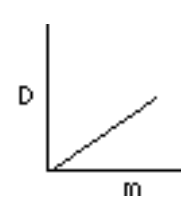
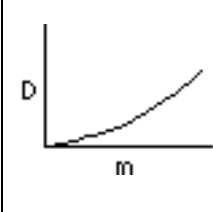
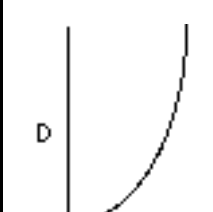
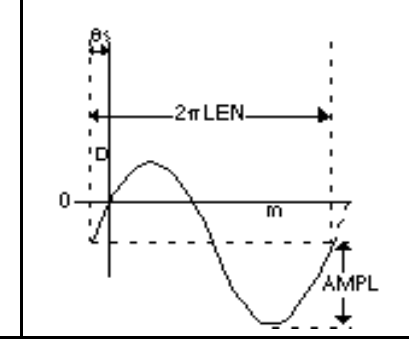
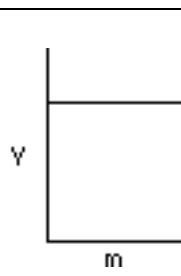
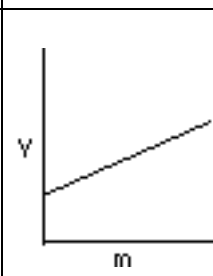
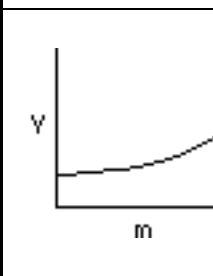
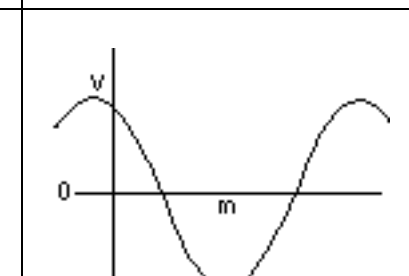
	RATIOCAM	RATIOSLP	RATIO_RL	
			(Polynomial)	(Trig)
<b>How Defined</b>	SSlave distance MMaster distance	SSlave distance MMaster distance $K_1$ Start ratio $K_2$ Slope	SSlave distance MMaster distance $K_1$ M coefficient $K_2 M^2$ coefficient $K_3 M^3$ coefficient	SSlave distance MMaster distance LEN# of master counts in 1 radian AMPL Amplitude $\theta_s$ Starting angle
<b>Distance Polynomial</b>	$D = K_1 m$ $K_1 = \frac{S}{M}$	$D = K_2 m^2 + K_1 m$ $K_1 = \text{start ratio}$ $K_2 = \frac{\text{Slope}}{2}$	$D = K_3 m^3 + K_2 m^2 + K_1 m$	$D = \text{AMPL} \sin\left(\frac{m}{LEN} + \theta_s\right) - \text{AMPL} \sin \theta_s$
<b>Distance Plot</b>				
<b>Velocity Polynomial</b>	$V = K_1$ $K_1 = \frac{S}{M}$	$V = K_2 m + K_1$ $K_1 = \text{Start ratio}$ $K_2 = \text{Slope}$	$V = K_3 m^2 + K_2 m + K_1$ $K_1 = K_1$ of position $K_2 = 2K_2$ of position $K_3 = 3K_3$ of position	$V = \text{AMPL} \cos\left(\frac{m}{LEN} + \theta_s\right)$
<b>Velocity Plot</b>				

**READ**

Read

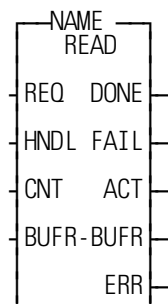
**Io/COMM**

**Inputs:**

- REQ (BOOL) - enables execution (**One-shot**)
- HNDL (INT) - output from OPEN function block
- CNT (INT) - number of bytes to read
- BUFR (MEMORY AREA) - area to read data into  
*MEMORY AREA* is a STRING, ARRAY, STRUCTURE, ARRAY ELEMENT, or STRUCTURE MEMBER

**Outputs:**

- DONE (BOOL) - energized if ERR = 0  
not energized if ERR ≠ 0
- FAIL (BOOL) - energized if ERR ≠ 0  
not energized if ERR = 0
- ACT (INT) - number of bytes read
- BUFR (same variable as BUFR input)
- ERR (INT) - 0 if data transfer successful  
≠ 0 if data transfer unsuccessful

*See Appendix B in the PiCPro Online Help for ERR codes.*

```
<<INSTANCE NAME>>:READ(REQ := <<BOOL>>, HNDL := <<INT>>, CNT
:= <<INT>>, BUFR := <<MEMORY AREA>>, DONE => <<BOOL>>, FAIL
=> <<BOOL>>, ACT => <<INT>>, BUFR => <<MEMORY AREA>>, ERR
=> <<INT>>);
```

The READ function block reads data from the file or device at the User Port specified by the value at HNDL and places it in the variable at BUFR. The number of bytes to read is specified by the variable at CNT. The number of bytes actually read is placed into the variable at ACT. ACT will be less than CNT when there are less bytes in the file than specified by CNT, or when there is an error. Otherwise the value of ACT will equal the value of CNT.

**WARNING**

If the input at BUFR does not have as many bytes as specified by CNT, the "extra" data will overflow into the declared memory area immediately after the memory area at BUFR.

## **READ**

### **IMPORTANT**

See APPLICATION NOTE # 1 in the Application Note section (at end of the PiCPro Online Help) for information about READING from and WRITing to STRINGS.

READ is used in conjunction with the CLOSE, CONFIG, OPEN, SEEK, STATUS, and WRITE I/O function blocks.

---

---

**READFDBK**

Read Feedback

**Io/READFDBK**

---

---

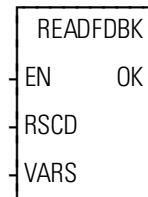

**Inputs:** EN (BOOL) - enables execution  
 RSCD (STRUCT) - a structure to identify rack, slot, channel, and device  
 VARS (STRUCT) - a structure to contain variables required for reading encoders or resolvers in background

**Outputs:** OK (BOOL) - set if no errors in structure data

READFDBK(RSCD := <<MEMORY AREA>>, VARS := <<MEMORY AREA>>, OK => <<BOOL>>)

The READFDBK function allows an encoder or a resolver feedback device to be read on a scan time basis (in background). Using this feature allows you to place encoder and resolver modules in an expansion rack. It can be used with the encoder, 12 channel resolver, block resolver, and block stepper/encoder/DC in modules.

No information needs to be entered in the servo setup program. These are read only feedback devices used in open loop control.

The function performs initialization, update, and reference tasks.

Data is stored and manipulated in two structures you declare in the software declarations table. The members of these structures can be written to or read from in the ladder.

The first structure at the RSCD input identifies the rack, slot, channel, and device (type of encoder). The second structure at the VARS input allows you to read and write variables required for reading encoders in background.

The READFDBK function should be called by the ladder once each scan.

A separate READFDBK function must be used for each axis.

**PROGRAMMING NOTE:** If multiple axes will be read in the background with READFDBK functions, you may want to create an array of structures for the RSCD and the VARS structures. This eliminates the need to enter these structures individually for each axis in the software declarations table.

It is necessary to declare the encoder or resolver module in the hardware declarations table.

Explanations of the two structures required for the READFDBK function follow.

**The RSCD input structure**

The structure that must be used at the RSCD input of the READFDBK function is shown in Figure 2-24. It has four members; RACK, SLOT, CHAN, and DEVICE.

<b>IMPORTANT</b>	
<p>The structure you enter in the software declarations table for the RSCD input must have the members entered in the order shown in Figure 2-24. The data type for each member of the structure must be as shown in the <b>Type</b> column in order for the software to recognize the information.</p> <p>Initial values are entered by you for the rack, slot, channel, and device for the encoder axis at the RACK, SLOT, CHAN, and DEVICE members of the structure.</p>	

**Figure 2-24. The structure at the RSCD input**

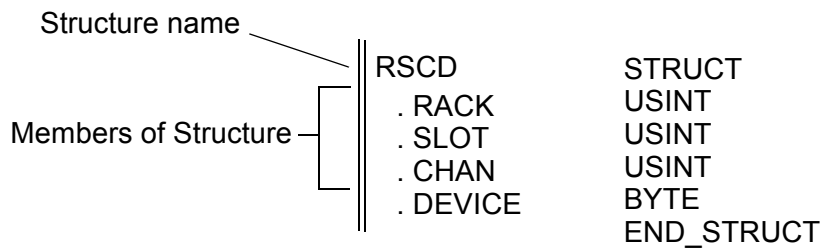



## RSCD structure members

<b>RACK</b> (rack number)	<b>USINT</b> (Write) Range 0 to 8 Range = 100 for block modules	The RACK member specifies the rack the encoder or resolver module resides in. (The master or CPU rack is #0. Expansion racks are numbered 1 - 7 (1 - 8 for some earlier versions of the CPU), where #1 is the rack connected to the master, #2 is the rack connected to #1, etc.)  For a block module, RACK must be set to 100.
<b>SLOT</b> (rack slot number)	<b>USINT</b> (Write) Range 3 to 13  Range 1 to 77 for block modules	The SLOT member specifies the slot in the rack the module resides in. Slots are numbered left to right when facing the controller. Slot 1 and 2 are reserved for the CSM and CPU module respectively.  For a block module, RACK must be set to 100.
<b>CHAN</b> (module channel)	<b>USINT</b> (Write) Range 1 to 4 for encoder Range 1 to 12 for multi-channel resolver  Range 1 to 2 for block st/enc/DC in  Range 1 to 6 for block resolver	The CHAN member specifies the number of the channel on the module.  With an encoder if 3 and 4 are used, a four channel encoder module must reside in the rack.

**DEVICE**  
(type of encoder)

**BYTE (Write)**

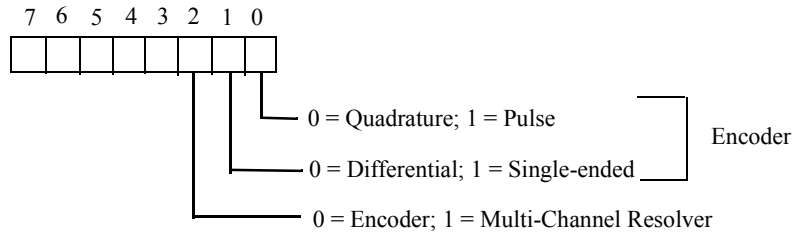

The DEVICE member defines the type of feedback device.

**Encoders**

**Bit 0 defines whether it is quadrature or pulse encoder.**

**Bit 1 defines whether it is differential or single-ended.**

**Resolvers**

Bit 2 defines whether an encoder or a resolver module is being read.

If bit 2 is set to 1, the resolver is being read and bits 0 and 1 are ignored.

If bit 2 is 0, the encoder is being read.

All remaining bits (3 - 7) should be set to zero.

**The VARS input structure**

The structure that must be used at the VARS input of the READFDBK function is shown in Figure 2-25. The members of this structure are; REFER (reference), REFVAL (reference value), ROLPOS (rollover position), STATUS, ERROR, FDBK (feedback), LATCH, POSITN (position), REFSWT (reference switch), ADDRESS, SPARE1 and SPARE2.

<b>IMPORTANT</b>	
<p>The structure you enter in the software declarations table for the VARS input must have the members entered in the order shown in Figure 2-25. The data type for each member of the structure must be as shown in the <b>Type</b> column in order for the software to recognize the information.</p> <p>You write values to REFER, REFVAL, and ROLPOS.</p> <p>The structure you enter in the software declarations table for the VARS input must have the members entered in the order shown in Figure 2-25. The data type for each member of the structure must be as shown in the <b>Type</b> column in order for the software to recognize the information.</p> <p>The software assigns values to STATUS, ERROR, FDBK, LATCH, POSITN, REFSWT, and ADDRESS*. <i>Never enter any values for them.</i></p> <p>*See note for exceptions at the ADDRESS structure member that follows.</p>	

**Figure 2-25. The structure at the VARS input**

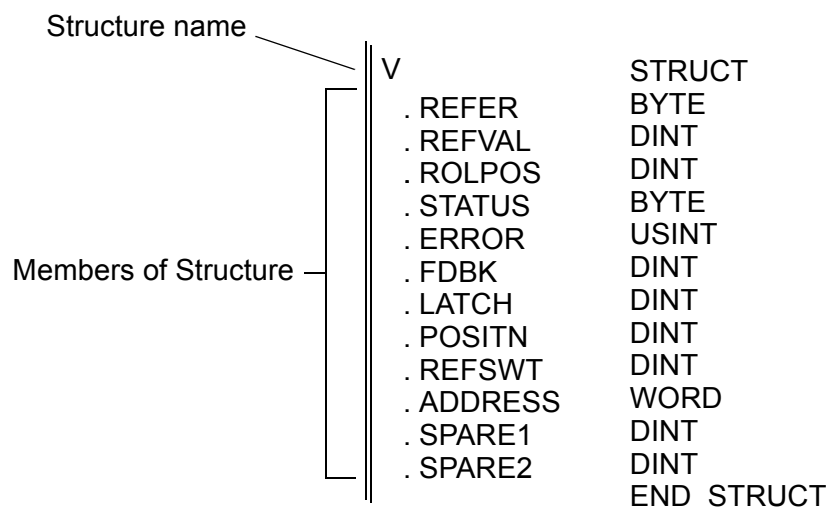

The VARS structure members

<p><b>REFER</b> (reference)</p>	<p><b>BYTE (Write)</b></p>	
<p>The REFER member of the structure allows you to do a reference with the READFDBK function. It requests a reference and defines the type of reference that will occur. (If no reference is required, leave bit 0 set to 0.)</p> <p>With an encoder, it is possible to do a reference based on a fast input to the encoder module or on a ladder event. Either type can be used with or without the index mark.          NOTE: With the fast input, the position is latched in hardware when the fast input transitions.</p> <p>With the block stepper/encoder/DCin module, it is possible to do a reference based on the DCin or on a ladder event. Either type can be used with or without the index mark.          NOTE: With the block DCin, the position is read in software when the DCin transitions.</p> <p>NOTE: The Block I/O 5-Axis Integrated Stepper Module does not support a DC input or latching on an index mark.</p> <p>With a resolver, it is only possible to do a reference based on a ladder event.</p> <p>The chart below summarizes how the reference value entered in the REFVAL member is assigned to the reference position.</p> <p>All remaining bits (4 - 7) should be set to zero.</p>		
<b>Reference</b>	<b>With index</b>	<b>Without index</b>
<p><b>Fast input reference (Encoder only) or DCin reference with the block st/enc/DCin module</b></p>	<p>Assigns the value in REFVAL to the next index mark after the fast in occurred.</p>	<p>Assigns the value in REFVAL to the position where the fast in occurred.</p>
<p><b>Ladder reference (Encoder or resolver)</b></p>	<p>Assigns the value in REFVAL to the next index mark (Enc) or null (Res) after the ladder reference switch turns on (bit 1 of REFER).</p>	<p>Assigns the value in REFVAL to the position where the ladder reference input switch turns on (bit 1 of REFER).</p>

Before bit 0 is set requesting a reference, you must define the type of reference desired with bits 2 and 3. When a positive transition of bit 0 occurs, the reference complete bit in the STATUS member (see below) is cleared. Bit 0 of REFER may be cleared at any time after the transition occurs.

Once the function knows what type of reference will be performed and that a request has been made, it will wait for the reference to be completed.

For a fast input reference, it will wait for the fast in to occur.

For a ladder reference, it will wait for a positive transition on bit 1. Use the reference switch to set this bit in the ladder. Use the BOOL2BYT conversion to set the bits in the REFER member of the VARS structure as shown in Figure 80.

NOTE: Any unconnected input (IN4 - IN7) places a zero in that bit of the byte.

**Figure 2-26. BOOL2BYT conversion for REFER**

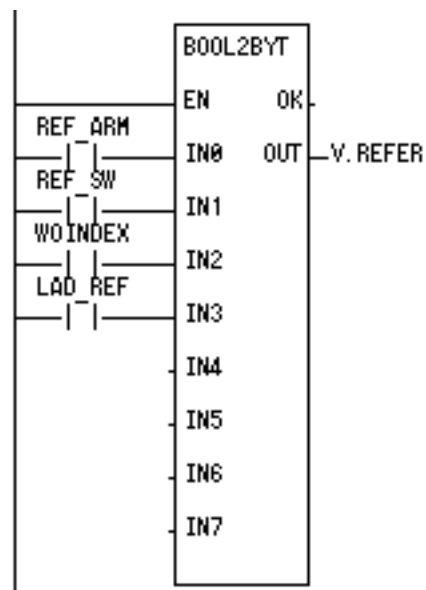

RRJ055.4191

<p><b>REFVAL</b> (reference value)</p>	<p><b>DINT (Write)</b> Range = ±536,870,912 FU</p>	<p>The REFVAL member defines the reference value you want to assign to the reference position. Always be sure the number you enter is within the range given since no limit checking is done by the software.</p>
<p><b>ROLPOS</b> (rollover on position)</p>	<p><b>DINT (Write)</b> Range = ± 536,870,912 FU</p>	<p>The ROLPOS member defines the rollover position you want. Entering a zero means no rollover position is in effect. Always be sure the number you enter is within the range given since no limit checking is done by the software.</p>
<p><b>STATUS</b> (status)</p>	<p><b>BYTE (Read)</b></p>	<div data-bbox="373 798 665 882" data-label="Diagram"> </div> <div data-bbox="665 882 1391 1029" data-label="List-Group"> <ul style="list-style-type: none"> <li>— Set if loss of feedback* (With differential encoder or multichannel resolver)</li> <li>— Set if reference complete</li> <li>— Set for one update after fast input transitions (Enc only; always 0 for Res)**</li> <li>— Set if fast input is on (Enc only; always 0 for Res)***</li> <li>— Internal status bits (not used by the ladder)</li> </ul> </div> <div data-bbox="665 1029 1391 1176" data-label="Footnote"> <p>* See note at ADDRESS structure member.          ** If using the block stepper/encoder/DC in module, this will be set for the index mark of the encoder.          *** If using the block stepper/encoder/DC in module, this will be set for the DC input.</p> </div> <p><b>Note:</b> If the feedback is read from a Block I/O 5-Axis Integrated Stepper Module, STATUS will hold the following information:</p> <div data-bbox="373 1302 665 1386" data-label="Diagram"> </div> <div data-bbox="665 1386 1391 1533" data-label="List-Group"> <ul style="list-style-type: none"> <li>— 24V input status</li> <li>— Reference complete</li> <li>— Drive overcurrent fault</li> <li>— SSI valid double read</li> <li>— reserved</li> </ul> </div> <p>The STATUS member gives the status of the items shown above in bits 0 - 3. The remaining bits are internal and not used by the ladder. Use the BYT2BOOL conversion to check the bits in the STATUS member of the VARS structure.</p>

Figure 2-27. BYT2BOOL conversion for STATUS

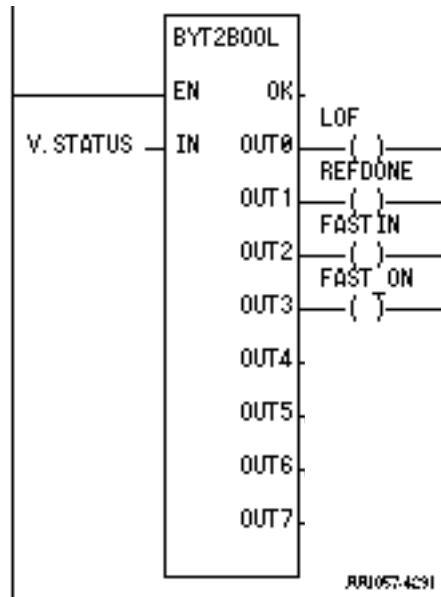

<b>ERROR</b> (error number)	<b>USINT</b> (Read) (0-6)	<p>The ERROR member will contain one of the following values:</p> <ul style="list-style-type: none"> <li>0 No error</li> <li>1 Invalid rack number</li> <li>2 Invalid slot number</li> <li>3 Invalid channel number</li> <li>4 Module not found or not enough channels</li> <li>5 Structure memory written to by something other than this function</li> <li>6 Cannot read from specified rack/slot/channel</li> </ul>
<b>FDBK</b> (actual feedback value)	<b>DINT</b> (Read)	<p>The FDBK member gives the actual feedback value from the module.</p> <p><b>Encoder</b> - A 24 bit value. <b>Resolver</b> - 0 - 3999</p>
<b>LATCH</b> latched value (Encoder only)	<b>DINT</b> (Read)	<p>The LATCH member gives the most recent fast input latched value. It is a 24 bit value.</p> <p>It is always the rising edge of the fast input unless the reference cycle just completed used the fast input and the index. After the reference is complete, the module will once again respond to a rising edge of the fast input.</p> <p>If you are using a block stepper/encoder/DC in module, the latch value is the index position of the encoder.</p>
<b>POSITN</b> (axis position)	<b>DINT</b> (Read)	<p>The POSITN member gives the position of the axis according to the reference, rollover position, and encoder activity since power on. This value will roll over if it exceeds a four byte value in the positive or negative direction.</p>
<b>REFSWT</b> (reference switch)	<b>DINT</b> (Read)	<p>For an encoder, the REFSWT member gives the distance between the reference switch and the index mark.</p> <p>For a resolver, the REFSWT member gives the value at FDBK when the transition of the reference complete bit occurs.</p> <p>NOTE: REFSWT is only valid if the reference complete status bit is set.</p>



<b>ADDRESS</b> (address)	<b>WORD</b> (No action*)	<p>This address must be zero in order for the software to initialize the READFDBK function. After initialization the software assigns an address to it.</p> <p><b>*NOTE:</b> Normally, no action is required on your part. However, if it is ever necessary to reinitialize, you must write a zero to ADDRESS and call the function.</p> <p>Also, if a loss of feedback occurs, you must write a zero to ADDRESS and call the function in order to clear the loss of feedback. It is not cleared when feedback is restored.</p>
<b>SPARE1</b> (reserved)	<b>DINT</b>	
<b>SPARE2</b> (reserved)	<b>DINT</b>	

---



---

## READ\_SV

Read Servo

**Motion/DATA**

---



---

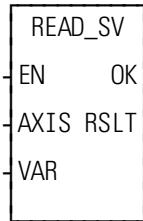

**Inputs:** EN (BOOL) - enables execution  
 AXIS (USINT) = identifies axis (servo, digitizing, or time)  
 VAR (SINT) = variable to be read

**Outputs:** OK (BOOL) - execution completed without error  
 RSLT (DINT) = servo data read

READ\_SV(AXIS := <<USINT>>, VAR := <<SINT>>, OK => <<BOOL>>, RSLT => <<DINT>>)

The read servo function allows the specified variable (VAR) to be read for the specified axis. The results of the read are displayed at RSLT.

The variables that can be read using the function are listed in the table below.

The table also indicates which variables can be written with the WRITE\_SV function and what type of axis apply (servo, digitizing, or time).

The READ\_SVF and WRIT\_SVF functions allow you to read and write the same variables listed below faster. However, the units are feedback units and updates rather than ladder units and minutes. This is noted in the variable description.

**Note:** When using read/write variables with the Stepper Axis Module, the feedback units are stepper units. Ladder units may still be used.

**Variables available for the read/write servo functions**

Key for the variable table below:

**V#** - identifies the variable number you enter in the read and/or write servo functions at VAR.

**R** column - the variable can be used with read servo function.

**W** column - the variable can be used with write servo function (see WRITE\_SV).

An **F (in XX)** in the lower right corner of the Definition Box indicates you can use the read servo **Fast** (READ\_SVF) or write servo **Fast** (WRIT\_SVF) functions with that variable and the units (usually feedback units) used with these functions.

**S = servo axis D = digitizing axis T = time axis**

**Variables Table**

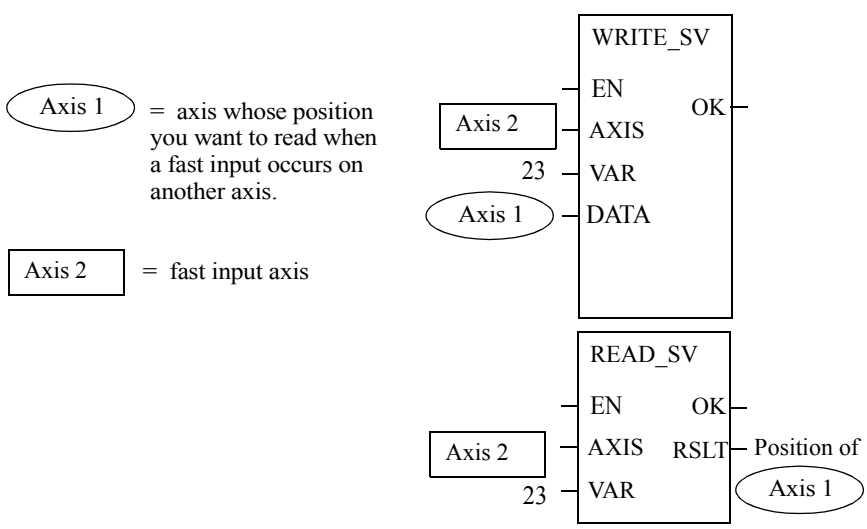
V #	Definition	R	W
<p><b>1</b></p>	<p><b>Actual position</b> - Reads the actual position of the axes in ladder units.</p> <p>With a DLS axis, this will read the actual position if the actual position is broadcast, or the command position if the command position is broadcast.</p> <p>With a time axis, allows you to write the position.</p> <p>(Range for a time axis is +2147483647 to -2147483648 ladder units.)</p> <p>Example:</p>  <p>Axis 1 = axis whose position you want to read when a fast input occurs on another axis.</p> <p>Axis 2 = fast input axis</p> <p><b>F in FU</b></p>	<p>S, D, T</p>	<p>T</p>

V #	Definition (Continued)	R	W
2	<p><b>Move type</b> - The active move type is indicated by a number:</p> <p>11 position move      18 ratiopro            12 distance move     20 ratiosyn or ratiogr            14 velocity start      22 ratiocam            16 fast reference or    23 ratioslp                ladder reference    24 ratioreal</p> <p style="text-align: right;"><b>F</b></p>	S	
3	<p><b>Command position</b> - Reads the commanded position in ladder units.</p> <p style="text-align: right;"><b>F in FU</b></p>	S, D	
4	<p><b>Position error</b> - Represents the position error in ladder units.</p> <p>NOTE: With SERCOS where the actual position error is in the drive, internal calculations approximate the position error and bring the approximation out to variable 4. This approximation may vary by the distance moved in one or two updates from the actual position error read from the drive via the service channel.</p> <p>NOTE: Not available with the stepper axis module.</p> <p style="text-align: right;"><b>F in FU</b></p>	S	
5	<p><b>Slow velocity filter error</b> - Represents the error of the slow velocity filter in ladder units.</p> <p style="text-align: right;"><b>F in FU</b></p>	S	
6	<p><b>Command velocity</b> - Shows the velocity ramping up and down with move in ladder units/minute for servo axes and ladder units/second (counts/second) for time axes. (Range for a time axis is <math>\pm 2,000,000</math> ladder units/sec.)</p> <p>*Do not write a command velocity when running s-curve velocity profiles.</p> <p style="text-align: right;"><b>F in FU/update</b></p>	S, T	T*
7	<p><b>Position change</b> - Reads the distance moved during one interrupt in ladder units/minute for a servo axis and in ladder units/update for a digitizing axis. To read the position change over several interrupts, see variable 34.</p> <p style="text-align: right;"><b>F in FU/update</b></p>	S, D	

V #	Definition (Continued)	R	W
8	<p><b>Feedback last</b> - Reads the latest feedback position directly from the feedback module in feedback units.</p> <p>Ranges for various feedback devices:</p> <p>Encoder/resolverCounts from 0 to 16,777,215 FU and then rolls over. The number returned will count according to the feedback polarity specified in setup.</p> <p>Analog input 0 to 4095 unipolar; -2048 to 2047 bipolar TTL (Depends on number of bits used for position data.)</p> <p>SERCOS -2,147,483,648 to 2,147,483,647</p> <p>Virtual -2,147,483,648 to 2,147,483,647</p> <p style="text-align: right;"><b>F in FU</b></p>	S, D	
9	<p><b>Fast input position (hardware)</b> - Reads the axis position when the fast input occurs in feedback units. The module must have been set up to respond to fast inputs through the FAST_QUE, FAST_REF, REGIST, or MEASURE functions.</p> <p>NOTE: Not available with the stepper axis module.</p> <p style="text-align: right;"><b>F in FU</b></p>	S, D	
10	<p><b>Registration/referencing position change</b> - Reads the distance position changed in ladder units due to registration or the last machine reference. This number can be used to allow the ladder to synchronize axes if a slave axis started before registration ever ran.</p> <p>NOTE: Not available with the stepper axis module.</p> <p style="text-align: right;"><b>F in FU</b></p>	S, D	

V#	Definition (continued)	R	W
11	<p><b>Consecutive bad marks</b> - Reads the number of consecutive bad marks since the last good mark when using registration. You can also write any positive number into variable 11 to set the number of consecutive bad marks. Typically, 0 would be entered to initialize the counter.</p> <p>When a good mark occurs, this number will be reset to 0. If the number of bad marks exceeds 2,147,483,647, the number returned will “roll over” to -2,147,483,648 and start counting toward 0. NOTE: Not available with the stepper axis module.</p> <p style="text-align: right;"><b>F</b></p>	S, D	S, D
12	<p><b>Rollover on position-</b> Reads the rollover position in ladder units. Allows you to write a rollover position which overrides the one entered in setup.</p> <p>The range is 0 to 536,870,911 FU. Entering a 0 turns rollover on position off. Negative values cannot be entered.</p> <p>Note: Without rollover on position when 2,147,483,647 is reached, the next number will be -2,147,483,648. The count continues to zero and back up to 2,147,483,647, etc.</p> <p>Digital Drive Note: If an absolute reference (WRITE_SV Variable 90) was performed prior to changing the rollover position (WRITE_SV Variable 12), the absolute reference will need to be performed again since WRITE_SV Variable 90 also writes the current rollover position to the digital drive. The digital drive then stores the rollover position and uses it to correctly calculate the absolute position on subsequent power cycles.</p> <p style="text-align: right;"><b>F in FU</b></p>	S, D, T	S, D, T

	<p><b>NOTE</b></p> <p>Variables 13 through 16 deal with master/slave offsets. It is important to remember that these offsets affect the master/slave relationship, not the individual axes. The master axis is accessed through the slave axis. Offsets are calculated based on the slave axis ladder units. The number of the slave axis is entered at the AXIS input of the READ_SV and WRITE_SV functions.</p>		
V #	Definition (Continued)	R	W
13	<p><b>Slave offset incremental</b> - Reads the total remaining slave offset in slave ladder units. Writes an incremental slave offset. The total incremental offset entered is applied each time the WRITE_SV function is called. The offset cannot be canceled.*</p> <p style="text-align: right;"><b>F in FU</b></p>	S	S
14	<p><b>Master offset incremental</b> - Reads the total remaining master offset in slave ladder units. Writes an incremental master offset. It is applied each time the WRITE_SV function is called. The offset cannot be canceled.*</p> <p style="text-align: right;"><b>F in FU</b></p>	S	S
15	<p><b>Slave offset absolute</b> - Reads the absolute slave offset in slave ladder units. Writes an absolute slave offset. Each time the WRITE_SV function is called with an absolute offset an offset is applied which is the difference between the last call and this call will be applied. An absolute offset can be canceled by entering an absolute offset of 0.*</p> <p style="text-align: right;"><b>F in FU</b></p>	S	S
16	<p><b>Master offset absolute</b> - Reads the absolute master offset in slave ladder units. Writes an absolute master offset. Each time the WRITE_SV function is called with an absolute offset an offset is applied which is the difference between the last call and this call will be applied. An absolute offset can be canceled by entering an absolute offset of 0.*</p> <p style="text-align: right;"><b>F in FU</b></p>	S	S
	<p>*Variables 13, 14, 15, 16 - Incremental/absolute example</p> <p>If an incremental offset of 100 is requested, and then later another incremental offset of 110 is requested, the total offset applied will be 210.</p> <p>If an absolute offset of 100 is requested, and then later another absolute offset of 110 is requested, the total offset applied will be 110.</p>		

The examples that follow illustrate how offsets are incorporated into moves. Offsets can be entered in the ladder with variables 13 to 16 and offsets are added by the software from calculations done if registration is being used.

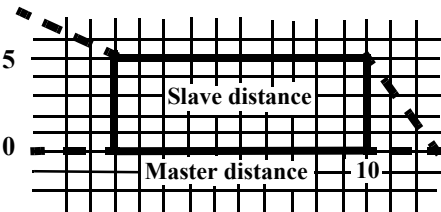
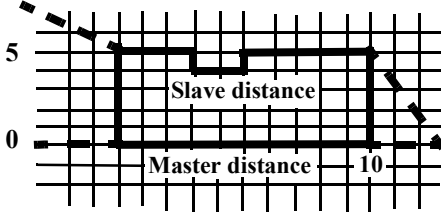
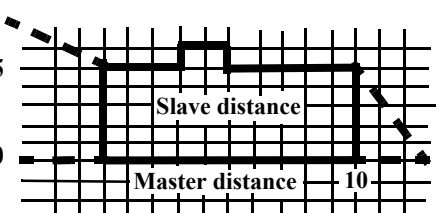
<p><b>1. Master/slave move No offsets</b></p>  <p>The graph shows a coordinate system with a vertical axis from 0 to 5 and a horizontal axis from 0 to 10. A solid horizontal line at y=0 is labeled 'Master distance' with a '10' at its end. A dashed curve starts at (0, 5) and ends at (10, 0). A solid horizontal line at y=5 is labeled 'Slave distance' with a '10' at its end. The area between the solid lines and the dashed curve is shaded.</p>	<p>In the example on the left, the master is traveling 10 units and the slave is traveling 50 units (shown by the area under the curve). No offsets have been entered.</p> <p>NOTE: The examples are showing just one segment of a profile.</p>
<p><b>2. Master/slave move Negative slave offset</b></p>  <p>The graph is similar to the first one, but the solid horizontal line for 'Slave distance' is at y=3. The area between this line and the dashed curve is shaded.</p>	<p>In the example on the left, a slave offset of -2 has been entered. The master travels 10 units and the slave travels 48 units (shown by the area under the curve).</p> <p>NOTE: This also represents what would occur if registration was running on the slave axis and an offset of -2 was calculated by the software. The distance the master travels remains constant and the distance the slave travels varies.*</p>
<p><b>3. Master/slave move Positive slave offset</b></p>  <p>The graph is similar to the first one, but the solid horizontal line for 'Slave distance' is at y=7. The area between this line and the dashed curve is shaded.</p>	<p>In the example on the left, a slave offset of +2 has been entered. The master travels 10 units and the slave travels 52 units (shown by the area under the curve).</p> <p>NOTE: This also represents what would occur if registration was running on the slave axis and an offset of +2 was calculated by the software. The distance the master travels remains constant and the distance the slave travels varies.*</p>

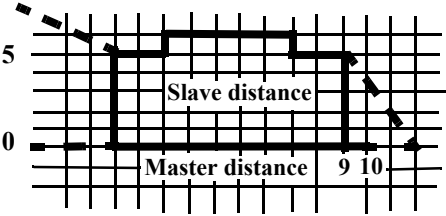
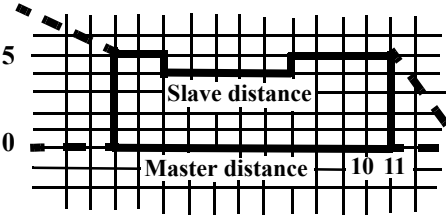

<p><b>4. Master/slave move Negative master offset</b></p> 	<p>In the example on the left, a master offset of -1 has been entered. The master travels 9 units and the slave travels 50 units (shown by the area under the curve).</p> <p>NOTE: This also represents what would occur if registration was running on the master axis and an offset of -1 was calculated by the software. The distance the master travels varies and the distance the slave travels remains constant.*</p>
<p><b>5. Master/slave move Positive master offset</b></p> 	<p>In the example on the left, a master offset of +1 has been entered. The master travels 11 units and the slave travels 50 units (shown by the area under the curve).</p> <p>NOTE: This also represents what would occur if registration was running on the master axis and an offset of +1 was calculated by the software. The distance the master travels varies and the distance the slave travels remains constant.*</p> <p>*When using registration on either the master or slave axis, it is always the slave axis that makes the physical adjustment when an offset is calculated.</p>

V #	Definition (continued)	R	W
17	<p><b>Slave offset filter</b> - Allows you to write a rate in the range of +1 to +101 or -1 to -10001 as shown below. This range represents the percentage the velocity will increase or decrease to apply the offset. At +101 or -10001, the offset is applied as a step function which in effect is no filter. This is the default if nothing is entered in WRITE_SV variable 17.</p>	F	S
18	<p><b>Master offset filter</b> - Allows you to write a rate in the range of +1 to +101 or -1 to -10001 as shown below. This range represents the percentage the velocity will increase or decrease to apply the offset. At +101 or -10001, the offset is applied as a step function which in effect is no filter. This is the default if nothing is entered in WRITE_SV variable 18.</p>	F	S

See the figure below for more information on master/slave offset filters.

**Figure 2-28.**  
Range of values for Slave/Master offset filter

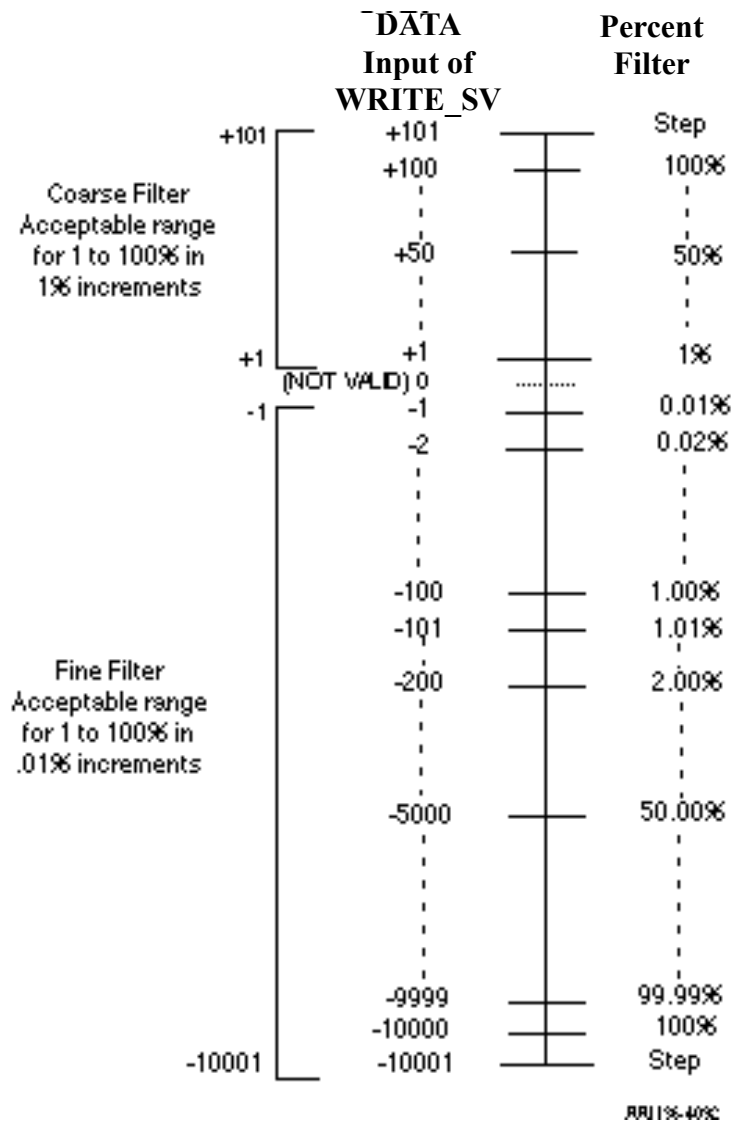

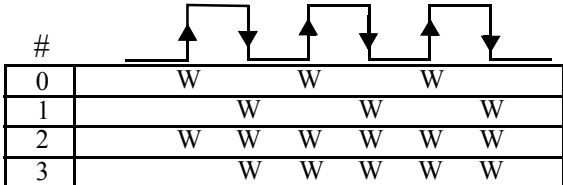
V #	Definition (Continued)	R	W																				
19	<p><b>Fast input direction</b> - By entering one of the following numbers, the fast input will be written (W) as shown in the chart below.</p> <p>0 - only on a low to high (rising) transition (default)</p> <p>1 - only on a high to low (falling) transition</p> <p>2 - alternating rising and falling beginning with a low to high transition</p> <p>3 - alternating falling and rising beginning with a high to low transition</p> <div style="text-align: center;">  <p>The diagram shows a signal line with three transitions: a rising edge, a falling edge, and another rising edge. Above the signal, arrows indicate the direction of each transition. Below the signal, a table shows the 'W' (write) events for each setting:</p> <table border="1" data-bbox="472 751 1031 871"> <thead> <tr> <th>#</th> <th>Transition 1 (Low to High)</th> <th>Transition 2 (High to Low)</th> <th>Transition 3 (Low to High)</th> </tr> </thead> <tbody> <tr> <td>0</td> <td>W</td> <td>W</td> <td>W</td> </tr> <tr> <td>1</td> <td></td> <td>W</td> <td>W</td> </tr> <tr> <td>2</td> <td>W</td> <td>W</td> <td>W</td> </tr> <tr> <td>3</td> <td></td> <td>W</td> <td>W</td> </tr> </tbody> </table> </div> <p>NOTE: Not available with the stepper axis module.</p> <p style="text-align: right;"><b>F</b></p>	#	Transition 1 (Low to High)	Transition 2 (High to Low)	Transition 3 (Low to High)	0	W	W	W	1		W	W	2	W	W	W	3		W	W		S, D
#	Transition 1 (Low to High)	Transition 2 (High to Low)	Transition 3 (Low to High)																				
0	W	W	W																				
1		W	W																				
2	W	W	W																				
3		W	W																				
20	<p><b>Fast input distance</b> - Reads the distance in ladder units between the most recent fast input and the previous fast input. This allows the ladder to measure the distance between two fast inputs.</p> <p>When this variable is used with the MEASURE or REGISTRATION functions, the function must be called first and then the variable read.</p> <p>This distance can be one of four distances depending on how the direction was defined in variable 19. This is illustrated in the examples that follow.</p> <p>See also the STATUSSV function.</p> <p>NOTE: Not available with the stepper axis module.</p> <p style="text-align: right;"><b>F in FU</b></p>	S, D																					

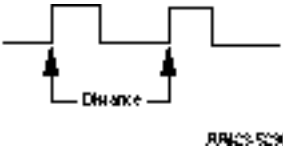
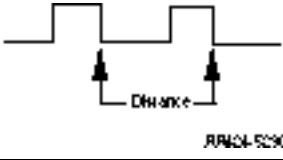
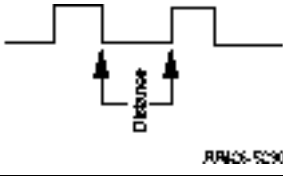
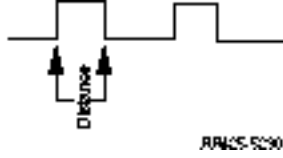
<p>If WRITE_S V variable 19 is:</p> <p>0 (rising)</p>	<p>Then Statussv's fast input rising bit is:</p> <p>1</p>	<p>And READ_SV variable 20 will give the distance between rising edges:</p> 
<p>If WRITE_S V variable 19 is:</p> <p>1 (falling)</p>	<p>Then Statussv's fast input rising bit is:</p> <p>0</p>	<p>And READ_SV variable 20 will give the distance between falling edges:</p> 
<p>If WRITE_S V variable 19 is:</p> <p>2 (both)*</p>	<p>And Statussv's fast input rising bit is:</p> <p>1</p>	<p>Then READ_SV variable 20 will give the distance from falling edge to rising edge:</p> 
<p>If WRITE_S V variable 19 is:</p> <p>2 (both)*</p>	<p>And Statussv's fast input rising bit is:</p> <p>0</p>	<p>Then READ_SV variable 20 will give the distance from rising edge to falling edge:</p> 

\*Note that when variable 19 is set to 2, the STATUSSV bit indicates which distance is in variable 20.

V #	Definition (Continued)	R	W
21	<p><b>Reversal not allowed</b> - Allows the feature of the slave following the master when the master reverses direction to be turned on or off for the ratio_gr and ratiosyn functions. (NOTE: The ratiopro function has an input for this feature.)</p> <p>A “0” (the default) allows the slave to follow the master in the reverse direction. A “1” does not allow the slave to follow the master in the reverse direction.</p> <p>Write_sv must always be called <i>before</i> the move function. The state of reversal cannot be changed after the move has started.</p> <p>An overflow Estop error will occur if the reversed distance exceeds 536,870,912 units in either the plus or minus direction.</p> <p style="text-align: right;"><b>F</b></p>	S	S
22	<p><b>Fast input position (software)</b> - Reads the actual software position of the axis in ladder units. This position value is determined by things like the reference value and rollover on position.</p> <p>The module must have been set up to respond to fast inputs through the FAST_QUE, FAST_REF, REGIST, or MEASURE functions.</p> <p>NOTE: This differs from the variable 9 fast input position which is the hardware latch position.</p> <p style="text-align: right;"><b>F in FU</b></p>	S, D	
23	<p><b>Position (software) of axis 1 with fast input on axis 2</b> - Reads the position in feedback units of axis 1 when a fast input occurs on axis 2.</p> <p>Both the WRITE_SV and READ_SV functions are required to use this variable.</p> <p>The module must have been set up to respond to fast inputs through the FAST_QUE, FAST_REF, REGIST, or MEASURE functions.</p> <p>Enter the number of the fast input axis (servo or digitizing axis) at the AXIS input of both functions.</p> <p>Enter the number of the axis (servo, digitizing, or time axis) whose position you want to read in the DATA input of the WRITE_SV function. The position is read at the RSLT output of the READ_SV function.</p> <p>The position of a servo, digitizing, or time axis can be read.</p> <p style="text-align: right;"><b>F in FU</b></p>	S, D, T	S, D

V #	Definition (Continued)	R	W
24	<p><b>Registration switch</b> - Allows you to turn registration on or off for the master or slave axis (bit 0, 1). Allows you to choose whether or not the registration calculations will change the axis position (bit 2).</p> <p>Set bit 0 to turn off registration compensation for the slave axis. Set bit 1 to turn off registration compensation for the master axis. note (bit 0,1)</p> <p>Bit 0 and bit 1 of variable 24 deal with master/slave compensation due to registration. It is important to remember that this compensation affects the master/slave relationship, not the individual axes. The master axis is accessed through the slave axis. The number of the slave axis is entered at the AXIS input of the READ_SV and WRITE_SV functions.</p> <p>Set bit 2 so that the registration calculations do not change the axis position.</p> <p>NOTE: This bit can be used with a servo axis or a digitizing only axis. When used with a digitizing only axis, bit 0 and bit 1 must be set to zero.</p> <p>Variable 10 can be read to see how much change there would have been if bit 2 was not set.</p> <p>Writing a zero to variable 24 returns the registration calculations to normal.</p> <p>Reads the registration flags.</p> <p>NOTE: Not available with the stepper axis module.</p> <p style="text-align: right;"><b>F in FU</b></p>	S, D	S, D

V #	Definition (Continued)	R	W
25	<p><b>Fast queuing</b> - Entering a one turns fast queuing on. A move start, abort move, or a fast queue event will now start within one interrupt. When it is set to zero, these activities can take up to eight interrupts to begin. Fast queuing makes your axis more responsive, but there is a trade-off in that the execution time is increased.</p> <p>When one or more axis is slaved to a master axis that is starting and stopping using distance moves (normally with the SCURVE function), you must also set Fast queuing for each slave axis. This ensures that the slave distances will be reached before the master axis stops.</p> <p>When doing a synchronized slave start, see the note at variable 26.</p> <p style="text-align: right;"><b>F in FU</b></p>	S	S
26	<p><b>Synchronized slave start</b> - Allows you to tell a master axis which of its slave axes must be queued up before any of them begin their move. Each slave axis you want to synchronize is identified by setting a bit in a DINT using the lower 16 bits where the LSB = axis 1 and the MSB = axis 16. When the last “set” axis has been queued, all the slave axes will begin their move on the next interrupt.</p> <p>WRITE_SV must be called before the move. It can be called again when you want to identify a different set of synchronized slave axes. Change the bits only after the slave axes identified in the first WRITE_SV have started to move.</p> <p>Writing a zero to variable 26 clears all identified axes.</p> <p>READ_SV returns the bits of the slave axes being synchronized, in the low word of RSLT.</p> <p>NOTE: Always use fast queuing (variable 25) with this variable. This ensures that the slave axes will be checking for the synchronized slave start flag <i>every</i> interrupt, not just on the <i>next</i> interrupt. Remember that the synchronized slave start variable 26 is set on the master axis and fast queuing variable 25 is set on each slave axis.</p> <p style="text-align: right;"><b>F</b></p>	S, D, T	S, D, T

V #	Definition (Continued)	R	W
27	<p><b>Backlash compensation</b> - Writes a backlash compensation value. Enter the value in ladder units. The amount is added or subtracted from the command whenever the commanded direction is reversed. The value written should equal the amount of mechanical backlash in the gears between the servo motor and the desired motion.</p> <p>NOTE: Because the backlash value is added or subtracted after the commanded position is calculated, the distance moved will not be reflected in variable 3 (commanded position). It will, however, be reflected in variable 1 (actual position).</p> <p>It is also important at power on to ensure that the PiC will compensate for backlash correctly. The PiC assumes that the most recent move is in the positive direction. Program a positive move to “wind up” the backlash in a positive direction before writing to variable 27. Once the initial positive direction has been established, the PiC will compensate for backlash as described above whenever the commanded value changes direction.</p> <p>READ_SV reads the backlash compensation value in ladder units. (0 - 327 feedback units) default = 0</p> <p>NOTE: Not available with a stepper axis or a SERCOS axis.</p> <p style="text-align: right;"><b>F in FU</b></p>	S	S
28	<p><b>TTL feedback</b> - Reads the position of the feedback axis by returning the state of 24 TTL inputs to the DINT at the RSLT output of READ_SV. The 24 inputs are the low 24 bits.</p> <p>Depending on the hardware, the 24th TTL input can be used as an indicator of valid data. When it is used to indicate valid data, then you must monitor a waiting flag at the MSB of the DINT at RSLT.</p> <p>The waiting flag will be high until the hardware sends valid data to the TTL inputs. Do not attempt to close the loop while the waiting flag is high. The OK on the CLOSLOOP function will not be set if the waiting flag is high. When valid data is received, the waiting flag goes low and you can then successfully close the loop.</p> <p>You can write to the eight TTL outputs using the eight LSBs of the DINT at the DATA input on the WRITE_SV function.</p> <p>NOTE: Not available with the stepper axis or a SERCOS axis.</p> <p style="text-align: right;"><b>F</b></p>	S, D	S, D



V #	Definition (Continued)	R	W
29	<p><b>Reference switch position</b> - With encoder feedback, the position here represents the distance between the reference switch and the index mark in feedback units.</p> <p>With resolver feedback, the position here represents the absolute position of switch closure in feedback units.</p> <p>With analog input or TTL feedback, the position here represents the absolute position when referencing occurred.</p> <p><b>Note:</b> The number returned in variable 29 always counts in the same direction regardless of the feedback polarity specified in setup.</p> <p>This measurement could be in error up to the distance traveled in eight updates. You can reduce that error to no more than the distance traveled in one update by setting variable 25 <i>Fast Queuing</i> using the WRIT_SV function.</p> <p><b>Note:</b> Not available with the stepper axis module.</p> <p style="text-align: right;"><b>F in FU</b></p>	S, D	

The next four variables (30 - 33) allow you to put a master delta filter on a slave axis. Variations in the master delta can cause undesirable “jitter” in the slave axis. Applying a master delta filter can correct this problem.

<p><b>30</b></p>	<p><b>Filter time constant</b> - Defines a first order filter on the master axis as viewed by each slave axis defined. In some applications it is necessary to filter the master delta to control variations that can occur in master axis travel. There are 10 approximate filter values:</p> <table style="margin-left: auto; margin-right: auto;"> <tr> <td>2</td> <td>64</td> </tr> <tr> <td>4</td> <td>128</td> </tr> <tr> <td>8</td> <td>256</td> </tr> <tr> <td>16</td> <td>512</td> </tr> <tr> <td>32</td> <td>1024</td> </tr> </table> <p>The time constant has a fine resolution at low values and a coarse resolution at high values.</p> <p>Identify the slave axis at the AXIS input of READ_SV or WRITE_SV.</p> <p>Related master filter variables: 31, 32, 33 (0 - 1023, 0 disables filter)</p> <p style="text-align: right;"><b>F</b></p>	2	64	4	128	8	256	16	512	32	1024	<p>S</p>	<p>S</p>
2	64												
4	128												
8	256												
16	512												
32	1024												
<p><b>31</b></p>	<p><b>Filter error limit</b> - Limits the amount of lag introduced by the filter. When this limit is reached, the filter will no longer be in effect. This allows you to implement a large filter at low velocities when resolution problems are more pronounced and still limit the following error effects at high velocities when filtering is not required. A positive number is entered using WRITE_SV. It applies to both positive and negative errors.</p> <p>Identify the slave axis at the AXIS input of READ_SV or WRITE_SV.</p> <p>Related master filter variables: 30, 32, 33 (1 to 2147483647 feedback units)</p> <p style="text-align: right;"><b>F in FU</b></p>	<p>S</p>	<p>S</p>										

V #	Definition (Continued)	R	W
32	<p><b>Velocity compensation flag</b> - Entering a one turns the default velocity compensation feature off. Turning it off will result in the slave axis lagging the master axes by the amount traveled by the master axis in one interrupt (or multiple interrupts for SERCOS and digital drive axes). Velocity compensation should be turned off when using Command Based Master/Slave functionality (i.e. Variable 59 = 1). Velocity compensation works independent of the filter. Identify the slave axis at the AXIS input of READ_SV or WRITE_SV.                      Related master filter variables: 30, 31, 33                      (0, 1)</p>	S	S
	<b>F</b>		
33	<p><b>Filter lag</b> - Reads the filter following error.                      Identify the slave axis at the AXIS input of READ_SV.                      Related master filter variables: 30, 31, 32                      (-2147483648 to +2147483647 feedback units)</p>	S	
	<b>F in FU</b>		

<b>NOTES ON FILTER LAG</b>
<p>Normally, the filter time constant and error limit will be established prior to the move call. If they are changed after the slave axis is locked to the master axis, keep the following in mind:</p> <ul style="list-style-type: none"> <li>• If the filter lag is already at the filter error limit and the error is increased, the new limit will be reached at the rate defined by the filter and master axis velocity.</li> <li>• If the filter lag is already at the filter error limit and the error is decreased, the excess will be dumped into the slave axis command in one update.</li> <li>• If the filter lag is already at the filter error limit, changing the time constant will have no effect.</li> <li>• If the filter time constant is set to zero, any lag will remain.</li> </ul>

V #	Definition (Continued)	R	W
34	<p><b>Position change over several interrupts</b> - Variable 7 reads the change in position in a single interrupt. However, it can be difficult to get an accurate reading in one interrupt especially if an axis is moving slowly. Variable 34 allows the change in position to be read over several interrupts.</p> <p>Write at the DATA input of WRITE_SV the number of interrupts (0 to 255) over which the change in position will be summed. Writing a zero to the DATA input turns the feature off.</p> <p>Read with READ_SV the distance moved over several interrupts in ladder units for a servo or digitizing axis. The value is not necessarily changed every interrupt. It changes only after the number of interrupts designated with WRITE_SV have occurred since the last value was read. NOTE: A non-zero value must be written with WRITE_SV before you call READ_SV or the READ_SV OK will not be set.</p> <p>An overflow can occur if the axis is moving fast and the number of interrupts selected is large. If an overflow occurs, the OK of READ_SV will not be set. Write to variable 34 to clear an overflow error condition.</p> <p style="text-align: right;"><b>F in FU</b></p>	S, D	S, D
35	<p><b>Part reference offset</b> - Reads the part reference offset in ladder units. The offset represents the distance that would have to be subtracted from the current position to remove the part reference.</p> <p style="text-align: right;"><b>F in FU</b></p>	S, D	
36	<p><b>Software upper limit</b>- read or write in ladder units the upper end-limit for a servo axis. Exceeding the endlimit will generate a C-stop.</p> <p>The range is -536870912 to 536870911 FU.</p> <p style="text-align: right;"><b>F in FU</b></p>	S	S

V #	Definition (Continued)	R	W
37	<p><b>Software lower limit</b> - read or write in ladder units the lower end-limit for a servo axis. Exceeding the endlimit will generate a C-stop.</p> <p>The range is -536870912 to 536870911 FU.</p> <p style="text-align: right;"><b>F in FU</b></p>	S	S
38	<p><b>Commanded position</b> (before slow velocity filter) - reads the commanded position before the slow velocity filter is applied to a servo axis. If slow velocity filter is not in effect, it returns the same commanded position as variable 3 returns.</p> <p style="text-align: right;"><b>F in FU</b></p>	S, D	
39	<p><b>Following error limit</b> - read or write in ladder units the following error limit for a servo axis. This overrides the following error limit entered in servo setup.</p> <p>The range is -536870912 to 536870911 FU.</p> <p style="text-align: right;"><b>F in FU</b></p>	S	S
40	<p><b>In-position band</b> - read or write in ladder units the in-position for a servo axis. This overrides the in-position band entered in servo setup.</p> <p>The range is -536870912 to 536870911 FU.</p> <p style="text-align: right;"><b>F in FU</b></p>	S	S
<p><b>Variables 41, 42, and 43 work with the RATIOCAM, RATIOSLP, and RATIO_RL functions. They do not work with the RATIOPRO function.</b></p>			
41	<p><b>Current segment number</b> - returns the segment number from the ratio move currently being executed. The first segment is number 1. This matches the array element number in the profile. If one of the three above moves is not being executed, the OK of READ_SV will be clear.</p> <p style="text-align: right;"><b>F</b></p>	S	
42	<p><b>Slave distance into segment</b> - returns the distance the slave axis is into the segment identified in variable 41. If one of the three above moves is not being executed, the OK of READ_SV will be clear. The units are feedback units.</p> <p style="text-align: right;"><b>F in FU</b></p>	S	
43	<p><b>Master distance into segment</b> - returns the distance the master axis is into the segment identified in variable 41. If one of the three above moves is not being executed, the OK of READ_SV will be clear. The units are in feedback units.</p> <p style="text-align: right;"><b>F in FU</b></p>	S	

**Background Information on Servo Control Variables 44 through 48**

Variables 44, 45, 46, 47, and 48 are used to control the servo software. In normal operation, the *servo iteration command* is determined by the move type (DISTANCE, VEL\_STRT, RATIOCAM, etc.) The command is compared to the feedback and the difference is fed to the internal PID calculations. The result is the *servo PID command* which is written to the D/A.

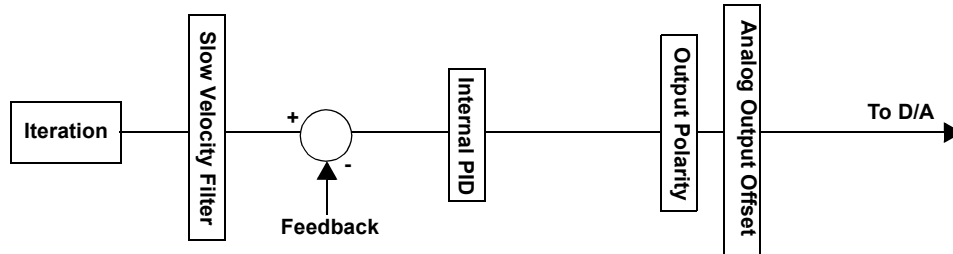

These variables allow you to interrupt this normal servo operation at various points as illustrated by the diagram below. They perform the following:

- Read the result of the *servo iteration command* and write a *user iteration command* before the next internal PID calculation (44 and 45).
- Read the result of the *servo PID command* and write a *user PID command* (46 and 47).
- Disable the servo software (48) and allow the D/A command to come from the ANLG\_OUT function.
- CAUTION: Fault conditions are ignored when the servo software is disabled.

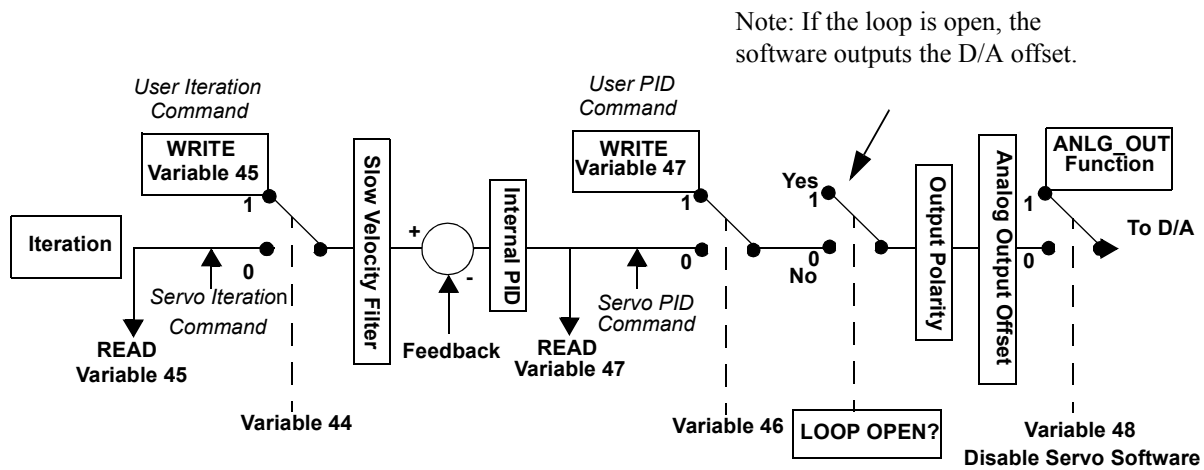

Typically, these variables will be used within user servo tasks (refer to the PiCPro Online Help).

In certain cases when using these variables, it may be helpful to know the sequence in which execution occurs.

On every interrupt, the following occurs in the order given:

**1. The PID code is executed.**

If variable 44 = 0 read *servo iteration command* (the data servo iteration code writes)

Else (variable 44 = 1) read *user iteration command* (the data variable 45 writes)

Compare to feedback

Perform internal PID calculations

Store result into *servo PID command* (the data variable 47 reads)

If variable 46 = 0 read *servo PID command* (the data PID calculations write)

Else (variable 46 = 1) read *user PID command* (the data variable 47 writes)

Apply output polarity and analog output offset

If variable 48 = 0, then write value to D/A register

**2. The iteration code is executed.**

Calculate iteration from move type, store in *servo iteration command*

**3. The user servo TASK code is executed.**

Read variable 45 ( Read *servo iteration command* )

Write variable 45 ( Write *user iteration command* )

Read variable 47 ( Read *servo PID command* )

Write variable 47 ( Write *user PID command* )

V #	Definition (Continued)	R	W
44	<p><b>Set user iteration command</b> -when set to one, allows you to use the <i>user iteration command</i> before the slow velocity filter. The <i>user iteration command</i> is written with variable 45. A valid value should be written to variable 45 before variable 44 is set to one.</p> <p>0 = use <i>servo iteration command</i> (default)                      1 = use <i>user iteration command</i> before PID calculations</p> <p><b>Note:</b> When this variable is 1, Superimposed Moves (Variable 66) will not be applied.</p> <p style="text-align: right;"><b>F</b></p>	S	S
45	<p><b>User iteration command</b> - allows you to read the result of the <i>servo iteration command</i> and write the <i>user iteration command</i> to the input of the next PIC calculations when variable 44 is set to one. The value read or written is the distance to travel per one update.</p> <p>To zero the command, a zero must be written with variable 45. Otherwise, the most recent write value will be in effect.</p> <p>The range is -67108864 to 67108863 FU/update</p> <p><b>Note:</b> Reading this variable while a Superimposed Move (Variable 66) is being applied will not result in returning the combined iteration command for this axis and it's assigned Superimposed Move axis. It will return only the iteration command for this axis's move.</p> <p style="text-align: right;"><b>F in FU/update</b></p>	S	S
46	<p><b>Set user PID command</b> - when set to one, allows you to use the <i>user PID command</i> after the PID calculation and before the D/A command. You can then write a <i>user PID command</i> with variable 47. A valid PID command should be written to variable 47 before variable 46 is set to one.</p> <p>0 = use <i>servo PID command</i> (default)                      1 = use <i>user PID command</i></p> <p>NOTE: Not available with a stepper axis or a SERCOS axis.</p> <p style="text-align: right;"><b>F</b></p>	S	S



<p>47</p>	<p><b>User PID command</b> - allows you to read the output of the <i>servo PID command</i> that is to be sent to the D/A and write a <i>user PID command</i> when variable 46 is set to one.</p> <p>To zero the PID command, a zero must be written to variable 47. Otherwise, the most recent write value will be in effect.</p> <p>Units are D/A bits where one bit is .33mV.</p> <p>The range is -32768 to 32767 D/A bits.</p> <p>NOTE: Not available with a stepper axis or a SERCOS axis.</p> <p style="text-align: right;"><b>F in D/A bits</b></p>	<p>S</p>	<p>S</p>
<p>48</p>	<p><b>Disable servo software</b>- when set to one, the ANLG_OUT function can be used to control the D/A command or, with a SERCOS system, the SCS_CTRL and the SCA_WCYC functions can be used to control the axis instead of the servo software.</p> <p>The most recent value from the servo software, from the ANLG_OUT function, or the most recent position value from the SCA_WCYC function, remains in effect regardless of any E-stop or other fault conditions.</p> <p>0 = use servo software (default)</p> <p>1 = disable servo software {use ANLG_OUT} [use ANLG_OUT function or D/A command; for SERCOS, use the SCS_CTRL function (to set the control bits) and the SCA_WCYC function (to write the position) or the battery box (to control velocity) of the axis.</p>	<p>S</p>	<p>S</p>
<p>49</p>	<p>Reserved</p>		
<p>50</p>	<p><b>Override endlimit check</b> - allows you to disable endlimit checking whether referencing has occurred or not.</p> <p>0 = enable endlimit check</p> <p>1 = disable endlimit check</p> <p>Note: If the Servo Setup “Ignore Limits” selection was “Yes,” variable 50 will be 1. If the selection was “No” or “Until Referenced”, variable 50 will be 0.</p> <p>Note: If the Servo Setup “Ignore limits?” selection was “Yes” and the ladder writes 0 to variable 50 via WRITE_SV, the end limit check will default to “Ignore Limits Until Referenced”.</p> <p style="text-align: right;"><b>F</b></p>	<p>S</p>	<p>S</p>

The table below summarizes the programming features that affect whether or not endlimits are checked.

Variable 50	Servo Setup Ignore limits?	Reference Occurred?	Status of Check Limits
0	Until Referenced	No	No Check
0	Until Referenced	Yes	Check
0	No	Don't Care	Check
0	Yes	No	No Check
0	Yes	Yes	Check
1	Don't Care	Don't Care	No Check

V#	Definition (Continued)	R	W										
51	<p><b>SERCOS command position</b> - reads the SERCOS position. The value is in feedback units.</p> <p style="text-align: right;"><b>F</b></p>	S											
55	<p><b>Queued move type</b> - The queued move type is indicated by a number:</p> <table style="width: 100%; border: none;"> <tr> <td style="width: 50%;">11 position move</td> <td style="width: 50%;">18 ratiopro</td> </tr> <tr> <td>12 distance move</td> <td>20 ratiosyn or ratiogr</td> </tr> <tr> <td>14 velocity start</td> <td>22 ratiocam</td> </tr> <tr> <td>16 fast reference or ladder reference</td> <td>23 ratioslp</td> </tr> <tr> <td></td> <td>24 ratioreal</td> </tr> </table> <p style="text-align: right;"><b>F</b></p>	11 position move	18 ratiopro	12 distance move	20 ratiosyn or ratiogr	14 velocity start	22 ratiocam	16 fast reference or ladder reference	23 ratioslp		24 ratioreal	S	
11 position move	18 ratiopro												
12 distance move	20 ratiosyn or ratiogr												
14 velocity start	22 ratiocam												
16 fast reference or ladder reference	23 ratioslp												
	24 ratioreal												

<p><b>58</b></p>	<p><b>SERCOS Modulo Value</b> - tells the control what the SERCOS drive's modulo value is for its SERCOS digitizing axis. Writing to this variable will not change the modulo value in the SERCOS drive. This only tells the control what modulo value the SERCOS drive is using so the control can account for the rollover in the feedback value it's reading from the drive.</p> <p>The rule for using this variable is:</p> <p>If the axis is a SERCOS digitizing axis  AND  Bit 7 (modulo format) of IDN 76 (position data scaling type) is set-  AND  IDN 103 (modulo value) is non-zero  THEN  Write the modulo value to variable 58 via  WRITE_SV</p> <p>Writing a value of zero to this variable tells the control that modulo format is not being used in the SERCOS drive. Writing variable 58 is only required for a SERCOS digitizing axis. The modulo flag and value for a SERCOS servo axis are read from the drive when the SCA_CLOS function block is executed.</p> <p>Reading this variable with READ_SV will not read the modulo value from the drive. It will only read what is currently stored in variable 58.</p> <p style="text-align: right;"><b>F</b></p>	<p>S, D</p>	<p>S, D</p>
<p><b>59</b></p>	<p><b>Command Position Based Master/Slave</b> - Indicates and specifies if RATIO_GR, RATIOSYN, and RATIOPRO will base their slave axis motion on the master axis' actual position or command position. The slave axis number is entered at the AXIS input. When writing this variable, the WRITE_SV function must be executed prior to the execution of the RATIO_GR, RATIOSYN, or RATIOPRO function. Velocity compensation should be inhibited (Variable 32 = 1) when using this feature.</p> <p>0 = Use master's actual position (default)  1 = Use master's command position</p> <p>Note: This variable must be 0 if the master axis is a time or digitizing axis, otherwise a "Master axis is not available" P-error will occur when the RATIO move is attempted.</p> <p style="text-align: right;"><b>F</b></p>	<p>S</p>	<p>S</p>

<p>60</p>	<p><b>Servo Axis S-Curve interpolation</b> - indicates/selects whether S-Curve Interpolation or Linear Ramp Interpolation will be used when the axis is accelerating and decelerating. Writing this variable is only allowed if the axis' "Enable S-Curve checkbox is checked in Servo Setup.</p> <p>0 = the current acceleration ramp and deceleration ramp will be used to accelerate and decelerate the axis</p> <p>1 = the current S-Curve will be used to accelerate and decelerate the axis</p> <p style="text-align: right;"><b>F</b></p>	<p>S</p>	<p>S</p>
<p>61</p>	<p><b>Multiple Interrupt Velocity Compensation</b> – selects whether multiple interrupt velocity compensation or normal velocity compensation will be used for master/slave moves. The slave axis number should be specified at the AXIS input.</p> <p>Valid Range = [0,1]</p> <p>0 = Use normal single-interrupt velocity compensation (default) 1 = Use multiple-interrupt velocity compensation (default for digital drive axes)</p> <p>Normal velocity compensation compensates for the inherent one-interrupt position lag that occurs between master and slave axes when the master's actual position is used to command the slave axis. With SERCOS and digital drive axes, there is a multiple-interrupt lag that occurs.</p> <p>With SERCOS axes, the "Position Error Cyclic Update Offset" specified in Servo Setup is used to determine the correct number of interrupts. The offset that provides the correct position error in the control will also be the offset that provides the correct amount of velocity compensation.</p> <p>With digital drive axes, the correct number of interrupts is 3. These defaults are established when STRTSERV or DSTRTSRV executes.</p> <p>Due to the larger amount of velocity compensation, SERCOS and digital drive axes will default to using a velocity compensation filter to avoid an overly sensitive slave axis. This will cause some lag to occur between the master and slave positions during master acceleration and deceleration. This filter can be adjusted or eliminated with Variable 62. See Variable 62 for a description of the velocity compensation filter.</p> <p>If Variable 32 Velocity Compensation Flag = 1, all velocity compensation will be inhibited regardless of the state of variable 61.</p> <p style="text-align: right;"><b>F</b></p>	<p>S</p>	<p>S</p>

62	<p><b>Velocity Compensation Filter</b> – specifies the number of servo interrupts in which a given amount of velocity compensation will be applied to a slave axis</p> <p>Valid Range = [1,20]</p> <p>1 = the amount of velocity compensation calculated for a given interrupt will be applied in 1 interrupt (i.e. no filter)</p> <p>2 = the amount will be divided up and applied over the next 2 interrupts</p> <p>3 = the amount will be divided up and applied over the next 3 interrupts</p> <p>.</p> <p>.</p> <p>.</p> <p>20 = the amount will be divided up and applied over the next 20 interrupts</p> <p>Increasing this value will reduce the sensitivity of the slave to changes in the master's velocity but will increase the amount of master/slave position lag that will occur during master acceleration and deceleration. Reducing this value will reduce or eliminate the amount of master/slave position lag that will occur during master acceleration and deceleration but will increase the sensitivity of the slave to changes in the master's velocity. Note that this master/slave position lag only occurs during acceleration and deceleration of the master axis.</p> <p>Default = 1, for analog interface servo axes  = 3, for digital drive axes  = Position Error Cyclic Update Offset + 6,  for SERCOS axes</p> <p style="text-align: right;"><b>F</b></p>	S	S
----	--	---	---

<p><b>63</b></p>	<p><b>Resumable E-Stop Allow</b> - selects whether the User-Set E-Stop (E_STOP function) and the Excess Following Error E-Stop will be resumable.</p> <p>When this variable is 1, the E_STOP function and the Excess Following Error E-Stop will execute a Resumable E-Stop. When a Resumable E-Stop occurs, the following happens:</p> <ol style="list-style-type: none"> <li>1. The servo loop is opened</li> <li>2. Zero voltage is sent to the analog outputs.</li> <li>3. The moves in the active and next queues remain intact.</li> <li>4. The axis' Normal Interpolator remains running.</li> <li>5. The axis goes into Resume Mode. In Resume Mode, the axis will follow the Resume Interpolator. The Resume Interpolator will output zero velocity until the RESUME function is called. The RESUME function can only be called after the Resumable E-Stop has been reset and the servo loop has been closed. The axis remains in Resume Mode until the RESUME function brings it back on path or until a non-resumable E-Stop occurs and cancels Resume Mode.</li> </ol> <p>When this variable is 0, the E_STOP function and the Excess Following Error E-Stop will execute a normal E-Stop (i.e. open the servo loop, zero voltage to the Analog outputs, and clear the active and next queues).</p> <p>This variable is initialized by STRTSERV based on the selection in Servo Setup.</p> <p>Note that the E_STOP function and the Excess Following Error E-Stop are the only types of E-Stops that are resumable. All other types of E-Stops will execute normally regardless of the state of this variable.</p> <p>Also see READ_SV Variable 64, RESMODE?, and RESUME.</p> <p style="text-align: right;"><b>F</b></p>	<p>S</p>	<p>S</p>
<p><b>64</b></p>	<p><b>Resume distance</b> - is the signed distance between the Resume Interpolator's command position and the Normal Interpolator's command position in ladder units. This value determines the direction and distance of a RESUME move. If this value is positive, the RESUME function will cause the axis to move in the positive direction. If this value is negative, the RESUME function will cause the axis to move in the negative direction. This value is only valid when the axis is in Resume Mode.</p> <p>Also see READ_SV Variable 63, RESMODE?, and RESUME.</p> <p style="text-align: right;"><b>F in FU</b></p>	<p>S</p>	

<p>65</p>	<p><b>Velocity Compensation Factor</b> – is the value used to multiply the change in the master axis feedback delta when calculating the slave axis’s velocity compensation. Refer to Variable 61 for a description of Multiple Interrupt Velocity Compensation. The slave axis number should be specified at the AXIS input.</p> <p>For most applications, the default value will be correct and this variable should not be changed. However, the exception to this rule is described in the following SERCOS NOTE.</p> <p><b>SERCOS Note:</b> For SERCOS axes, this value defaults to [Position Error Cyclic Update Offset + 6]. The Position Error Cyclic Update Offset is entered in Servo Setup. It is used to correctly calculate the position error of a SERCOS axis. In most cases, this default value will be the correct value to eliminate any position lag between SERCOS master and slave axes. However, if the master and slave axes are different types, (i.e. one analog interface and the other SERCOS) or the master and slave SERCOS drives are different (i.e. different manufacturer), it may be necessary to change this value to eliminate position lag between the master and slave axes. If this value is changed, it may also be desirable to change the velocity compensation filter. Refer to Variable 62 for a description of the velocity compensation filter.</p> <p>Valid Range = [1,20]</p> <p>1 = The change in the master axis feedback is not multiplied prior to calculating the slave axis’s velocity compensation. In other words, it will operate exactly like normal velocity compensation.</p> <p>2 = The change in the master axis feedback delta will be multiplied by 2 when calculating the slave axis’s velocity compensation.</p> <p>.</p> <p>.</p> <p>.</p> <p>20 = The change in the master axis feedback delta will be multiplied by 20 when calculating the slave axis’s velocity compensation.</p> <p>Default Value = 1, for analog interface servo axes          = 3, for digital drive axes          = Position Error Cyclic Update Offset + 6,          for SERCOS axes</p> <p style="text-align: right;"><b>F</b></p>	<p>S</p>	<p>S</p>
-----------	---	----------	----------

<p>66</p>	<p><b>Superimposed Move Axis Assignment</b> – activates or cancels the Superimposed Move feature. This feature allows the ladder to add a move on top of an axis’s current move.</p> <p>Writing a valid servo axis number to this variable turns on the Superimposed Move feature by assigning that axis (the Superimposed Move axis) to the axis specified at the AXIS input. (the Receiving axis). After this variable is written, any move executed by the Superimposed Move axis will be added on top of the current move of the Receiving axis. Internally, this is performed by adding the iteration command of the Superimposed Move axis to the iteration command of the Receiving axis. The Receiving Axis will only accept the additional command while it is executing a RATIO_ move or a VEL_STRT move. A typical application will specify a virtual axis for this variable. Writing a value of 0 cancels the Superimposed Move axis assignment. Both the Receiving axis and the Superimposed Move axis must have the same servo update rate.</p> <p>Reading this variable will return the axis number of the Superimposed Move axis. A returned value of 0 indicates there is no Superimposed Move axis assigned.</p> <p>Valid Range = [0,16] and [101,116]          Default Value = 0</p> <p><b>Notes:</b></p> <p style="padding-left: 40px;">If Variable 44 (User Iteration Command) is set to 1, Superimposed Moves will not be applied.</p> <p style="padding-left: 40px;">Reading Variable 45 (Iteration Command) will not return the combined iteration command of the specified axis and the assigned Superimposed Move axis. It will return only the iteration command of the specified axis.</p> <p style="text-align: right;"><b>F</b></p>	<p>S</p>	<p>S</p>
-----------	---	----------	----------



67	<p><b>Digital Drive Status Word</b> – indicates the following digital drive states. Each bit represents a state.</p> <p>0000 0001H - Startup Commutation Complete  0000 0002H - At Zero Speed  0000 0004H - In Speed Window  0000 0008H - Up to Speed  0000 0010H - At Plus Current Limit  0000 0020H - At Minus Current Limit  0000 0040H - Drive Bus Charged  0000 0080H - Drive Enabled  0000 0100H - Drive Ready  0000 0200H - Release Brake  0000 0400H - Drive Fault  0000 0800H - Drive Warning  0000 1000H - 220V Shunt on 440V Drive  0000 2000H - Drive Ready and Bus Charged  0100 0000H - Hardware Enable Line  0200 0000H - Auxiliary Feedback Loss-of-Feedback</p> <p>All other bits are reserved</p>	S,D	
<b>F</b>			

<p><b>68</b></p>	<p><b>Digital Drive Faults</b> – indicates any faults currently active in the digital drive. Each bit represents a fault.</p> <p>0000 0000H - No fault          0000 0001H - Drive Memory Fault          0000 0002H - Drive Bus Over Voltage Fault          0000 0004H - Drive PM1 Over Current Fault          0000 0008H - Drive Bus Under Voltage Fault          0000 0010H - Motor Temperature Fault          0000 0020H - Continuous Current Fault          0000 0040H - Drive Heatsink Temperature Fault          0000 0080H - Drive F2 Feedback Fault          0000 0100H - Drive F1 Feedback Fault          0000 0200H - Drive Ambient Temperature Fault          0000 0400H - Motor Calculated Temperature Fault          0000 0800H - Drive Timing Fault          0000 1000H - Drive Interface Fault          0000 2000H - User Set Fault          0000 4000H - Drive F1 Communication Fault          0000 8000H - Over Speed Fault          0001 0000H - Over Current Fault          0002 0000H - Control Panel Disconnect Fault          0004 0000H - Drive Power Module Fault          0008 0000H - Feedback Type Mismatch Fault          0010 0000H - (reserved)          0020 0000H - Drive Relay Fault          0040 0000H - Drive PM2 Over Current Fault          0080 0000H - Drive PM Temperature Fault          0100 0000H - Motor Ground Fault          0200 0000H - Drive AC Input Over Voltage Fault          0400 0000H - Overtravel Plus Fault          0800 0000H - Overtravel Minus Fault          1000 0000H - Digital Link Communication Error          2000 0000H - Invalid Switch Setting Fault          4000 0000H - (reserved)          8000 0000H - (reserved)</p>	<p>S</p>	<p>F</p>
------------------	---	----------	----------

69	<p><b>Digital Drive Warnings</b> – indicates any warnings currently active in the digital drive. Each bit represents a warning.</p> <p>0000 0000H - No warnings  0000 0001H - Drive Heatsink Temperature Warning  0000 0002H - Drive Ambient Temperature Warning  0000 0004H - Motor Temperature Warning  0000 0008H - Motor Calculated Temperature Warning  0000 0010H - Loss of Feedback on Aux Warning</p> <p>All other bits are reserved.</p> <p style="text-align: right;"><b>F</b></p>	S	
70	<p><b>Digital Drive Analog Input</b> – returns a value representing the voltage at the digital drive’s analog input. The value is in the range [-8192,8191] where 8192 counts = 10 volts.</p> <p>For example:</p> <p>8191 = 10V  4096 = 5V  0 = 0V  -4096 = -5V  -8192 = -10V</p> <p>The following formula can be used to calculate the voltage:  Voltage = Variable70 * 10V / 8192</p> <p style="text-align: right;"><b>F</b></p>	S	
71	<p><b>Digital Drive Inputs</b> – returns the states of the digital drive inputs. Each bit represents the state of one input.</p> <p>Bit 0 = Input 1  Bit 1 = Input 2  Bit 2 = Input 3  Bit 3 = Input 4  Bit 4 = Input 5  Bit 5 = Input 6  Bit 6 = Input 7  Bit 7 = Input 8  Bits 8 through 31 are undefined</p> <p>0 means the input is OFF  1 means the input is ON</p> <p><b>Note:</b> “MMC Application Input” must be checked as an Input Assignment in PiCPro for each input that is to be read here. If not, the bit representing that input will always be 0.</p> <p style="text-align: right;"><b>F</b></p>	S	

<p>72</p>	<p><b>Digital Drive Outputs</b> – Reading this variable returns the states of the digital drive outputs. Each bit represents the state of one output.</p> <p>Bit 0 = Output 1          Bit 1 = Output 2          Bit 2 = Output 3          Bit 3 = Output 4          Bit 4 = Output 5          Bits 5 through 31 are undefined</p> <p>0 means the output is OFF          1 means the output is ON</p> <p>Writing this variable will set or reset the digital drive outputs. Write a bit to 0 to turn OFF an output and write a bit to 1 to turn ON an output. If other states are assigned to an output by PiCPro, the following logic is used to determine if the output should be turned ON or OFF:</p> <p>The output will be turned ON:              if this bit is ON <b>OR</b> any of the other assigned states are ON.</p> <p>The output will be turned OFF:              if this bit is OFF <b>AND</b> all other assigned states are OFF.</p> <p><b>Note:</b> “MMC Application Output” must be checked as an Output Assignment in PiCPro for each output that is to be written by this variable. If not, writing this variable will have no effect on the digital drive output.</p> <p style="text-align: right;"><b>F</b></p>	<p>S</p>	<p>S</p>
<p>73</p>	<p><b>Digital Drive Current</b> – is returned in the range [-25500,25500] where the units represent .01 amps.</p> <p>For example:          25500 = 255.00 amps          165 = 1.65 amps          -14554 = -145.54 amps</p> <p style="text-align: right;"><b>F</b></p>	<p>S</p>	
<p>74</p>	<p><b>Digital Drive Average Current</b> – is returned in the range [0,25500] where the units represent .01 amps.</p> <p>For example:          25500 = 255.00 amps          165 = 1.65 amps</p> <p style="text-align: right;"><b>F</b></p>	<p>S</p>	

75	<p><b>Digital Drive Plus Current Limit</b> – is returned in the range [0,25500] where the units represent .01 amps.</p> <p>For example:  25500 = 255.00 amps  165 = 1.65 amps</p> <p>The digital drive will limit this value to the lesser of the Motor Maximum Current and the Drive Maximum Current.</p> <p style="text-align: right;"><b>F</b></p>	S	S
76	<p><b>Digital Drive Minus Current Limit</b> – is in the range [0,25500] where the units represent .01 amps.</p> <p>For example:  25500 = 255.00 amps  165 = 1.65 amps</p> <p>The digital drive will limit this value to the lesser of the Motor Maximum Current and the Drive Maximum Current.</p> <p style="text-align: right;"><b>F</b></p>	S	S
77	<p><b>Digital Drive Motor Temperature</b> – If the motor has a thermistor, the temperature is returned in degrees C. If the motor has a thermal switch, 0 is returned if the switch is open and 1 is returned if the switch is closed. If the motor has neither a thermistor nor a thermal switch, the calculated temperature is returned in degrees C.</p> <p style="text-align: right;"><b>F</b></p>	S	
78	<p><b>Digital Drive Position Loop Proportional Gain</b> – is in the range [0,32767]. The units are:  feedback units / minute / feedback units of following error</p> <p style="text-align: right;"><b>F</b></p>	S	S
79	<p><b>Digital Drive Position Loop Feedforward</b> – is the percentage of feedforward applied to the digital drive's position loop. The range is [0%,100%].</p> <p style="text-align: right;"><b>F</b></p>	S	S
80	<p><b>Digital Drive Velocity Loop Proportional Gain</b> – is in the range [0,32767] representing values in the range [0.0,3276.7]</p> <p style="text-align: right;"><b>F</b></p>	S	S
81	<p><b>Digital Drive Velocity Loop Integral Gain</b> – is in the range [0,32767].</p> <p style="text-align: right;"><b>F</b></p>	S	S
82	<p><b>Digital Drive Velocity Loop Integrator Inhibit</b></p> <p>0 = do not inhibit the digital drive velocity loop integrator  1 = inhibit the digital drive velocity loop integrator</p> <p style="text-align: right;"><b>F</b></p>	S	S

83	<p><b>Digital Drive Velocity Loop Integrator Hold</b></p> <p>0 = do not hold the digital drive velocity loop integrator 1 = hold the digital drive velocity loop integrator</p> <p style="text-align: right;"><b>F</b></p>	S	S
84	<p><b>Digital Drive Current Plus Enable</b></p> <p>0 = disable digital drive plus current 1 = enable digital drive plus current default = 1</p> <p style="text-align: right;"><b>F</b></p>	S	S
85	<p><b>Digital Drive Current Minus Enable</b></p> <p>0 = disable digital drive minus current 1 = enable digital drive minus current default = 1</p> <p style="text-align: right;"><b>F</b></p>	S	S
86	<p><b>Digital Drive Ignore Plus Travel Limit</b></p> <p>0 = enforce the digital drive plus travel limit 1 = ignore the digital drive plus travel limit</p> <p style="text-align: right;"><b>F</b></p>	S	S
87	<p><b>Digital Drive Ignore Minus Travel Limit</b></p> <p>0 = enforce the digital drive minus travel limit 1 = ignore the digital drive minus travel limit</p> <p style="text-align: right;"><b>F</b></p>	S	S
88	<p><b>Digital Drive Position Loop I-Gain</b> – specifies the integral gain value to be used in the digital drive’s position loop. The units are ((FU / min) * 1000) / (FUFE * min).</p> <p style="text-align: right;"><b>F</b></p>	S	S
89	<p><b>Digital Drive Predicted Command Velocity</b> – is the command velocity that can be used to perform a smooth transition when switching the digital drive to Velocity Mode. See DVLCMD. The units are RPM, motor revolutions / min.</p> <p style="text-align: right;"><b>F</b></p>	S	

90	<p><b>Digital Drive Absolute Reference Position</b> – specifies the position value to be assigned to the current position of a digital drive axis with an absolute feedback device. This is a one-time setup operation. This value is sent to the digital drive and the drive will retain this reference position through power cycles. When this value is sent to the digital drive, the current rollover position is also sent. The digital drive uses the rollover position to properly calculate the absolute position on subsequent power cycles. (Therefore, if the rollover position is ever changed by the ladder with WRITE_SV Variable 12, this absolute reference will need to be performed again.) The function REF_DNE? will indicate that the absolute reference is complete. Events that will clear this reference are:</p> <ul style="list-style-type: none"> <li>- Drive scaling changed</li> <li>- Loss-of-feedback occurred</li> <li>- Location of F1 or F2 feedback has changed</li> <li>- PiCPro's "Clear Absolute Reference" was selected by the user</li> <li>- Motor is changed</li> </ul> <p>The valid range is [0, 2147483647]. Also, after feedback scaling is applied in the digital drive, the result must be in the range [0, 4294967295].</p> <p style="text-align: right;"><b>F</b></p>		S,D
91	<p><b>Digital-Drive-to-Control Communication Errors</b> – is the number of communication errors detected in messages sent from the digital drive to the MMCD.</p> <p style="text-align: right;"><b>F</b></p>	S	
92	<p><b>Control-to-Digital-Drive Communication Errors</b> – is the number of communication errors detected in messages sent from the MMCD to the digital drive.</p> <p style="text-align: right;"><b>F</b></p>	S	

---



---

## READ\_SVF

Read Servo Fast

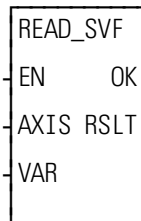
**Motion/DATA**

**Inputs:** EN (BOOL) - enables execution  
 AXIS (USINT) = identifies axis (servo, digitizing, or time)  
 VAR (SINT) = variable to be read

**Outputs:** OK (BOOL) - execution completed without error  
 RSLT (DINT) = servo data read

```
READ_SVF(AXIS := <<USINT>>, VAR := <<SINT>>, OK => <<BOOL>>,
  RSLT => <<DINT>>)
```

The read servo fast function allows the specified variable (VAR) to be read for the specified axis. The results of the read are displayed at RSLT. The READ\_SVF function performs the read faster than the READ\_SV function. It consumes less CPU time in exchange for some features. Less verification is performed on the inputs to READ\_SVF. All values that involve velocity or distance are in feedback units and updates rather than ladder units and minutes.

Refer to the Variables Table in the READ\_SV function for a listing of variables that can be READ using the READ\_SVF function.

NOTE: Because of minimal error checking, calling READ\_SVF without first initializing servos using STRTSERV will result in invalid outputs at OK and RSLT.



---



---

## REAL2DI

*Real to Double Integer*

**Datatype/REALCONV**

---



---

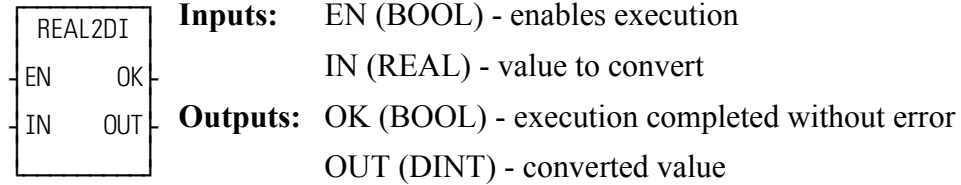

REAL2DI(N := <<REAL>>, OK => <<BOOL>>, OUT => <<DINT>>)

The REAL2DI function converts a real into a double integer. The result is placed in a variable at OUT.

---



---

## REAL2DW

*Real to Double Word*

**Datatype/REALCONV**

---



---

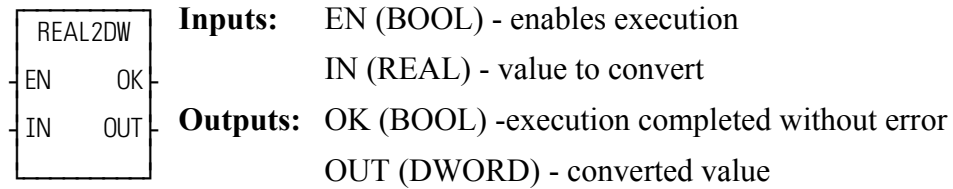

REAL2DW(IN := <<REAL>>, OK => <<BOOL>>, OUT => <<DWORD>>)

The REAL2DW function converts a real into a double word. The result is placed in a variable at OUT.

---



---

## REAL2LR

*Real to Long Real*

**Datatype/REALCONV**

---



---

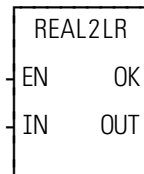

**Inputs:** EN (BOOL) - enables execution

IN (REAL) - value to convert

**Outputs:** OK (BOOL) - execution completed without error

OUT (LREAL) - converted value

REAL2LR(IN := <<REAL>>, OK => <<BOOL>>, OUT => <<LREAL>>)

The REAL2LR function converts a real into a long real. The result is placed in a variable at OUT.

---



---

## REAL2UDI

*Real to Unsigned Double Integer*

**Datatype/REALCONV**

---



---

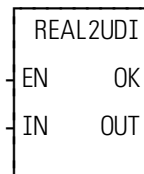

**Inputs:** EN (BOOL) - enables execution

IN (REAL) - value to convert

**Outputs:** OK (BOOL) - execution completed without error

OUT (UDINT) - converted value

REAL2UDI(IN := <<REAL>>, OK => <<BOOL>>, OUT => <<UDINT>>)

The REAL2UDI function converts a real into a unsigned double integer. The result is placed in a variable at OUT.

---

---

# REF\_DNE?

Reference Done?

**Motion/REF**

---

---



**Inputs:** EN (BOOL) - enables execution  
 AXIS (USINT) - identifies axis (servo or digitizing)

**Outputs:** OK (BOOL) - execution completed without error  
 RDNE (BOOL) - indicates if machine reference is done

REF\_DNE?(AXIS := <<USINT>>, OK => <<BOOL>>, RDNE => <<BOOL>>)

The reference done function asks the question “Is the machine reference cycle complete?” If RDNE is set, a reference cycle is done. If not, then the reference cycle is not done.

RDNE is cleared when servo reinitialization takes place and whenever a reference function is called.

NOTE: This function cannot be used with the stepper axis module.

---

---

# REF\_END

Reference End

**Motion/REF**

---

---

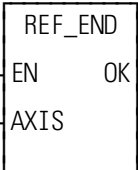

**Inputs:** EN (BOOL) - enables execution (**Typically one-shot**)  
 AXIS (USINT) - identifies axis (servo or digitizing)

**Outputs:** OK (BOOL) - execution completed without error

REF\_END?(AXIS := <<USINT>>, OK => <<BOOL>>)

When the reference switch is tripped in a ladder machine reference, this function is used to inform the software that the reference has occurred. Also see LAD\_REF. When performing a LAD\_REF on the index mark with a virtual axis, REF\_END will also generate the index event.

**IMPORTANT**

The REF\_END function is *always* used when doing a ladder (LAD\_REF) machine reference. The REF\_END function cannot be used with the stepper axis module.

**REGIST**

Registration

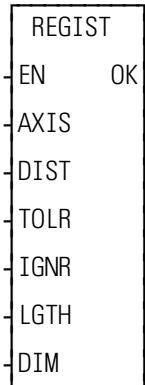
**Motion/MOVE\_SUP**

- Inputs:** EN (BOOL) - enables execution (**Typically one-shot**)
- AXIS (USINT) - identifies the axis registration will be applied to. (servo or digitizing)  
NOTE: Fast input on axis feedback required.
- DIST (UDINT) - distance between registration marks that identifies the second mark as a good mark. (Usually the same as LGTH.) Range of values is 0 to 536,870,912 FU. Entered in LU.
- TOLR (UDINT) - error allowed to exist between two marks when compared to DIST. Range of values is 0 to 536,870,912 FU. Entered in LU.
- IGNR (UDINT) - distance after a mark in which any mark will be ignored. Range of values is 0 to 536,870,912 FU. Entered in LU.
- LGTH (UDINT) - theoretical distance between good registration marks. Used to calculate the compensation needed, if any, in master/slave applications. Range of values is 0 to 536,870,912 FU. Entering a zero turns registration off. Entered in LU.
- DIM (DINT) - value axis position will take on when a good registration mark occurs. Range of values is -32,768 to 32,767 FU. Entered in LU.

**Outputs:** OK (BOOL) - execution completed without error

The OK will not be set if any of the following occur:

- The axis is not found.
- Any input is out of range.
- A reference move is in the active or next queue.

```
REGIST(AXIS := <<USINT>>, DIST := <<UDINT>>, TOLR := <<UDINT>>,
IGNR := <<UDINT>>, LGTH := <<UDINT>>, DIM := <<DINT>>, OK =>
<<BOOL>>)
```

The registration function is used to set the axis position to a defined value when a fast input occurs. It can be used on a servo or digitizing axis with any move type.

**SERCOS NOTE:** The function block SCA\_PBIT must be called and completed successfully prior to calling the REGIST function with a SERCOS axis.

Registration is most frequently used in master/slave applications. When used with master/slave moves, it has the additional ability of compensating for errors that may occur. The end result is a system that remains synchronized with no accumulated error. Repeatable accuracy throughout a process can be maintained.

The axis identified at AXIS may be a master or a slave axis. Registration can run on either one. But because the control may not be controlling the master axis, any compensation for error is done on the slave axis.

The software calculates how much compensation is required by the value entered in LGTH (**Note:** A zero entered in LGTH turns registration off). This is the theoretical distance between good registration marks. In a packaging application, this is often equivalent to the product length or the cycle length.

**Note:** For registration to work properly, the ratio of the LGTH to the slave or master distance entered in the ratio move function must equal a whole number as illustrated in the following equations.

**For Slave Registration:**

$$\frac{\left( \text{LGTH}_{\text{LU}} \times \left( \frac{\text{FU}}{\text{LU}} \right) \right)}{\text{SDST}_{\text{FU}}} = 1, \text{ or } 2 \text{ etc. (whole number)}$$

**For Master Registration:**

$$\frac{\left( \text{LGTH}_{\text{LU}} \times \left( \frac{\text{FU}}{\text{LU}} \right) \right)}{\text{MDST}_{\text{FU}}} = 1, \text{ or } 2 \text{ etc. (whole number)}$$

When registration is used in combination with master-slave ratio moves, you must ensure that registration and the ratio moves work together properly. In most applications there is an integer relationship between the value entered at LGTH and the associated distance traveled for both the master and slave.

The next three inputs, DIST, TOLR, and IGNR, are used to determine whether or not the registration mark is good. For a mark to be recognized as good, it must be the value entered in DIST from the previous mark. A tolerance can be entered in TOLR which allows an error between two marks when compared to DIST.

A distance can be entered in IGNR which allows any marks within that distance to be ignored following the last mark.

**Note:** This last mark is not necessarily a good mark.

This is illustrated in What Determines a Good Mark. The second registration mark is recognized as a good mark because it is within the distance  $\pm$  tolerance range and it is not in the ignore region.

**Note on tolerance:** If a value of 10 units is entered at TOLR, then there is a range of  $\pm 10$  which make up the tolerance band.

**Figure 2-29. What Determines a Good Mark**

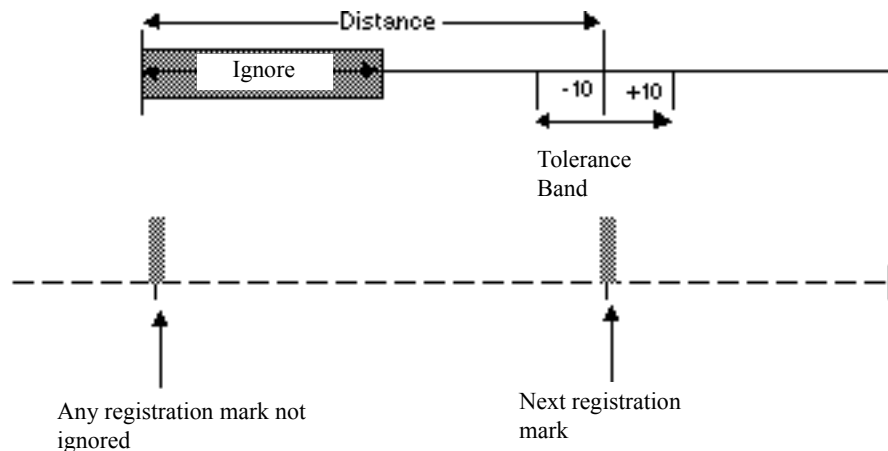

If all marks are to be recognized as good marks, enter a 0 in DIST and a 0 in IGNR.

Whenever a good registration mark occurs, the axis position is reset to the value entered in DIM.

**PROGRAMMING NOTE**

The REGIST function should be called only once when you are ready to begin registration. It is only necessary to call it again if any of the inputs have changed. When the REGIST function is called, any pending non-motion reference is cleared.

**Note:** Any motion reference in the active or next queue will prevent the registration function from executing.

**SERCOS NOTE:** The function block SCA\_PBIT must be called and completed successfully prior to calling the REGIST function with a SERCOS axis.

## Background on registration

In many closed-loop servo systems, it is often necessary to maintain synchronization and accurate positioning repeatedly throughout a process. This can be difficult when the product or process itself is inconsistent. Using registration allows you to overcome this difficulty.

Many factors can contribute to inconsistency. Some examples of the numerous possibilities are as follows:

- Working with non-rigid material which may stretch or shrink during processing.
- Working with the mechanics of a system where the revolution of a feedback device may give you 5975 counts on one revolution and 5974 on the next.
- Unevenly spaced products on a belt.

Typically, when using registration, sensors are used to detect the position of the product. With non-rigid materials which may stretch or shrink, a photo eye can detect registration marks on the material. With rigid products (or processes), a proximity switch could detect material spacing.

Registration capabilities are available on any axis with any move type. The fast input on the feedback module allows a position at a registration event to be captured. When this occurs, the system recalculates the numerical representation of the axis position.

This is important in applications such as packaging or converting where the process must be precisely coordinated and any non-rigid material cannot be depended upon to retain dimensional relationships. These applications usually involve master/slave moves. The fast input signals can be used as repeatable references to which the master and all subsequent slaves continually synchronize. This discussion uses a master/slave application.

### Registration example

This example uses the RATIOPRO move which is based on a master/slave algorithm. The move has a defined cycle length. Registration compensation, when required, takes place within this cycle with the insertion of an offset value calculated by the software. (There are also offsets that can be entered by you with the WRITE\_SV function.)

Looking at a packaging process (Example of registration) where a labeled product coming off a web of non-rigid material (master axis) must be cut with a rotary knife (slave axis) to 5 inch lengths so that the label is always in the center of the product, you would want to compensate for any variation in product length during each cycle.

Figure 2-30. Example of registration

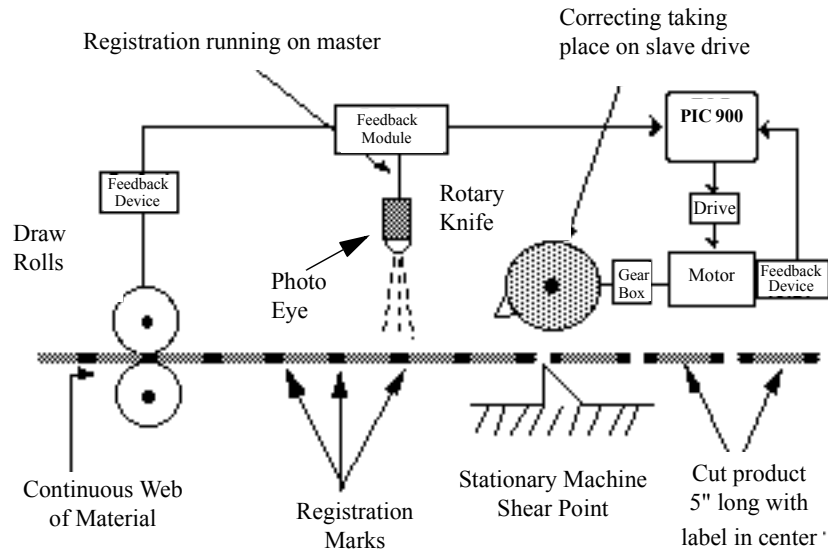



If you did not compensate, then the error would accumulate and the label would no longer be centered. As an example, the product is being cut at a rate of 500 per minute. If the product becomes stretched so that the actual length is 5.001 inch, in one minute the label on the product would be off by 1/2 inch--in two minutes, by 1 inch, etc.

By using a photo eye to detect registration marks on the product, any error in product length will be detected. The rotary knife will adjust its position to compensate for any error in product length so that the product is always cut at the correct position. Because the stretching of the material is gradual, the compensation will be minimal. If there is no stretching of the product, no compensation will occur.

Block diagrams of registration showing the interaction between the various components of registration are shown in Block diagram of master registration and in Block diagram of slave registration

Some of the bits and variables of the servo data functions (STATUSV, READ\_SV, and WRITE\_SV) are used in conjunction with registration.

With registration running on the master axis (Example of registration), the actual axis position is monitored by the control with the feedback device.

The photo eye is watching for registration marks and sending a fast input signal when it sees one. The “good mark detector” decides if the mark is recognized as good by the parameters you have defined in DIST, TOLR, and IGNR. Information coming out of the good mark detector includes whether a good or bad mark has been detected, if the distance plus tolerance has been exceeded, and the number of consecutive bad marks.

When a good mark is detected, that information is sent to two places; the registration calculation and the axis position calculation. In the registration calculation, the LGTH value, the good mark, and the actual axis position are all used to calculate an offset value for the master.

This offset value is sent to the master/slave profile (through the offset filter if it is turned on).

When a good mark occurs, the axis position is reset to the value entered in DIM.

Figure 2-31. Block diagram of master registration

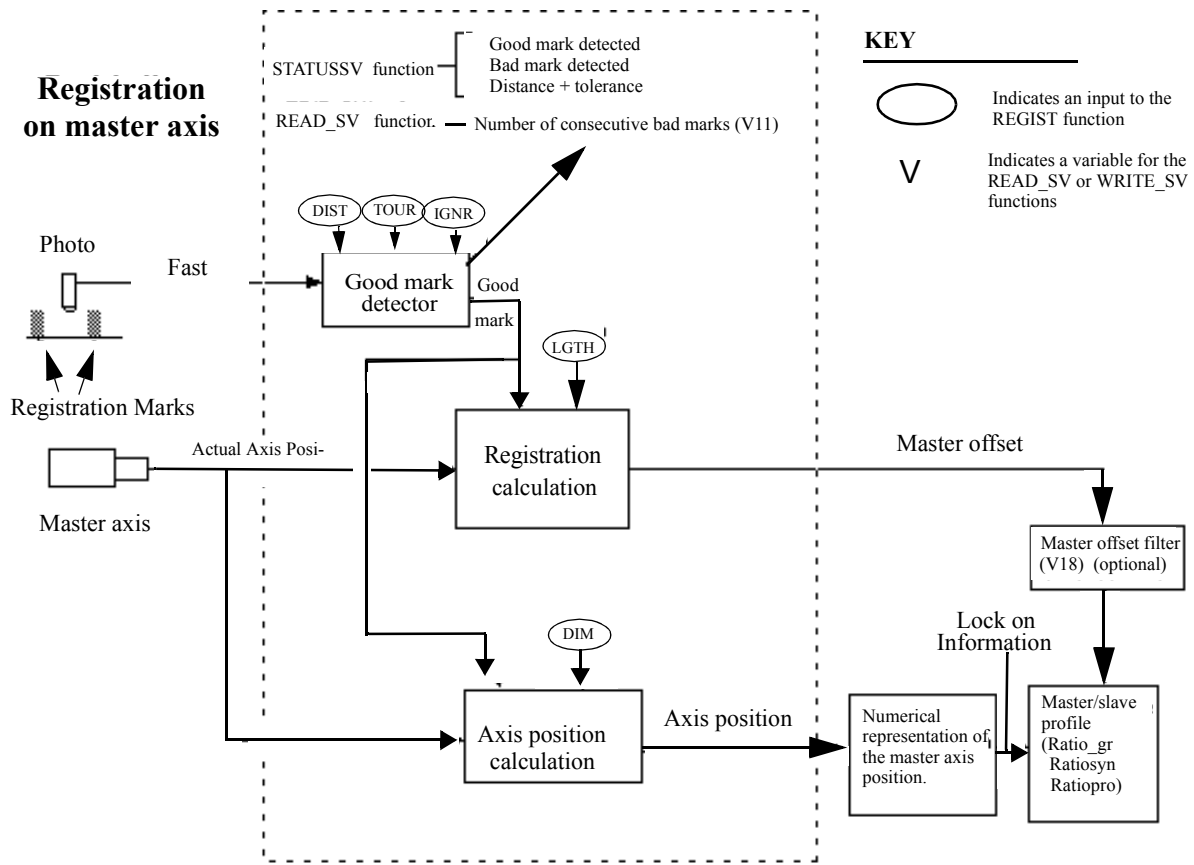

When registration is running on the slave axis (Block diagram of slave registration), the block diagram is very similar to the master registration one in Block diagram of master registration

Figure 2-32. Block diagram of slave registration

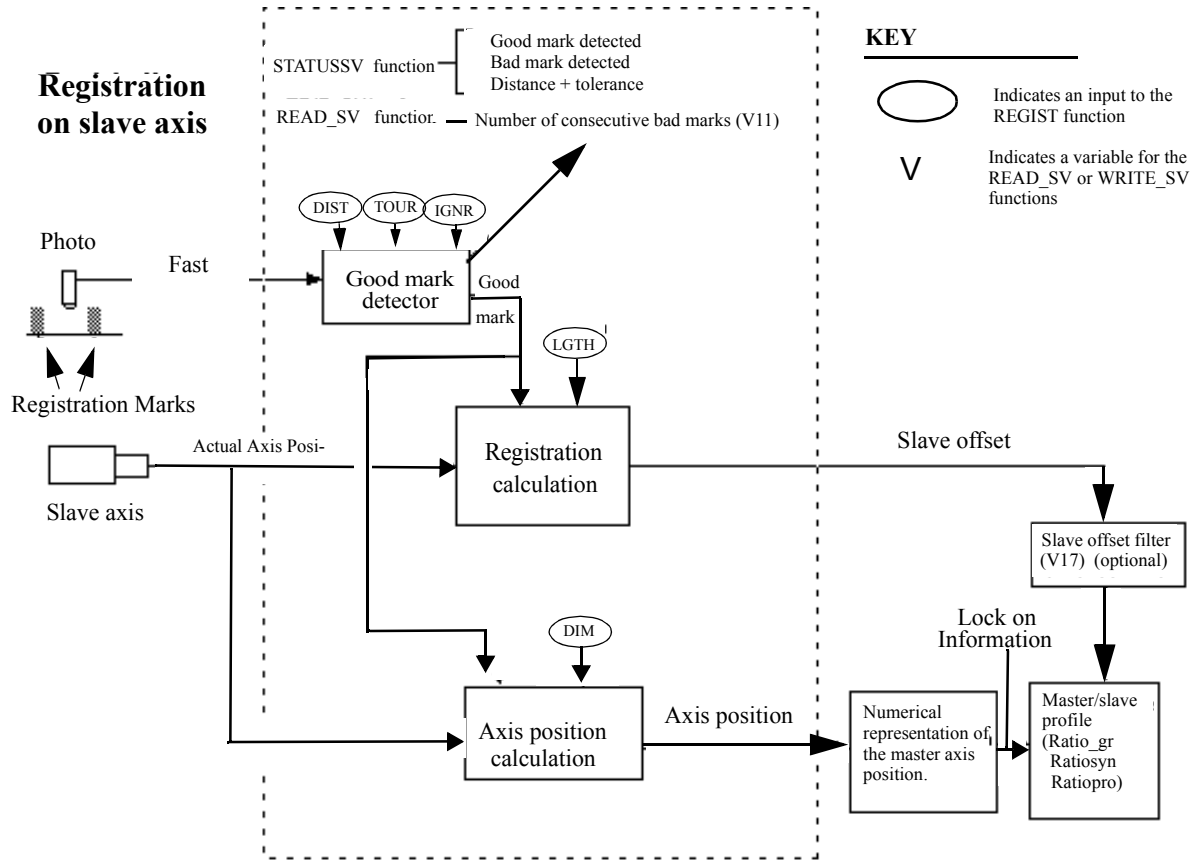

Two ways in which registration could be used are explained below. Every mark is recognized in Registration with all good marks. This can be done by entering a 0 in the DIST and a 0 in the IGNR inputs. Now every mark will be recognized as good.

**Figure 2-33. Registration with all good marks**

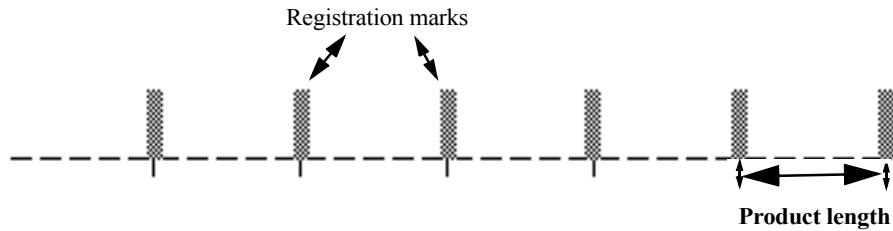

This is acceptable when there is no chance for the photo eye to trigger off of any other mark on the product.

Sometimes there are other marks occurring that you do not want to register off of, such as those shown in Registration that recognizes some marks as good. It is possible to skip unwanted marks.

**Figure 2-34. Registration that recognizes some marks as good**

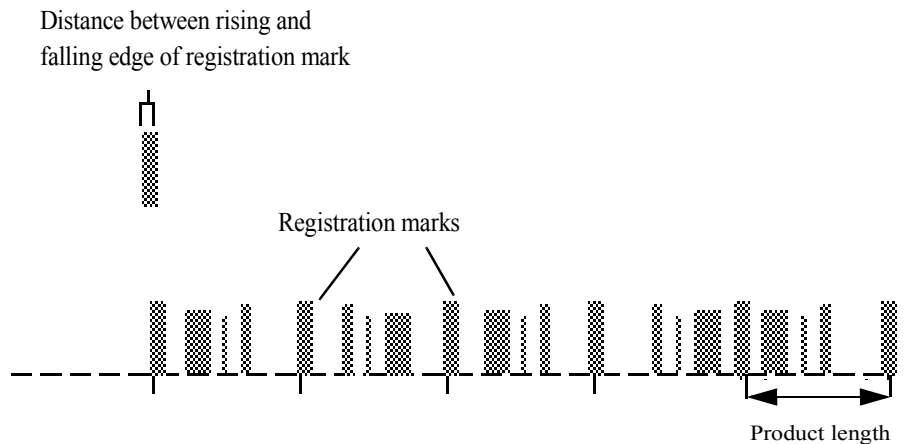

---



---

# RENAME

Rename

**Io/COMM**

---



---

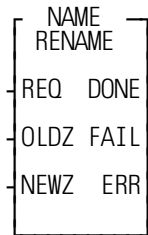

**Inputs:** REQ (BOOL) - enables execution (**One-shot**)  
 OLDZ (STRING) - a string containing the complete pathname  
 NEWZ (STRING) - a string containing the new file-name

**Outputs:** DONE (BOOL) - energized if ERR = 0  
 not energized if ERR ≠ 0  
 FAIL (BOOL) - energized if ERR ≠ 0  
 not energized if ERR = 0  
 ERR (INT) - 0 if data transferred successfully  
 ≠ 0 if data transfer unsuccessful  
*See Appendix B in the PiCPro Online Help for error codes.*

```
<<INSTANCE NAME>>:RENAME(REQ := <<BOOL>>, OLDZ :=
    <<STRING>>, NEWZ := <<STRING>>, DONE => <<BOOL>>, FAIL =>
    <<BOOL>>, ERR => <<INT>>);
```

**Note:** The RENAME function block cannot be used with the FMSDISK.  
 The RENAME function block allows you to rename an existing file on the RAMDISK or in PiCPro. The complete pathname is placed in the OLDZ and the new name is placed in the NEWZ. The new name must not be the name of an existing file.

At the OLDZ input, enter the complete pathname to rename a file in PiCPro:

With a subdirectory, Without a subdirectory,  
**PICPRO:c:\sub\file-** or **PICPRO:c:filename.ext\$00**  
**name.ext\$00**

or the following to rename a file on the RAMDISK.

With a subdirectory, Without a subdirectory,  
**RAMDISK:sub\file-** or **RAMDISK:filename.ext\$00**  
**name.ext\$00**

## **RENAME**

At the NEWZ input, enter the new filename in the format shown below.

**filename.ext\$00**

---

---

**REPLACE**

Replace

**String/REPLACE**

---

---

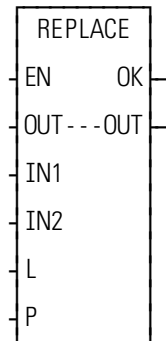

**Inputs:** EN (BOOL) - enables execution  
 OUT (STRING) - output STRING  
 IN1 (STRING) - characters to replace  
 IN2 (STRING) - characters which replace  
 L (INT) - length  
 P (INT) - position

**Outputs:** OK (BOOL) - execution completed without error  
 OUT (same variable as OUT input)

```
RENAME(OUT := <<STRING>>, IN1 := <<STRING>>, IN2 := <<STRING>>,
  L := <<STRING>>, P := <<INT>>, OK => <<BOOL>>, OUT =>
  <<STRING>>)
```

The REPLACE function is used to replace one or more characters in a STRING with all characters from another STRING. All characters in the variable at IN2 replace characters in the variable at IN1, starting at the position specified by the input at P. The input at L specifies how many characters in the variable at IN1 are being replaced. The variables at IN1 and IN2 must be unique from the variable at OUT.

**An error occurs:**

If P = 0

If P &gt; 255

If P &gt; length of IN1

If L &gt; 255

If IN1 = OUT

If IN2 = OUT

If length of IN1 - L + length of IN2 &gt; length of OUT

**Example of replace function**

Var at IN1	Var at IN2	Value at L	Value at P	Var at OUT
stringLong2	1string	4	7	string1string2

# REP\_END

Repeat Profile End

Motion/RATIOMOV

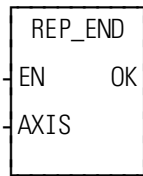

**Inputs:** EN (BOOL) - enables execution (**One-shot**)

AXIS (USINT) - identifies axis (servo)

**Outputs:** OK (BOOL) - execution completed without error

REP\_END(AXIS := <<USINT>>, OK => <<BOOL>>)

The repeat profile end function is required to stop repeating profiles that have been started in the RATIOCAM, RATIOSLP, or RATIOPRO functions.

It will only stop repeating profiles if the function calling for repeating profiles is in the active queue. It has no effect on moves that are not in the active queue.

A REP\_END function was activated while a RATIOPRO move was in the active queue at the point 1 shown in Ending a repeating profile. The profile will continue executing until it reaches segment 5. (See point 2.) Then it will come to an end instead of returning to segment 2 as it does when repeating.

**Figure 2-35. Ending a repeating profile**

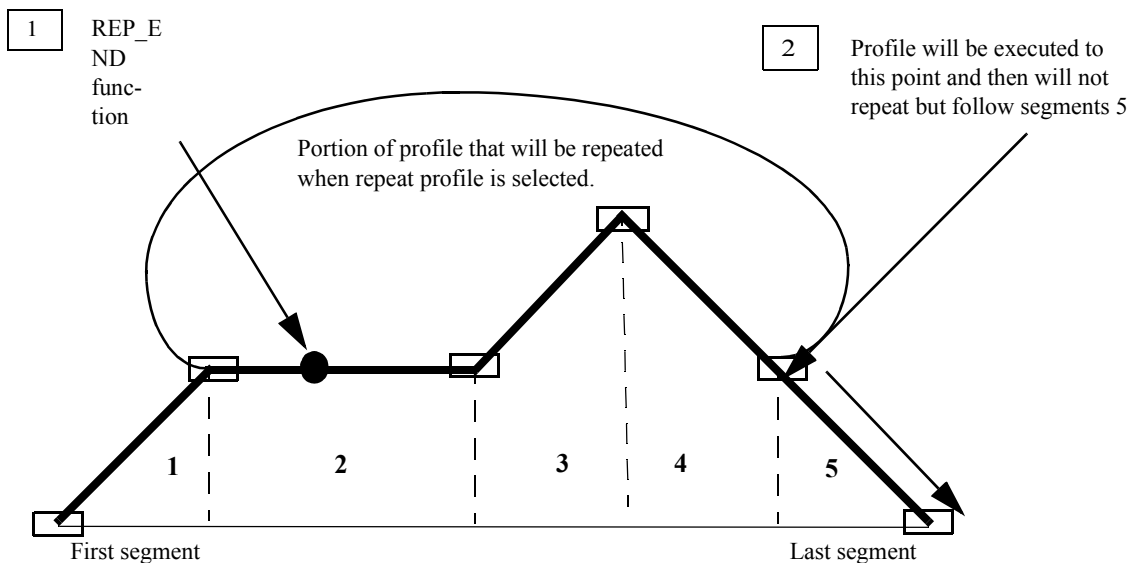



---



---

## RESMODE?

Axis in Resume Mode?

**Motion/ERRORS**

---



---

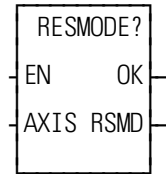

**Inputs:** EN (BOOL) - enables execution

AXIS (USINT) - identifies axis (servo only)

**Outputs:** OK (BOOL) - execution completed without error

RSMD (BOOL) - indicates the axis is in Resume Mode when set

RESUME(AXIS := <<USINT>>, OK => <<BOOL>>, RSMD => <<BOOL>>)

The RESMODE? function asks if the axis is in Resume Mode. If so, RSMD will be energized; if not, RSMD will be de-energized. An axis is in Resume Mode from the time a Resumable E-Stop occurs until the RESUME function moves the axis back on path and the Normal Interpolator resumes control of the axis or until a non-resumable E-Stop occurs to cancel Resume Mode. While in Resume Mode, the Resume Interpolator (commanded via the RESUME function) controls the axis and the Normal Interpolator is allowed to continue running, but controls nothing. The difference between the commands of these two interpolators is accumulated in Resume Distance (READ\_SV Variable 64). A Resumable E-Stop occurs when the E\_STOP function is called or an Excess Following Error E-Stop occurs while Resumable E-Stop Allow is set (WRITE\_SV/READ\_SV Variable 63).

Also see RESUME and READ\_SV Variables 63 & 64.

---



---

## RESUME

Resume to Normal Interpolator Path

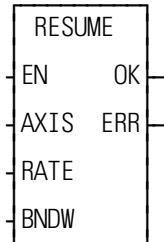
Motion/**ERRORS**

**Inputs:** EN (BOOL) - enables execution (one-shot)  
 AXIS (USINT) - axis number (servo only)  
 RATE (UDINT) - axis feedrate in LU/min (range = 0 to the velocity limit specified in Servo Setup)  
 BNDW (UDINT) - back on path bandwidth in LU (range = 0 FU to 2147483647 FU)

**Outputs:** OK (BOOL) - execution complete without error  
 ERR (INT) - error number

```
RESUME(AXIS := <<USINT>>, RATE := <<UDINT>>, BNDW :=
  <<UDINT>>, OK => <<BOOL>>)
```

After a Resumable E-Stop occurs and the axis goes into Resume Mode, the RESUME function will command the axis to move back to the Normal Interpolator's command position at the velocity specified by RATE. The direction and distance the axis will travel are determined by the Resume Distance (READ\_SV Variable 64).

If the Resume Distance is positive, the axis will travel in the positive direction. If the Resume Distance is negative, the axis will travel in the negative direction. The Resume Distance is the distance between the Resume Interpolator's command position and the Normal Interpolator's command position. When the Resume Distance is less than or equal to BNDW (i.e. the axis is back on path), the Normal Interpolator will resume control of the axis and Resume Mode is turned off.

### IMPORTANT:

Be aware that acceleration/deceleration ramps are not applied to this motion. The rate specified is immediately applied to the axis. Therefore, the feedrate used should **slowly** move the axis back to path.

### IMPORTANT:

Also be aware that once the Resume Distance is within the bandwidth BNDW, the axis will be commanded to move the remainder of the distance to path in the next update. Therefore, care should be taken in selecting the size of BNDW.

**Notes:**

- This function can only be called if the axis is in Resume Mode and the loop is closed.
- This function can be called multiple times while in Resume Mode if the ladder desires to change the feedrate or bandwidth during the move.
- The Slow Velocity Filter is applied to the output of the Resume Interpolator

If no error occurs, OK will be energized and ERR will be 0. If an error occurs, OK will be de-energized and ERR will indicate the error. Possible values for ERR are:

- 0 = no error
- 1 = invalid AXIS input
- 2 = axis is not in Resume Mode
- 3 = axis servo loop is not closed
- 4 = invalid RATE input
- 5 = invalid BNDW input

Also see RESMODE? and READ\_SV Variables 63 & 64.

---

---

**RIGHT***Right String***String/RIGHT**

---

---

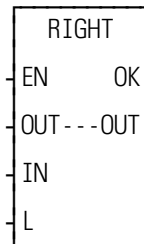

**Inputs:** EN (BOOL) - enables execution  
 OUT (STRING) - output STRING  
 IN (STRING) - STRING to extract from  
 L (INT) - length

**Outputs:** OK (BOOL) - execution completed without error  
 OUT (same variable as OUT input)

RIGHT(OUT := <<STRING>>, IN := <<INT>>, L := <<INT>>, OK =>  
 <<BOOL>>, OUT => <<STRING>>)

The RIGHT function is used to extract characters from the right side of a string. The number of characters specified by the input at L are extracted from the right side of the variable at IN and placed into the variable at OUT.

An error occurs:

If L > OUT

If L > 255

**Example of right function**

Var at IN1	Value at L	Var at OUT
string1string2	7	string2

# ROL

Rotate Left

**Binary/ROL**

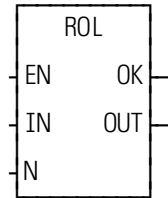

**Inputs:** EN (BOOL) - enables execution  
 IN (BITWISE) - value to have bits rotated  
 N (USINT) - number of bits to rotate

**Outputs:** OK (BOOL) - execution completed without error  
 OUT (same type as IN) - rotated value

ROL(IN := <<BITWISE>>, N := <<USINT>>, OK => <<BOOL>>, OUT => <<BITWISE>>)

The ROL function is similar to the shift left function. The bits in the variable or constant at IN are moved to the left the number of positions specified by N. The bits on the left are not discarded, but are rotated, replacing the bits on the right. The result is placed in the variable at OUT.

Rotate left, where N = 2:

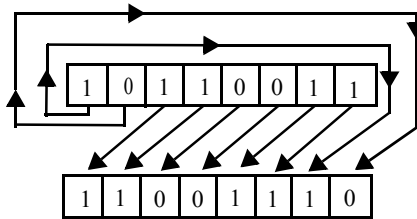

**Examples of rotate left:**

ROL (3)    11110000    =    10000111  
 ROL (4)    01110011    =    00110111  
 ROL (6)    11000011    =    11110000

**ROR**

Rotate Right

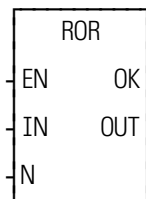
**Binary/ROR****Inputs:** EN (BOOL) - enables execution

IN (BITWISE) - value to have bits rotated

N (USINT) - number of bits to rotate

**Outputs:** OK (BOOL) - execution completed without error

OUT (same type as IN) - rotated value

ROR(IN := <<BITWISE>>, N := <<USINT>>, OK => <<BOOL>>, OUT => <<BITWISE>>)

The ROR function is similar to the shift right function. The bits in the variable or constant at IN are moved to the right the number of positions specified by N. The bits on the right are not discarded, but are rotated, replacing the bits on the left. The result is placed in the variable at OUT.

**Rotate right, where N = 2:**

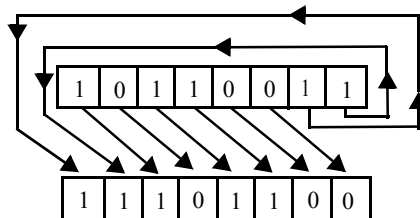
**Examples of rotate right**

ROR (3) 11110000 = 00011110

ROR (4) 01110011 = 00110111

ROR (8) 11001101 = 11001101

**R\_PERCEN**

Rate Percent

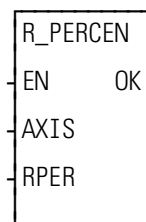
**Motion/MOVE\_SUP**

**Inputs:** EN (BOOL) - enables execution  
 AXIS (USINT) - identifies axis (servo)  
 RPER (USINT) - percent to increase or decrease feedrate at for all moves for the specified axis. The range is from 0 to 199% with 100% being the feedrate entered at RATE for distance, position and velocity moves.  
 NOTE: If 200 to 255% is entered, the software handles it as if 199 was entered.

**Outputs:** OK (BOOL) - execution completed without error

R\_PERCEN(AXIS := <<USINT>>, RPER := <<USINT>>, OK => <<BOOL>>)

The rate percent function allows the feedrate for all moves connected with the specified axis to be changed.

**Note:** This is a temporary change in feedrates lasting until the servos are reinitialized. At that point, it defaults to the feedrates entered in setup. The velocity limit entered in setup will never be exceeded by what is entered in the RPER input.

---



---

## SC\_INIT

SERCOS initialization

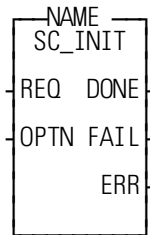
**Motion/SERC\_SYS**

**Inputs:** REQ (BOOL) - set to call (**one-shot**)

OPTN (USINT) - must be zero

**Outputs:** DONE (BOOL) - set when initialization has completed successfully

FAIL (BOOL) - Set if initialization error occurred

ERR (UINT) -  $\neq 0$  if initialization error occurred

```
<<INSTANCE NAME>>:SC_INIT(REQ := <<BOOL>>, OPTN := <<USINT>>,
  DONE => <<BOOL>>, FAIL => <<BOOL>>, ERR => <<UINT>>);
```

The SC\_INIT function block copies the initialization data into all SERCOS interface modules. It is used in conjunction with the user-defined function block created in the SERCOS setup program. See the PiCPro Online Help for more information.

The REQ input should be one-shot at the beginning of the ladder after calling the user-defined function block created in SERCOS setup. The SC\_INIT function block must be scanned every ladder scan. Never program a jump around this function block.

The OPTN input is reserved for future use and must be set to zero.

The ERR output will be  $\neq 0$  if an error occurred. See Table 2-11 on page 407 for a list of errors.

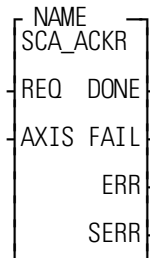

**SCA\_ACKR***SERCOS axis acknowledge reference***Motion/REF**

**Inputs:** REQ (BOOL) - set to acknowledge the reference cycle (**one-shot**)

AXIS (USINT) - identifies servo SERCOS axis

**Outputs:** DONE (BOOL) - set when the write is complete

FAIL (BOOL) - set if an error occurred

ERR (INT)  $\neq 0$  if an error occurred

SERR (UINT) - slave error;  $\neq 0$  if ERR is 128

```
<<INSTANCE NAME>>:SCA_ACKR(REQ := <<BOOL>>, AXIS :=
  <<USINT>>, DONE => <<BOOL>>, FAIL => <<BOOL>>, ERR =>
  <<INT>>, SERR => <<UINT>>);
```

The SCA\_ACKR function block is used with a servo SERCOS axis and acknowledges the reference cycle. It sends IDN 148 with a value of zero.

The drive will again be controlled by the SERCOS master (the PiC) after this function block is called.

The AXIS input identifies the servo SERCOS axis.

The DONE output is set after the internal conditions to acknowledge the reference cycle are complete.

The FAIL output is set if an ERR occurs.

The ERR output will be  $\neq 0$  if an error occurred. See Table 2-11 on page 407 for a list of errors.

The SERR output will be  $\neq 0$  if the ERR output is 128. See Table 2-12 on page 410 for a list of errors.

---



---

## SCA\_CLOS

SERCOS axis close

Motion/INIT

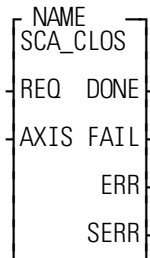

**Inputs:** REQ (BOOL) - set to read the drive IDNs (**one-shot**)

AXIS (USINT) - identifies servo SERCOS axis

**Outputs:** DONE (BOOL) - set when the write is complete

FAIL (BOOL) - set if an error occurred

ERR (INT) -  $\neq 0$  if a read error occurred

SERR (UINT) - slave error;  $\neq 0$  if ERR is 128

```
<<INSTANCE NAME>>:SCA_CLOS(REQ := <<BOOL>>, AXIS :=
<<USINT>>, DONE => <<BOOL>>, FAIL => <<BOOL>>, ERR =>
<<INT>>, SERR => <<UINT>>);
```

The SCA\_CLOS function block is used to close a servo SERCOS position loop. It performs the following:

- read drive IDN 76 and determine if the drive modulo (rollover) is set
- read IDN 103 if modulo is set
- read IDN 47 to determine current drive position
- update the servo data with the new position
- send the value as commanded position
- set the control bits to cause the drive to close the feedback loop.

The REQ input is set to read the drive IDN. This can take several scans.

The AXIS input identifies the servo SERCOS axis.

The DONE output is set after the internal conditions to close the loop are set.

The FAIL output is set if an ERR occurs.

The ERR output will be  $\neq 0$  if an error occurred. See Table 2-11 on page 407 for a list of errors.

The SERR output will be  $\neq 0$  if the ERR output is 128. See Table 2-12 on page 410 for a list of errors.

**Note:** Rollover on position in the PiC is the same concept as modulo in the drive. They are independent of each other. Their values can be the same or different and one or the other or both can be turned on or off.

**SCA\_CTRL**

SERCOS axis control

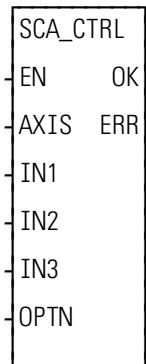
**Motion/DATA**

**Inputs:** EN (BOOL) - set to call function  
 AXIS (USINT ) - identifies SERCOS axis  
 IN1 (BOOL) - used to set the appropriate control word bit  
 IN2 (BOOL) - used to set the appropriate control word bit  
 IN3 (BOOL) - used to set the appropriate control word bit  
 OPTN (USINT) - defines which control word bits are affected by IN1-3

**Outputs:** OK (BOOL) - set if write is allowed  
 ERR (INT) - ≠ 0 if error occurred

```
SCA_CTRL(AXIS := <<USINT>>, IN1 := <<BOOL>>, IN2 := <<BOOL>>, IN3
:= <<BOOL>>, OPTN := <<USINT>>, OK => <<BOOL>>, ERR =>
<<INT>>)
```

When the SERCOS slave is being controlled by the functions in Motion.lib, the SCA\_CTRL function is used to control bits 6 - 9 and 11 of the MDT control word. Refer to the SERCOS specification for the definitions of the MDT control word.

Bits 8, 9, and 11 define the operation mode. They are normally set to zero which is the default.

Bits 6 and 7 define the real time control bits. The SERCOS specification and your drive manual define the purpose of these bits. Typically, bits 6 and 7 are left at zero.

The following table illustrates how the IN and OPTN inputs are used.

If the OPTN Input is:	Then	is control word bit	Description
0	(Not used for SCA_CTRL)		
1	IN1 IN2 IN3	8 9 11	The chart below summarizes the mode options for IN1, IN2 and IN3 when OPTN 1 is chosen. Typically, primary operation is used.
			<b>Bits</b>
			<b>11    9    8    Description</b>
			0    0    0    Primary operation mode (IDN 32)
			0    0    1    Secondary operation mode 1 (IDN 33)
			0    1    0    Secondary operation mode 2 (IDN 34)
			0    1    1    Secondary operation mode 3 (IDN 35)
			1    0    0    Secondary operation mode 4 (IDN 284)
			1    0    1    Secondary operation mode 5 (IDN 285)
			1    1    0    Secondary operation mode 6 (IDN 286)
			1    1    1    Secondary operation mode 7 (IDN 287)
2	IN1 IN2 IN3	6 not used not used	Real time control bit 1
3	IN1 IN2 IN3	7 not used not used	Real time control bit 2

**Note:** All bits default to zero.

The ERR output will be  $\neq 0$  if an error occurred. See Table 2-11 on page 407 for a list of errors.

**Application Note**

When the SERCOS slave is controlled by Motion.lib, you follow the steps summarized below.

1. Initialize the SERCOS axis.
2. Initialize the servo axis.
3. Use the SCA\_CTRL function to set the operation mode and the realtime bits 1 and 2. **NOTE:** The primary operation mode is the default mode and typically used for most applications.
4. Control bits 13, 14, and 15 for the drive loop closure with Motion.lib logic. **NOTE:** If the loop closure bits must be controlled by the ladder, WRITE\_SV variable 48 must be set to 1 and the bits controlled by SCS\_CTRL.

---



---

## SCA\_ERST

SERCOS axis error reset

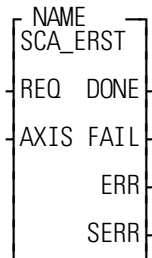
**Motion/ERRORS**

**Inputs:** REQ (BOOL) - set to reset internal E-errors (**one-shot**)

AXIS (USINT) - identifies servo SERCOS axis

**Outputs:** DONE (BOOL) - set when errors are reset

FAIL (BOOL) - set if an error occurred

ERR (INT)  $\neq 0$  if an error occurred

SERR (UINT) - slave error;  $\neq 0$  if ERR is 128

```
<<INSTANCE NAME>>:SCA_ERST(REQ := <<BOOL>>, AXIS :=
  <<USINT>>, DONE => <<BOOL>>, FAIL => <<BOOL>>, ERR =>
  <<INT>>, SERR => <<UINT>>);
```

The SCA\_ERST function block is used to reset internal E-errors and can close the loop on a servo SERCOS axis.

The REQ input is set to reset internal E-errors.

The AXIS input identifies the servo SERCOS axis.

The DONE output is set after the internal conditions to reset the E-errors are complete.

The FAIL output is set if an ERR occurs.

The ERR output will be  $\neq 0$  if an error occurred. See Table 2-11 on page 407 for a list of errors.

SERR output will be  $\neq 0$  if the ERR output is 128. See Table 2-12 on page 410 for a list of errors.

---



---

## SCA\_PBIT

SERCOS axis probe initialize

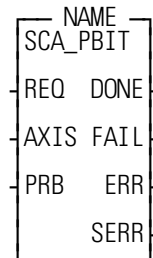
**Motion/MOVE\_SUP**

**Inputs:** REQ (BOOL) - executes function block (**one-shot**)  
 AXIS (USINT) - SERCOS axis number (servo or digitizing)  
 PRB (USINT) - SERCOS probe input direction

**Outputs:** DONE (BOOL) - function block complete  
 FAIL (BOOL) - function block failure  
 ERR (INT) - function block error  
 SERR (UINT) - SERCOS slave error

```
<<INSTANCE NAME>>:SCA_PBIT(REQ := <<BOOL>>, AXIS :=
<<USINT>>, PRB := <<USINT>>, DONE => <<BOOL>>, FAIL =>
<<BOOL>>, ERR => <<INT>>, SERR => <<UINT>>);
```

The SCA\_PBIT function block is used to initialize the SERCOS fast input. Before executing a REGIST, MEASURE, or FAST\_QUEUE function with a SERCOS axis, this function block must be called to initialize the SERCOS fast input. The SERCOS specification refers to the fast input as a “probe input”. Most SERCOS drive manufacturers provide two fast inputs: one for the SERCOS servo axis and one for the SERCOS digitizing axis. When executed, the SCA\_PBIT function block will communicate with the SERCOS drive to set up the drive’s fast input as requested by the PRB input.

The AXIS input identifies the SERCOS servo or digitizing axis.

The PRB input selects the probe input direction. Valid input values are:

### Value Description of when to capture the SERCOS fast input

- 0 No SERCOS fast input capture
- 1 On the positive edge only
- 2 On the negative edge only
- 3 On both edges, positive edge first
- 4 On both edges, negative edge first

The DONE output is set when the function block completes successfully.

The FAIL output is set if an error occurs.

The ERR output will return the error number if an error occurred. See Table 2-11 on page 407 for a list of errors.

SERR output will return the SERCOS slave error number if ERR = 128. See Table 2-12 on page 410 for a list of errors.

## SCA\_PBIT

**Note:** The SCA\_PBIT function block uses the SERCOS slave's real-time control bits and may also use the real-time status bits. Therefore, while SCA\_PBIT and the subsequent registration, measure, or fast queue operations are active, the ladder should NOT attempt to do any of the following:

- Assign IDN numbers to the real-time status bits.
- Assign IDN numbers to the real-time control bits.
- Modify the control bits.
- Modify any IDN related to the probe inputs.

**Note:** When programming two SCA\_PBIT function blocks, one for a SERCOS servo axis and another for a SERCOS digitizing axis on the same SERCOS drive, the execution of the two function blocks must not occur simultaneously. In other words, the execution of the second function block must not begin until the execution of the first function block is complete.



**SCA\_RCYC**

SERCOS axis read cyclic

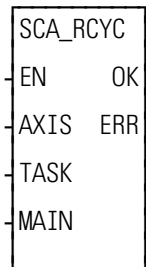
**Motion/DATA**

**Inputs:** EN (BOOL) - set to call function  
 AXIS (USINT) - identifies the servo SERCOS axis  
 TASK (STRUCT) - structure that accesses data elements within a servo task  
 MAIN (STRUCT) - structure that accesses data elements in the main ladder

**Outputs:** OK (BOOL) - set if read is allowed  
 ERR (INT) - ≠ 0 if error occurred

```
SCA_RCYC(Axis := <<USINT>>, Task := <<MEMORY AREA>>, OK =>
  <<BOOL>>, ERR => <<INT>>)
```

The SCA\_RCYC function allows you to read cyclic data between the ladder and the SERCOS hardware. It can be called either in a servo task or in the main ladder, but never in both. When used in a servo task, the function needs to be called once. When used in the main ladder, the function needs to be called continuously.

The STRUCT input at TASK and at MAIN must match the order and size of the list of IDNs selected for the AT in IDN16. (In SERCOS setup, it is possible to copy the IDN list to the clipboard from within the Define Cyclic Data dialog box and then paste it into the software declarations table.) The structure is labeled ILISTR and would have the following format:

```
ILISTR  STURCT
.IDN51  DINT
.IDN... (varies)
.IDN... (varies)
...n...
.SIZE   USINT
```

The **SIZE** member of the structure indicates the number of bytes in the AT cyclic data as well as the number of bytes in the structure less the **SIZE** byte. The **SIZE** will be compared with the size indicated on the SERCOS module and an error will be generated if they are not equal. This preserves the integrity of the data.

**Note:** Regardless of where this function is used (in a servo task or in the main ladder), you must enter the above structure at both the **TASK** input and the **MAIN** input. The structure name must be different for each one, but the members must be the same. Or you can make an array of structures entering a different array on each input.

When the function is initially called, the address of **TASK** is stored in servo data memory. During each servo update, the **TASK** structure is copied from the SERCOS module to data memory.

Every time the function is called, the information in the **TASK** structure is copied to the **MAIN** structure. There are internal checks that ensure the entire group of IDNs came from the same interrupt.

The **ERR** output will be  $\neq 0$  if an error occurred. See Table 2-11 on page 407 for a list of errors.

---



---

## SCA\_RECV

SERCOS axis receive

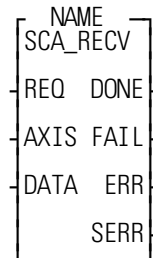
**Motion/DATA**

**Inputs:** REQ (BOOL) - request for receiving data (**one-shot**)  
 AXIS (USINT) - identifies the servo SERCOS axis  
 DATA (STRUC) - structure that sets up the format for the data received

**Outputs:** DONE (BOOL) - set when the data is received  
 FAIL (BOOL) - set if error occurred  
 ERR (INT) - ≠ 0 if receive error occurred  
 SERR (UINT) - slave error; ≠ 0 if ERR is 128

```
<<INSTANCE NAME>>:SCA_RECV(REQ := <<BOOL>>, AXIS :=
  <<USINT>>, DATA := <<MEMORY AREA>>, DONE => <<BOOL>>, FAIL
  => <<BOOL>>, ERR => <<INT>>, SERR => <<UINT>>);
```

The SCA\_RECV function block is used to receive information from the service channel section of the SERCOS communication.

The AXIS input identifies the servo SERCOS axis.

The DATA input is a structure with the following members:

Member	Type	Description
IDN	UINT	IDN value
IDTYPE	BYTE	0 = (S)ystem      1 = (P)roduct
ELEM	USINT	1 = Read procedure command status (SIZE = 1) 2 = Name string (SIZE = 3) 3 = Attribute (SIZE = 2) 4 = Units string (SIZE = 3) 5 = Minimum value (SIZE = 1 or 2) 6 = Maximum value (SIZE = 1 or 2) 7 = Operation data (SIZE = 1, 2, 3, or 4)  NOTE: When the SIZE is 3 or 4, a string must be provided at the STRARR member and the string size must be entered at the AVAIL member. If a 3 (attribute) is entered, the value will be put into the LDATA member DINT since the attribute is always a 4-byte value. If a 5 (minimum value) or 6 (maximum value) is entered, the data size must be the same as the operation data size above.
SIZE	UINT	1 = two bytes    2 = four bytes    3 = String    4 = Array
AVAIL	UINT	Quantity of bytes available in the array
ACTUAL	UINT	Quantity of bytes actually in the array
SDATA	UINT	Data received if 1 is entered in SIZE
LDATA	DINT	Data received if 2 is entered in SIZE
STRARR	STRING/ ARRAY	(Optional - only required if a 3 or 4 is entered in SIZE) Data received is a string if 3 is entered in SIZE or data received is an array if 4 is entered in SIZE

The DONE output is set after the internal conditions to receive are set.

The FAIL output is set if an ERR occurs.

The ERR output will be  $\neq 0$  if an error occurred. See Table 2-11 on page 407 for a list of errors.

SERR output will be  $\neq 0$  if the ERR output is 128. See Table 2-12 on page 410 for a list of errors.

**SCA\_REF**

SERCOS axis reference

**Motion/REF**

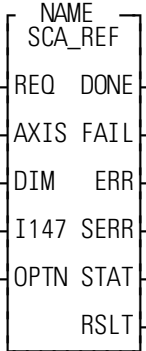

**Inputs:** REQ (BOOL) - request for reference cycle (**one-shot**)  
 AXIS (USINT) - identifies the servo SERCOS axis  
 DIM (DINT) - the value to assign to the index mark (feedback marker pulse) or the switch position  
 I147 (WORD) - bits for IDN147  
 OPTN (WORD) - 0 if IDN 147 is not sent; 1 if IDN 147 is sent.

**Outputs:** DONE (BOOL) - set when the reference cycle is complete  
 FAIL (BOOL) - set if an error occurred  
 ERR (INT) - 0 if no error occurred; ≠ 0 if a read error occurred  
 SERR (UINT) - slave error; ≠ 0 if ERR is 128  
 STAT (INT) - indicates which IDN is being sent or received  
 RSLT (DINT) - the commanded position after the reference is complete

```
<<INSTANCE NAME>>:SCA_REF(REQ := <<BOOL>>, AXIS := <<USINT>>,
  DIM := <<DINT>>, I147 := <<WORD>>, OPTN := <<WORD>>, DONE =>
  <<BOOL>>, FAIL => <<BOOL>>, ERR => <<INT>>, SERR => <<UINT>>,
  STAT => <<INT>>, RSLT => <<DINT>>);
```

The SCA\_REF function block is used to run a reference cycle on the servo SERCOS slave axis identified at the AXIS input.

The DIM input is the value assigned to the index mark or the reference switch position.

The I147 input holds the bits for IDN 147. Refer to the SERCOS specification for more information. Typically, bits 2, 3, and 4 are 101 respectively. The other bits depend on the application and the features offered by the drive.

The OPTN input determines whether IDN147 is sent during the reference cycle. For some drives, IDN 147 must be sent during phase 2. Set bit 0 of the option word to 1 if you are sending IDN 147 during the reference cycle. Set bit 0 of the option word to 0 if you are not sending IDN 147 during the reference cycle.

The DONE output is set when the reference cycle is complete. The SCA\_ACKR function must be called after the reference cycle is complete.

The FAIL output is set if there is an error.

The ERR output will be  $\neq 0$  if an error occurred. See Table 2-11 on page 407 for a list of errors.

SERR output will be  $\neq 0$  if the ERR output is 128. See Table 2-12 on page 410 for a list of errors.

The STAT output indicates which IDN is being sent or received. It is used only for troubleshooting failure conditions. See the chart below.

<b>STAT#</b>	<b>IDN</b>
<b>1</b>	Sending IDN 147 - option bits
<b>2</b>	Sending IDN 52 - reference position
<b>3</b>	Sending IDN 148 - start reference
<b>4</b>	Receiving IDN 148 - reference started?
<b>5</b>	Receiving IDN 403 - reference done?
<b>6</b>	Receiving IDN 47 - position?
<b>0</b>	Reference complete

The RSLT output gives the commanded position for your information after the reference is complete.

**Note:** This function block cannot be called while the axis is in Resume Mode or if Resumable E\_Stop Allow (READ\_SV/WRITE\_SV variable 63) is set. Also, do not turn on Resumable E\_Stop Allow while a SERCOS axis reference is executing.

---



---

## SCA\_RFIT

SERCOS axis reference initialize

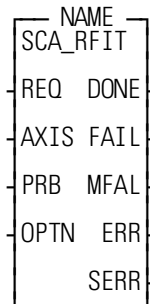
**Motion/REF**

**Inputs:** REQ (BOOL) - executes function block (**one-shot**)  
 AXIS (USINT) - SERCOS axis number (servo or digitizing)  
 PRB (USINT) - selects SERCOS probe input direction  
 OPTN (WORD) - reference options

**Outputs:** DONE (BOOL) - initialization is complete  
 FAIL (BOOL) - initialization failure  
 MFAL (BOOL) - monitor failure  
 ERR (INT) - SERCOS error  
 SERR (UINT) - SERCOS slave error

```
<<INSTANCE NAME>>:SCA_RFIT(REQ := <<BOOL>>, AXIS :=
  <<USINT>>, PRB := <<USINT>>, OPTN := <<WORD>>, DONE =>
  <<BOOL>>, FAIL => <<BOOL>>, MFAL => <<BOOL>>, ERR => <<INT>>,
  SERR => <<UINT>>);
```

The SCA\_RFIT function block must be executed before calling a FAST\_REF or LAD\_REF function. The function block performs two functions:

1. When the REQ input is energized, it initializes the SERCOS drive's fast input (referred to as a probe input in the SERCOS specification) and index mark detection as requested by the PRB and OPTN inputs.
2. After the DONE output is set and after the FAST\_REF or LAD\_REF function has begun, it continually communicates with the SERCOS drive to monitor the occurrence of the reference switch or index mark and then reads the latched position from the drive. Because of this monitoring feature, the SCA\_RFIT function block must be scanned every ladder scan while the reference cycle is active. Never program a jump around this function block.

The AXIS input specifies the SERCOS servo or digitizing axis.

The PRB input selects the probe input direction. Valid input values are:

Value	Description
0	Do not capture the axis position with SERCOS probe input
1	Capture the axis position on the SERCOS probe input positive edge
2	Capture the axis position on the SERCOS probe input negative edge

The OPTN input provides the following options:

Bit	Description
0	Ignore index (binary value = 0000 0000 0000 0001)
1	Reserved
2	Abort (binary value = 0000 0000 0000 0100)
3 - 15	Reserved

Setting bit 0 will cause the SERCOS drive to capture the axis position at the reference switch. Leaving bit 0 reset will cause the SERCOS drive to capture the axis position at the first occurrence of the index mark after the reference switch.

**Note:** The state of bit 0 (set or reset) must match the state of bit 0 of the OPTN input of the FAST\_REF or LAD\_REF function.

**IMPORTANT:** If the SERCOS drive is not a G&L Motion Control Centurion drive, bit 0 must be set. Currently, only the G&L Motion Control Centurion drives support capturing the axis position at the first occurrence of the index mark after the reference switch.

Setting bit 2 will abort SCA\_RFIT. If called while initializing (i.e. before DONE or FAIL are set), the FAIL output will be set and the ERR output will return 39 “Function block aborted by user”. If called while monitoring for the reference event (i.e. after DONE is set), the MFAL output will be set, the ERR output will return 39 “Function block aborted by user”, and the reference will be aborted.

The DONE output is set when the initialization phase completes successfully. It is then OK to execute the FAST\_REF or LAD\_REF function.

The FAIL output is set if an error occurs during the initialization phase.

The MFAL output is set if an error occurs during the monitoring phase. If MFAL is set, the reference will be aborted. The ERR output will return the error number if an error occurred during either the initialization phase or the monitoring phase.

The SERR output will return the SERCOS slave error number if ERR = 128.

**Note:** The SCA\_RFIT function block uses the SERCOS slave’s real-time control bits. Therefore, while the SCA\_RFIT function block and the subsequent fast reference or ladder reference operations are active, the ladder should not attempt to:

1. Assign IDN numbers to the real-time controls bits.
2. Modify the real-time controls bits.
3. Modify any IDN related to the probe inputs.

**Note:** When programming two SCA\_RFIT function blocks, one for a SERCOS servo axis and another for a SERCOS digitizing axis on the same SERCOS drive, the execution of the two function blocks must not occur simultaneously. In other words, the execution of the second function block must not begin until the execution of the first function block is complete.



**Note:** If the MEASURE function is active when SCA\_RFIT is called with PRB not equal to zero or OPTN equal to zero, the MEASURE function will be turned off. To reactivate the MEASURE function, call it after the reference is complete.

---



---

## SCA\_SEND

SERCOS axis send

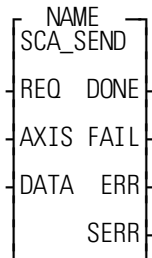
**Motion/DATA**

**Inputs:** REQ (BOOL) - request to send data (**one-shot**)  
 AXIS (USINT) - identifies the servo SERCOS axis  
 DATA (STRUC) - structure that sets up the format for the data sent

**Outputs:** DONE (BOOL) - set when the send is complete  
 FAIL (BOOL) - set if an error occurred  
 ERR (INT) - 0 if no error occurred;  $\neq 0$  if a send error occurred  
 SERR (UINT) - slave error;  $\neq 0$  if ERR is 128

```
<<INSTANCE NAME>>:SCA_SEND(REQ := <<BOOL>>, AXIS :=
  <<USINT>>, DATA := <<MEMORY AREA>>, DONE => <<BOOL>>, FAIL
  => <<BOOL>>, ERR => <<INT>>), SERR => <<UINT>>);
```

The SCA\_SEND function block is used to send information to the service channel section of the SERCOS communication.

The AXIS input identifies the servo SERCOS axis.

The DATA input is a structure with the following members:

Member	Type	Description
IDN	UINT	IDN value
IDTYPE	BYTE	0 = (S)ystem                                      1 = (P)roduct
ELEM	USINT	2 = Name string (SIZE = 3) 3 = Attribute (SIZE = 2) 4 = Units string (SIZE = 3) 5 = Minimum value (SIZE = 1 or 2) 6 = Maximum value (SIZE = 1 or 2) 7 = Operation data (SIZE = 1, 2, 3, or 4)  NOTE: When the SIZE is 3 or 4, a string must be provided at the STRARR member and the string size must be entered at the AVAIL member. If a 3 (attribute) is entered, the value will be put into the LDATA member DINT since the attribute is always a 4-byte value. If a 5 (minimum value) or 6 (maximum value) is entered, the data size must be the same as the operation data size above.
SIZE	UINT	1 = two byte    2 = four byte    3 = String    4 = Array
AVAIL	UINT	Quantity of bytes available in the array
ACTUAL	UINT	Quantity of bytes actually in the array
SDATA	UINT	Data to be sent if 1 is entered in SIZE
LDATA	DINT	Data to be sent if 2 is entered in SIZE
STRARR	STRING/ARRAY	(Optional - only required if a 3 or 4 is entered in SIZE) Data received is a string if 3 is entered in SIZE or data received is an array if 4 is entered in SIZE

**NOTE:** The same structure members are used for the SCA\_RECV and the SCA\_SEND function blocks.

The DONE output is set after the internal conditions to send are set.

The FAIL output is set if an error occurs.

The ERR output will be  $\neq 0$  if an error occurred. See Table 2-11 on page 407 for a list of errors.

SERR output will be  $\neq 0$  if the ERR output is 128. See Table 2-12 on page 410 for a list of errors.

---

---

**SCA\_STAT**

SERCOS axis status

**Motion/DATA**

---

---

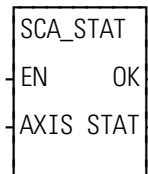
**Inputs:** EN (BOOL) - set to read

AXIS (USINT) - identifies the SERCOS axis

**Outputs:** OK (BOOL) - set if read is allowed

STAT (WORD) - the status word of the most recent AT info

SCA\_STAT(AXIS := <<USINT>>, OK => <<BOOL>>, STAT => <<WORD>>)

The SCA\_STAT function is used for monitoring the ready-to-operate drive mode, for diagnostic troubleshooting, or for monitoring the two real-time status bits returned from the drive. For the definition of the bit assignments to the AT status word, consult the SERCOS specification.

**SCA\_WCYC**

SERCOS axis write cyclic

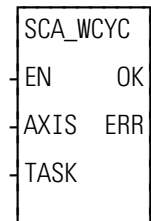
**Motion/DATA**

**Inputs:** EN (BOOL) - set to call function (**one-shotted**)  
 AXIS (USINT) - identifies the servo SERCOS axis  
 TASK (STRUCT) - structure that accesses data elements within a servo task

**Outputs:** OK (BOOL) - set if read is allowed  
 ERR (INT) -  $\neq 0$  if error occurred

SCA\_WCYC(AXIS := <<USINT>>, TASK => <<MEMORY AREA>>, OK => <<BOOL>>, ERR => <<INT>>)

The SCA\_WCYC function allows you to write cyclic data between the ladder and the SERCOS hardware. It is called once and may only be used in a servo task.

The STRUCT input at TASK must match the order and size of the list of IDNs selected for the MDT in IDN24. (In SERCOS setup, it is possible to copy the IDN list to the clipboard from within the Define Cyclic Data dialog box and then paste it into the software declaration table.) The structure would have the following format:

```

ILISTW  STRUCT
.IDN47  DINT
.IDN... (varies)
.IDN... (varies)
...n...
.SIZE   USINT
  
```

The SIZE member of the structure indicates the number of bytes in the MDT cyclic data as well as the number of bytes in the structure less the SIZE byte. The SIZE will be compared with the size indicated on the SERCOS module and an error will be generated if they are not equal. This preserves the integrity of the data.

When the function is initially called, the address of TASK is stored in servo data memory. During each servo update, the TASK structure is copied from data memory to the SERCOS module.

The ERR output will be  $\neq 0$  if an error occurred. See Table 2-11 on page 407 for a list of errors.

---



---

## SCR\_CONT

SERCOS ring continue

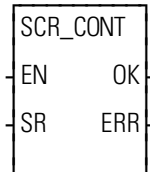
**Motion/SERC\_SYS**

**Inputs:** EN (BOOL) - enables execution (**one-shot**)  
 SR (STRUCT) -structure that identifies the SERCOS ring affected

**Outputs:** OK (BOOL) -set if continuation is allowed  
 ERR (USINT) - 0 if OK is set; ≠ 0 if an error occurs

SCR\_CONT(SR := <<MEMORY AREA>>, OK => <<BOOL>>, ERR => <<USINT>>)

If you have chosen in SERCOS setup to pause SERCOS communication of this ring after phase 2 in order to send additional IDN numbers, use the SCR\_CONT function to continue through phase 4.

The SR input is a structure consisting of the following members which identify the SERCOS axis:

SLOT (UINT)  
 RING (UINT)

The ERR output will be ≠ 0 if an error occurred. See Table 2-11 on page 407 for a list of errors.

**SCR\_ERR**

SERCOS ring error

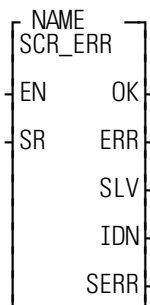
**Motion/SERC\_SYS****Inputs:** EN (BOOL) - set to read errors

SR (STRUCT) - structure that identifies the SERCOS ring

**Outputs:** OK (BOOL) - set if the SR input is validERR (INT) - 0 if there is no error;  $\neq 0$  if an error occurs

SLV (UINT) - identifies slave 1 - 8 if ERR = 128, 136, or 144

IDN (UINT) - indicates the most recent IDN read or written if ERR = 128 or 144

SERR (UINT) - slave error;  $\neq 0$  if ERR is 128NOTE: SLV, IDN, and SERR are valid only if ERR  $\neq 0$ .

```
<<INSTANCE NAME>>:SCR_ERR(EN := <<BOOL>>, SR := <<MEMORY AREA>>, OK => <<BOOL>>, ERR => <<INT>>, SLV => <<UINT>>, IDN => <<UINT>>, SERR => <<UINT>>);
```

The SCR\_ERR function block identifies ring errors that can occur during the transfer of IDNs. It can also represent a hardware failure such as a break in the fiber optic cable or a failure during initialization. In addition, it can supply some information as to what is happening before the error occurred. See the background information at the end of this description.

The SR input is a structure consisting of the following members which identify the SERCOS ring:

SLOT	(UINT)
RING	(UINT)

The ERR output will be  $\neq 0$  if an error occurred. See Table 2-11 on page 407 for a list of errors.

**Note:** You must always return to phase 0 and reinitialize the SERCOS ring after a ring error occurs.

## SCR\_ERR

The SLV output is valid only if the ERR output equals 128, 136, or 144. Then it can be helpful in identifying which slave (1 - 8) has the problem.

The IDN output is valid only if the ERR output equals 128 or 144. Then it indicates the most recent IDN read or written.

SERR output will be  $\neq 0$  if the ERR output is 128. See Table 2-12 on page 410 for a list of errors.

### Background Information on Using SCR\_ERR for Diagnostics

If the SCR\_PHAS function does not return a “4” at the PHAS output within a few seconds of calling SC\_START, looking at the outputs of the SCR\_ERR function block will be helpful to diagnose problems that may have occurred. (Remember that you may have chosen to pause at phase 2.)

If a ring error occurs during the initialization through the phases, the SCR\_ERR function block outputs show the most recent IDN number and the slave to which it was sent or received. If the slave returned an error due to an IDN transfer, this error number defined by the slave manufacturer can be read at the SERR output. This information in addition to knowing the sequence of the IDN send and receive activity will aid in diagnosing the initialization failure. This activity is described below.

#### Phase 0

During phase 0 a test is performed to determine if a communication telegram is able to make it all the way around the ring. If it can, the fiber optic ring is complete and all slaves are turned on. If it cannot, error 20 will occur.

#### Phase 1

Each slave is individually addressed and a response is expected. If the address switches on the drive are not set correctly, it will not respond when addressed by the PiC. If a slave does not respond, error 136 occurs and the number of the unresponsive slave will appear at the SLV output. When phase 1 is completed, all the drives are addressed properly.

#### Phase 2

Several IDNs are read, calculations are made and several IDNs are written for each slave on the ring. If a slave cannot respond with data due to an IDN read or does not accept IDN data from an IDN write, error 128 will occur and the most recent IDN and slave read or written will appear at the IDN and SLV output. If an error occurs, no more IDNs are read or written to any slave. The order in which the IDNs are read and written are:

**For each slave in numerical order:**

Read the following IDNs: 3, 4, 5, 88, 90, and 96.

Timing calculations are done based on this read information.



**For each slave in numerical order:**

Write the following IDNs: 1, 2, 6, 89, 8, 7, 9, 10, 15, and 32.

**Note:** IDN 32 is not sent if telegram type of IDN 15 is 0 or 7.

**For each slave:**

The IDNs in the SERCOS setup list are written.

**For each slave:**

IDNs 99 and 127 are written.

If pause after phase 2 was set, IDNs are transferred as requested by the ladder. If phase 2 is complete, all timing is calculated, all configuration IDNs have been written and accepted by the slaves.

**Phase 3****For each slave:**

IDN 128 is written. **Note:** Phase 3 is a brief preparation for phase 4.

**Phase 4**

All initializing operations are complete.

The SERR output will be  $\neq 0$  if the ERR output is 128. See Table 2-12 on page 410 for a list of errors.

---



---

## SCR\_PHAS

SERCOS ring phase

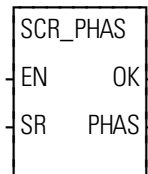
**Motion/SERC\_SYS**

**Inputs:** EN (BOOL) - set to call function  
 SR (STRUC) -structure that identifies SERCOS ring

**Outputs:** OK (BOOL) -set if phase number is returned  
 PHAS (USINT) - highest phase number completed

```
SCR_PHAS(SR := <<MEMORY AREA>>, OK => <<BOOL>>, PHAS =>
  <<USINT>>)
```

The SCR\_PHAS function identifies the completed phase (0 - 4).

The SR input is a structure consisting of the following members which identify the SERCOS ring:

```
SLOT  (UINT)
RING  (UINT)
```

The OK output will remain clear until phase 0 has begun.

The PHAS output gives the highest phase (0 - 4) completed by the SERCOS ring identified at the SR input.

**SCS\_ACKR**

SERCOS slave acknowledge reference

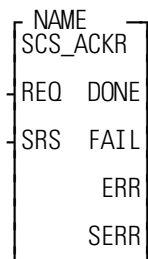
**Motion/SERC\_SLV**

**Inputs:** REQ (BOOL) - set to acknowledge the reference cycle (**one-shot**)

SRS (STRUC) - structure that identifies SERCOS slave

**Outputs:** DONE (BOOL) - set when the write is complete

FAIL (BOOL) - set if an error occurred

ERR (INT)  $\neq 0$  if a read error occurred

SERR (UINT) - slave error;  $\neq 0$  if ERR is 128

```
<<INSTANCE NAME>>:SCS_ACKR(REQ := <<BOOL>>, SRS := <<MEM-
  ORY AREA>>, DONE => <<BOOL>>, FAIL => <<BOOL>>, ERR =>
  <<INT>>, SERR => <<UINT>>);
```

The SCS\_ACKR function block acknowledges the reference cycle. It sends IDN 148 with a value of zero.

**CAUTION**

You must write the newly referenced value (using the SCS\_SEND or WRITE\_SV function) that is returned from the SCS\_REF function *before* calling this function block.

The drive will again be controlled by the SERCOS master (the PiC) after this function block is called.

The SRS input is a structure consisting of the following members which identify the SERCOS axis:

SLOT (UINT)  
RING (UINT)  
SLAVE (UINT)

The DONE output is set after the internal conditions to acknowledge the reference are set.

The FAIL output is set if an ERR occurs.

The ERR output will be  $\neq 0$  if an error occurred. See Table 2-11 on page 407 for a list of errors.

The SERR output will be  $\neq 0$  if the ERR output is 128. See Table 2-12 on page 410 for a list of errors.

**SCS\_CTRL**

SERCOS slave control

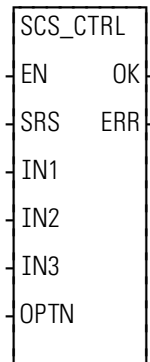
**Motion/SERC\_SLV**

**Inputs:** EN (BOOL) - set to call function  
 SRS (STRUC ) - structure that identifies SERCOS slave  
 IN1 (BOOL) - used to set the appropriate control word bit  
 IN2 (BOOL) - used to set the appropriate control word bit  
 IN3 (BOOL) - used to set the appropriate control word bit  
 OPTN (USINT) - defines which control word bits are affected by IN1-3

**Outputs:** OK (BOOL) - set if write is allowed  
 ERR (INT) - ≠ 0 if error occurred

```
SCS_CTRL(SRS := <<MEMORY AREA>>, IN1 := <<BOOL>>, IN2 :=
  <<BOOL>>, IN3 := <<BOOL>>, OPTN := <<USINT>>, OK => <<BOOL>>,
  ERR => <<INT>>)
```

The SCS\_CTRL function is used to control bits 6 - 9, bit 11, and bits 13 - 15 of the MDT control word. Refer to the SERCOS specification for the definitions of the MDT control word.

Typically, bits 13 - 15 are all set to 1 to enable the drive. Bits 8 and 9 define the operation mode. They are normally set to zero which is the default.

Bits 6 and 7 define the real time control bits. The SERCOS specification and your drive manual define the purpose of these bits. Typically, bits 6 and 7 are left at zero.

The SRS input is a structure consisting of the following members which identify the SERCOS axis:

```
SLOT   (UINT)
RING   (UINT)
SLAVE  (UINT)
```

The table below illustrates how the IN and OPTN inputs are used.

If the OPTN Input is:	Then	is control word bit	Description
0*	IN1	13	Halt/restart drive
	IN2	14	Enable drive
	IN3	15	Drive on/off
1	IN1	8	The chart below summarizes the mode options for IN1, IN2 and IN3 when OPTN 1 is chosen. Typically, primary operation is used
	IN2	9	
	IN3	11	
			<b>Bits</b>
			<b>11    9    8    Description</b>
			0    0    0    Primary operation mode (IDN 32)
			0    0    1    Secondary operation mode 1 (IDN 33)
			0    1    0    Secondary operation mode 2 (IDN 34)
			0    1    1    Secondary operation mode 3 (IDN 35)
			1    0    0    Secondary operation mode 4 (IDN 284)
			1    0    1    Secondary operation mode 5 (IDN 285)
			1    1    0    Secondary operation mode 6 (IDN 286)
			1    1    1    Secondary operation mode 7 (IDN 287)
2	IN1	6	Real time control bit 1
	IN2	not used	
	IN3	not used	
3	IN1	7	Real time control bit 2
	IN2	not used	
	IN3	not used	

\* If the SERCOS slave is being controlled by the functions in Motion.lib, the SCA\_CLOS and OPENLOOP functions will control these bits and SCS\_CTRL must not be called with option 0 or 1. **Note:** All bits default to zero. The ERR output will be  $\neq 0$  if an error occurred. See Table 2-11 on page 407 for a list of errors.

---

---

**SCS\_RECV**

SERCOS slave receive

**Motion/SERC\_SLV**

---

---

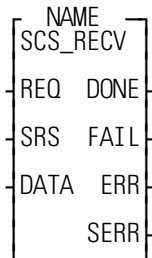

**Inputs:** REQ (BOOL) - request for receiving data (**one-shot**)  
 SRS (STRUCT) - structure that identifies the SERCOS slave  
 DATA (STRUCT) - structure that sets up the format for the data received

**Outputs:** DONE (BOOL) - set when data received  
 FAIL (BOOL) - set if error occurred  
 ERR (INT) -  $\neq 0$  if receive error occurred  
 SERR (UINT) - slave error,  $\neq 0$  if ERR = 128

```
<<INSTANCE NAME>>:SCS_RECV(REQ := <<BOOL>>, SRS := <<MEMORY AREA>>, DATA := <<MEMORY AREA>>, DONE => <<BOOL>>, FAIL => <<BOOL>>, ERR => <<INT>>, SERR => <<UINT>>);
```

The SCS\_RECV function block is used to receive information from the service channel section of the SERCOS communication.

The SRS input is a structure consisting of the following members which identify the SERCOS axis:

```
SLOT   (UINT)
RING   (UINT)
SLAVE  (UINT)
```

The DATA input is a structure with the following members:

Member	Type	Description
IDN	UINT	IDN value
IDTYPE	BYTE	0 = (S)ystem                      1 = (P)roduct
ELEM	USINT	1 = Read procedure command status (SIZE = 1) 2 = Name string (SIZE = 3) 3 = Attribute (SIZE = 2) 4 = Units string (SIZE = 3) 5 = Minimum value (SIZE = 1 or 2) 6 = Maximum value (SIZE = 1 or 2) 7 = Operation data (SIZE = 1, 2, 3, or 4)  NOTE: When the SIZE is 3 or 4, a string must be provided at the STRARR member and the string size must be entered at the AVAIL member. If a 3 (attribute) is entered, the value will be put into the LDATA member DINT since the attribute is always a 4-byte value. If a 5 (minimum value) or 6 (maximum value) is entered, the data size must be the same as the operation data size above.
SIZE	UINT	1 = two bytes    2= four bytes    3 = String    4 = Array
AVAIL	UINT	Quantity of bytes available in the array
ACTUAL	UINT	Quantity of bytes actually in the array
SDATA	UINT	Data received if 1 is entered in SIZE
LDATA	DINT	Data received if 2 is entered in SIZE
STRARR	STRING/ ARRAY	(Optional - only required if a 3 or 4 is entered in SIZE) Data received is a string if 3 is entered in SIZE or data received is an array if 4 is entered in SIZE

The DONE output is set after the internal conditions to receive are complete.

The FAIL output is set if an ERR occurs.

The ERR output will be  $\neq 0$  if an error occurred. See Table 2-11 on page 407 for a list of errors.

The SERR output will be  $\neq 0$  if the ERR output is 128. See Table 2-12 on page 410 for a list of errors.

---

---

**SCS\_REF**

SERCOS slave reference

**Motion/SERC\_SLV**

---

---

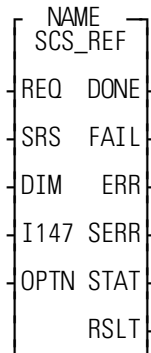

**Inputs:** REQ (BOOL) - request for reference cycle (**one-shot**)  
 SRS (STRUC) - identifies the servo SERCOS slave  
 DIM (DINT) - the value to assign to the index mark (feedback marker pulse) or the switch position  
 I147 (WORD) - bits for IDN147  
 OPTN (WORD) - 0 if IDN 147 is not sent; 1 if IDN 147 is sent.

**Outputs:** DONE (BOOL) - set when the reference cycle is complete  
 FAIL (BOOL) - set if an error occurred  
 ERR (INT) - 0 if no error occurred; ≠ 0 if a read error occurred  
 SERR (UINT) - slave error; ≠ 0 if ERR is 128  
 STAT (INT) - indicates which IDN is being sent or received  
 RSLT (DINT) - the commanded position after the reference is complete NOTE: This value must be sent to the slave *before* the SCS\_ACKR function block is called.

```
<<INSTANCE NAME>>:SCS_REF(REQ := <<BOOL>>, SRS := <<MEMORY AREA>>, DIM := <<DINT>>, I147 := <<WORD>>, OPTN := <<WORD>>, DONE => <<BOOL>>, FAIL => <<BOOL>>, ERR => <<INT>>, SERR => <<UINT>>, STAT => <<INT>>, RSLT => <<DINT>>);
```

The SCS\_REF function block is used to run a reference cycle on the non-servo SERCOS slave axis identified at the SRS input.

The SRS input is a structure consisting of the following members which identify the SERCOS axis:

SLOT (UINT)  
 RING (UINT)  
 SLAVE (UINT)



The DIM input is the value assigned to the index mark or the reference switch Position.

The I147 input holds the bits for IDN 147. Refer to the SERCOS specification for more information. Typically, bits 2, 3, and 4 are 101 respectively. The other bits depend on the application and the features offered by the drive.

The OPTN input determines whether IDN147 is sent during the reference cycle. For some drives, IDN 147 must be sent during phase 2. Set bit 0 of the option word to 1 if you are sending IDN 147 during the reference cycle. Set bit 0 of the option word to 0 if you are not sending IDN 147 during the reference cycle.

The DONE output is set when the reference cycle is complete. The SCS\_ACKR function must be called after the reference cycle is complete.

The ERR output will be  $\neq 0$  if an error occurred. See Table 2-11 on page 407 for a list of errors.

The SERR output will be  $\neq 0$  if the ERR output is 128. See Table 2-12 on page 410 for a list of errors.

The STAT output indicates which IDN is being sent or received. It is used only for troubleshooting failure conditions. See the chart below.

STAT#	IDN
1	Sending IDN 147 - option bits
2	Sending IDN 52 - reference position
3	Sending IDN 148 - start reference
4	Receiving IDN 148 - reference started?
5	Receiving IDN 403 - reference done?
6	Receiving IDN 47 - position?
0	Reference complete

The RSLT output gives the commanded position after the reference is complete. If the ladder is using the SCS\_SEND function to write the drive position, this new value must be used prior to calling the SCS\_ACKR function.

---

---

**SCS\_SEND**

SERCOS slave send

**Motion/SERC\_SLV**

---

---

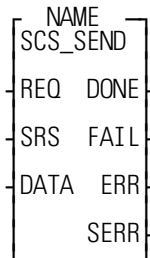

**Inputs:** REQ (BOOL) - request to send data (**one-shot**)

SRS (STRUCT) - structure that identifies the SERCOS slave

DATA (STRUCT) - structure that sets up the format for the data sent

**Outputs:** DONE (BOOL) - set when the send is complete

FAIL (BOOL) - set if an error occurred

ERR (INT) - 0 if no error occurred;  $\neq 0$  if a send error occurred

SERR (UINT) - slave error,  $\neq 0$  if ERR = 128

```
<<INSTANCE NAME>>:SCS_SEND(REQ := <<BOOL>>, SRS := <<MEMORY AREA>>, DATA := <<MEMORY AREA>>, DONE => <<BOOL>>, FAIL => <<BOOL>>, ERR => <<INT>>, SERR => <<UINT>>);
```

The SCS\_SEND function block is used to send information to the service channel section of the SERCOS communication.

The SRS input is a structure consisting of the following members which identify the SERCOS axis:

```
SLOT    (UINT)
RING    (UINT)
SLAVE   (UINT)
```



---

---

**SCS\_STAT**

SERCOS slave status

**Motion/SERC\_SLV**

---

---

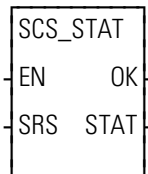

**Inputs:** EN (BOOL) - set to read  
 SRS (STRUC ) - structure that identifies the SERCOS slave

**Outputs:** OK (BOOL) - set if read is allowed  
 STAT (WORD) - the status word of the most recent AT info

SCS\_STAT(SRS := <<MEMORY AREA>>, OK => <<BOOL>>, STAT => <<WORD>>)

The SCS\_STAT function is used for monitoring the ready-to-operate drive mode, for diagnostic troubleshooting, or for monitoring the two real-time status bits returned from the drive. For the definition of the bit assignments to the AT status word, consult the SERCOS specification.

The SRS input is a structure consisting of the following members which identify the SERCOS axis:

SLOT (UINT)  
 RING (UINT)  
 SLAVE (UINT)

**SERCOS Errors**

The errors listed in Table 2-11 can appear at the ERR output of certain SERCOS functions/function blocks described in the preceding section.

**Table 2-11 List of ERR Errors**

<b>ERR #</b>	<b>Description</b>
0	No error
1	IDN queue was busy when called or the amount of dynamic memory currently available on the SERCOS board is not enough to accommodate the size specified in .AVAIL..
2	The quantity specified in the .AVAIL structure member is not large enough for the received data. The actual size of the received data is returned in the .ACTUAL structure member. This error is reported by the SERCOS firmware.
3	Axis is not initialized, is not a SERCOS axis, or the slot/ring/slave specification is incorrect.
4	Invalid data in DATA input structure
5	Error reset function could not be completed.
6	SERCOS ring 1 busy*
7	SERCOS ring 2 busy*
8	SERCOS ring 1 configuration size error**
9	SERCOS ring 2 configuration size error**
10	Function block enabled while already in process
11	Bit 3 or bit 8 set in the procedure command acknowledgment (data status) Either operation data invalid or procedure command error
12	Not enough pool memory available
13	Change bit in status word was zero after reference complete.
14	The IDN queue was cleared during an IDN transfer, typically caused by calling the SC_INIT function while an IDN is being read or written.
15	SERCOS module is unavailable for IDN transfer because the phase-to-phase transition in progress is between phase 2 and phase 4.
16	Slave response timed out
17	The SERCOS module did not receive an expected AT response. SERCOS cable may be disconnected.
18	Number of SERCOS slots or slaves is invalid.
19	The SERCOS module did not receive an expected MDT response. SERCOS cable may be disconnected.
20	Phase 0 detected that the ring is not complete. The optic cable could be open or drive turned off.
21	The SERCOS module firmware is outdated for the features requested from a newer version of the motion library.
22	The SERCOS module firmware is a newer version and the motion library is outdated and unable to interface.

**SCS\_STAT**

23	The version of PiCPro used to create the SERCOS setup data is outdated for the features requested from the library or the SERCOS module firmware.
24	The version of PiCPro used to create the SERCOS setup data is a newer version and the library is unable to interface.
25	A two-ring SERCOS module was specified in SERCOS setup but the module is a one-ring SERCOS module.
26	Invalid PRB input on the SCA_PBIT or SCA_RFIT function blocks or invalid OPTN input on the SCA_RFIT function block.
27	The SERCOS setup data was configured for a different CPU (PiC, MMC, or MMC for PC).
28	The SERCOS ring is not currently halted in phase 2. SERCOS Setup may not have specified "Pause after Phase 2".
29	The axis is in Resume Mode or Resumable E-EStop Allow (READ_SV/ WRITE_SV Variable 63) is set.
30	The drive status word (bit 13=1) indicates an error.
31	An E-stop condition exists for this axis in the PiC900.
32	Incorrect phase number, contact G&L Motion Control.
33	Incorrect address error, contact G&L Motion Control.
34	Incorrect AT number error, contact G&L Motion Control.
35	Variable 48 is set to 1 and you attempt to close the loop
36	OPTN input is invalid.
37	The quantity specified in the .AVAIL structure member is not large enough for the received data. The actual size of the received data is returned in the .ACTUAL structure member. This error is reported by the motion library software.
38	Open loop was requested while SCA_CLOS was in progress.
39	Function block aborted by user
48	Service channel not ready when attempt to send/receive non-cyclic data
49	No data to send or receive
50	The value of the .SIZE member of the TASK input structure does not match the byte count in the SERCOS module.
51	The value of the .SIZE member of the MAIN input structure does not match the byte count in the SERCOS module.
65	Error occurred calculating when MDT should occur.
66	Error occurred calculating when drive data valid.
67	Error occurred calculating when feedback data valid.
68	Error occurred calculating total time required for communication cycle.
69	Error occurred calculating cyclic data memory for SERCON processor.
70	Error occurred calculating cyclic data memory for internal memory map.
71	Error occurred calculating service channel memory map.
72	Incorrect ring error, contact G&L Motion Control.
73	Incorrect AT count error, contact G&L Motion Control.

74	CPU on SERCOS module has too many tasks during update.
128	Slave error occurred. Read SERR output to identify error. The SLV output indicates the slave number.
136	Slave will not respond in phase 1. The SLV output indicates the slave number.
144	Procedure command error - The slave number can be viewed at the SLV output and the IDN number at the IDN output.
152	CRC error. The bit pattern received by the SERCOS receiver is corrupted.

\*This busy error may occur if the SC\_INIT function is not one-shotted and a second store operation is attempted before the first one is done.

\*\*This size error will occur if too many IDNs are defined in the SERCOS setup data.

The errors listed in Table 2-12 can appear at the SERR output of certain SERCOS functions/function blocks described in the preceding section.

**Table 2-12 List of SERR Errors**

<b>SERR #</b>	<b>Description</b>
4097	This IDN does not exist.
4105	The data for this IDN may not be accessed.
8193	The name does not exist
8194	The name transmission is too short
8195	The name transmission is too long
8196	The name may not be changed
8197	The name is write-protected
12290	The attribute transmission is too short
12291	The attribute transmission is too long
12292	The attribute may not be changed
12293	The attribute is write-protected at this time
16385	The units do not exist
16386	The units transmission is too short
16387	The units transmission is too long
16388	The units may not be changed
16389	The units are write-protected at this time
20481	The minimum value does not exist
20482	The minimum value transmission is too short
20483	The minimum value transmission is too long
20484	The minimum value may not be changed
20485	The minimum value is write-protected
24577	The maximum value does not exist
24578	The maximum value transmission is too short
24579	The maximum value transmission is too long
24580	The maximum value may not be changed
24581	The maximum value is write-protected
28674	The data is too short.
28675	The data is too long
28676	The data may not be changed.
28677	The data is write-protected at this time.
28678	The data is smaller than the minimum value.
28679	The data is larger than the maximum value.
28680	The bit pattern for this IDN is invalid.



---



---

**SCURVE**

S Curve

Motion/MOVE\_SUP

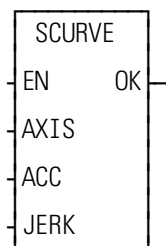

**Inputs:** EN (BOOL) - enables execution (**One-shot**)  
 AXIS (USINT) - the time axis (range 25 to 28)  
 ACC (LREAL) - the maximum acceleration rate in counts/min<sup>2</sup>  
 JERK(LREAL) - the constant jerk in counts/min<sup>3</sup>

**Outputs:** OK (BOOL) - execution complete without errors

SCURVE(AXIS := <<USINT>>, ACC := <<LREAL>>, JERK := <<LREAL>>, OK => <<BOOL>>)

**NOTE:** A math coprocessor is required to use the SCURVE function.

The SCURVE function allows a master time axis to follow an s-curve velocity profile instead of a trapezoidal velocity profile as shown below. In the typical trapezoidal profile, there will be jerks (shown by arrows below) when motion starts and accelerates, when the commanded velocity is reached, when deceleration begins, and when deceleration ends. These jerks can be suppressed by using an s-curve profile which smooths out the acceleration and deceleration.

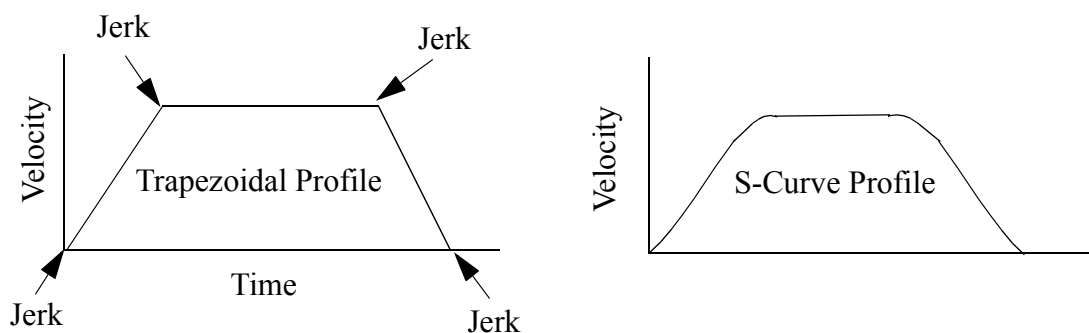

## SCURVE

You create an s-curve profile by defining a maximum acceleration rate (ACC) and a constant jerk rate (J) for a master time axis in the SCURVE function. (See the Notes that follow.) Then you can use the DISTANCE, POSITION, or VEL\_STR/VEL\_END functions to move a distance, reach an endpoint, or follow a velocity.

Two other functions can be used with the SCURVE function. The IN\_POS? function is used to indicate when the distance or position move is complete. The NEWRATE function is used to change the velocity of the time axis while it is moving.

The command velocity (variable 6) can be read with the READ\_SV function. This value is given in counts/sec. It will read the velocity command due to the s-curve profile. When the axis is accelerating or decelerating, the value will be different than the value commanded. NOTE: Do not write a command velocity with variable 6 when a non-zero value is entered in the ACC and JERK inputs.

You can turn the s-curve off by entering a zero in the ACC input and in the JERK input. The acceleration and deceleration of the time axis will then work with a position and a step velocity written with variables 1 and 6 using the WRITE\_SV function. DISTANCE, POSITION, and VEL\_STR/END functions are not used.

To improve performance, it is recommended that the velocity compensation flag (read servo variable 32) be turned off for any slaves following the s-curve master time axis.

Time axes do not use the queue like servo axes do. If the time axis is already moving when another function call is made, the new move will begin immediately. The moves are blended together. For example if a second distance move is called before the first is completed, the distance values of the first and second move will be summed. The rate specified in the second move will also take effect immediately. Depending upon distance, endpoint, or direction selected in a distance, position or velocity move, the axis could reverse direction.

### Notes on Determining ACC and JERK Inputs

The following guidelines may help you determine the maximum acceleration [ACC input ( $A_m$ )] and the constant jerk [JERK input ( $J$ )] for your application. The two examples below present two ways to approach this.

#### Example 1

In the first example, assume that when going from 0 to maximum velocity ( $V_m$ ) the first third of the velocity change is spent in constant jerk, the second third is spent in constant acceleration, and the final third is spent in constant jerk as shown below.

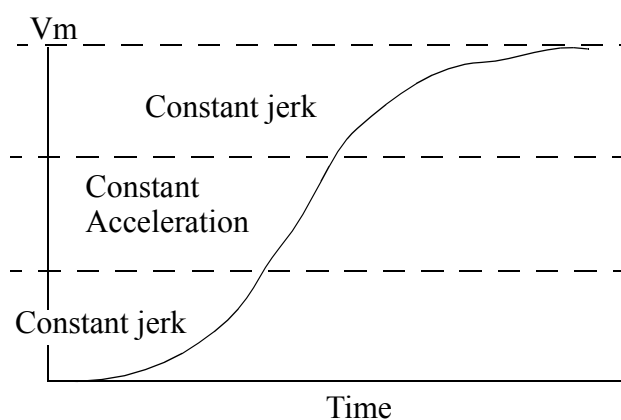

When this 1/3 relationship is true, the relationship between acceleration, jerk, velocity and time can be expressed as follows:

$$J = \frac{3}{2} \frac{A_m^2}{V_m} \quad \text{and} \quad A_m = \frac{5}{3} \frac{V_m}{time}$$

If you select an approximate time for acceleration from 0 to  $V_m$  (left column) and a value for the maximum velocity (top row), then the table provides the value for constant jerk (first line) and maximum acceleration (second line) in each row. Typically, you set the ACC and JERK inputs once based on the maximum your application can handle.

Time (sec)	Velocity (FU/min) $1 \times 10^3$	Velocity (FU/min) $1 \times 10^4$	Velocity (FU/min) $1 \times 10^5$	Velocity (FU/min) $1 \times 10^6$	Velocity (FU/min) $1 \times 10^7$	
<b>0.01</b>	$1.5 \times 10^{11}$ $1.0 \times 10^7$	$1.5 \times 10^{12}$ $1.0 \times 10^8$	$1.5 \times 10^{13}$ $1.0 \times 10^9$	$1.5 \times 10^{14}$ $1.0 \times 10^{10}$	$1.5 \times 10^{15}$ $1.0 \times 10^{11}$	JERK (FU/min <sup>3</sup> ) ACC (FU/min <sup>2</sup> )
<b>0.1</b>	$1.5 \times 10^9$ $1.0 \times 10^6$	$1.5 \times 10^{10}$ $1.0 \times 10^7$	$1.5 \times 10^{11}$ $1.0 \times 10^8$	$1.5 \times 10^{12}$ $1.0 \times 10^9$	$1.5 \times 10^{13}$ $1.0 \times 10^{10}$	JERK (FU/min <sup>3</sup> ) ACC (FU/min <sup>2</sup> )
<b>1</b>	$1.5 \times 10^7$ $1.0 \times 10^5$	$1.5 \times 10^8$ $1.0 \times 10^6$	$1.5 \times 10^9$ $1.0 \times 10^7$	$1.5 \times 10^{10}$ $1.0 \times 10^8$	$1.5 \times 10^{11}$ $1.0 \times 10^9$	JERK (FU/min <sup>3</sup> ) ACC (FU/min <sup>2</sup> )
<b>10</b>	$1.5 \times 10^5$ $1.0 \times 10^4$	$1.5 \times 10^6$ $1.0 \times 10^5$	$1.5 \times 10^7$ $1.0 \times 10^6$	$1.5 \times 10^8$ $1.0 \times 10^7$	$1.5 \times 10^9$ $1.0 \times 10^8$	JERK (FU/min <sup>2</sup> ) ACC (FU/min <sup>2</sup> )
<b>100</b>	$1.5 \times 10^3$ $1.0 \times 10^3$	$1.5 \times 10^4$ $1.0 \times 10^4$	$1.5 \times 10^5$ $1.0 \times 10^5$	$1.5 \times 10^6$ $1.0 \times 10^6$	$1.5 \times 10^7$ $1.0 \times 10^7$	JERK (FU/min <sup>3</sup> ) ACC (FU/min <sup>2</sup> )

**Example 2:**

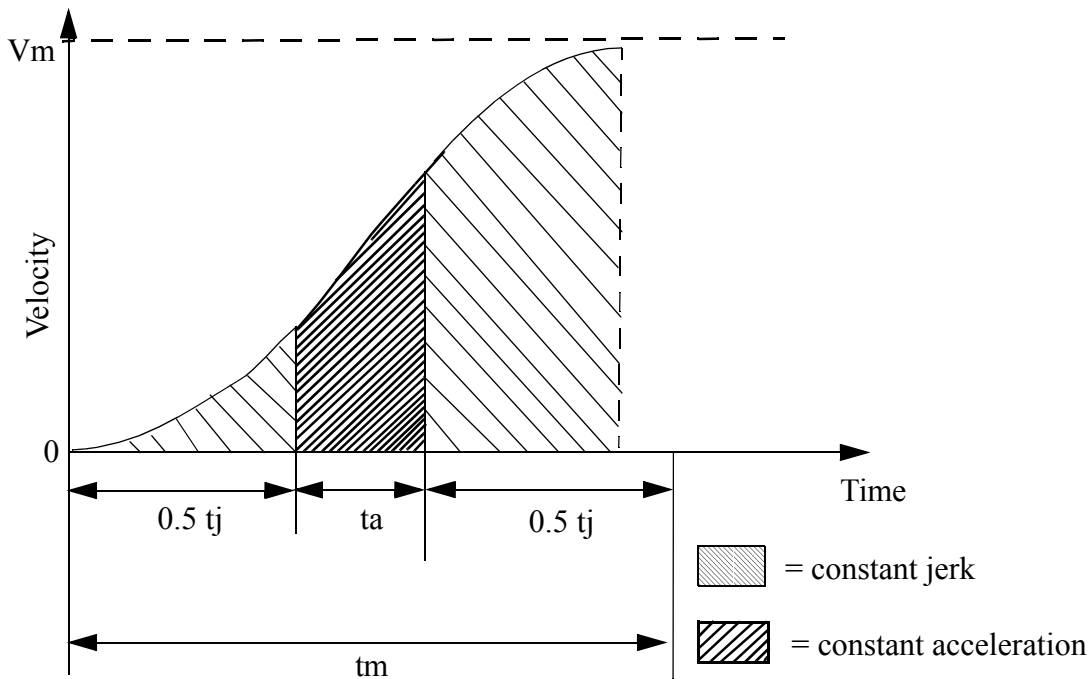

$V_m$  = Maximum velocity

$t_m$  = The total time to reach velocity  $V_m$  if the axis starts at 0

$t_j$  = The total constant jerk time

$t_a$  = The total constant acceleration time

$s$  = The fraction of time spent in constant jerk calculated by:

$$s = \frac{t_j}{t_m}$$

If you know  $V_m$ ,  $t_m$ , and  $s$ , then you can calculate jerk and acceleration using the following formulas.

$$JERK = \frac{2 \times V_m}{s \times t_m^2 (1 - 0.5 \times s)}$$

$$ACCL = \frac{V_m}{t_m (1 - 0.5 \times s)}$$

The units for JERK are ladder units per minute<sup>3</sup>; therefore,  $V_m$  is in ladder units per minute and  $t_m$  is in minutes. The units for ACCL are ladder units per minute<sup>2</sup>.

**SEEK**

Seek

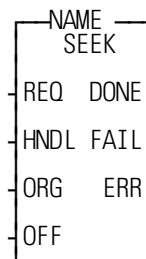
**Io/COMM**

**Inputs:** REQ (BOOL) - enables execution (**One-shot**)  
 HNDL (INT) - output from OPEN function block  
 ORG (INT) - origin  
 OFF (DINT) - offset

**Outputs:** DONE (BOOL) - energized if ERR = 0  
 not energized if ERR ≠ 0  
 FAIL (BOOL) - energized if ERR ≠ 0  
 not energized if ERR = 0  
 ERR (INT) - 0 if data transfer successful  
 ≠ 0 if data transfer unsuccessful

*See Appendix B in the PiCPro Online Help for ERR codes.*

```
<<INSTANCE NAME>>:SEEK(REQ := <<BOOL>>, HNDL := <<INT>>, ORG
:= <<INT>>, OFF := <<DINT>>, DONE => <<BOOL>>, FAIL =>
<<BOOL>>, ERR => <<INT>>);
```

When you use the OPEN function block, the file or device is set up for a sequential read/write. The SEEK function block allows you to change the location of the pointer.

This function block positions a pointer in a RAMDISK or FMSDISK file. A READ or WRITE executed after this function block will start reading from or writing at that point. The pointer is positioned from one of three origins specified by the value at ORG. It is offset from the origin by the number of bytes specified at OFF. The offset value can be positive (for forward) or negative (for backward).

If the offset value moves the pointer beyond the end of file, the pointer will be at the end of the file. If the offset value moves the pointer before the beginning of file, the pointer will be at the beginning of the file.

**Enter at ORG**

16#A00  
 16#A01  
 16#A02

**Positions pointer at OFF bytes from:**

beginning of file  
 its current location  
 end of file

**Examples of SEEK function**

<b>Value at ORG</b>	<b>Value at OFF</b>	<b>Positions pointer at OFF bytes from:</b>
16#A00	10	10 bytes beginning of file
16#A02	0	the end of the file
16#A00	-5	the beginning of file

SEEK is used in conjunction with the CLOSE, CONFIG, OPEN, READ, STATUS, and WRITE I/O function blocks.

**SEL**

Select

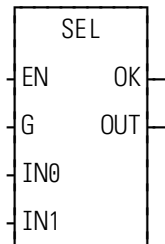
**Filter/SEL**

**Inputs:** EN (BOOL) - enables execution  
 G (BOOL) - value selector  
 IN0 (ANY except STRUCT) - value to be selected  
 IN1 (same type as IN0) - value to be selected

**Outputs:** OK (BOOL) - execution completed without error  
 OUT (same type as IN0) - selected value

```
SEL(G := <<BOOL>>, IN0 := <<ANY>>, IN1 := <<USINT>>, OK =>
  <<BOOL>>, OUT => <<ANY>>)
```

The SEL function is used to select one of two values and place it in the output variable. The selection is based on the value of the BOOLEAN input at G.

If power flow/logic continuity does not exist to the point at G, then the value of the variable or constant at IN0 is placed into the variable at OUT. If power flow/logic continuity exists to the point at G, then the value of the variable or constant at IN1 is placed into the variable at OUT.



---



---

## SERVOCLK

Servo Clock

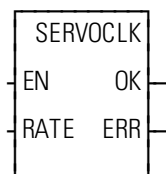
**Xclock/SERVOCLK****Inputs:** EN (BOOL) - enables execution (**One-shot**)

RATE (TIME) -1, 2, 4, 8, or 16 ms

**Outputs:** OK (BOOL) - interrupt started without errorERR (USINT) - 0 if OK is set.  $\neq 0$  if an error occurs.

SERVOCLK(RATE := <<TIME>>, OK => <<BOOL>>, ERR => <<USINT>>)

The SERVOCLK function is used in conjunction with the task feature. It allows you to run a task tied to the servo interrupt clock without actually running any servos. This gives you the ability to run a faster, higher-priority task than either the hardware or system tasks.

**NOTE:** When you are running servos, the servo interrupt clock is started when you call the STRTSERV function.

The SERVOCLK function is called only once to start the servo interrupt clock. It may be called before or after the task(s) that is to run on the servo clock.

If the STRTSERV and the SERVOCLK functions are both called in the same ladder, the most recent one called will be in effect. Calling SERVOCLK after STRTSERV will stop the servos.

The errors that can appear at the ERR output are listed below.

- ERR = 1** Invalid rate value entered. Must be 1, 2, 4, 8, or 16\* ms.
- ERR = 2** Out of memory.
- ERR = 3** Invalid CPU revision. Outdated EPROMs.

\*If you are using a Turbo<sup>2</sup> control, do not set the servo interrupt clock at 16 ms.

**SHL**

Shift Left

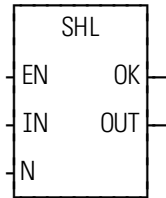
**Binary/SHL**

**Inputs:** EN (BOOL) - enables execution  
 IN (BITWISE) - value to have bits shifted  
 N (USINT) - number of bits to shift

**Outputs:** OK (BOOL) - execution completed without error  
 OUT (same type as IN) - shifted value

SHL(IN := <<BITWISE>>, N := <<USINT>>, OK => <<BOOL>>, OUT => <<BITWISE>>)

The SHL function moves all bits in the variable or constant at IN to the left. The bits are shifted the number of positions specified by the variable or constant at N. N bits on the left side are dropped. N bits on the right side are replaced with zeros. The result is placed in the variable at OUT.

Shift left, where N = 2:

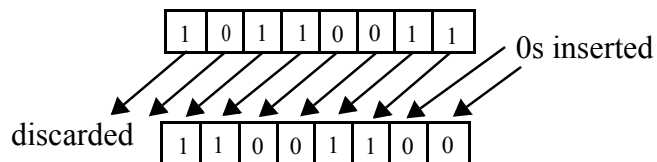
**Examples of shift left:**

SHL (3)	11110000	=	10000000
SHL (4)	01110011	=	00110000
SHL (8)	11111111	=	00000000

**SHR**

Shift Right

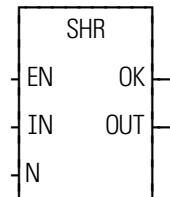
**Binary/SHR**

**Inputs:** EN (BOOL) - enables execution  
 IN (BITWISE) - value to have bits shifted  
 N (USINT) - number of bits to shift

**Outputs:** OK (BOOL) - execution completed without error  
 OUT (same type as IN) - shifted value

SHR(IN := <<BOOL>>, N := <<USINT>>, OK => <<BOOL>>, OUT => <<BITWISE>>)

The SHR function moves all bits in the variable or constant at IN to the right. The bits are shifted the number of positions specified by the variable or constant at N. N bits on the right side are dropped. N bits on the left side are replaced with zeros. The result is placed in the variable at OUT.

Shift right, where N = 2:

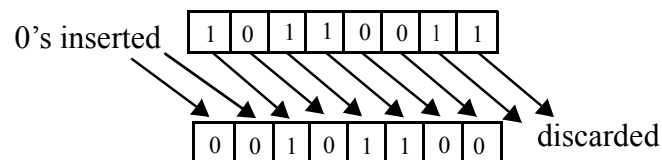

**Examples of shift right:**

SHR (3)    10101010    =    00010101  
 SHR (4)    01110011    =    00000111  
 SHR (8)    11111111    =    00000000

**SIN**

Sine

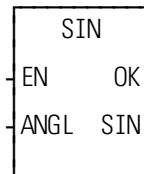
**Arith/TRIG**

**Inputs:** EN (BOOL) - enables execution  
 ANGL (REAL/LREAL) - angle value (in radians)

**Outputs:** OK (BOOL) - execution completed without error  
 SIN (REAL/LREAL) - sine calculated

NOTE: The data types entered at ANGL and SIN must match, i.e. if ANGL is REAL, then SIN must be REAL.

SIN(ANGL := <<REAL/LREAL>>, OK => <<BOOL>>, SIN => <<REAL/LREAL>>)

The SIN function calculates the sine of the angle entered at ANGL. The result is placed at SIN.

**SINT2BYT**

Short Integer to Byte

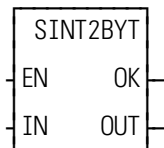
**Datatype/SINTCONV**

**Inputs:** EN (BOOL) - enables execution  
 IN (SINT) - value to convert

**Outputs:** OK (BOOL) - execution completed without error  
 OUT (BYTE) - converted value

SINT2BYT(IN := <<BOOL>>, OK => <<BOOL>>, OUT => <<BYTE>>)

The SINT2BYT function changes the data type of the value at IN from a short integer to a byte. The result is placed in the variable at OUT.

---



---

## SINT2DI

Short Integer to Double Integer

**Datatype/SINTCONV**

---



---

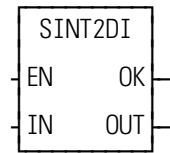

**Inputs:** EN (BOOL) - enables execution  
IN (SINT) - value to convert

**Outputs:** OK (BOOL) - execution completed without error  
OUT (DINT) - converted value

SINT2DI(IN := <<BOOL>>, OK => <<BOOL>>, OUT => <<DINT>>)

The SINT2DI function changes the data type of the value at IN from a short integer to a double integer. The sign of the short integer is extended into the leftmost 24 bits of the double integer. The result is placed in the variable at OUT.

---



---

## SINT2INT

Short Integer to Integer

**Datatype/SINTCONV**

---



---

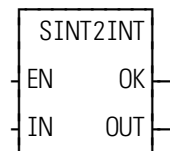

**Inputs:** EN (BOOL) - enables execution  
IN (SINT) - value to convert

**Outputs:** OK (BOOL) - execution completed without error  
OUT (INT) - converted value

SINT2INT(IN := <<SINT>>, OK => <<BOOL>>, OUT => <<INT>>)

The SINT2INT function changes the data type of the value at IN from a short integer to an integer. The sign of the short integer is extended into the leftmost 8 bits of the integer. The result is placed in the variable at OUT.

---



---

## SINT2LI

Short Integer to Long Integer

**Datatype/SINTCONV**

---



---

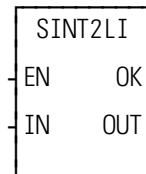

**Inputs:** EN (BOOL) - enables execution

IN (SINT) - value to convert

**Outputs:** OK (BOOL) - execution completed without error

OUT (LINT) - converted value

SINT2LI(IN := <<SINT>>, OK => <<BOOL>>, OUT => <<LINT>>)

The SINT2LI function converts a short integer into a long integer. The sign bit of the DINT is extended into the leftmost 56 bits of the long integer. The result is placed in a variable at OUT.

---



---

## SINT2USI

Short Integer to Unsigned Short Integer

**Datatype/SINTCONV**

---



---



**Inputs:** EN (BOOL) - enables execution

IN (SINT) - value to convert

**Outputs:** OK (BOOL) - execution completed without error

OUT (USINT) - converted value

SINT2USI(IN := <<SINT>>, OK => <<BOOL>>, OUT => <<USINT>>)

The SINT2USI function changes the data type of the value at IN from a short integer to an unsigned short integer. The result is placed in the variable at OUT.

## SIZEOF

Size of variable

Datatype/SIZEOF

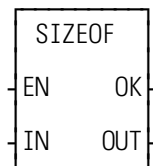

**Inputs:** EN (BOOL) - set to call the function (**one-shot**)  
 IN (any data type) - variable name

**Outputs:** OK (BOOL) - set when EN is on  
 OUT (UINT) - size in bytes of the variable entered at IN

SIZEOF(IN := <<ANY>>, OK => <<BOOL>>, OUT => <<UNIT>>)

The SIZEOF function is used to give you the size of the variable name you enter at IN.

The OK will be set if the EN is on and off when the EN is off.

The OUT output reports the size in bytes of the variable at IN.

Data Type of Variable	OUT Output (in bytes)	Data Type of Variable	OUT Output (in bytes)
BOOL	1	STRING	Declared length +2
BYTE	1	DATE	2
WORD	2	TIME_OF_DAY	4
DWORD	4	DATE_AND_TIME	4
LWORD	8	TIME	4
SINT	1	Variable (ARRAY)	Size of one element in array
INT	2	STRUCT	Number of bytes in structure
DINT	4	STRUCT.member	Size of member
LINT	8	STRUCT.member (ARRAY)	Size of one element in array member
USINT	1	STRUCT (ARRAY)	Size of one structure in the array
UNIT	2	STRUCT (ARRAY).member	Size of member
UDINT	4	STRUCT (ARRAY).member (ARRAY)	Size of one element in array member
ULINT	8	Variable name of array only	Not supported
REAL	4	Name of structure array only	Not supported
LREAL	8	Constant	4 unless DATE (D#) which is 2

## SIZEOF

Below is an example of what the size output would be for the structure MACH and each of its members.

Variable Name at IN	Data Type of Variable	SIZE Output (in bytes)
MACH	STRUCT	14
.ONE	BYTE	1
.TWO	DWORD (2)	4*
.END	STR (3)	5
END_STRUCT		

\*The 4 represents DWORD (0). There are another 4 bytes in DWORD (1) which brings the total for the structure to 14.



**SQRT**

Square Root

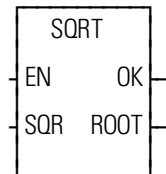
**Arith/ARITH****Inputs:** EN (BOOL) - enables executionSQR (USINT, UINT, UDINT, REAL constant) -  
value to find square root of**Outputs:** OK (BOOL) - execution completed without errorROOT (same type as SQR) - square root of the  
number

SQRT(SQR := <<USINT, UINT, UDINT, REAL>>, OK => <<BOOL>>, ROOT  
=> <<USINT, UINT, UDINT, REAL>>)

The SQRT function determines the square root of the number at SQR and places it in the variable at ROOT. The value at SQR must be greater than or equal to zero.

The square root function, operating on a non-negative number S, is defined as:

$$\sqrt{S} = r$$

where  $r * r = S$

If the value at ROOT is not an integer, it is rounded up to the nearest integer if the fractional value is greater than or equal to .5. It is rounded down to the nearest integer if the fractional value is less than .5.

**Note:** You can use other datatypes such as INTs, DINTs, etc. as long as they are positive values.

---



---

**STATUS**

Status

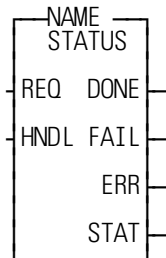
**IO/COMM**

**Inputs:** REQ (BOOL) - enables execution (**One-shot**)  
 HNDL (INT) - output from OPEN function block

**Outputs:** DONE (BOOL) - energized if ERR = 0  
 not energized if ERR ≠ 0  
 FAIL (BOOL) - energized if ERR ≠ 0  
 not energized if ERR = 0

ERR (INT) - 0 if data transfer successful  
 ≠ 0 if data transfer unsuccessful

*See Appendix B in the PiCPro Online Help for ERR codes.*

STAT (INT) - number of bytes in buffer

```
<<INSTANCE NAME>>:STATUS(REQ := <<BOOL>>, HNDL := <<INT>>,
  DONE => <<BOOL>>, FAIL => <<BOOL>>, ERR => <<INT>>, STAT =>
  <<INT>>);
```

The STATUS function block outputs the number of bytes that are in the input buffer for the device designated by HNDL. The number of bytes is placed in the variable at STAT. The value of STAT should be used as an input to the READ function (at CNT) to specify how many bytes should be read from the port.

- Use this function block only for a device at the User Port, and only when the device is opened in the READ or READ/WRITE mode. ERR code # 9 will be returned if this function is used on workstation or DISK files.
- The maximum number of characters that will be buffered by the PiC is 128. If a read is not done, the buffer will fill up. Subsequent characters will be lost.

STATUS is used in conjunction with the CLOSE, CONFIG, OPEN, READ, SEEK, and WRITE I/O function blocks.

---



---

# STATUSSV

Status Servo

**Motion/DATA**

---



---

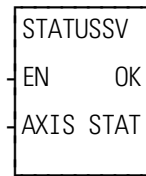

**Inputs:** EN (BOOL) - enables execution  
 AXIS (USINT) - identifies axis (servo or digitizing)

**Outputs:** OK (BOOL) - execution completed without error  
 STAT (WORD) - gives the status of the axis

STATUSSV(AXIS := <<USINT>>, OK => <<BOOL>>, STAT => <<WORD>>)

The STATUSSV function identifies the following axis characteristics in the STAT word output:

Characteristic	Binary Value	Hex Value
1.Move started	00000000 00000001	0001
2.Fast input occurred	00000000 00000010	0002
3.Fast input on	00000000 00000100	0004
4.Good mark detected	00000000 00001000	0008
5.Bad mark detected	00000000 00010000	0010
6.DIST + TOLR exceeded	00000000 00100000	0020
7.Fast input rising	00000000 01000000	0040

These bits are “read and clear” (one shot) bits except the fast input on bit. A set bit means that the event has occurred since the last time the function was called. Therefore, it is recommended that the function be called only once in the ladder to prevent missing the event.

**Move started** - This bit will be set when the software starts iterating a move. It will be set whenever a move begins.

A situation where checking the status of this bit is helpful is when the start of a move has been held off by the distance requirement in the FAST\_QUE function. The bit will be set when the move *actually* begins.

**Fast input occurred** - This bit will be set by the software whenever a fast input occurs on the servo or digitizing axis. The module must be configured to watch for the fast input by using the FAST\_QUE, the FAST\_REF, REGIST, or MEASURE. The FAST\_QUE and FAST\_REF functions must be called each time you want to

perform the function and configure the module. REGIST and MEASURE are called once.

Typically, the **Fast input occurred** bit will be set anytime the fast input occurs on the axis. However, if it is an encoder axis that uses the index mark to reference, the bit is set when the index mark occurs. With the FAST\_REF function, the bit is set when the index mark occurs after the fast input transitions. With the LAD\_REF function, the bit is set when the index mark occurs after the REF\_END function is called in the ladder.

**Fast input on** - This bit is set by the hardware when the fast input is on.

**NOTE:** If the STATUS\_SV function is called after the fast input turns on but before a servo interrupt occurs, the **Fast input on** bit is set and the **Fast input occurred** bit will not be set until the next scan.

**NOTE:** This bit is not supported with SERCOS or virtual axes. It will always be reset.

**Good mark detected-** This bit will be set when a good mark is detected.

**Bad mark detected** - This bit keeps track of bad marks.

**NOTE:** Since the first mark is always “bad,” it will be set on the first mark after registration is called.

**Distance + tolerance exceeded** - This bit is set as soon as the distance from the last mark exceeds the value of DIST + TOLR whether or not a mark has occurred. It will be reset when any mark occurs.

**Fast input rising** - This bit indicates the direction of the most recent fast input until the next fast input occurs.

If the transition direction is defined as rising (a 0 entered in variable 19 of WRITE\_SV), then this bit will always be on.

If the transition direction is defined as falling (a 1 entered in variable 19 of WRITE\_SV), then this bit will always be off.

If the transition direction is defined as both rising and falling (a 2 entered in variable 19 of WRITE\_SV), then this bit will alternate between on and off as the fast input signal alternates.

See also the table of variables at the READ\_SV function.

---



---

## STEPCNTL

Stepper Control

Io/STEPPER

---



---

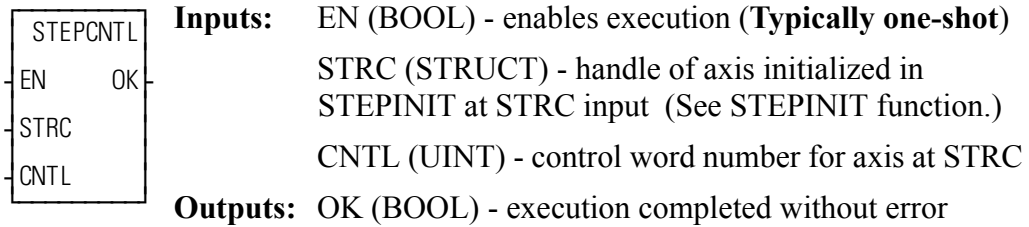

STEPCNTL(STRC := <<MEMORY AREA>>, CNTL := <<UINT>>, OK => <<BOOL>>)

The STEPCNTL function is used to send a control word to the stepper motor control module (SMCM). The number entered in CNTL represents a control word from those listed in the table that follows.

### IMPORTANT

When the STEPCNTL function is called, it can take the SMCM up to 3 ms to process it. To ensure proper operation, always check that the “control word not processed” bit in the status word is clear before sending a control word.

## STEPCNTL

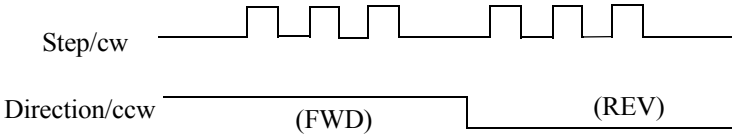
Control #	Name	Description
1	Enable profile	The <i>enable profile</i> control word is required to allow profile commands to be entered into the command queue.
2	Pause profile	The <i>pause profile</i> control word will prevent any further profile commands in the command queue from being executed until a <i>continue</i> control word is received.  <b>NOTE:</b> An active <i>distance</i> or <i>position</i> command will complete its execution.
3	Continue profile	The <i>continue</i> control word will cause profile command execution to resume. It resets the pause bit and goes to the next command in the command queue.  If a <i>continue</i> control word is received <i>before</i> the current command is completed, that command will be aborted and the next command in the command queue will be executed.
NOTE: If a velocity command is executed and there are no more commands in the command queue, the queue empty bit will be set as soon as the continue profile word is written. Because there are no more commands to execute the SMCM will then force the stepper to decelerate to zero at the current acc/dec rate.-		
4	Emergency stop	The <i>emergency stop</i> control word causes the SMCM to stop outputting pulses to the stepper regardless of the current acc/dec rate. The command queue is emptied.
5	Controlled stop	The <i>controlled stop</i> control word causes the SMCM to immediately decelerate to zero velocity at the current acc/dec rate. The command queue is emptied.
6	Step/direction	The <i>step/direction</i> control word causes pulses to be output on the step/cw output and direction to be output on the direction/ccw output as shown below. The step/direction mode is the default.  

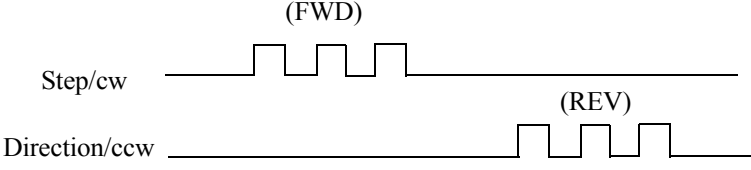
7	CW/CCW	<p>The <i>CW/CCW</i> control word causes steps to be output on the step/cw output when the stepper motor moves in a forward direction and on the direction/ccw output when the stepper motor moves in the reverse direction.</p> 
---	--------	---

**Interrupting distance, position, and velocity moves**

Moves can be interrupted in various ways--a *controlled stop*, an *emergency stop*, or a *continue* control word. The effects each of these has on a move are illustrated in the next three figures.

When a *controlled stop* control word is received from the ladder, the move is aborted and the axis decelerates to zero at the current acc/dec rate as shown in Controlled stop control word received before end of a move

**Figure 2-36. Controlled stop control word received before end of a move**

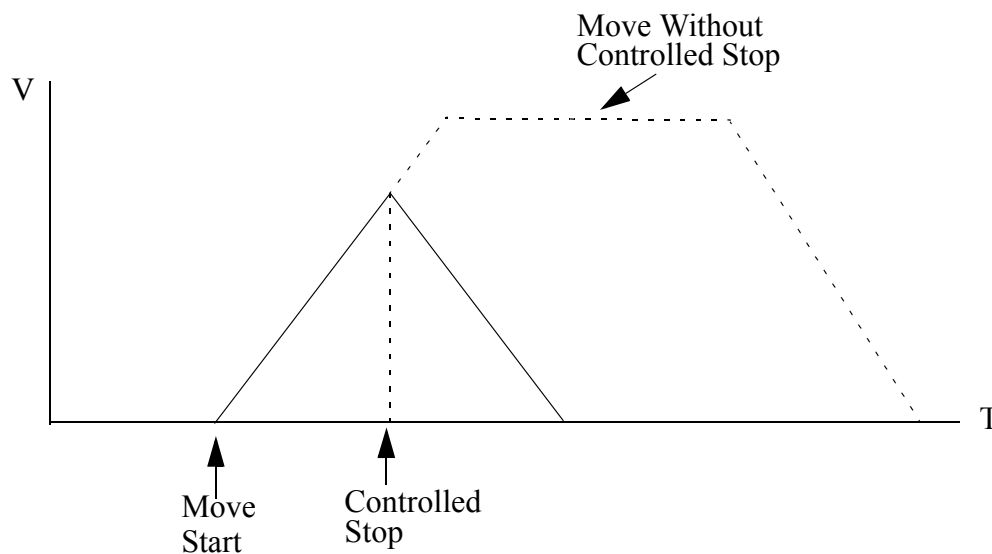

When an *emergency stop* control word is received from the ladder, the axis comes to an immediate halt as shown in Emergency stop control word received before end of distance move

**Figure 2-37. Emergency stop control word received before end of distance move**

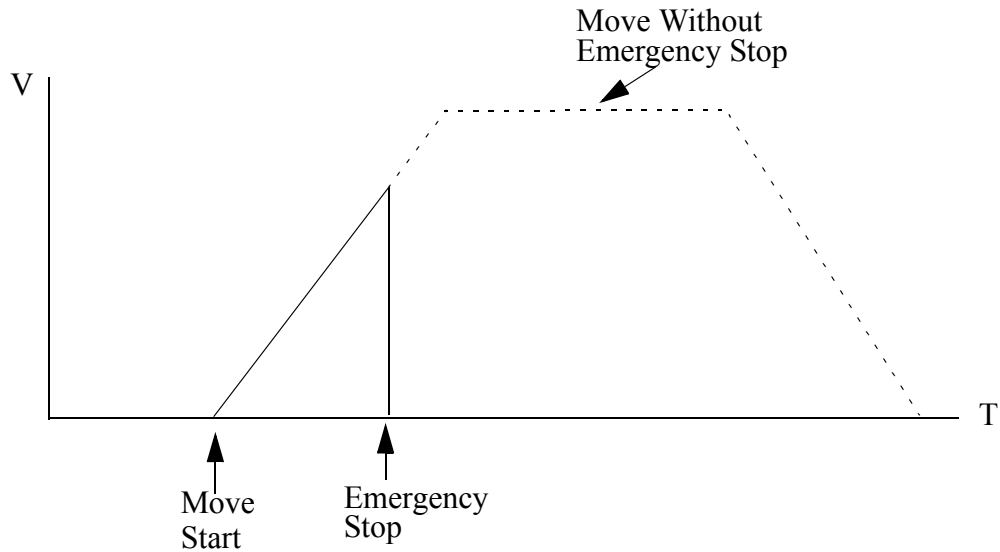

When the word to continue is received from the ladder, the next command in the profile is executed as shown in Velocity move with continue control word received before velocity reached

**Figure 2-38. Velocity move with continue control word received before velocity reached**

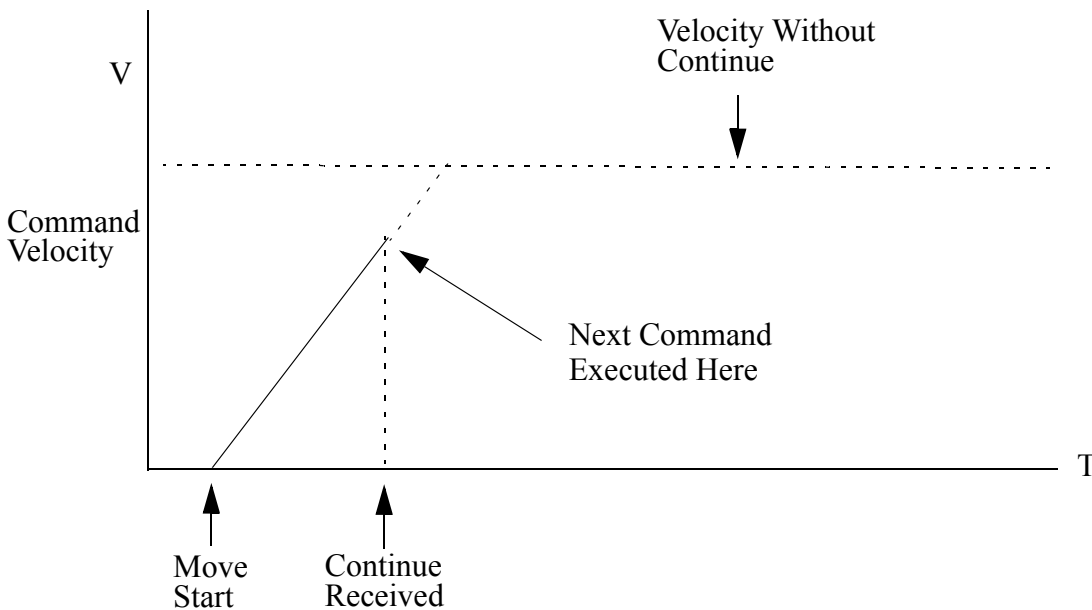



**STEPINIT**

Step Initialization

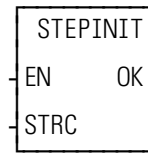
**Io/STEPPER**

**Inputs:** EN (BOOL) - enables execution (**One-shot**)  
 STRC (STRUCT) - contains the following members:  
 RACK, SLOT, CHAN, ERROR, and ID which identifies the axis as a stepper axis

**Outputs:** OK (BOOL) - execution completed without error

STEPINIT(STRC := <<MEMORY AREA>>, OK => <<BOOL>>)

The STEPINIT function initializes an axis as a stepper axis. It verifies the integrity of the rack, slot, and channel location and assigns a handle (ID) to the axis at that location.

It also returns the errors listed in the table below at the ERROR member of the structure.

**Error number for ERROR member of structure**

#	Name of Error	Function OK not set with error
0	No error	N/A
1	Invalid rack number <i>or</i> remote rack not available	STEPINIT
2	Invalid slot number	STEPINIT
3	Invalid channel number	STEPINIT
4	Module not found at rack and slot location <i>or</i> not enough channels on the module	STEPINIT
5	Invalid command number	STEP_CMD
6	Invalid data for the command	STEP_CMD
7	Invalid control number	STEP_CNTL
8	A stepper function called before the STEPINIT function	STEP_COM, STEP_CNTL, STEP_STAT, and STEP_POS
9	A BLOCK_IO error has occurred	STEP_COM, STEP_CNTL, STEP_STAT, and STEP_POS

You enter a structure in the software declarations table following the format shown below. The name of the structure in this example is STEP1.

## Structure for STEPINIT function

Name	Type
STEP1	STRUCT
.RACK	USINT
.SLOT	USINT
.CHAN	USINT
.ERROR	INT
.ID	INT
	END_STRUCT

**IMPORTANT**

The structure you enter in the software declarations table must have the members entered in the order shown above. The data type for each member of the structure must be as shown in the **Type** column in order for the software to recognize the information.

Initial values are entered by you for the rack, slot, and channel numbers for the stepper axis at the RACK, SLOT, and CHAN members of the structure.

**NOTE:** With the block stepper/encoder/DCin module, the RACK must be set to 100, the SLOT is the module number from 1 to 77 (1 for the block module connected to the CPU, 2 for the block module connected to #1, 3 for the module connected to #2, etc., and CHAN is 1 or 2.

The software assigns values to ERROR and ID. *Never enter any values for them.*

**STEPSTAT***Step Status***IO/STEPPER****Inputs:** EN (BOOL) - enables execution

STRC (STRUCT) - handle of axis initialized in STEPINIT at STRC input

**Outputs:** OK (BOOL) - execution completed without error

STAT (WORD) - stepper status for AXIS

STEPSTAT(STRC := <<MEMORY AREA>>, OK => <<BOOL>>, STAT => <<WORD>>)

The STEPSTAT function allows you to read the data on the status of the axis. See the table below.

**IMPORTANT**

It takes the stepper motor control module (SMCM) up to 3 ms to process a control word. If the “control word not processed” bit in the status word is clear, the status word reflects the last control word that was written.

Table 2-13. WORD Output from STEPSTAT Function

Name	Description	Binary value	Dec	Hex
Profile enabled	<p>When set, this bit indicates that commands can be sent to the queue for execution. It is set by sending the <i>enable profile</i> control word.</p> <p>The following conditions will reset this bit:</p> <ul style="list-style-type: none"> <li>• Sending an emergency stop control word</li> <li>• Completing a controlled stop</li> <li>• Controller scan loss</li> <li>• Illegal command/data is executed</li> <li>• Illegal control word received</li> <li>• Calculation error occurred</li> <li>• Command queue overflow</li> </ul> <p>When reset, the following occurs:</p> <ul style="list-style-type: none"> <li>• The SMCM stops outputting pulse</li> <li>• The queue is emptied</li> <li>• Any commands sent to the queue are lost</li> <li>• Status information for the axis is invalid</li> </ul>	00000000 00000001	1	0001
Profile paused	<p>When set, this bit indicates that no more commands will be executed from the queue. The following commands will set this bit:</p> <ul style="list-style-type: none"> <li>• A <i>pause profile</i> command or control word</li> <li>• A <i>velocity move</i> command</li> </ul> <p>This bit is reset by sending a <i>continue profile</i> control word.</p>	00000000 00000010	2	0002
At velocity	<p>When set, this bit indicates that the desired velocity has been reached. This bit is set when a <i>velocity move</i> command is executed <i>and</i> the desired velocity is reached.</p> <p>This bit is reset by sending a <i>continue profile</i> control word.</p>	00000000 00000100	4	0004
Queue empty	<p>This bit is set when the final command in the queue has completed execution.</p> <p>This bit is reset when a command is placed into the queue for execution.</p>	00000000 00001000	8	0008

Name	Description	Binary value	Dec	Hex
NOTE: If a velocity command is executed and there are no more commands in the command queue, the queue empty bit will be set as soon as the continue profile word is written. Because there are no more commands to execute the SMCM will then force the stepper to decelerate to zero at the current acc/dec rate.				
Queue full	This bit is set when the queue is full (500 commands). An E-stop will occur if another command is sent to the queue.  This bit is reset when a command is removed from the queue for execution.	00000000 00010000	16	0010
Control word not processed	This bit is set until the control word is processed.	00000000 00100000	32	0020
	(not used)	00000000 0X000000	64	0040
	(not used)	00000000 X0000000	128	0080
	(not used)	0000000X 00000000	256	0100
	(not used)	000000X0 00000000	512	0200
	(not used)	00000X00 00000000	1024	0400
	(not used)	0000X000 00000000	2048	0800
	(not used)	000X0000 00000000	4096	1000
	(not used)	00X00000 00000000	8192	2000
	Reserved for future version # of firmware	0V000000 00000000	16384	4000
	Reserved for future version # of firmware	V0000000 00000000	32768	8000

**STEP\_CMD**

Step Command

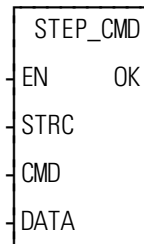
**IO/STEPPER**

**Inputs:** EN (BOOL) - enables execution (**Typically one-shot**)  
 STRC (STRUCT) - handle of axis initialized in STEPINIT at STRC input (See STEPINIT function.)  
 CMD (UINT) - stepper command for STRC  
 DATA (DINT) - command data for STRC

**Outputs:** OK (BOOL) - execution completed without error

STEP\_CMD(STRC := <<MEMORY AREA>>, CMD := <<UINT>>, DATA := <<DINT>>, OK => <<BOOL>>)

The STEP\_CMD function sends a profile command and its related data to the stepper axis identified in STRC. The commands available and their range of data are listed in the table below. Several commands (up to 500) can be sent to the command queue on the stepper motor control module (SMCM) to run a profile for the axis identified at STRC.

**IMPORTANT**

When the STEP\_CMD function is called, the command is moved into a command queue on the SMCM. It can take up to 3 ms for the SMCM to process a command after it has been moved into the command queue. In some cases, it is important that the command be processed before some other action is taken (i.e. sending a control word).

To ensure that the command is processed before some other action, send a *pause* command immediately after the command. Check to see that the pause bit in the status word is set before initiating the next action.

**NOTE**

If the command queue is empty when the SMCM is ready to execute another command, the SMCM will force the stepper to decelerate to zero at the current acc/dec rate. If another command is sent to the command queue during this deceleration, that command will be executed immediately.

<b>Profile Commands</b>		
<b>Com #</b>	<b>Profile Command</b>	<b>Range</b>
1	<p><b>Distance</b></p> <p>The <i>distance</i> command will cause the stepper to move the indicated number of steps relative to the current position.</p> <p>For example, if the current position is 200 and the commanded distance is 1000, the endpoint will be 1200. The SMCM will output 1000 steps.</p> <p>The SMCM will cause the motor to accelerate, decelerate, or reverse direction in order to move the required distance.</p> <p>At the end of an uninterrupted distance move, the velocity is always zero.</p> <p>The distance move will accelerate towards (or decelerate to) the maximum velocity set with command 4.</p> <p>All acceleration and deceleration required to move the commanded distance will be at the acc/dec rate set with command 5.</p> <p>A distance move is aborted when a <i>continue</i> control word is received from the ladder.</p>	±2,147,352,575 steps
2	<p><b>Position</b></p> <p>The <i>position</i> command is identical to the <i>distance</i> command except the move is relative to absolute zero. When power is first applied to the SMCM, the absolute position is zero. Any distance moved from this point is added to or subtracted from (for reverse move) the current position to form the new absolute position.</p> <p>For example, if the current position is 200 and the commanded position is 1000, the endpoint will be 1000. The SMCM will output 800 steps.</p> <p>The SMCM will cause the motor to accelerate, decelerate, and reverse directions, if necessary, in order to move to the commanded position.</p> <p>At the end of an uninterrupted position move, the velocity is always zero.</p> <p>The position move will accelerate towards (or decelerate to) the maximum velocity set with command 4.</p> <p>All acceleration and deceleration required to move the commanded distance will be at the acc/dec rate set with command 5.</p> <p>A position move is aborted when a <i>continue</i> control word is received from the ladder.</p>	±2,147,352,575 steps

3	<p><b>Velocity</b></p> <p>The <i>velocity</i> command will cause the stepper to accelerate or decelerate at the current acc/dec rate from the current velocity to the commanded velocity.</p> <p>When the <i>velocity</i> command is executed, the “pause” bit in the status word is set immediately. The next command will not be executed until a <i>continue</i> control word from the ladder is received. If a <i>continue</i> control word is received during the acc/dec portion of the move, the <i>velocity</i> command is aborted and the next command is executed.</p> <p>If no <i>continue</i> control word is received during the acc/dec section, the commanded velocity is reached and the “at velocity” bit in the status word is set. The axis will continue at that velocity until a <i>continue</i> control word is received.</p> <p>The velocity that will be reached is the velocity specified by the command and is not related in any way to the maximum velocity. Three examples of velocity moves are shown in Figures 9-37 through 9-39.</p>	$\pm 1,000,000$ steps/sec
---	---	------------------------------

The starting velocity is “0” and the move accelerates at the current acc/dec rate to the commanded velocity in Velocity move with starting velocity = 0. It will continue at the commanded velocity until the next command is received.

**Figure 2-39. Velocity move with starting velocity = 0**

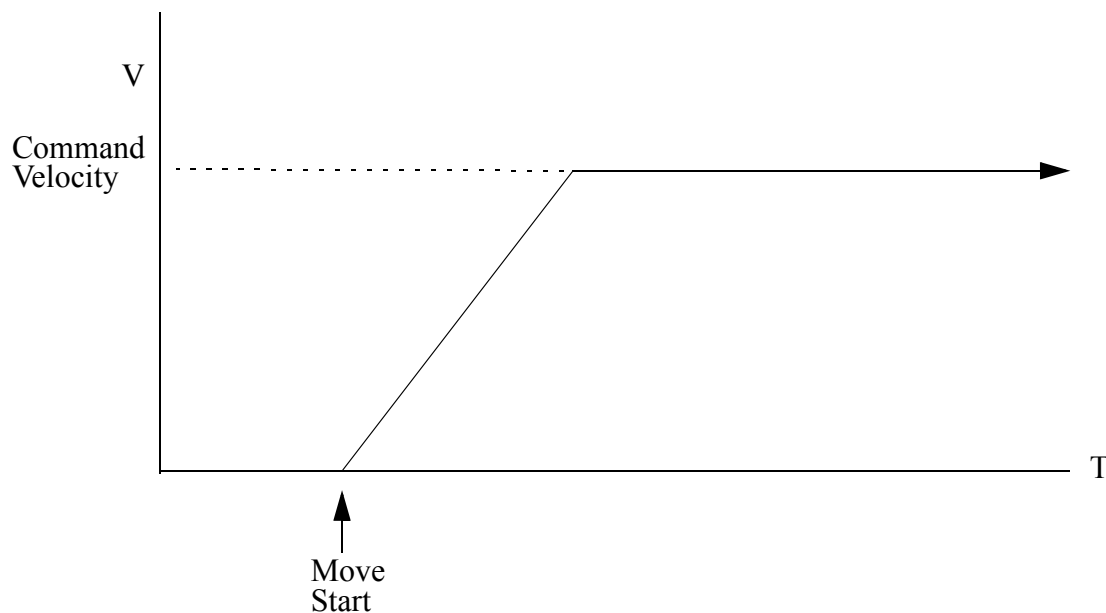



A velocity move where the starting velocity is greater than the commanded velocity is illustrated in Velocity move with starting velocity > commanded velocity. The move decelerates at the current acc/dec rate until it is at the commanded velocity.

**Figure 2-40. Velocity move with starting velocity > commanded velocity**

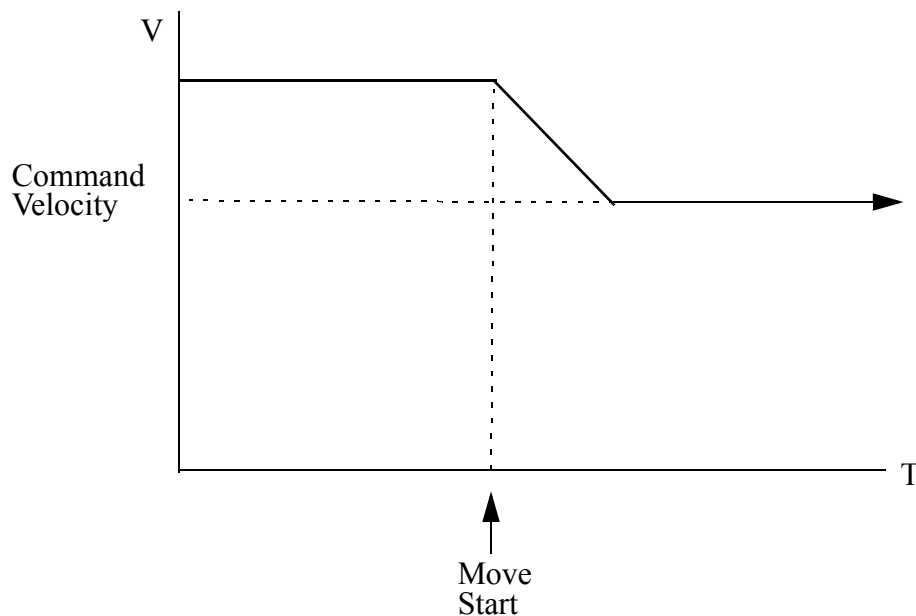

A velocity move where the starting velocity is forward and the commanded velocity is reverse is illustrated in Velocity move with starting velocity forward (+), commanded velocity reverse (-). The move decelerates to "0" and then reverses direction as commanded.

Figure 2-41. Velocity move with starting velocity forward (+), commanded velocity reverse (-)

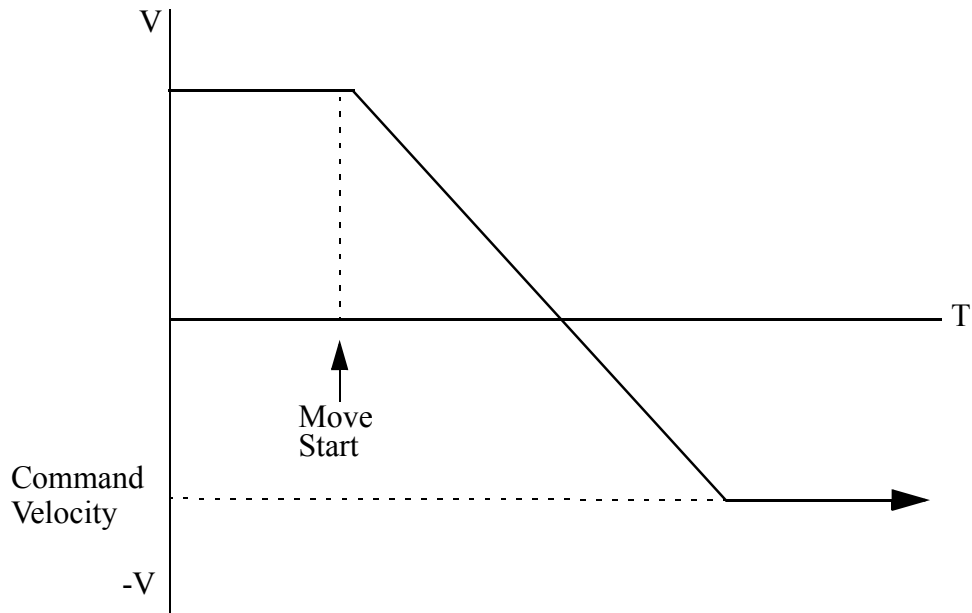

Com #	Command	Range
4	<p><b>Set Maximum Velocity</b></p> <p>The <i>set maximum velocity</i> command defines the maximum velocity that will be allowed during a distance or position move.</p>	1 to 1,000,000 steps/sec (Default - 200 steps/sec)
5	<p><b>Set Acc/Dec Rate</b></p> <p>The <i>set acc/dec rate</i> command defines the rate at which the stepper motor will accelerate or decelerate.</p> <p><b>Note:</b> ACC/DEC rates above 1,000,000 steps/sec/sec during distance or position moves may cause an overshoot in the number of steps sent to the drive. Avoid this by setting the rate below 1,000,000 steps/sec/sec.</p>	1 to 16,777,215 steps/sec/sec (Default - 200 steps/sec/sec)
6	<p><b>Set Reference</b></p> <p>The <i>set reference</i> command is used to establish an absolute position for subsequent position moves. The absolute position is forced to the reference position defined by the set reference data.</p>	±2,147,352,575 steps (Default - 0)
7	<p><b>Pause</b></p> <p>The <i>pause</i> command causes the SMCM to remain at the current command until a <i>continue</i> control word is received from the ladder.</p>	--

Com	Command	Range																																													
8	<p><b>Steps Per Revolution (5-Axis Integrated Stepper Module only)</b></p> <p>This value specifies the number of steps per revolution for a step-per axis controlled by the 5-Axis Integrated Stepper Module. The following table indicates the steps per revolution for each of the valid DATA input values.</p> <table border="1" data-bbox="342 541 1175 1186"> <thead> <tr> <th><u>Value</u></th> <th><u>mSteps/Step</u></th> <th><u>Steps/Rev (assuming 1.8° motor)</u></th> </tr> </thead> <tbody> <tr><td>0</td><td>2</td><td>400</td></tr> <tr><td>1</td><td>4</td><td>800</td></tr> <tr><td>2</td><td>8</td><td>1,600</td></tr> <tr><td>3</td><td>16</td><td>3,200</td></tr> <tr><td>4</td><td>32</td><td>6,400</td></tr> <tr><td>5</td><td>64</td><td>12,800</td></tr> <tr><td>6</td><td>128</td><td>25,600</td></tr> <tr><td>7</td><td>256</td><td>51,200</td></tr> <tr><td>8</td><td>5</td><td>1,000</td></tr> <tr><td>9</td><td>10</td><td>2,000</td></tr> <tr><td>10</td><td>25</td><td>5,000</td></tr> <tr><td>11</td><td>50</td><td>10,000</td></tr> <tr><td>12</td><td>125</td><td>25,000</td></tr> <tr><td>13</td><td>250</td><td>50,000</td></tr> </tbody> </table> <p>Module power-on default: 0</p> <p>Note: This is not a command that is entered into the stepper module's command queue. The value is written to the stepper module and is effective immediately.</p>	<u>Value</u>	<u>mSteps/Step</u>	<u>Steps/Rev (assuming 1.8° motor)</u>	0	2	400	1	4	800	2	8	1,600	3	16	3,200	4	32	6,400	5	64	12,800	6	128	25,600	7	256	51,200	8	5	1,000	9	10	2,000	10	25	5,000	11	50	10,000	12	125	25,000	13	250	50,000	0 to 13
<u>Value</u>	<u>mSteps/Step</u>	<u>Steps/Rev (assuming 1.8° motor)</u>																																													
0	2	400																																													
1	4	800																																													
2	8	1,600																																													
3	16	3,200																																													
4	32	6,400																																													
5	64	12,800																																													
6	128	25,600																																													
7	256	51,200																																													
8	5	1,000																																													
9	10	2,000																																													
10	25	5,000																																													
11	50	10,000																																													
12	125	25,000																																													
13	250	50,000																																													

Com #	Command	Range
9	<p><b>Driven Run Current (5-Axis Integrated Stepper Module only)</b></p> <p>This value specifies the peak current that will be applied when stepping.</p> <p>1 count = 19.65 mA  204 counts = 4 A (maximum)  Peak current = (RMS current)(1.4)</p> <p>Module power-on default: 0</p> <p>Note: This is not a command that is entered into the stepper module's command queue. The value is written to the stepper module and is effective immediately.</p>	0 to 204
10	<p><b>Drive Idle Current (5-Axis Integrated Stepper Module only)</b></p> <p>This value specifies the peak current that will be applied to maintain holding torque.</p> <p>1 count = 19.65 mA  204 counts = 4 A (maximum)  Peak current = (RMS current)(1.4)</p> <p>Module power-on default: 0</p> <p>Note: This is not a command that is entered into the stepper module's command queue. The value is written to the stepper module and is effective immediately.</p>	0 to 204
11	<p><b>Drive Enable (5-Axis Integrated Stepper Module only)</b></p> <p>This value enables and disables a drive in a 5-Axis Integrated Stepper Module.</p> <p>0 = drive disable  1 = drive enable</p> <p>Module power-on default: 0</p> <p>Note: This is not a command that is entered into the stepper module's command queue. The value is written to the stepper module and is effective immediately.</p>	0 to 1

### Profile example

The table below gives an example of a profile for one stepper axis. This example sends 10 commands to the command queue via the STEP\_CMD function. The position of the axis at the end of each command is given in the last column.

**Note:** The first command is a reference to zero. By including this command you ensure that the stepper axis position will always be reset to zero when restarting the ladder scan.

Example profile commands for one stepper axis				
CMD from STEP_CMD	DATA from STEP_CMD	Steps output	Direction	Absolute position
6 (Set Reference)	0	0	N/A	0
4 (Set Max Vel)	5000	0	N/A	0
5 (Set acc/dec rate)	2000	0	N/A	0
1 (Distance)	1,000	1,000	Forward	+1,000
1 (Distance)	1,000	1,000	Forward	+2,000
1 (Distance)	-3,000	3,000	Reverse	-1,000
2 (Position)	1,000	2,000	Forward	+1,000
6 (Set Reference)	10,000	0	N/A	+10,000
1 (Distance)	1,000	1,000	Forward	+11,000
2 (Position)	-1,000	12,000	Reverse	-1,000

### Programming suggestion

In the previous example, it would be necessary to enter 10 STEP\_CMD functions in the ladder to send all the profile commands to the module. The variables at the CMD and DATA inputs would hold the values listed in the table.

In order to transfer all the profile commands and data needed for one stepper axis in the STEP\_CMD function, an array of structures can be used.

The structure P1 (profile 1) would have two members; .C (command) and .D (data). The array would be long enough to hold all the profile commands needed for the stepper axis identified at STRC plus an additional element holding zeros to mark the end of the array. In the ladder example that follows, the EQ function will reset LOAD\_PRO when the command equals zero.

NOTE: You may want to declare an array with several extra elements. This would allow you to easily add additional commands and data to an existing profile. Always ensure that the last array element contains zeros.

One method of using this array of structures with the STEP\_CMD function in the ladder is shown below.

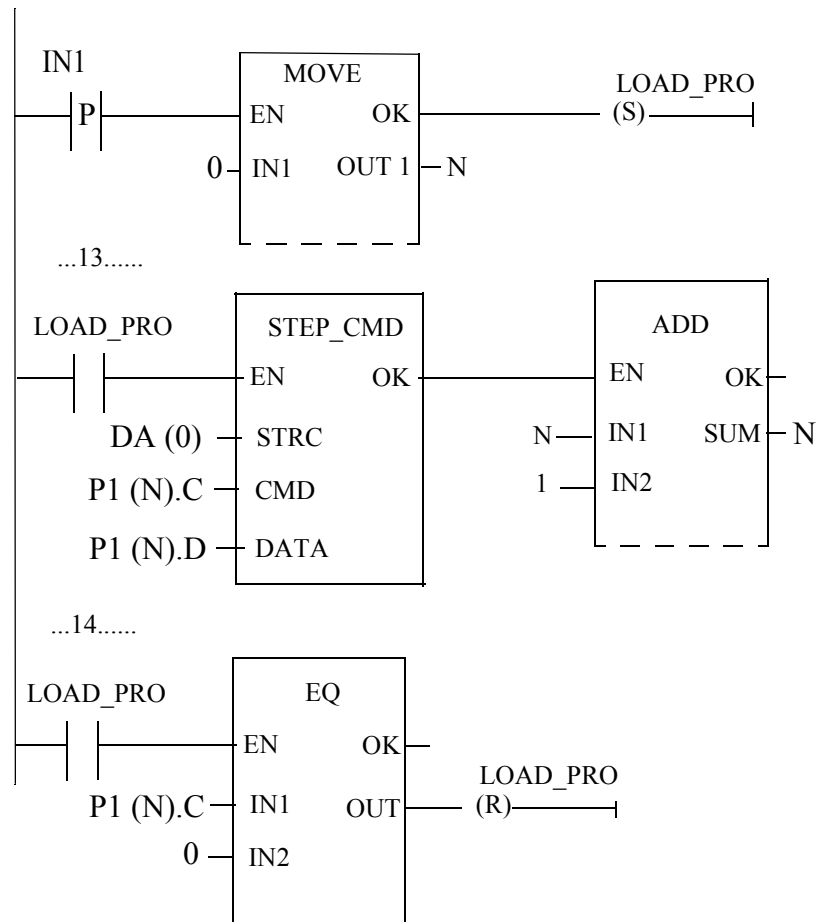

---



---

## STEP\_POS

Stepper Position

**IO/STEPPER**

---



---

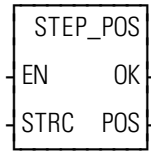

**Inputs:** EN (BOOL) - enables execution  
 STRC (STRUCT) - handle of axis initialized in STEPINIT at STRC input (See STEPINIT function.)

**Outputs:** OK (BOOL) - execution completed without error  
 POS (DINT) - latest position read for axis at STRC

STEP\_POS(STRC := <<MEMORY AREA>>, OK => <<BOOL>>, POS => <<DINT>>)

The STEP\_POS function allows you to read the position of the stepper axis.



**STR2D\_T**

String to Date and Time

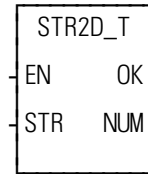
**Datatype/STRCONV**

**Inputs:** EN (BOOL) - enables execution  
STR (STRING) - string to convert

**Outputs:** OK (BOOL) - execution completed without error  
NUM (DATE\_AND\_TIME) - Date and time conversion

STR2D\_T(STR := <<USINT>>, OK => <<BOOL>>, NUM => <<DATE\_AND\_TIME>>)

The STR2D\_T function converts a string into a date and time.

The string at STR consists of six fields (three required, three optional) entered in the following order:

Field	Required			Optional		
	Year	Month	Day	Hour	Minute	Second
<b>Range</b>	1988 to 2051	1 to 12	1 to 31	0 to 23	0 to 59	0 to 59
<b>Example string</b>	1992	- 10	- 25	- 12	: 30	: 15

**Guidelines for entering strings**

- If any of the three required fields are not entered, the OK will not be set.
- The three optional fields will default to zero if nothing is entered in them.
- Whenever a field is entered, all fields to the left of it must also be entered.
- Every field must be separated by a delimiter character. Use dashes, colons, or commas. Alpha/numeric characters are not recommended.
- If a number is out of range, the OK will not be set. The function will return to the base of the calendar clock--1988-01-01:00:00:00.

To set the time of day clock in the control, use the DATE\_AND\_TIME output from the STR2D\_T function as the input to the IN on the CLOCK function.

---

---

**STR2NUM***String to Numeric***Datatype/STRCONV**

---

---

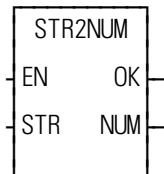
**Inputs:** EN (BOOL) - enables execution

STR (STRING) - STRING to convert (may include plus (+) or minus (-) sign)

**Outputs:** OK (BOOL) - execution completed without error

NUM (NUMERIC) - converted value

```
STR2NUM(STR := <<STRING>>, OK => <<BOOL>>, NUM =>
<<NUMERIC>>)
```

The STR2NUM function converts the STRING value of the variable at STR into a numeric value, and places the result into the variable at NUM. If the STRING contains non-numeric characters, other than + or -, the output at OK will not energize and the value of the variable at NUM will be unpredictable.

---

---

**STR2USI***String to Unsigned Short Integer***Data type/STRCONV**

---

---

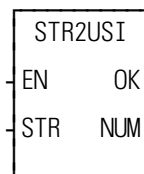
**Inputs:** EN (BOOL) - enables execution

STR (STRING) - string to convert

**Outputs:** OK (BOOL) - execution completed without error

NUM (USINT) - usint (ASCII code)

```
STR2USI(STR := <<STRING>>, OK => <<BOOL>>, NUM => <<USINT>>)
```

The STR2USI function converts the first character of the STRING value at STR into a USINT at NUM. Any ASCII character may be converted to USINT.

For example, if the string 'A' appears at STR, the value of NUM becomes 65.

The output at OK will not be energized if the actual length of the string at STR is zero (no characters).

**STRTSERV**

Start servo

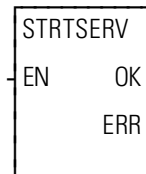
**Motion/INIT****Inputs:** EN (BOOL) - enables execution (**One-shot**)**Outputs:** OK (BOOL) - execution completed without error

ERR (USINT) - An integer indicates an error (See STRTSERV function error table below.)

STRTSERV(OK =&gt; &lt;&lt;BOOL&gt;&gt;, ERR =&gt; &lt;&lt;USINT&gt;&gt;)

**NOTE:** Use DSTRTSRV instead of STRTSV when programming an MMCD control.

The STRTSERV function is used with the user-defined setup function (USER\_SET) to initialize all the setup data for your application. When STRTSERV is activated it finds the setup data, initializes it, and places it in the RAM memory of the PiC. The servo software is then running and interrupts are occurring. Everything is ready for a ladder command for motion. A basic method of entering these two functions into your ladder is shown below.

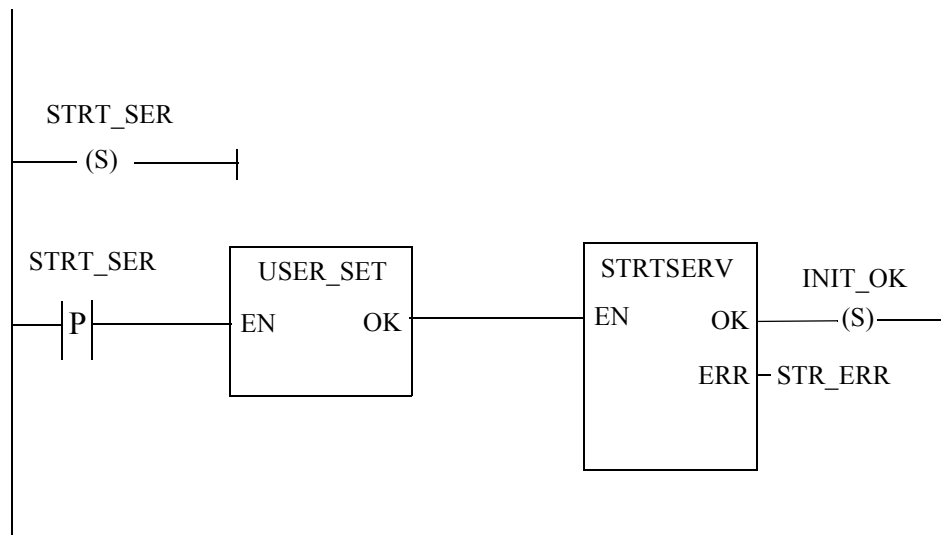

The positive transition contact (STRT\_SER) is used as a one shot and the set coil (INIT\_OK) latches the initialization OK for multiple scans.

When working with SERCOS axes, the user-defined setup function and STRTSERV should not be called until the SERCOS ring completes phase 4. The SERCOS ring phase can be determined via the SCR\_PHAS function.

The ERR output will contain one of the numbers listed in the table below.

<b>Table 2-14. Servo Initialization Errors</b>		
<b>ERR</b>	<b>Name</b>	<b>Description</b>
0	No error	
1	Bad user function data	The CPU is 486, all the axes are digitizing axes, and all are declared with a 16 msec update rate. Change at least one of the axes' update rates to something less than 16 msec.
2	Not enough low memory	There are too many axes called for in the user-defined setup function for the available memory.
3	Feedback module(s) not found	One or more feedback modules identified in setup cannot be found. This error will also occur if the channel selected is three or four and the feedback module in the rack is only a two channel module.
4	Analog module(s) not found	One or more analog output modules identified in setup cannot be found. This error will also occur if the channel selected is five through eight and the analog module in the rack is only a four channel module.
5	Update rate (SERCOS axis only)	The update rate of a SERCOS interface axis does not match the update rate of the SERCOS ring declared in SERCOS Setup.
6	Incorrect CPU type	The servo setup data was configured for the wrong controller and needs to be configured for the proper controller.
7	Wrong CPU	The CPU is not the required 486-based processor. You must either upgrade to a 486-based CPU or use a pre-11.0 release of the motion library.
8	Incompatible drive firmware	One or more of the digital drives contain firmware that is incompatible with the MMCD firmware.
9	Invalid firmware	The MMC for PC SERCOS Firmware returned an error
10	Address not found	The digital drive address specified in servo setup was not found. ERAX indicates the axis.
11	Duplicate address	More than one digital drive was found with the address specified in servo setup. ERAX indicates the axis.
12	Digital drive firmware too old	The digital drive firmware version is too old for this version of the motion.lib. ERAX indicates the axis.
13	Digital drive firmware too new	The digital drive firmware version is too new for this version of the motion.lib. ERAX indicates the axis.
14	No digital drives found	No digital drives were found.
15	Cyclic data sizes not identical	The digital drives' cyclic data sizes are not identical. This is due to incompatible firmware versions among the digital drives.

16	Cyclic failed to start	Cyclic data mode failed to start. This is due to a communication error between the MMCD and the digital drives. This could also be due to one or more digital drives failing to respond.
23	Outdated Servo Setup data	<p>The setup data was compiled with a version of PiCPro that is older than this version of STRTSERV and is incompatible with this version of STRTSERV. Open the Servo Setup file and recompile it.</p> <p>This error can also occur if the user-defined servo setup function is not called prior to calling STRTSERV.</p>
24	Newer Servo Setup data	<p>The Servo Setup data was compiled with a version of PiCPro that is newer than this version of STRTSERV and is incompatible with this version of STRTSERV. Upgrade PiCPro to the same (or newer) version that the Servo Setup data was compiled with. Or recompile the Servo Setup data with this version of PiCPro.</p> <p>This error can also occur if the user-defined servo setup function is not called prior to calling STRTSERV.</p>

**SUB**

Subtract

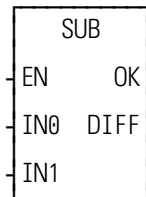
**Arith/ARITH****Inputs:** EN (BOOL) - enables execution

IN0 (NUMERIC or TIME duration) - minuend

IN1 (same type as IN0) - subtrahend

**Outputs:** OK (BOOL) - execution completed without error

DIFF (same type as IN0) - difference

SUB(IN0 := <<NUMERIC/TIME>>, IN1 := <<NUMERIC/TIME>>, OK =>  
 <<BOOL>>, DIFF => <<NUMERIC/TIME>>)

The SUB function subtracts the value of the variable or constant at IN1 from the value of the variable or constant at IN0, and places the result in the variable at DIFF.

X	IN0
<u>-Y</u>	IN1
Z	DIFF

**SYN\_END**

Synchronization End

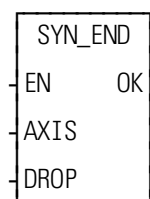
**Motion/RATIOMOV**

**Inputs:** EN (BOOL) - enables execution (**One-shot**)  
 AXIS (USINT) - identifies axis (servo)  
 DROP (DINT) - slave position when it is to drop out of synchronization  
 If DROP is outside the range of -536,870,912 to 536,870,911 FU, the OK will not be set.

**Outputs:** OK (BOOL) - execution completed without error

SYN\_END(AXIS := <<USINT>>, DROP := <<DINT>>, OK => <<BOOL>>)

The syn end function ends a ratio syn move. When it is called in the ladder, the slave axis will stop moving immediately when it reaches the position entered at the DROP input with no ramping.

A ratio syn move may also be stopped by aborting the move:

- with no move in the queue. The ratio syn move will ramp down at the default deceleration rate and motion will stop.

OR

- with another move in the queue. The velocity will ramp to the new move rate and continue with the new move, or the velocity will step and continue if a master/slave move is next.

**Note:** A ratio syn move may also be ended with a GR\_END function. However, you cannot specify a slave drop point with GR\_END.

---



---

**S\_DT\_DT**

*Subtract: Date and Time Minus Date and Time*

**Arith/DATETIME**

---



---

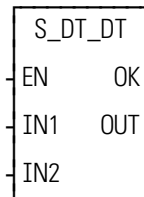

**Inputs:** EN (BOOL) - enables execution

IN1 (DATE\_AND\_TIME) - minuend

IN2 (DATE\_AND\_TIME) - subtrahend

**Outputs:** OK (BOOL) - execution completed without error

OUT (TIME duration) - difference

S\_DT\_DT(IN1 := <<DATE\_AND\_TIME>>, IN2 := <<DATE\_AND\_TIME>>, OK => <<BOOL>>, OUT => <<TIME>>)

The S\_DT\_DT function subtracts the value in the variable or constant at IN2 from the value in the variable or constant at IN1. The result is a TIME duration value that is placed in the variable at OUT.

**Example of subtract: DATE\_AND\_TIME minus DATE\_AND\_TIME**

Value at IN1	Value at IN2	Value at OUT
DT#1994-09-15-03:31:14	DT#1994-09-13-11:31:00	T#1d16h14s

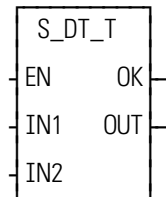

**S\_DT\_T***Subtract: Date and Time Minus Time***Arith/DATETIME**

**Inputs:** EN (BOOL) - enables execution  
 IN1 (DATE\_AND\_TIME) - minuend  
 IN2 (TIME) - subtrahend

**Outputs:** OK (BOOL) - execution completed without error  
 OUT (DATE\_AND\_TIME) - difference

S\_DT\_T(IN1 := <<BOOL>>, IN2 := <<TIME>>, OK => <<BOOL>>, OUT => <<DATE\_AND\_TIME>>)

The S\_DT\_T function subtracts the value in the variable or constant at IN2 from the value in the variable or constant at IN1. The result is a DATE\_AND\_TIME value that is placed in the variable at OUT.

**Example of subtract: DATE\_AND\_TIME minus TIME**

Value at IN1	Value at IN2	Value at OUT
DT#1994-09-15-03:31:14	T#1h	DT#1994-09-15-02:31:14

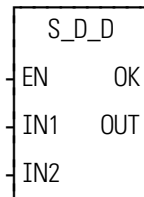
**S\_D\_D***Subtract: Date Minus Date***Arith/DATETIME****Inputs:** EN (BOOL) - enables execution

IN1 (DATE) - minuend

IN2 (DATE) - subtrahend

**Outputs:** OK (BOOL) - execution completed without error

OUT (TIME duration) - difference

S\_D\_D(IN1 := <<DATE>>, IN2 := <<DATE>>, OK => <<BOOL>>, OUT => <<TIME>>)

The S\_D\_D function subtracts the value in the variable or constant at IN2 from the value in the variable or constant at IN1. The result is a TIME duration value that is placed in the variable at OUT.

**Example of subtract: DATE minus DATE**

Value at IN1	Value at IN2	Value at OUT
DT#1991-06-04	D#1991-06-02	T#2d

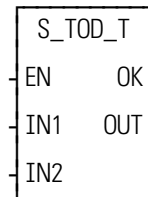
**S\_TOD\_T***Subtract: Time of Day minus Time***Arith/DATETIME****Inputs:** EN (BOOL) - enables execution

IN1 (TIME\_OF\_DAY) - minuend

IN2 (TIME duration) - subtrahend

**Outputs:** OK (BOOL) - execution completed without error

OUT (TIME\_OF\_DAY) - difference

S\_TOD\_T(IN1 := <<TIME\_OF\_DAY>>, IN2 := <<TIME>>, OK =>  
 <<BOOL>>, OUT => <<TIME\_OF\_DAY>>)

The S\_TOD\_T function subtracts the value of the variable or constant at IN2 from the value of the variable or constant at IN1. The result is a TIME\_OF\_DAY value that is placed in the variable at OUT.

**Example of subtract: TIME\_OF\_DAY minus TIME**

Value at IN1	Value at IN2	Value at OUT
TOD#14:57:34	T#4h54m23s	TOD#10:03:11

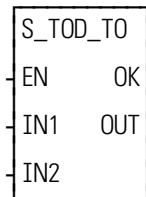
**S\_TOD\_TO***Subtract: Time of Day Minus Time of Day***Arith/DATETIME**

**Inputs:** EN (BOOL) - enables execution  
 IN1 (TIME\_OF\_DAY) - minuend  
 IN2 (TIME\_OF\_DAY) - subtrahend

**Outputs:** OK (BOOL) - execution completed without error  
 OUT (TIME duration) - difference

S\_TOD\_TO(IN1 := <<TIME\_OF\_DAY>>, IN2 := <<TIME\_OF\_DAY>>, OK => <<BOOL>>, OUT => <<TIME>>)

The S\_TOD\_TO function subtracts the value in the variable or constant at IN2 from the value in the variable or constant at IN1. The result is a TIME duration value that is placed in the variable at OUT.

**Example of subtract: TIME\_OF\_DAY minus TIME\_OF\_DAY**

Value at IN1	Value at IN2	Value at OUT
TOD#14:57:34	TOD#10:03:11	T#4h54m23s

**TAN**

Tangent

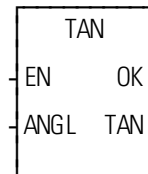
**Arith/TRIG**

**Inputs:** EN (BOOL) - enables execution  
ANGL (REAL/LREAL) - angle value (in radians)

**Outputs:** OK (BOOL) - execution completed without error  
TAN (REAL/LREAL) - tangent calculated

NOTE: The data types entered at ANGL and TAN must match, i.e. if ANGL is REAL, then TAN must be REAL.

TAN(ANGL := <<REAL/LREAL>>, OK => <<BOOL>>, TAN => <<REAL/LREAL>>, )

The TAN function calculates the tangent of the angle entered at ANGL. The result is placed at TAN.

**TAUFFAC**

Calculate a first order filter for TAUFILT

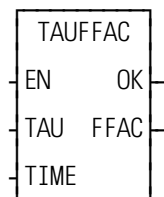
**PID/TAUFFAC**

**Inputs:** EN (BOOL) - enables execution  
TAU (TIME) - time constant TAU

TIME (TIME) - sample time T

**Outputs:** OK (BOOL) - function block OK  
FFAC (REAL) - filter factor

TAUFFAC(TAU := <<TIME>>, TIME := <<TIME>> OK => <<BOOL>>, FFAC => <<UDINT>>)

The TAUFFAC function calculates a first order filter factor to be used in the first order filter function TAUFILT. This block accepts as inputs the time constant TAU and the Sample Time T.

---



---

## TAUFILT

Provides a first order filter response

**PID/TAUFILT**

---



---

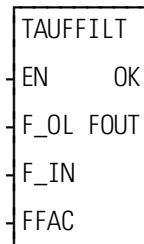

**Inputs:** EN (BOOL) - enables execution  
 F\_OL (REAL) - filter output last (previous value)  
 F\_IN (REAL) - filter input  
 FFAC (REAL) - filter factor from TAUFFAC

**Outputs:** OK (BOOL) - execution OK  
 FOUT (REAL) - filter output (current value)

TAUFILT(F\_OL := <<REAL>>, F\_IN := <<REAL>>, FFAC := <<REAL>>, OK => <<BOOL>>, FOUT => <<REAL>>)

The function TAUFILT provides a first order filter response  $(1 - e^{-t/TAU})$ . The filter factor FFAC is first calculated with the TAUFFAC function, then the filter can be called on a time basis as defined as the TAUFFAC function input. The input F\_OL must be set to the previous value of the output FOUT. The variable to be filtered is F\_IN.

---



---

## TIM2UDIN

Time to Unsigned Double Integer

**Datatype/D\_TCONV**

---



---

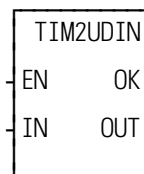

**Inputs:** EN (BOOL) - enables execution  
 IN (TIME) - time value to convert

**Outputs:** OK (BOOL) - execution completed without error  
 OUT (UDINT) - value in milliseconds

TIM2UDIN(IN := <<TIME>>, OK => <<BOOL>>, OUT => <<UDINT>>)

The TIM2UDIN function converts the TIME at IN to a UDINT at OUT. The units of the value at OUT are milliseconds.

For example, an IN value of T#10s results in an OUT of 10000 (milliseconds).

---



---

## TIME2STR

*Time to String*

**Datatype/D\_TCONV**

---



---

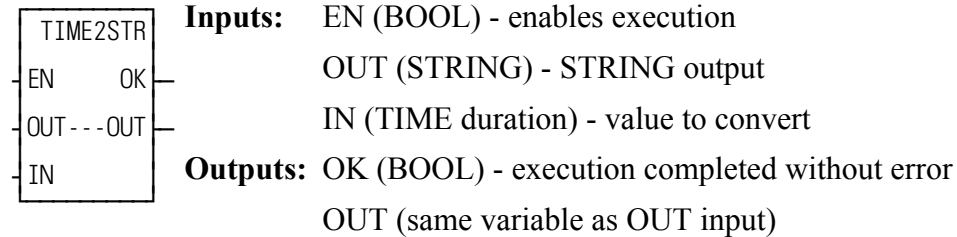

TIME2STR(OUT := <<STRING>>, IN := <<TIME>>, OK => <<BOOL>>, OUT => <<STRING>>)

The TIME2STR function converts the value in the variable or constant at IN to a STRING value. The result is placed in the variable at OUT.

### Example of TIME to STRING function

Value at IN1	Value at OUT
TOD#14:57:34	45d23h

**Note:** The minimum length entered in software declarations for the STRING at OUT must be 17 characters.

---

---

**TME\_ERR?**

Timing Error ?

**Motion/ERRORS**

---

---

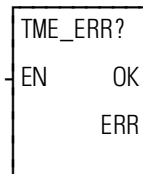
**Inputs:** EN (BOOL) - enables execution**Outputs:** OK (BOOL) - execution completed without error  
ERR (BOOL) - indicates a timing error has occurred if set

TIME\_ERR(OK =&gt; &lt;&lt;BOOL&gt;&gt;, ERR =&gt; &lt;&lt;BOOL&gt;&gt;)

The timing error inquiry asks if the time required to carry out the servo calculations exceeds the allotted interrupt time.

**IMPORTANT:** Set an E-stop on all axes when a timing error occurs.

---

---

**TOD2STR**

Time\_of\_Day to String

**Datatype/D\_TCONV**

---

---

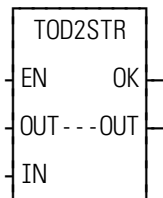
**Inputs:** EN (BOOL) - enables execution

OUT (STRING) - STRING output

IN (TIME\_OF\_DAY) - value to convert

**Outputs:** OK (BOOL) - execution completed without error

OUT (same variable as OUT input)

TOD2STR(OUT := &lt;&lt;STRING&gt;&gt;, IN := &lt;&lt;TIME\_OF\_DAY&gt;&gt;, OK =&gt; &lt;&lt;BOOL&gt;&gt;, OUT =&gt; &lt;&lt;STRING&gt;&gt;)

The TOD2STR function converts the value in the variable or constant at IN to a STRING value. The result is placed in the variable at OUT.

**Example of TIME\_OF\_DAY to STRING function**

Value at IN1	Value at OUT
TOD#16:27:45	16:27:45



**TOF**

Timer Off

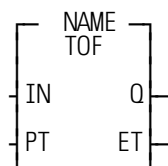
**Timers/TOF****Inputs:** IN (BOOL) - enables execution

PT (TIME duration) - preset time (minimum 10ms)

**Outputs:** Q (BOOL) - energized from the time IN is energized until preset time (PT) elapses then deenergizes

ET (TIME duration) - elapsed time

```
<<INSTANCE NAME>>:TOF(IN := <<BOOL>>, PT := <<TIME>>, Q =>
  <<BOOL>>, ET => <<TIME>>)
```

The TOF function block de-energizes an output after a duration of time. When the input at IN is energized, the output at Q is energized. When power to IN drops, the output at Q stays energized until the time specified by the variable or constant at PT has passed. Then the output at Q is deenergized. The amount of time that has passed is placed into the variable at ET, as the time passes.

If power flow to the point at IN occurs before the preset value is reached, the counting is stopped and the output at Q is not deenergized.

To enter a constant at the PT (preset time) input, type T# followed by the amount and type [d (day), h (hour), m (minute), s (second), ms (millisecond)]. For example, to enter a preset time of 5 seconds type the following at PT:

T#5s

**Note:** A variable declared in software declarations can also be used at PT.

**TON**

Timer On

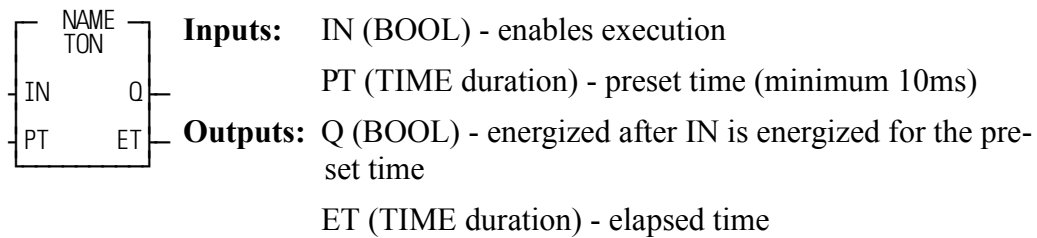
**Timers/TON**

```
<<INSTANCE NAME>>:TON(IN := <<BOOL>>, PT := <<TIME>>, Q =>
  <<BOOL>>, ET => <<TIME>>)
```

The TON function block energizes an output after a duration of time. The output at Q is energized after the input at IN has been energized for the amount of time specified by the variable or constant at PT. The count starts when the block begins executing (power flow occurs at IN). The variable at ET contains the amount of time that has passed, as it passes.

If power flow to the point at IN drops before the preset value is reached, the counting is stopped and the output at Q does not energize. If power flow to the point at IN drops after Q has been energized, Q is deenergized immediately.

To enter a constant at the PT (preset time) input, type T# followed by the amount and type [d (day), h (hour), m (minute), s (second), ms (millisecond)]. For example, to enter a preset time of 5 seconds type the following at PT:

T#5s

**Note:** A variable declared in software declarations can also be used at PT.

**TP**

Timer Pulse

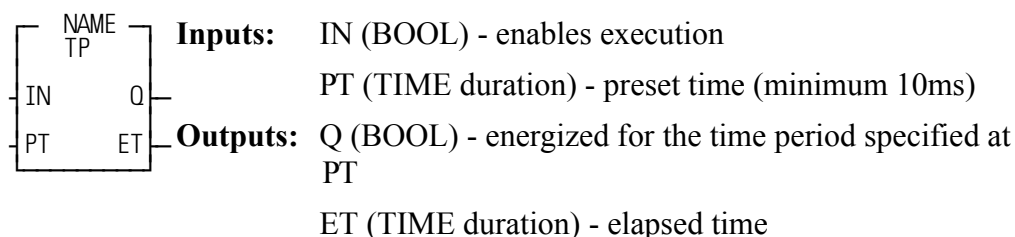
**Timers/TP**

```
<<INSTANCE NAME>>:TP(IN := <<BOOL>>, PT := <<TIME>>, Q =>
  <<BOOL>>, ET => <<TIME>>)
```

The TP function block energizes an output for a duration of time. The output at Q is energized when power flow occurs at IN. Q remains energized for the amount of time specified by the variable or constant at PT, regardless of the power flow at IN. The variable at ET holds the amount of time that has elapsed since the output at Q was energized.

To enter a constant at the PT (preset time) input, type T# followed by the amount and type [d (day), h (hour), m (minute), s (second), ms (millisecond)]. For example, to enter a preset time of 5 seconds type the following at PT:

T#5s

**Note:** A variable declared in software declarations can also be used at PT.

---



---

**TUNERead**

Tune Read

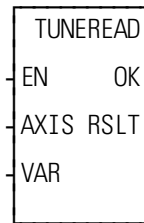
**Motion/DATA****Inputs:** EN (BOOL) - enables execution (**Typically one-shot**)

AXIS (USINT) - identifies axis (servo)

VAR (SINT) - number of variable to read

**Outputs:** OK (BOOL) - execution complete without error

RSLT (DINT) - servo data read

TUNERead(AXIS := <<USINT>>, VAR := <<SINT>>, OK => <<BOOL>>, RSLT => <<DINT>>)

The TUNERead function allows you to read from your LDO the variables listed in the table in TUNEWRT. These are the same variables that can be read on the servo setup view list.

The slow speed filter variable 5 is the only TUNERead variable that can be used with a stepper axis, a SERCOS axis, or a digital drive axis.

**TUNEWRIT**

Tune Write

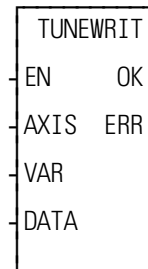
**Motion/DATA****Inputs:** EN (BOOL) - enables execution (**Typically one-shot**)

AXIS (USINT) - identifies axis (servo)

VAR (SINT) - number of variable to write to

DATA (DINT) - servo data to write

**Outputs:** OK (BOOL) - execution complete without error

ERR (INT) - 0 if data transfer is successful

1 to 3 if data transfer is unsuccessful

TUNEWRIT(AXIS := <<USINT>>, VAR := <<SINT>>, DATA := <<DINT>>, OK => <<BOOL>>, ERR => <<INT>>)

The TUNEWRIT function allows you to change the variables listed in the table below from your LDO. These are the same variables that can be changed with the servo setup force list. The slow speed filter variable 5 is the only TUNEWRIT variable that can be used with a stepper axis, a SERCOS axis, or a digital drive axis.

**VARIABLES AVAILABLE FOR THE TUNE READ/WRITE FUNCTIONS****Key for the variable table**

**V#** - identifies the variable number you enter in the tune read and/or write functions at VAR.

**R** column- indicates the variable can be used with the tune read function.

**W** column- indicates the variable can be used with the tune write function.

**S** = initialized servo axis

V #	Definition	R	W
1	<b>Proportional Gain</b> - Proportional gain calibrates corrective action proportional to the amount of following error. The value written/read represents the axis units per minute for each axis unit of following error. . Range: 0 - 20000	S	S
2	<b>Integral Gain</b> - Integral gain determines corrective action proportional to the amount of following error summed over the time duration of the error. The longer the following error exists, the greater the integral error. The value written/read represents the number of axis units per minute per axis unit of following error times minutes. Range: 0 - 32000	S	S

3	<p><b>Derivative Gain</b> - Derivative gain determines the corrective action proportional to the magnitude of change of the following error. The value written/read represents the number of axis units per minute for each axis unit of following error per minute.</p> <p>Range: 0 - 1000</p>	S	S
4	<p><b>Offset</b> - If it is not possible to get a zero volts reading from a voltmeter placed across the analog output channel for the axis, write the amount of voltage in millivolts that allows you to reach a zero reading.</p> <p>Range: -10000 to 10000 mV</p>	S	S
5	<p><b>Slow Speed Filter</b> - Write the milliseconds the filter will take to smooth out a “step” change in velocity while the axis is moving at slow velocities.</p> <p><b>NOTE:</b> Specifically, the value entered represents the milliseconds that the servo software takes to carry out 63.2% of the step change.</p> <p>Range: 0 - 10000 ms</p>	S	S
6	<p><b>Feed Forward Percent</b> - Write a percentage (from 0 to 100%) that you want the position loop to compensate for the lag that occurs between the generation of the following error and the correction of that error by the PID calculations.</p> <p>Range: 0 - 100%</p>	S	S

The outputs at ERR of TUNEWRT are listed below.

**Err # Description**

- 0 No error
- 1 Axis is not initialized, axis number is out of range, or the variable is not supported by this type of an axis (e.g. stepper, SERCOS, or digital drive axis).
- 2 Variable is not from 1 through 6
- 3 Data is out of range or value cannot be calculated.

**NOTE**

When using the TUNEREAD AND TUNEWRIT functions, note that: The values you enter with TUNEWRIT are stored in the PiC memory as approximate conversions. Therefore, there may be some discrepancy when these values are read back with TUNEREAD.

Calculated values are stored directly in the PiC memory and used to issue servo commands. Be aware that when gains are changed, it has an immediate effect on the axis. The D/A signal may step to a new voltage causing the axis to jump. The larger the change, the greater the jump.

If Servo Setup Force and the TUNEREAD and TUNEWRIT are all being used, the last data written from any source will be what is in effect.

**Note:** The CPU must have a math coprocessor in order to use the TUNEREAD and TUNEWRIT functions. The axis must be an initialized servo axis.

---



---

## UDIN2DI

*Unsigned Double Integer to Double Integer*

**Datatype/UDINTCNV**

---



---

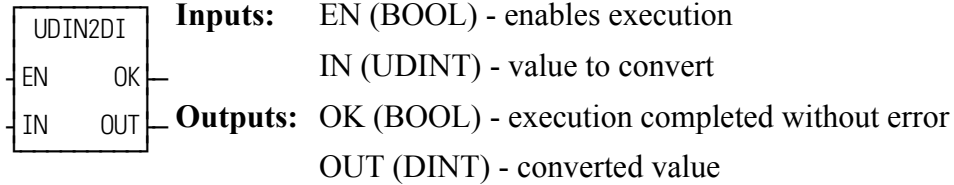

UDIN2DI(IN := <<UDINT>>, OK => <<BOOL>>, OUT => <<DINT>>)

The UDIN2DI function changes the data type of the value at IN from an unsigned double integer to a double integer. The result is placed in the variable at OUT.

---



---

## UDIN2DW

*Unsigned Double Integer to Double Word*

**Datatype/UDINTCNV**

---



---

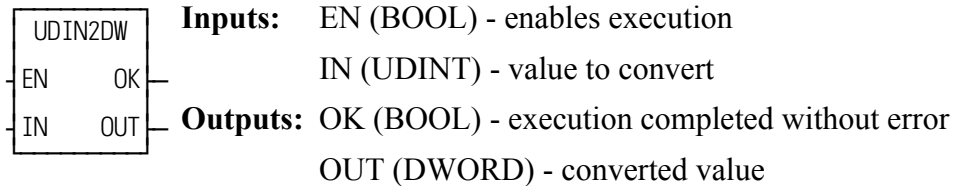

UDIN2DW(IN := <<UDINT>>, OK => <<BOOL>>, OUT => <<DWORD>>)

The UDIN2DW function changes the data type of the value at IN from an unsigned double integer to a double word. The result is placed in the variable at OUT.



---



---

## UDIN2RE

*Unsigned Double Integer to Real*

**Datatype/UDINTCNV**

---



---

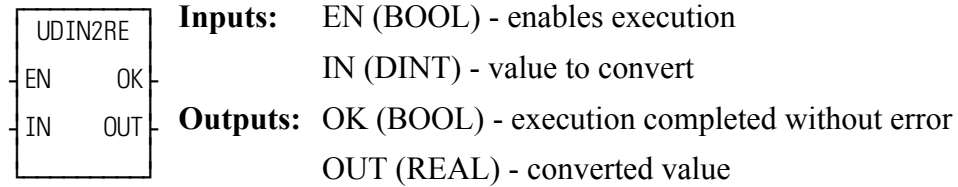

UDIN2RE(IN := <<DINT>>, OK => <<BOOL>>, OUT => <<REAL>>)

The UDIN2RE function converts an unsigned double integer into a real. The result is placed in a variable at OUT.

---



---

## UDIN2TIM

*Unsigned Double Integer to Time*

**Datatype/UDINTCNV**

---



---

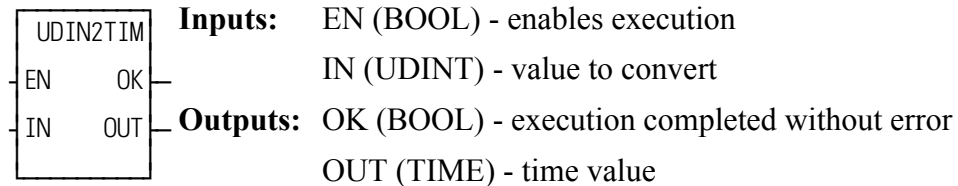

UDIN2TIM(IN := <<UDINT>>, OK => <<BOOL>>, OUT => <<TIME>>)

The UDIN2TIM function converts the UDINT or constant at IN to TIME. The units of the value at IN are milliseconds.

For example, an IN value of 10000 (milliseconds) results in an OUT of T#10s.

---



---

## UDIN2UI

*Unsigned Double Integer to Unsigned Integer*

**Datatype/UDINTCNV**

---



---

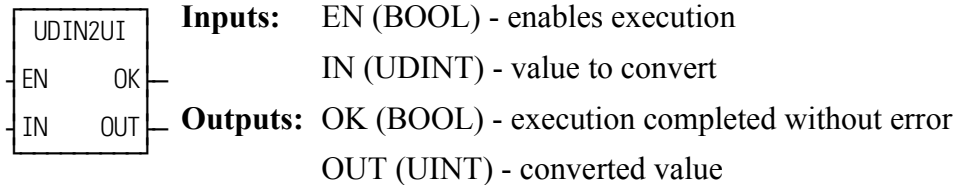

UDIN2UI(IN := <<UDINT>>, OK => <<BOOL>>, OUT => <<UINT>>)

The UDIN2UI function changes the data type of the value at IN from an unsigned double integer to an unsigned integer. The leftmost 16 bits of the unsigned double integer are truncated. The result is placed in the variable at OUT.

---



---

## UDIN2ULI

*Unsigned Double Integer to Unsigned Long Integer*

**Datatype/UDINTCNV**

---



---

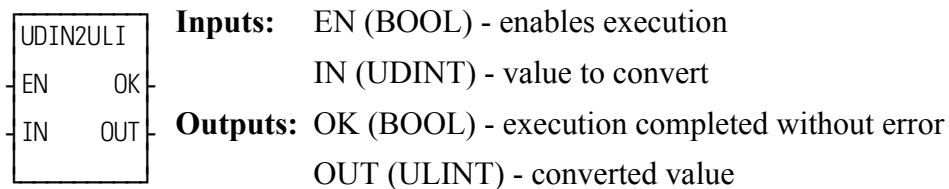

UDIN2ULI(IN := <<UDINT>>, OK => <<BOOL>>, OUT => <<ULINT>>)

The UDIN2ULI function converts an unsigned double integer into an unsigned long integer. The leftmost 32 bits of the unsigned long integer are filled with zeros. The result is placed in a variable at OUT.

## UDIN2USI

Unsigned Double Integer to Unsigned Short Integer

**Datatype/UDINTCNV**

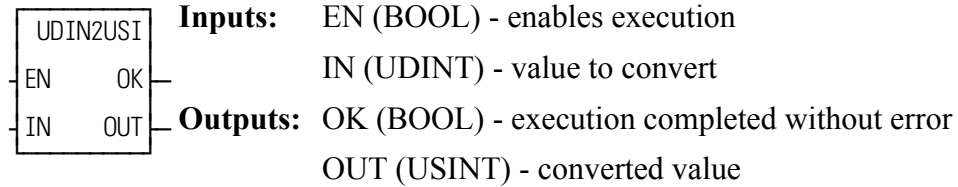

UDIN2USI(IN := <<UDINT>>, OK => <<BOOL>>, OUT => <<USINT>>)

The UDIN2USI function changes the data type of the value at IN from an unsigned double integer to an unsigned short integer. The leftmost 24 bits of the unsigned double integer are truncated. The result is placed in the variable at OUT.

## UINT2INT

Unsigned Integer to Integer

**Datatype/UINTCONV**

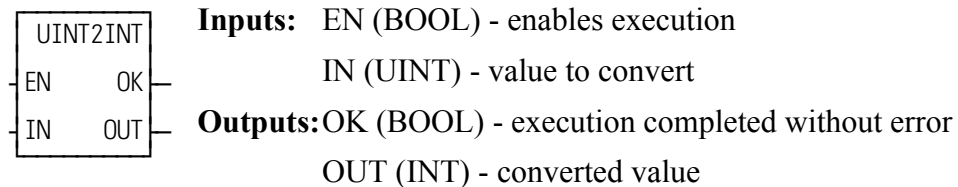

ANLG\_OUT(RACK := <<USINT>>, SLOT := <<USINT>>, CHAN := <<USINT>>, VALU := <<INT>>, OK => <<BOOL>>, OPEN => <<BOOL>>)

The UINT2INT function changes the data type of the value at IN from an unsigned integer to an integer. The result is placed in the variable at OUT.

---



---

## UINT2UDI

Unsigned Integer to Unsigned Double Integer

**Datatype/UINTCONV**

---



---

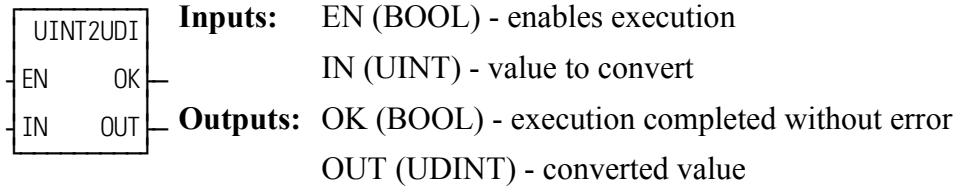

UINT2UDI(IN := <<UINT>>, OK => <<BOOL>>, OUT => <<UDINT>>)

The UINT2UDI function changes the data type of the value at IN from an unsigned integer to an unsigned double integer. The leftmost 16 bits of the unsigned double integer are filled with zeros. The result is placed in the variable at OUT.

---



---

## UINT2ULI

Unsigned Integer to Unsigned Long Integer

**Datatype/UINTCONV**

---



---

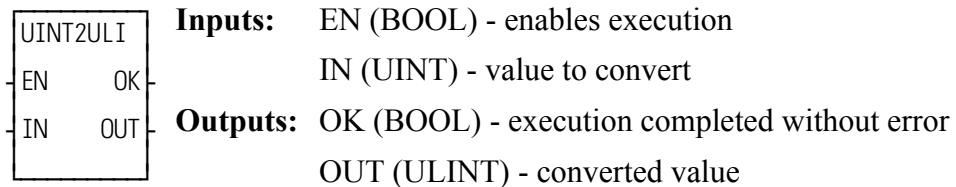

UINT2ULI(IN := <<UINT>>, OK => <<BOOL>>, OUT => <<ULINT>>)

The UINT2ULI function converts an unsigned integer into an unsigned long integer. The leftmost 48 bits of the unsigned long integer are filled with zeros. The result is placed in a variable at OUT.

---



---

## UINT2USI

*Unsigned Integer to Unsigned Short Integer*

**Datatype/UINTCONV**

---



---

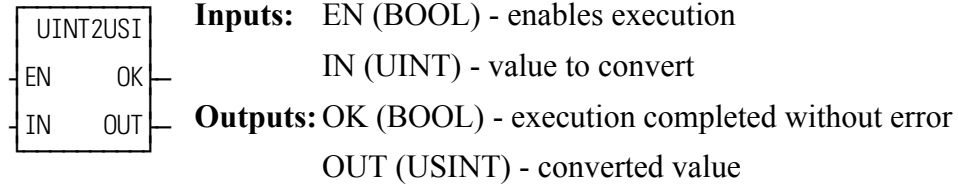

UINT2USI(IN <<UINT>>, OK => <<BOOL>>, OUT => <<USINT>>)

The UINT2USI function changes the data type of the value at IN from an unsigned integer to an unsigned short integer. The leftmost 8 bits of the unsigned integer are truncated. The result is placed in the variable at OUT.

---



---

## UINT2WO

*Unsigned Integer to Word*

**Datatype/UINTCONV**

---



---

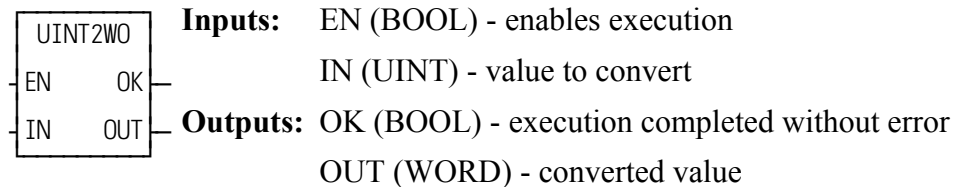

UINT2WO(IN := <<UINT>>, OK => <<BOOL>>, OUT => <<WORD>>)

The UINT2WO function changes the data type of the value at IN from an unsigned integer to a word. The result is placed in the variable at OUT.

---



---

## ULIN2LI

*Unsigned Long Integer to Long Integer*

**Datatype/ULINTCNV**

---



---

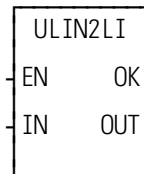

**Inputs:** EN (BOOL) - enables execution

IN (ULINT) - value to convert

**Outputs:** OK (BOOL) - execution completed without error

OUT (LINT) - converted value

ULIN2LI(IN := <<ULINT>>, OK => <<BOOL>>, OUT => <<LINT>>)

The ULIN2LI function converts an unsigned long integer into a long integer. The result is placed in a variable at OUT.

---



---

## ULIN2LR

*Unsigned Long Integer to Long Real*

**Datatype/ULINTCNV**

---



---

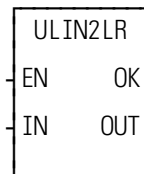

**Inputs:** EN (BOOL) - enables execution

IN (ULINT) - value to convert

**Outputs:** OK (BOOL) - execution completed without error

OUT (LREAL) - converted value

ULIN2LR(IN := <<ULINT>>, OK => <<BOOL>>, OUT => <<LREAL>>)

The ULIN2LR function converts an unsigned long integer into a long real. The result is placed in a variable at OUT.

---



---

## ULIN2LW

*Unsigned Long Integer to Long Word*

**Datatype/ULINTCNV**

---



---

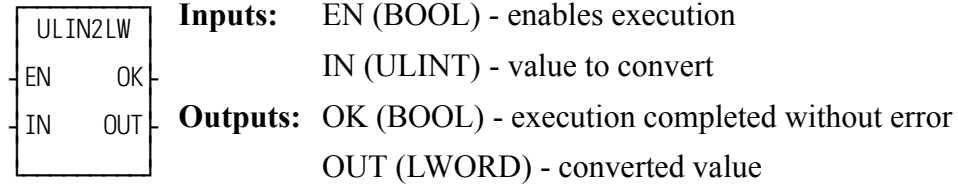

ULIN2LW(IN := <<ULINT>>, OK => <<BOOL>>, OUT => <<LWORD>>)

The ULIN2LW function converts an unsigned long integer into a long word. The result is placed in a variable at OUT.

---



---

## ULIN2UDI

*Unsigned Long Integer to Unsigned Double Integer*

**Datatype/ULINTCNV**

---



---

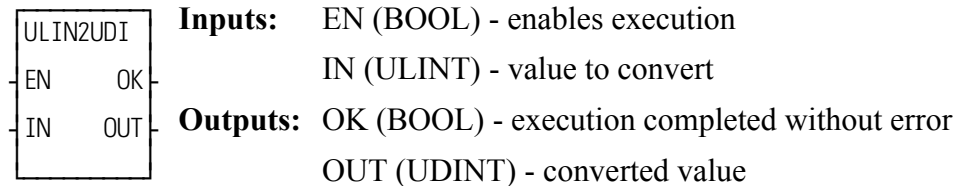

ULIN2UDI(IN := <<ULINT>>, OK => <<BOOL>>, OUT => <<UDINT>>)

The ULIN2UDI function converts an unsigned long integer into a unsigned double integer. The leftmost 32 bits of the unsigned long integer are truncated. The result is placed in a variable at OUT.

---



---

## ULIN2UI

*Unsigned Long Integer to Unsigned Integer*

**Datatype/ULINTCNV**

---



---

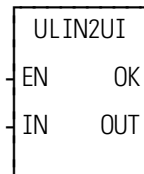

**Inputs:** EN (BOOL) - enables execution

IN (ULINT) - value to convert

**Outputs:** OK (BOOL) - execution completed without error

OUT (UINT) - converted value

ULIN2UI(IN := <<ULINT>>, OK => <<BOOL>>, OUT => <<UINT>>)

The ULIN2UI function converts an unsigned long integer into a unsigned integer. The leftmost 48 bits of the unsigned long integer are truncated. The result is placed in a variable at OUT.

---



---

## ULIN2USI

*Unsigned Long Integer to Unsigned Short Integer*

**Datatype/ULINTCNV**

---



---

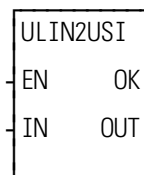

**Inputs:** EN (BOOL) - enables execution

IN (ULINT) - value to convert

**Outputs:** OK (BOOL) - execution completed without error

OUT (USINT) - converted value

ULIN2USI(IN := <<ULINT>>, OK => <<BOOL>>, OUT => <<USINT>>)

The ULIN2USI function converts an unsigned long integer into a unsigned short integer. The leftmost 56 bits of the unsigned long integer are truncated. The result is placed in a variable at OUT.



---



---

## UPR\_CASE

Upper Case

String/UPR\_CASE

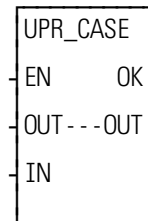

**Inputs:** EN (BOOL) - enables execution  
 OUT (STRING) - output STRING  
 IN (STRING) - string of characters to convert to upper case

**Outputs:** OK (BOOL) - execution completed without error  
 OUT (same variable as OUT input) - converted string

UPR\_CASE(OUT := <<STRING>>, IN := <<STRING>>, OK => <<BOOL>>, OUT => <<STRING>>)

The UPR\_CASE function converts the characters in a string to all upper case characters. The result is placed in the string at OUT.

The OK will not be set if the number of characters in the string at IN is larger than the maximum number of characters you have declared in the string at OUT.

See also LWR\_CASE function.

---



---

## USIN2BYT

Unsigned Short Integer to Byte

Datatype/USINTCNV

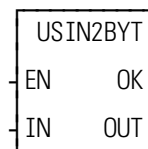

**Inputs:** EN (BOOL) - enables execution  
 IN (USINT) - value to convert

**Outputs:** OK (BOOL) - execution completed without error  
 OUT (BYTE) - converted value

USIN2BYT(IN := <<USINT>>, OK => <<BOOL>>, OUT => <<BYTE>>)

The USIN2BYT function changes the data type of the value at IN from an unsigned short integer to a byte. The result is placed in the variable at OUT.

---



---

## USIN2SI

Unsigned Short Integer to Short Integer

**Datatype/USINTCNV**

---



---

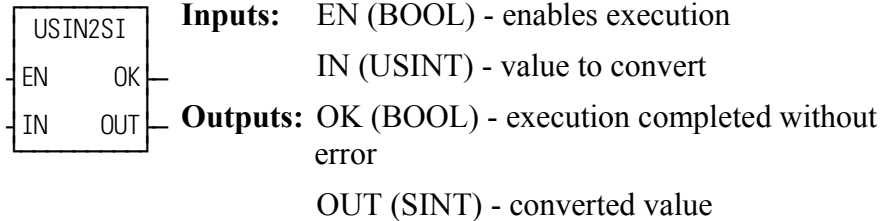

USIN2SI(IN := <<USINT>>, OK => <<BOOL>>, OUT => <<SINT>>)

The USIN2SI function changes the data type of the value at IN from an unsigned short integer to a short integer. The result is placed in the variable at OUT.

---



---

## USIN2STR

Unsigned Short Integer (ASCII Code) to String

**Datatype/USINTCNV**

---



---

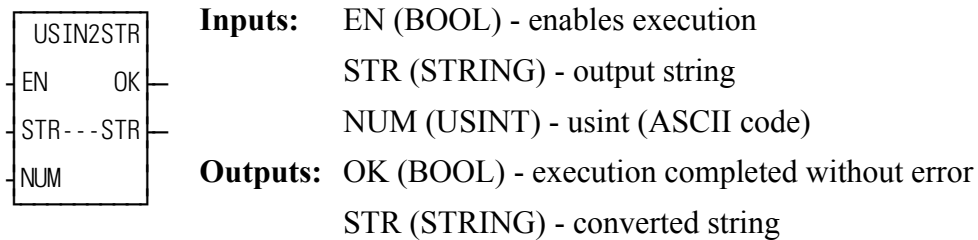

USIN2STR(STR := <<STRING>>, NUM := <<USINT>>, OK => <<BOOL>>, STR => <<STRING>>)

The USIN2STR function converts the USINT or constant at NUM into the first character of the STRING at STR. Any ASCII code may be converted to STRING.

For example, if NUM = 65, the first character of STRING becomes 'A'.

**Note:** The string at STR will always be a one-character string.

---



---

## USIN2UDI

*Unsigned Short Integer to Unsigned Double Integer*

**Datatype/USINTCNV**

---



---

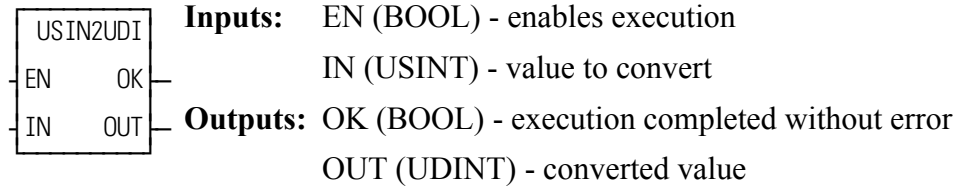

USIN2UDI(IN := <<USINT>>, OK => <<BOOL>>, OUT => <<UDINT>>)

The USIN2UDI function changes the data type of the value at IN from an unsigned short integer to an unsigned double integer. The leftmost 24 bits of the unsigned double integer are filled with zeros. The result is placed in the variable at OUT.

---



---

## USIN2UI

*Unsigned Short Integer to Unsigned Integer*

**Datatype/USINTCNV**

---



---

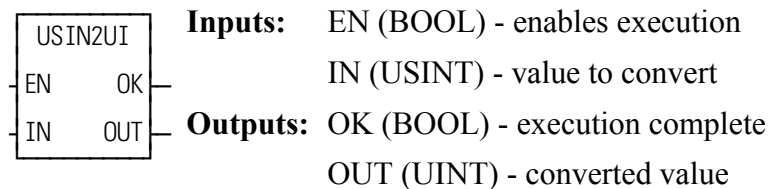

USIN2UI(IN := <<USINT>>, OK => <<BOOL>>, OUT => <<UINT>>)

The USIN2UI function changes the data type of the value at IN from an unsigned short integer to an unsigned integer. The leftmost 8 bits of the unsigned integer are filled with zeros. The result is placed in the variable at OUT.

---



---

## USIN2ULI

Unsigned Short Integer to Unsigned Long Integer

**Datatype/USINTCNV**

---



---

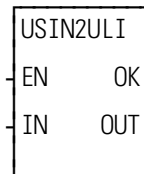

**Inputs:** EN (BOOL) - enables execution

IN (USINT) - value to convert

**Outputs:** OK (BOOL) - execution completed without error

OUT (ULINT) - converted value

USIN2ULI(IN := <<USINT>>, OK => <<BOOL>>, OUT => <<ULINT>>)

The USIN2ULI function converts an unsigned short integer into an unsigned long integer. The leftmost 56 bits of the unsigned long integer are filled with zeros. The result is placed in a variable at OUT.

---



---

## VEL\_END

Velocity End

**Motion/MOVE**

---



---

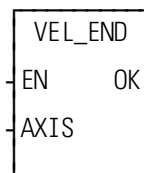

**Inputs:** EN (BOOL) - enables execution (**One-shot**)

AXIS (USINT) - identifies axis (servo or time)

**Outputs:** OK (BOOL) - execution completed without error

VEL\_END(AXIS := <<USINT>>, OK => <<BOOL>>)

The velocity end function is required to stop a move started by the VEL\_STRT function.

When used on a servo axis, the ACC/DEC will be a ramp, unless S-Curve interpolation is enabled via Servo-Setup or the WRITE\_SV function.

**VEL\_STRT**

Velocity Start

**Motion/MOVE**

VEL_STRT	<b>Inputs:</b>	EN (BOOL) - enables execution ( <b>one-shot</b> )
EN    OK		AXIS (USINT) - identifies axis (servo or time)
AXIS  QUE		PLUS (BOOL) - indicates direction of motion
PLUS		RATE (UDINT) - feedrate at which motion occurs (entered in LU/MIN)
RATE	<b>Outputs:</b>	OK (BOOL) - execution completed without error
		QUE (USINT) - number of velocity start move for queue

```
VEL_STRT(AXIS := <<USINT>>, PLUS := <<BOOL>>, RATE :=
<<UDINT>>, OK => <<BOOL>>, QUE => <<USINT>>)
```

The velocity start function moves an axis at a specified feedrate and direction. If the input at PLUS is set, then movement occurs in the positive direction as defined for your system. If it is not set, then movement occurs in the negative direction. When the velocity move is used with a time axis, the S\_CURVE function must be called first.

To end a velocity start move you must include the VEL\_END function in your ladder program.

**IMPORTANT**

Remember that a VEL\_END function only ends the velocity move in the active queue. A VEL\_END function *never* ends the velocity move in the next queue. Only call the VEL\_END function when the velocity move you want to end is in the active queue.

When used on a servo axis, the ACC/DEC will be a ramp, unless S-Curve interpolation is enabled via Servo-Setup or the WRITE\_SV function.

---

---

**VFASTIN***Virtual Fast Input***Motion/MOVE\_SUP**

---

---

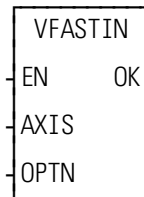
**Inputs:** EN (BOOL) - enables execution (**one-shot**)

AXIS (USINT) - identifies virtual axis

OPTN (UINT) - options

**Outputs:** OK (BOOL) - execution completed without error

VFASTIN(AXIS := &lt;&lt;USINT&gt;&gt;, OPTN := &lt;&lt;UINT&gt;&gt;, OK =&gt; &lt;&lt;BOOL&gt;&gt;)

The VFASTIN function generates a virtual fast input for a virtual axis. This can be used to simulate a fast input for the REGIST, MEASURE, FAST\_REF, and FAST\_QUE functions with a virtual axis. When executing a FAST\_REF on the index mark after the fast input, this function will generate both the fast input event and the index event simultaneously.

When the EN input is energized, a fast input will be generated for the virtual axis specified at the AXIS input. This axis must be a virtual axis (i.e. “Virtual” is specified as the Input Type and Output Type in Servo Setup.) The OPTN input exists for future enhancements and must be 0.

---



---

## WORD2BYT

Word to Byte

**Datatype/WORDCONV**

---



---

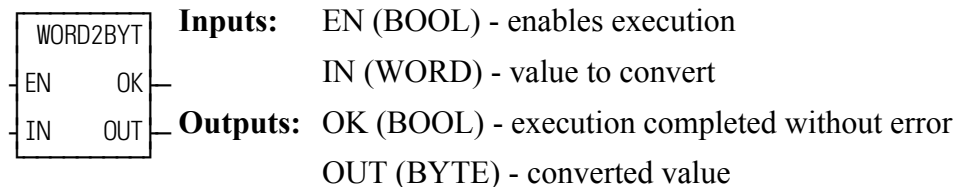

WORD2BYT(IN := <<WORD>>, OK => <<BOOL>>, OUT => <<BYTE>>)

The WORD2BYT function changes the data type of the value at IN from a word to a byte. The leftmost 8 bits of the word are truncated. The result is placed in the variable at OUT.

---



---

## WORD2DW

Word to Double Word

**Datatype/WORDCONV**

---



---

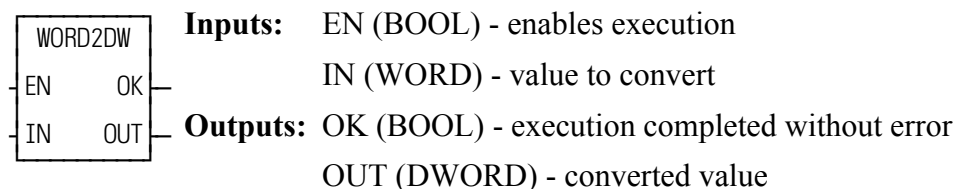

WORD2DW(IN := <<WORD>>, OK => <<BOOL>>, OUT => <<DWORD>>)

The WORD2DW function changes the data type of the value at IN from a word to a double word. The leftmost 16 bits of the double word are filled with zeros. The result is placed in the variable at OUT.

---



---

## WORD2INT

Word to Integer

**Datatype/WORDCONV**

---



---

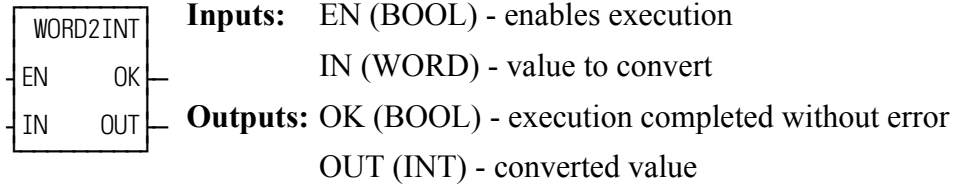

WORD2INT(IN := <<WORD>>, OK => <<BOOL>>, OUT => <<INT>>)

The WORD2INT function changes the data type of the value at IN from a word to an integer. The result is placed in the variable at OUT.

---



---

## WORD2LW

Word to Long Word

**Datatype/WORDCONV**

---



---

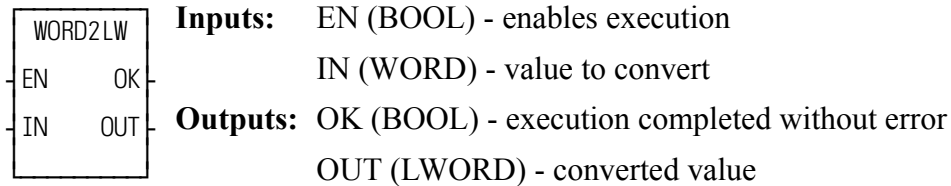

WORD2LW(IN := <<WORD>>, OK => <<BOOL>>, OUT => <<LWORD>>)

The WORD2LW function converts a word into a long word. The leftmost 48 bits of the long word are filled with zeros. The result is placed in a variable at OUT.



---

---

## WORD2UI

Word to Unsigned Integer

**Datatype/WORDCONV**

---

---

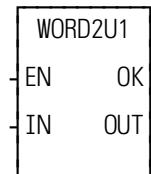

**Inputs:** EN (BOOL) - enables execution

IN (WORD) - value to convert

**Outputs:** OK (BOOL) - execution completed without error

OUT (UINT) - converted value

WORD2UI(IN := <<WORD>>, OK => <<BOOL>>, OUT => <<UINT>>)

The WORD2UI function changes the data type of the value at IN from a word to an unsigned integer. The result is placed in a variable at OUT.

---

---

**WRITE**

Write

**IO/COMM**

---

---

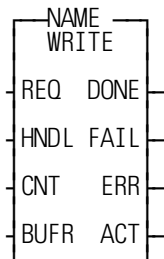

**Inputs:** REQ (BOOL) - enables execution (**One-shot**)  
 HNDL (INT) - output from OPEN function block  
 CNT (INT) - number of bytes to write  
 BUFR (MEMORY AREA) - to write data from  
*MEMORY AREA* is a STRING, ARRAY, STRUCTURE, ARRAY ELEMENT, or STRUCTURE MEMBER

**Outputs:** DONE (BOOL) - energized if ERR = 0  
 not energized if ERR ≠ 0  
 FAIL (BOOL) - energized if ERR ≠ 0  
 not energized if ERR = 0  
 ERR (INT) - 0 if data transfer successful  
 ≠ 0 if data transfer unsuccessful  
*See Appendix B in the PiCPro Online Help for ERR codes.*  
 ACT (INT) - number of bytes written

```
<<INSTANCE NAME>>:WRITE(REQ := <<BOOL>>, HNDL := <<INT>>,
  CNT := <<INT>>, BUFR := <<MEMORY AREA>>, DONE => <<BOOL>>,
  FAIL => <<BOOL>>, ERR => <<INT>>, ACT => <<INT>>);
```

The WRITE function block writes data to the file or device at the User Port specified by the input at HNDL. It writes the number of bytes specified by the value at CNT, from the variable at BUFR. It replaces or writes over any existing data in a file. The number of bytes actually written is placed into the variable at ACT. ACT will be less than CNT when the number of bytes in the variable at BUFR is less than CNT, or when there is an error. Otherwise the value of ACT will equal the value of CNT.

WRITE is used in conjunction with the CLOSE, CONFIG, OPEN, READ, SEEK, and STATUS I/O function blocks.

**Note:** The FMSDISK does not support the WRITE function block.

---



---

## WRITE\_SV

Write Servo

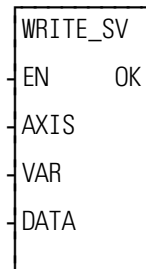
**Motion/DATA**

**Inputs:** EN (BOOL) - enables execution (typically one-shot)  
 AXIS (USINT) - identifies axis (servo, digitizing, or time)  
 VAR (SINT) - variable to be written to  
 DATA (DINT) - servo data to be written to

**Outputs:** OK (BOOL) - execution completed without error

```
WRITE_SV(AXIS := <<USINT>>, VAR ::= <<SINT>>, DATA := <<DINT>>,
         OK => <<BOOL>>)
```

The WRITE\_SV function allows the specified variable (VAR) to be written with DATA for the specified axis.

Refer to the Variable Table in the READ\_SV function for a listing of variables that can be written to using the WRITE\_SV function.

---

---

**WRIT\_SVF***Write Servo Fast***Motion/DATA**

---

---

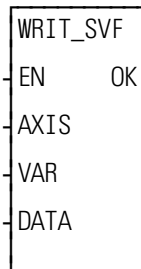

**Inputs:** EN (BOOL) - enables execution  
 AXIS (USINT) = identifies axis (servo, digitizing, or time)  
 VAR (SINT) = variable to be written to  
 DATA (DINT) = servo data to be written

**Outputs:** OK (BOOL) - execution completed without error

WRIT\_SVF(AXIS := <<USINT>>, VAR := <<SINT>>, DATA := <<DINT>>, OK => <<BOOL>>)

The write servo fast function allows the specified variable (VAR) to be written with DATA for the specified axis. The WRIT\_SVF function performs the write faster than the WRITE\_SV function. It consumes less CPU time in exchange for some features. Less verification is performed on the inputs to WRIT\_SVF. All values that involve velocity or distance are in feedback units and updates rather than ladder units and minutes.

Refer to the Variables Table in the READ\_SV function for a listing of variables that can be written to using the WRITE\_SVF function.

NOTE: Because of minimal error checking, calling WRIT\_SVF without first initializing axes using STRTSERV will corrupt memory and cause unexpected results.

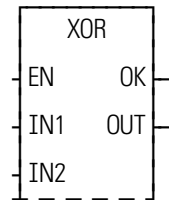
**XOR***Exclusive Or***Binary/XOR****Inputs:** EN (BOOL) - enables execution

IN1 (BITWISE) - number to be XORed

IN2 (same type as IN1) - number to be XORed

**Outputs:** OK (BOOL) - execution completed without error

OUT (same type as IN1) - XORed number

XOR(IN1 := <<BITWISE>>, IN2 := <<BITWISE>>, OK => <<BOOL>>, OUT => <<BITWISE>>)

The XOR function exclusive ORs the variable or constant at IN1 with the variable or constant at IN2, and places the results in the variable at OUT. This is an extensible function which can XOR up 17 inputs.

If two inputs of the XOR function are different, the output is 1. If two inputs are the same, the output is 0. See the example below.

**Example of XOR function with a value at IN1 and IN2:**

11000011	value at IN1
<u>10101010</u>	value at IN2
01101001	value at OUT

If a third value would be at IN3, it would be XORed with the first two as shown below (this would continue with each additional input).

11000011	value at IN1
<u>10101010</u>	value at IN2
01101001	result
<u>11001100</u>	value at IN3
10100101	value at OUT

**XOR**

## **A.1 - Operator Interface ASFB**

---

Your TrueView and Cimrex operator interface device requires the following ASFBs in your LDO to set up communications between the PiC and the operator interface device.

---

---

# OI\_SER

Operator Interface Serial

USER/OI

---

---

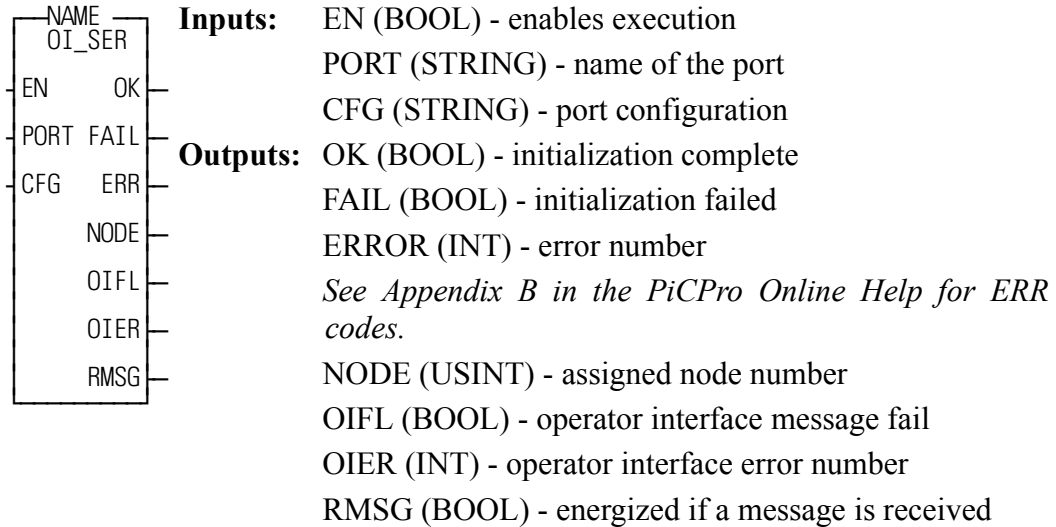

```
<<INSTANCE NAME>>:OI_SER(EN := <<BOOL>>, PORT := <<STRING>>,  
  CFG := <<STRING>>, OK => <<BOOL>>, FAIL => <<BOOL>>, ERROR =>  
  <<INT>>, NODE => <<USINT>>, OIFL => <<BOOL>>, OIER => <<INT>>,  
  RMSG => <<BOOL>>);
```

The OI\_Serial function block implements the communication protocol between the PiC and a Cimrex or TrueView operator interface device. It handles RS232 and RS422 serial communication.

The EN input causes an I/O port to be opened and configured based on the other inputs. When enabled, the function block will then be ready to receive a protocol message from the operator interface device. Dropping the enable input will cause the I/O port to be closed.

The PORT input defines the name of the serial port to be used for communications. The standard port on any MMC or PiC900 family CPU is 'USER:\$00'. The port name is entered as a string. If a port on a Serial Communication Module is to be used, the module must be assigned in the main ladder using the ASSIGN function block. The port name used as the input to the ASSIGN function block would also be passed as the PORT input.

The CFG input defines the characteristics of the port defined at the PORT input. Values are the same as for the CONFIG function block.

Baud rate	Parity	Data bits	Stop bits	Synch mode	Terminator
9600,	N,	8,	1,	N	\$00



String = 9600,N,8,1,N\$00

If you need to change the default values for the parameters at the CFG string input, refer to the table of acceptable values found at the CONFIG function block.

The OK output is set if the function block was successful in opening and configuring the serial port. It is latched and reset only when the enable is dropped and enabled again.

The FAIL output is set if the function block was not successful in opening and configuring the serial port. It is latched and reset only when the enable is dropped and enabled again.

The ERR output contains an error number if the FAIL output is set. These errors are listed in Appendix B of the PiCPro Online Help.

The NODE output contains the node number specified at the /OI command line switch. It is provided for information purposes only. If no node number has been entered, the output will be "0".

The OIFL output is the operator interface message fail. It is set for one scan when a failure occurs attempting to process a command from the operator interface.

The OIER output is the operator interface error number. When OIFL is set, this output will hold one of the following error codes. This error number corresponds to the Remote error number displayed at the bottom of the operator interface device

The RMSG output is energized for one scan when a message is received from the OI..

**Code Description**

- 1 Data Table Mismatch** - The OID file used in the operator interface configuration does not match the PiC's data table.
- 2 Index Number Out of Range** - The index number of the data element requested by the operator interface is beyond the end of the PiC's data table.
- 3 Invalid Data Size** - The specified data size of a specific data element requested by the operator interface does not match the data size of that data element in the PiC's data table.
- 4 Response Message Too Long** - The length of the response string generated within OI\_SER exceeds the declared length of the response string.

## NOTES

## **B.1 - OPC Server ASFB**

---

The OPC [OLE (Object Linking and Embedding) for Process Control] Server was designed to read and write data to and from the control via Ethernet.

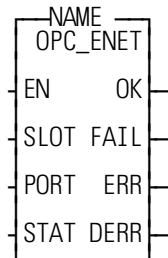

**Inputs:** EN (BOOL) - enables execution, set every scan  
SLOT (USINT) - slot number of Ethernet - TCP/IP module in rack  
PORT (UINT) - UDP protocol port number  
Choose any available UDP port above 1024.  
STAT (STRUCT) - status of last message received

**Outputs:** OK (BOOL) - execution complete  
FAIL (BOOL) - error, execution incomplete  
ERR (INT) - error number from IP functions that occurred during execution  
DERR (INT) - data transfer errors

```
<<INSTANCE NAME>>:OPC_ENET(EN := <<BOOL>>, SLOT :=  
  <<USINT>>, PORT :=<<UINT>>, STAT:=<<MEMORY AREA>>, OK =>  
  <<BOOL>>, FAIL => <<BOOL>>, ERR => <<INT>>, DERR => <<INT>>);
```

The OPC\_ENET function block enables the control to communicate with the G&L Motion Control OPC Server. It provides a protocol for this communication and error checking capabilities for the data sent. Any OPC compliant client can be used with the OPC server.

The function block is configured as a UDP server. It will service incoming UDP requests but will not solicit information from other controls or PCs.

All the variables to be passed to the OPC Server via this function block must be declared globally within the ladder. For more information on setting up the OPC server, refer to the OPC Server Manual.

When the EN input is set, a UDP socket is created on the TCP/IP module defined in SLOT. It binds that socket to the PORT. It services requests for read or write data from an OPC server.

The PORT input defines the port to be used for Ethernet communications. You must assign an available port number above 1024. Use this same number in your OPC setup to ensure that communications will be established.

The STAT input provides status or debug information on the last message received. It includes a valid message BOOL that can be used to re-trigger a watch dog timer.

The OK output is set if the function block was successful in opening and configuring the port.

The FAIL output is set if the function block was not successful in opening and configuring the port.

The ERR output contains an error number if the FAIL output is set. These are the same errors that can occur in the IP function/function blocks.

```

STAT STRUCT                               Status of the last message received
.ValidMsg          BOOL                   Indicates that a valid message was received
                                                (one shot)
.InvalidMsg        BOOL                   Indicates that an invalid message was
                                                received (one shot)
.Command           BYTE                   2 = Read, 3 = Write
.ClientIPAddr      STRING[25]            IP Address of the Client that sent the last
                                                message
.CheckSum          INT                    Checksum, used to verify the size of the
                                                Structure, set the Initial Value to 12345
END_STRUCT

```

### IMPORTANT

The last data variable CheckSum must be included in the structure with the initial value set to 12345. This memory location with a known value is used by the ASFB to verify the size of the structure. If the structure is not the correct size, an error will be reported upon initialization.

Note: All ten checksum elements must have the initial value set to 12345.

ERR#	Description	ERR#	Description
0	No error	40	Destination address required
1	Not owner	41	Protocol wrong type for socket
2	No such file or directory	42	Protocol not available
3	No such process	43	Protocol not supported
4	Interrupted system call	44	Socket type not supported
5	I/O error	45	Operation not supported on socket
6	No such device or address	46	Protocol family not supported
7	Arg list too long	47	Address family not supported
8	Exec format error	48	Address already in use
9	Bad file number	49	Can't assign requested address
10	No children	50	Socket operation on non-socket
11	No more processes	51	Network is unreachable
12	Not enough core	52	Network dropped connection on reset

<b>13</b>	Permission denied	<b>53</b>	Software caused connection abort
<b>14</b>	Bad address	<b>54</b>	Connection reset by peer
<b>15</b>	Directory not empty	<b>55</b>	No buffer space available
<b>16</b>	Mount device busy	<b>56</b>	Socket is already connected
<b>17</b>	File exists	<b>57</b>	Socket is not connected
<b>18</b>	Cross-device link	<b>58</b>	Can't send after socket shutdown
<b>19</b>	No such device	<b>59</b>	Too many references: can't splice
<b>20</b>	Not a directory	<b>60</b>	Connection timed out
<b>21</b>	Is a directory	<b>61</b>	Connection refused
<b>22</b>	Invalid argument	<b>62</b>	Network is down
<b>23</b>	File table overflow	<b>63</b>	Text file busy
<b>24</b>	Too many files open	<b>64</b>	Too many levels of symbolic links
<b>25</b>	Not a typewriter	<b>65</b>	No route to host
<b>26</b>	File name too long	<b>66</b>	Block device required
<b>27</b>	File too large	<b>67</b>	Host is down
<b>28</b>	No space left on device	<b>68</b>	Operation now in progress
<b>29</b>	Illegal seek	<b>69</b>	Operation already in progress
<b>30</b>	Read-only file system	<b>70</b>	Operation would block
<b>31</b>	Too many links	<b>71</b>	Function not implemented
<b>32</b>	Broken pipe	<b>72</b>	Operation cancelled
<b>33</b>	Resource deadlock avoided	<b>1000</b>	There is a non-zero terminated string which requires zero termination or a zero length string.
<b>34</b>	No locks available	<b>1001</b>	There is a CNT input which is too large.
<b>35</b>	Unsupported value	<b>1002</b>	The SLOT number requested does not contain an Ethernet board.
<b>36</b>	Message size	<b>1003</b>	Either the firmware does not support TCP/IP or there is no Ethernet board in the rack.
<b>37</b>	Argument too large	<b>1004</b>	The IPZ buffer is too small.
<b>38</b>	Result too large	<b>1005</b>	A TCP/IP function was terminated due to a TCP/IP stack failure. The socket the function block is using is no longer valid. *

### **NOTE**

A ladder with Ethernet functions loaded on an MMC for PC requires the IPSTAT function to reset the connection to the host. The other PiC CPU models have an external Ethernet module (with it's own TCP/IP stack) and do not require IPSTAT.

The DERR output is a data transfer error and can contains one of the numbers listed below.

#### **Code Description**

- 1 Data Table Mismatch** - The message has an invalid CRC value. The OID file used in the OPC server configuration does not match the PiC's data table.
- 2 Index Number Out of Range** - The index number of the data element requested by the OPC server is beyond the end of the PiC's data table.
- 3 Invalid Data Size** -The specified data size of a specific data element requested by the OPC does not match the data size of that data element in the PiC's data table.
- 4 Output Oversize** - More than 500 bytes of data have been requested in one UDP packet.
- 5 Byte Count Wrong** - The byte count of the request message from the OPC server is inconsistent with the requested data (incomplete message).
- 6 Invalid STAT Structure Checksum** - The STAT structure is not the correct size. Check the number of elements, data types and initial values.

---

---

## OPC\_10

OPC Server with 10 ports

**USER/OPC\_ENET**

---

---

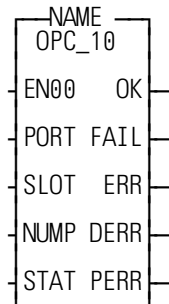

**Inputs:** EN00 (BOOL) - enable execution, set every scan  
PORT (UINT) - first UDP protocol port number  
(number must be over 1024)  
SLOT (USINT) - slot number of Ethernet module  
NUMP (UINT) - number of ports to open for the OPC  
Server (from 1 to 10)  
STAT (STRUCT(0..9)) - status of last message received

**Outputs:** OK (BOOL) - execution complete without any errors  
FAIL (BOOL) - ethernet error was detected  
ERR (INT) - ethernet error number  
DERR (INT) - data transfer error number  
PERR (USINT) - port number with above error numbers  
(in a range of 0 to 9)

```
<<INSTANCE NAME>>:OPC_10(EN00 := <<BOOL>>, PORT := <<UINT>>,  
SLOT := <<USINT>>, NUMP := <<UINT>>, STAT[0] := <<MEMORY  
AREA>>, OK => <<BOOL>>, FAIL => <<BOOL>>, ERR => <<INT>>,  
DERR => <<INT>>, PERR => <<USINT>>);
```

This function block extends the support for the G&L Motion Control OPC Server (Version 2.0 or later) to use up to 10 UDP protocol ports. This function block contains several OPC\_ENET function blocks to provide this support. The additional UDP ports allow for data transfer rates up to 10 times higher than the standard OPC\_ENET function block.

All the variables to be passed to the OPC Server via this function block must be declared globally (the G attribute in the software declarations) within the main ladder. For more information on setting up the OPC Server, refer to the OPC Server Manual.

The PORT input defines the first UDP protocol port to be used for the Ethernet communications with the OPC Server. You must assign an available port number above 1024. Use this same number in your OPC Server setup to ensure that communications will be established.

The SLOT input indicates the slot number for the Ethernet module used for the Ethernet communications with the OPC Server.



The NUMP input defines how many UDP protocol ports will be opened using the OPC\_ENET function block. The value at NUMP must match the number of ports for the device properties in the OPC Server configuration. The UDP protocol ports used by this function block will have consecutive values beginning at the PORT value. For example, if the value at PORT is 1234 and the value at NUMP is 3, then the OPC communications will occur on UDP ports 1234, 1235 and 1236. IF NUMP is greater than 10, then PERR will be 99 and ERR will be 9999.

The OK is set as long as none of the OPC\_ENET function blocks has detected an error. As soon as one of them has detected an error, OK will be reset and FAIL will be set.

The values for the ERR and DERR outputs are defined in the tables with the OPC\_ENET function block description. The PERR output defines which port number is associated with the ERR and DERR errors. As PERR values begin at 0, add the PERR value to the PORT value to determine which particular protocol port is involved in the error.

STAT STRUCT(0..9)		Status of the last message received
.ValidMsg	BOOL	Indicates that a valid message was received (one shot)
.InvalidMsg	BOOL	Indicates that an invalid message was received (one shot)
.Command	BYTE	2 = Read, 3 = Write
.ClientIPAddr	STRING[25]	IP Address of the Client that sent the last message
.Checksum	INT	Checksum, used to verify the size of the Structure, set the Initial Value to 12345
END_STRUCT		

<b>IMPORTANT</b>
The last data variable CheckSum must be included in the structure with the initial value set to 12345. This memory location with a known value is used by the ASFB to verify the size of the structure. If the structure is not the correct size, an error will be reported upon initialization.

## **NOTES**

## C.1 - Temperature Function Errors

---

ERR	Description
0	No error.
1	The RACK input is invalid.
2	A rack hardware fault occurred
3	The SLOT input is invalid.
4	The module specified is not an analog temperature module
5	The CHAN input is invalid.
6	A module hardware fault occurred.
7	The channel is currently being initialized. Try again later. <b>Note:</b> This error can occur if the ladder continually attempts to initialize a channel.
8	A mathematical overflow occurred when converting the counts to temperature or millivolts.
9	The RNGE input is invalid.
10	The $\mu$ SEC input is invalid.
11	A temperature underflow occurred. This indicates an open thermocouple or the temperature read is below the limits of the hardware. <b>Note:</b> There is no open indication for grounded thermocouples.
12	A temperature overflow occurred. The temperature read is above the limits of the hardware.
13	The HNDL input is invalid.
14	The VALU output is outside the range specified by the initialization function. <b>Note:</b> This error can also occur if the thermocouple is open.



# **INDEX**

## **Symbols**

±10V DC output module 2-11, 2-13

## **Numerics**

4-20 mA output 2-13

4-20 mA output module 2-11, 2-13

## **A**

A\_DT\_T function 1-7, 2-31

A\_IN\_MMC function 1-32, 2-32

A\_INCHIT function 1-32, 2-33  
errors 2-35

A\_INCHRD function block 1-32, 2-36  
errors 2-37

A\_INMDIT function 1-32, 2-40  
errors 2-40

A\_TOD\_T function 1-7, 2-41

abort move 2-3

ABRTALL function 1-51, 2-2

ABRTMOVE function 1-51, 2-2

ABS function 1-6, 2-3

acc/dec rates  
limits 2-4

ACC\_DEC function 1-50, 2-4

ACC\_JERK function 2-5

ACOS function 1-8, 2-9

ADD function 1-6, 2-9, 2-456

algorithm

independent gains 2-218  
ISA 2-218

analog

functions 1-32

analog output

units 2-14, 2-15  
volts 2-14, 2-15

AND function 1-9, 2-10

ANLG\_OUT function 1-33, 2-13

anlgin group functions 1-32

ANLGINIT function 1-33, 2-11

anlgout group functions 1-33

anti-reset windup 2-217, 2-225

APPEND mode 2-207

arith group functions 1-6

arithmetic

arith

ABS 2-3

ADD 2-9, 2-456

DIV 2-94

MOD 2-187

MUL 2-189

NEG 2-191

datetime

A\_DT\_T 2-31

A\_TOD\_T 2-41

S\_DT\_DT 2-458

S\_DT\_T 2-459

S\_TOD\_T 2-461

functions 1-6

trig

ACOS 2-9

ASIN 2-22

ATAN 2-25

COS 2-78

EXP 2-112

LN 2-177

LOG 2-177

SIN 2-422

TAN 2-463

ARTDCHIT function 1-41, 2-17

errors 2-18

ARTDCHRD function block 1-41, 2-19

errors 2-20

ARTDMDIT function 1-41, 2-21

errors 2-21

ASIN function 1-8, 2-22

ASSIGN function block 1-36, 2-23

errors 2-24

ATAN function 1-8, 2-25

ATMPCHIT function 1-37, 2-26

errors 2-27

ATMPCHRD function block 1-37, 2-28

errors 2-29

ATMPMDIT function 1-37, 2-30

errors 2-30

## **B**

BAT\_OK? function 1-34, 1-35, 2-43

binary

AND 2-10

functions 1-9

- NOT 2-204
- OR 2-210
- ROL 2-367
- ROR 2-368
- SHL 2-420
- SHR 2-421
- XOR 2-495
- BIO\_PERF function block 2-43
- bipolar
  - example 2-39
  - range 2-34
- bit
  - rotate functions 1-9
  - shift functions 1-9
- BOOL2BYT function 1-11, 2-46
- BOOL2BYTE group function 1-11, 1-22
- BTMPCHIT function 1-37, 2-47
- BTMPCHRD function 2-48, 2-50
- BTMPCHRD function block 1-37
- BTMPMGR function 1-37
- buffer 2-295
- bumpless transfer 2-214, 2-223
- BYT2BOOL function 1-11, 2-51
- BYTE2DW function 1-11, 2-52
- BYTE2LW function 1-11, 2-52
- BYTE2SI function 1-11, 2-53
- BYTE2USI function 1-11, 2-53
- BYTE2WO function 1-11, 2-54
- byteconv group functions 1-11

**C**

- C\_ERRORS function 1-47, 2-81
- C\_RESET function 1-47, 2-83
- C\_STOP function 1-47, 2-83
  - errors 2-82
- C\_STOP? function 1-47, 2-84
- cam output
  - conditions 2-56
  - example 2-58
- CAM\_OUT function 1-50, 2-55
- CAPTINIT function 1-44, 2-59
  - errors 2-61
- CAPTSTAT function 1-44, 2-65
- Celsius 2-28
- changing ratios
  - RATIO\_GR 2-201
  - RATIO\_RL 2-201
  - RATIOSLP 2-201
  - RATIOSYN 2-201
- clock
  - get time 2-66
  - set 2-66
- CLOCK function 1-57, 2-66
- CLOSE function block 1-36, 2-67
- CLOSLOOP function 1-48, 2-68
- CLSLOOP? function 1-48, 2-69
- comm group function blocks 1-36
- communication parms 2-71
- comparison
  - ratio moves 2-294
  - RATIOSLP, RATIOCAM, RATIOPRO 2-262
- CONCAT function 1-55
  - errors 2-70
- CONFIG function block 1-36, 2-71
- COORD2RL function 1-44, 2-74, 2-286
  - errors 2-77
  - structures 2-74
- COS function 1-8, 2-78
- counter function blocks 1-10
- counters
  - CTD 2-78
  - CTU 2-79
  - CTUD 2-80
- C-stop
  - define 1-46
  - errors
    - bit locations 2-82
    - hex value 2-82
- CTD function block 1-10, 2-78
- CTU function block 1-10, 2-79
- CTUD function block 1-10, 2-80

**D**

- d\_tconv group functions 1-14
- D\_TOD2DT function 1-14, 2-110
- data
  - send/receive 1-36
- data capture
  - tasks 2-60
  - variables
    - actual position 2-62

- command change 2-62, 2-63
- commanded position 2-62
- fast input occurred 2-62
- feedback position 2-62
- filter error 2-62
- position change 2-62, 2-63
- position error 2-62
- prefilter command change 2-62, 2-63
- prefilter commanded 2-62
- remaining master offset 2-63
- remaining slave offset 2-63

datatype

- BOOL2BYT 2-46
- byteconv
  - BYT2BOOL 2-51
  - BYTE2DW 2-52
  - BYTE2LW 2-52
  - BYTE2SI 2-53
  - BYTE2USI 2-53
  - BYTE2WO 2-54
- d\_tconv
  - D\_TOD2DT 2-110
  - DATE2STR 2-85
  - DT2DATE 2-102, 2-103
  - DT2STR 2-103
  - DT2TOD 2-104
  - TIM2UDIN 2-464
- dintconv
  - DINT2DW 2-88
  - DINT2INT 2-88
  - DINT2LI 2-89
  - DINT2SI 2-90
  - DINT2UDI 2-90
- dwordconv
  - DWOR2BYT 2-107
  - DWOR2DI 2-108
  - DWOR2LW 2-108
  - DWOR2RE 2-109
  - DWOR2UDI 2-109
  - DWOR2WO 2-110
- intconv
  - INT2DINT 2-141
  - INT2LINT 2-141
  - INT2SINT 2-142
  - INT2UINT 2-142
  - INT2WORD 2-143
- lintconv
  - LINT2DI 2-174
  - LINT2INT 2-174
  - LINT2LR 2-175
  - LINT2LW 2-175
  - LINT2SI 2-176
  - LINT2ULI 2-176
- lrealconv
  - LREA2LI 2-178
  - LREA2LW 2-178
  - LREA2RE 2-179
  - LREA2ULI 2-179
- lwordconv
  - LWOR2BYT 2-181
  - LWOR2DW 2-182
  - LWOR2LR 2-183
  - LWOR2WO 2-184
  - LWORD2ULI 2-183
- NUM2STR 2-205
- realconv
  - REAL2DI 2-347
  - REAL2DW 2-347
  - REAL2LR 2-348
  - REAL2UDI 2-348, 2-349
- sintconv
  - SINT2BYT 2-422
  - SINT2DI 2-423
  - SINT2INT 2-423
  - SINT2LI 2-424
  - SINT2USI 2-424
- strconv
  - STR2NUM 2-452
  - STR2USI 2-452
- udintconv
  - UDIN2DI 2-474
  - UDIN2DW 2-474
  - UDIN2RE 2-475
  - UDIN2TIM 2-475
  - UDIN2ULI 2-476
- uintconv
  - UINT2ULI 2-478
- ulintconv
  - ULIN2LI 2-480
  - ULIN2LR 2-480
  - ULIN2LW 2-481
  - ULIN2UDI 2-481

- ULIN2UI 2-482
- ULIN2USI 2-482
- usintcnv
  - USIN2STR 2-484
  - USIN2ULI 2-486
- wordcnv
  - WORD2BYT 2-489
  - WORD2DW 2-489
  - WORD2INT 2-490
  - WORD2LW 2-490
  - WORD2UI 2-491
- datatype functions 1-11
- DATE2STR function 1-14, 2-85
- datetime group functions 1-7
- deadband 2-217, 2-224
- DELETE function 1-55, 2-86
- DELFIL function block 1-36, 2-87
- derivative 2-214
  - control 2-214
- DeviceNet
  - if status code 2-131
  - if status flags 2-131
  - network status 2-130
  - network status flags 2-130
- digitizing axes 2-168, 2-241, 2-252, 2-261, 2-274, 2-284, 2-287, 2-309, 2-315, 2-317, 2-319, 2-320, 2-324
- DINT2DW function 1-12, 2-88
- DINT2INT function 1-12, 2-88
- DINT2LI function 1-12, 2-89
- DINT2RE function 1-12
- DINT2SI function 1-12, 2-90
- DINT2UDI function 1-12, 2-90
- dintcnv group functions 1-12
- DIRECT function block 1-36, 2-91
- DISTANCE function 1-49, 2-93
- DIV function 1-6, 2-94
- DLS\_INIT function block 1-44
- DLS\_RECV function block 1-44
- DLS\_SEND function 1-44
- DLS\_STAT function block 1-44
- DNS (Domain Name Server) 2-152, 2-154
- DOS
  - file read/write 1-36
- DPOSMODE function 1-49, 2-100
- DRSETFLT function 1-48

- DRSTRTSRV function 1-48
- DT2DATE function 1-14, 2-102, 2-103
- DT2STR function 1-14, 2-103
- DT2TOD function 1-14, 2-104
- DTORQCMD function 1-49, 2-105
- DVELCMD function 1-49, 2-106
- DWOR2BYT function 1-13, 2-107
- DWOR2DI function 1-13, 2-108
- DWOR2LW function 1-13, 2-108
- DWOR2RE function 1-13, 2-109
- DWOR2UDI function 1-13, 2-109
- DWOR2WO function 1-13, 2-110
- dwordcnv group functions 1-13

## E

- E\_ERRORS function 1-47, 2-113
- E\_RESET function 1-47, 2-115
- E\_STOP function 1-47, 2-115
- E\_STOP? function 1-47, 2-116
- encoder 2-120, 2-167
  - ignore index 2-121, 2-168
- end a move
  - ratio gear 2-137
  - syn end 2-457
  - vel end 2-486
- EQ function 1-28, 2-105, 2-106, 2-111
- ERR errors 2-407
- error (registration)
  - accumulate 2-355
- errors
  - C-stop 1-46
  - ERR 2-407
  - E-stop 1-46
  - programming 1-46
  - SERCOS 2-407
  - SERR 2-410
  - temperature function C.1 - 1
  - timing 1-46
- E-stop
  - define 1-46
  - errors
    - bit locations 2-114
    - hex value 2-114
  - reset 2-115
- ethernet-TCP/IP
  - errors 2-164



ethernet-TCP/IP functions

- IPACCEPT 2-148
- IPCLOSE 2-149
- IPCONN 2-150
- IHOST 2-151
- IPIP2NAM 2-152
- IPLISTEN 2-153
- IPNAM2IP 2-154
- IPREAD 2-155
- IPRECV 2-156
- IPSEND 2-158
- IPSOCK 2-159
- IPWRITE 2-161

evaluate

- EQ 2-105, 2-106, 2-111
- GE 2-135
- GT 2-138
- LE 2-170
- LT 2-180
- NE 2-191

evaluate functions 1-28

EXP function 1-8, 2-112

**F**

Fahrenheit 2-28

FAST\_QUE function 1-51, 2-117, 2-233  
programming error 2-118, 2-233  
uses 2-117

FAST\_REF function 1-53, 1-54, 1-55, 2-120

FB\_CLS function block 1-30, 2-125

FB\_OPN function block 1-30, 2-126

FB\_RCV function 1-30, 2-127

FB\_SND function 1-30, 2-128

FB\_STA function 1-30, 2-129

feedrate

change

all moves 2-369

field bus function/blocks

- FB\_CLS 2-125
- FB\_OPN 2-126
- FB\_RCV 2-127
- FB\_SND 2-128
- FB\_STA 2-129

filter

- LIMIT 2-173
- MAX 2-185

MIN 2-187

MOVE 2-188

MUX 2-190

SEL 2-418

filter functions 1-30

filter value

derivative 2-216

proportional 2-216

FIND function 1-55, 2-132

FRESPACE function block 1-36

FU2LU function 1-44

functions

menu 1-2

**G**

GE function 1-28, 2-135

GETDAY function 1-57, 2-136

GR\_END function 1-52, 2-137

GT function 1-28, 2-138

**H**

HOLD function 1-50, 2-138

HOLD\_END function 1-50, 2-139

**I**

I/O function blocks 1-31

IDN

147 2-383

148 2-371

IN\_POS? function 1-50, 2-143

INSERT function 1-55, 2-140

INT2DINT function 1-15, 2-141

INT2LINT function 1-15, 2-141

INT2SINT function 1-15, 2-142

INT2UINT function 1-15, 2-142

INT2WORD function 1-15, 2-143

intconv group functions 1-15

integral 2-214

control 2-214

io

anlgin

A\_INCHIT 2-33

A\_INCHRD 2-36

A\_INMDIT 2-40

anlgout

ANLG\_OUT 2-13

ANLGINIT 2-11  
 BAT\_OK? 2-43  
 BIO\_PERF 2-43  
 comm  
   ASSIGN 2-23  
   CLOSE 2-67  
   CONFIG 2-71  
   DELFIL 2-87  
   DIRECT 2-91  
   OPEN 2-207  
   READ 2-295  
   RENAME 2-359  
   SEEK 2-416  
   WRITE 2-492  
 JKtherm  
   ATMPCHIT 2-26  
   ATMPCHRD 2-28  
   ATMPMDIT 2-30  
   BTMPCHIT 2-47  
   BTMPCHRD 2-48, 2-50  
 network  
   NETCLS 2-192  
   NETFRE 2-192  
   NETMON 2-193  
   NETOPEN 2-194  
   NETRCV 2-196  
   NETSND 2-198  
   NETSTA 2-200  
 PID 2-214  
 PID2 2-222  
 READFDBK 2-297  
 rtdtemp  
   ARTDCHIT 2-17  
   ARTDCHRD 2-19  
   ARTDMDIT 2-21  
 sockets  
   IPSTAT 2-160  
 stepper  
   STEP\_POS 2-450  
   STEPNTL 2-431  
   STEPINIT 2-435  
 IP socket  
   error numbers B.1 -2  
 IPACCEPT function block 1-42, 2-148  
 IPCLOSE function block 1-42, 2-149  
 IPCONN function block 1-42, 2-150  
 IPHOST function block 2-151  
 IPHOSTID function block 1-42  
 IPIP2NAM function block 1-42, 2-152  
 IPLISTEN function block 1-42, 2-153  
 IPNAM2IP function block 1-42, 2-154  
 IPREAD function block 1-42, 2-155  
 IPRECV function block 1-42  
 IPRECV funtion block 2-156  
 IPSEND function block 1-42, 2-158  
 IPSOCK function block 1-42, 2-159  
 IPSTAT function 1-42, 2-160  
 IPWRITE function block 1-42, 2-161  
**J**  
 jerks 2-412  
 J-K thermocouple module 2-28  
**L**  
 LAD\_REF function 1-53, 1-54, 1-55, 2-124,  
   2-167  
 ladder reference 2-167  
 ladder units 1-43  
 LE function 1-28, 2-170  
 LEFT function 1-55, 2-171  
 LEN function 1-55, 2-172  
 less than 2-180  
 LIMIT function 1-30, 2-173  
 LINT2DI function 1-16, 2-174  
 LINT2INT function 1-16, 2-174  
 LINT2LR function 1-16, 2-175  
 LINT2LW function 1-16, 2-175  
 LINT2SI function 1-16, 2-176  
 LINT2ULI function 1-16, 2-176  
 lintconv group functions 1-16  
 LN function 1-8, 2-177  
 LOG function 1-8, 2-177  
 loss of feedback 2-114  
 LREA2LI function 1-17, 2-178  
 LREA2LW function 1-17, 2-178  
 LREA2RE function 1-17, 2-179  
 LREA2ULI function 1-17, 2-179  
 lrealcnv group functions 1-17  
 LT function 1-28, 2-180  
 LU2FU function 1-44  
 LWOR2BYT function 1-18, 2-181  
 LWOR2DW function 1-18, 2-182

LWOR2LI function 1-18, 2-182  
LWOR2LR function 1-18, 2-183  
LWOR2ULI function 1-18, 2-183  
LWOR2WO function 1-18, 2-184  
lwordenv group functions 1-18  
LWR\_CASE function 1-56

## M

machine reference 2-120, 2-167  
machine reference switch  
  set up 2-123  
master/slave moves  
  programming errors 2-233  
  ratio gear 2-283  
  ratio profile 2-253  
  ratio slope 2-261  
  ratio synchronization 2-273  
math coprocessor 2-1  
MAX function 1-30, 2-185  
MEASURE function 1-50, 2-185  
MID function 1-56, 2-186  
MIN function 1-30, 2-187  
MMC  
  A\_IN\_MMC function 2-32  
MOD function 1-6, 2-187  
mode  
  APPEND 2-207  
  READ 2-207  
  WRITE 2-207  
module 2-13  
  ±10V DC output 2-11, 2-13  
  4-20 mA output 2-11  
  J-K thermocouple 2-28  
motion  
  data  
    CAPINIT 2-61  
    CAPSTAT 2-65  
    COORD2RL 2-74  
    READ\_SV 2-308  
    SCA\_STAT 2-390  
    STATUSSV 2-429  
    TUNERead 2-470  
    TUNEWrit 2-471  
    WRITE\_SV 2-493  
  errors  
    C\_ERRORS 2-81

C\_RESET 2-83  
C\_STOP 2-83  
C\_STOP? 2-84  
E\_ERRORS 2-113  
E\_RESET 2-115  
E\_STOP 2-115  
E\_STOP? 2-116  
P\_ERRORS 2-233  
P\_RESET 2-236  
TME\_ERR? 2-466  
init  
  CLOSLOOP 2-68  
  CLSLOOP? 2-69  
  OPENLOOP 2-209  
  STRTSERV 2-453  
move  
  DISTANCE 2-93  
  DPOSMODE 2-100  
  DTORQCMD 2-105  
  DVELCMD 2-106  
  POSTION 2-232  
  VEL\_END 2-486  
  VEL\_STR 2-487  
move\_sup  
  ACC\_DEC 2-4  
  ACC\_JERK 2-5  
  CAM\_OUT 2-55  
  HOLD 2-138  
  HOLD\_END 2-139  
  IN\_POS 2-143  
  MEASURE 2-185  
  NEW\_RATE 2-203  
  NEWRATIO 2-201  
  PLS 2-227  
  PLS\_EDIT 2-231  
  R\_PERCEN 2-369  
  RATIOSCL 2-257  
  REGIST 2-350  
  SCURVE 2-411  
  VFASTIN 2-488  
que  
  ABRTALL 2-2  
  ABRTMOVE 2-2  
  FAST\_QUE 2-117  
  Q\_AVAIL? 2-238  
  Q\_NUMBER 2-239

- ratiomov
    - GR\_END 2-137
    - RATIO\_GR 2-283
    - RATIO\_RL 2-286
    - RATIOCAM 2-241
    - RATIOPRO 2-252
    - RATIOSLP 2-261
    - RATIOSYN 2-273
    - REP\_END 2-362
    - SYN\_END 2-457
  - ref
    - FAST\_REF 2-120
    - LAD\_REF 2-167
    - PART\_CLR 2-211
    - PART\_REF 2-212
    - REF\_DNE? 2-349
    - REF\_END 2-349
- motion data group functions 1-44
- motion error group functions 1-46
- motion functions 1-43
- motion init group functions 1-48
- motion move group functions 1-49
- motion move\_sup group functions 1-50
- motion que group functions 1-51
- motion ratiomov group functions 1-52
- motion ref group functions 1-53, 1-54, 1-55
- MOVE function 1-30, 2-188
- moves
  - distance 2-93
  - position 2-232
  - ratio cam 2-241
  - ratio gear 2-283
  - ratio profile 2-253
  - ratio real 2-286
  - ratio slope 2-261
  - ratio synchronization 2-273
  - velocity start 2-487
- MUL function 1-6, 2-189
- MUX function 1-30, 2-190
- mV range 2-29
- N**
- NE function 1-28, 2-191
- NEG function 1-6, 2-191
- NETCLS function block 1-38, 2-192
- NETFRE function block 1-38, 2-192

- NETMON function block 1-38, 2-193
- NETOPN function block 1-38, 2-194
  - errors 2-194
- NETRCV function block 1-38, 2-196
  - errors 2-197
- NETSND function block 1-38, 2-198
  - errors 2-199
- NETSTA function block 1-38, 2-200
- network 1-38
  - group functions 1-38
  - status 2-193
- NEW\_RATE function 1-50, 2-203
- NEWRATIO function 1-50, 2-201
- NEXNET
  - function blocks 1-38
- noise filter 2-34
- NOT function 1-9, 2-204
- NUM2STR function 1-19, 2-205
- NUM2STR group function 1-19

## O

- offset
  - examples 2-314
- offset bytes 2-416
- OI\_SER A.1 -2
- OI\_SER function block A.1 -2
- OK\_ERROR 2-206
- OK\_ERROR function 1-28
- one-shot 2-1
- OPC B.1 -6
- OPC server B.1 -2
- OPC\_10 function block B.1 -6
- OPC\_ENET function block B.1 -2
- OPEN function block 1-36, 2-23, 2-207
- OPENLOOP function 1-48, 2-209
- OR function 1-9, 2-210
- origin 2-416

## P

- P\_ERRORS function 1-47, 2-233
- P\_RESET function 1-47, 2-236
- part reference 2-211
- part reference offset 2-326
- PART\_CLR function 1-53, 2-211
- PART\_REF function 1-53, 1-55, 2-212
- photo eye 2-355

## PID

- algorithms 2-218
- control 2-213
- equations 2-218, 2-220
- example network 2-221, 2-226
- RAMP 2-240
- structure 2-215, 2-223

## pid

- PWDTY 2-237
- TAUFFAC 2-463
- TAUFILT 2-464

## PID code 2-329

## PID command 2-328

## PID function block 1-39, 2-214

- equation terms 2-218

## PID functions/blocks 1-56

## PID group function 1-39

## PID2 function 1-56

## PID2 function block 2-222

## PLS 2-55

## PLS function 1-50, 2-227

## PLS\_EDIT function 1-50, 2-231

## POSITION function 1-49, 2-232

## profile

- back to back 2-253, 2-256
- end repeat 2-362
- repeat 2-253, 2-254

## profile (step)

- example 2-447

## programming errors

- bit locations 2-234, 2-235
- define 1-46
- hex value 2-234, 2-235

## proportional 2-214

- control 2-214

## PWDTY function 2-237

## PWDTY function block 1-56

## Q

## Q\_AVAIL? function 1-51, 2-238

## Q\_NUMBER function 1-51, 2-239

## queue

- abort all moves 2-2
- and fast input 2-117
- available 2-238
- number 1-51

## R

## R\_PERCEN function 1-50, 2-369

## RAMDISK

- read/write 1-36

## RAMP function 1-56, 2-240

## ratio gear

- characteristics 2-285
- mechanical representation 2-284

## ratio real

- characteristics 2-288
- structure members 2-44, 2-289

## RATIO\_GR function 1-52, 2-283

## RATIO\_RL function 1-52, 2-286

## ratiocam

- and scaling 2-259
- array of structures 2-248
- characteristics 2-247
- master start position 2-243
- profile 2-242
- repeat profile end 2-362
- slave start position 2-243

## RATIOCAM function 1-52, 2-241

## ratiopro

- back to back profiles 2-256
- master start position 2-254
- not OK 2-253
- profile number 2-253
- repeat profile 2-254
- repeat profile end 2-362
- slave reversal 2-253, 2-255
- summary 2-252

## RATIOPRO function 1-52, 2-252

## RATIOSCL function 1-50, 2-257

## ratioslp

- and scaling 2-260
- array of structures 2-268
- characteristics 2-263
- profile 2-269
- repeat profile end 2-362
- slope 2-271

## RATIOSLP function 1-52, 2-261

## ratiosyn

- characteristics 2-276
- master start position 2-276
- mechanical representation 2-274
- rollover on position 2-281

- slave start position 2-276
- RATIOSYN function 1-52, 2-273
- READ function block 1-36, 2-295
- READ mode 2-207
- READ\_SV function 1-44, 2-308
- READ\_SV function (see variable servo)
- READ\_SVF function 1-44, 2-346
- READFDBK function 1-40, 2-297, 2-359
- READFDBK group function 1-40
- REAL2DI function 1-20, 2-347
- REAL2DW function 1-20, 2-347
- REAL2LR function 1-20, 2-348
- REAL2UDI function 1-20, 2-348, 2-349
- realconv group functions 1-20
- REF\_DNE? function 1-53, 2-349
- REF\_END function 1-53, 2-349
- reference
  - complete 2-349
  - fast input
    - define 2-120, 2-167
    - function 2-120
  - ladder
    - end function 2-349
    - function 2-167
  - no motion 2-121, 2-168
  - null setup 2-122, 2-169
  - part
    - clear function 2-211
    - switch setup 2-123
- REGIST function 1-50, 2-350
- registration
  - background 2-353
  - example 2-353
  - fast input 2-350
  - good marks 2-358
  - master 2-356
  - slave 2-357
- remainder 2-187
- RENAME function block 1-36, 2-359
- REP\_END function 1-52, 2-362
- REPLACE function 1-56, 2-361
- RESMODE function 2-363
- RESMODE? function 1-47
- resolver
  - ignore null 2-121, 2-168
- RESUME function 1-47, 2-364

- RIGHT function 1-56, 2-366
- ROL function 1-9, 2-367
- ROR function 1-9, 2-368
- RS422/485 2-71
- RTD
  - channel read errors 2-20
  - initialize
    - channel 2-17
    - errors (channel) C.1 - 1
    - module 2-21
  - temperature range 2-17
- RTD functions 1-41
- RTDtemp group functions 1-41

## S

- S\_D\_D function 1-7
- S\_DT\_DT function 1-7, 2-458
- S\_DT\_T function 1-7, 2-459
- S\_TOD\_T function 1-7, 2-461
- S\_TOD\_TO function 1-7
- SC\_INIT function block 1-55, 2-370, 2-425
- SCA\_ACKR function block 1-53, 2-371
- SCA\_CLOS function block 1-48, 2-372
- SCA\_CTRL function 1-44, 2-373
- SCA\_ERST function 1-47
- SCA\_ERST function block 2-376, 2-377
- SCA\_PBIT function 1-50
- SCA\_RCYC function 1-44, 2-379
- SCA\_RECV function block 1-44, 2-381
- SCA\_REF function block 1-53, 2-383
- SCA\_RFIT function 1-53
- SCA\_SEND function block 1-44, 2-388
- SCA\_STAT function 1-44, 2-390
- SCA\_WCYC function 1-44, 2-391
- SCR\_CONT function 1-55, 2-392
- SCR\_ERR function block 1-55, 2-393
- SCR\_PHAS function 1-55, 2-396
- SCS\_ACKR function block 1-54, 2-397
- SCS\_CTRL function 1-54, 2-398
- SCS\_RECV function block 1-54, 2-400
- SCS\_REF function block 1-54, 2-402
- SCS\_SEND function block 1-54, 2-404
- SCS\_STAT function 1-54, 2-406
- SCURVE function 1-50, 2-411
- SEEK function block 1-36, 2-416
- SEL function 1-30, 2-418

## SERCOS

### function blocks

- SC\_INIT 2-370, 2-425
- SCA\_ACKR 2-371
- SCA\_CLOS 2-372
- SCA\_ERST 2-376, 2-377
- SCA\_RECV 2-381
- SCA\_REF 2-383
- SCA\_SEND 2-388
- SCR\_ERR 2-393
- SCS\_ACKR 2-397
- SCS\_RECV 2-400
- SCS\_REF 2-402
- SCS\_SEND 2-404

### functions

- SCA\_CTRL 2-373
- SCA\_RCYC 2-379
- SCA\_WCYC 2-391
- SCR\_CONT 2-392
- SCR\_PHAS 2-396
- SCS\_CTRL 2-398
- SCS\_STAT 2-406

SERCOS command position 2-332

SERCOS errors 2-407

serial communications 2-23

SERR errors 2-410

### servo

- axes 2-241, 2-252, 2-261, 2-274, 2-284,  
2-287, 2-309, 2-315, 2-317, 2-  
319, 2-320, 2-324, 2-471

### Servo Control Variables

- background information 2-328

servo iteration command 2-328

- execution sequence 2-329

servo PID command

- execution sequence 2-329

SERVOCLK function 1-57, 2-419

SHL function 1-9, 2-420

SHR function 1-9, 2-421

SIN function 1-8, 2-422

SINT2BYT function 1-21, 2-422

SINT2DI function 1-21, 2-423

SINT2INT function 1-21, 2-423

SINT2LI function 1-21, 2-424

SINT2USI function 1-21, 2-424

sintconv group functions 1-21

### slave axis

- reversal 2-253, 2-255

slave delta overflow 2-114

### SMCM

#### moves

- interrupt 2-433

software limit

- lower 2-327

- upper 2-326

source identification (SID) 2-194

SQRT function 1-6

STATUS function block 1-36

status servo characteristics 1-44

STATUSSV function 1-44, 2-429

### step profile

- commands 2-441

- control words 2-432

- continue profile 2-432

- pause profile 2-432

- step/direction 2-432

- distance command 2-441

- pause command 2-445, 2-447

- position command 2-441

- set acc/dec rate command 2-445, 2-447

- set maximum velocity command 2-445

- set reference command 2-445, 2-446, 2-  
447

- velocity command 2-442

STEP\_CMD function 1-43

STEP\_POS function 1-43, 2-450

STEPCNTL function 1-43, 2-431

STEPINIT function 1-43, 2-435

- errors 2-435

- structure 2-435

stepper group functions 1-43

STEPSTAT function 1-43

STR2D\_T function 1-23

STR2NUM function 1-23, 2-452

STR2USI function 1-23, 2-452

strconv group functions 1-23

### string

- CONCAT 2-70

- DELETE 2-86

- FIND 2-132

- INSERT 2-140

- LEFT 2-171

- LEN 2-172
- MID 2-186
- REPLACE 2-361
- RESMODE 2-363
- RESUME 2-364
- RIGHT 2-366
- UPR\_CASE 2-483
- string functions 1-55
- STRTSERV function 1-48, 2-453
  - initialize setup data 2-453
- SUB function 1-6
- SYN\_END function 1-52, 2-137, 2-457
- T**
- TAN function 1-8, 2-463
- task 2-419
- TAUFFAC function 1-56, 2-463
- TAUFILT function 1-56, 2-464
- TCP client
  - setup 2-162
- TCP server
  - setup 2-162
- terminator 2-71
- thermocouple
  - J type 2-28
    - range 2-26
  - K type 2-28
    - range 2-26
- TIM2UDIN function 1-14, 2-464
- time
  - axes 2-241, 2-252, 2-261, 2-274, 2-284, 2-287, 2-309, 2-315, 2-317, 2-319, 2-320, 2-324
- TIME2STR function 1-14
- timer function blocks 1-56
- timers
  - TOF 2-467
  - TON 2-468
  - TP 2-469
- timing error
  - define 1-46
  - inquiry 2-466
- TME\_ERR? function 1-47, 2-466
- TOD2STR function 1-14
- TOF function block 1-56, 2-467
- TON function block 1-56, 2-221, 2-468

- TP function block 1-56, 2-469
- trig group functions 1-8
- troubleshooting
  - block I/O 2-43
- TrueView TCS A.1 -2
- TUNERead function 1-44, 2-470
- TUNEWRIT function 1-45, 2-471

## U

- UDIN2DI function 1-24, 2-474
- UDIN2DW function 1-24, 2-474
- UDIN2RE function 1-24, 2-475
- UDIN2TIM function 1-24, 2-475
- UDIN2UI function 1-24
- UDIN2ULI function 1-24, 2-476
- UDIN2USI function 1-24
- udintenv group functions 1-24
- UDP Client
  - setup 2-163
- UDP Server
  - setup 2-163
- UINT2INT function 1-25
- UINT2UDI function 1-25
- UINT2ULI function 1-25, 2-478
- UINT2USI function 1-25
- UINT2WO function 1-25
- uintconv group functions 1-25
- ULIN2LI function 1-26, 2-480
- ULIN2LR function 1-26, 2-480
- ULIN2LW function 1-26, 2-481
- ULIN2UDI function 1-26, 2-481
- ULIN2UI function 1-26, 2-482
- ULIN2USI function 1-26, 2-482
- ulintenv group functions 1-26
- unipolar
  - example 2-39
  - range 2-34
- UPR\_CASE function 1-56, 2-483
- user iteration command
  - execution sequence 2-329
- user PID command
  - execution sequence 2-329
- user port 2 1-36, 2-67, 2-71, 2-295, 2-428, 2-492, A.1 -2
- USIN2BYT function 1-27
- USIN2SI function 1-27



USIN2STR function 1-27, 2-484  
USIN2UDI function 1-27  
USIN2UI function 1-27  
USIN2ULI function 1-27, 2-486  
usintenv group functions 1-27

## V

variable servo  
  actual position 2-309  
  axis position (software) 2-319  
  backlash comp 2-322  
  bad marks 2-312  
  command  
    position 2-310  
    velocity 2-310  
  current segment number 2-327  
  fast input  
    direction 2-317  
    distance 2-317  
    position (HW) 2-311  
    position (SW) 2-319  
  fast queuing 2-321  
  feedback last 2-311  
  filter  
    error 2-310  
    error limit 2-324  
    lag 2-325  
    time constant 2-324  
  filter time constant 2-324  
  list 1-44, 1-45  
  master distance into segment 2-327  
  master offset  
    absolute 2-313  
    filter 2-315  
    incremental 2-313  
  part reference offset 2-326  
  position  
    change 2-310, 2-326  
    error 2-310  
  reference switch position 2-323  
  reg/ref position change 2-311  
  registration switch 2-320  
  reversal not allowed 2-319  
  rollover on position 2-312  
  set user iteration command 2-330, 2-331  
  slave distance into segment 2-327

  slave offset  
    absolute 2-313  
    filter 2-315  
    incremental 2-313  
  software lower limit 2-327  
  software upper limit 2-326  
  synchronized slave start 2-321  
  TTL feedback 2-322  
  velocity compensation flag 2-325  
variable tune  
  analog output  
    offset 2-472  
  derivative  
    gain 2-472  
  feed forward  
    percent 2-472  
  integral  
    gain 2-471  
  proportional  
    gain 2-471  
  velocity  
    filter  
      slow 2-472  
VEL\_END function 1-49, 2-486  
VEL\_STRT function 1-49, 2-487  
velocity end 2-3  
VFASTIN function 1-50, 2-488

## W

WORD2BYT function 1-28, 2-489  
WORD2DW function 1-28, 2-489  
WORD2INT function 1-28, 2-490  
WORD2LW function 1-28, 2-490  
WORD2UI function 1-28, 2-491  
wordconv group functions 1-28  
WRIT\_SVF function 1-45, 2-494  
WRITE function block 1-36, 2-492  
WRITE mode 2-207  
WRITE\_SV function 1-45, 2-493

## X

xclock  
  CLOCK 2-66  
  GETDAY 2-136  
  SERVOCLK 2-419  
Xclock functions 1-57

XOR function 1-9, 2-495

## **NOTES**

