

Accessories for digital drive systems

Manual



Edition: December 2014
Translation of the original document
European Version (CE region)

Keep all manuals as a product component during the life span of the product.
Pass all manuals to future users and owners of the product.

Record of Document Revisions

Edition	Comments
04/2007	First edition
07/2007	System S700 updated.
11/2007	Several corrections, connectors added.
03/2008	Motor cable 1mm ² for S700 added, Symbols acc. to ANSI Z535, Y-Connector X0/X8 for S700 added, configuration of cables, 3YL20->3YL24.
04/2010	Weight 3YL-24, Product brand, 3YL20 with UL, 3YLN new, S748/772, AKD, Resolver table, S200 accessories removed.
12/2010	Order codes brake resistors, Comcoder wire colors, feedback cable color, order codes motor cables, mains filter new types, mains chokes new types, transport tool for AKM8, mounting clamps for S700, accessories S640/670 removed, 3YL20 removed, company name.
10/2011	Motor cables, cable data, EU order codes mating connectors AKD, AKD Hiperface.
03/2012	Order codes motor cables S748/772 updated, cable data, combined cables for AKD with SFD, stainless steel connectors for Washdown motors.
08/2012	SFD cable fotos, all SFD cables to one section, dimensions mains chokes corrected, capacitor modules new, formal improvements
05/2013	Photos SFD cables, dimensions mains chokes updated, KCM modules new, manufacturing hints for Kollmorgen cables removed, configured cable tables with photos, typo corrections, fan kit AKM7, mains filter 1NF-20 replaced by 1NF-20B, mounting clamps S700 removed, 24V mains supply removed, hybrid cables new
11/2013	Heat sink AKD-N new, Hybrid cables AKD-C/N new, Hybrid cables SFD3/DSL, new Ethernet cables
03/2014	New Layout, AKMH mounting kit, KCM updated, AKM7 Fan-Kit updated, hybrid cables SFD3/DSL added
05/2014	Length definition of hybrid cables for decentralized systems changed, S700 X8Y set with X4Amini
08/2014	Brake resistor AKD-x01206 changed, length definitions for decentral hybrid cables updated
12/2014	S640/670 added, AKD-x04807 accessories added

Technical changes which improve the performance of the device may be made without prior notice!

Printed in the United States of America

This document is the intellectual property of Kollmorgen. All rights reserved. No part of this work may be reproduced in any form (by photocopying, microfilm or any other method) or stored, processed, copied or distributed by electronic means without the written permission of Kollmorgen.

1 Table of Contents

1	Table of Contents	3
2	General	7
2.1	About this manual	7
2.2	Hints for the online edition (PDF format)	7
2.3	Safety Notes	8
2.3.1	Symbols Used	8
2.3.2	You should pay attention to this	9
3	Digital Drive Systems	10
3.1	Drive System with S300	10
3.2	Drive System with S400	11
3.3	Drive System with S601...620	12
3.4	Drive System with S640...670	13
3.5	Drive System with S701...724	14
3.6	Drive System with S748/772	15
3.7	Drive System with AKD-x00306...02406	16
3.8	Drive System with AKD-x00307...02407	17
3.9	Drive System with AKD-x04807	18
3.10	Decentralized Drive System with AKD-C and AKD-N	19
4	Mechanical Accessories	20
4.1	Mounting Kit for AKMH Motors	20
4.2	Suspension Unit for AKM motors	20
4.3	Fan Kit for AKM7 motors	21
4.4	Mechanical accessories for AKD-N and AKD-C	22
4.4.1	Heat Sink for AKD-N	22
4.4.2	Mounting clamps for AKD-N	22
4.4.3	Sealing plugs for AKD-N connectors	23
4.4.4	Connector Kit for AKD-C	23
4.4.5	Cabinet connector coupling for AKD-C/N	23
5	Shield clamps	24
5.1	Auxiliary terminals on the servo amplifier	24
5.2	External shielding busbar	25
6	Mains chokes	26
6.1	General	26
6.2	Important notes	26
6.3	Type assignment and order codes	26
6.4	Mains choke 3L	27
7	Mains filters	28
7.1	General	28
7.2	Important notes	28
7.3	Type assignment and order codes	28
7.4	Mains filters 1NF-10...12	29
7.5	Mains filters 1NF-20B, 1NF-25	30

7.6	Mains filters 3NF-07...30	31
7.7	Mains filters 3EF-42...130	32
8	Brake resistors	33
8.1	General	33
8.2	Important notes	33
8.3	Type assignment and order codes	34
8.4	External brake resistor BAFP(U)	35
8.5	External brake resistor BAR(U)	36
8.6	External brake resistor BAS(U)	37
9	Capacitor Modules	38
9.1	General	38
9.2	Important notes	38
9.3	Type assignment and order codes	39
9.4	Example installation with AKD-P, KCM-P and KCM-E	39
9.5	KCM Module	40
10	Motor chokes	41
10.1	General	41
10.2	Important notes	42
10.3	Type assignment and order codes	42
10.4	Motor choke 3YL-24	43
10.5	Motor choke 3YLN-xx	44
11	Cables	45
11.1	Technical data for cables	45
11.2	Tools	45
11.3	PC connection	46
11.3.1	AKD	46
11.3.2	S300, S400, S600, S700	46
11.4	Power Voltage Supply, external brake resistor, DC bus link	48
11.4.1	Mating connector (part of delivery)	48
11.4.2	Mating connector (optional)	48
11.4.3	Recommended cable type	49
11.4.4	Preparing cables for AKD/S300/S400/S601...620/S700	49
11.4.5	Preparing cables for S640/670 and S748/772	51
11.5	24V auxiliary voltage supply	52
11.5.1	Mating connector (part of delivery)	52
11.5.2	Recommended cable type	52
11.5.3	Preparing cables	53
11.6	Digital/analog Inputs/Outputs	54
11.6.1	Digital In/Outputs for AKD-C	54
11.6.2	Digital In/Outputs for AKD-N	54
11.6.3	Digital/analog I/O for S300/S400/S600/S700 and AKD-B/P/T/M	55
11.6.4	Preparing cables	56
11.7	Encoder Emulation, Stepper motor control, Master-Slave	57
11.7.1	Mating connector, cable type	57
11.7.2	Connection	57

11.7.3 Termination resistors	57
11.7.4 Preparing cables	58
11.8 Ethernet cable	59
11.8.1 Order codes Ethernet cable, configured	59
11.9 CAN bus cable	60
11.9.1 CAN bus cable AKD	60
11.9.2 Can bus cable for S300/S400/S600/S700	60
11.10 Hybrid cables	62
11.10.1 AKD to AKM1 Motor (i-tec connector)	62
11.10.2 AKD to AKM2-6 (IP65 connector)	63
11.10.3 AKD-C to AKD-N in the decentralized drive system	65
11.10.4 AKD-N to AKD-N in the decentralized drive system	65
11.11 Motor cables	66
11.11.1 General	66
11.11.2 Motor cables, configured	66
11.11.2.1 Order codes motor cables for S300	67
11.11.2.2 Order codes motor cables for S400	67
11.11.2.3 Order codes motor cables for S601...620	68
11.11.2.4 Order codes motor cables for S701-712	69
11.11.2.5 Order codes motor cables for S724	70
11.11.2.6 Order codes motor cables for S748, S640/670	70
11.11.2.7 Order codes motor cables for AKD-B/P/T/M	72
11.11.2.8 Order codes motor cables for AKD-N	74
11.11.3 Preparing motor cables (motor end)	75
11.11.3.1 Motor series AKM2...8, 6SMx7, DBL2...6, DBK	75
11.11.3.2 Motor series AKM8, DBL7/8	75
11.11.4 Preparing motor cables (servo amplifier end)	77
11.11.4.1 Preparing cables for S300/S400	77
11.11.4.2 Preparing cables for S601...620	78
11.11.4.3 Preparing cables for S701...724	79
11.11.4.4 Preparing cables for AKD-x00306/x00606	79
11.11.4.5 Preparing cables for AKD-x01206/X02406/X0xx07	80
11.11.4.6 Preparing cables for S640/670 and S748/772	80
11.12 Feedback cables	82
11.12.1 Resolver cables	82
11.12.1.1 Resolver cables for S300/S400/S600/S700	82
11.12.1.2 Resolver cable for AKD	83
11.12.2 SFD cables for AKD	83
11.12.3 Encoder cables	84
11.12.3.1 Encoder cables for S300/S400/S600/S700	84
11.12.3.2 Encoder cables for AKD	85
11.12.4 ComCoder cables	86
11.12.4.1 ComCoder cables for S300/S400/S600/S700	86
11.12.4.2 Comcoder cables for AKD	87

This page intentionally left blank.

2 General

2.1 About this manual

This manual describes accessories for Kollmorgen digital servo amplifiers. It contains essential technical data. The manual is only valid in conjunction with the instructions manual for the servo amplifier and servo motor you are using in your application.

You will find copies of the instructions manual for Kollmorgen servo amplifiers and servo motors on the CD ROM included in the scope of supply and on our Internet site. The documents are available in Acrobat Reader format in multiple languages (system requirements: WINDOWS, Internet browser, Acrobat Reader).

Servo amplifier product family names appear in abbreviated format:

Servo amplifier	Abbreviation	Servo amplifier	Abbreviation
SERVOSTAR 300	S300	S701...724	S701...724
SERVOSTAR 400	S400	S748/772	S748/772
SERVOSTAR 601...620	S601...620	AKD-xyyyzz	AKD
SERVOSTAR 640...670	S640...670		

More detail information can be found in the "European Product WIKI" available at www.wiki-kollmorgen.eu.

2.2 Hints for the online edition (PDF format)

Bookmark:

Table of contents and index are active bookmarks.

Table of contents and index in the text:

The lines are active cross references. Click on the desired line and the appropriate page is indicated.







Page/chapter numbers in the text:

Page/chapter numbers with cross references are active. Click at the page/chapter number to reach the indicated target.

2.3 Safety Notes

This section helps you to recognize and avoid dangers to people and objects.

2.3.1 Symbols Used

Symbol	Indication
 DANGER	Indicates a hazardous situation which, if not avoided, will result in death or serious injury.
 WARNING	Indicates a hazardous situation which, if not avoided, could result in death or serious injury.
 CAUTION	Indicates a hazardous situation which, if not avoided, could result in minor or moderate injury.
NOTICE	Indicates situations which, if not avoided, could result in property damage.
NOTE	This symbol indicates important notes.
	Warning of a danger (general). The type of danger is specified by the text next to the symbol.
	Warning of danger from electricity and its effects.
	Warning of suspended loads.

2.3.2 You should pay attention to this

Read the documentation!

Read the available documentation before installation and commissioning. Improper handling of the devices can cause harm to people or damage to property. The operator must therefore ensure that all persons entrusted to work on the devices have read and understood the manual and that the safety notices in this manual are observed.

Always observe the whole drive system built with servo amplifier, cables, motor, accessories (filters, chokes, etc.). This means, that all documentation which exist for the components, must be available, must be read and must be understood.

Pay attention to the technical data!

Adhere to the technical data and the specifications on connection conditions (rating plate and documentation). If permissible voltage values or current values are exceeded, the devices can be damaged, e.g. through overheating.

Specialist staff required!

Only properly qualified personnel are permitted to perform such tasks as transport, assembly, setup and maintenance. Qualified specialist staff are persons who are familiar with the transport, installation, assembly, commissioning and operation of power electronics and who bring their relevant minimum qualifications to bear on their duties. The qualified personnel must know and observe IEC 60364 / IEC 60664 and national accident prevention regulations.

Additional requirements on specialist staff may also result from the risk assessment.

Hot surface!



Some devices can reach temperatures of up to 250°C during operation. Touching them can result in burns. Observe the permissible mounting position and ensure that a sufficient distance is maintained from neighboring assemblies.

Earthing!



It is vital that you ensure that the device housing is safely earthed to the PE (protective earth) busbar in the switch cabinet. Without low-resistance earthing no personal protection can be guaranteed and there is a risk of death from electric shock.

High voltages!



Keep the switching cabinet closed when the equipment is in operation. Not having optical displays does not guarantee an absence of voltage. Power connections may carry voltage even if the motor is not turning.

Do not unplug any connectors during operation. There is a risk of death or severe injury from touching exposed contacts. Power connections may be live even when the motor is not rotating. This can cause flashovers with resulting injuries to persons and damage to the contacts.

DC Bus link connections can carry dangerous voltage levels over an hour after the line voltage has been switched off (self-discharge time). Danger of death from electric shock.

Before commencing work on the modules' power terminals, check the voltage at the connection terminals is de-energized to ground and to each other.

3 Digital Drive Systems

The systems shown are simply a possible scenario for setting up a digital drive system with relevant servo amplifier components.

3.1 Drive System with S300

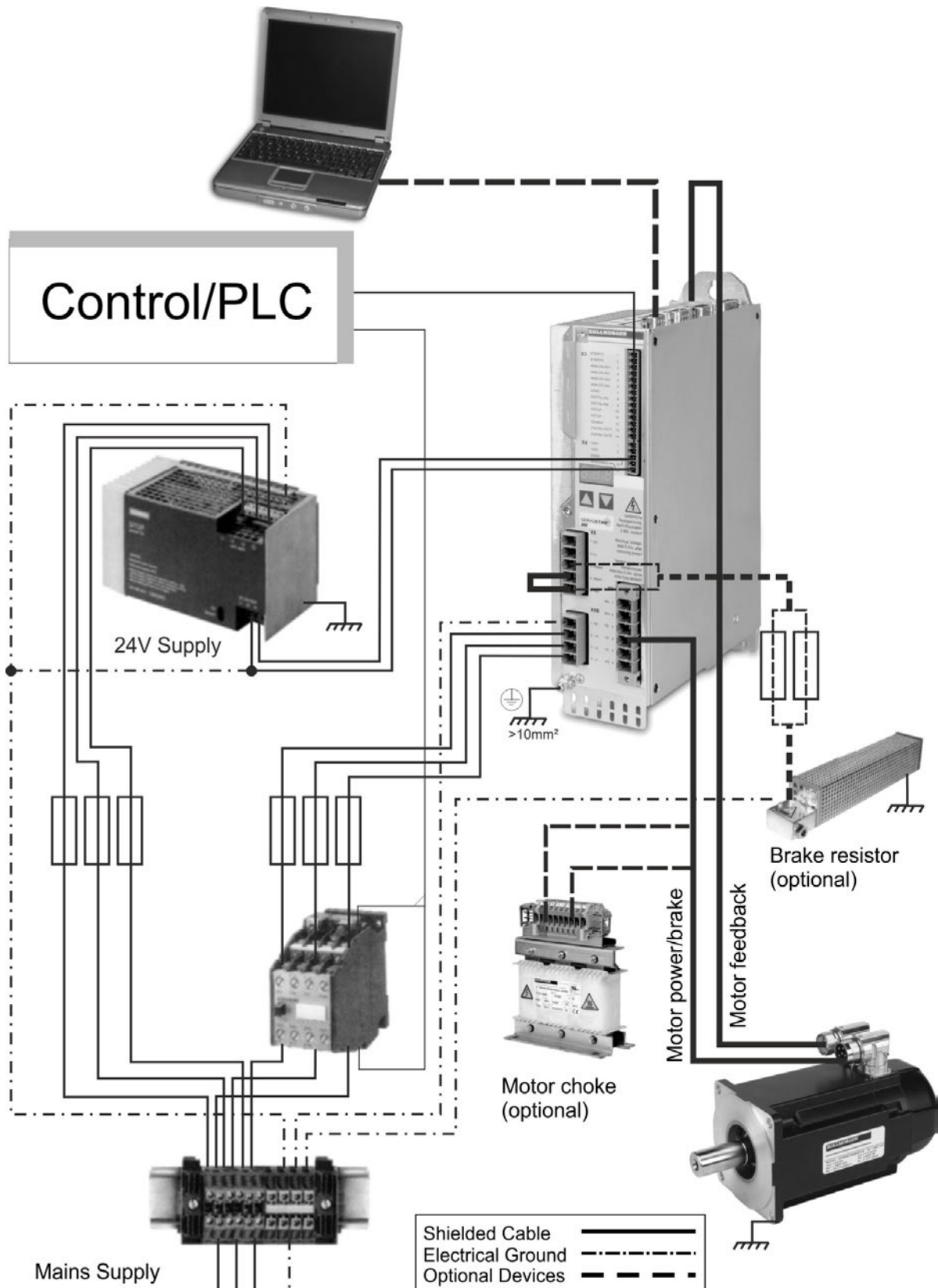

3.2 Drive System with S400

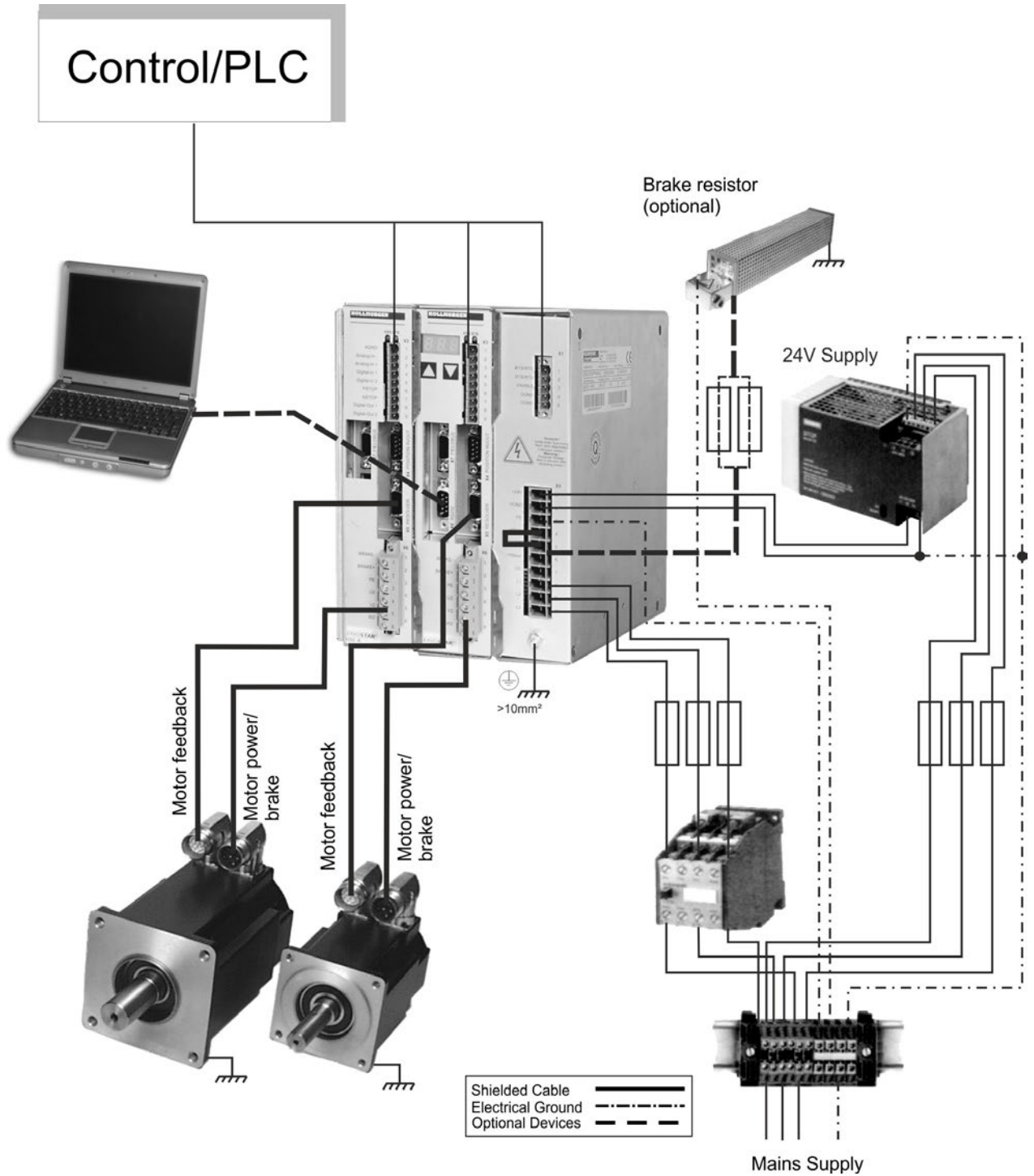

3.3 Drive System with S601...620

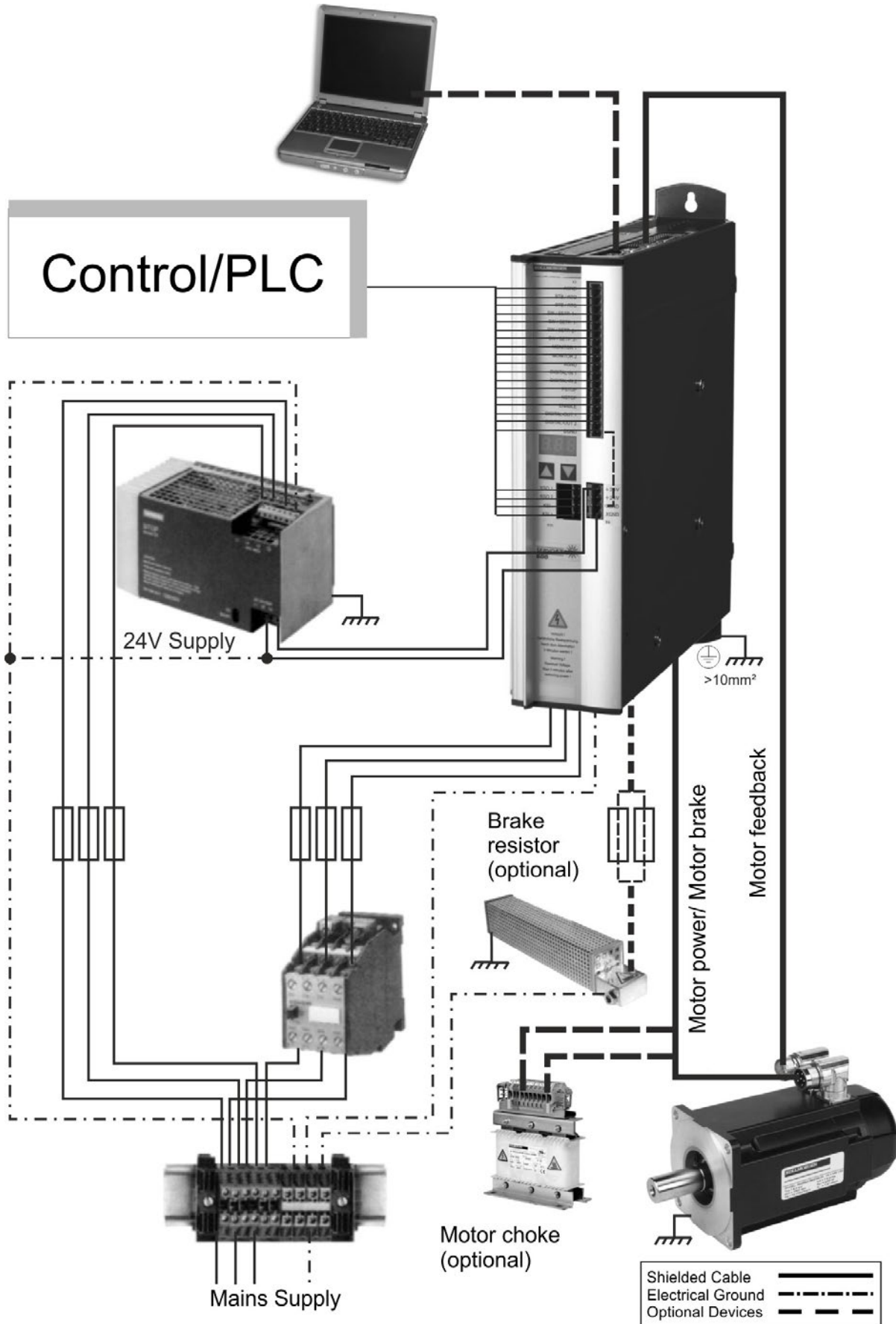

3.4 Drive System with S640...670

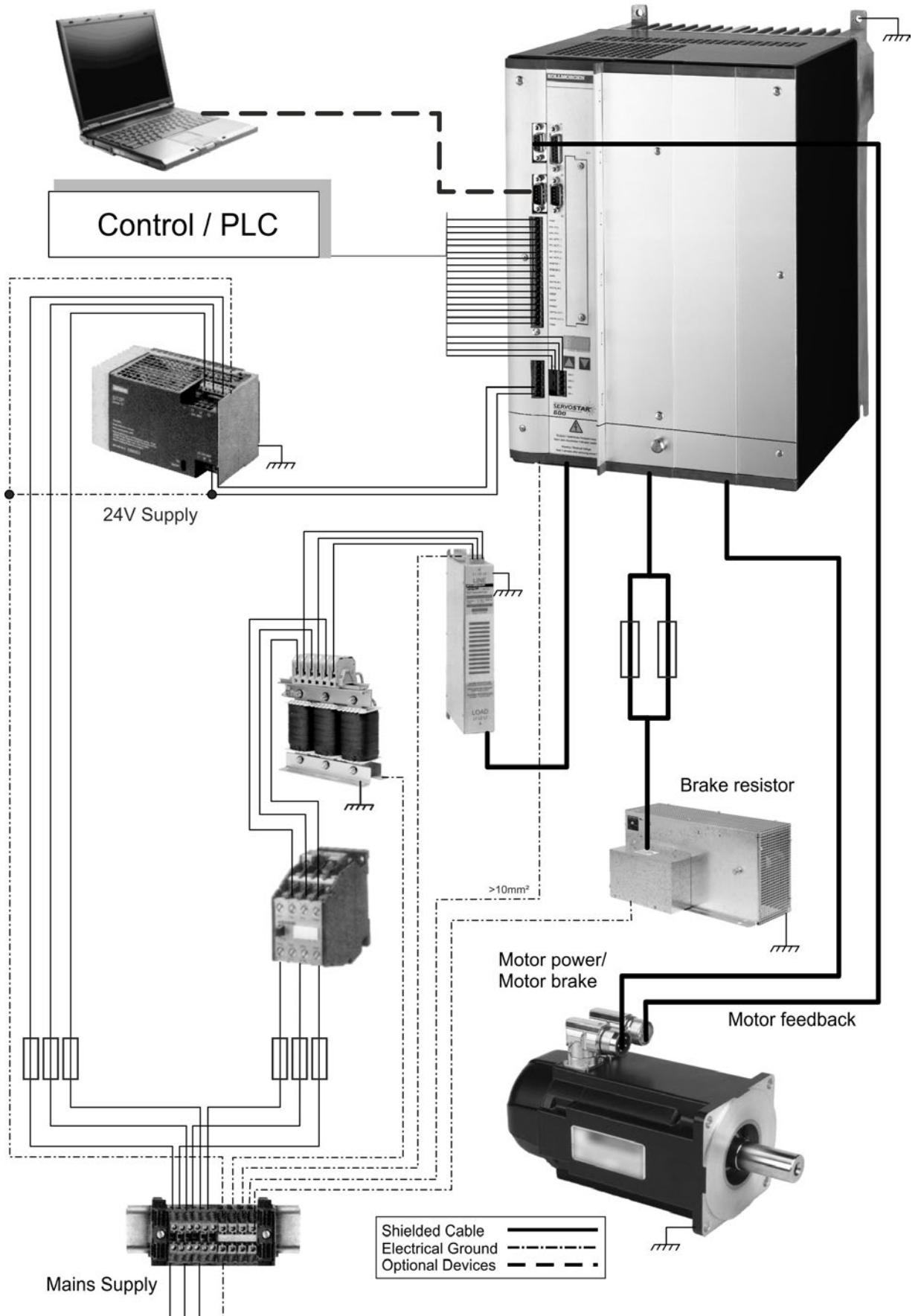

3.5 Drive System with S701...724

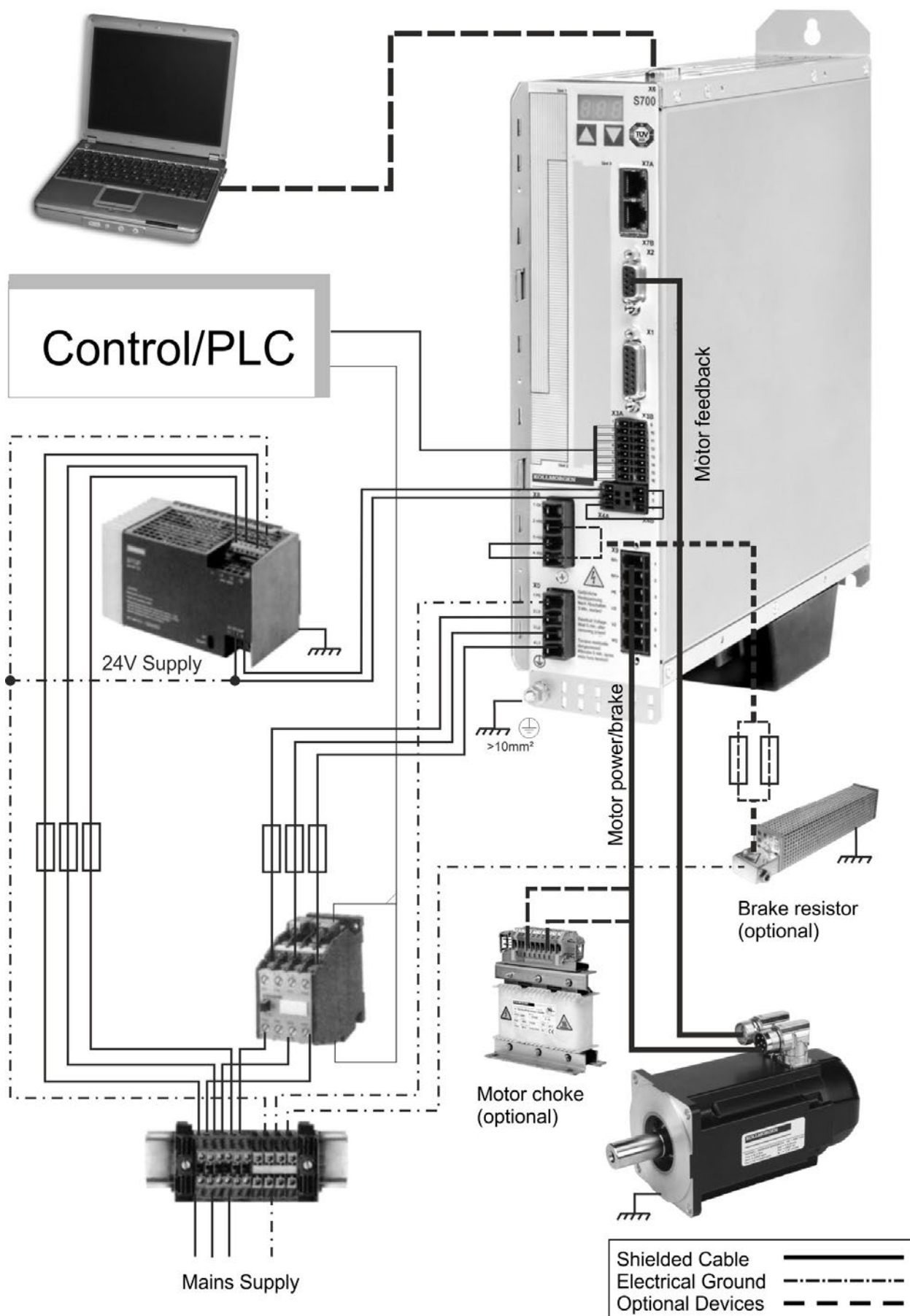

3.6 Drive System with S748/772

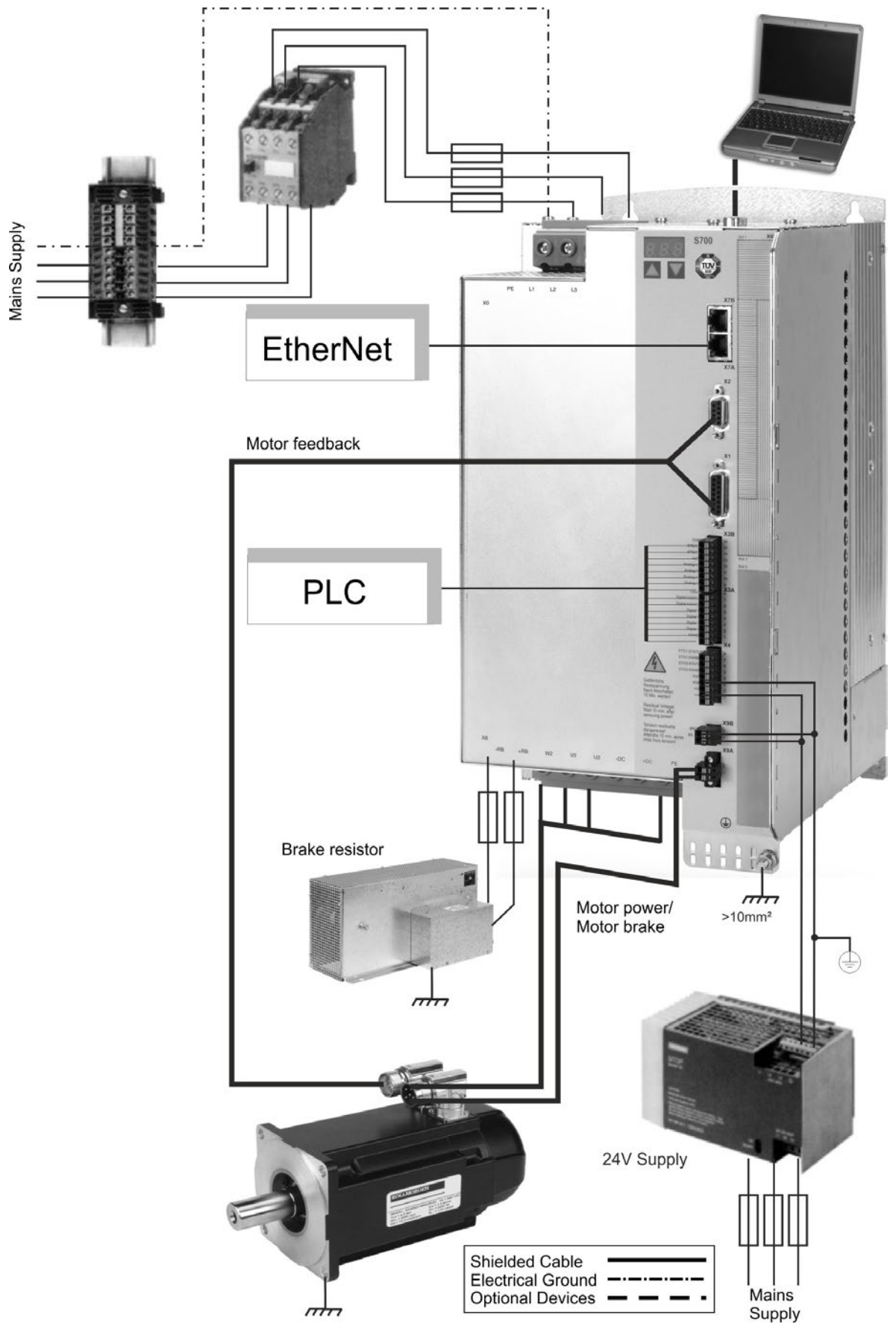

3.7 Drive System with AKD-x00306...02406

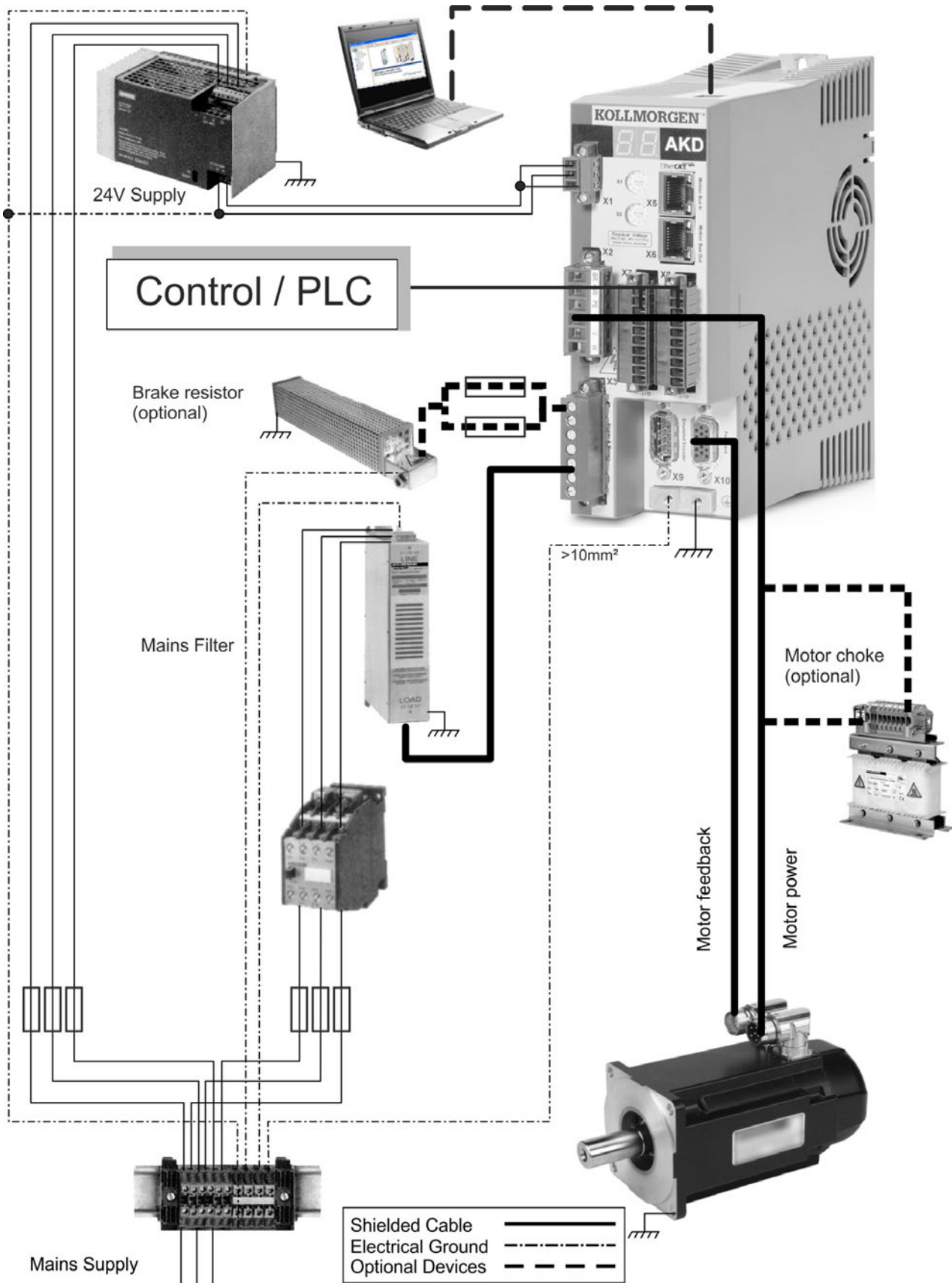

3.8 Drive System with AKD-x00307...02407

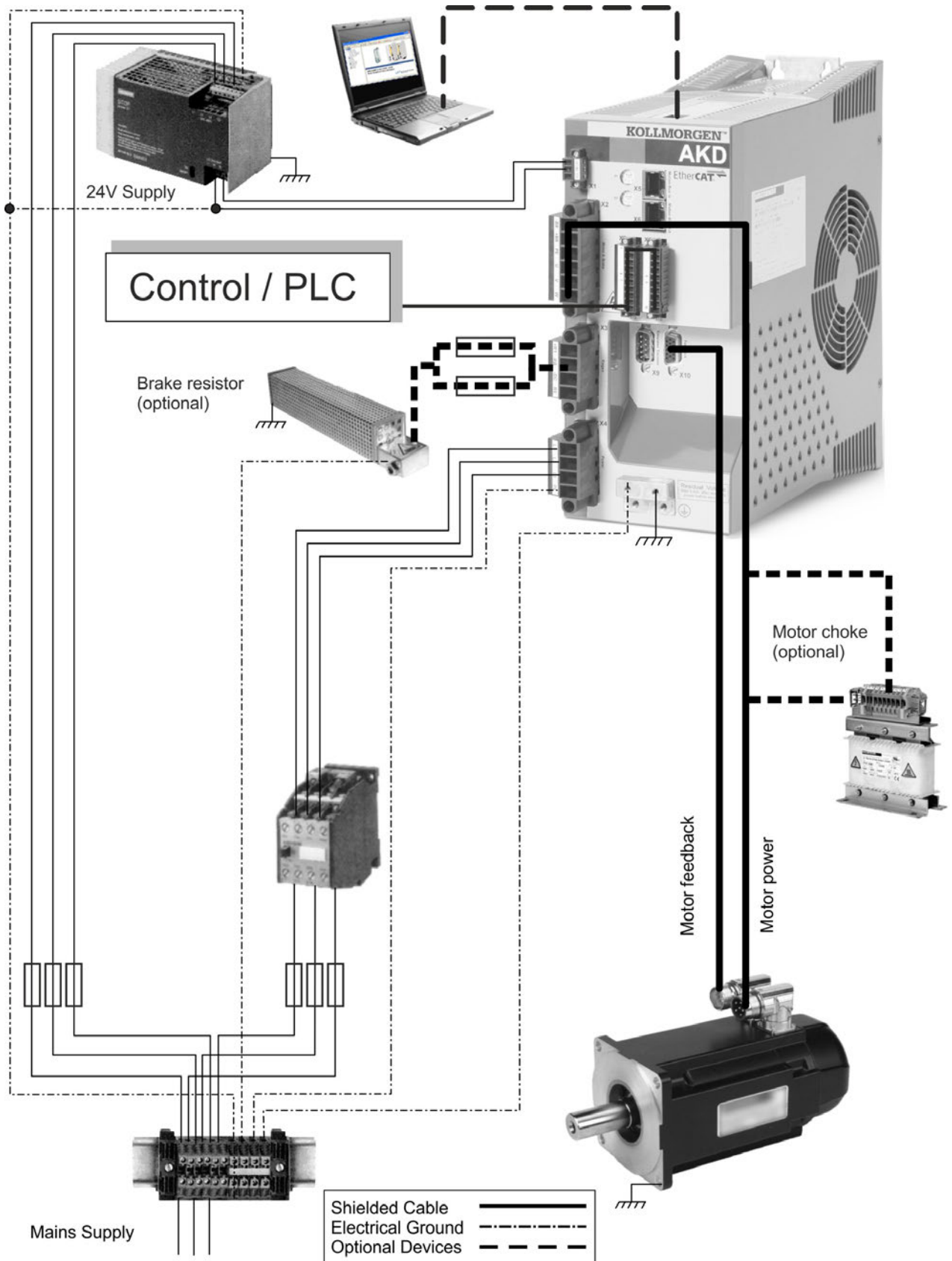

3.9 Drive System with AKD-x04807

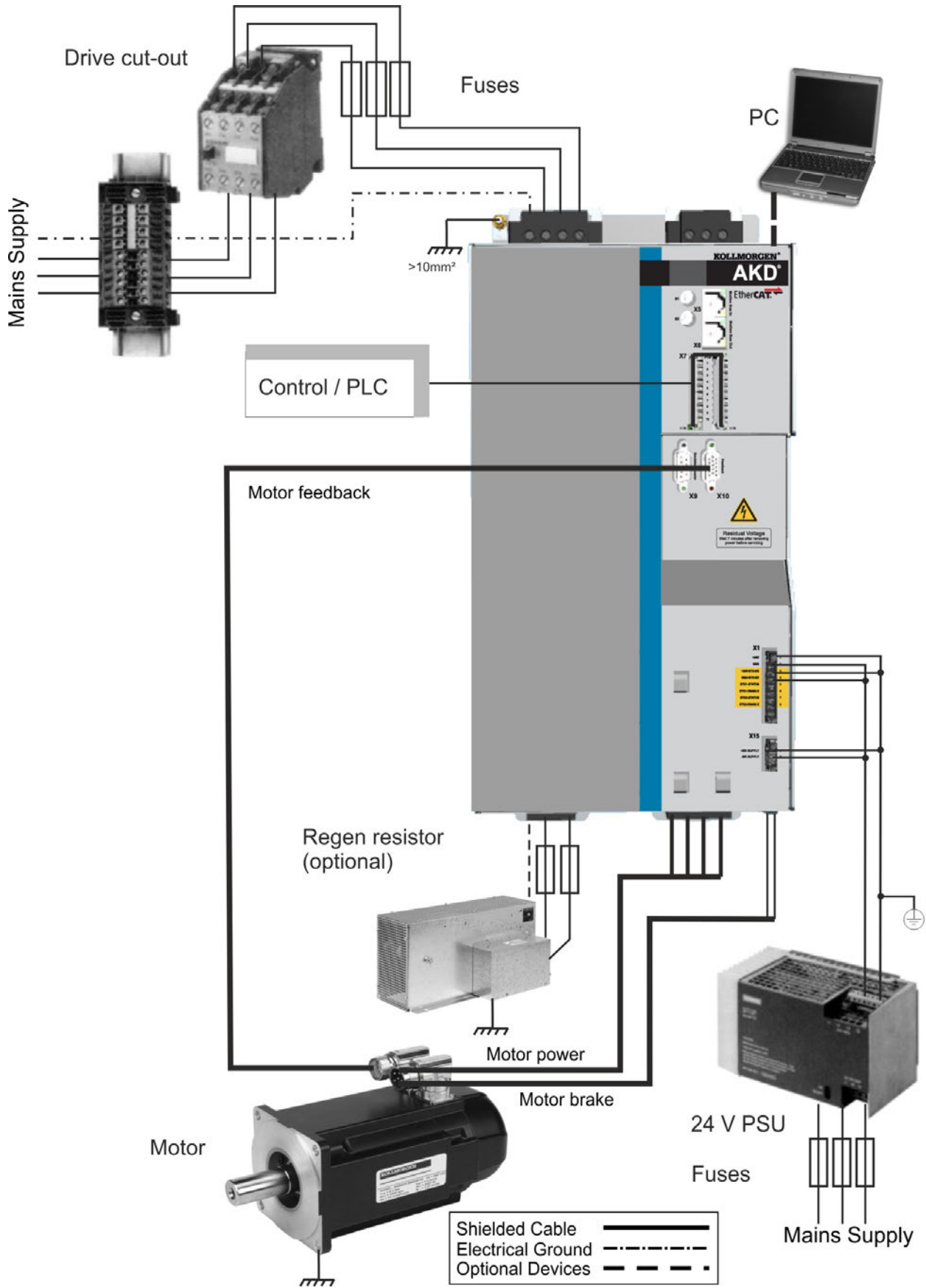

3.10 Decentralized Drive System with AKD-C and AKD-N

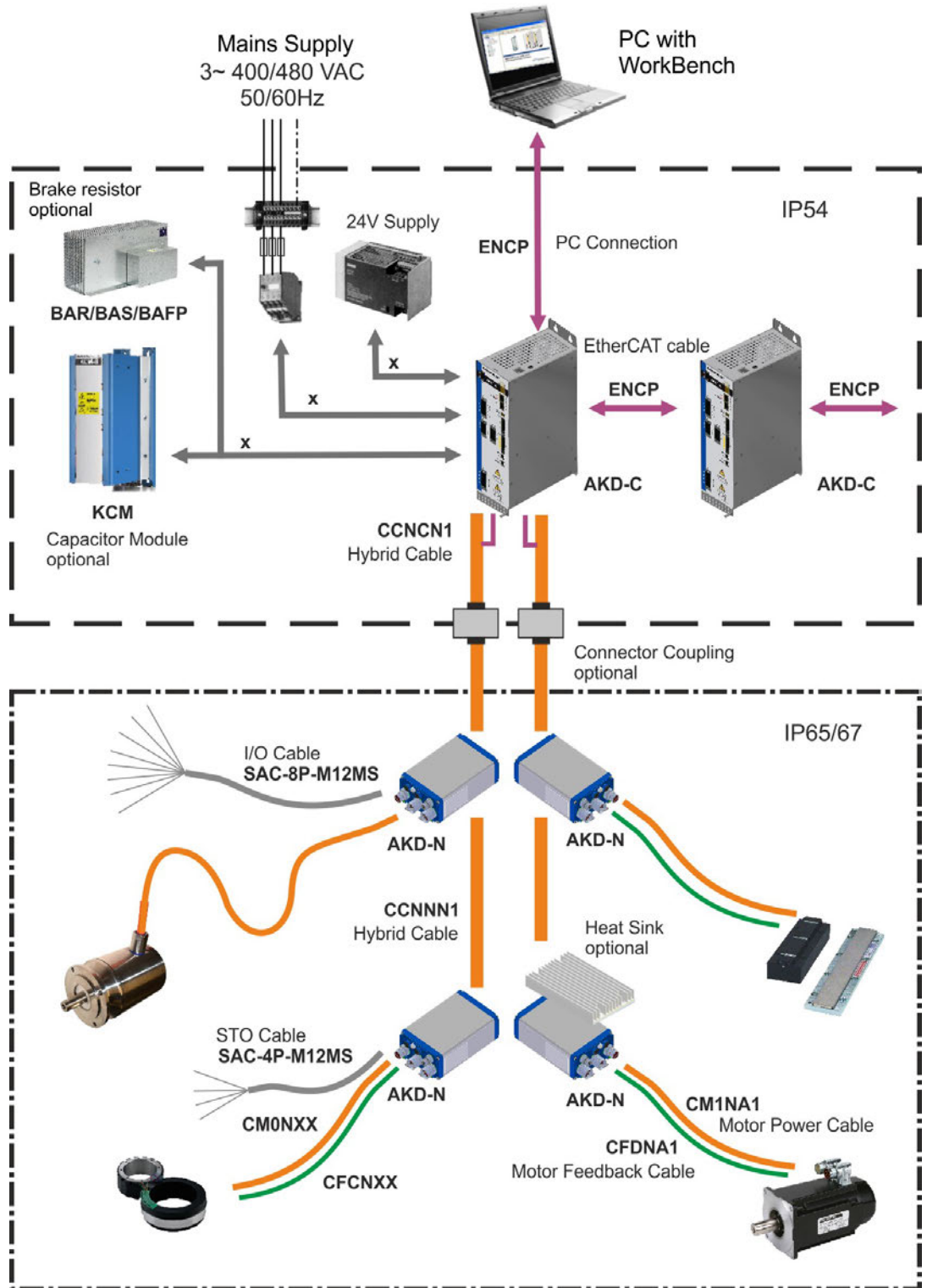

All components inside the borders are supplied by Kollmorgen with the exception of cables signed with "x". These cables are not supplied by Kollmorgen, you should use cables or wires according to EN 60204.

4 Mechanical Accessories

4.1 Mounting Kit for AKMH Motors

IEC mounting kits with 1 shaft center screw and 4 flange screws. Hygienic mounting is possible only with these screws.

Description	Order Code
Mounting Hardware AKMH2, Ax flange / Cx front mounting	MTG-KIT-AKMH2-IEC
Mounting Hardware AKMH3, Ax flange / Cx front mounting	MTG-KIT-AKMH3-IEC
Mounting Hardware AKMH4, Ax flange / Cx front mounting	MTG-KIT-AKMH4-IEC
Mounting Hardware AKMH5, Ax flange / Cx front mounting	MTG-KIT-AKMH5-IEC
Mounting Hardware AKMH6, Ax flange / Cx front mounting	MTG-KIT-AKMH6-IEC

NEMA mounting kits are described in the US selection guide, available from the Kollmorgen website www.kollmorgen.com).

4.2 Suspension Unit for AKM motors



DANGER

Suspended load. Risk of death if load falls. Never step under the load, while the motor is raised!

NOTICE

You must read the instructions manual for the suspension unit ZPMZ 120/292. Observe the "safety instructions" and "use as directed" hints before starting transportation work.

The Suspension Unit ZPMZ 120/292 is designed for suspended handling exclusively of motors (i.e., without attached units such as gearboxes, clutches, etc.) with a maximum weight of 120 kg and maximum nominal span of the extreme suspension hooks of 292 mm.

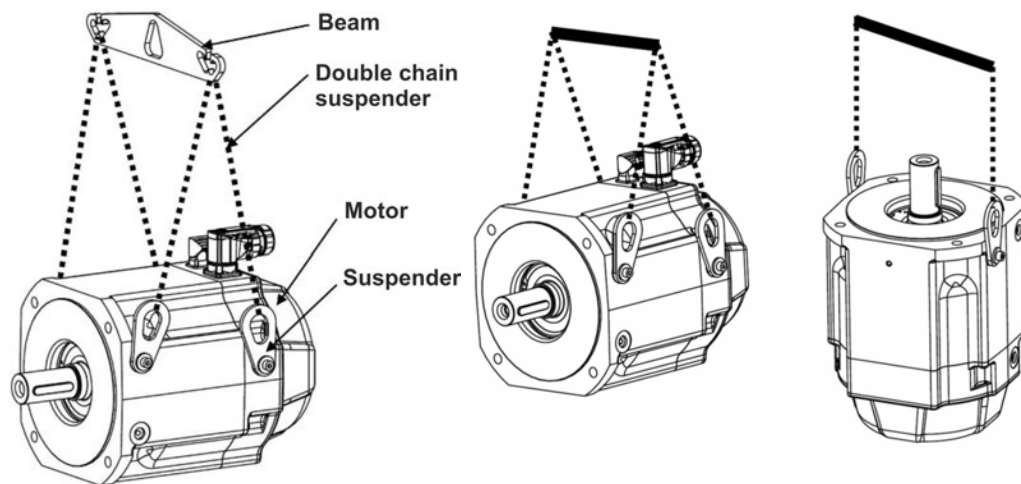

The suspended unit consists of a Beam, suspended off the crane hook and two double-run chain suspenders. The motor may be borne on two or four runs of the chain suspender.

The suspenders (number depends on the motor type) are delivered with the motor.

Technical Data				
Lifting capacity	120 kg		Weight	0,83 kg
Nominal span	292 mm		Number of cycles a year	20.000
Lug width	44,7 mm		Average load	60 %
Lug height	51 mm		Order code	FA00092

4.3 Fan Kit for AKM7 motors

NOTICE

Observe the mounting instructions delivered with the fan kit. The fan housing can be mounted either with both the supplied brackets and spacers or with the brackets only. The choice of mounting method depends on the application. If strong vibrations are expected, you should use both brackets and spacers. Motors with integrated brakes require the long spacers.

Mounting the fan kit enlarges the motor by approximately 65 mm. The detailed final dimensions of AKM7 motors with mounted fan kit can be found in the instructions manual of the AKM motor series. Ventilation of AKM7 motors allow increased current of the motors. This higher current usually requires larger wiring cross section compared to not ventilated motors. The necessary data for current and wiring cross section can be found in the technical data section of the AKM instructions manual.

Technical Data	
Supply voltage	24 VDC
Supply current	270 mA
Electrical power	6.5 W
Surface	Coated with polyester powder coating in matt black, not resistant against solvents
Protection class	IP 20
Connection	Cable gland 10 mm, cable diameter 4 mm to 6 mm, recommended cable 3x0.75 mm ² (not part of delivery)
Terminals	0.33 mm ² to 4 mm ²
Weight	2.52 kg
Order code	AKM7-FAN

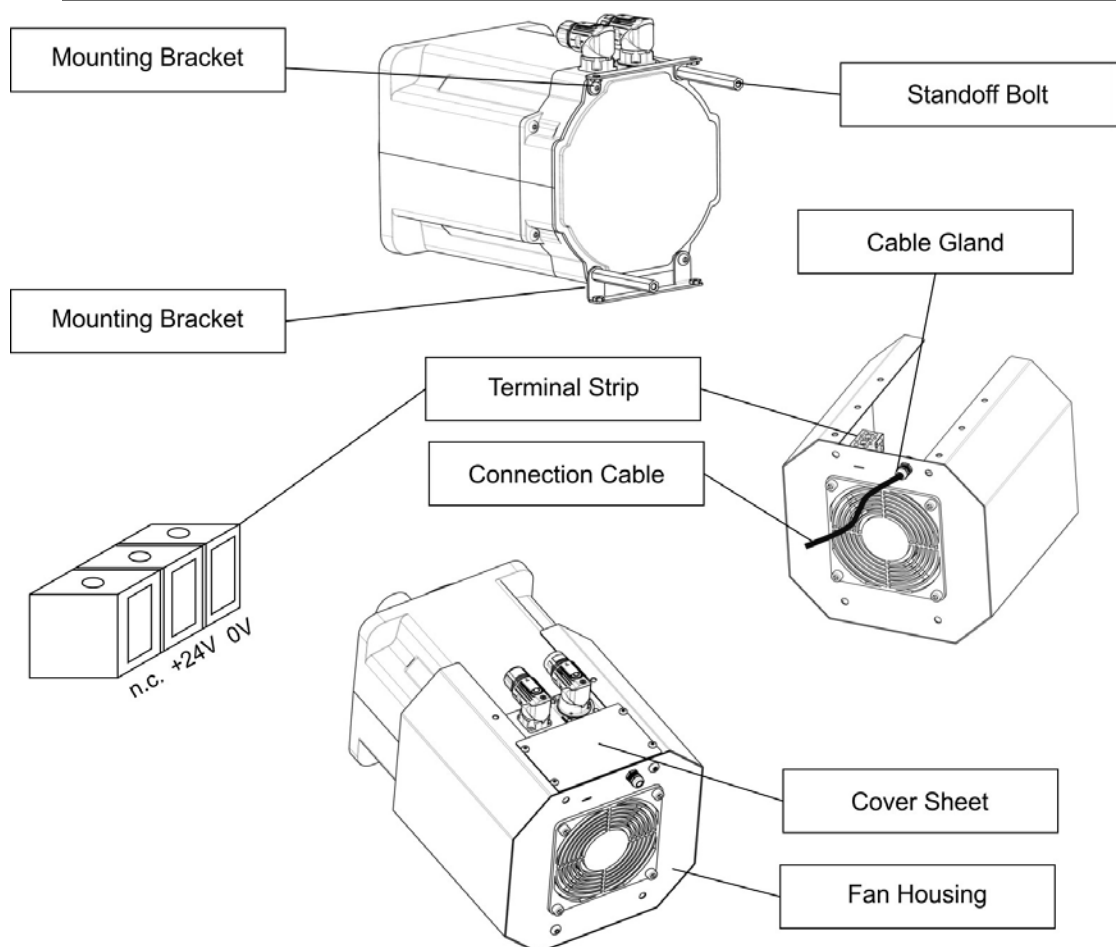

4.4 Mechanical accessories for AKD-N and AKD-C

NOTICE

You must read the AKD-N/AKD-C installation manuals. Observe the safety instructions given there before commencing mounting/installation work.

4.4.1 Heat Sink for AKD-N

When mounting AKD-N to the machinery, temperature management is important to ensure maximum performance of the drive system. In case of medium or bad cooling situation (as described in the AKD-N Installation Manual), you can mount a heat sink to the AKD-N.

Heat flow is optimized by a heat conducting film, which must be placed between heat sink and AKD-N.

Mounting holes in the heat sink and winding holes in the AKD-N are prepared for M4x16 hexagon socket screws to ISO 4762. Use a 3 mm T-handle Allen key for mounting.

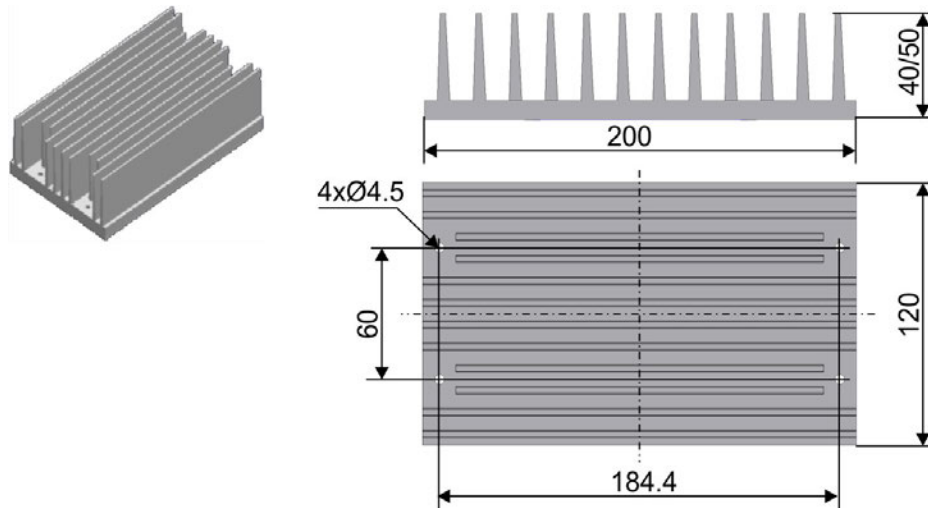

Order Codes

Article	Order codes
Heat sink Kit 40 mm with Heat conducting film and 4 screws M4x16	AKD-N 3,6 HEATSINK KIT 40MM
Heat sink Kit 50 mm with Heat conducting film and 4 screws M4x16	AKD-N 3,6 HEATSINK KIT 50MM
Heat conducting film	849-373000-04

4.4.2 Mounting clamps for AKD-N

The AKD-N servo amplifier is mounted to the machine with special mounting clamps. The delivery package contains 4 clamps. In case of lost or damaged clamps, you can order a set of four clamps.

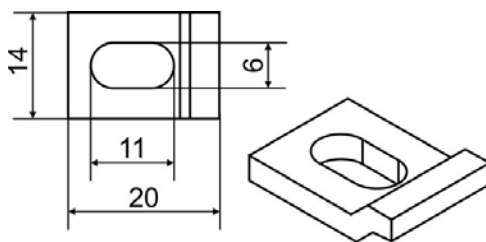

Order Codes

Article	Order codes
AKD-N Mounting Clamps Set, 4 clamps	AKD-N-M/C-Set

4.4.3 Sealing plugs for AKD-N connectors

The sealing plugs in the delivery package are screwed to unused AKD-N connectors to ensure the IP class for the machine environment. In case of lost plugs, you can order a set with 3 different plug sizes.



Order Code

Article	Order Codes
AKD-N Sealing Plug Set, 4xM12, 2xM23, 2xM17	AKD-N-S/P-Set

4.4.4 Connector Kit for AKD-C

Mating connectors X12, X13, X14, X15, and X17 are part of delivery. If a mating connector is lost or damaged, you can order the AKD-C Connector Kit.

Order Code

Article	Order Codes
AKD-N Connector Kit, included mating connectors X12, X13, X14, X15, and X17	AKD-C-CONKIT

4.4.5 Cabinet connector coupling for AKD-C/N

The connector coupling must be built into the outer wall of a cabinet. The connector coupling connects power and signal lines as well as shielding of the hybrid cables and ensures the long-term sealed transition between cabinet environment (IP54) and machine environment (IP65/67).

Inside the cabinet the CCNCN1 cable (→ p. 65) to AKD-C can be plugged in, outside the cabinet the CCNNN1 cable (→ p. 65) to AKD-N can be plugged in.

Order Codes

Article	Order Codes
Hybrid Connector Coupling AKD-C/AKD-N	AKD-CN-Coupling*

*in process

5 Shield clamps

NOTICE

You must read the instructions manuals for the servo amplifier/servo motor you are using in your application. Observe the safety instructions they contain before commencing mounting/installation work.

5.1 Auxiliary terminals on the servo amplifier

S300, S701...724 and AKD



These servo amplifiers feature slots on the front panel for the connection of additional shield clamps.

Article	Tension range	Order Codes
SK14	6-13mm	DE-108248

S640/670, S748/772



The shroud supplied with these servo amplifiers features slots for the connection of additional shield clamps.

We recommend using the following shield clamp:

Manufacturer	Article	Tension range
OBO (Bettermann)	BBS-Schelle Typ 2056	16-22mm
OBO (Bettermann)	BBS-Schelle Typ 2056	28-34mm

The clamps are part of delivery of the servo amplifier.

5.2 External shielding busbar



The power cable shields (line in, motor cable, external regen resistor) can be routed to an additional busbar via shield clamps.

Kollmorgen recommends using Weidmüller KLBÜ shield clamps.

A possible scenario for setting up a busbar for the above shield clamps is described below.

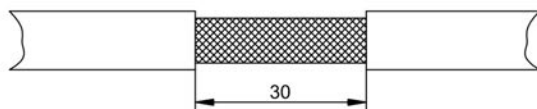
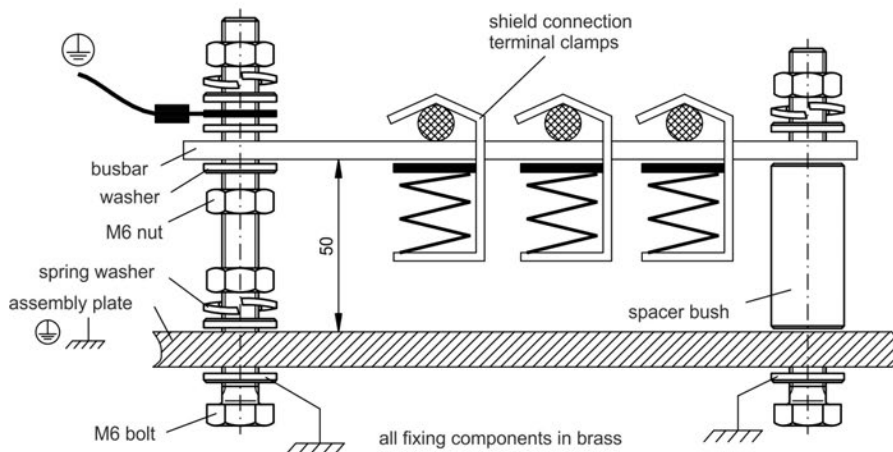
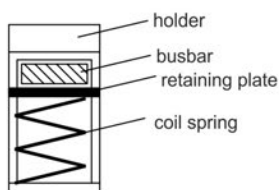
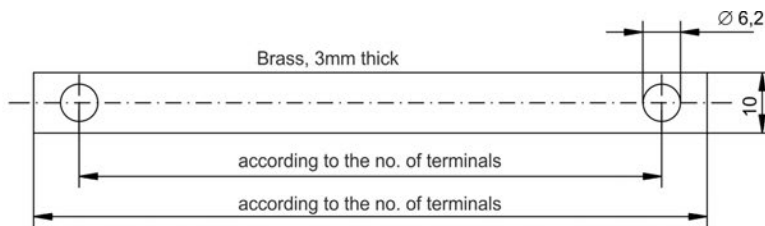

1. Cut a busbar of the required length from a brass rail (cross-section 10 x 3 mm) and drill holes in it as indicated. All shield clamps required must fit between the drill holes.



CAUTION

Risk of injury due to the spring force of the coil spring. Use pliers.

2. Squeeze together the coil spring and the supporting plate and push the busbar through the opening in the holder.
3. Mount the busbar with the shield clamps fitted on the assembly plate. Use either metal spacer bushes or screws with nuts and accessories to maintain a spacing of 50 mm. Earth the busbar using a single conductor with a cross-section of at least 2.5 mm².
4. Strip the external cable sheath to a length of approximately 30 mm, taking care not to damage the braided shield. Push the shield clamp up and route the cable to it via the busbar.

NOTICE

Make sure there is good contact between the shield clamp and the braided shield.

6 Mains chokes

NOTICE

You must read the instructions manuals for the servo amplifier and servo motor you are using in your application. Observe the safety instructions given there.

6.1 General

A 3L mains choke must be used on S640/670 servo amplifiers in order to reduce mains harmonics.

In special cases, if mains voltage is more than 3% asymmetrical, then the S748/772 must be used with a mains choke. In unfavorable combination of mains impedance and DC bus capacitance the unloaded DC bus may reach voltage up to 800V without choke. For EMC reasons the chokes should be mounted isolated to the cabinet. Single conductors can be used for wiring, shielded cables are not required. More information see WIKI "[Mains Choke](#)".

Purpose of mains choke:

- Prevents impermissible loading of semiconductors in the event of rapid current rise during commutation.
- Prevents voltage dips in the mains voltage caused by commutation.
- Reduces current ripple in the DC link, thereby increasing the service life of the DC link capacitors.

6.2 Important notes



DANGER

Power terminals are capable of conducting hazardous voltage up to 10 minutes after the mains voltage has been disconnected. Risk of electric shock. Before starting work on power terminals, check that the phase-to-earth and phase-to-phase voltages have de-energised.

NOTICE

Due to the high earth leakage currents induced by the system, you should observe the requirements of EN 61800-5-1 (e.g. fixed installation, $\geq 10 \text{ mm}^2$ or double protective earth) when carrying out mounting and installation work. You must read the instructions manual for the servo amplifier/servo motor you are using in your application and observe the safety instructions they contain before commencing mounting/installation work.

Mounting: 50mm free space required above and below the device.

Connection diagram: see servo amplifier instructions manual.

6.3 Type assignment and order codes

Servo amplifier	Mains choke
S640/670 (with asymmetrical mains >3% only)	4% uk
S748/772 (with asymmetrical mains >3% only)	2% uk
AKD, S300, S400, S601...620, S701...724	not required

Order Codes

Article	uk	Order codes
Mains choke 3L0,5-63-4 (0.47mH, 63A)	4%	DE-92201
Mains choke 3L0,4-80-4 (0.37mH, 80A)	4%	DE-92100
Mains choke 3L0,2-160-4 (0.19mH, 160A)	4%	DE-92099
Mains choke 3L0,24-50-2 (0.24mH, 50A)	2%	DE-201476
Mains choke 3L0,2-75-2 (0.20mH, 75A)	2%	DE-201477

6.4 Mains choke 3L

NOTICE

A number of servo amplifiers can be connected to one and the same mains choke; the rated current of the mains choke must be greater than or at least equal to the total current of the connected servo amplifiers.

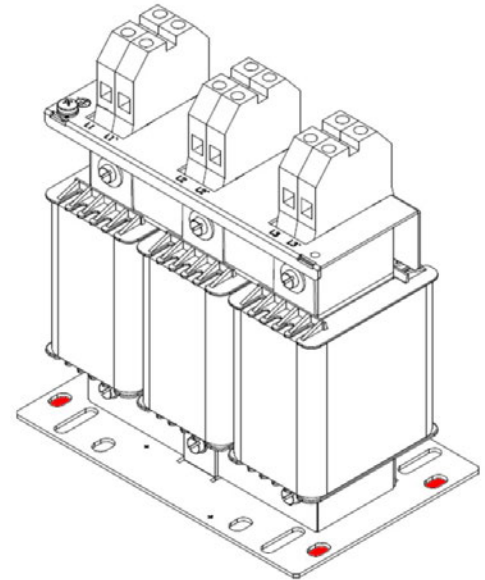
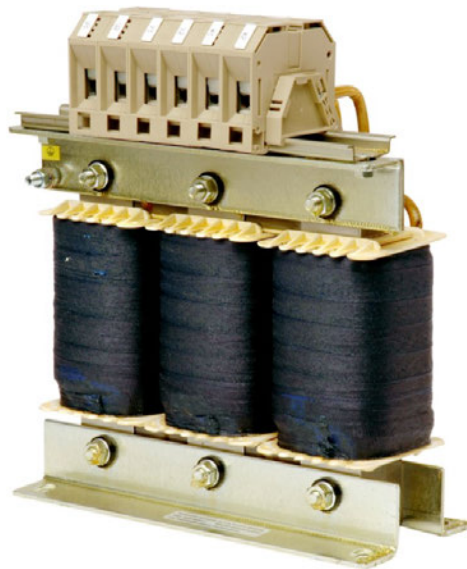
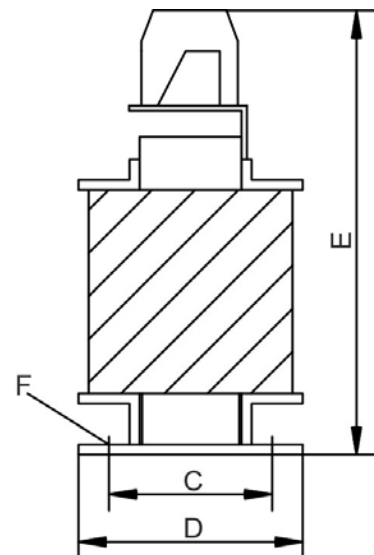
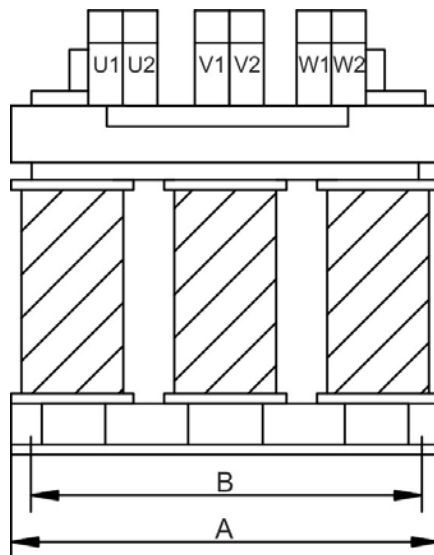

Photo: 3L0,2-160-4, all models are similar



Technical Data

Type	Inductivity [mH]	Nominal Current [A]	uk [%]	A [mm]	B [mm]	C [mm]	D [mm]	E [mm]	F [mm]	Terminals [mm ²]	Weight [kg]
3L 0,5-63-4	0.47	63	4	185	170	77	122	215	8x12	16	9.65
3L 0,4-80-4	0.37	80	4	210	175	85	125	240	8x12	16	12.5
3L 0,2-160-4	0.19	160	4	291	273	116.5	148.5	310	10x18	95	27
3L 0,24-50-2	0.24	50	2	152.5	114.3	88.9	114.3	163	6.5	10	5.9
3L 0,2-75-2	0.20	75	2	185	170	77	122	220	8x12	35	9.9

7 Mains filters

7.1 General

AKD-x00306 to AKD-x02406 and S640/670 servo amplifiers require an external mains filter. All other servo amplifiers feature built-in mains filters (see the relevant instructions manual). The filtering effect of the mains filters can only be assured if the permissible throughput rating of the mains filters is not exceeded even on peak loading of the servo amplifiers with I_{peak} .

The max. available throughput rating of the mains filter must be higher than the max. power consumption of the servo amplifiers and higher than the maximum power consumption of the motors. More information can be found on the WIKI page "[Mains Filter](#)".

7.2 Important notes



DANGER

Power terminals are capable of conducting hazardous voltage up to 10 minutes after the mains voltage has been disconnected. Risk of electric shock. Before starting work on power terminals, check that the phase-to-earth and phase-to-phase voltages have de-energized.

NOTICE

Due to the high earth leakage currents induced by the system, you should observe the requirements of EN 61800-5-1 (e.g. fixed installation, $\geq 10 \text{ mm}^2$ or double protective earth) when carrying out mounting and installation work. You must read the instructions manuals for the used components and observe the safety instructions they contain before commencing mounting/installation work. See servo amplifier instructions manual for connection diagrams.

7.3 Type assignment and order codes

Servo amplifier	Mains filter	
S300, S400, S601...620, S700, AKD-x00307...04807 (240 to 480V)	not required	
S640/670	3EF	
AKD-B/P/T/M 00306...02406 (120 to 240V)	1NF, 3NF	

Article	Order code	Remarks
Mains filter 1NF-10 (230 VAC, 10A)	DE-201565	1~, 230V AC, CE*, UL
Mains filter 1NF-12 (230 VAC, 12A)	DE-201566	1~, 230V AC, CE*, UL
Mains filter 1NF-20B (125V/230 VAC, 20A)	DE-201865	1~, IEC 230V AC, UL 125 V AC, CE*
Mains filter 1NF-25 (230 VAC, 25A)	DE-201568	1~, 230V AC, CE*, UL
Mains filter 3NF-07 (480 VAC, 07A)	DE-201569	3~, 480V AC, CE*, UL
Mains filter 3NF-16 (480 VAC, 16A)	DE-201570	3~, 480V AC, CE*, UL
Mains filter 3NF-30 (480 VAC, 30A)	DE-201571	3~, 480V AC, CE*, UL
Mains filter 3EF-42 (480 VAC, 42A)	DE-92102	3~, 480V AC, CE*, UL
Mains filter 3EF-75 (480 VAC, 42A)	DE-92103	3~, 480V AC, CE*, UL
Mains filter 3EF-100 (480 VAC, 42A)	DE-92104	3~, 480V AC, CE*, UL
Mains filter 3EF-130 (480 VAC, 42A)	DE-92105	3~, 480V AC, CE*, UL

* No EC directive matches mains filters actually. You can use the filters in Europe, they are manufactured according to harmonized standards concerning creeping and voltage distances.

7.4 Mains filters 1NF-10...12

Observe the safety instructions → p. 28.
For single-phase operation only.

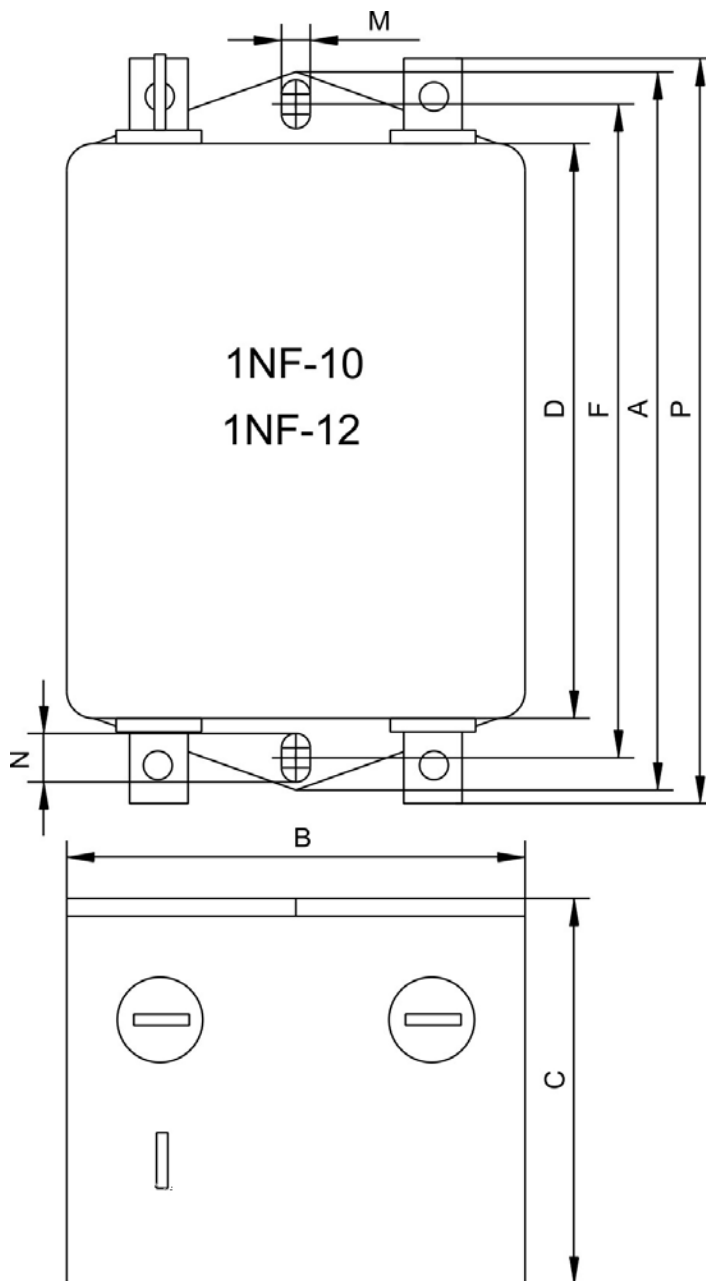

Technical Data

Type	Nominal Current [A]*	Nominal Voltage [V]	A [mm]	B [mm]	C [mm]	D [mm]	F [mm]	M [mm]	N [mm]	P [mm]	Weight [kg]	Connection
1NF-10	10	230	85	49	40.3	54	75	5.3	6.3	87	0.29	Fast-on
1NF-12	12	230	156	57.5	45.4	130.5	143	5.3	6	156	0.73	Fast-on

* at 40°C environment temperature

7.5 Mains filters 1NF-20B, 1NF-25



Observe the safety instructions → p. 28.
For single-phase operation only.

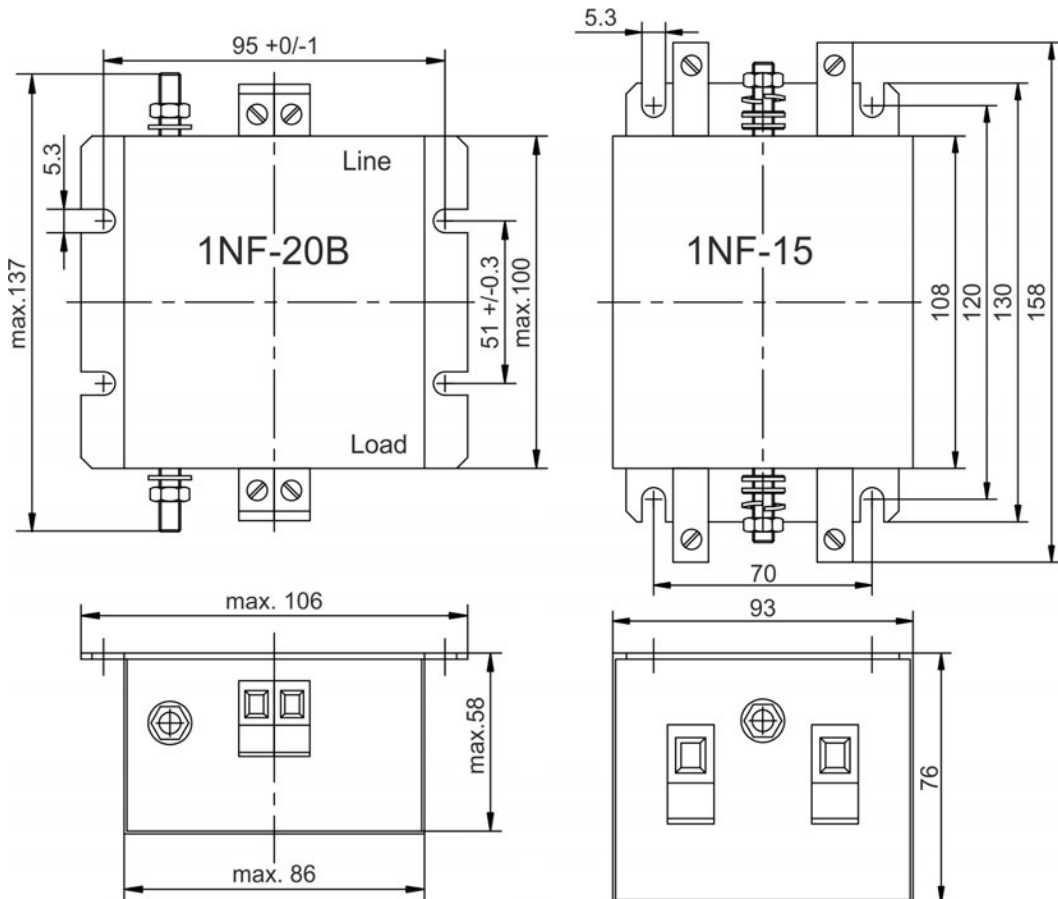

Technical Data

Type	Nominal Current [A]*	Nominal Voltage		Weight [kg]	Connection Phase Terminals	Connection PE
		IEC	UL/CSA			
1NF-20B	20	230V	125V	0.93	Wires up to 4mm ² Torque 0.6 to 0.8 Nm	Bolt M 6 Torque 3.5 to 4 Nm
1NF-25	25	230V	230V	0.7	Wires up to 10mm ² Torque 1.5 to 1.8 Nm	

* at 50°C environment temperature

7.6 Mains filters 3NF-07...30

Observe the safety instructions → p. 28.

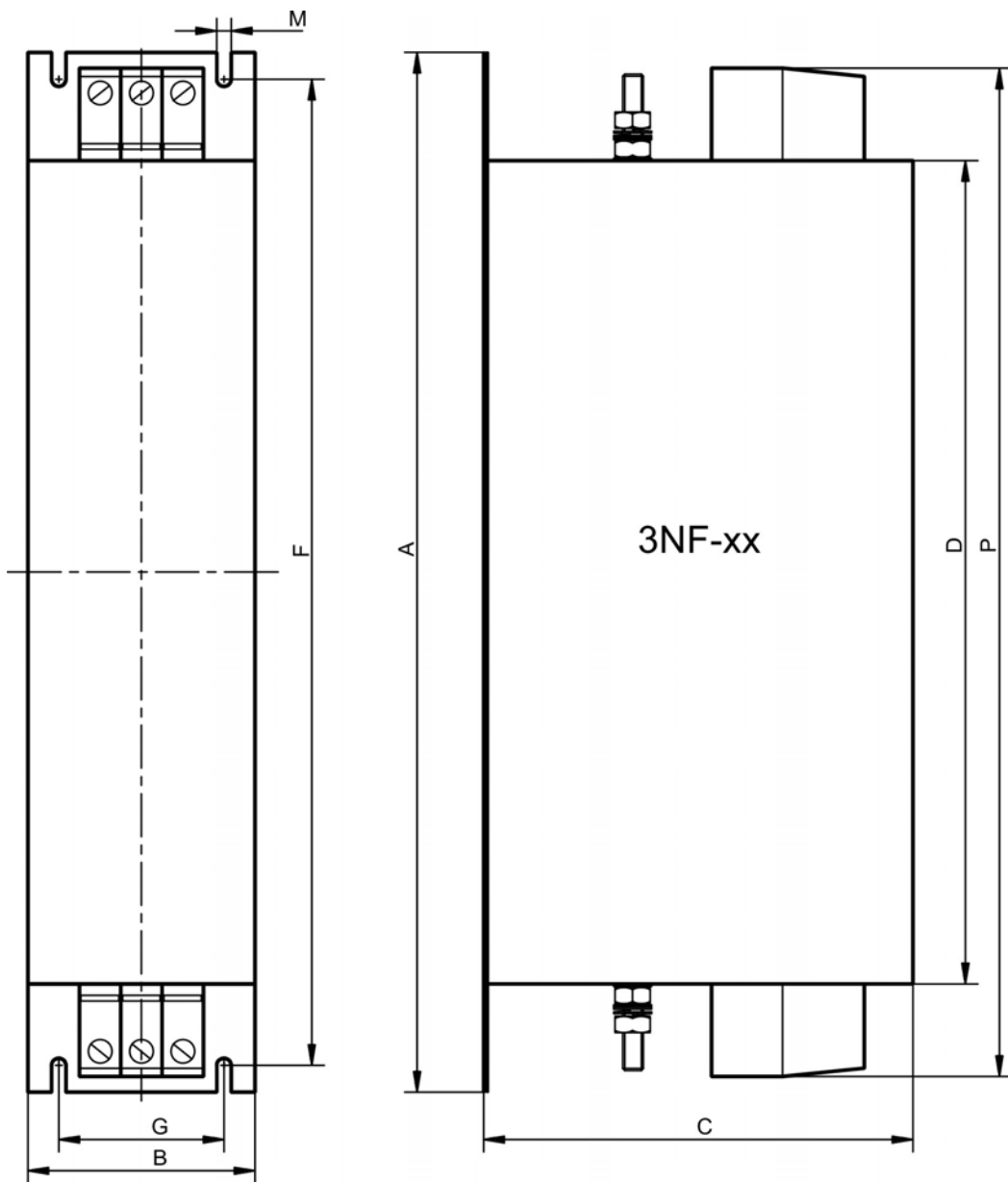

Technical Data

Type	Nom. Current*	A [mm]	B [mm]	C [mm]	D [mm]	F [mm]	G [mm]	M [mm]	P [mm]	Weight [kg]	Terminals	PE Bolt
3NF-07	7 A	190	40	70	160	180	20	4.5	180	0.5	4mm ² ,	M5, 2.2Nm
3NF-16	16 A	250	45	70	220	235	25	5.4	240	0.8	0.7..0.8Nm	
3NF-30	30 A	270	50	85	240	255	30	5.4	260	1.2	10mm ² , 1.9..2.2Nm	

* at 50°C environment temperature

7.7 Mains filters 3EF-42...130

Observe the safety instructions → p. 28.

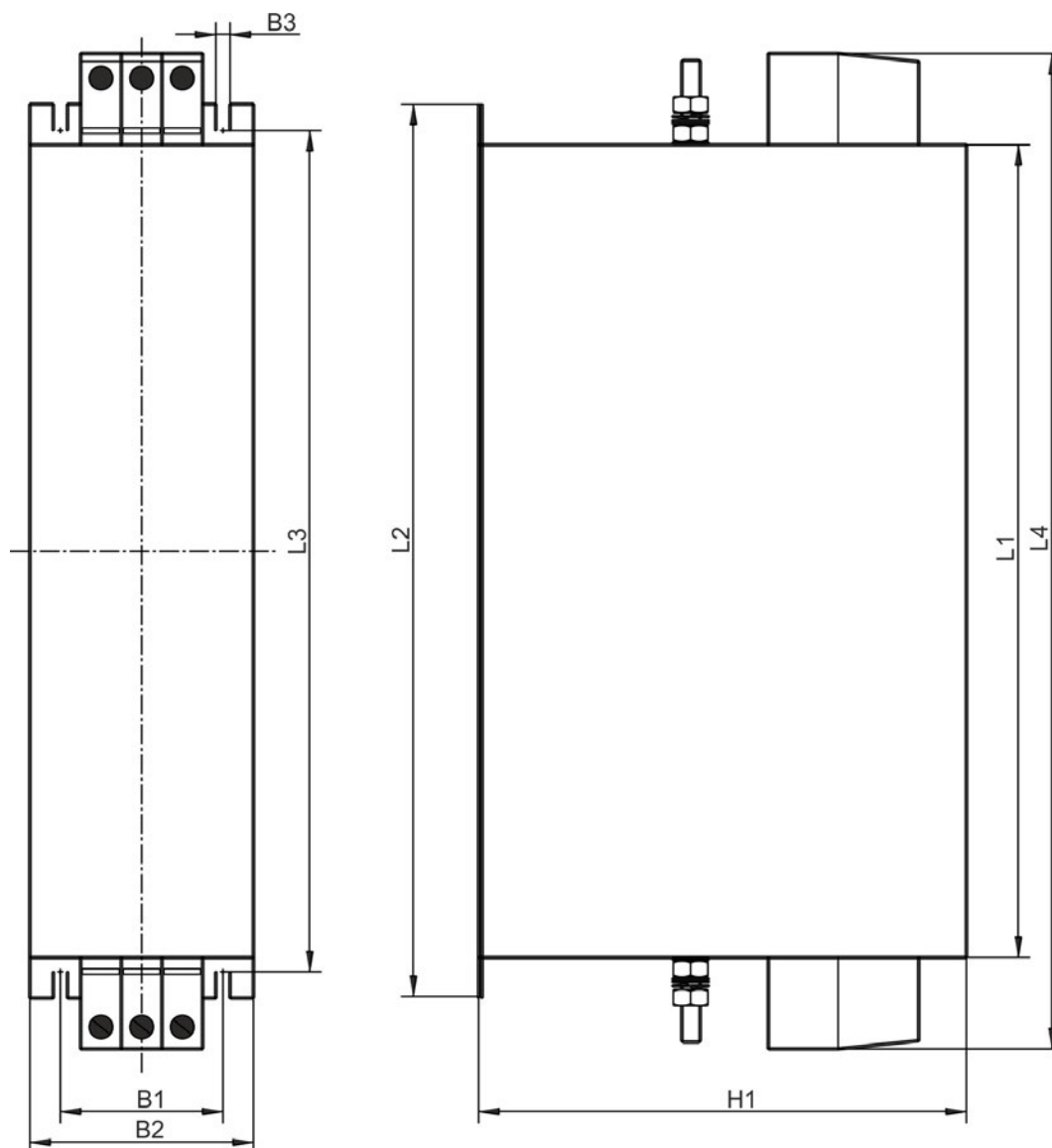

Technical Data

Type	Nom. Current*	L1 [mm]	L2 [mm]	L3 [mm]	L4 [mm]	B1 [mm]	B2 [mm]	B3 [mm]	H1 [mm]	Terminals [mm ²]	PE Bolt [mm]
3EF-42	42 A	305	335	320	355	35	60	7	150	10	5
3EF-72	75 A	300	330	314	380	55	80	7	185	25	6
3EF-100	100 A	300	330	314	380	55	80	7	220	25	8
3EF-130	130 A	350	380	364	440	65	90	7	220	50	10

8 Brake resistors

8.1 General

During braking with the aid of the motor, energy is fed back into the servo amplifier. This regenerative energy is dissipated as heat in the brake resistor. The brake resistor is switched on by the brake circuit. Different resistance values have to be used depending on the servo amplifier. All resistors meet the requirements of CE directives and are UL-registered.

Hints for calculation of the brake power can be found in our Product WIKI on page "[Calculation of brake power](#)", more information to the resistors are given on WIKI page "[Brake Resistors](#)".

8.2 Important notes



WARNING

The brake resistor surface temperature can exceed 250°C. Risk of burns! Measure the temperature and wait until temperature dropped down below 40°C, before touching the resistor housing.

NOTICE

Inadequate levels of cooling air or incorrect installation can lead to overheating and destruction of the resistor and surrounding components.

- May only be installed in switchgear cabinets, comply with the permissible installation types and clearances (see dimensional drawing).
- Ensure there is unobstructed convection for cooling purposes.
- Use temperature-resistant materials in the vicinity of the resistor.
- The connection terminals must never be located within the flow range of the heated waste air.

The following requirements must be met to ensure the brake resistors work properly:

- Compliance with required installation clearances
- Compliance with permissible installation type
- Unhindered access of cooling air
- Unhindered diverting of warmed up air
- Rated data with maximum ambient temperature 40°C, in case of ambient temperature higher than 40°C, power must be reduced by 4% per 10K temperature rise

NOTICE

You must read the instructions manual for the servo amplifier/servo motor you are using in your application and observe the safety instructions they contain before commencing mounting/installation work.

A connection diagram appears in the servo amplifier's instructions manual.

8.3 Type assignment and order codes

Servo amplifier	Brake resistor	Resistance/ Ω	Remarks
S300 (S3xx61)	BAR(U)	66	optional
S300 (S3xx01)	BAR(U)	91	optional
S400, S601...620, S701-712	BAR(U)	33	optional
S640, S748	BAS(U)	15	usually required
S670, S772	BAS(U)	10	usually required
S724	BAR(U)/BAS(U)	23	optional
AKD-x00306*	BAFP(U)/BAR(U)/BAS(U)	33	usually required
AKD-x00606*	BAFP(U)/BAR(U)/BAS(U)	33	usually required
AKD-x01206*	BAR(U)/BAS(U)	15	optional
AKD-x02406*	BAR(U)/BAS(U)	15	optional
AKD-x00307*	BAR(U)/BAS(U)	33	optional
AKD-x00607*	BAR(U)/BAS(U)	33	optional
AKD-x01207*	BAR(U)/BAS(U)	33	optional
AKD-x02407*	BAR(U)/BAS(U)	23	optional
AKD-x04807*	BAS(U)	10	optional
AKD-C01007	BAR(U)/BAS(U)	33	optional

Order codes

Article	Amplifier	Resistance [Ω]	Rated Power [W]	Max. Power [W]	Order code
Brake resistor BAS(U) 2000-10	S670, S772, AKD-x04807	10	2000	3200	DE-103874
Brake resistor BAS(U) 3000-10		10	3000	4800	DE-103875
Brake resistor BAS(U) 6000-10		10	6000	9600	DE-103876
Brake resistor BAR(U) 500-15	AKD-x01206 & x02406, S640, S748	15	500	800	DE-201439
Brake resistor BAR(U) 1000-15		15	1000	1600	DE-201440
Brake resistor BAS(U) 2000-15		15	2000	3200	DE-103871
Brake resistor BAS(U) 3000-15		15	3000	4800	DE-103872
Brake resistor BAS(U) 6000-15		15	6000	9600	DE-103873
Brake resistor BAR(U) 600-23	AKD-x02407, S724	23	600	960	DE-200613
Brake resistor BAR(U) 1000-23		23	1000	1600	DE-200614
Brake resistor BAS(U) 2000-23		23	2000	3200	DE-200615
Brake resistor BAS(U) 3000-23		23	3000	4800	DE-200616
Brake resistor BAS(U) 4000-23		23	4000	6400	DE-200617
Brake resistor BAFP(U) 100-33	AKD-x00306 to -x00606 AKD-x00307 to -x01207, AKD-C01007, S400, S601...620, S701-712	33	100	160	DE-201437
Brake resistor BAFP(U) 200-33		33	200	320	DE-201438
Brake resistor BAR(U) 250-33		33	250	400	DE-106254
Brake resistor BAR(U) 500-33		33	500	800	DE-106255
Brake resistor BAR(U) 1500-33		33	1500	2400	DE-106258
Brake resistor BAS(U) 3000-33		33	3000	4800	DE-201407
Brake resistor BAR(U) 300-66		S300 (S3xx61)	66	300	480
Brake resistor BAR(U) 600-66	66		600	960	DE-107162
Brake resistor BAR(U) 1000-66	66		1000	1600	DE-107163
Brake resistor BAR(U) 300-91	S300 (S3xx01)	91	300	480	DE-107164
Brake resistor BAR(U) 600-91		91	600	960	DE-107165
Brake resistor BAR(U) 1000-91		91	1000	1600	DE-107166

*= AKD-x means AKD variants -B, -P, -T and -M

8.4 External brake resistor BAFP(U)



Protection class: IP40



The surface temperature can exceed 250°C.
Risk of burns and fire! Measure the temperature before touching.

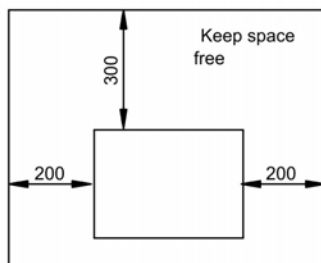
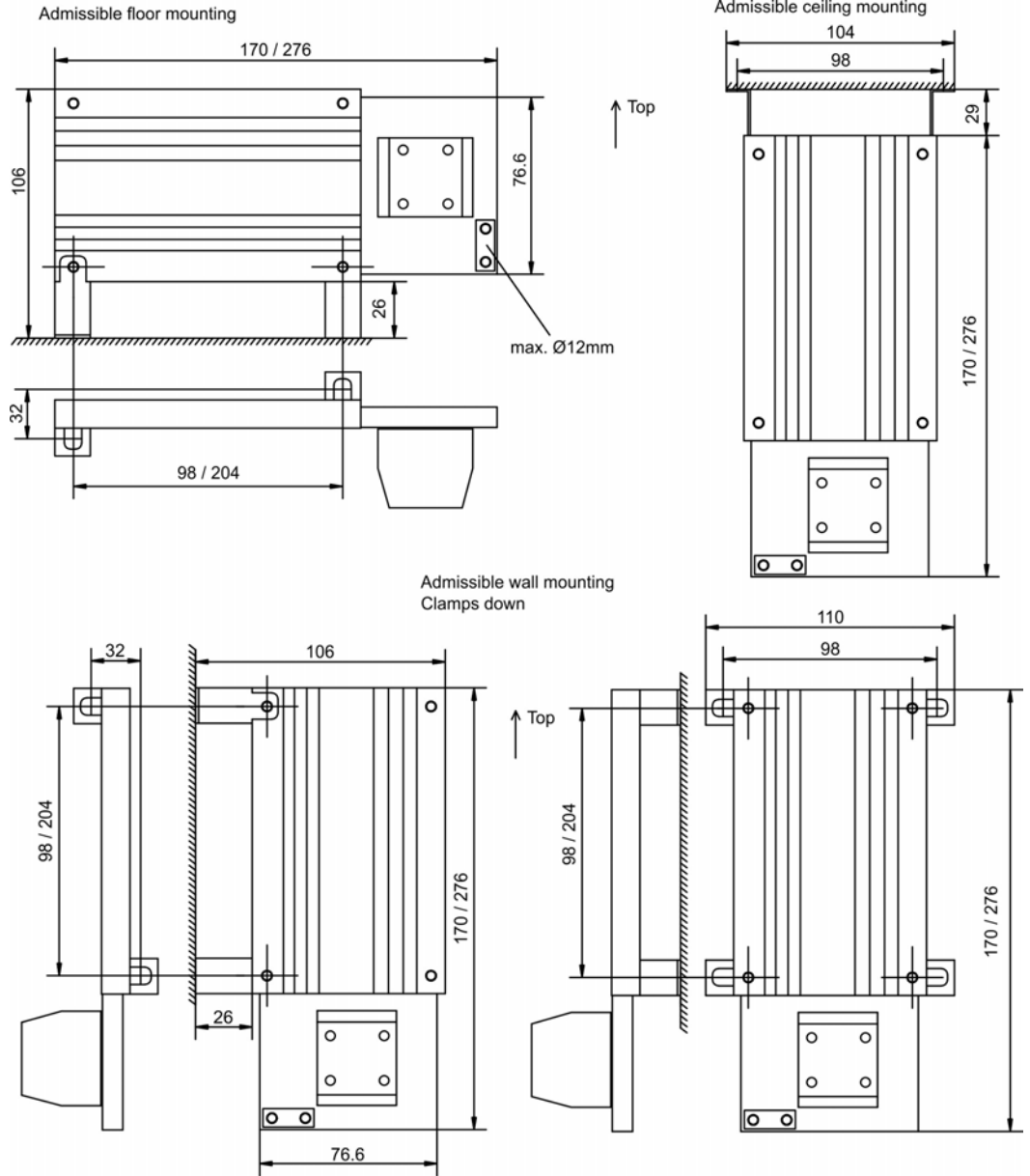

Typ	R	Length	Power	Weight
	Ω	mm	W	Kg
BAFP(U) 100-33	33	170	100	0,3
BAFP(U) 200-33	33	276	200	0,55

Other types of mounting are not admitted !

8.5 External brake resistor BAR(U)



Protection class: IP20



WARNING

The surface temperature can exceed 250°C.
Risk of burns and fire! Measure the temperature before touching.

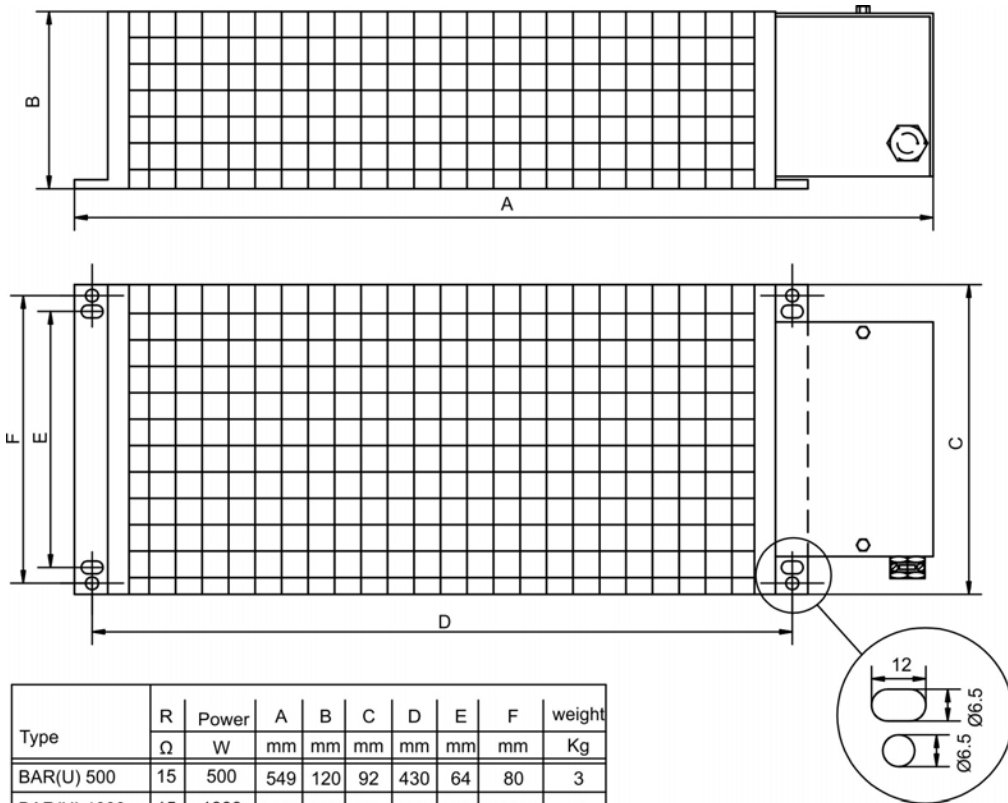

Type	R	Power	A	B	C	D	E	F	weight
	Ω	W	mm	mm	mm	mm	mm	mm	
BAR(U) 500	15	500	549	120	92	430	64	80	3
BAR(U) 1000	15	1000	749	120	92	630	64	80	4
BAR(U) 600	23	600	549	120	92	430	64	80	3
BAR(U) 1000	23	1000	749	120	92	630	64	80	4
BAR(U) 250	33	250	349	120	92	230	64	80	2
BAR(U) 500	33	500	549	120	92	430	64	80	3
BAR(U) 1500	33	1500	649	120	185	530	-	150	5,8
BAR(U) 300	66	300	349	120	92	226	64	80	1,5
BAR(U) 600	66	600	549	120	92	426	64	80	2,3
BAR(U) 1000	66	1000	749	120	92	626	64	80	3,4
BAR(U) 300	91	300	349	120	92	226	64	80	1,5
BAR(U) 600	91	600	549	120	92	426	64	80	2,3
BAR(U) 1000	91	1000	749	120	92	626	64	80	3,4

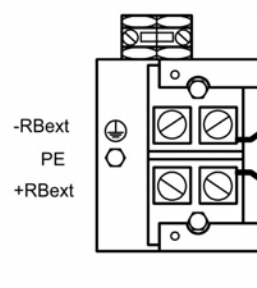

±10%, temperature drift approx. 1%
Cold approx. +8%, 320°C approx. -7%

Admissible floor mounting

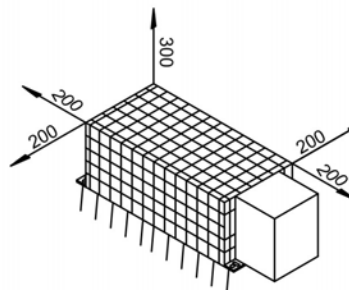

Admissible wall mounting
Clamps down

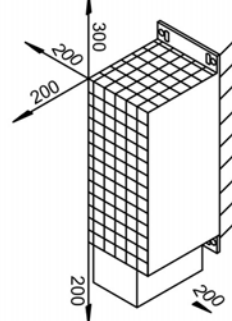

Other types of mounting are not admitted !

8.6 External brake resistor BAS(U)



Protection class: IP20



The surface temperature can exceed 250°C.
Risk of burns and fire! Measure the temperature before touching.

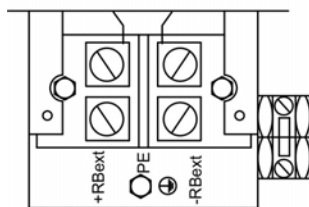
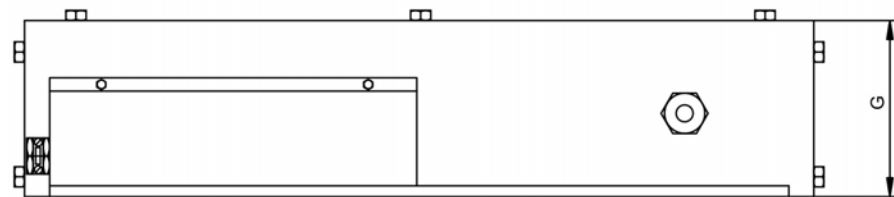
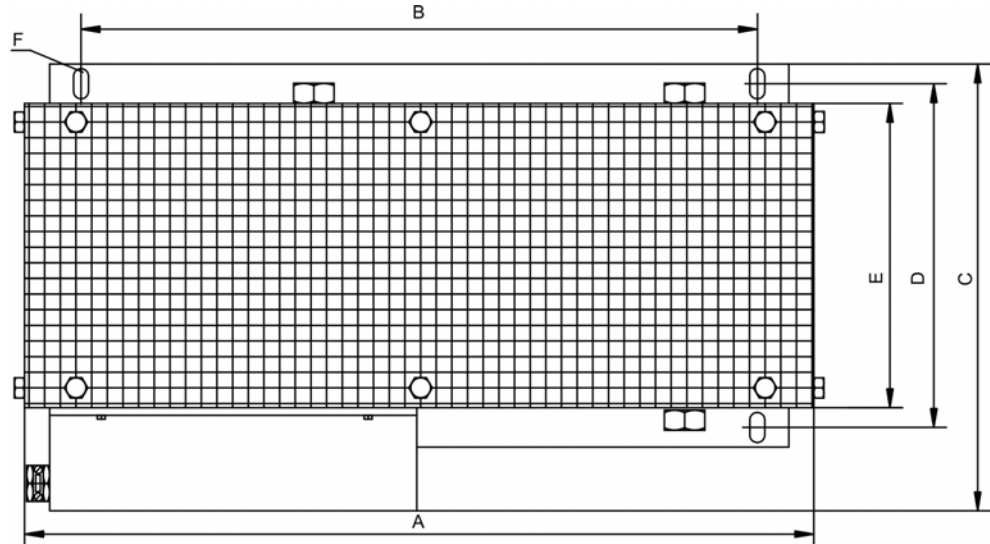

±10%, temperature drift approx. 1%
Cold approx. +8%, 320°C approx. -7%

Admissible floor mounting

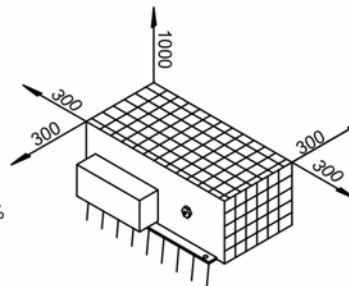

Admissible wall mounting
Clamps down

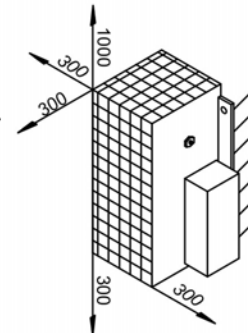

Other types of mounting are not admitted !

	R	Rated power	A	B	C	D	E	F	G	weight
	Ω	W	mm	mm	mm	mm	mm	mm	mm	Kg
BAS(U)2000-10	10	2000	490	380	255	170	150	Ø10,5	260	7
BAS(U)3000-10	10	3000	490	380	355	270	250	Ø10,5	260	8
BAS(U)6000-10	10	6000	490	380	455	370	350	Ø10,5	260	11
BAS(U)2000-15	15	2000	490	380	255	170	150	Ø10,5	260	7
BAS(U)3000-15	15	3000	490	380	355	270	250	Ø10,5	260	8
BAS(U)6000-15	15	6000	490	380	455	370	350	Ø10,5	260	11
BAS(U)2000-23	23	2000	490	380	255	170	150	Ø10,5	260	7
BAS(U)3000-23	23	3000	490	380	355	270	250	Ø10,5	260	8
BAS(U)4000-23	23	4000	490	380	355	270	250	Ø10,5	260	9
BAS(U)3000-33	33	3000	490	380	355	270	250	Ø10,5	260	8

9 Capacitor Modules

9.1 General

KCM modules (**K**OLL**M**OR**G**EN **C**apacitor **M**odules) absorb energy generated by the motor when it is operating in generator mode. Normally, this energy is dissipated as waste via brake resistors. KCM modules, however, feed the energy they have stored back into the DC Bus link as and when it is required.

KCM-S	Saves energy: The energy stored in the capacitor module during generative braking is available the next time acceleration happens. The module's inception voltage is calculated automatically during the first load cycles.
KCM-P	Power in spite of power failure: If the power supply fails, the module provides the servo amplifier with the stored energy that is required to bring the drive to a standstill in a controlled manner (this only applies to the power supply voltage; battery-back the 24 V supply separately).
KCM-E	Expansion module for both applications. Expansion modules are available in two capacitance classes.

More information can be found on the WIKI page "[KCM Capacitor Module](#)".

9.2 Important notes



DANGER

DC Bus link terminals in servo systems carry high DC voltage of up to 900 V. Touching the terminals while they are carrying voltage is extremely dangerous. Switch off (disconnect) the line voltage. You must only work on the connections when the system is disconnected.

It can take over an hour for the modules to self-discharge. Check the state of charge with a measuring device that is suitable for a DC voltage of up to 1,000 V. When measuring a voltage of over 60 V between the DC+/DC- terminals or to ground, discharge the modules as described in the KCM Instructions Manual.

NOTICE

You must read the instructions manual for the servo amplifier/servomotor you are using in your application and observe the safety instructions they contain before commencing mounting/installation work.

Wiring diagram and more important notes concerning wiring can be found in the KCM instructions manual and in the instructions manual of the used servo amplifier.

9.3 Type assignment and order codes

Servo amplifier	KCM Module	Servo amplifier	KCM Module
S300	all Modules	S640, S670	not allowed
S400	all Modules	S748, S772	not allowed
S601 to S620	all Modules	AKD-x00306...02406*	not allowed
S701 to S724	all Modules	AKD-x04807	not allowed
AKD-x00307...02407*	all Modules	AKD-C01007	all Modules

*= x means variants -B, -P, -T and -M

Order codes

Type/Order Code	Remarks
KCM-S200-0000	Energy Saving Module, 1.6 kW
KCM-P200-0000	Power Module, 2 kW
KCM-E200-0000	Expansion Module 2 kW
KCM-E400-0000	Expansion Module 4 kW

9.4 Example installation with AKD-P, KCM-P and KCM-E

NOTICE

Maximum cable length between AKD and KCM: 500 mm. The DC+ and DC- lines should always be twisted, maximum cross section is 6 mm².

RS422 interface X4 allows data exchange controlled by a terminal software of your choice. Interface setting: 115200 Baud, 8 Data Bits, 1 Stop Bit, No Parity&Flow Control. The X4 mating connector is in the package. The ready signal reports the ready to operate (high level).

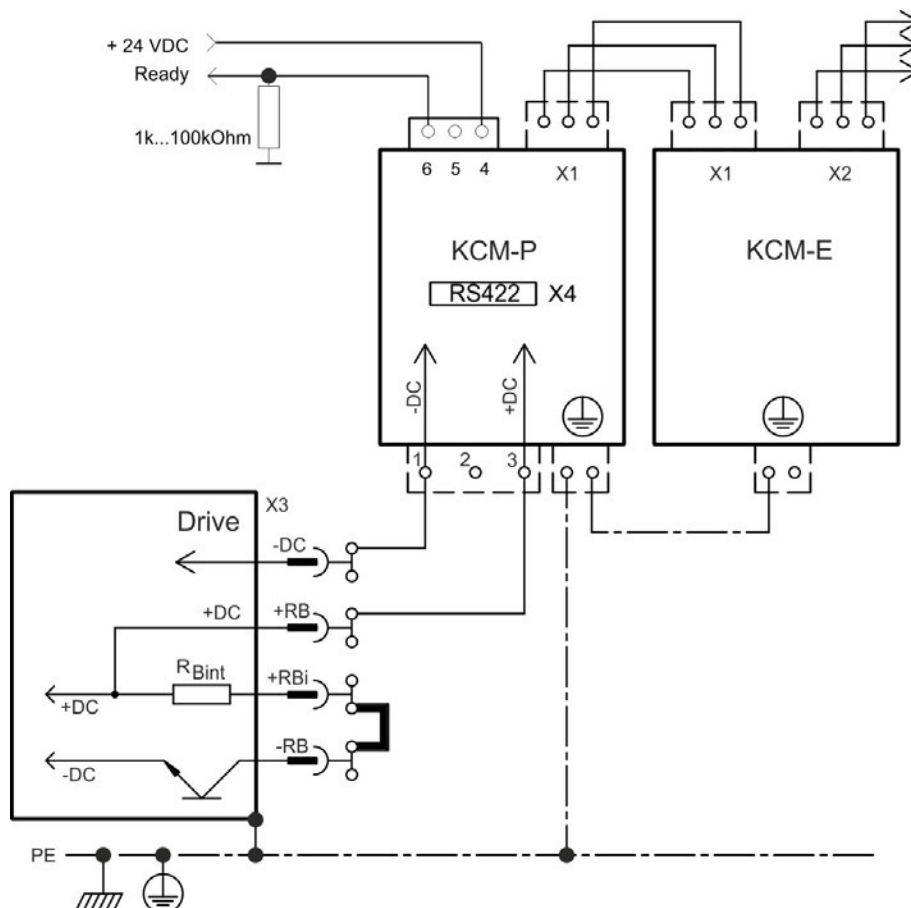

More information is given in the KCM Instructions Manual.

9.5 KCM Module



Observe the safety instructions → p. 38 and in the instruction manual of the servo amplifier.

Permissible assembly type: Vertical, ground connections at the bottom.
Other assembly positions are not permitted. Observe the required free space to next device. Ensure there is unobstructed convection for cooling purposes.

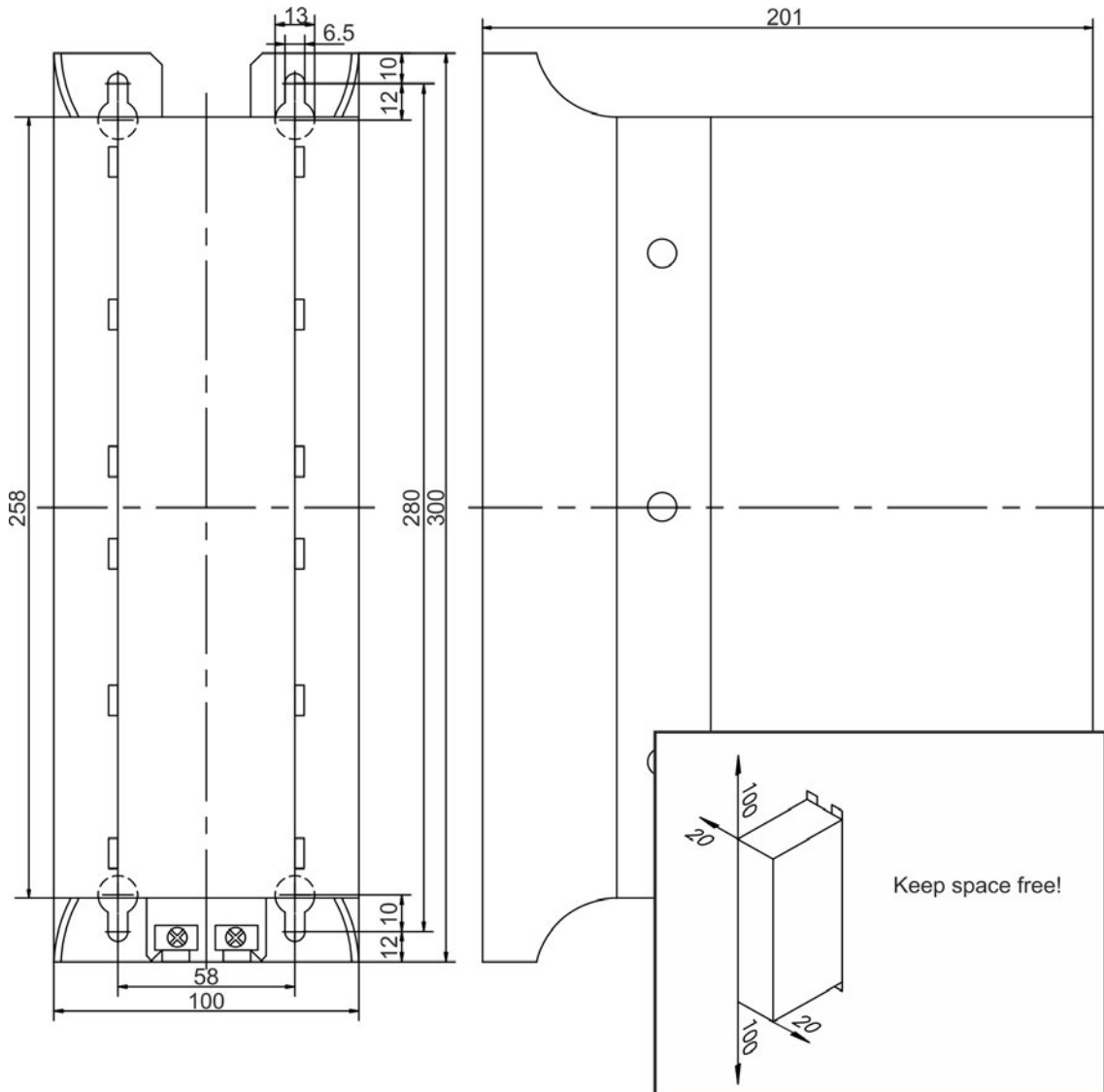

Technical Data

Type	Storage Capacity [Ws]	Rated supply voltage [V=]	Peak supply voltage [V=]	Power [kW]	Protection Class	Inception voltage [V=]	Weight [kg]
KCM-S200	1600	max 850 VDC	max 950VDC (30s in 6min)	18	IP20	calculated	6.9
KCM-P200	2000					470 VDC	6.9
KCM-E200	2000					-	4.1
KCM-E400	4000					-	6.2

10 Motor chokes

10.1 General

Shielded motor cables

For reasons of electromagnetic compatibility, the motor must be supplied with power via a shielded cable. The structure of a cable with 100% shielding and the capacity equivalent circuit diagram (to earth) are shown below.

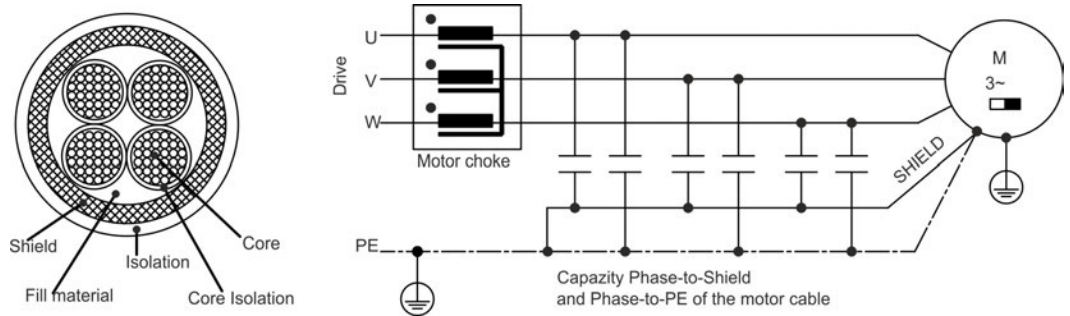

Why use motor chokes?

- To compensate high capacitive charge/discharge currents typical of shielded motor cables approximately 25 m and longer.
- To reduce current alternation noise in the motor.
- To reduce current ripple in the motor.

The digital servo amplifiers' high switching frequencies and steep switching edges give rise to the transfer of capacitive currents to the shield by the three phases (U, V, W). These currents flow from the shield to earth. Depending on the cable length and cable capacity (determined by design), this can lead to the generation of shield currents with peak values of up to 20 A.

These shield currents place a load on the servo amplifiers and motor and, on large systems, lead to shifts in potential which can damage other components.

This effect is evident in particular on systems with multiple amplifiers operating in parallel on the same mains filter.

The motor chokes slow down the rate of rise of the motor current (reduce edge steepness), thereby reducing the current transferred to the shield.

Why is the cross-section of the motor cable important?

Motor cables longer than 50 m with a small cross-section (e.g. 4 x 1.0 mm²) and therefore a higher equivalent resistance are able to reduce the oscillation tendency of the LCR oscillating circuit (amplifier/choke/cable/motor). This cross-section can also be advantageous for cable lengths shorter than 50 m if the cable capacity and motor inductance are very high. However, the current loading of the cable must always be within the limits specified by EN 60204.

10.2 Important notes



CAUTION

The choke can become hot during operation (rising to temperatures in excess of 80° C). Risk of light burns and fire! Therefore, you should make sure that the choke is mounted a sufficient distance away from neighbored components. Provide the requisite conditions for unobstructed convection to cool the choke.

NOTICE

You must read the instructions manual for the servo amplifier/servo motor you are using in your application and observe the safety instructions they contain before commencing mounting/installation work. This manual is only valid in conjunction with the instructions manual for the servo amplifier and servo motor you are using in your application.

Mount the motor choke 3YLN on a conductive earthed assembly plate in the switchgear cabinet. The choke box 3YL-24 can be mounted to DIN rails as well.

The motor choke is wired into the cable close to the amplifier. When laying the motor cable, allow about 400 mm for the connection to the choke.

Connection diagram see the servo amplifier instructions manual.

10.3 Type assignment and order codes

Servo amplifier	Motor choke	Condition
S300	3YL-24, 3YLN-xx	Motor cable ≥ 25m
S400	3YL-24, 3YLN-xx	Motor cable ≥ 25m
S601...620	3YL-24, 3YLN-xx	Motor cable ≥ 25m
S640/670	not required	
S701...724	3YL-24, 3YLN-xx	Motor cable ≥ 25m
S748/772	usually not required, in case of cable length ≥ 25m and unusual conditions, ask our customer support	
AKD-x003 to AKD-x006*	3YLN-06	Motor cable ≥ 25m
AKD-x012*	3YLN-14	Motor cable ≥ 25m
AKD-x024*	3YLN-24	Motor cable ≥ 25m

*= x means variants -B, -P, -T and -M

Order codes

Article	Nominal Current	Approvals	Order code
Motor choke box 3YL-24	24 A	CE	DE-90074
Motor choke 3YLN-06	6 A	CE, UL	DE-107929
Motor choke 3YLN-10	10 A	CE, UL	DE-107930
Motor choke 3YLN-14	14 A	CE, UL	DE-107931
Motor choke 3YLN-20	20 A	CE, UL	DE-107932
Motor choke 3YLN-24	24 A	CE, UL	DE-201447

10.4 Motor choke 3YL-24

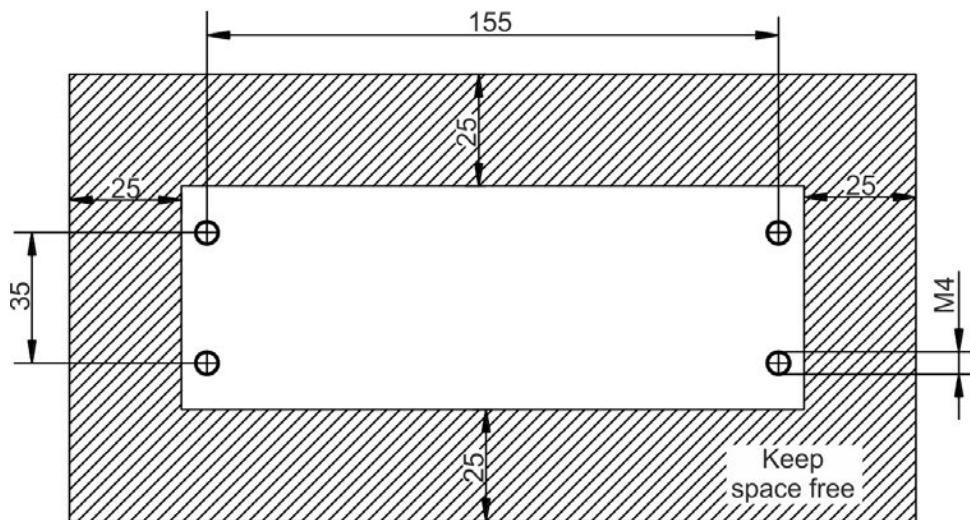
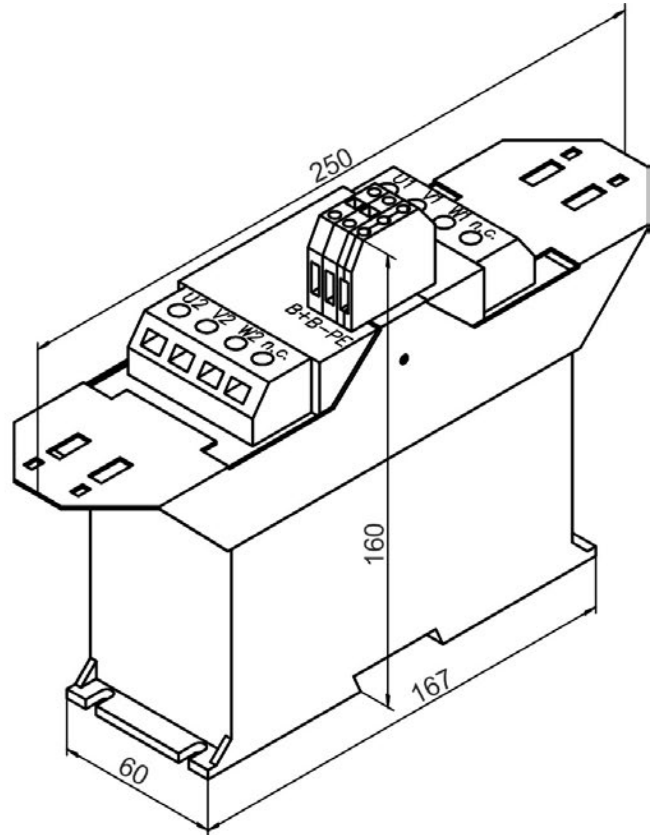

Technical data:

Rated data	Sym	Unit	3 YL-24
Rated Current	I _{0rms}	A	Max.3x 24
Frequency	f _{max}	kHz	8.3
Inductivity	L	μH	120
Resistance	R	mOhm	2.6
Weight	G	kg	1.4
Cable diameter (Shield clamp)	-	mm	4 to 13.5
Wire cross section U-V-W max. (terminals)	-	mm ²	4
Wire cross section BR+/- max. (terminals)	-	mm ²	2.5

10.5 Motor choke 3YLN-xx

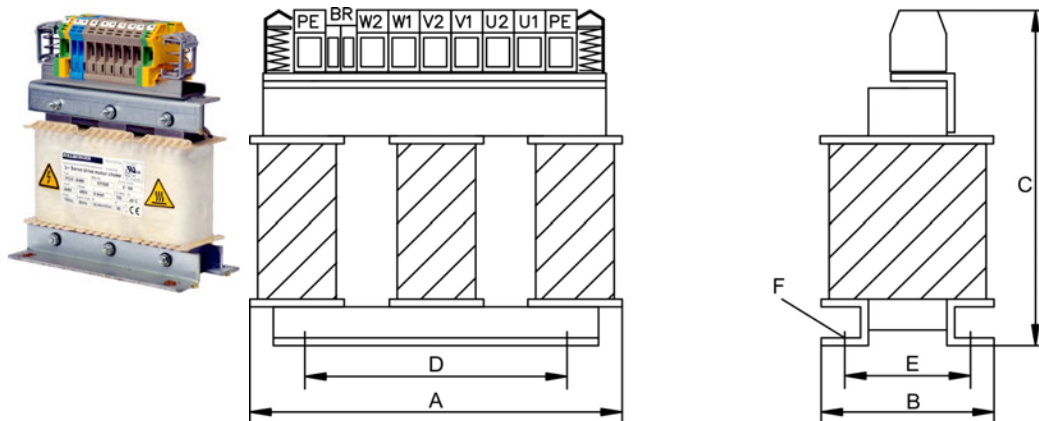

Technical Data:

Rated Data	Sym	DIM	3YLN-06	3YLN-10	3YLN-14	3YLN-20	3YLN-24
Rated current	I _{0rms}	A	6	10	14	20	24
Rated voltage	U _{nom}	V	480				
Rated frequency	f _{nom}	Hz	0 to 150				
Max. frequency	f _{max}	kHz	8				
Inductivity	L	μH	900	900	900	450	450
Power loss	P	W	12	14.5	19.4	22.3	23.2
Protection class	-	-	IP00				
Temperature class	-	-	F				
Operation class	-	-	S1				
Weight	G	kg	4.5	5.5	10	10	10
Cable diameter (Shield clamp)	-	mm	4 to 13.5				
Wiring cross section max. (Terminals)	-	mm ²	10	10	16	16	16
Width	A	mm	155	155	190	190	190
Depth	B	mm	90	105	125	125	125
Height	C	mm	195	195	230	230	230
Mounting hole distance	D	mm	130	130	170	170	170
Mounting hole distance	E	mm	56.5	71.5	78	78	78
Mounting screws	F	-	4xM6	4xM6	4xM6	4xM6	4xM6

11 Cables

NOTICE

Kollmorgen assumes no liability for errors or damage to equipment caused by cables manufactured by customers.

11.1 Technical data for cables

Information on the chemical, mechanical and electrical characteristics of the cables can be found in our [Technical WIKI \(Cables\)](#).

Insulation material

Sheathing: PUR (polyurethane, code 11Y)

Core insulation: PETP (polyesteraphthalate, code 12Y)

Capacitance (phase to shield)

Motor cable: less than 180 pF/m (cross sections >6mm² have larger capacitance)

Feedback cable: less than 120 pF/m

Hybrid Cable: special requirements

Technical data

- The brackets in the core definition indicate the shielding
- All cables are suitable for use as trailing cables
- The technical data refer to use as moveable cables
- Operating life : 10 million bending cycles
- All cables are UL recognized

11.2 Tools

Only work with the special tools that are required for the used connectors. You can obtain these special tools from the manufacturer of the connectors or contacts.

11.3 PC connection

11.3.1 AKD

The AKD is connected by a standards net cable with RJ45 connectors to the PC or to a Switch/Hub.

Article	Order Code
Ethernet Cable PC-AKD	→ p. 59

11.3.2 S300, S400, S600, S700

Kollmorgen digital "Sx" type servo amplifiers are equipped with a serial RS232 interface to facilitate communication with a standard personal computer (PC). Various types of interface can be used on the PC. Appropriate cables and in some cases specific accessories will be required to establish the connection between servo amplifier and PC.

Article	Order Code
Cable PC-S300/S400/S600/S700 3m, 9poles	DE-90067
Setup Kit S300/S400/S600/S700 USB	DE-107666
Y-Adapter for splitting CAN/RS232 and Multilink	→ p. 47

Setup Kit S300, S400, S600, S700 USB



An interface converter is required to use the USB interface on a PC. Our "USB" setup kits contain a USB serial converter and a serial PC cable suitable for the amplifier type.

PC cable for S300, S400, S600, S700



For the purpose of parameterisation and for firmware upgrades, the servo amplifiers can be connected to the serial RS232 interface on a PC. The connecting cable must be shielded. The braided shield on the RS232 connecting cable is conductively connected to the front panel of the servo amplifier via the connector housing on the Sub-D male connector.

Y Adapter (Splitter) for S300/S600/S700

The signals for the serial link to the PC and the CAN interface are routed via the same connector on the servo amplifier (X6). Our Y adapters can be used for simultaneous access to both interfaces. In this case, the interface signals are routed via separate connectors.

Article	Order Code
Y-Programming-Adapter 1 Axis	DE-108211
Y-Adapter -SR6Y- 4 Axes (Multilink Cable)	DE-90060
Y-Adapter -SR6Y6- 6 Axes (Multilink Cable)	DE-92042

The multi-axis Y adapters support the simultaneous setup (multi-link) of a number of S300/S600/S700 in a single setup session.

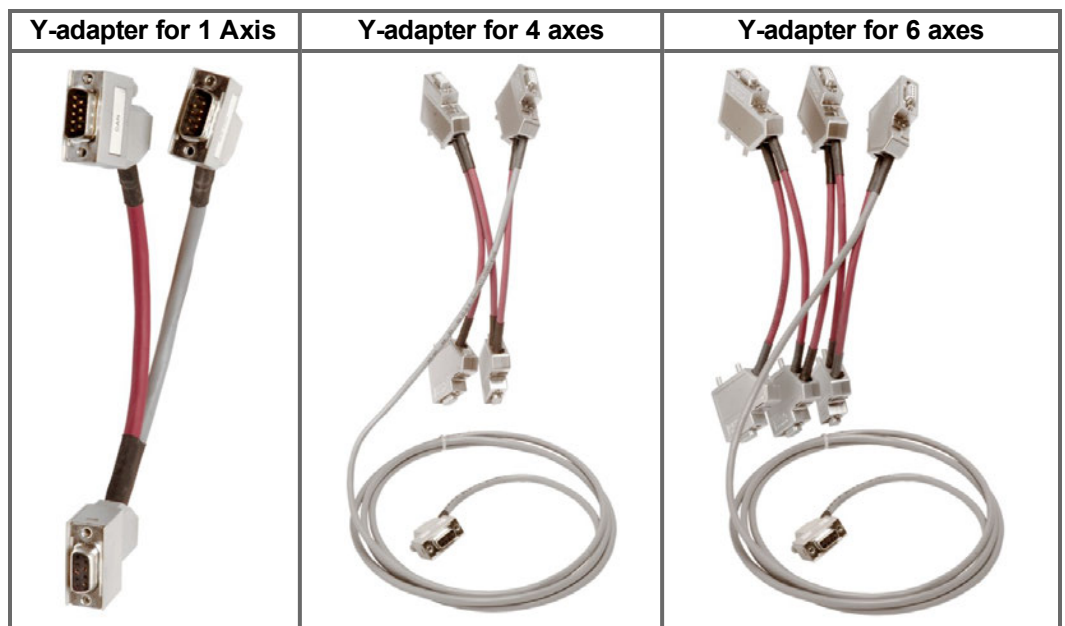

11.4 Power Voltage Supply, external brake resistor, DC bus link

The connectors used (40 A and higher fixed terminals) are included in the scope of supply of the servo amplifier. If necessary, the connectors are coded and printed with the corresponding terminal designation. The table indicates the type of cable required for each intended purpose.

NOTE We do not deliver configured cables for this interface.

NOTICE You must always observe the specifications in respect of cable cross-sections contained in the instructions manual for the servo amplifier you are using in your application. Fit suitable wire end ferrules or plug connectors to stripped conductors. A connection diagram appears in the servo amplifier instructions manual.

11.4.1 Mating connector (part of delivery)

Amplifier	Mains supply 1		Mains supply 2		DC-link bus		Brake resistor	
	#	Order Code	#	Order Code	#	Order Code	#	Order Code
S300-230V	X0	DE-105856	-	-	X8	DE-107556	X8	DE-107556
S300-400V	X0	DE-107557	-	-	X8	DE-107558	X8	DE-107558
S400	X0	DE-102583	-	-	X0	DE-102583	X0	DE-102583
S601...620	X0A	DE-92258	X0B	DE-92259	X7	DE-90064	X8	DE-90065
S701...724	X0	DE-200451	-	-	X8	DE-200452	X8	DE-200452
AKD-x00306/00606*	X3	CON-AKDX3A-SL	-	-	X3	CON-AKDX3A-SL	X3	CON-AKDX3A-SL
AKD-x01206*	X3	CON-AKDX3B-SL	-	-	X3	CON-AKDX3B-SL	X3	CON-AKDX3B-SL
AKD-x02406/0xx07*	X4	CON-AKDX4-SL	-	-	X3	CON-AKDX3C-SL	X3	CON-AKDX3C-SL
AKD-C01007	X12	Connector Kit → p. 23	-	-	X14	Connector Kit → p. 23	X14	Connector Kit → p. 23

*= x means variants -B, -P, -T and -M

11.4.2 Mating connector (optional)

Amplifier	Mains supply		DC-link bus / Brake resistor	
	#	Order Code	#	Order Code
S701...724	X0Y	DE-200851	X8Y&X4Amini	DE-201942
S701...724	X0F	DE-200955	X8F	DE-200956
AKD-x02406/0xx07			X3Y	CON-AKDX3C-SL-Y

With Y-connectors you can daisy-chain supply voltage or DC-bus link to several amplifiers. For details see instructions manual of the servo amplifier. The F-connectors are for fast wiring (no screws).

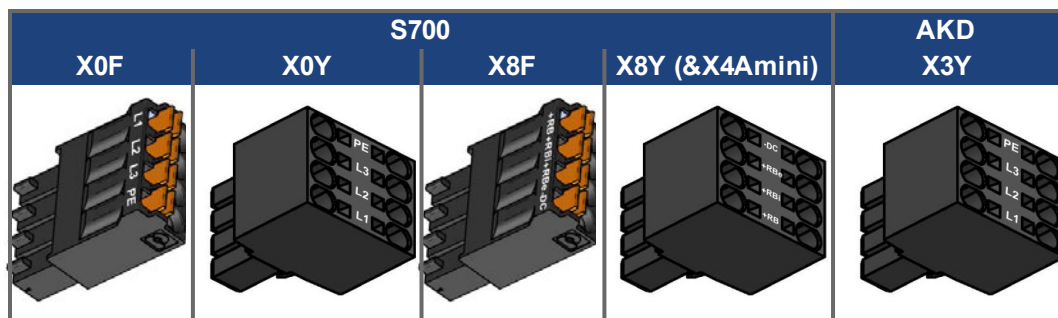

11.4.3 Recommended cable type

Purpose	max. length	recommended cable @ amplifier rated output current		
		In=1.5...10A	In=14...24A	In=40...70A
AC-supply*	-	H07V-K 1.5	H07V-K 4	H07VVC4-K 3G 25
DC-bus link*	0.5 m	H07V-K 1.5	H07V-K 4	H07V-K 25
	2m	H07VVC4-K 2X 1.5	H07VVC4-K 2X 4	H07VVC4-K 2X 25
Ext. brake resistor*	5m	H07VVC4-K 2G 1.5		H07VVC4-K 2G 25

* valid only for single-axis systems. For multi-axis systems, please consult our customer support.

11.4.4 Preparing cables for AKD/S300/S400/S601...620/S700

The connections are located on the bottom or front of the servo amplifier. Terminal connectors are used, which are included in the delivery package for the servo amplifier. The connectors are coded and have the appropriate connection designation printed on them. **They must never be mixed up.**

Follow the pin assignment in the instructions manual. When connecting an external brake resistor, please note that the link cable must first be removed.

Preparing unshielded cables

If shielding is not necessary, then we recommend using single cores for the wiring inside the switchgear cabinet.

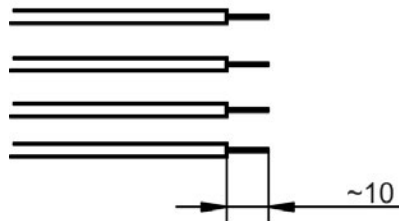
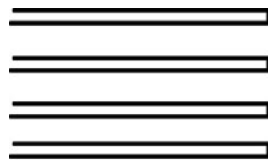

Strip off about 10 mm of the insulation at the ends of the cores. Take care to avoid damage to the copper strands while doing this. Depending on the cross-section of the core and the type of bootlace ferrule that is used, the length that has to be stripped may vary by several millimeters.

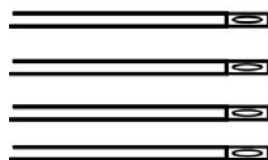

Apply bootlace ferrules to the conductors. As an alternative, you can also use terminal pins.

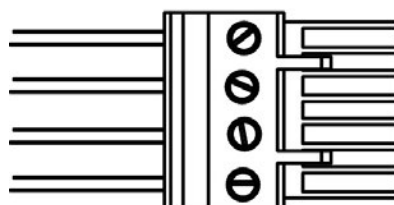

Connector example S600:

Push the ends of the conductors into the connector as far as they will go. Follow the pin assignment in the servo amplifier's instructions manual. Tighten the screws of the terminals. Take care that the insulation is not trapped in the terminals.

Preparing shielded cables

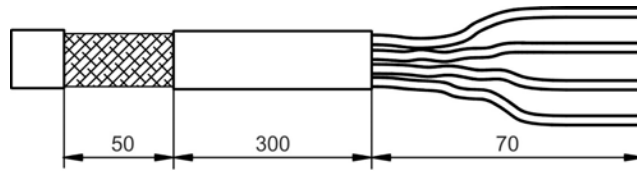

First, remove the outer covering of the cable and the shielding braid over a length of about 70 mm. Then remove just the outer covering for about another 50 mm, without damaging the shielding braid.

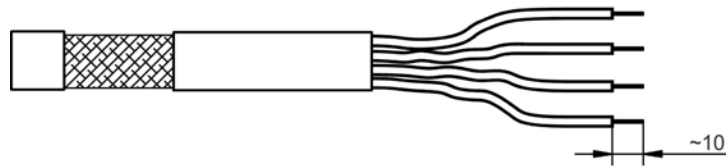

Strip off about 10 mm of the insulation from the ends of the cores. Take care to avoid damage to the copper strands while doing this. Depending on the cross-section of the core and the type of bootlace ferrule that is used, the length that has to be stripped may vary by several millimeters.

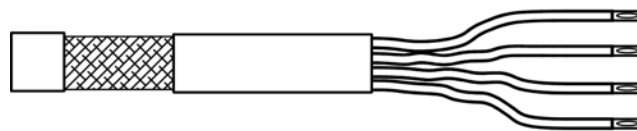

Apply bootlace ferrules to the conductors. As an alternative, you can also use terminal pins instead of bootlace ferrules.

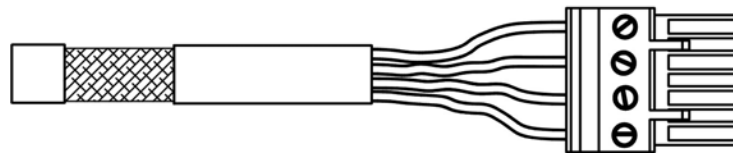

Connector example S600: Push the ends of the conductors into the connector as far as they will go. Follow the pin assignment in the instructions manual. Tighten the screws of the terminals. Take care that the insulation is not trapped in the terminals.

11.4.5 Preparing cables for S640/670 and S748/772

The connections for the power supply, the ballast resistor and the DC-link are made through terminals on the bottom of the servo amplifier. These terminals can accept core cross-sections from 10 to 50 mm².

The AC supply connection is used as an example for preparing a cable.

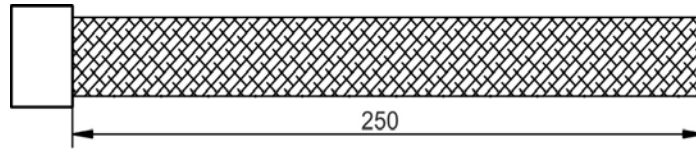

Remove the outer covering of the cable over a length of about 250 mm, without damaging the shielding braid.

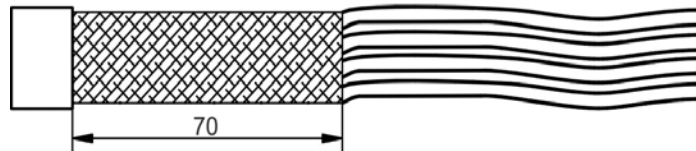

Shorten the shielding to a length of about 70 mm.

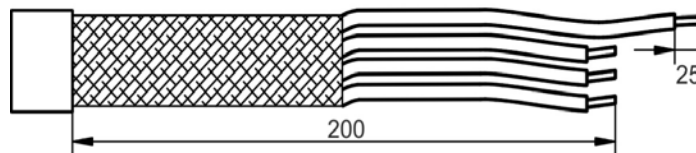

Shorten the three cores for the supply phases to 200 mm. Strip off all cores for a length of about 25 mm. This length depends on the core cross-section and the bootlace ferrules that are used.

Apply bootlace ferrules to the conductors.

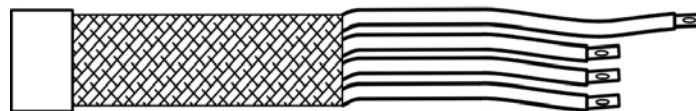

Connect up the cable according to the wiring diagram in the instructions manual for the servo amplifier and take care that no insulation is trapped in the terminals.

11.5 24V auxiliary voltage supply

Connectors are used, that are included in the delivery package of the servo amplifiers. If necessary, the connectors are coded and printed with the corresponding terminal designation.

NOTE

We do not deliver configured cables for this interface.

NOTICE

You must always observe the specifications in respect of cable cross-sections contained in the instructions manual for the servo amplifier you are using in your application. Fit suitable wire end ferrules or plug connectors to stripped conductors. A connection diagram appears in the servo amplifier instructions manual.

11.5.1 Mating connector (part of delivery)

Amplifier	Connector	Order Code
S300	X4	DE-107555
S400	X0	DE-102583
S601...620	X4	DE-90062
S640/670	X4	DE-92143
S701...724	X4A	DE-200449
S701...724	X4B	DE-200450
S748/772	X4	DE-201241
S748/772	X9B	DE-201193
AKD-B/P/T/M	X1	CON-AKDX1-SL
AKD-C	X13	Connector Kit → p. 23

11.5.2 Recommended cable type

Purpose	recommended cable
24V Aux. Voltage	H07V-K 1.5 or H07V-K 2.5
Observe voltage drop!	

11.5.3 Preparing cables

The connection is on the front panel of the servo amplifier. A Combicon connector is used, which is included in the delivery package of the servo amplifiers.

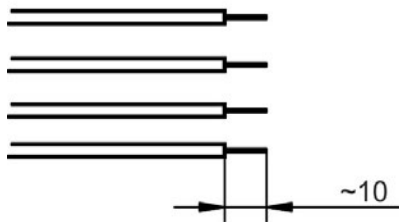
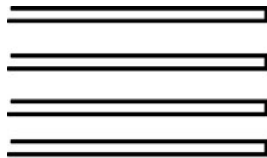

Strip off about 10 mm of the insulation at the ends of the cores. Take care to avoid damage to the copper strands while doing this. Depending on the cross-section of the core and the type of bootlace ferrule that is used, the length that has to be stripped may vary by several millimeters.

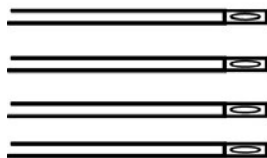

Apply bootlace ferrules to the conductors. As an alternative, you can also use terminal pins.

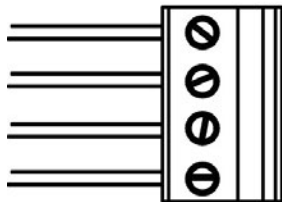

Connector example S601...620:

Push the ends of the conductors into the connector as far as they will go. Follow the pin assignment in the instructions manual. Tighten the screws of the terminals. Take care that the insulation is not trapped in the terminals.

11.6 Digital/analog Inputs/Outputs

11.6.1 Digital In/Outputs for AKD-C

The digital control signals are connected to X15 and X16 with single lines.

NOTE

We do not deliver configured cables for this interface.

Mating connector (part of delivery)

Amplifier	Digital Signals		STO Signals	
	#	Order Code	#	Order Code
AKD-C	X15	Connector Kit → p. 23	X16	Connector Kit → p. 23

Recommended cable type

Purpose	max. length	Recommended cable
Digital I/O, STO	30m	H07VK 0.5

11.6.2 Digital In/Outputs for AKD-N



All AKD-N servo amplifiers have one 8 poles M12 connector to connect digital control signals.
Maximum cable length 5m.



AKD-N-DS servo amplifiers (devices with local STO input) have an additional 4 poles M12 connectors to connect the local STO signals.
Maximum cable length 5m.

Kollmorgen recommends pre-configured Phoenix SAC cables.

Order codes for I/O cables, one end configured

Amplifier	Order Code	No. of wires	Description
AKD-N all types	SAC-8P-M12MS	8 poles	5m, M12 mating connector, unconfigured wires
AKD-N-DS	SAC-4P-M12MS	4 poles	5m, M12 mating connector, unconfigured wires

Other length can be ordered from Phoenix Contact Deutschland GmbH.

11.6.3 Digital/analog I/O for S300/S400/S600/S700 and AKD-B/P/T/M

The cables for analog signals must be twisted pairs, and shielded. The digital signals can be connected by single wires.

NOTE

We do not deliver configured cables for this interface.

Mating connector (part of delivery)

Amplifier	Digital / analog signals				STO Signals	
	#	Order Code	#	Order Code	#	Order Code
S300	X3	DE-107554	-	-	X4	DE-107555
S400	X3	DE-102585	X1	DE-102584	-	-
S601...620	X3	DE-90061	-	-	X10	DE-101696
S640/670	X3	DE-101695	-	-	X10	DE-101696
S701...724	X3A	DE-200447	X3B	DE-200448	X4B	DE-200450
S748/772	X3A	DE-200447	X3B	DE-200448	X4	DE-201241
AKD-B/P/T	X7	CON-AKDX7-SL	X8	CON-AKDX8-SL	X1	CON-AKDX1-SL
AKD-T-IC	X7	CON-AKDX7-SL	X8	CON-AKDX8-SL	X1	CON-AKDX1-SL
	X21	CON-AKDX21-SL	X22	CON-AKDX22-SL	-	-
	X23	CON-AKDX23-SL	X24	CON-AKDX24-SL	-	-
AKD-M	X7	CON-AKDX7-SL	X8	CON-AKDX8-SL	X1	CON-AKDX1-SL
	X35	CON-AKDX35-SL	X36	CON-AKDX36-SL	-	-

Recommended cable type

Purpose	max. length	recommended cable
Digital I/O	10m	H07VK 0,5
BTB	10m	
Digital GND	10m	
Analog Setpoint	25m	LiYCY (TP) 4x2x0.25
Analog GND	25m	

Color code for shielded cable

Signal	Color*	Cable
AGND	GY	LiYCY (TP) 4x2x0.25
analog in 1+	WH	
analog in 1-	BN	
analog in 2+	GN	
analog in 2-	YE	
analog out 1	PK	
analog out 2	BU	
AGND	RD	

* according to IEC 60757

11.6.4 Preparing cables

For simplicity, the instructions for preparation only show the section with the cores that have to be shielded and twisted pairs.

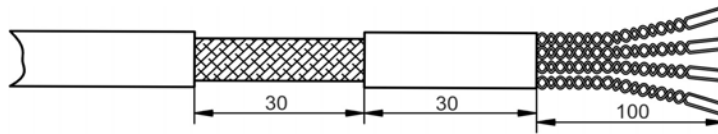

Remove the outer covering and the shielding braid over a length of about 100 mm. Remove another section of the outer covering, about 30 mm long, without damaging the shielding braid.

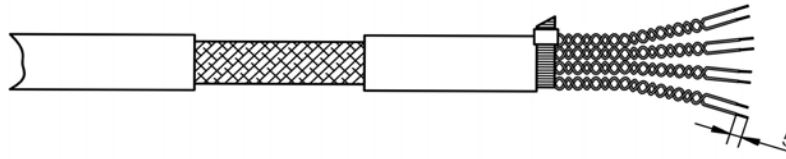

Secure the cores where they emerge, with a cable tie. Strip off the insulation from the cores for a length of about 5 mm, without damaging the copper strands. This length can vary, according to the type of bootlace ferrule that is used.

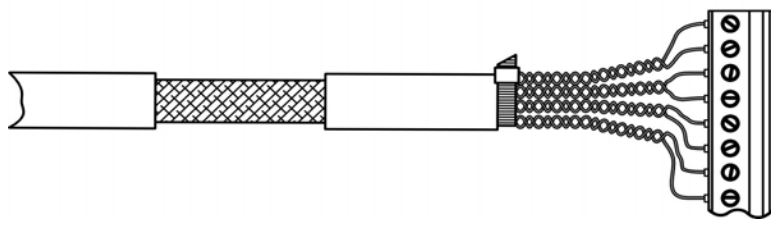
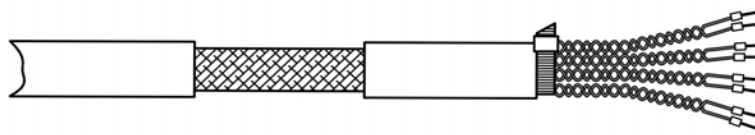

Fit appropriate bootlace ferrules or terminal pins to the bared ends of the cores.

Wire up the screw terminals of the connector according to the wiring diagram (see also the instructions manual for the servo amplifier). Tighten the screws and take care that the insulation is not trapped in the terminals.

11.7 Encoder Emulation, Stepper motor control, Master-Slave

This interface can be used for several applications (see the amplifiers instructions manual). The material requirements are always the same.

NOTE

We do not deliver configured cables for this interface.

11.7.1 Mating connector, cable type

Article	Description	Order Code
Cable	4x2x0.25 (per meter)	DE-92186
Sub-D connector kit	Socket 9-pole, housing and screws	DE-81784
Connector kit, amplifier end AKD-B/P/T/M, X9/X10	X10 male connector 15 pin high density, X9 female connector 9 pin, 2 housings, screws	AKD-X9+X10-Kit

11.7.2 Connection

The cable used must be shielded, with twisted pairs to (suggestion according to DIN 47100). Since it is important which signal pairs are twisted together, the following table shows the colors of the individual cores (to IEC 60757).

SubD9 S300...S700	SubD9, X9 AKD-B/P/T/M	ROD	Core color @ 5x2x0.25 SSI, Stepper motor control, Master-Slave
1	3	WH	WH
2	7	GN	n.c.
3	8	YE	n.c.
4	1	GY	GN
5	2	PK	YE
6	4	BU	GY
7	5	RD	PK
8 n.c.	6	BK	BK
9 n.c.	9	BN	n.c.

The connector assignment is determined by the use of the interface; see the servo amplifier instructions manual.

11.7.3 Termination resistors

Depending on servo amplifier type (see instructions manual for the servo amplifier) and application, the cable must be terminated by termination resistors at the amplifier end or the control end. The resistance values depend on the characteristic impedance of the cable material.

Pin	Interface function (S300/S400/S600/S700)							
	ROD		SSI		Stepper control		Master-Slave	
	Amplifier	Controller	Amplifier	Controller	Amplifier	Controller	Master	Slave
1	-	-	-	-	-	-	-	-
2	-	R ~ 150Ω	-	-	-	-	-	-
3	-		-	-	-	-	-	-
4	-	R ~ 150Ω	R ~ 150Ω	-	R ~ 150Ω	-	-	R ~ 150Ω
5	-			-		-	-	
6	-	R ~ 150Ω	-	R ~ 150Ω	R ~ 150Ω	-	-	R ~ 150Ω
7	-		-			-	-	
8	-	-	-	-	-	-	-	-
9	-	-	-	-	-	-	-	-

11.7.4 Preparing cables

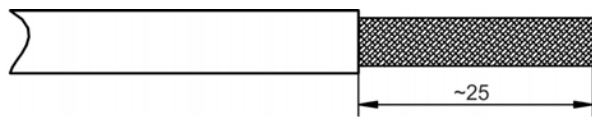

Remove the outer covering of the cable over a length of about 25 mm, without damaging the shielding braid.

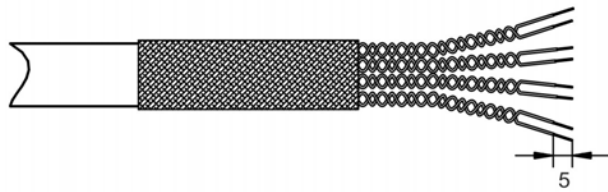

Push the shielding braid back over the outer covering of the cable, and strip off the ends of the cores over a length of about 5 mm, without damaging the copper strands.

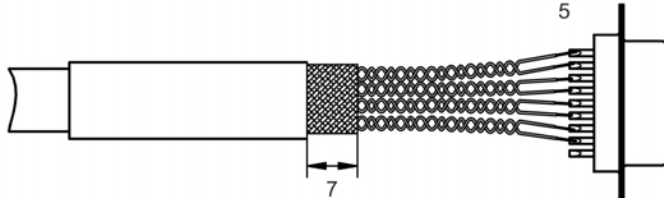

Push a suitable piece of heatshrink tubing over the outer cover, and heat it up. Leave about 7 mm free at the end.

Solder the ends of the cores (with the resistors where required) into the solder buckets of the SubD connector. Insulate the connections and the resistors so that there can be no accidental contact between them or with the connector housing.

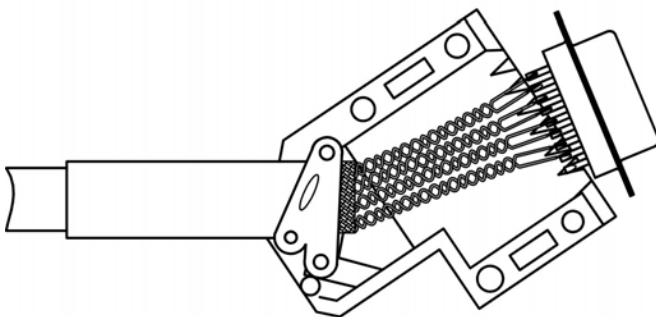

Use the strain relief to fix the cable to the bottom half of the housing. Do not overtighten the screws, or the cable will be crushed. Place the SubD connector, with the wider side below, in the bottom half of the housing.

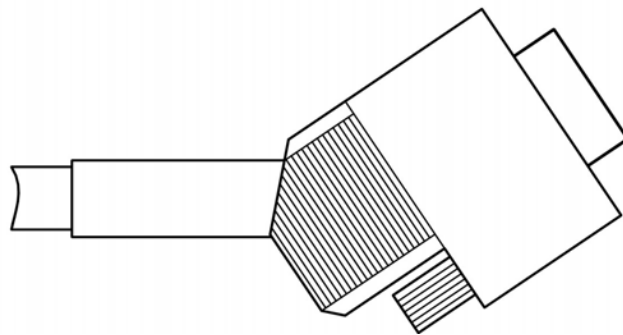

Check the connections before closing the housing, since it cannot be opened again afterwards without damage. Place the fixing screw in position in the housing, and then press the two halves of the housing firmly together. Take care that the fixing screw and the SubD connector insert are properly located.

11.8 Ethernet cable

Connection to an Ethernet network is possible via two RJ45 connectors in the servo amplifiers.

These cables can be used for all fieldbus connections with standard RJ45 connectors like EtherCAT, PROFINET, SynqNet and also for the EtherNet TCP/IP Service Port connection of an AKDservo amplifier.

11.8.1 Order codes Ethernet cable, configured

Article	Length	Order code
Ethernet cable	0.17 m	ENCP-0017-000
Ethernet cable	0.26 m	ENCP-0026-000
Ethernet cable	0.30 m	ENCP-0030-000
Ethernet cable	0.50 m	ENCP-0050-000
Ethernet cable	1.00 m	ENCP-0100-000
Ethernet cable	2.00 m	ENCP-0200-000
Ethernet cable	3.00 m	ENCP-0300-000
Ethernet cable	4.00 m	ENCP-0400-000
Ethernet cable	5.00 m	ENCP-0500-000
Ethernet cable	10.00 m	ENCP-1000-000

11.9 CAN bus cable

According to ISO 11898 you should use a bus cable with a characteristic impedance of 120 Ω. The usable cable length depends on the transmission rate. The values that we have measured can be taken as a guide, but they should not be interpreted as limits:

Cable data

- Characteristic impedance: 100-120 Ω
- Cable capacitance: max. 60 nF/km
- Conductor (loop) resistance: 159.8 Ω/km

Cable length, depending on the transmission rate:

Transmission rate / kbps	1000	500	250
max. cable length / m	20	70	115

The table refers to the total cable length between the ends of the bus. Longer transmission distances can be achieved with a lower cable capacitance (max. 30 nF/km) and lower loop resistance (115 Ω/km).

11.9.1 CAN bus cable AKD

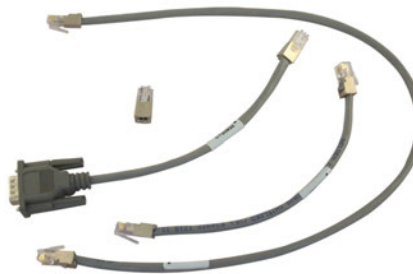

We deliver configured CAN bus cables for AKD-xyyyzz-xxCN and AKD-xyyyzz-xxCC.

Article	Length	AKD Order code
CAN Bus cable	0.15 m	CBP000-002-m15-00
CAN Bus cable	0.30 m	CBP000-002-m30-00
CAN Bus cable	1.00 m	CBP000-002-001-00
CAN Bus cable	3.00 m	CBP000-002-003-00

The CAN Termination connector is required for bus termination of the last AKD connected to the CAN bus. For connecting an AKD to a CAN device with SubD9 connector the CAN RJ12-SubD9 Adapter can be used.

Article	Order code
CAN Termination connector	AKD-CAN-Termination
CAN RJ12->SubD9 adapter	AKD-CAN-RJ12-SubD9

11.9.2 Can bus cable for S300/S400/S600/S700

NOTE

We do not deliver configured cables for S300/S400/S600/S700.

Usage of the materials in the table below ensure that all the requirements are met.

Part	Designation	Order code
Cable	Li2YCY (TP) 2x2x0.25mm ²	DE-86834 (cut to length)
SubD kit	9-pin SubD connector (socket)	DE-90650

If your cable has more connectors than you need, any of them can be left free.

For EMC reasons, the SubD connector housings must fulfil the following conditions:

- metal or metallic-coated housing
- provision for connecting the cable shielding to the housing, large-area connection

Wiring diagram

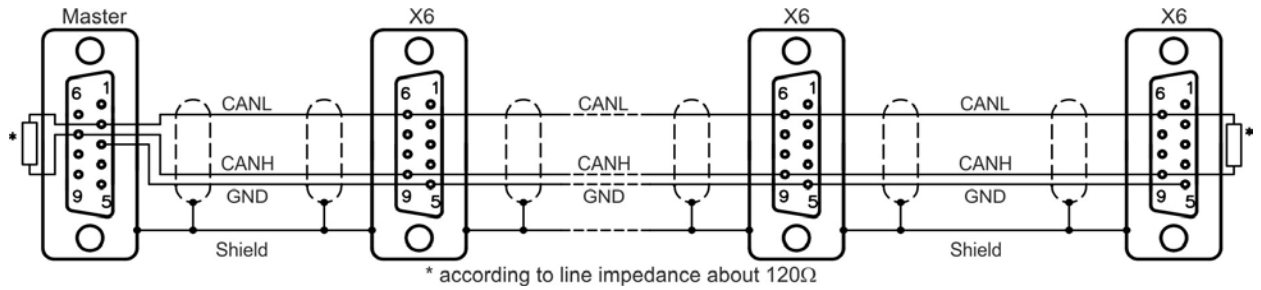

Preparing cables

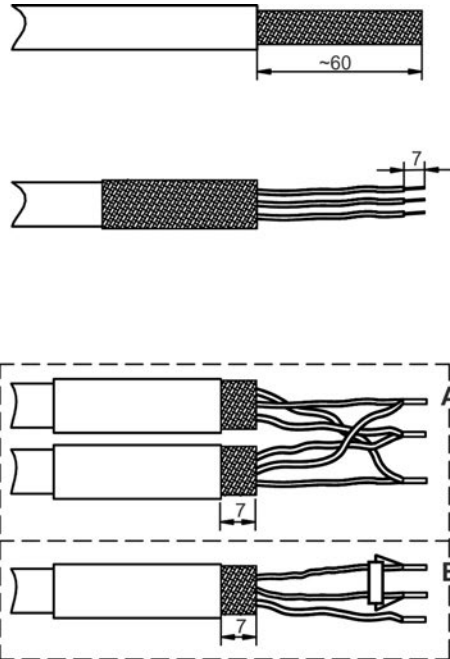

Remove the outer covering of the cable over a length of about 60 mm, without damaging the shielding braid.

Push the shielding braid back over the outer covering of the cable, and strip off the ends of the cores over a length of about 7 mm, without damaging the copper strands. The length can vary according to the type of bootlace ferrule that is used.

Push a suitable piece of heat-shrink tubing over the outer cover, and heat it up. Leave about 7 mm free at the end. Fit appropriate bootlace ferrules to the cores. Depending on which type of connector you are preparing, use diagram A (inner bus connector), or B (outer bus connector). Use ferrules for twin wires if you have to connect two cores, or one core and a termination resistor to a single connection.

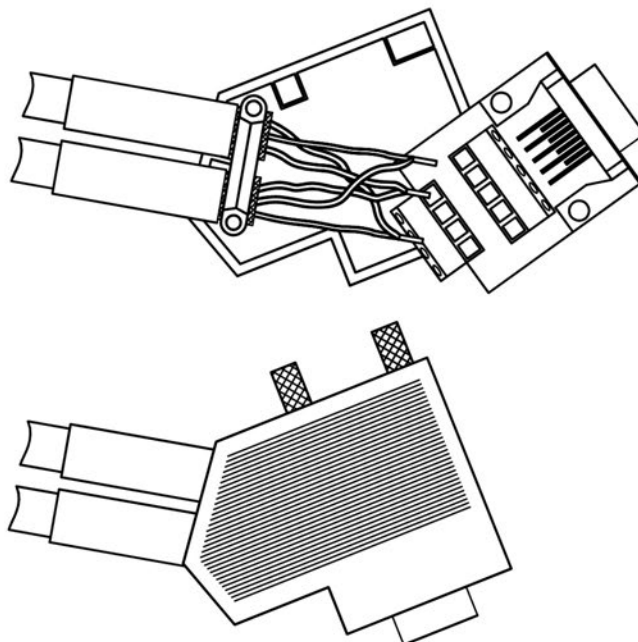

Use the strain relief to fix the cable to the bottom half of the housing. Do not overtighten the screws, or the cable will be crushed. Wire up the terminals according to the wiring diagram, and place the connector PCB with the terminals underneath in the lower half of the housing.

Put the two knurled screws in place, and press the two halves of the housing together until the four lugs snap into position.

Take care that the connector PCB and the knurled screws are properly located.

11.10 Hybrid cables

11.10.1 AKD to AKM1 Motor (i-tec connector)

You should use the configured Kollmorgen cables.

For AKD-B/P/T/M, with shield clamp, i-tec motor connector

AKD-B/P/T/M series servo amplifiers have a 15 pole high density SubD female connector to connect the feedback and a terminal connector for power wiring.

NOTE

For SFD3 connection to AKD-B/P/T/M, the feedback connector on the servo amplifier end contains electronics.

Usable for AKM1 (connector option D, feedback options C- and CA). Define the required length in clear text (steps of 1 m). Maximum cable length 25 m.

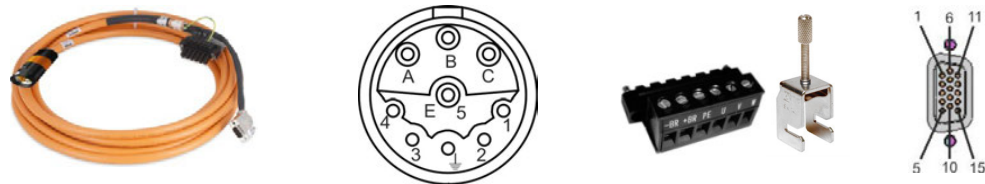

Servo amplifier	(4x1+(2x0.34)+(2x0.75))	Usable to connect	Order code
AKD-B/P/T/M	SFD	AKD-x00306 & x00606* and AKM1 (connector D, feedback C-)	CCS1A3-010-vvv-00
AKD-B/P/T/M	SFD3 & Brake	AKD-x & x* and AKM1 (connector D, feedback CA)	CCJ1A3-010-vvv-00

*= x means variants -B, -P, -T and -M

For AKD-N, i-tec motor connector

AKD-N series servo amplifiers have an 8 pole round connector to connect both motor power and feedback.

Usable for AKM1 (connector option D, feedback option CA).

Maximum cable length 5 m. Length definition: xx=meters, yy=centimeters.

0.2, 0.3, ... , 1.0 (steps 0.1m up to 1m)

1.25, 1.5, ... , 2.0 (steps 0.25m up to 2m).

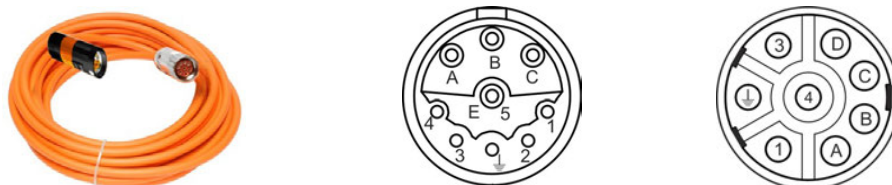

Servo amplifier	(4x1+(2x0.34)+(2x0.75))	Usable to connect	Order code
AKD-N	SFD3 & Brake	AKD-N and AKM1 (connector D, feedback CA)	CCJNA3-010-xxmyy-00

11.10.2 AKD to AKM2-6 (IP65 connector)

You should use the configured Kollmorgen cables.

With shield clamp for AKD-B/P/T/M, motor connector size 1 (up to 22A)

AKD-B/P/T/M series servo amplifiers have a 15 pole high density SubD female connector to connect the feedback and a terminal connector for power wiring. The hybrid cable is splitted to power and feedback cables on the servo amplifier end. The cable shield can be connected to the servo amplifier front with the attached shield clamp.

NOTE

For DSL and SFD3 connection to AKD-B/P/T/M, the feedback connector on the servo amplifier end contains electronics.

Usable for AKM2 to AKM6 (connector option D, feedback option C-, CA, GE and GF). Define the required length in clear text (steps of 1 m). Maximum cable length 25 m.

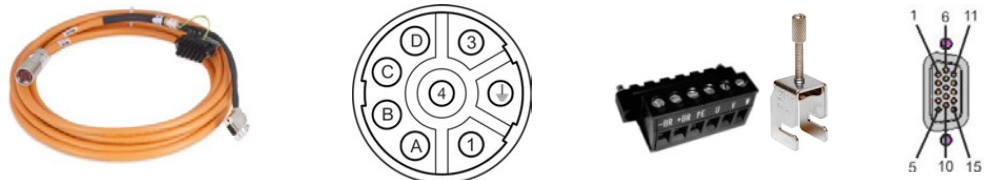

Servo amplifier	(4x1+(2x0.34)+(2x0.75))	Usable to connect	Order code
AKD-B/P/T/M	SFD	AKD-x00306 & x00606* and AKM2-6 (connector D, feedback C-)	CCS1A1-010-vvv-00
AKD-B/P/T/M	SFD3/DSL & Brake	AKD-x00306,x00606,x00307,x00607* and AKM2-6 (connector D, feedback CA, GE, GF)	CCJ1A1-015-vvv-00

*= x means variants -B, -P, -T and -M

For AKD-N, motor connector size 1 (up to 22A)

AKD-N series servo amplifiers have an 8 pole round connector to connect both motor power and feedback.

Usable for AKM2 to AKM6 (connector option D, feedback option CA, GE and GF).

Maximum cable length 5 m.Length definition: xx=meters, yy=centimeters.

0.2, 0.3, ... , 1.0 (steps 0.1m up to 1m)

1.25, 1.5, ... , 2.0 (steps 0.25m up to 2m).

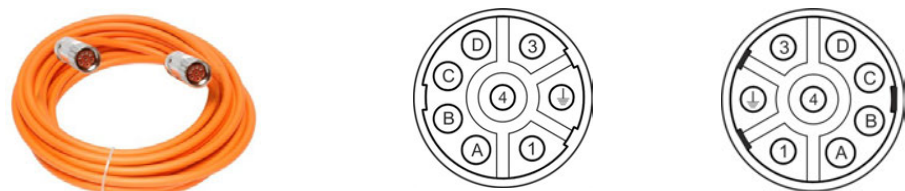

Servo amplifier	(4x1+(2x0.34)+(2x0.75))	Usable to connect	Order code
AKD-N	SFD3/DSL & Brake	AKD-N and AKM2-6 (connector D, feedback CA, GE, GF)	CCJNA1-015-xxmyy-00

With shield plate for AKD-B/P/T/M, motor connector size 1 (up to 22A)

AKD-B/P/T/M series servo amplifiers have a 15 pole high density SubD female connector to connect the feedback and a terminal connector for power wiring. The hybrid cable is splitted to power and feedback cables on the servo amplifier end. The cable shield is automatically connected to the servo amplifier front with the mounted shield plate.

NOTE

For DSL and SFD3 connection to AKD-B/P/T/M, the feedback connector on the servo amplifier end contains electronics.

Usable for AKM2 to AKM6 (connector option D, feedback option C-, CA, GE and GF). Define the required length in clear text (steps of 1 m). Maximum cable length 25 m.

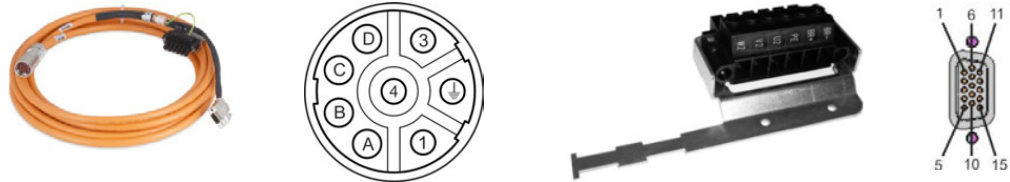

Servo amplifier	(4x1.5+ (2x0.34) (2x0.75))	Usable to connect	Order code
AKD-B/P/T/M	SFD	AKD-x01206* and AKM2-6 (connector D, feedback C-)	CCS2A1-015-vvv-00
AKD-B/P/T/M	SFD3 & Brake	AKD-x01206 & x00307...x01207* and AKM2-6 (connector D, feedback CA)	CCJ2A1-015-vvv-00
AKD-B/P/T/M	DSL & Brake	AKD-x01206 & x00307...x01207* and AKM2-6 (connector D, feedback GE/GF)	CCJ2A1-015-vvv-00

*= x means variants -B, -P, -T and -M

11.10.3 AKD-C to AKD-N in the decentralized drive system

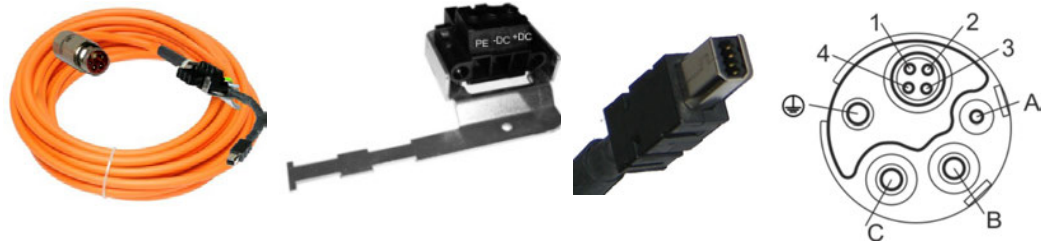

Length definition: xx=meters, yy=centimeters.
 Define cable lengths: 3 m, 6 m, 12 m, 24 m, 36 m, 40 m
 Maximum cable length 40 m.

You should use the configured Kollmorgen cables.

(3x2.5+(2x0.25)+(2x0.25))	Usable to connect	Order code
Hybrid Cable	Central power supply AKD-C to AKD-N	CCNCN1-025-xxmyy-00

For replacement issues you can order a connector kit for X20A or X21A with order code CON-AKD-CX20/21A-SL with one connector and one metal shroud.

11.10.4 AKD-N to AKD-N in the decentralized drive system

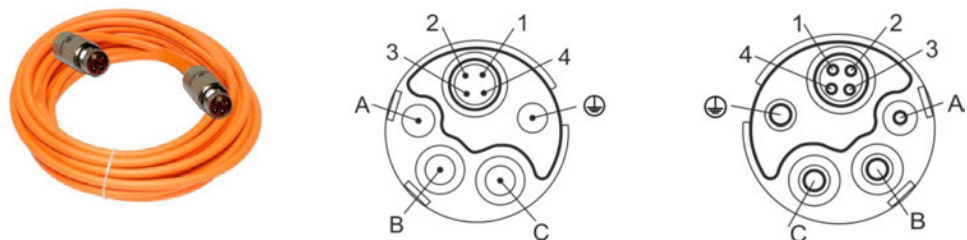

Length definition: xx=meters, yy=centimeters.
 Steps:

- 0.25 m steps from 0.25 m to 2 m,
- 0.5 m steps from 2.5 m bis 25 m
- Maximum cable length 25 m.

You should use the configured Kollmorgen cables.

(3x2.5+(2x0.25)+(2x0.25))	Usable to connect	Order code
Hybrid Cable	AKD-N to AKD-N	CCNNN1-025-xxmyy-00

11.11 Motor cables

11.11.1 General

Standard versions of Kollmorgen motors have either one connector or one terminal box for the power connection. Optional connection types are described in the relevant motor manual.

Motor series	Power Connection	Motor series	Power Connection
AKM1...8 =< 22A	Connector size 1	Cartridge DDR =< 22A	Connector size 1
AKM7...8 > 22A	Connector size 1.5	Cartridge DDR > 22A	Connector size 1.5
AKM8	Terminal box	DBL1...6 / DBK1...4	Connector size 1
AKMH2...6	Connector size 1	DBL7...8	Terminal box
VLM2...6	Connector size 1		

Depending on their power ratings, Kollmorgen servo amplifiers are equipped with connectors or fixed screw terminals.

Technical data of the used cable material can be found our [Technical WIKI \(Cables\)](#).

11.11.2 Motor cables, configured

The cables differ in respect of how they are connected to the amplifier. There are major differences in connection method due to the varying requirements in respect of minimum code distances, different shielding concepts depending on rated voltage and current load. Our pre-assembled ready-to-use cables meet the requirements of relevant CE and UL directives.

NOTE

Different conductor cross-sections are required for different motors, and that for motors with a holding brake the brake signals are also attached through this connector.

Connections standard motor connectors

The view is as seen from the contact side of the mating connector.

Standard (size 1). wire max 4mm ²					Option H (size 1.5). wire max. 10mm ²				
	Pin	Signal	Pin	Signal		Pin	Signal	Pin	Signal
	1	U2	A	+ Br		U	U2	+	+ Br
	4	V2	B	- Br		V	V2	-	- Br
	3	W2	C	n.c.		W	W2	1	Option J only
	PE (2)	PE	D	n.c.		PE	PE	2	Option J only

Material list

Part	Designation	Order Code
Cable	Overview (→ p. 45)	
Connector kit (motor end) Size 1.0	EMC Connector 8 poles, size 1.0	DE-92175
Washdown connector kit (motor end) Size 1.0	EMC Connector 8 poles, size 1.0. stainless steel	DE-201810
Connector kit (motor end) Size 1.5	EMC Connector 6 poles, size 1.5	DE-201601

11.11.2.1 Order codes motor cables for S300

NOTE

Column Max. Current: according to EN60204, table 6, installation type B2.

230V

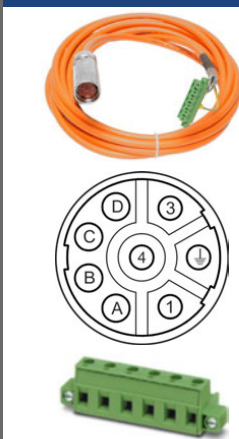
	Article	Cable Type	Max. Current	Order Code
	Motor cable (230V) 5m	(4x1)	10.1	DE-107485
	Motor cable (230V) 10m	(4x1)	10.1	DE-107486
	Motor cable (230V) 15m	(4x1)	10.1	DE-107487
	Motor cable (230V) 20m	(4x1)	10.1	DE-107488
	Motor cable (230V) 25m	(4x1)	10.1	DE-107489
	Motor cable (230V) 5m	(4x1+(2x0.75))	10.1 / 8.5	DE-107491
	Motor cable (230V) 10m	(4x1+(2x0.75))	10.1 / 8.5	DE-107492
	Motor cable (230V) 15m	(4x1+(2x0.75))	10.1 / 8.5	DE-107493
	Motor cable (230V) 20m	(4x1+(2x0.75))	10.1 / 8.5	DE-107494
	Motor cable (230V) 25m	(4x1+(2x0.75))	10.1 / 8.5	DE-107495

400V, with shield clamp

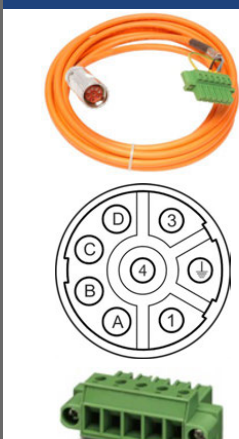
	Article	Cable Type	Max. Current	Order Code
	Motor cable (400V) 5m	(4x1)	10.1	DE-107473
	Motor cable (400V) 10m	(4x1)	10.1	DE-107474
	Motor cable (400V) 15m	(4x1)	10.1	DE-107475
	Motor cable (400V) 20m	(4x1)	10.1	DE-107476
	Motor cable (400V) 25m	(4x1)	10.1	DE-107477
	Motor cable (400V) 5m	(4x1+(2x0.75))	10.1 / 8.5	DE-107479
	Motor cable (400V) 10m	(4x1+(2x0.75))	10.1 / 8.5	DE-107480
	Motor cable (400V) 15m	(4x1+(2x0.75))	10.1 / 8.5	DE-107481
	Motor cable (400V) 20m	(4x1+(2x0.75))	10.1 / 8.5	DE-107482
	Motor cable (400V) 25m	(4x1+(2x0.75))	10.1 / 8.5	DE-107483

11.11.2.2 Order codes motor cables for S400

NOTE

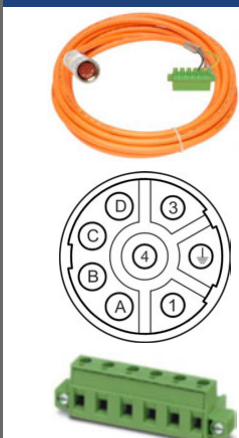

Column Max. Current: according to EN60204, table 6, installation type B2.

	Article	Cable Type	Max. Current	Order Code
	Motor cable 5m	(4x1)	10.1	DE-102575
	Motor cable 10m	(4x1)	10.1	DE-102576
	Motor cable 15m	(4x1)	10.1	DE-102806
	Motor cable 20m	(4x1)	10.1	DE-102807
	Motor cable 25m	(4x1)	10.1	DE-102808
	Motor cable 5m	(4x1+(2x0.75))	10.1 / 8.5	DE-102579
	Motor cable 10m	(4x1+(2x0.75))	10.1 / 8.5	DE-102580
	Motor cable 15m	(4x1+(2x0.75))	10.1 / 8.5	DE-102809
	Motor cable 20m	(4x1+(2x0.75))	10.1 / 8.5	DE-102810
	Motor cable 25m	(4x1+(2x0.75))	10.1 / 8.5	DE-102811

11.11.2.3 Order codes motor cables for S601...620

NOTE

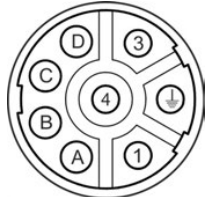
Column Max. Current: according to EN60204, table 6, installation type B2.



	Article	Cable Type	Max. Current	Order Code
  	Motor cable 5m	(4x1)	10.1	DE-90083
	Motor cable 10m	(4x1)	10.1	DE-90084
	Motor cable 15m	(4x1)	10.1	DE-90085
	Motor cable 20m	(4x1)	10.1	DE-90086
	Motor cable 25m	(4x1)	10.1	DE-90087
	Motor cable 5m	(4x1+(2x0.75))	10.1 / 8.5	DE-90088
	Motor cable 10m	(4x1+(2x0.75))	10.1 / 8.5	DE-90089
	Motor cable 15m	(4x1+(2x0.75))	10.1 / 8.5	DE-90090
	Motor cable 20m	(4x1+(2x0.75))	10.1 / 8.5	DE-90091
	Motor cable 25m	(4x1+(2x0.75))	10.1 / 8.5	DE-90092
	Motor cable 5m	(4x1.5)	13.1	DE-89918
	Motor cable 10m	(4x1.5)	13.1	DE-89952
	Motor cable 15m	(4x1.5)	13.1	DE-89953
	Motor cable 20m	(4x1.5)	13.1	DE-89954
	Motor cable 25m	(4x1.5)	13.1	DE-89956
	Motor cable 5m	(4x1.5+(2x0.75))	13.1 / 8.5	DE-89957
	Motor cable 10m	(4x1.5+(2x0.75))	13.1 / 8.5	DE-89961
	Motor cable 15m	(4x1.5+(2x0.75))	13.1 / 8.5	DE-89963
	Motor cable 20m	(4x1.5+(2x0.75))	13.1 / 8.5	DE-89965
	Motor cable 25m	(4x1.5+(2x0.75))	13.1 / 8.5	DE-89967
	Motor cable 5m	(4x2.5)	17.4	DE-89959
	Motor cable 10m	(4x2.5)	17.4	DE-89960
	Motor cable	15m (4x2.5)	17.4	DE-89962
	Motor cable 20m	(4x2.5)	17.4	DE-89964
	Motor cable 25m	(4x2.5)	17.4	DE-89966
Motor cable 5m	(4x2.5+(2x1))	17.4 / 10.1	DE-89968	
Motor cable 10m	(4x2.5+(2x1))	17.4 / 10.1	DE-89970	
Motor cable 15m	(4x2.5+(2x1))	17.4 / 10.1	DE-89971	
Motor cable 20m	(4x2.5+(2x1))	17.4 / 10.1	DE-89972	
Motor cable 25m	(4x2.5+(2x1))	17.4 / 10.1	DE-89969	

11.11.2.4 Order codes motor cables for S701-712

NOTE

Column Max. Current: according to EN60204, table 6, installation type B2.

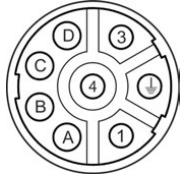
With shield clamp for amplifier's end, motor connector size 1, 6 poles, up to 22A

	Article	Cable Type	Max. Current	Order Code
  	Motor cable 5m	(4x1)	10.1	DE-107473
	Motor cable 10m	(4x1)	10.1	DE-107474
	Motor cable 15m	(4x1)	10.1	DE-107475
	Motor cable 20m	(4x1)	10.1	DE-107476
	Motor cable 25m	(4x1)	10.1	DE-107477
	Motor cable 5m	(4x1+(2x0.75))	10.1 / 8.5	DE-107479
	Motor cable 10m	(4x1+(2x0.75))	10.1 / 8.5	DE-107480
	Motor cable 15m	(4x1+(2x0.75))	10.1 / 8.5	DE-107481
	Motor cable 20m	(4x1+(2x0.75))	10.1 / 8.5	DE-107482
	Motor cable 25m	(4x1+(2x0.75))	10.1 / 8.5	DE-107483

With shield plate at amplifier's end, motor connector size 1, 6 poles, up to 22A



	Article	Cable Type	Max. Current	Order Code
  	Motor cable 5m	(4x1.5)	13.1	DE-200456
	Motor cable 10m	(4x1.5)	13.1	DE-200457
	Motor cable 15m	(4x1.5)	13.1	DE-200458
	Motor cable 20m	(4x1.5)	13.1	DE-200459
	Motor cable 25m	(4x1.5)	13.1	DE-200460
	Motor cable 5m	(4x1.5+(2x0.75))	13.1 / 8.5	DE-200462
	Motor cable 10m	(4x1.5+(2x0.75))	13.1 / 8.5	DE-200463
	Motor cable 15m	(4x1.5+(2x0.75))	13.1 / 8.5	DE-200464
	Motor cable 20m	(4x1.5+(2x0.75))	13.1 / 8.5	DE-200465
	Motor cable 25m	(4x1.5+(2x0.75))	13.1 / 8.5	DE-200466
	Motor cable 5m	(4x2.5)	17.4	DE-200468
	Motor cable 10m	(4x2.5)	17.4	DE-200469
	Motor cable 15m	(4x2.5)	17.4	DE-200470
	Motor cable 20m	(4x2.5)	17.4	DE-200471
	Motor cable 25m	(4x2.5)	17.4	DE-200472
	Motor cable 5m	(4x2.5+(2x1))	17.4 / 10.1	DE-200474
	Motor cable 10m	(4x2.5+(2x1))	17.4 / 10.1	DE-200475
	Motor cable 15m	(4x2.5+(2x1))	17.4 / 10.1	DE-200476
	Motor cable 20m	(4x2.5+(2x1))	17.4 / 10.1	DE-200477
	Motor cable 25m	(4x2.5+(2x1))	17.4 / 10.1	DE-200478
	Motor cable 5m	(4x4)	23	DE-200618
	Motor cable 10m	(4x4)	23	DE-200619
	Motor cable 15m	(4x4)	23	DE-200620
	Motor cable 20m	(4x4)	23	DE-200621
	Motor cable 25m	(4x4)	23	DE-200622
	Motor cable 5m	(4x4+(2x1))	23 / 10.1	DE-200623
	Motor cable 10m	(4x4+(2x1))	23 / 10.1	DE-200624
	Motor cable 15m	(4x4+(2x1))	23 / 10.1	DE-200625
	Motor cable 20m	(4x4+(2x1))	23 / 10.1	DE-200626
	Motor cable 25m	(4x4+(2x1))	23 / 10.1	DE-200627

11.11.2.5 Order codes motor cables for S724

NOTE

Column Max. Current: according to EN60204, table 6, installation type B2.

With shield plate at amplifier's end, motor connector size 1.5, 6 poles



	Article	Cable Type	Max. Current	Order Code	
	Motor cable 5m	(4x6)	30	DE-201678	
	Motor cable 10m	(4x6)	30	DE-201679	
	Motor cable 15m	(4x6)	30	DE-201680	
	Motor cable 20m	(4x6)	30	DE-201681	
	Motor cable 25m	(4x6)	30	DE-201682	
		Motor cable 5m	(4x6+(2x1))	30 / 10.1	DE-201683
		Motor cable 10m	(4x6+(2x1))	30 / 10.1	DE-201684
		Motor cable 15m	(4x6+(2x1))	30 / 10.1	DE-201685
		Motor cable 20m	(4x6+(2x1))	30 / 10.1	DE-201686
		Motor cable 25m	(4x6+(2x1))	30 / 10.1	DE-201687

11.11.2.6 Order codes motor cables for S748, S640/670



NOTE

Column Max. Current: according to EN60204, table 6, installation type B2.

Wire end ferrules at amplifier's end, motor connector size 1.5, 6 poles

	Article	Cable Type	Max. Current	Order Code
	Motor cable 5m	(4x10)	40	DE-201589
	Motor cable 10m	(4x10)	40	DE-201590
	Motor cable 15m	(4x10)	40	DE-201591
	Motor cable 20m	(4x10)	40	DE-201592
	Motor cable 25m	(4x10)	40	DE-201593
	Motor cable 5m	(4x10+(2x1.5))	40 / 13.1	DE-201594
	Motor cable 10m	(4x10+(2x1.5))	40 / 13.1	DE-201595
	Motor cable 15m	(4x10+(2x1.5))	40 / 13.1	DE-201596
	Motor cable 20m	(4x10+(2x1.5))	40 / 13.1	DE-201597
	Motor cable 25m	(4x10+(2x1.5))	40 / 13.1	DE-201598
	Motor cable 5m	(4x16)	54	DE-201688
	Motor cable 10m	(4x16)	54	DE-201689
	Motor cable 15m	(4x16)	54	DE-201690
	Motor cable 20m	(4x16)	54	DE-201691
	Motor cable 25m	(4x16)	54	DE-201692
	Motor cable 5m	(4x16+(2x1.5))	54 / 13.1	DE-201693
	Motor cable 10m	(4x16+(2x1.5))	54 / 13.1	DE-201694
	Motor cable 15m	(4x16+(2x1.5))	54 / 13.1	DE-201695
	Motor cable 20m	(4x16+(2x1.5))	54 / 13.1	DE-201696
	Motor cable 25m	(4x16+(2x1.5))	54 / 13.1	DE-201697

Wire end ferrules on amplifier's end, motor end cut off for motors with terminal box

	Article	Cable type	Max. Current	Order Code	
	Motor cable 5m	(4x10)	40	DE-201698	
	Motor cable 10m	(4x10)	40	DE-201699	
	Motor cable 15m	(4x10)	40	DE-201700	
	Motor cable 20m	(4x10)	40	DE-201701	
	Motor cable 25m	(4x10)	40	DE-201702	
	Motor cable 5m	(4x10+(2x1.5))	40 / 13.1	DE-201713	
	Motor cable 10m	(4x10+(2x1.5))	40 / 13.1	DE-201714	
	Motor cable 15m	(4x10+(2x1.5))	40 / 13.1	DE-201715	
	Motor cable 20m	(4x10+(2x1.5))	40 / 13.1	DE-201774	
	Motor cable 25m	(4x10+(2x1.5))	40 / 13.1	DE-201775	
		Motor cable 5m	(4x16)	54	DE-201703
		Motor cable 10m	(4x16)	54	DE-201704
		Motor cable 15m	(4x16)	54	DE-201705
		Motor cable 20m	(4x16)	54	DE-201706
		Motor cable 25m	(4x16)	54	DE-201707
		Motor cable 5m	(4x16+(2x1.5))	54 / 13.1	DE-201776
		Motor cable 10m	(4x16+(2x1.5))	54 / 13.1	DE-201745
		Motor cable 15m	(4x16+(2x1.5))	54 / 13.1	DE-201746
		Motor cable 20m	(4x16+(2x1.5))	54 / 13.1	DE-201747
		Motor cable 25m	(4x16+(2x1.5))	54 / 13.1	DE-201748
		Motor cable 5m	(4x25)	70	DE-201708
		Motor cable 10m	(4x25)	70	DE-201709
		Motor cable 15m	(4x25)	70	DE-201710
		Motor cable 20m	(4x25)	70	DE-201711
		Motor cable 25m	(4x25)	70	DE-201712
Motor cable 5m	(4x25+(2x1.5))	70 / 13.1	DE-201749		
Motor cable 10m	(4x25+(2x1.5))	70 / 13.1	DE-201750		
Motor cable 15m	(4x25+(2x1.5))	70 / 13.1	DE-201751		
Motor cable 20m	(4x25+(2x1.5))	70 / 13.1	DE-201752		
Motor cable 25m	(4x25+(2x1.5))	70 / 13.1	DE-201753		

11.11.2.7 Order codes motor cables for AKD-B/P/T/M

NOTE

Hybrid cables for motors with one-cable connection → p. 62

Define the required length in clear text (steps of 1m). Length definition vvv=meters. Maximum cable length 50 m, in case of cable length ≥ 25 m a motor choke (→ p. 41) should be used.

AKD-B/P/T/M, AKM1 motor connector y-tec

Usable to connect AKD-x00306* and AKM1 (connector options 1, Y).

Cable is delivered with shield clamp.

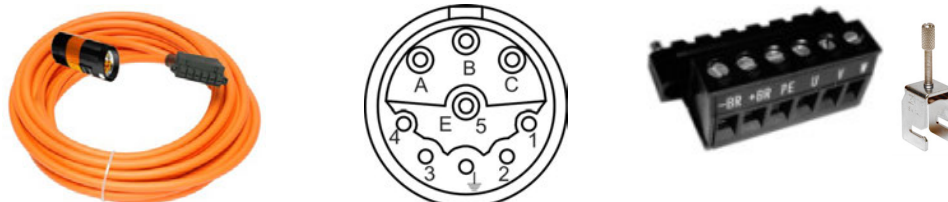

Article	Order code
Motor cable (4x1)	CM01A3-010-vvv-00
Motor cable (4x1+(2x1))	CM11A3-010-vvv-00

*= x means variants -B, -P, -T and -M

AKD-B/P/T/M, AKM1 motor connector y-tec

Usable to connect AKD-x00307* and AKM1 (connector options 1, Y).

Drive connector with mounted shield plate.

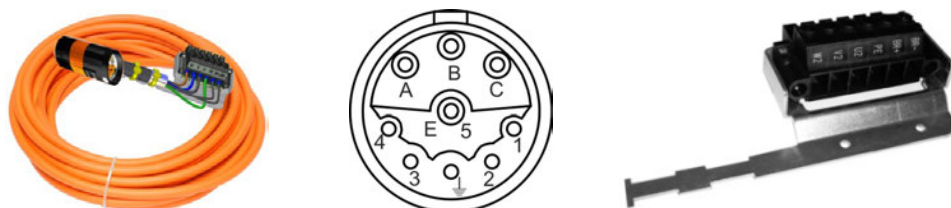

Article	Order code
Motor cable (4x1)	CM02A3-010-vvv-00
Motor cable (4x1+(2x1))	CM12A3-010-vvv-00

*= x means variants -B, -P, -T and -M

With shield clamp for AKD-B/P/T/M, motor connector size 1 (up to 22A)

Usable to connect AKD-x00306* & x00606* and AKM1 to AKM7 (connector options 1, 7, B, C, G)

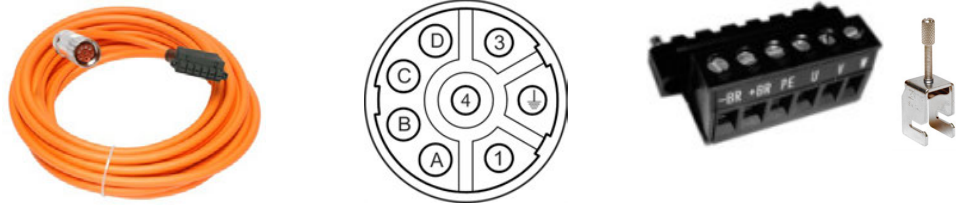

Article	Order code
Motor cable (4x1)	CM01A1-010-vvv-00
Motor cable (4x1+(2x1))	CM11A1-010-vvv-00

*= x means variants -B, -P, -T and -M

With shield plate for AKD-B/P/T/M, motor connector size 1 (up to 22A)

Usable to connect AKD-x01206* & 02406*, AKD-x00307...x02407* and AKM1 to AKM7 (connector options 1, 7, B, C, G).

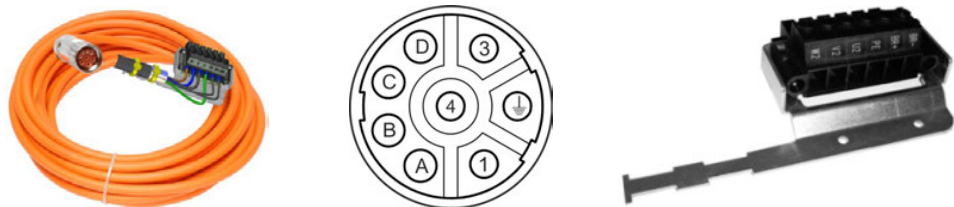

Article	Order code
Motor cable (4x1.5)	CM02A1-015-vvv-00
Motor cable (4x1.5+(2x1))	CM12A1-015-vvv-00
Motor cable (4x2.5)	CM02A1-025-vvv-00
Motor cable (4x2.5+(2x1))	CM12A1-025-vvv-00
Motor cable (4x4)	CM02A1-040-vvv-00
Motor cable (4x4+(2x1.5))	CM12A1-040-vvv-00

*= x means variants -B, -P, -T and -M

With shield plate for AKD-B/P/T/M. motor connector size 1.5 (> 22A)

Usable to connect AKD-x02406* & x02407* and AKM74Q / AKM82T (connector options 1, H)



Article	Order code
Motor cable (4x6)	CM02A4-060-vvv-00
Motor cable (4x6+(2x1.5))	CM12A4-060-vvv-00

*= x means variants -B, -P, -T and -M

11.11.2.8 Order codes motor cables for AKD-N

Define the required length in clear text.

Length definition: xx=meters, yy=centimeters. Steps:

- 0.1 m steps from 0.2 m to 1 m.
- 0.25 m steps from 1.25 m to 5 m

Maximum cable length 5 m.

Round connector for AKD-N, AKM1 motor connector y-tec

Usable to connect AKD-N and AKM1 (connector options 1, Y).

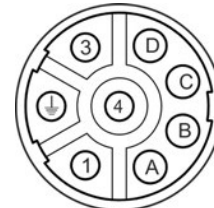
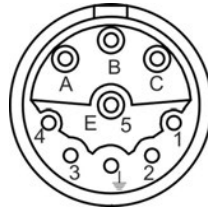

Article	Order code
Motor cable (4x1)	CM0NA3-010-xxmyy-00
Motor cable (4x1+(2x1))	CM1NA3-010-xxmyy-00

Round connector for AKD-N, motor connector size 1 (up to 22A)

Usable to connect AKD-N and AKM1 to AKM5 (connector options 1, 7, B, C, G)

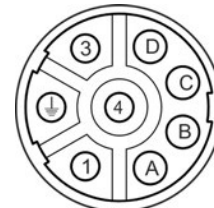
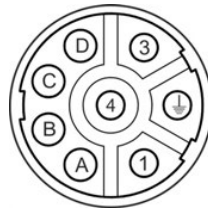

Article	Order code
Motor cable (4x1)	CM0NA1-010-xxmyy-00
Motor cable (4x1+(2x1))	CM1NA1-010-xxmyy-00

11.11.3 Preparing motor cables (motor end)

11.11.3.1 Motor series AKM2...8, 6SMx7, DBL2...6, DBK

Motors with connectors should be connected with our pre-assembled cables.

11.11.3.2 Motor series AKM8, DBL7/8

These motors are fitted with terminal boxes, in which there are bolts or terminals for connections. The terminal boxes have 2 screw glands, so that the power and brake cables can be routed separately. If a motor cable with integral brake is used, the unused screw gland must be replaced by a blanking plug. Please refer to the instructions manual for the motor series.

Preparing cables for terminal box, separate cables (DBL7/8)

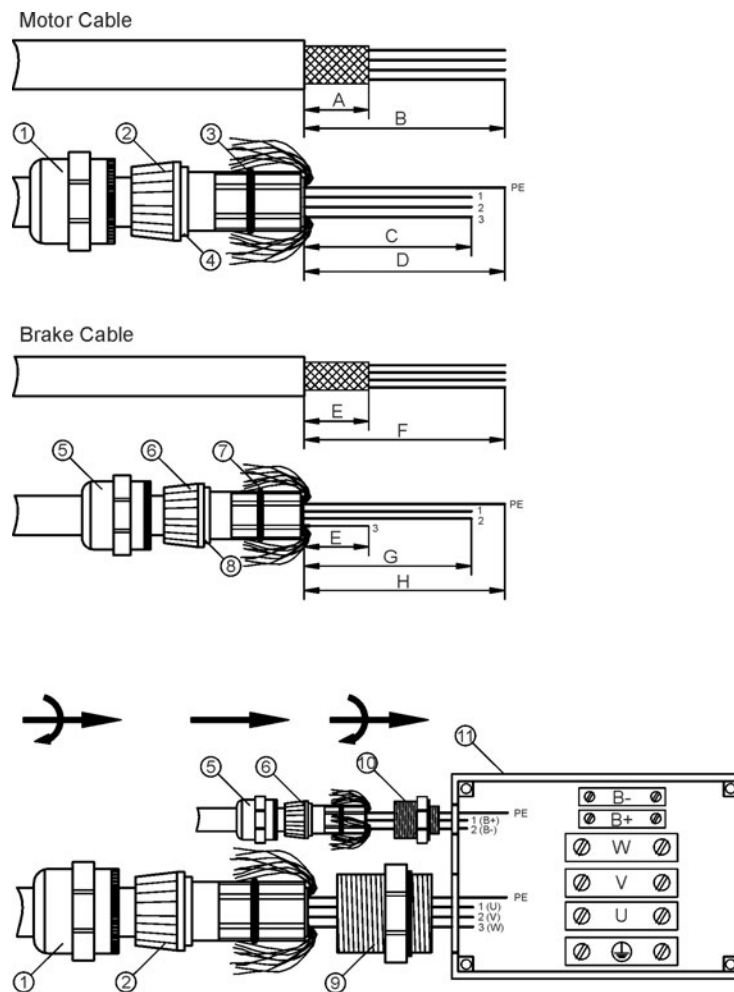

Remove the outer covering over length B, without damaging the shielding braid. Shorten the shielding braid to length A.

Push the union nut (1) and the clamping ring (2) onto the cable and push the shielding braid back over the clamping ring. The shielding braid must cover the sealing ring (3), but must not stick out over the sealing edge (4). Cut off the cores to lengths C and D.

Remove the outer covering over length F, without damaging the shielding braid. Shorten the shielding braid to length E.

Push the union nut (5) and the clamping ring (6) onto the cable and push the shielding braid back over the clamping ring. The shielding braid must cover the sealing ring (7), but must not stick out over the sealing edge (8). Cut off the cores to lengths E/G/H. Remove the insulation from core 3 and lay it over the shielding braid.

Screw the threaded sleeve (9) or (10) into the terminal box (11, example: AKM8 Motor). Push the cores of the cables and the clamping rings (2) or (6) through the threaded sleeve and screw the union nut (1) or (5) tightly onto the threaded sleeve. Then fit bootlace ferrules or terminal pins to the ends of the cores for the brake connections, and ring terminals to the power connections and the PE.

Motor	A	B	C	D	E	F	G	H	Connection
DBL7/8	20	140	110	140	20	140	130	140	Terminals (similar to drawing)

Preparing cables for terminal box, combined cables (AKM8, DBL7/8)

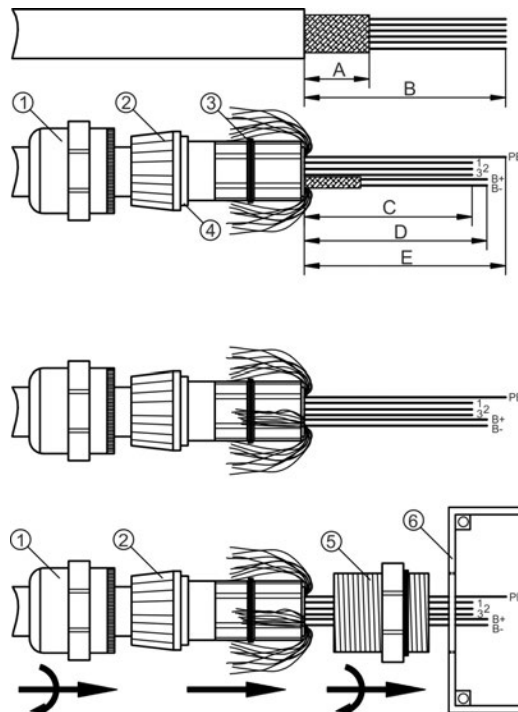

Remove the outer covering over length B, without damaging the shielding braid. Shorten the shielding braid to length A.

Push the union nut (1) and the clamping ring (2) onto the cable and push the shielding braid back over the clamping ring. The shielding braid must cover the sealing ring (3), but must not stick out over the sealing edge (4). Cut off the cores to lengths C/D/E. Shorten the shielding braid for the brake cores to length A.

Push the shielding braid for the brake cores back over the clamping ring. The braid must cover the sealing ring (3) but must not stick out over the sealing edge (4).

Screw the threaded sleeve (5) into the terminal box (6, example: AKM8 Motor). Push the cores of the cable and the clamping ring (2) through the threaded sleeve and screw the union nut (1) tightly onto the threaded sleeve.

Then fit, depending on the motor type, bootlace ferrules or ring terminals to the ends of the cores.

Motor	A	B	C	D	E	Connection
DBL7/8	20	140	110	130	140	Terminals
AKM8	20	140	110	130	140	Terminals

11.11.4 Preparing motor cables (servo amplifier end)

Material list

Part	Description	Order code
Cable	Overview (→ p. 45)	
Connector kit amplifier end S300, 230V	Power Combicon X9	DE-107631
Connector kit amplifier end S300, 400V	Power Combicon X9	DE-107467
Connector kit amplifier end S400	Power Combicon X6	DE-107466
Connector kit amplifier end S601...620	Power Combicon X9	DE-90066
Connector kit amplifier end S701-712, S724	Power Combicon X9	DE-200453
Connector kit amplifier end AKD-x00306/x00606*, SK14	Power Combicon X2	AKD-X2+SK14-Kit
Connector kit amplifier end AKD-x01206/x02406/x0xx07*	Power Combicon X2	AKD-X2+Shield-Kit

*= X means variants -B, -P, -T and -M

Connection scheme

Pin assignment is described in the instructions manual for the servo amplifier.

11.11.4.1 Preparing cables for S300/S400

The motor is connected to S300 or S400 by a Power Combicon connector (→ p. 77). Please take note that the connector can accept a maximum conductor cross-section of 4 mm².

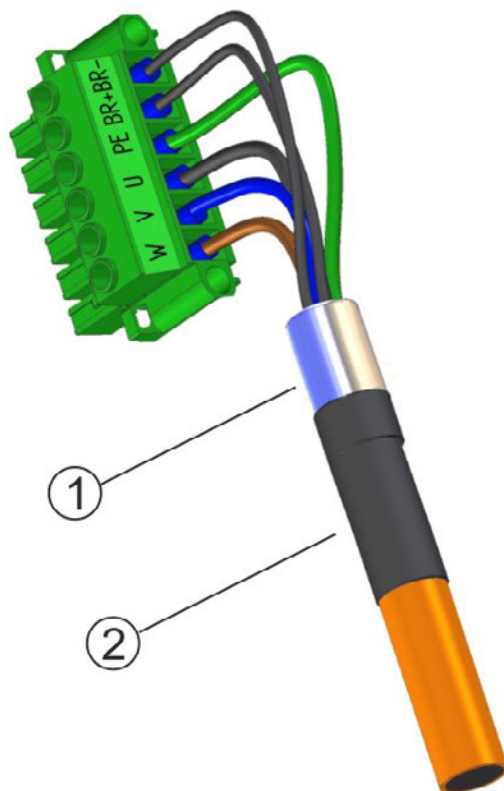

Strip the external cable sheath to a length of approximately 120 mm, taking care not to damage the braided shield. Push the braided shield (1) back over the cable and secure with a rubber sleeve (2) or shrink sleeve. Shorten all the wires apart from the protective earth (PE) wire (green/yellow) by about 20 mm so that the PE wire is now the longest wire. Strip all wires and fit wire end ferrules.

Wire the connector as shown in the connection diagram in the instructions manual. Plug in the connector to the socket on the front of the servo amplifier. Screw the connector in place.

Use a shielding clamp (→ p. 24) to ensure an optimum shield connection to the servo amplifier.

Alternatively you can use the shield shroud of the servo amplifier. Use cable ties to attach the cable to the side shroud of the amplifier, securing the braided shield of the cable to the shroud with a cable tie.

This ensures that there is conductive contact over a large surface area between the braided shield and the front panel.

11.11.4.2 Preparing cables for S601...620

The motor is connected to the S601...620 by a Power Combicon connector (→ p. 77). You can order the connector kit from Kollmorgen (connector, housing, shield plate, rubber bushes, installation material) with the order code DE-90066.

Please take note that the connector can accept a maximum conductor cross-section of 4 mm².

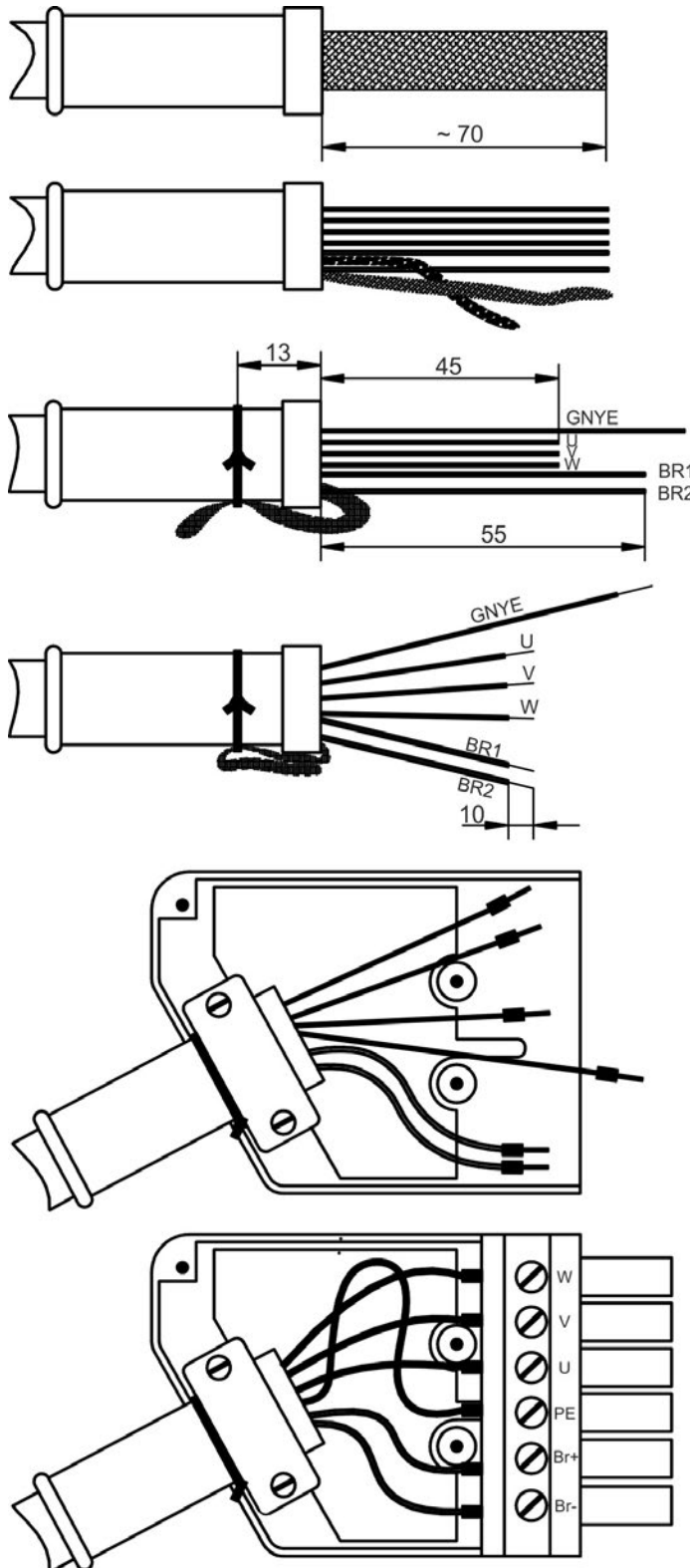

First push the rubber sleeve onto the cable, and **then** strip off about 70 mm of the outer covering, without damaging the shielding.

Carefully separate the shielding braid from the cores.

Twist the shielding braid into a pigtail and tie it to the sleeve with the wire. Shorten the brake cores to 55 mm and the power cores to 45 mm.

Fold back the overhanging length of the shielding pigtail to face forwards. Strip off the ends of the cores for about 10 mm. This length can vary, depending on the type of bootlace ferrule that is used.

Apply bootlace ferrules to the conductors. Place the shield plate in the bottom half of the connector housing. Place the cable in the strain relief, so that the folded shielding pigtail lies on the shield plate, but the tie-wire is not clamped inside.

Tighten up the screws, without crushing the cable.

Place the connector in the housing. Take care that the tongue of the shield plate sits in the PE clamp. Wire up the connector according to the wiring diagram in the instructions manual, and tighten up the clamping screws. Take care that the insulation is not trapped underneath. Close the housing.

11.11.4.3 Preparing cables for S701...724

The motor is connected to the S701...724 by a Power Combicon connector (→ p. 77). You can order the connector kit from Kollmorgen (connector, housing, shield plate, rubber bushes, installation material) with the order code DE-200453. Please take note that the connector can accept a maximum conductor cross-section of 6 mm².

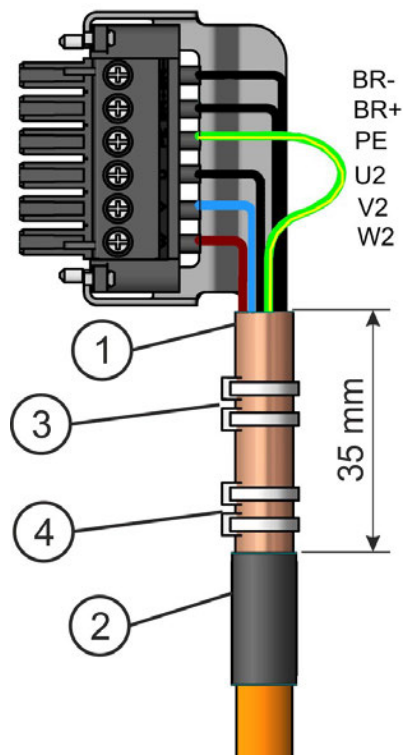

Strip the external cable sheath to a length of approx. 120 mm, taking care not to damage the braided shield. Push the braided shield (1) back over the cable and secure with a rubber sleeve (2) or shrink sleeve.

Shorten all the wires apart from the protective earth (PE) wire (green/yellow) by about 20 mm so that the PE wire is now the longest wire. Strip all wires and fit wire end ferrules.

Secure the braided shield of the cable to the shroud with a cable tie or a hose clamp (3) and use a second tie (4) to fasten the cable.

Wire the connector as shown in the connection diagram. Plug in the connector to the socket on the front of the S701...724.

Screw the connector in place. This ensures that there is conductive contact over a large surface area between the braided shield and the front panel.

11.11.4.4 Preparing cables for AKD-x00306/x00606



The motor is connected to the AKD-x00306/x00606 with a connector (→ p. 77). Please take note that the connector can accept a maximum conductor cross-section of 4 mm².

Use a shielding clamp (→ p. 24) to ensure an optimum shield connection to the servo amplifier.

Wire the connector as shown in the connection diagram in the installation manual. Plug in the connector to the socket on the front of the servo amplifier. Screw the connector in place.

11.11.4.5 Preparing cables for AKD-x01206/X02406/X0xx07

The motor is connected to the AKD-x01206/x02406/x0xx07 by a Power Combicon connector (→ p. 77). You can obtain the connector kit from us (with connector, housing, shield plate, rubber bushes, installation material).

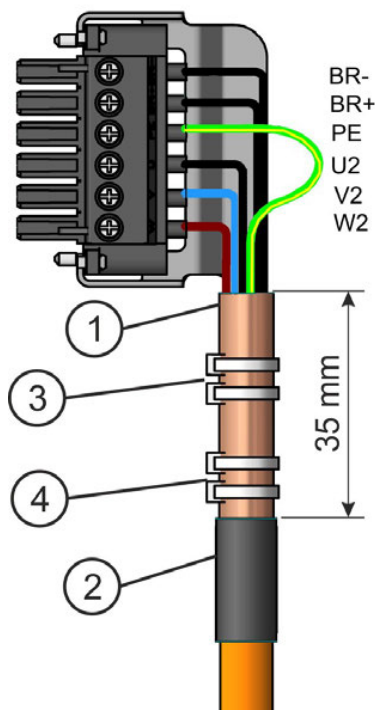

Strip the external cable sheath to a length of approx. 120 mm, taking care not to damage the braided shield. Push the braided shield (1) back over the cable and secure with a rubber sleeve (2) or shrink sleeve.

Shorten all the wires apart from the protective earth (PE) wire (green/yellow) by about 20 mm so that the PE wire is now the longest wire. Strip all wires and fit wire end ferrules.

Secure the braided shield of the cable to the shroud with a cable tie or a hose clamp (3) and use a second tie (4) to fasten the cable.

Wire the connector as shown in the connection diagram. Plug in the connector to the socket on the front of the AKD.

Screw the connector in place. This ensures that there is conductive contact over a large surface area between the braided shield and the front panel.

11.11.4.6 Preparing cables for S640/670 and S748/772

Motor Power Cable

The motor is connected to the S640/670 or S748/772 by terminals. The cable material depends on the motor that is used. Please refer to the instructions manual for the corresponding motor series.

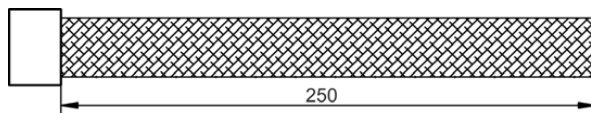

Please take note that the terminals can accept a core cross-sections of 10 to 50 mm².

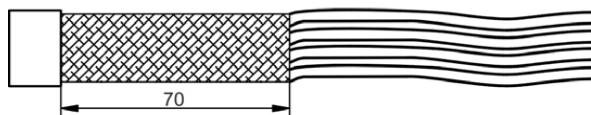

Remove the outer covering over a length of 250 mm, without damaging the shielding braid.

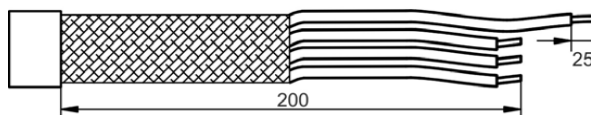

Shorten the shielding braid to a length of 70 mm.

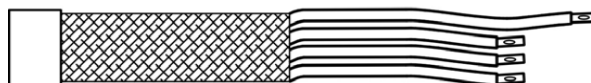

Shorten the cores for the power connections to 200 mm. Strip off about 25 mm of the insulation from all cores. The length varies with the conductor cross-section and the type of bootlace ferrule that is used.

Apply bootlace ferrules to the conductors. Do not use terminal pins, because their cross-section is too small.

Holding Brake Cable

S640/670

The electric holding brake of the motor is connected via connector X4. It is therefore necessary to wire the power and brake cables separately.

S748/772

The electric holding brake of the motor is connected via connector X9A. It is therefore necessary to wire the power and brake cables separately. The 24V power supply for the holding brake is connected via connector X9B (→ p. 52).

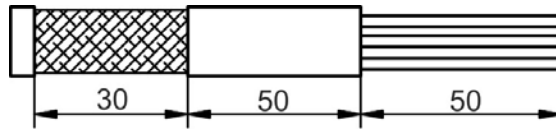

Remove the outer covering of the cable and the shielding braid over a length of about 50 mm. Then remove the outer covering without damaging the shielding braid.

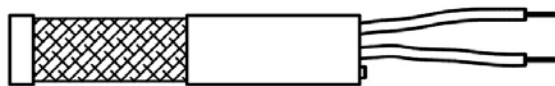

Shorten the redundant lines of the cable as far as possible. Strip off about 10 mm of the insulation from the ends of the cores. Take care to avoid damage to the copper strands while doing this. Depending on the cross-section of the core and the type of bootlace ferrule that is used, the length that has to be stripped may vary by several millimeters.

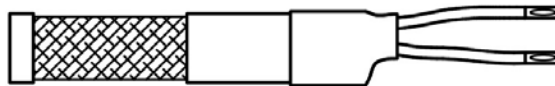

Protect the redundant lines by pushing a 30 mm long heat shrink sleeve half over the outside cover and heat it up.

Apply bootlace ferrules to the conductors. As an alternative, you can also use terminal pins instead of bootlace ferrules.

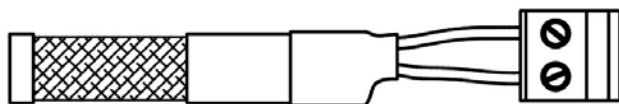

Connector example S748/772:

Push the ends of the conductors into the connector as far as they will go. Follow the pin assignment in the instructions manual. Tighten the screws of the terminals. Take care that the insulation is not trapped in the terminals.

11.12 Feedback cables

11.12.1 Resolver cables

11.12.1.1 Resolver cables for S300/S400/S600/S700



All standard motors in our range feature the same 12-pin connector for the resolver connection. This connector is also used for the connections from the motor's thermal protection contact to the servo amplifier. The servo amplifiers have a Sub-D female connector for the connection of a resolver and the thermal protection contact.

The cable shield is connected to the servo amplifier via the connector housing.

The motor feedback should be connected with pre-assembled cables from Kollmorgen.

Order Codes Resolver cable, configured

Article	Cable Type	Cable Length	Order Code
Resolver cable	(4x(2x0.25))	5 m	DE-84972
Resolver cable	(4x(2x0.25))	10 m	DE-84973
Resolver cable	(4x(2x0.25))	15 m	DE-84974
Resolver cable	(4x(2x0.25))	20 m	DE-84975
Resolver cable	(4x(2x0.25))	30 m	DE-84976

Pinout and components

For cable lengths up to 100 m use a shielded and sheathed cable, with cores as twisted pairs (suggestion acc. to DIN 47100). Please consult our customer support for cables longer than 100 m.

Amplifier end Pin	Pair No.	Core color acc. to IEC 60757	Motor end Pin	Function 6SM, DBL/DBK, AKM, VLM	
-	-	-	1	n.c.	
2	4	BU	2	Thermal Sensor+	
3	2	YE	3	S4 Cosine-	
4	3	PK	4	S3 Sine-	
5	1	BN	5	R2 Reference-	
6	4	RD	6	Thermal Sensor-	
7	2	GN	7	S2 Cosine+	
8	3	GY	8	S1 Sine+	
9	1	WH	9	R1 Reference+	

Material list

Part	Designation	Order code
Cable (cut to length)	LiYCY (TP) 4x2x0.25	DE-92186
Connector kit, motor end	EMC Connector 12 pole	DE-90210
Washdown connector kit, motor end	EMC Connector 12 pole, stainless steel	DE-201811
Connector kit, amplifier end	Socket 9-poles, housing and screws	DE-81784

Technical data of the used cable material can be found on → p. 45

11.12.1.2 Resolver cable for AKD

All our standard motors feature the same 12-pin connector (IP65) for the resolver connection. This connector is also used for the connections from the motor's thermal protection contact to the servo amplifier. The AKM1 motor optionally supports a y-tec connector.

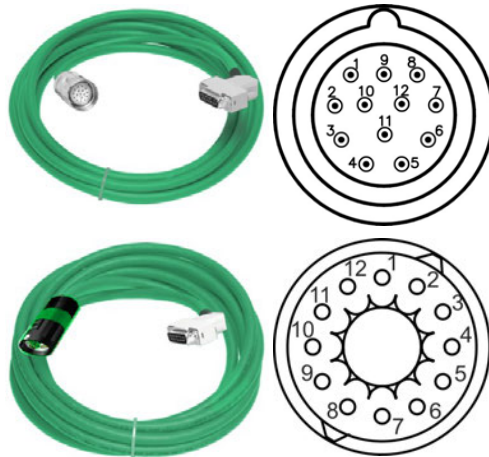

The AKD-B/P/T/M series servo amplifiers have a 15 pole high density Sub-D female connector for the connection of a resolver and the thermal protection contact. On the motor end two connectors are available: standard Kollmorgen IP65 or y-tec connector for AKM1.

Length definition: vvv=meters.

Maximum cable length 100 m.

The cable shield is connected to the AKD-B/P/T/M via the connector housing.

The motor feedback should be connected with pre-assembled cables from Kollmorgen.

Order codes for resolver cables, pre-assembled

Amplifier	(4x(2x0.25))	Order code	Length
AKD-B/P/T/M	Resolver Cable IP65	CFR0A1-002-vvv-00	Steps of 1m up to 100m
AKD-B/P/T/M	Resolver Cable y-tec	CFR0A3-002-vvv-00	Steps of 1m up to 100m

Define the required length in clear text.

11.12.2 SFD cables for AKD



The AKD-B/P/T/M series servo amplifiers have a 15 pole high density Sub-D female connector for the connection of an SFD feedback. Length definition: vvv=meters. Maximum cable length 50 m.

The cable shield is connected to the AKD-B/P/T/M via the connector housing.

The AKD-N series servo amplifiers have a round connector to connect an SFD feedback. On the motor end two connectors are available: standard Kollmorgen IP65 or y-tec connector for AKM1. Length definition: xx=meters, yy=centimeters. Maximum cable length 5 m.

The cable shield is connected to the AKD-N via the connector housing.

The motor feedback should be connected with pre-assembled cables from Kollmorgen.

Order codes for SFD cables, pre-assembled

Amplifier	(2x(2x0.25))	Order code	Length
AKD-B/P/T/M	SFD Cable IP65	CFS0A1-002-vvv-00	Steps of 1 m up to 50 m
AKD-B/P/T/M	SFD Cable y-tec	CFS0A3-002-vvv-00	Steps of 1 m up to 50 m
AKD-N-DF/DS	SFD Cable IP65	CFSNA1-002-xxmyy-00	0.1m steps from 0.2m to 1m,
AKD-N-DF/DS	SFD Cable y-tec	CFSNA3-002-xxmyy-00	0.25m steps from 1.25m to 5m

Define the required length in clear text.

11.12.3 Encoder cables

11.12.3.1 Encoder cables for S300/S400/S600/S700



All the standard motors in our range feature the same 17-pin connector for the encoder connection (EnDat, HIPERFACE, BiSS etc.). This connector is also used for the connections from the motor's thermal protection contact to the servo amplifier. The servo amplifiers have a Sub-D female connector for the connection of the encoder and the thermal protection contact. The cable shield is connected to the servo amplifier via the connector housing. The motor feedback should be connected with pre-assembled cables from Kollmorgen.

Order Codes Encoder cables, configured

Article	Cable Type	Cable Length	Order Code all encoders
Encoder cable	(7x(2x0.25))	5 m	DE-90287
Encoder cable	(7x(2x0.25))	10 m	DE-91019
Encoder cable	(7x(2x0.25))	15 m	DE-91811
Encoder cable	(7x(2x0.25))	20 m	DE-91807
Encoder cable	(7x(2x0.25))	25 m	DE-92205

Pinout and components

Up to a cable length of 50 m, use a shielded and sheathed cable with cores in twisted pairs (suggestion acc. to DIN 47100). Consult our customer support for cables longer than 50 m.

The following table shows the correlation between the individual types of encoder and the cable connections that are required:

Pin amplifier end	Pair #	Core color*	Pin motor end
1	1	WH	1
2	6	RD/BU	2
3	2	GN	3
4	6	GY/PK	4
5	3	GY	5
6	-	-	-
7	7	BN/GN	7
8	4	BU	8
9	1	BN	9
10	5	VT	10
11	2	YE	11
12	5	BK	12
13	3	PK	13
14	7	WH/GN	14
15	4	RD	15

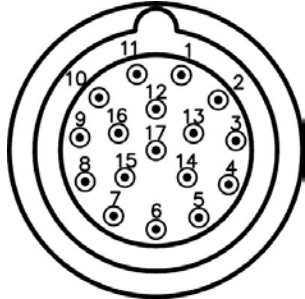

* to IEC 60757

Material list

Part	Description	Order code
Cable (cut to length)	LiYCY (TP) 7x2x0.25mm ²	DE-100904
Connector kit, motor end	EMC Connector, 17 poles	DE-85267
Washdown connector kit, motor end	EMC Connector 17 poles, stainless steel	DE-201820
Connector kit, amplifier end	Socket 15 poles, housing and screws	DE-103440

11.12.3.2 Encoder cables for AKD

All the standard motors in our range feature the same 17-pin connector for the encoder connection (EnDat, HIPERFACE, BiSS etc.). This connector is also used for the connections from the motor's thermal protection contact to the servo amplifier. The AKM1 motor optionally supports a 12 pin y-tec connector for Hiperface encoder only.



The AKD-B/P/T/M series servo amplifiers have a 15 pole high density Sub-D female connector for the connection of an encoder and the thermal protection contact. On the motor end two connectors are available: standard Kollmorgen IP65 or y-tec connector for AKM1. Maximum cable length 50m. Length definition: vvv=meters.

The cable shield is connected to the AKD-B/P/T/M via the connector housing.



The AKD-N series servo amplifiers have a round connector to connect an encoder feedback and the thermal protection contact. On the motor end two connectors are available: standard Kollmorgen IP65 or y-tec connector for AKM1. Maximum cable length 5m.

Length definition: xx=meters, yy=centimeters.

The cable shield is connected to the AKD-N via the connector housing.

The motor feedback should be connected with pre-assembled cables from Kollmorgen.

Order Codes Encoder cables, configured

Amplifier	(7x(2x0.25))	EnDat 2.2, BiSS C	Order codes		Length, Remarks
			EnDat 2.1, BiSS B	Hiperface	
AKD-B/P/T/M	Encoder cable IP65	CFD0A1-002- vvv-00	CFE0A1-002- vvv-00	CFH0A1-002- vvv-00	Steps of 1 m up to 50 m
AKD-B/P/T/M	Encoder cable y-tec	-	-	CFH0A3-002- vvv-00	Steps of 1 m up to 50 m
AKD-N	Encoder cable IP65	CFDNA1-002- xxmyy-00	CFENA1-002- xxmyy-00	CFHNA1-002- xxmyy-00	0.1 m steps from 0.2 m to 1 m,
AKD-N	Encoder cable y-tec	-	-	CFHNA3-002- xxmyy-00	0.25 m steps from 1.25 m to 5 m.

Define the required length in clear text.

11.12.4 ComCoder cables

11.12.4.1 ComCoder cables for S300/S400/S600/S700



All standard motors in our range feature the same 17-pin connector for the ComCoder connection. This connector is also used for the connections from the motor's thermal protection contact to the servo amplifier. The servo amplifiers have a Sub-D female connector for the connection of the ComCoder and the thermal protection contact. The cable shield is connected to the servo amplifier via the connector housing. The motor feedback should be connected with pre-assembled cables from Kollmorgen.

Order Codes Comcoder cables, configured

Article	Cable Type	Cable Length	Order Code
ComCoder cable	(8x(2x0.25))	5 m	DE-107915
ComCoder cable	(8x(2x0.25))	10 m	DE-107916
ComCoder cable	(8x(2x0.25))	15 m	DE-107917
ComCoder cable	(8x(2x0.25))	20 m	DE-107918
ComCoder cable	(8x(2x0.25))	25 m	DE-107919

Pinout and components

Up to a cable length of 25 m, use a shielded and sheathed cable with cores in twisted pairs (suggestion according to DIN 47100). Please consult our customer support for cables longer than 25 m.

Connection scheme

Pin amplifier end	Pair	Core color*	Pin motor end
1	1	WH	1
2	6	RD/BU	7
3	2	GN	3
4	6	GY/PK	10
5	3	GY	5
6	4	RD	15
7	7	BN/GN	8
8	4	BU	16
9	1	BN	2
10	5	VT	7
11	2	YE	4
12	5	BK	10
13	3	PK	6
14	7	WH/GN	9
15	8	WH/YE	17

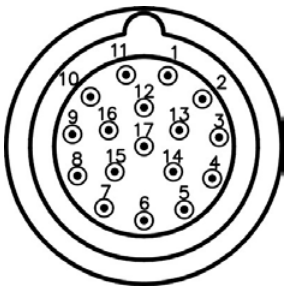

* to IEC 60757

Material list

Part	Description	Order code
Cable (cut to length)	LiYCY (TP) 8x2x0.25mm ²	DE-108012
Connector kit, motor end	EMC Connector, 17 poles	DE-85267
Washdown connector kit, motor end	EMC Connector 17 poles, stainless steel	DE-201820
Connector kit, amplifier end	Socket 15-poles, housing and screws	DE-103440

11.12.4.2 Comcoder cables for AKD

All the standard motors in our range feature the same 17-pin connector for the comcoder connection (incremental encoder with Hall sensors). This connector is also used for the connections from the motor's thermal protection contact to the servo amplifier.



The AKD-B/P/T/M series servo amplifiers have a 15 pole high density Sub-D female connector for the connection of a ComCoder and the thermal protection contact. Length definition: vvv=meters. Maximum cable length 25 m.

The cable shield is connected to the AKD-B/P/T/M via the connector housing.



The AKD-N series servo amplifiers have a round connector to connect a ComCoder and thermal protection contact. On the motor end one connector is available: standard Kollmorgen IP65 connector. Length definition: xx=meters, yy=centimeters. Maximum cable length 5 m.

The cable shield is connected to the AKD-N via the connector housing.

The motorfeedback should be connected with pre-assembled cables from Kollmorgen.

Order Codes ComCoder cables, configured

Amplifier	(8x(2x0.25))	Order code	Length
AKD-B/P/T/M	Comcoder cable IP65	CFC0A1-002-vvv-00	Steps of 1 m up to 25 m
AKD-N	Comcoder cable IP65	CFCNA1-002-xxmyy-00	0.1 m steps from 0.2 m to 1m, 0.25 m steps from 1.25 m to 5 m

Define the required length in clear text.

About KOLLMORGEN

Kollmorgen is a leading provider of motion systems and components for machine builders. Through world-class knowledge in motion, industry-leading quality and deep expertise in linking and integrating standard and custom products, Kollmorgen delivers breakthrough solutions that are unmatched in performance, reliability and ease-of-use, giving machine builders an irrefutable marketplace advantage.

For assistance with your application needs, visit www.kollmorgen.com or contact us at:

North America

KOLLMORGEN

203A West Rock Road
Radford, VA 24141 USA

Web: www.kollmorgen.com

Mail: support@kollmorgen.com

Tel.: +1 - 540 - 633 - 3545

Fax: +1 - 540 - 639 - 4162

Europe

KOLLMORGEN Europe GmbH

Pempelfurtstraße 1
40880 Ratingen, Germany

Web: www.kollmorgen.com

Mail: technik@kollmorgen.com

Tel.: +49 - 2102 - 9394 - 0

Fax: +49 - 2102 - 9394 - 3155

Asia

KOLLMORGEN

Rm 2205, Scitech Tower, China
22 Jianguomen Wai Street

Web: www.kollmorgen.com

Mail: sales.asia@kollmorgen.com

Tel.: +86 - 400 666 1802

Fax: +86 - 10 6515 0263

KOLLMORGEN[®]

Because Motion Matters™