

Accessories for digital drive systems with AKD[®] and AKD[®]2G

Manual



Edition: November 2019
Translation of the original document
European Version (CE region)



For safe and proper use, follow these instructions. Keep for future use.

Record of Document Revisions

Edition	Comments
...	Table with lifecycle information of this document see (→ # 67)
10/2017	AKD-N cables: references to AKM1 removed, recommended cable types (AC, RBext, DC-Bus) corrected, reference to safe Stemann slip rings added
02/2018	AKD-N heat sink 40 mm removed, Trademark list added, SpeedTec spelling corrected
11/2019	Warning notes layout updated, user expertise updated, new readers note cover page, cable section updated, AKD2G accessories added, AKM2G cables added, AKD-N connector tool, new section mating connectors / adapters

Trademarks

- AKD is a registered trademark of Kollmorgen Corporation.
- EnDat is a registered trademark of Dr. Johannes Heidenhain GmbH.
- EtherCAT is a registered trademark and patented technology, licensed by Beckhoff Automation GmbH, Germany.
- EtherCAT and Safety over EtherCAT are registered trademarks and patented technologies, licensed by Beckhoff Automation GmbH, Germany.
- Ethernet/IP is a registered trademark of ODVA, Inc.
- Ethernet/IP Communication Stack: copyright (c) 2009, Rockwell Automation.
- sercos® is a registered trademark of sercos® international e.V.
- HIPERFACE is a registered trademark of Max Stegmann GmbH.
- PROFINET is a registered trademark of PROFIBUS and PROFINET International (PI).
- SIMATIC is a registered trademark of SIEMENS AG.
- SpeedTec is a registered trademark of TE Connectivity Industrial GmbH.
- Windows is a registered trademark of Microsoft Corporation.

Technical changes which improve the performance of the device may be made without prior notice!

This document is the intellectual property of Kollmorgen. All rights reserved. No part of this work may be reproduced in any form (by photocopying, microfilm or any other method) or stored, processed, copied or distributed by electronic means without the written permission of Kollmorgen.

1 Table of Contents

1 Table of Contents	3
2 General	7
2.1 About this manual	7
2.2 Hints for the online edition (PDF format)	7
2.3 Symbols Used	7
2.4 Safety Notes	8
3 Digital Drive Systems	9
3.1 Drive System with AKD-x00306...02406	9
3.2 Drive System with AKD-x00307...02407	10
3.3 Drive System with AKD-x04807	11
3.4 Decentralized Drive System with AKD-C and AKD-N	12
3.5 Drive System with AKD2G-Sxx-6VxxD	13
3.6 Drive System with AKD2G-Sxx-7VxxD	14
4 Mechanical Accessories	15
4.1 Mounting Kit for AKMH Motors	15
4.2 Suspension Unit for AKM motors	15
4.3 Fan Kit for AKM7 motors	16
4.4 Mechanical accessories for AKD-N and AKD-C	17
4.4.1 Heat Sink for AKD-N	17
4.4.2 Mounting clamps for AKD-N	18
4.4.3 Sealing plugs for AKD-N connectors	18
4.4.4 Cabinet grommets	18
4.4.5 Slip rings	18
4.4.6 Connector Screwing Tool for AKD-N	19
4.5 Shield clamps	19
5 Mating connectors and Adapters	20
5.1 Connectors for AKD-B/P/T/M	20
5.2 Connectors for AKD-C	21
5.3 Connectors for AKD-N	21
5.4 Connectors for AKD2G	22
5.5 SDB Module for AKD2G	22
5.6 SFA (Smart Feedback Adapter) for AKD2G	23
6 Mains chokes	24
6.1 General	24
6.2 Important notes	24
6.3 Type assignment and order codes	24
6.4 Mains choke 3L	25
7 Mains filters	26
7.1 General	26
7.2 Important notes	26
7.3 Type assignment and order codes	26
7.4 Mains filters 1NF-10...12	27
7.5 Mains filters 1NF-20B, 1NF-25	28
7.6 Mains filters 3NF-07...30	29
7.7 Mains filters FN2090	30
7.8 Mains filters FN3288	31
8 Regen resistors (brake resistors)	32
8.1 General	32
8.2 Important notes	32
8.3 Type assignment and order codes	33

8.4 External regen resistor BAFP(U)	34
8.5 External regen resistor BAR(U)	35
8.6 External regen resistor BAS(U)	36
9 Capacitor Modules	37
9.1 General	37
9.2 Important notes	37
9.3 Type assignment and order codes	38
9.4 Example installation	38
9.5 KCM Module	39
10 Motor chokes	40
10.1 General	40
10.2 Important notes	41
10.3 Type assignment and order codes	41
10.4 Motor choke 3YLN-xx	42
11 Cables	43
11.1 Technical data for cables	43
11.2 Tools	43
11.3 PC connection	43
11.4 Power Voltage Supply, external regen resistor, DC bus link	44
11.4.1 Recommended cable type	44
11.4.2 Mating connector	44
11.5 24V auxiliary voltage supply	44
11.5.1 Recommended cable type	44
11.5.2 Mating connector	44
11.6 Digital/analog Inputs/Outputs	45
11.6.1 Digital In/Outputs for AKD-C	45
11.6.2 Digital I/O cable for AKD-N	45
11.6.3 STO cable for AKD-N-DS/DT	45
11.6.4 Fieldbus cable for AKD-N-DF/DG	46
11.6.5 Digital/analog I/O for AKD-B/P/T/M and AKD2G	46
11.7 Encoder Emulation, Stepper motor control, Master-Slave	47
11.7.1 Mating connector, cable type	47
11.7.2 Connection	47
11.8 Ethernet cable	47
11.9 CAN bus cable	48
11.10 AKD-C/N String Cables	49
11.10.1 String cable AKD-C to AKD-N	49
11.10.2 String cable AKD-N to AKD-N	50
11.11 AKM Cables	51
11.11.1 AKD-N to AKM single (hybrid) motor cables	51
11.11.2 AKD-N to AKM motor power cables	52
11.11.3 AKD-N to AKM motor feedback cables	53
11.11.3.1 SFD feedback cables AKD-N-DF/DS to AKM Motors	53
11.11.3.2 Encoder/ComCoder feedback cables AKD-N-DF/DS to AKM Motors	54
11.11.4 AKD-B/P/T/M to AKM single (hybrid) motor cables	55
11.11.4.1 AKD-B/P/T/M to AKM-1 Motor	55
11.11.4.2 AKD-B/P/T/M to AKM-2...6	56
11.11.5 AKD-B/P/T/M to AKM motor power cables	58
11.11.5.1 AKD-B/P/T/M (shield clamp) to AKM-1	58
11.11.5.2 AKD-B/P/T/M (shield clamp) to AKM-1...7, up to 22A	59
11.11.5.3 AKD-B/P/T/M (shield plate) to AKM-1...7, up to 22A	60
11.11.5.4 AKD-B/P/T/M-024 (shield plate) to AKM-7...8, more than 22A	61
11.11.5.5 AKD-B/P/T/M-048 (shield plate) to AKM-7...8, more than 22A	61
11.11.6 AKD-B/P/T/M to AKM motor feedback cables	62

11.11.6.1 Resolver feedback cables	62
11.11.6.2 SFD feedback cables	63
11.11.6.3 Encoder/ComCoder feedback cables	64
11.12 AKM®2G Cables	65
12 Record of Document Revisions	67

-- / --

2 General

2.1 About this manual

This manual describes accessories for Kollmorgen AKD drives. It contains essential technical data. The manual is only valid in conjunction with the instructions manual for the drive and servo motor you are using in your application.

You will find copies of the instructions manual for Kollmorgen drives and servo motors on the CD ROM included in the scope of supply and on our Internet site. The documents are available in Acrobat Reader format in multiple languages (system requirements: WINDOWS, Internet browser, Acrobat Reader).

More detail information can be found in the "Kollmorgen Developers Network" available at kdn.kollmorgen.com.









2.2 Hints for the online edition (PDF format)

Bookmark: Table of contents and index are active bookmarks.

Table of contents and index in the text: The lines are active cross references. Click on the desired line and the appropriate page is indicated.

Page/chapter numbers in the text: Page/chapter numbers with cross references are active. Click at the page/chapter number to reach the indicated target.

2.3 Symbols Used

Symbol	Indication
	Indicates a hazardous situation which, if not avoided, will result in death or serious injury.
	Indicates a hazardous situation which, if not avoided, could result in death or serious injury.
	Indicates a hazardous situation which, if not avoided, could result in minor or moderate injury.
	Indicates situations which, if not avoided, could result in property damage.
	This symbol indicates important notes.
	Warning of danger from electricity and its effects.
	Warning of danger from hot surface.
	Warning of danger from suspended loads.
	Warning of danger from automatic start.

2.4 Safety Notes

This section helps you to recognize and avoid dangers to people and objects.

Read the documentation!

Read the available documentation before installation and commissioning. Improper handling of the devices can cause harm to people or damage to property. The operator must therefore ensure that all persons entrusted to work on the devices have read and understood the manual and that the safety notices in this manual are observed.

Always observe the whole drive system built with drive, cables, motor, accessories (filters, chokes, etc.). This means, that all documentation which exist for the components, must be available, must be read and must be understood.

Pay attention to the technical data!

Adhere to the technical data and the specifications on connection conditions (rating plate and documentation). If permissible voltage values or current values are exceeded, the devices can be damaged, e.g. through overheating.

Specialist staff required!

Only properly qualified personnel are permitted to perform such tasks as transport, installation and setup. Qualified specialist staff are persons with expertise in transport, installation, assembly, commissioning and operation of electrotechnical equipment.

- Transport, storage, unpacking: only by personnel with knowledge of handling electrostatically sensitive components.
- Mechanical installation: only by personnel with mechanical expertise.
- Electrical installation: only by personnel with expertise in electrical engineering.
- Basic tests / setup: only by personnel with expertise in electrical engineering and drive technology.

The qualified personnel must know and observe ISO 12100 / IEC 60364 / IEC 60664 and national accident prevention regulations.

Additional requirements on specialist staff may also result from the risk assessment.

Hot surface!

Some devices can reach temperatures of up to 250°C during operation. Touching them can result in burns. Observe the permissible mounting position and ensure that a sufficient distance is maintained from neighboring assemblies.



Earthing!

It is vital that you ensure that the device housing is safely earthed to the PE (protective earth) busbar in the switch cabinet. Without low-resistance earthing no personal protection can be guaranteed and there is a risk of death from electric shock.



High voltages!

Keep the switching cabinet closed when the equipment is in operation. Not having optical displays does not guarantee an absence of voltage. Power connections may carry voltage even if the motor is not turning.

Do not unplug any connectors during operation. There is a risk of death or severe injury from touching exposed contacts. Power connections may be live even when the motor is not rotating. This can cause flashovers with resulting injuries to persons and damage to the contacts.

DC Bus link connections can carry dangerous voltage levels over an hour after the line voltage has been switched off (self-discharge time). Danger of death from electric shock.

Before commencing work on the modules' power terminals, check the voltage at the connection terminals is de-energized to ground and to each other.



3 Digital Drive Systems

The systems shown are simply a possible scenario for setting up a digital drive system with relevant drive components.

3.1 Drive System with AKD-x00306...02406

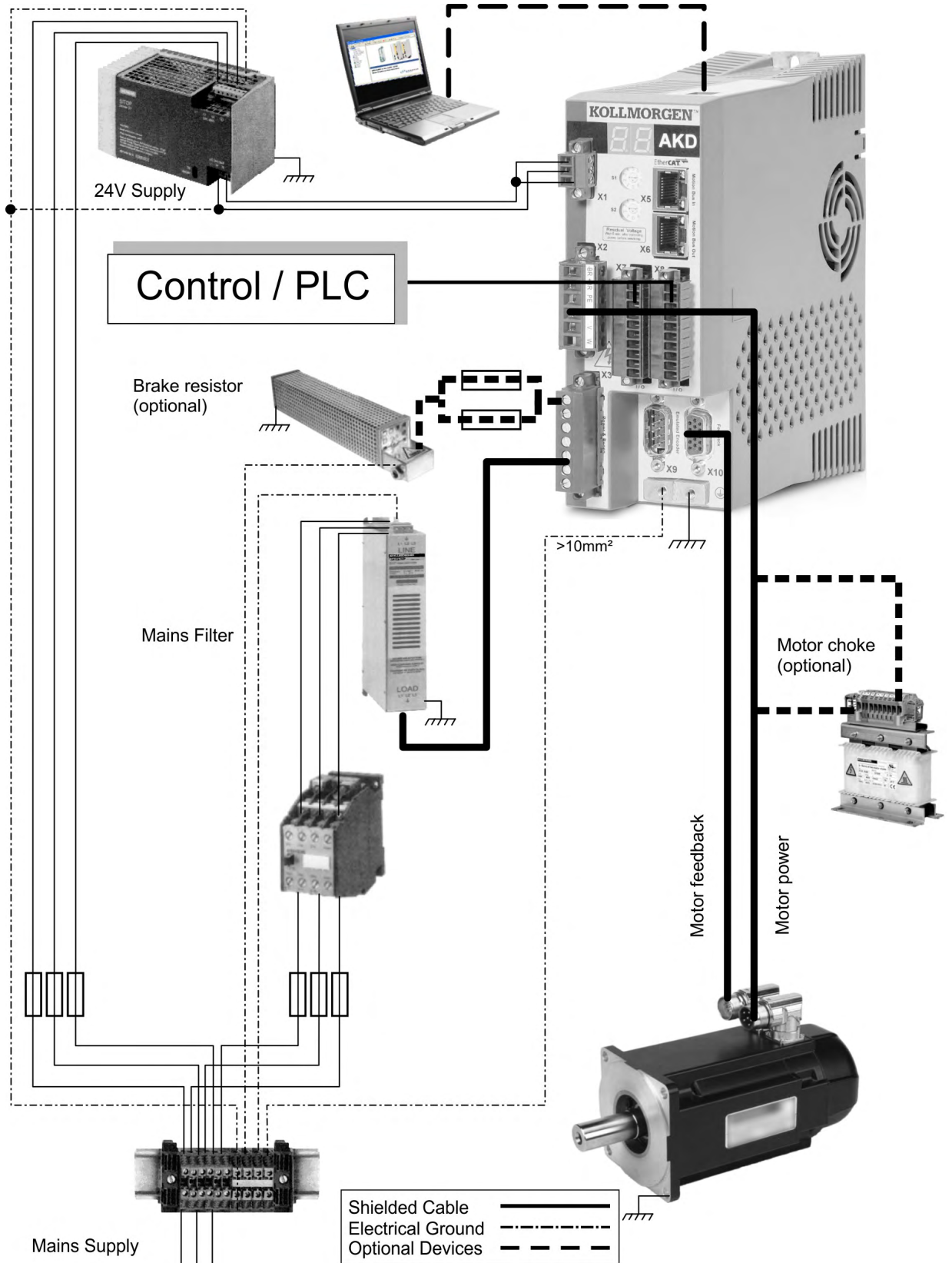

3.2 Drive System with AKD-x00307...02407

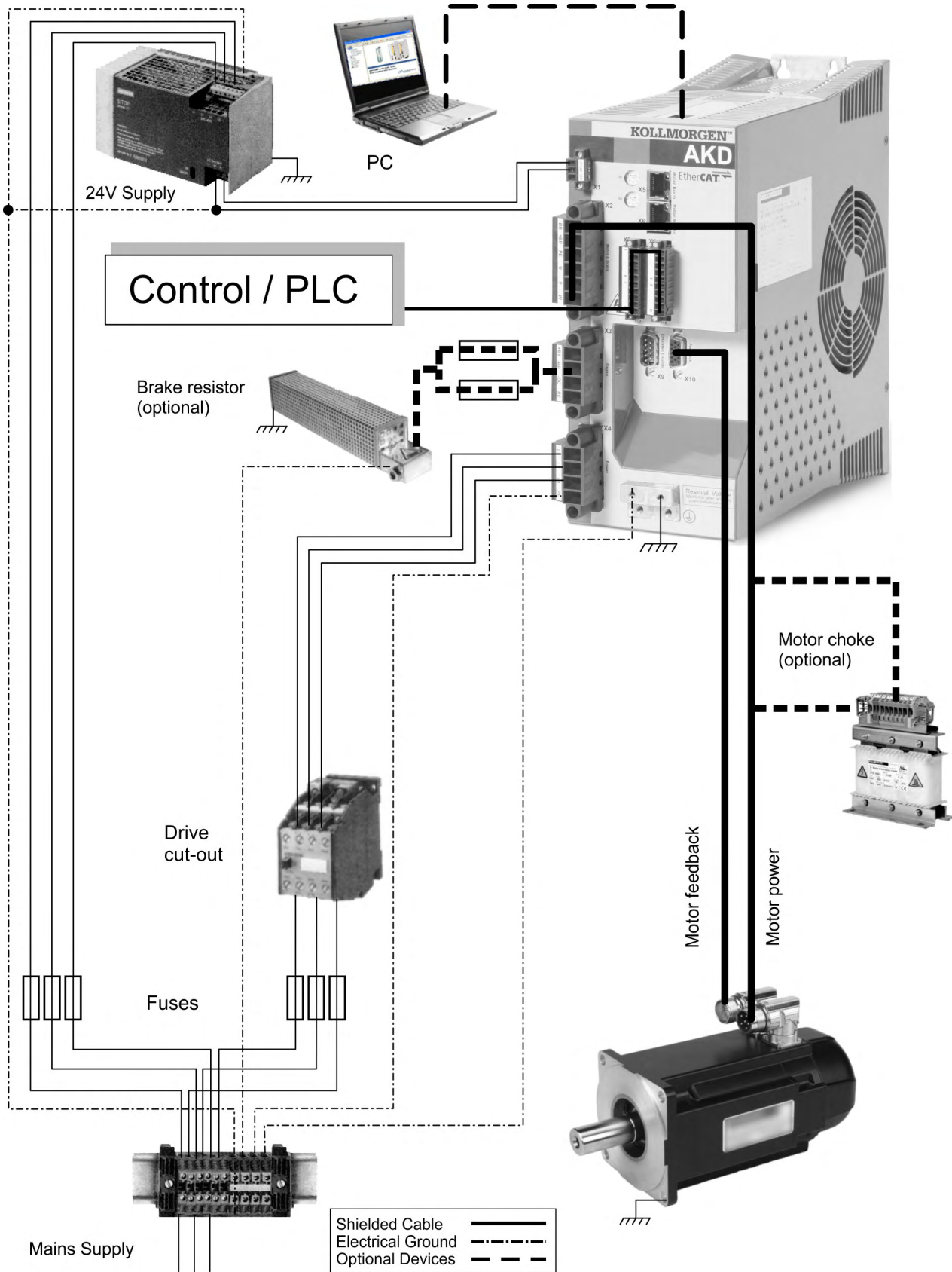

3.3 Drive System with AKD-x04807

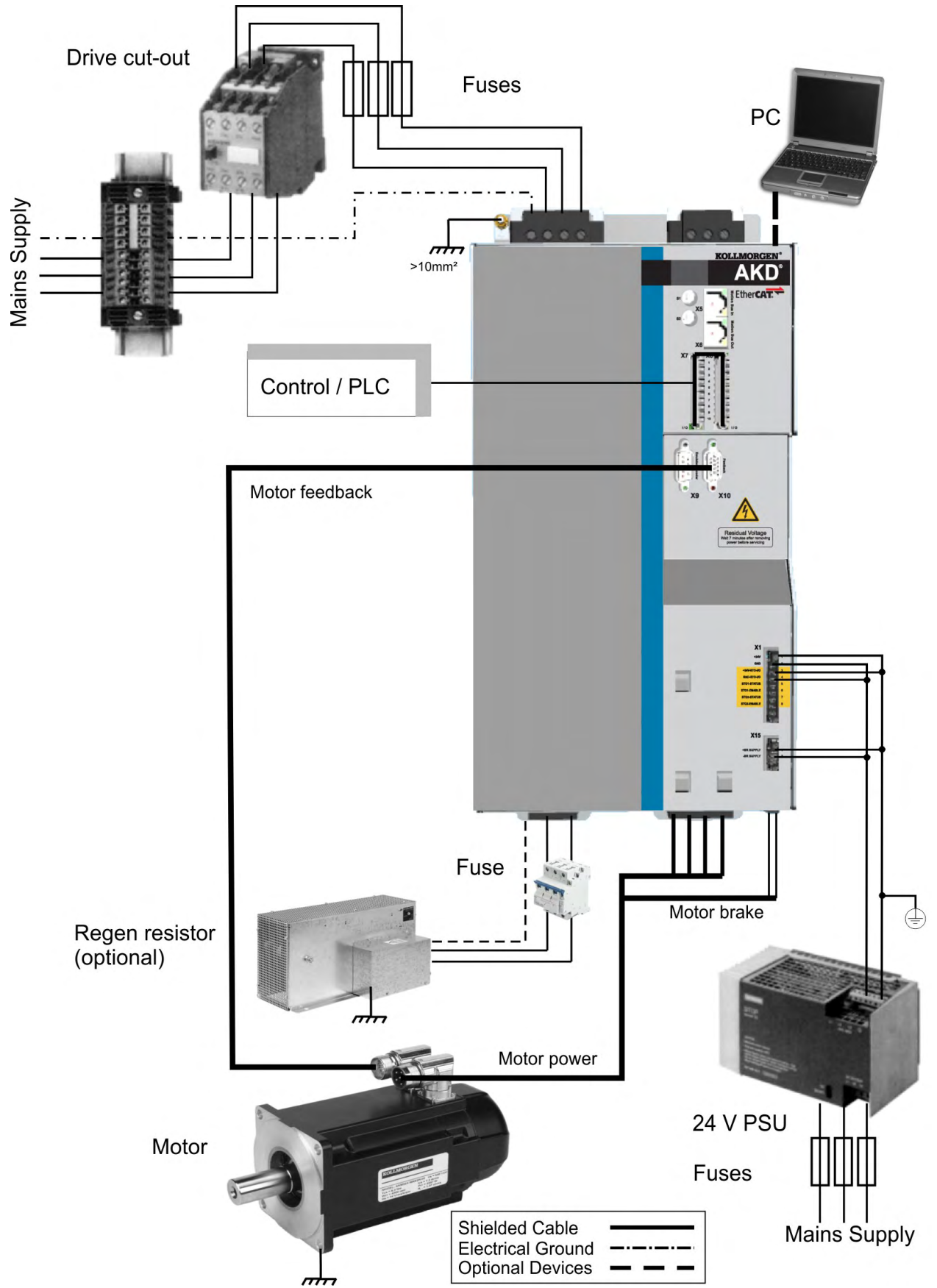

3.4 Decentralized Drive System with AKD-C and AKD-N

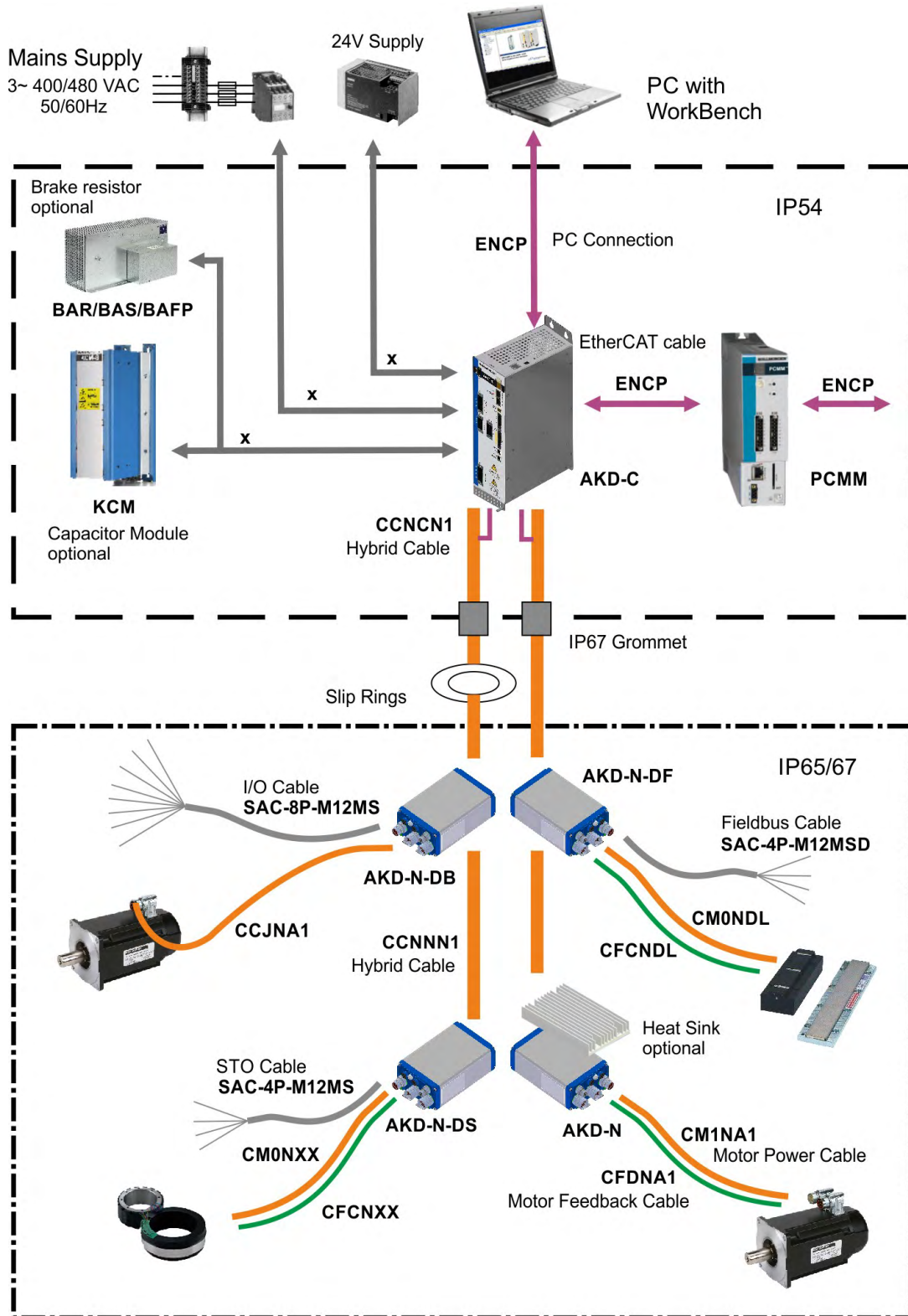

All components inside the borders are supplied by Kollmorgen with the exception of cables signed with "x". These cables are not supplied by Kollmorgen, you should use cables or wires according to EN 60204.

3.5 Drive System with AKD2G-Sxx-6VxxD

Example with single and dual cable motor connection on a dual axes 120 V to 240 V drive with functional safety option 2. The number of available axes depend on the drive variant.

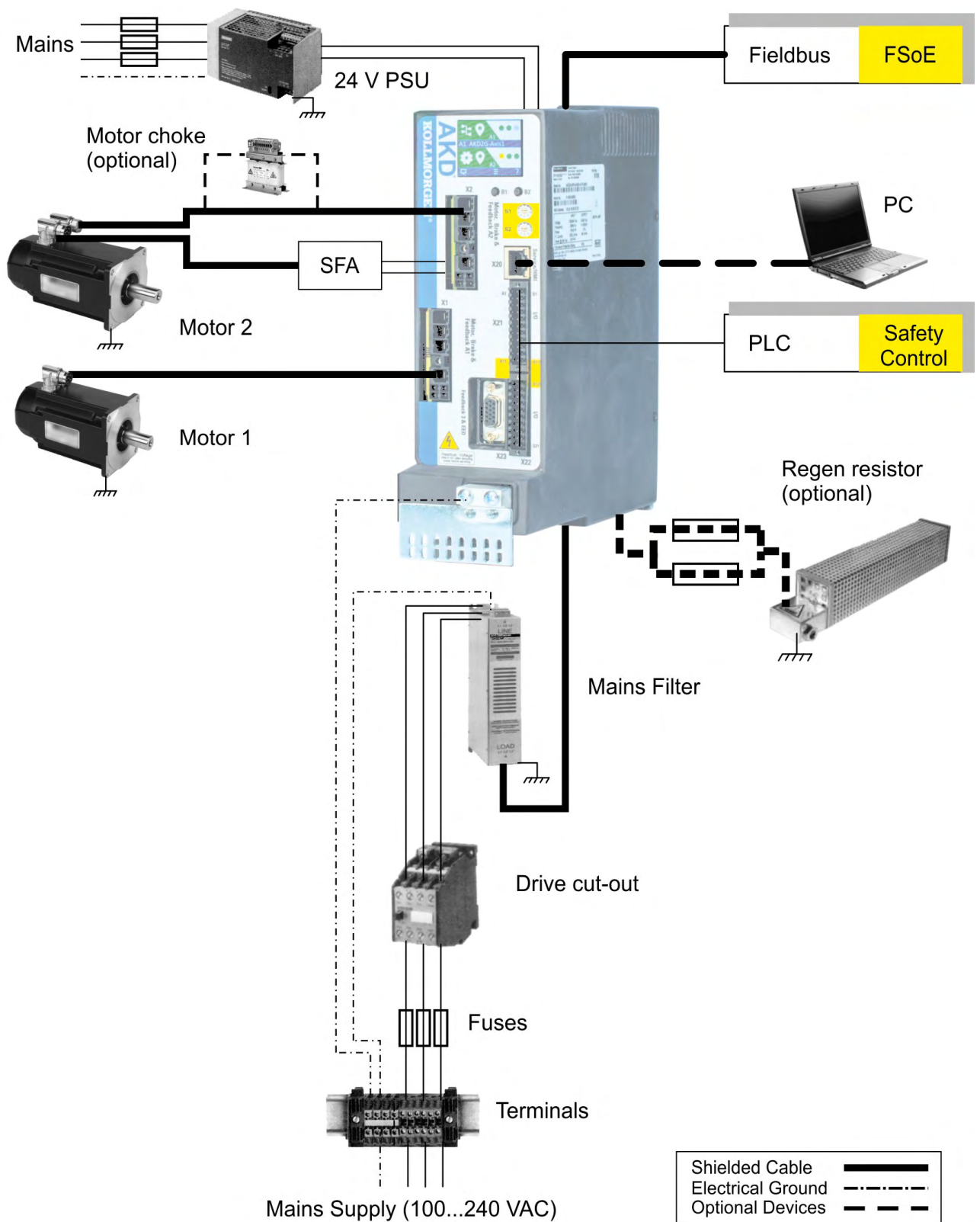

3.6 Drive System with AKD2G-Sxx-7VxxD

Example with single and dual cable motor connection on a dual axes 240 V to 480 V drive with functional safety option 2. The number of available axes depend on the drive variant.

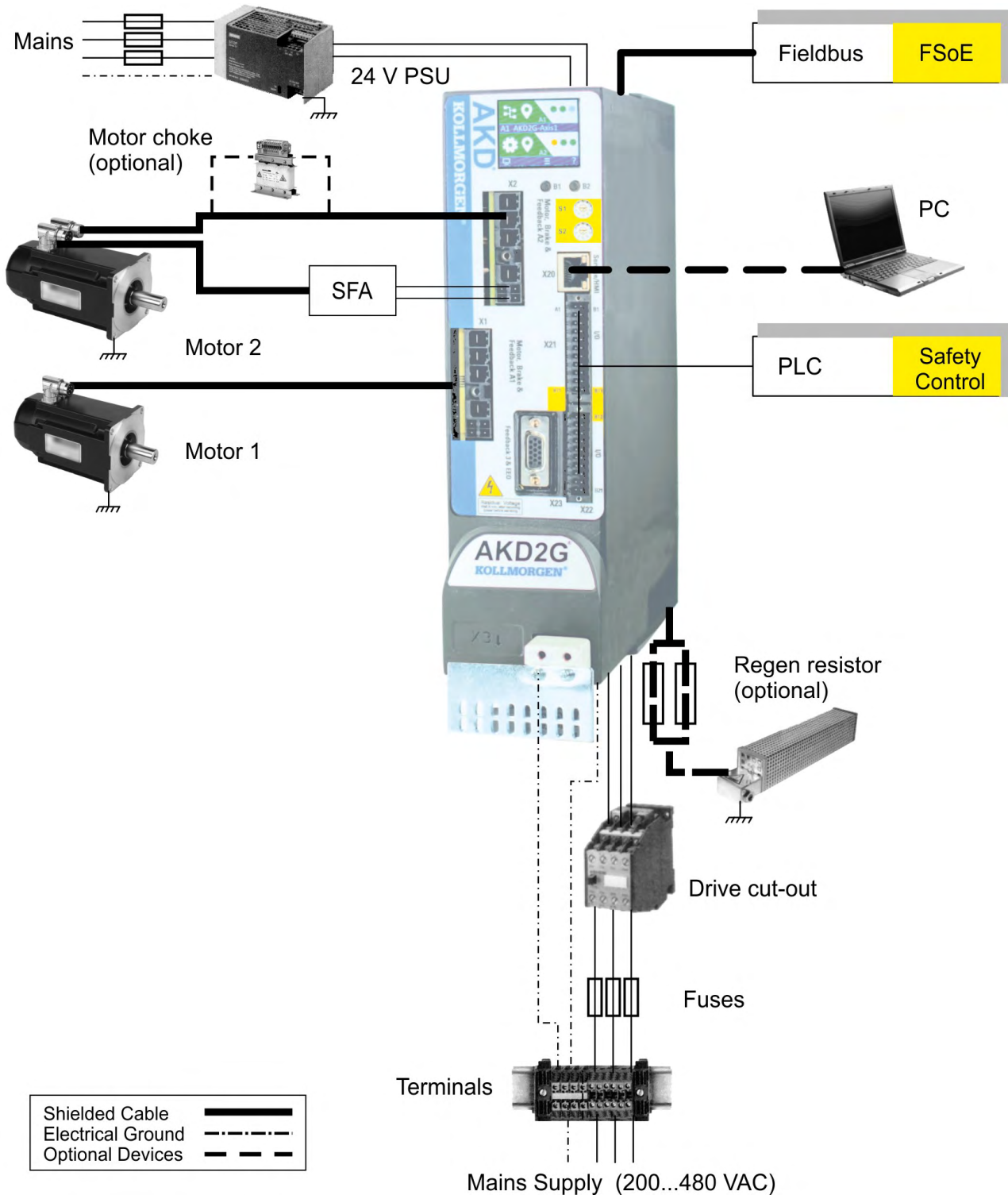

4 Mechanical Accessories

4.1 Mounting Kit for AKMH Motors

IEC mounting kits with 1 shaft center screw and 4 flange screws. Hygienic mounting is possible only with these screws.

Description	Order Code
Mounting Hardware AKMH2, Ax flange / Cx front mounting	MTG-KIT-AKMH2-IEC
Mounting Hardware AKMH3, Ax flange / Cx front mounting	MTG-KIT-AKMH3-IEC
Mounting Hardware AKMH4, Ax flange / Cx front mounting	MTG-KIT-AKMH4-IEC
Mounting Hardware AKMH5, Ax flange / Cx front mounting	MTG-KIT-AKMH5-IEC
Mounting Hardware AKMH6, Ax flange / Cx front mounting	MTG-KIT-AKMH6-IEC

NEMA mounting kits are described in the US selection guide, available from the Kollmorgen website (www.kollmorgen.com).

4.2 Suspension Unit for AKM motors



WARNING Suspended load!

Risk of death if load falls.

- Never step under the load, while the motor is raised!

NOTICE

You must read the instructions manual for the suspension unit ZPMZ 120/292. Observe the "safety instructions" and "use as directed" hints before starting transportation work.

The Suspension Unit ZPMZ 120/292 is designed for suspended handling exclusively of motors (i.e., without attached units such as gearboxes, clutches, etc.) with a maximum weight of 120 kg and maximum nominal span of the extreme suspension hooks of 292 mm.

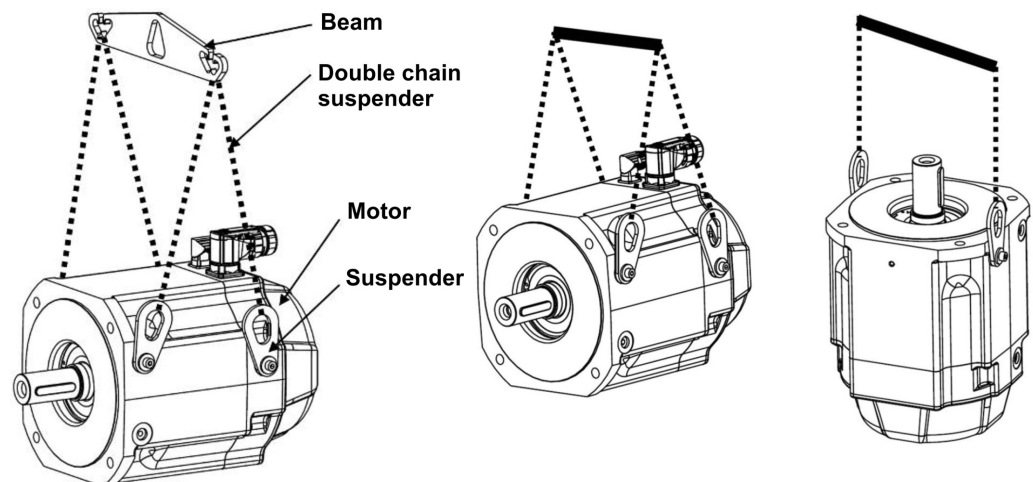

The suspended unit consists of a Beam, suspended off the crane hook and two double-run chain suspenders. The motor may be borne on two or four runs of the chain suspender.

The suspenders (number depends on the motor type) are delivered with the motor.

Technical Data				
Lifting capacity	120 kg		Weight	0,83 kg
Nominal span	292 mm		Number of cycles a year	20.000
Lug width	44,7 mm		Average load	60 %
Lug height	51 mm		Order code	FA00092

4.3 Fan Kit for AKM7 motors

NOTICE

Observe the mounting instructions delivered with the fan kit. The fan housing can be mounted either with both the supplied brackets and spacers or with the brackets only. The choice of mounting method depends on the application. If strong vibrations are expected, you should use both brackets and spacers. Motors with integrated brakes require the long spacers.

Mounting the fan kit enlarges the motor by approximately 65 mm. The detailed final dimensions of AKM7 motors with mounted fan kit can be found in the instructions manual of the AKM motor series. Ventilation of AKM7 motors allow increased current of the motors. This higher current usually requires larger wiring cross section compared to not ventilated motors. The necessary data for current and wiring cross section can be found in the technical data section of the AKM instructions manual.

Technical Data	
Supply voltage	24 VDC
Supply current	270 mA
Electrical power	6.5 W
Surface	Coated with polyester powder coating in matt black, not resistant against solvents
Protection class	IP 20
Connection	Cable gland 10 mm, cable diameter 4 mm to 6 mm, recommended cable 3x0.75 mm ² (not part of delivery)
Terminals	0.33 mm ² to 4 mm ²
Weight	2.52 kg
Order code	AKM7-FAN

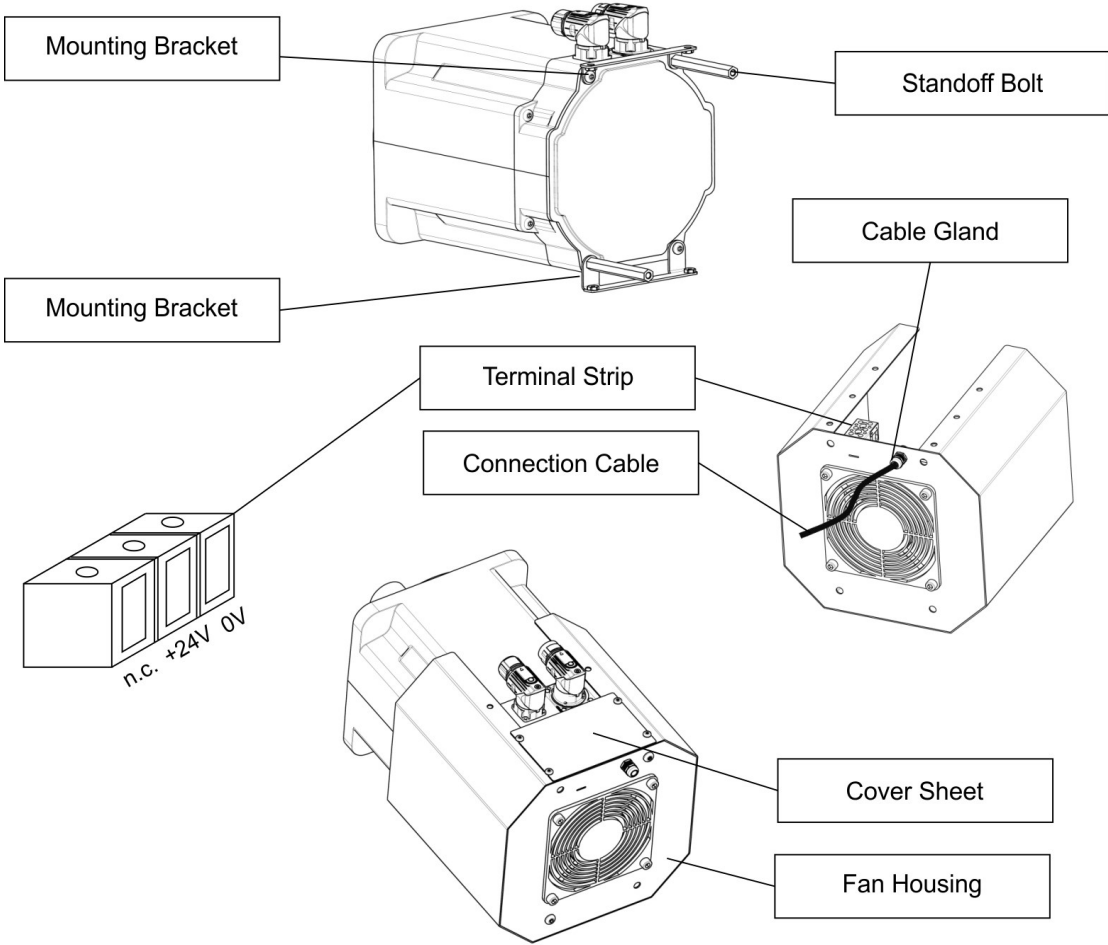

4.4 Mechanical accessories for AKD-N and AKD-C

NOTICE

You must read the AKD-N/AKD-C installation manuals. Observe the safety instructions given there before commencing mounting/installation work.

4.4.1 Heat Sink for AKD-N

When mounting AKD-N to the machinery, temperature management is important to ensure maximum performance of the drive system. In case of bad cooling situation (as described in the AKD-N Installation Manual), you can mount a heat sink to the AKD-N.

Heat flow is optimized by a heat conducting film, which must be placed between heat sink and AKD-N.

Mounting holes in the heat sink and winding holes in the AKD-N are prepared for M4x16 hexagon socket screws to ISO 4762. Use a 3 mm T-handle Allen key for mounting.

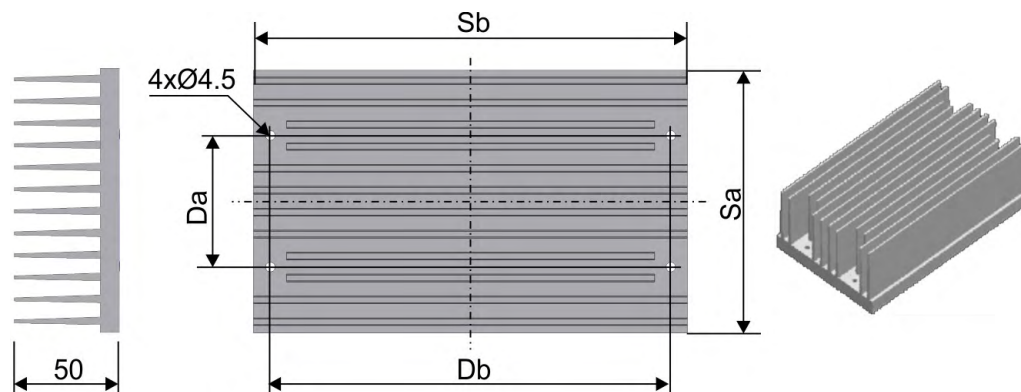

Figure similar to reality.

Usable for	Outer dimensions			Drill dimensions	
	Sa / mm	Sb / mm	Height / mm	Drill Da / mm	Drill Db / mm
AKD-N003/006	120	200	50	60	184.4
AKD-N012	120	250	50	60	234.4

Order Codes

Article	Usable for	Order codes
Heat sink Kit 50 mm with heat conducting film and 4 screws M4x16	AKD-N003/006	AKD-N 3,6 HEATSINK KIT 50MM
Heat sink Kit 50 mm with heat conducting film and 4 screws M4x16	AKD-N012	AKD-N 12 HEATSINK KIT 50MM
Heat conducting film	AKD-N003/006	849-373001-04
Heat conducting film	AKD-N012	849-374001-04

4.4.2 Mounting clamps for AKD-N

The AKD-N drive is mounted to the machine with special mounting clamps. The delivery package contains 4 clamps. In case of lost or damaged clamps, you can order a set of four clamps.

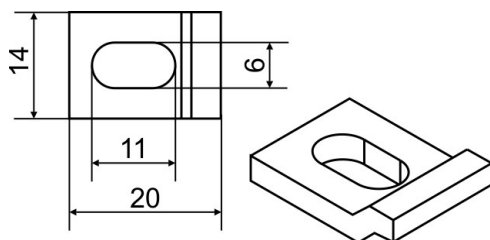

Order Codes

Article	Order codes
AKD-N Mounting Clamps Set, 4 clamps	AKD-N-M/C-Set

4.4.3 Sealing plugs for AKD-N connectors

The sealing plugs in the delivery package are screwed to unused AKD-N connectors to ensure the IP class for the machine environment. In case of lost plugs, you can order a set with 3 different plug sizes.



Order Code

Article	Order Codes
AKD-N Sealing Plug Set, 4xM12, 2xM23, 2xM17	AKD-N-S/P-Set

4.4.4 Cabinet grommets

The hybrid cable between AKD-C and the first AKD-N leads through the cabinet wall. To ensure IP67 protection class, Kollmorgen recommends cable entry system KDL/S combined with cable entry grommet KDT/S manufactured by Murrplastik Systemtechnik GmbH.

Please contact:

Murrplastik Systemtechnik GmbH

Fabrikstraße 10, D-71570 Oppenweiler, Germany

Phone: +49 (0)7191 482-0, Website: www.murrplastik.de, E-Mail: info@murrplastik.de

4.4.5 Slip rings

If AKD-N must be mounted on a rotary table, it is necessary to use slip ring assemblies for energy and data transfer between AKD-C in the cabinet and AKD-N on the rotary table. Kollmorgen cooperates with company STEMMANN-TECHNIK for user specific slip ring assembly solutions. Please contact:

STEMMANN-TECHNIK GmbH

Niedersachsenstraße 2, D-48465 Schüttorf, Germany

Phone: +49 (0)592381-0, Website: www.stemmann.com, E-Mail: sales@stemmann.de

The Safety Function STO has been tested with STEMMANN slip rings 6263576 and 6263577. These slip rings can be used as stand-alone modules or in a slip ring cassette.

4.4.6 Connector Screwing Tool for AKD-N



Tool for screwing the union nut of the AKD-N connectors.

Order Code

Article	Order Codes
Tool for M23 screw connection	AKD-N-TOOL-A

4.5 Shield clamps

NOTICE

You must read the instructions manuals for the drive/servo motor you are using in your application. Observe the safety instructions they contain before commencing mounting/installation work.



These drives feature slots on the front panel for the connection of additional shield clamps.

Article	Tension range	Order Codes
SK14	6-13mm	DE-108248

5 Mating connectors and Adapters

5.1 Connectors for AKD-B/P/T/M

Mating connectors are part of delivery (except SubD and RJ types). For spare parts see tables below.

Power connectors

Device	Description	Order Code
AKD-x00306/00606	Mating connector X2, motor, with shield clamp SK14	AKD-X2-SK14
AKD-x02406, AKD-x00307...02407	Mating connector X2, motor, with shield plate	AKD-X2+Shield-Kit
AKD-x00306/00606	Mating connector X3, mains, DC-Bus, Regen Resistor	CON- AKDX3A-SL
AKD-x01206	Mating connector X3, mains, DC-Bus, Regen Resistor	CON- AKDX3B-SL
AKD-x02406	Mating connector X4, mains	CON- AKDX3C-SL
AKD-x02406, AKD-x00307...02407	Mating connector X4, DC-Bus, Regen-R Mating connector X4 variant Y	CON- AKDX3C-S CON-AKDX3C-SL-Y
AKD-x04807	Mating connector X4, mains	CON- AKD4807X4-SL
AKD-x04807	Mating connector X14, DC-Bus Mating connector X14 variant Y	CON- AKD4807X14-SL CON-AKD4807X14-SL-Y
AKD-x04807	Mating connector X3, Regen-R	CON- AKD4807X3-SL

24 V supply and STO signals

Device	Description	Order Code
AKD all variants, 3A to 24A	Mating connector X1, 24V and STO	CON-AKDX1-SL
AKD all variants, 48A	Mating connector X1, 24V and STO	CON-AKD4807X1-SL

Digital I/O

Device	Description	Order Code
AKD all variants	Mating connector X7, I/O	CON-AKDX7-SL
	Mating connector X8, I/O	CON-AKDX8-SL
AKD-M	Mating connector X35, I/O	CON-AKDX35-SL
	Mating connector X36, I/O	CON-AKDX36-SL
Option IC	Mating connector X21, I/O Option	CON-AKDX21-SL
	Mating connector X22, I/O Option	CON-AKDX22-SL
	Mating connector X23, I/O Option	CON-AKDX23-SL
	Mating connector X24, I/O Option	CON-AKDX24-SL

Feedback

Device	Description	Order Code
AKD all variants	Connector kit with X10 male connector 15 pin high density, X9 female connector 9 pin, 2 housings, screws	AKD-X9+X10-Kit

CAN

Device	Description	Order Code
AKD all variants	CAN Termination connector	AKD-CAN-Termination
AKD all variants	CAN RJ12->SubD9 adapter	AKD-CAN-RJ12-SubD9

5.2 Connectors for AKD-C

Mating connectors X12, X13, X14, X15, and X16 are part of delivery. If a mating connector is lost or damaged, you can order the AKD-C Connector Kit.

Connector Kit

Device	Description	Order Code
AKD-C	Connector Kit, included mating connectors X12, X13, X14, X15, and X16	AKD-C-CONKIT
AKD-C	Connector Kit, included one mating connector with shield plate for X20A or X21A	CON-AKD-CX20/21A-SLA

5.3 Connectors for AKD-N

We do not offer mating connectors for motor power, feedback, hybrid or string cables. If these connectors are damaged, a new Kollmorgen cable must be used, see (→ # 49) and following.

Digital I/O connection

Kollmorgen recommends partly configured Phoenix SAC cables.

Device	Description	Order Code
AKD-N all variants	M12 mating connector for X3, 5 m cable, unconfigured wires	SAC-8P-M12MS (Phoenix Contact)

STO connection

Kollmorgen recommends partly configured Phoenix SAC cables.

Device	Description	Order Code
AKD-N-DS/DT	M12 mating connector for X6, 5 m cable, unconfigured wires, A coded	SAC-4P-M12MS (Phoenix Contact)

Feldbus connection

Kollmorgen recommends partly configured Phoenix SAC cables.

Device	Description	Order Code
AKD-N-DF/DG	M12 mating connector for X6, 5 m cable, unconfigured wires, D coded	SAC-4P-M12MSD/5,0 (Phoenix Contact)

Jump-X5 connector for AKD-N-DS/DF with single cable connection

For sufficient voltage supply of the digital feedback systems Hiperface DSL or SFD3 connected to AKD-N-DS/DF connector X4, a dongle must be plugged to X5.

Device	Description	Order Code
AKD-N-DS/DF, single cable	X5 mating connector with jumper 4-5	AKD-N-JUMP-X5

5.4 Connectors for AKD2G

Mating connectors are **not** included in the package of a standard AKD2G.

Mating connectors are included when the AKD2G is ordered with accessories (append “-A” to the model number).

Mating connectors listed below are never delivered with the drive. These mating connectors are usually part of the cables:

- Motor mating connector (X1, X2),
- SubD (X23, X41) for Feedback,
- RJ25 (X13, X14) for CAN-Bus, and RJ45 (X11, X12, X20) for Service and Fieldbus.

Connector Kits

Article	Order Code
X3, X10, X21 connectors	AKD2G-CONKIT
X3, X10, X21, X22 connectors	AKD2G-CONKIT+X22
X3, X10, X21, X22, X4, X5 connectors	AKD2G-CONKIT+X22+X4+X5

Connectors

Article	Order Code
X1/X2 connector - hybrid power/feedback	AKD2G-CON-X1/X2
X10 connector - 24 VDC	AKD2G-CON-X10
X10 T-connector - 24 VDC	AKD2G-CON-X10T
X21 connector - I/O	AKD2G-CON-X21
X22 connector - I/O	AKD2G-CON-X22
X3 connector - Mains/DC Link/Regen Resistor	AKD2G-CON-X3
X3 T-connector - Mains/DC Link/Regen Resistor	in process
X4 connector - second brake	AKD2G-CON-X4
X5 connector - second feedback	AKD2G-CON-X5

5.5 SDB Module for AKD2G

If the motor brake allows standstill braking only (no mechanical operation brake available), dynamic braking is a method to slow down a servo axis by dissipating the mechanical energy driven by the motor back EMF. When activated, the external Safe Dynamic Brake Module (SDB-Module) shorts the motor terminals. This forces all of the dynamic braking current to be stopping current. While the lines to the motor are shorted, the SDB status signal will be applied.

Suggestions for usable SDB Modules to be determined. Contact Kollmorgen please.

5.6 SFA (Smart Feedback Adapter) for AKD2G

The AKD2G servo drive is optimized for single hybrid cable technology using HIPERFACE DSL or SFD3 feedback options. For using a conventional feedback, Kollmorgen offers the Smart Feedback Adapter (SFA).

SFA can be laid into the cable duct or may be mounted to a DIN rail using a DIN rail clip. For X41 pinout and wire color coding refer to the AKD2G Installation Manual.

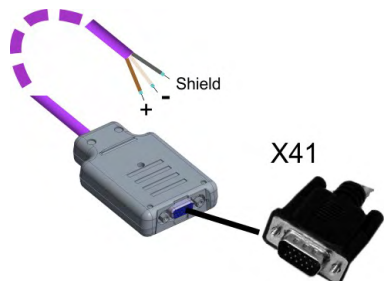

- X41 Sub-D high density 15 pin, female.
- 1 m shielded cable with 3 flying leads.
- Input for conventional feedback systems.
- Input for electronic gearing.
- Output for encoder emulation.
- Connected device must be set in Work-bench.
- Use Kollmorgen feedback cables.

SFA dimensions:

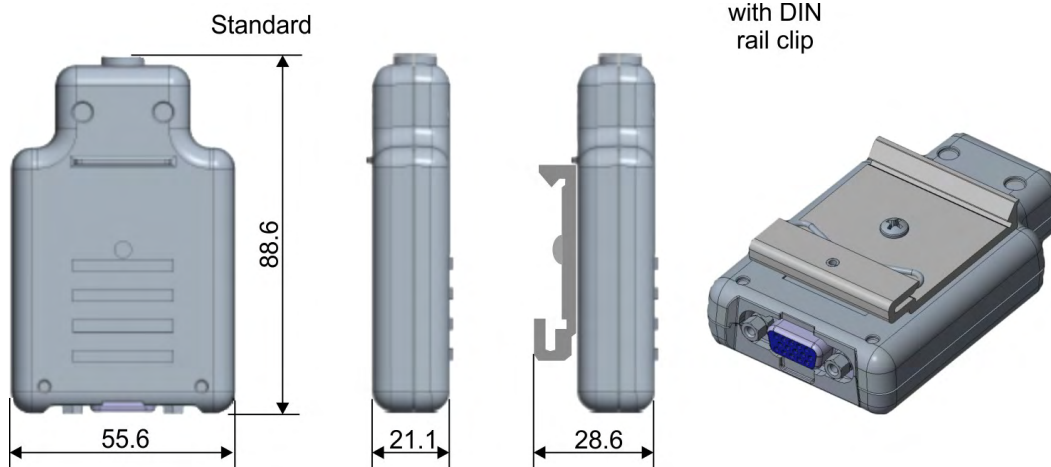

Order code

Article	Order Code
Smart Feedback Adapter (SFA), cable length 1 m	AKD2G-CON-SFA-000
Smart Feedback Adapter (SFA), cable length 1 m, with mounted DIN rail clip	AKD2G-CON-SFA-000-D

6 Mains chokes

NOTICE

You must read the instructions manuals for the drive and servo motor you are using in your application. Observe the safety instructions given there.

6.1 General

In special cases, if mains voltage is more than 3% asymmetrical, then the AKD-48A must be used with a mains choke. In unfavorable combination of mains impedance and DC bus capacitance the unloaded DC bus may reach voltage up to 800V without choke. For EMC reasons the chokes should be mounted isolated to the cabinet. Single conductors can be used for wiring, shielded cables are not required. Purpose of mains choke:

- Prevents impermissible loading of semiconductors in the event of rapid current rise during commutation.
- Prevents voltage dips in the mains voltage caused by commutation.
- Reduces current ripple in the DC link, thereby increasing the service life of the DC link capacitors.

More information can be found on Kollmorgen "KDN" page "[Mains Choke](#)".

6.2 Important notes



DANGER High Voltage up to 480 V!

Risk of electric shock. Power terminals are capable of conducting hazardous voltage up to 10 minutes after the mains voltage has been disconnected.

- Before starting work on power terminals, check that the phase-to-earth and phase-to-phase voltages have de-energised.

NOTICE

Due to the high earth leakage currents induced by the system, you should observe the requirements of EN 61800-5-1 (e.g. fixed installation, $\geq 10 \text{ mm}^2$ or double protective earth) when carrying out mounting and installation work. You must read the instructions manual for the drive/servo motor you are using in your application and observe the safety instructions they contain before commencing mounting/installation work.

Mounting: 50mm free space required above and below the device.

Connection diagram: see drive instructions manual.

6.3 Type assignment and order codes

Drive	Mains choke
AKD-x04807 (with asymmetrical mains >3% only)	2% uk
AKD other types and AKD2G	not required

Order Codes

Article	uk	Order codes
Mains choke 3L0,24-50-2 (0.24mH, 50A)	2%	DE-201476
Mains choke 3L0,2-75-2 (0.20mH, 75A)	2%	DE-201477

6.4 Mains choke 3L

NOTICE

A number of drives can be connected to one and the same mains choke; the rated current of the mains choke must be greater than or at least equal to the total current of the connected drives.

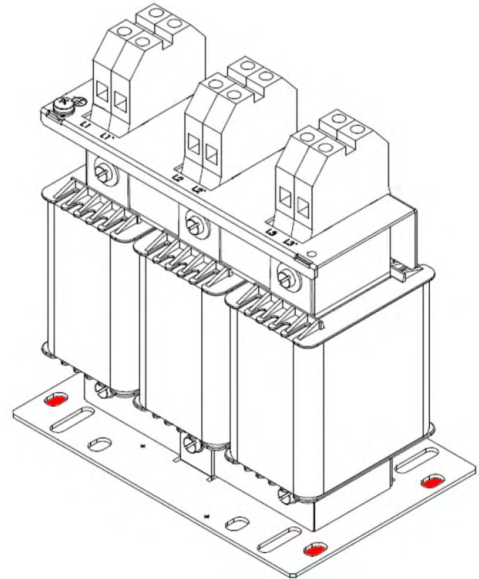
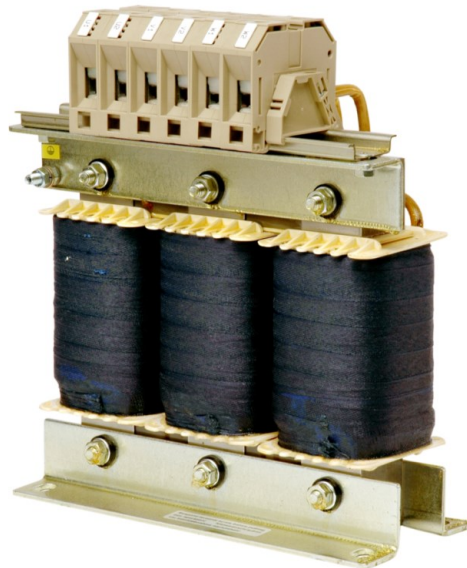
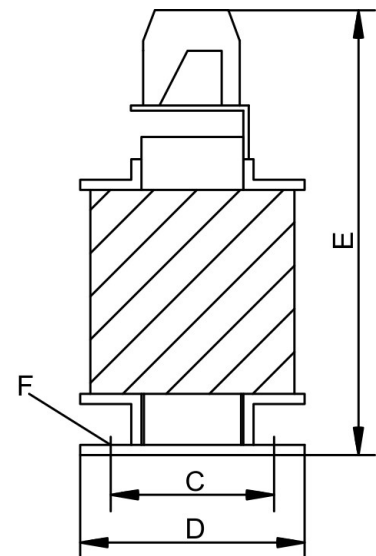
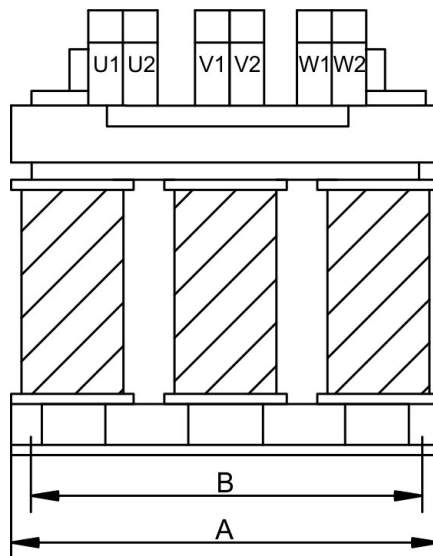

Photo: all models are similar



Technical Data

Type	Inductivity [mH]	Nominal Current [A]	uk [%]	A [mm]	B [mm]	C [mm]	D [mm]	E [mm]	F [mm]	Terminals [mm ²]	Weight [kg]
3L 0,24-50-2	0.24	50	2	152.5	114.3	88.9	114.3	163	6.5	10	5.9
3L 0,2-75-2	0.20	75	2	185	170	77	122	220	8x12	35	9.9

7 Mains filters

7.1 General

AKD-x00306 to AKD-x02406 and AKD2G-xxx-6Vxx drives require an external mains filter. All other drives feature built-in mains filters (see the relevant instructions manual). The filtering effect of the mains filters can only be assured if the permissible throughput rating of the mains filters is not exceeded even on peak loading of the drives with I_{peak} .

The max. available throughput rating of the mains filter must be higher than the max. power consumption of the drives and higher than the maximum power consumption of the motors. More information can be found on our "KDN" page "[Mains Filter](#)".

7.2 Important notes



DANGER High Voltage!

Risk of electric shock. Power terminals are capable of conducting hazardous voltage up to 10 minutes after the mains voltage has been disconnected.

- Before starting work on power terminals, check that the phase-to-earth and phase-to-phase voltages have de-energised.

NOTICE

Due to the high earth leakage currents induced by the system, you should observe the requirements of EN 61800-5-1 (e.g. fixed installation, $\geq 10 \text{ mm}^2$ or double protective earth) when carrying out mounting and installation work. You must read the instructions manuals for the used components and observe the safety instructions they contain before commencing mounting/installation work. See drive instructions manual for connection diagrams.

7.3 Type assignment and order codes

Drive	Mains filter
AKD-B/P/T/M 00306...02406 (120 to 240V)	1~: 1NF, 3~: 3NF
AKD-x00307...04807 (240 to 480V)	not required
AKD2G-xxx-6Vxx (120 to 240V)	1~: FN2090, 3~: FN3288
AKD2G-xxx-7Vxx (240 to 480V)	not required

Order Codes

Article	Mains, Voltage	Nominal Current	Approvals	Order code
Mains filter 1NF-10	1~, 230VAC	10A	CE, UL	DE-201565
Mains filter 1NF-12	1~, 230VAC	12A	CE, UL	DE-201566
Mains filter 1NF-20B	UL: 1~, 125 VAC CE: 1~, 230VAC	20A	CE, UL	DE-201865
Mains filter 1NF-25	1~, 230VAC	25A	CE, UL	DE-201568
Mains filter 3NF-07	3~, 480VAC	7A	CE, UL	DE-201569
Mains filter 3NF-16	3~, 480VAC	16A	CE, UL	DE-201570
Mains filter 3NF-30	3~, 480VAC	30A	CE, UL	DE-201571
Mains filter FN2090-6	1~, 250VAC	6A	CE, UL	DE-202203
Mains filter FN2090-12	1~, 250VAC	12A	CE, UL	DE-202204
Mains filter FN3288-10	3~, 530VAC	10A	CE, UL	DE-202205
Mains filter FN3288-16	3~, 530VAC	16A	CE, UL	DE-202206

7.4 Mains filters 1NF-10...12

Observe the safety instructions (→ # 26).
For single-phase operation only.

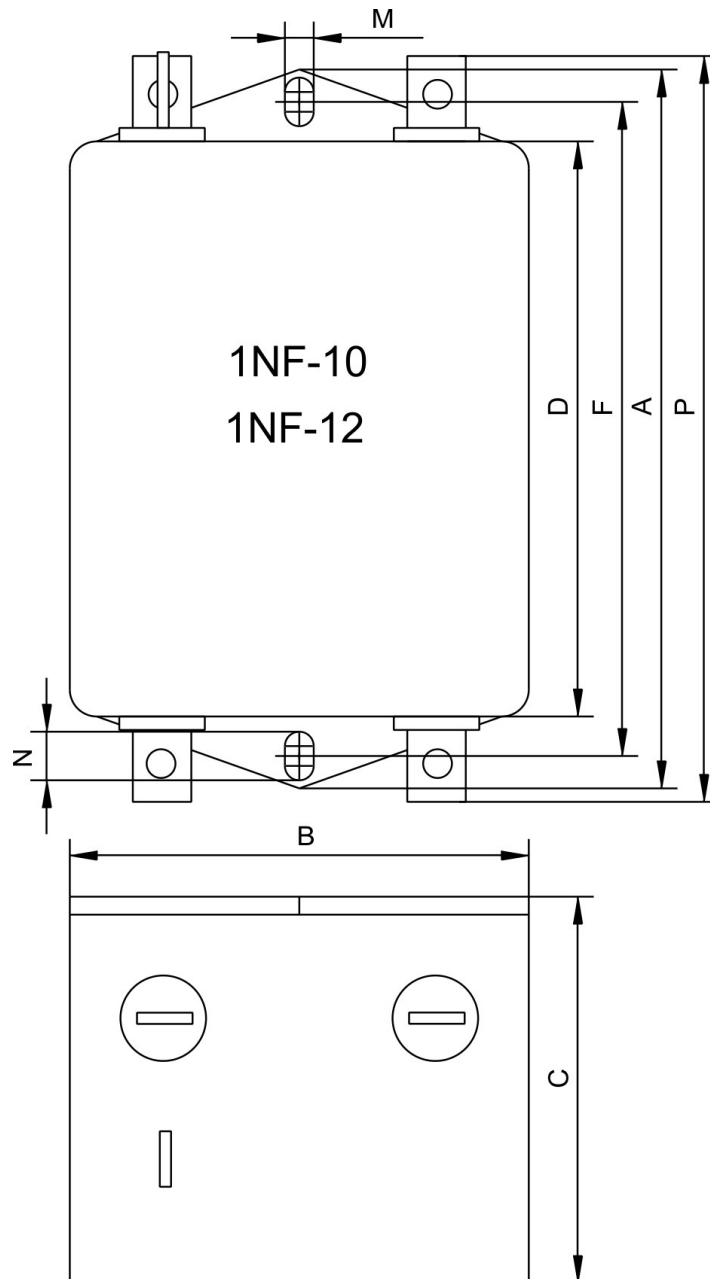

Technical Data

Type	Nominal Current [A]*	Nominal Voltage [V]	A [mm]	B [mm]	C [mm]	D [mm]	F [mm]	M [mm]	N [mm]	P [mm]	Weight [kg]	Connection
1NF-10	10	230	85	49	40.3	54	75	5.3	6.3	87	0.29	Fast-on
1NF-12	12	230	156	57.5	45.4	130.5	143	5.3	6	156	0.73	Fast-on

* at 40°C environment temperature

7.5 Mains filters 1NF-20B, 1NF-25

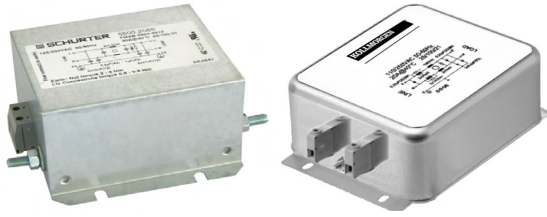

Observe the safety instructions (→ # 26).
For single-phase operation only.

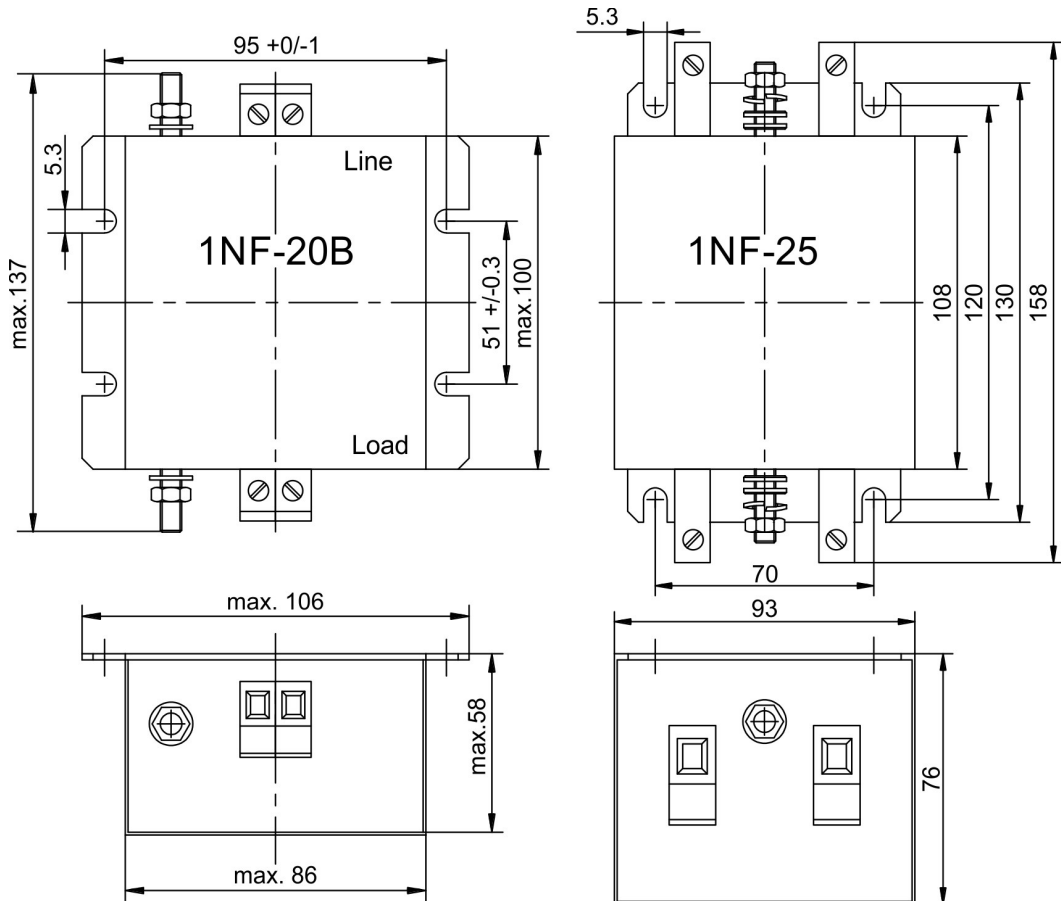

Technical Data

Type	Nominal Current [A]*	Nominal Voltage		Weight [kg]	Connection Phase Terminals	Connection PE
		IEC	UL/CSA			
1NF-20B	20	230V	125V	0.93	Wires up to 4mm ² Torque 0.6 to 0.8 Nm	Bolt M 6 Torque 3.5 to 4 Nm
1NF-25	25	230V	230V	0.7	Wires up to 10mm ² Torque 1.5 to 1.8 Nm	

* at 50°C environment temperature

7.6 Mains filters 3NF-07...30

Observe the safety instructions (→ # 26).

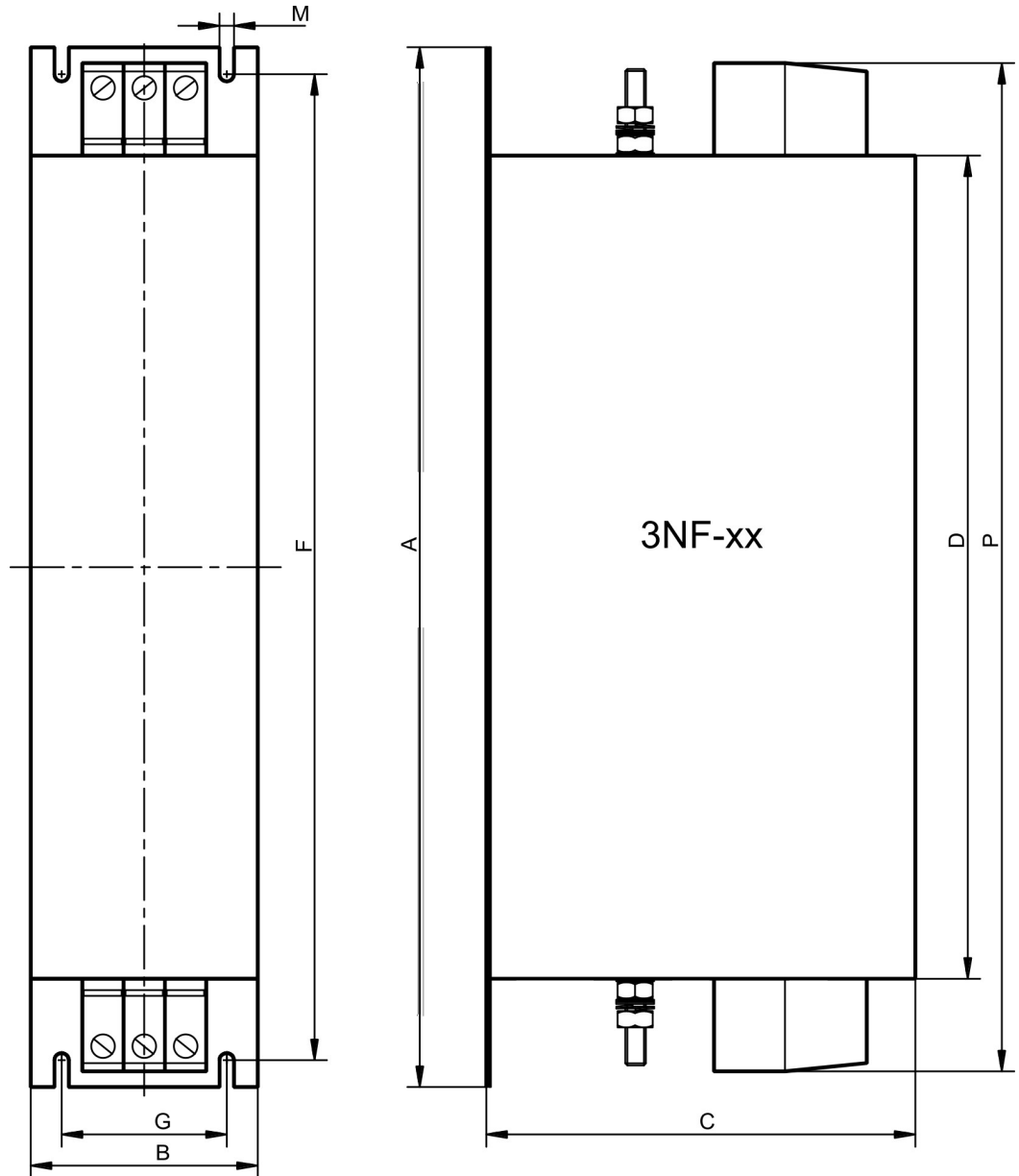

Technical Data

Type	Nom. Current*	A [mm]	B [mm]	C [mm]	D [mm]	F [mm]	G [mm]	M [mm]	P [mm]	Weight [kg]	Terminals	PE Bolt
3NF-07	7 A	190	40	70	160	180	20	4.5	180	0.5	4mm ² ,	M5, 2.2Nm
3NF-16	16 A	250	45	70	220	235	25	5.4	240	0.8	0.7..0.8Nm	
3NF-30	30 A	270	50	85	240	255	30	5.4	260	1.2	10mm ² , 1.9..2.2Nm	

* at 50°C environment temperature

7.7 Mains filters FN2090



Observe the safety instructions (→ # 26).

For single-phase up to 240 VAC operation only.

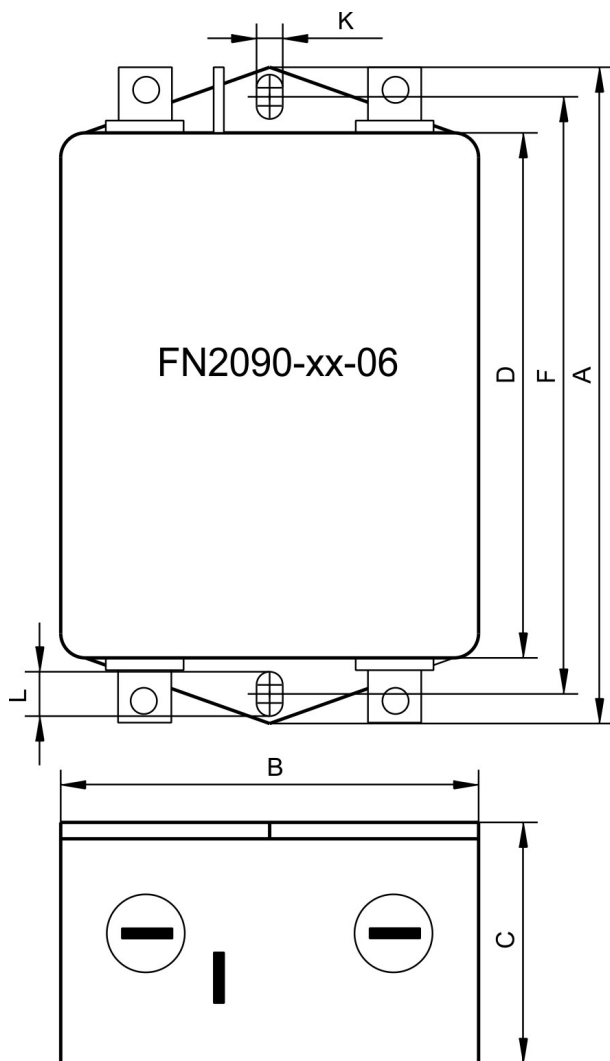

Technical Data

Type	Nominal Current [A]*	A [mm]	B [mm]	C [mm]	D [mm]	F [mm]	K [mm]	L [mm]	Weight [kg]	Faston
FN2090-6-06	6	85	54	30,5	65	75	5.3	6.3	0.2	6.3 x 0.8
FN2090-12-06	12	114	58	45.5	95	103	4.4	6	0.4	6.3 x 0.8

* at 50°C environment temperature

7.8 Mains filters FN3288



Observe the safety instructions (→ # 26).

For three-phase operation up to 480 VAC only.

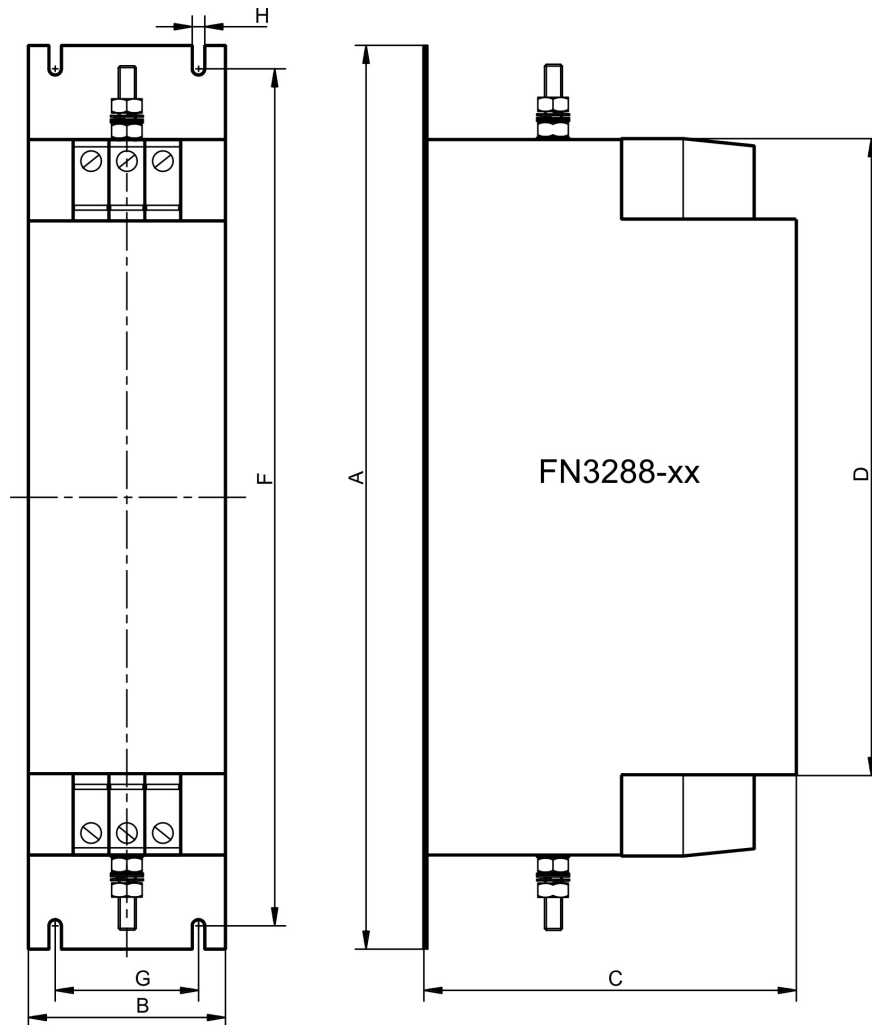

Technical Data

Type	Nom. Current [A]*	A [mm]	B [mm]	C [mm]	D [mm]	F [mm]	G [mm]	H [mm]	Weight [kg]	Terminals	PE Bolt
FN3288-10	10	185	40	120	157	175	20	4.5	0.8	0.5-6mm ² ,	M5,
FN3288-16	16	195	45	140	164	180	25	5.4	1.0	1.0-1.2Nm	2.2Nm

* at 50°C environment temperature

8 Regen resistors (brake resistors)

8.1 General

During braking with the aid of the motor, energy is fed back into the drive. This regenerative energy is dissipated as heat in the regen resistor (also called brake resistor). The regen resistor is switched on by the regen circuit. Different resistance values have to be used depending on the drive. All resistors meet the requirements of CE directives and are UL-registered. More information to the resistors are given on KDN page "[Brake Resistor](#)".

8.2 Important notes



DANGER High Voltage up to 900 V!

Risk of electric shock. Power terminals are capable of conducting hazardous voltage up to 10 minutes after the mains voltage has been disconnected.

- Before starting work on power terminals, check that the phase-to-earth and phase-to-phase voltages have de-energised.



WARNING High Temperature!

Risk of burns. The regen resistor surface temperature can exceed 250°C.

- Measure the temperature and wait until temperature dropped down below 40°C, before touching the resistor housing.
- Use fusing elements (for example Frizlen FPS series) to switch off the resistor in case of overload current.

NOTICE

Inadequate levels of cooling air or incorrect installation can lead to overheating and destruction of the resistor and surrounding components.

- May only be installed in switchgear cabinets, comply with the permissible installation types and clearances (see dimensional drawing).
- Ensure there is unobstructed convection for cooling purposes.
- Use temperature-resistant materials in the vicinity of the resistor.
- The connection terminals must never be located within the flow range of the heated waste air.

The following requirements must be met to ensure the regen resistors work properly:

- Compliance with required installation clearances
- Compliance with permissible installation type
- Unhindered access of cooling air
- Unhindered diverting of warmed up air
- Rated data with maximum ambient temperature 40°C, in case of ambient temperature higher than 40°C, power must be reduced by 4% per 10°C temperature rise

NOTICE

You must read the instructions manual for the drive you are using in your application and observe the safety instructions they contain before commencing mounting/installation work.

Check the drive's instructions manual for a connection diagram.

8.3 Type assignment and order codes

Drive*	Brake resistor	Resistance Ω	Remarks
AKD-x00306	BAFP(U)/BAR(U)/BAS(U)	33	usually required
AKD-x00606	BAFP(U)/BAR(U)/BAS(U)	33	usually required
AKD-x01206	BAR(U)/BAS(U)	15	optional
AKD-x02406	BAR(U)/BAS(U)	15	optional
AKD-x00307	BAR(U)/BAS(U)	33	optional
AKD-x00607	BAR(U)/BAS(U)	33	optional
AKD-x01207	BAR(U)/BAS(U)	33	optional
AKD-x02407	BAR(U)/BAS(U)	23	optional
AKD-x04807	BAS(U)	10	usually required
AKD-C	BAR(U)/BAS(U)	33	optional
AKD2G-Sxx-6V	BAFP(U)/BAR(U)/BAS(U)	15	optional
AKD2G-Sxx-7V	BAFP(U)/BAR(U)/BAS(U)	33	optional

Order codes

Article	Drive*	Resistance [Ω]	Rated Power [W]	Max. Power [W]	Order code
Brake resistor BAS(U) 2000-10	AKD-x04807	10	2000	3200	DE-103874
Brake resistor BAS(U) 3000-10		10	3000	4800	DE-103875
Brake resistor BAS(U) 6000-10		10	6000	9600	DE-103876
Brake resistor BAR(U) 500-15	AKD-x01206, AKD-x02406, AKD2G-Sxx-6V	15	500	800	DE-201439
Brake resistor BAR(U) 1000-15		15	1000	1600	DE-201440
Brake resistor BAS(U) 2000-15		15	2000	3200	DE-103871
Brake resistor BAS(U) 3000-15		15	3000	4800	DE-103872
Brake resistor BAS(U) 6000-15		15	6000	9600	DE-103873
Brake resistor BAR(U) 600-23	AKD-x02407	23	600	960	DE-200613
Brake resistor BAR(U) 1000-23		23	1000	1600	DE-200614
Brake resistor BAS(U) 2000-23		23	2000	3200	DE-200615
Brake resistor BAS(U) 3000-23		23	3000	4800	DE-200616
Brake resistor BAS(U) 4000-23		23	4000	6400	DE-200617
Brake resistor BAFP(U) 100-33	AKD-x00306 to -x00606, AKD-x00307 to -x01207, AKD-C, AKD2G-Sxx-7V	33	100	160	DE-201437
Brake resistor BAFP(U) 200-33		33	200	320	DE-201438
Brake resistor BAR(U) 250-33		33	250	400	DE-106254
Brake resistor BAR(U) 500-33		33	500	800	DE-106255
Brake resistor BAR(U) 1500-33		33	1500	2400	DE-106258
Brake resistor BAS(U) 3000-33		33	3000	4800	DE-201407

*= AKD-x means AKD variants -B, -P, -T or -M

8.4 External regen resistor BAFP(U)



Protection class: IP40



The surface temperature can exceed 250°C. Risk of burns and fire! Measure the temperature before touching.

Admissible floor mounting

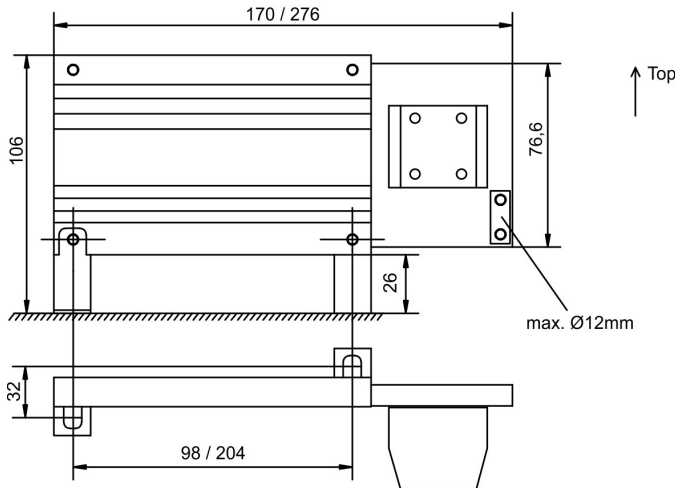

Admissible ceiling mounting

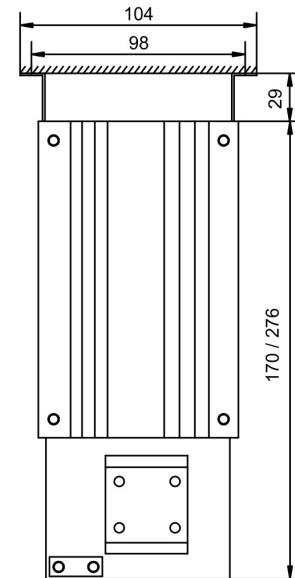

Admissible wall mounting
Clamps down

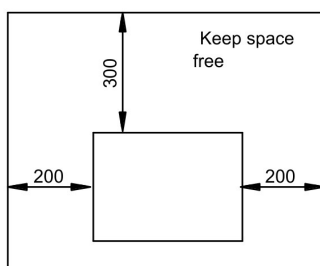
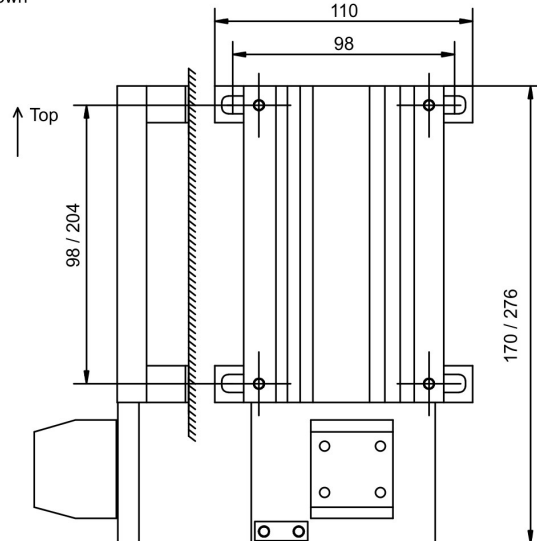
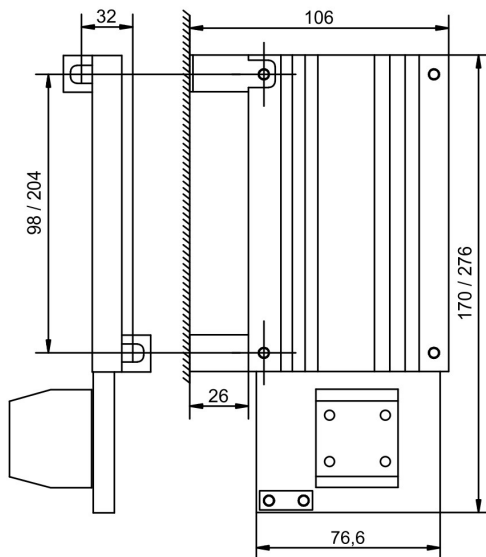

Typ	R	Length	Power	Weight
	Ω	mm	W	Kg
BAFP(U) 100-33	33	170	100	0,3
BAFP(U) 200-33	33	276	200	0,55

Other types of mounting are not admitted !

8.5 External regen resistor BAR(U)



Protection class: IP20



WARNING

The surface temperature can exceed 250°C. Risk of burns and fire! Measure the temperature before touching.

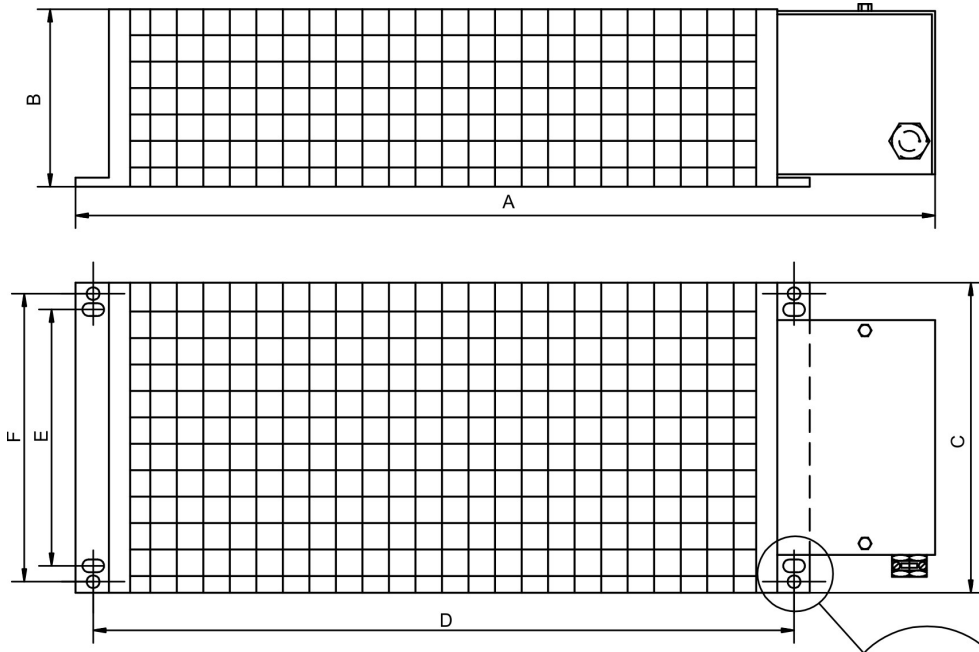

Type	R	Power	A	B	C	D	E	F	weight
	Ω	W	mm	mm	mm	mm	mm	mm	
BAR(U) 500	15	500	549	120	92	430	64	80	3
BAR(U) 1000	15	1000	749	120	92	630	64	80	4
BAR(U) 600	23	600	549	120	92	430	64	80	3
BAR(U) 1000	23	1000	749	120	92	630	64	80	4
BAR(U) 250	33	250	349	120	92	230	64	80	2
BAR(U) 500	33	500	549	120	92	430	64	80	3
BAR(U) 1500	33	1500	649	120	185	530	-	150	5,8
BAR(U) 300	66	300	349	120	92	226	64	80	1,5
BAR(U) 600	66	600	549	120	92	426	64	80	2,3
BAR(U) 1000	66	1000	749	120	92	626	64	80	3,4
BAR(U) 300	91	300	349	120	92	226	64	80	1,5
BAR(U) 600	91	600	549	120	92	426	64	80	2,3
BAR(U) 1000	91	1000	749	120	92	626	64	80	3,4

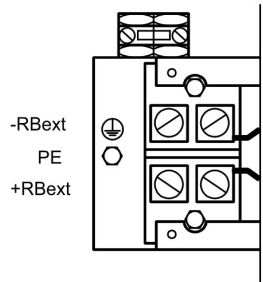
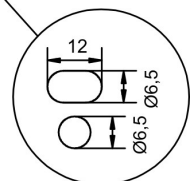

±10%, temperature drift approx. 1%
Cold approx. +8%, 320°C approx. -7%

Admissible floor mounting

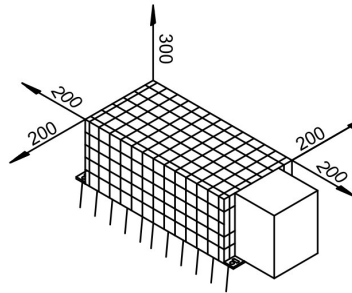

Admissible wall mounting
Clamps down

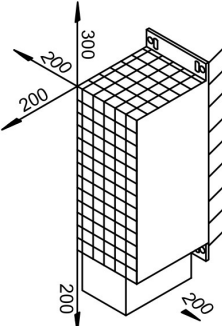

Other types of mounting are not admitted !

8.6 External regen resistor BAS(U)



Protection class: IP20



WARNING

The surface temperature can exceed 250°C. Risk of burns and fire! Measure the temperature before touching.

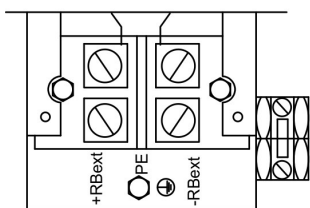
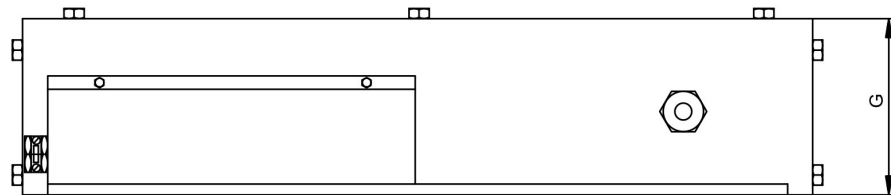
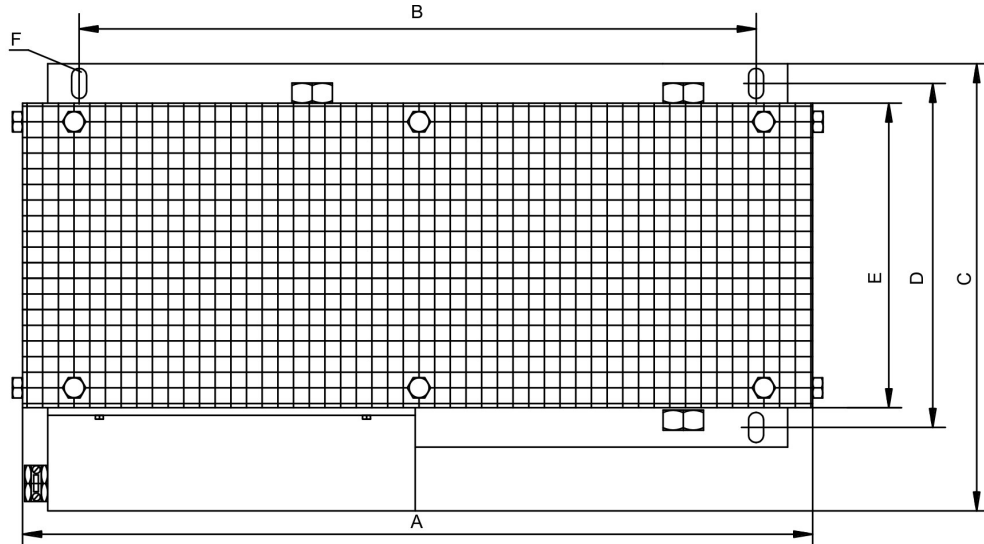

±10%, temperature drift approx. 1%
Cold approx. +8%, 320°C approx. -7%

Admissible floor mounting

Admissible wall mounting
Clamps down

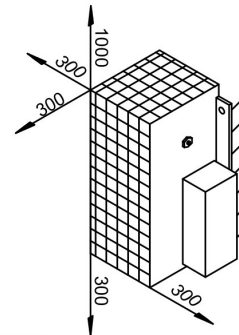
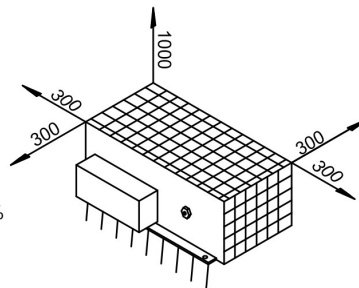

Other types of mounting are not admitted !

	R	Rated power W	A	B	C	D	E	F	G	weight Kg
	Ω		mm	mm	mm	mm	mm	mm	mm	
BAS(U)2000-10	10	2000	490	380	255	170	150	Ø10,5	260	7
BAS(U)3000-10	10	3000	490	380	355	270	250	Ø10,5	260	8
BAS(U)6000-10	10	6000	490	380	455	370	350	Ø10,5	260	11
BAS(U)2000-15	15	2000	490	380	255	170	150	Ø10,5	260	7
BAS(U)3000-15	15	3000	490	380	355	270	250	Ø10,5	260	8
BAS(U)6000-15	15	6000	490	380	455	370	350	Ø10,5	260	11
BAS(U)2000-23	23	2000	490	380	255	170	150	Ø10,5	260	7
BAS(U)3000-23	23	3000	490	380	355	270	250	Ø10,5	260	8
BAS(U)4000-23	23	4000	490	380	355	270	250	Ø10,5	260	9
BAS(U)3000-33	33	3000	490	380	355	270	250	Ø10,5	260	8

9 Capacitor Modules

9.1 General

KCM modules (**K**OLL**M**ORGEN **C**apacitor **M**odules) absorb energy generated by the motor when it is operating in generator mode. Normally, this energy is dissipated as waste via regen resistors. KCM modules, however, feed the energy they have stored back into the DC Bus link as and when it is required.

KCM-S	Saves energy: The energy stored in the capacitor module during generative braking is available the next time acceleration happens. The module's inception voltage is calculated automatically during the first load cycles.
KCM-P	Power in spite of power failure: If the power supply fails, the module provides the drive with the stored energy that is required to bring the drive to a standstill in a controlled manner (this only applies to the power supply voltage; battery-back the 24 V supply separately).
KCM-E	Expansion module for both applications. Expansion modules are available in two capacitance classes.

More information can be found on our KDN page "[KCM Capacitor Module](#)".

9.2 Important notes



⚠ DANGER High DC Voltage up to 900 V!

There is a danger of serious personal injury or death by electrical shock or electrical arcing. It can take over an hour for the modules to self-discharge.

- Switch off (disconnect) the line voltage. You must only work on the connections when the system is disconnected.
- Check the state of charge with a measuring device that is suitable for a DC voltage of up to 1,000 V.
- When measuring a voltage of over 50 V between the DC+/DC- terminals or to ground, discharge the modules as described in the KCM Instructions Manual.

NOTE

KCM is not released for use with AKD2G.

NOTICE

You must read the instructions manual for the devices you are using in your application and observe the safety instructions they contain before commencing mounting/installation work.

Wiring diagram and more important notes concerning wiring can be found in the KCM instructions manual and in the instructions manual of the used drive.

9.3 Type assignment and order codes

NOTE The KCM modules may only be connected to drives with 400/480 V rated voltage.

Drive*	KCM Module	Drive*	KCM Module
AKD-x00307...02407	all Modules	AKD-x00306...02406	not allowed
AKD-C01007	all Modules	AKD-x04807	contact customer support

*= x means variants -B, -P, -T or -M

Order codes

Type	Remarks	Order Code
KCM-S200	Energy Saving Module, 1.6 kW	KCM-S200-0000
KCM-P200	Power Module, 2 kW	KCM-P200-0000
KCM-E200	Expansion Module 2 kW	KCM-E200-0000
KCM-E400	Expansion Module 4 kW	KCM-E400-0000

9.4 Example installation

NOTICE Maximum cable length between drive and KCM: 500 mm. The DC+ and DC- lines should always be twisted, maximum cross section is 6 mm².

RS422 interface X4 allows data exchange controlled by a terminal software of your choice. Interface setting: 115200 Baud, 8 Data Bits, 1 Stop Bit, No Parity&Flow Control. The X4 mating connector is in the package. The ready signal reports the ready to operate (high level).

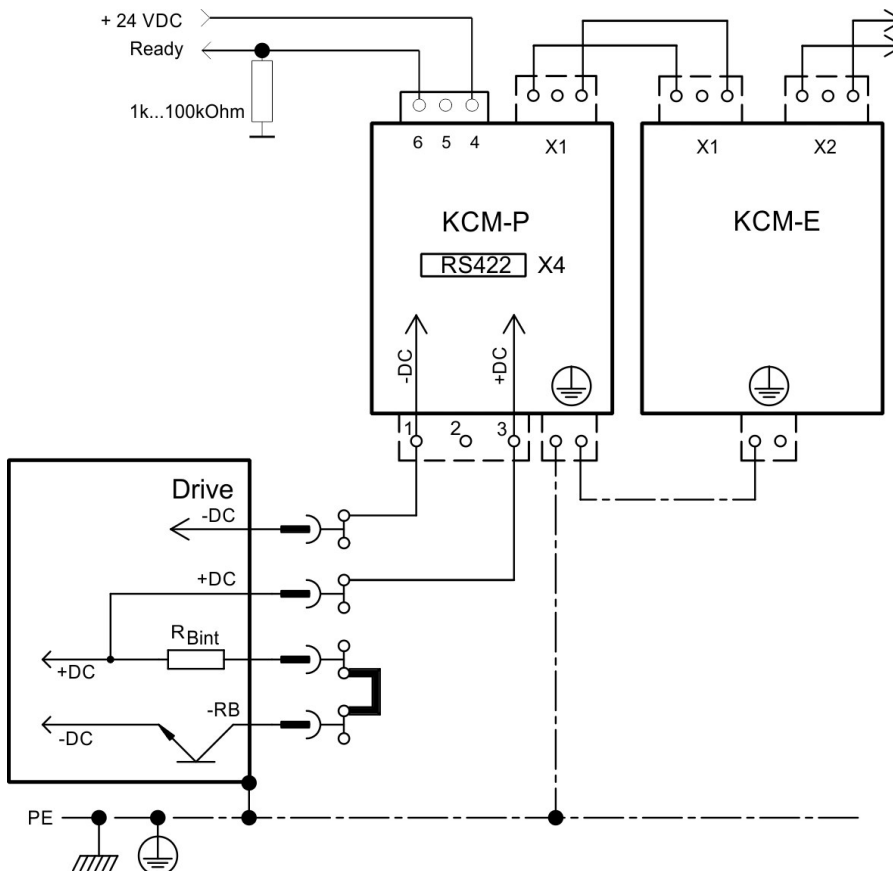

More information is given in the KCM Instructions Manual.

9.5 KCM Module



Observe the safety instructions and in the instruction manual of the drive.

Permissible assembly type: Vertical, ground connections at the bottom. Other assembly positions are not permitted. Observe the required free space to next device. Ensure there is unobstructed convection for cooling purposes.

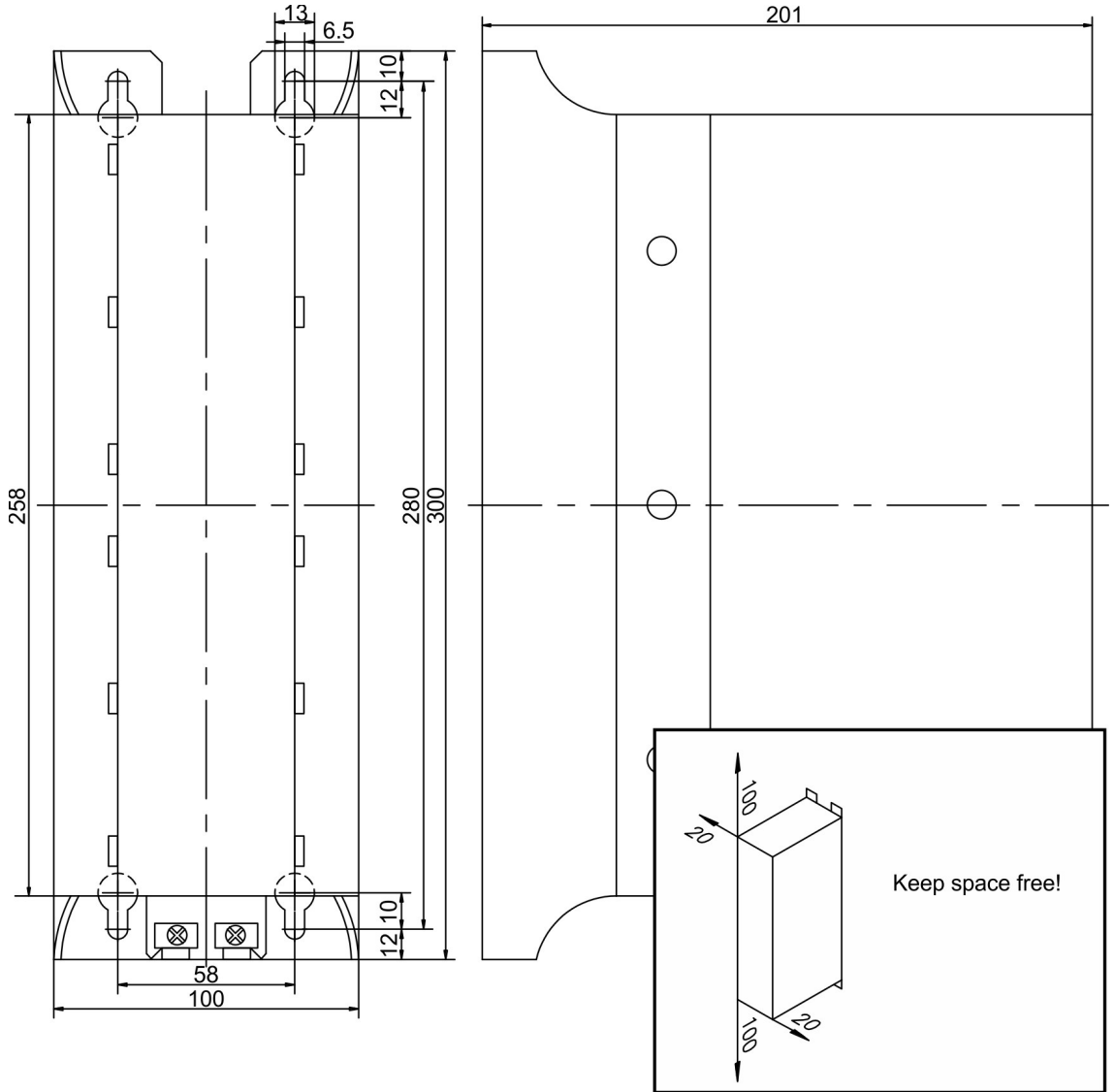

Technical Data

Type	Storage Capacity [Ws]	Rated supply voltage [V=]	Peak supply voltage [V=]	Power [kW]	Protection Class	Inception voltage [V=]	Weight [kg]
KCM-S200	1600	max 850 VDC	max 950VDC (30s in 6min)	18	IP20	calculated	6.9
KCM-P200	2000					470 VDC	6.9
KCM-E200	2000					-	4.1
KCM-E400	4000					-	6.2

10 Motor chokes

10.1 General

Shielded motor cables

For reasons of electromagnetic compatibility, the motor must be supplied with power via a shielded cable. The structure of a cable with 100% shielding and the capacity equivalent circuit diagram (to earth) are shown below.

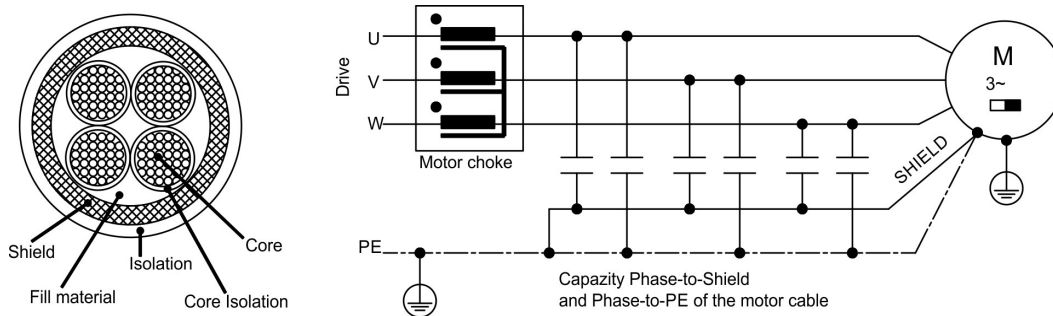

Why use motor chokes?

- To compensate high capacitive charge/discharge currents typical of shielded motor cables approximately 25 m and longer.
- To reduce current alternation noise in the motor.
- To reduce current ripple in the motor.

The digital drives high switching frequencies and steep switching edges give rise to the transfer of capacitive currents to the shield by the three phases (U, V, W). These currents flow from the shield to earth. Depending on the cable length and cable capacity (determined by design), this can lead to the generation of shield currents with peak values of up to 20 A.

These shield currents place a load on the drives and motor and, on large systems, lead to shifts in potential which can damage other components.

This effect is evident in particular on systems with multiple drives operating in parallel on the same mains filter.

The motor chokes slow down the rate of rise of the motor current (reduce edge steepness), thereby reducing the current transferred to the shield.

Why is the cross-section of the motor cable important?

Motor cables longer than 50 m with a small cross-section (e.g. 4 x 1.0 mm²) and therefore a higher equivalent resistance are able to reduce the oscillation tendency of the LCR oscillating circuit (drive/choke/cable/motor). This cross-section can also be advantageous for cable lengths shorter than 50 m if the cable capacity and motor inductance are very high. However, the current loading of the cable must always be within the limits specified by EN 60204.

10.2 Important notes



CAUTION High Temperature!

Risk of light burns and fire. The regen resistor surface temperature can exceed 80°C.

- Therefore, you should make sure that the choke is mounted a sufficient distance away from neighbored components.
- Provide the requisite conditions for unobstructed convection to cool the choke.

NOTICE

You must read the instructions manual for the devices you are using in your application and observe the safety instructions they contain before commencing mounting/installation work. This manual is only valid in conjunction with the instructions manual for the drive and servo motor you are using in your application.

Mount the motor choke 3YLN on a conductive earthed assembly plate in the switchgear cabinet.

The motor choke is wired into the cable close to the drive. When laying the motor cable, allow about 400 mm for the connection to the choke.

Connection diagram see the drive instructions manual.

10.3 Type assignment and order codes

Drive*	Motor choke	Condition
AKD-x003 to AKD-x006	3YLN-06	Motor cable \geq 25m
AKD-x012	3YLN-14	Motor cable \geq 25m
AKD-x024	3YLN-24	Motor cable \geq 25m

*= x means variants -B, -P, -T or -M

Order codes

Article	Nominal Current	Approvals	Order code
Motor choke 3YLN-06	6 A	CE, UL	DE-107929
Motor choke 3YLN-14	14 A	CE, UL	DE-107931
Motor choke 3YLN-24	24 A	CE, UL	DE-201447

10.4 Motor choke 3YLN-xx

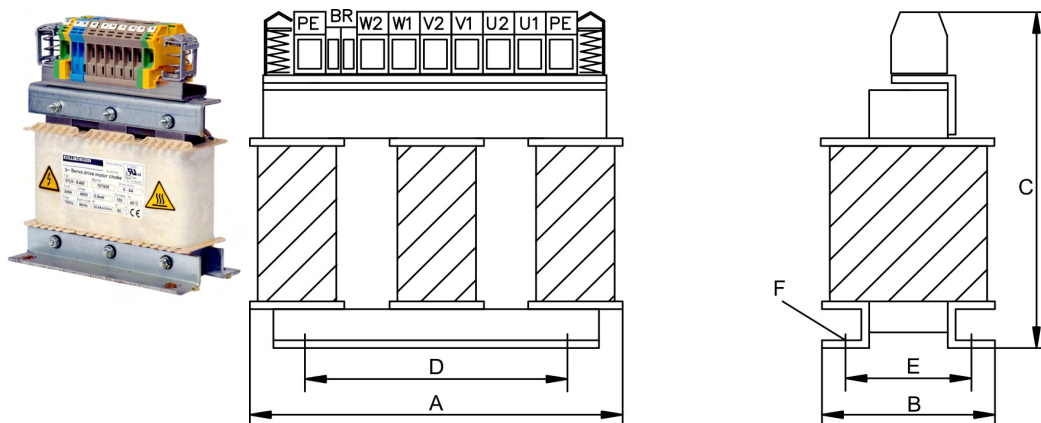

Technical Data:

Rated Data	Sym	DIM	3YLN-06	3YLN-14	3YLN-24
Rated current	I _{0rms}	A	6	14	24
Rated voltage	U _{nom}	V	480		
Rated frequency	f _{nom}	Hz	0 to 150		
Max. frequency	f _{max}	kHz	8		
Inductivity	L	μH	900	900	450
Power loss	P	W	12	19.4	23.2
Protection class	-	-	IP00		
Temperature class	-	-	F		
Operation class	-	-	S1		
Weight	G	kg	4.5	10	10
Cable diameter (Shield clamp)	-	mm	4 to 13.5		
Wiring cross section max. (Terminals)	-	mm ²	10	16	16
Width	A	mm	155	190	190
Depth	B	mm	90	125	125
Height	C	mm	195	230	230
Mounting hole distance	D	mm	130	170	170
Mounting hole distance	E	mm	56.5	78	78
Mounting screws	F	-	4xM6	4xM6	4xM6

11 Cables

NOTE

Kollmorgen assumes no liability for errors or damage to equipment caused by cables manufactured by customers.

11.1 Technical data for cables

Information on the chemical, mechanical and electrical characteristics of the cables can be found in our KDN page "[Cables](#)".

Insulation material

- Sheathing: PUR (polyurethane, code 11Y)
- Core insulation: PETP (polyesteraphthalate, code 12Y)

Capacitance (phase to shield)

- Motor cable: less than 180 pF/m (cross sections >6mm² have larger capacitance)
- Feedback cable: less than 120 pF/m
- Hybrid Cable: special requirements

Technical data

- The brackets in the core definition indicate the shielding
- All cables are suitable for use as trailing cables
- The technical data refer to use as moveable cables
- Operating life : 10 million bending cycles
- All cables are UL recognized

11.2 Tools

Only work with the special tools that are required for the used connectors. You can obtain these special tools from the manufacturer of the connectors or contacts.

11.3 PC connection

The AKD is connected by a standards net cable with RJ45 connectors to the PC or to a Switch/Hub.

Article	Order Code
Ethernet Cable PC-AKD	(→ # 47)

11.4 Power Voltage Supply, external regen resistor, DC bus link

The connectors used (40 A and higher fixed terminals) are included in the drive package. If necessary, the connectors are coded.

NOTE

We do not deliver configured cables for these interfaces.

NOTICE

You must always observe the specifications in respect of cable cross-sections contained in the instructions manual for the drive you are using in your application. Fit suitable wire end ferrules or plug connectors to stripped conductors. Connection diagrams can be found in the drive instructions manual.

11.4.1 Recommended cable type

The table indicates the cross section and cable shielding required for each intended purpose.

Purpose	max. length	recommended cross section (I_n = drive rated output current)		
		$I_n=1.5...10A$	$I_n=12...24A$	$I_n=40...72A$
AC-supply	-	1.5	4	25
DC-bus link	0.5 m	1.5	4	25
	2m	(2 x 1.5)	(2 x 4)	(2 x 25)
Ext. regen resistor	5m	(2 x 1.5 + PE)		(2 x 25 + PE)

Valid for single axis systems. For multi axes and cable types please consult our customer support.

11.4.2 Mating connector

Mating connectors, connector kits and adapters see (→ # 20)

11.5 24V auxiliary voltage supply

Connectors are used, that are included in the delivery package of the drives. If necessary, the connectors are coded and printed with the corresponding terminal designation.

NOTE

We do not deliver configured cables for this interface.

NOTICE

You must always observe the specifications in respect of cable cross-sections contained in the instructions manual for the drive you are using in your application. Fit suitable wire end ferrules or plug connectors to stripped conductors. A connection diagram appears in the drive instructions manual.

11.5.1 Recommended cable type

Purpose	recommended cable
24V Aux. Voltage	H07V-K 1.5 or H07V-K 2.5
Observe voltage drop!	

11.5.2 Mating connector

Mating connectors, connector kits and adapters see (→ # 20)

11.6 Digital/analog Inputs/Outputs

11.6.1 Digital In/Outputs for AKD-C

The digital control signals are connected to X15 and X16 with single lines.

NOTE

We do not deliver configured cables for this interface.

Mating connector

Mating connectors, connector kits and adapters see (→ # 20)

Recommended cable type

Purpose	max. length	Recommended cable
Digital I/O, STO	30m	H07VK 0.5

11.6.2 Digital I/O cable for AKD-N



All AKD-N drives have one 8 poles M12 connector to connect digital control signals.

Maximum cable length 5m.

Kollmorgen recommends pre-configured Phoenix SAC cables.

Order codes for I/O cables, one end configured

Amplifier	Order Code	Description
AKD-N all types	SAC-8P-M12MS	5m, M12 mating connector, unconfigured wires

Other length can be ordered from Phoenix Contact Deutschland GmbH.

11.6.3 STO cable for AKD-N-DS/DT



AKD-N-DS/DT drives (devices with local STO input) have an additional 4 poles M12 connectors to connect the local STO signals.

Maximum cable length 5m.

Kollmorgen recommends pre-configured Phoenix SAC cables.

Order codes for I/O cables, one end configured

Amplifier	Order Code	Description
AKD-N-DS/DT	SAC-4P-M12MS	5m, M12 mating connector, unconfigured wires, A-coded

Other length can be ordered from Phoenix Contact Deutschland GmbH.

11.6.4 Fieldbus cable for AKD-N-DF/DG



AKD-N-DF/DG drives (devices with local fieldbus input) have an additional 4 poles M12 connectors to connect the local fieldbus signals.

Maximum cable length 5m.

Kollmorgen recommends pre-configured Phoenix SAC cables.

Order codes for I/O cables, one end configured

Amplifier	Order Code	Description
AKD-N-DF/DG	SAC-4P-M12MSD/5,0	5m, M12 mating connector, unconfigured wires, D coded

Other length can be ordered from Phoenix Contact Deutschland GmbH.

11.6.5 Digital/analog I/O for AKD-B/P/T/M and AKD2G

The cables for analog signals must be twisted pairs, and shielded. The digital signals can be connected by single wires.

NOTE

We do not deliver configured cables for this interface.

Mating connector

Mating connectors, connector kits and adapters see (→ # 20)

Recommended cable type

Purpose	max. length	recommended cable
Digital I/O	30m	H07VK 0,5
BTB	30m	
Digital GND	30m	
Analog Setpoint	30m	LiYCY (TP) 4x2x0.25
Analog GND	30m	

11.7 Encoder Emulation, Stepper motor control, Master-Slave

This interface can be used for several applications ("AKD Instruction Manual"). The material requirements are always the same.

NOTE

We do not deliver configured cables for this interface.

11.7.1 Mating connector, cable type

Article	Description	Order Code
Cable	4x2x0.25 (per meter)	DE-92186
Connector kit, drive end AKD-B/P/T/M, X9/X10	X10 male connector 15 pin high density, X9 female connector 9 pin, 2 housings, screws	AKD-X9+X10-Kit

11.7.2 Connection

The cable used must be shielded, with twisted pairs to (suggestion according to DIN 47100). Since it is important which signal pairs are twisted together, the following table shows the colors of the individual cores (to IEC 60757). The connector assignment is determined by the use of the interface; see the drive instructions manual.

SubD9, X9 AKD-B/P/T/M	Core color @ 5x2x0.25	
	ROD	SSI, Stepper motor control, Master-Slave
3	WH	WH
7	GN	n.c.
8	YE	n.c.
1	GY	GN
2	PK	YE
4	BU	GY
5	RD	PK
6	BK	BK
9	BN	n.c.

Connector pin-out depends on the interface usage, see "AKD Instruction Manual".

11.8 Ethernet cable

Connection to an Ethernet network is possible via two RJ45 connectors in the drives. These cables can be used for all fieldbus connections with standard RJ45 connectors like EtherCAT, PROFINET, SynqNet and also for the EtherNet TCP/IP Service Port connection of an AKDdrive.

Order codes Ethernet cable, configured

Article	Length	Order code
Ethernet cable	0.17 m	ENCP-0017-000
Ethernet cable	0.26 m	ENCP-0026-000
Ethernet cable	0.30 m	ENCP-0030-000
Ethernet cable	0.50 m	ENCP-0050-000
Ethernet cable	1.00 m	ENCP-0100-000
Ethernet cable	2.00 m	ENCP-0200-000
Ethernet cable	3.00 m	ENCP-0300-000
Ethernet cable	4.00 m	ENCP-0400-000
Ethernet cable	5.00 m	ENCP-0500-000
Ethernet cable	10.00 m	ENCP-1000-000

11.9 CAN bus cable

According to ISO 11898 you should use a bus cable with a characteristic impedance of 120 Ω. The usable cable length depends on the transmission rate. The values that we have measured can be taken as a guide, but they should not be interpreted as limits:

Cable data:

- Characteristic impedance: 100-120 Ω
- Cable capacitance: max. 60 nF/km
- Conductor (loop) resistance: 159.8 Ω/km

Cable length, depending on the transmission rate:

Transmission rate / kbps	1000	500	250
max. cable length / m	20	70	115

The table refers to the total cable length between the ends of the bus. Longer transmission distances can be achieved with a lower cable capacitance (max. 30 nF/km) and lower loop resistance (115 Ω/km).

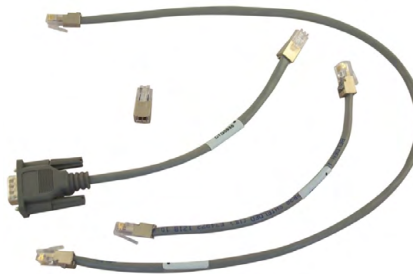

We deliver configured CAN bus cables for AKD-xyyyzz-xxCN and AKD-xyyyzz-xxCC.

Article	Length	AKD Order code
CAN Bus cable	0.15 m	CBP000-002-m15-00
CAN Bus cable	0.30 m	CBP000-002-m30-00
CAN Bus cable	1.00 m	CBP000-002-001-00
CAN Bus cable	3.00 m	CBP000-002-003-00

The CAN Termination connector is required for bus termination of the last AKD connected to the CAN bus. For connecting an AKD to a CAN device with SubD9 connector the CAN RJ12-SubD9 Adapter can be used.

Article	Order code
CAN Termination connector	AKD-CAN-Termination
CAN RJ12->SubD9 adapter	AKD-CAN-RJ12-SubD9

11.10 AKD-C/N String Cables

NOTICE

The AKD-C/N strings must be connected with Kollmorgen cables. The cable shield is connected to devices via the connector housings.

11.10.1 String cable AKD-C to AKD-N

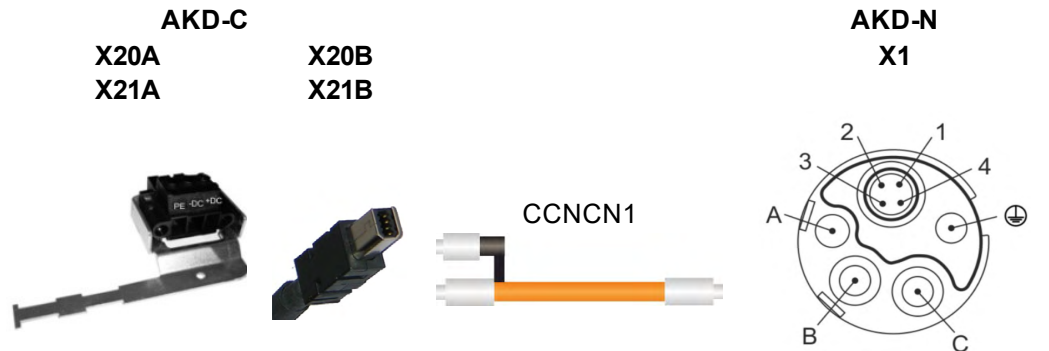

Pin X20A/X21A	Signal
1	+DC_ST
2	-DC_ST
3	PE
Pin X20B/X21B	Signal
1	Receive +
2	Receive -
3	Transmit +
6	Transmit -
4,5,7,8	n.c.

Pin	Signal
A	n.c
B	-DC_ST
C	+DC_ST
PE	PE
1	Receive -
2	Transmit -
3	Receive +
4	Transmit +

Maximum cable length 40 m. Length definition: xx=meters, yy=centimeters.

Defined cable lengths: 3 m, 6 m, 12 m, 24 m, 36 m, 40 m

Article	Order code
Hybrid cable (3x2.5+(2x0.25)+(2x0.25))	CCNCN1-025-xxmyy-00

For replacement issues you can order a connector kit for X20A or X21A with order code CON-AKD-CX20/21A-SL with one connector and one metal shroud (→ # 20).

11.10.2 String cable AKD-N to AKD-N

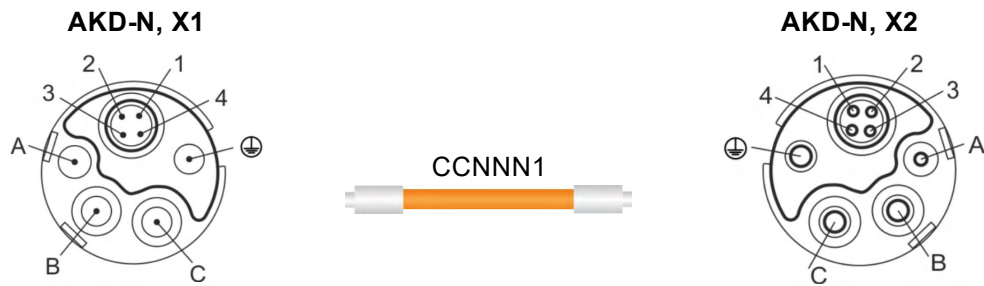

Pin	Signal
A	n.c
B	-DC_ST
C	+DC_ST
PE	PE
1	Receive -
2	Transmit -
3	Receive +
4	Transmit +

Pin	Signal
A	n.c
B	-DC_ST
C	+DC_ST
PE	PE
1	Transmit -
2	Receive -
3	Transmit+
4	Receive +

Maximum cable length depends on string topology. Refer to the AKD-N Installation Manual.
 Length definition: xx=meters, yy=centimeters.

Steps:

- 0.25 m steps from 0.25 m to 2 m,
- 0.5 m steps from 2.5 m bis 25 m
- Maximum cable length 25 m.

Article	Order code
Hybrid cable (3x2.5+(2x0.25)+(2x0.25))	CCNNN1-025-xxmyy-00

11.11 AKM Cables

11.11.1 AKD-N to AKM single (hybrid) motor cables

NOTE

The motor power&feedback should be connected with pre-assembled Kollmorgen single cables. The cable shield is connected to drive and motor via the connector housings.

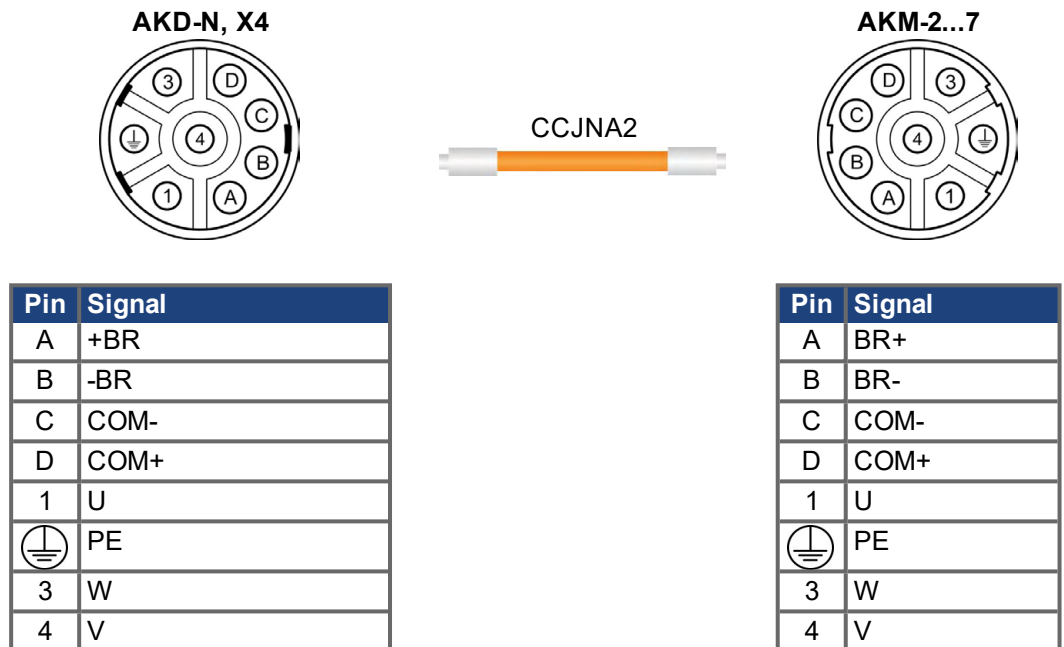

Maximum cable length 5 m. Length definition: xx=meters, yy=centimeters.

0.2, 0.3, ... , 1.0 (steps 0.1m up to 1m)

1.25, 1.5, ... , 2.0 (steps 0.25m up to 2m)

2.5, 3.0, ... , 5.0 (steps 0.5m up to 5m)

Usable for AKM (connector option D, feedback options CA, GE, GF). SFD3/DSL & Brake.

Article	Order code
Hybrid cable (4x1.5+(2x0.34)+(2x0.75))	CCJNA2-015-xxmyy-00
Hybrid cable (4x2.5+(2x0.34)+(2x1))	CCJNA2-025-xxmyy-00

NOTICE

AKD-Nzzz07-DS/DF: For sufficient voltage supply of the feedback system connected to AKD-N/X4, a special connector must be plugged to AKD-N/X5. This special connector is available with order code **AKD-N-JUMP-X5**.

11.11.2 AKD-N to AKM motor power cables

NOTE The motor power should be connected with pre-assembled Kollmorgen cables. The cable shield is connected to drive and motor via the connector housings.



Pin	Signal
A	+BR
B	-BR
C	n.c.
D	n.c.
1	U
	PE
3	W
4	V

Pin	Signal
A	BR+
B	BR-
C	n.c.
D	n.c.
1	U
	PE
3	W
4	V

Maximum cable length 5 m. Length definition: xx=meters, yy=centimeters

0.2, 0.3, ... , 1.0 (steps 0.1m up to 1m)

1.25, 1.5, ... , 2.0 (steps 0.25m up to 2m)

2.5, 3.0, ... , 5.0 (steps 0.5m up to 5m)

Usable for AKM-2 to AKM-7 (connector option 1, 7, B, C, G)

Article	Order code
Motor cable (4x1.5)	CM0NA2-015-xxmyy-00
Motor cable (4x1.5+(2x1))	CM1NA2-015-xxmyy-00
Motor cable (4x2.5)	CM0NA2-025-xxmyy-00
Motor cable (4x2.5+(2x1))	CM1NA2-025-xxmyy-00

11.11.3 AKD-N to AKM motor feedback cables

NOTE

The motor feedback should be connected with pre-assembled Kollmorgen cables. The cable shield is connected to drive and motor via the connector housings.

11.11.3.1 SFD feedback cables AKD-N-DF/DS to AKM Motors

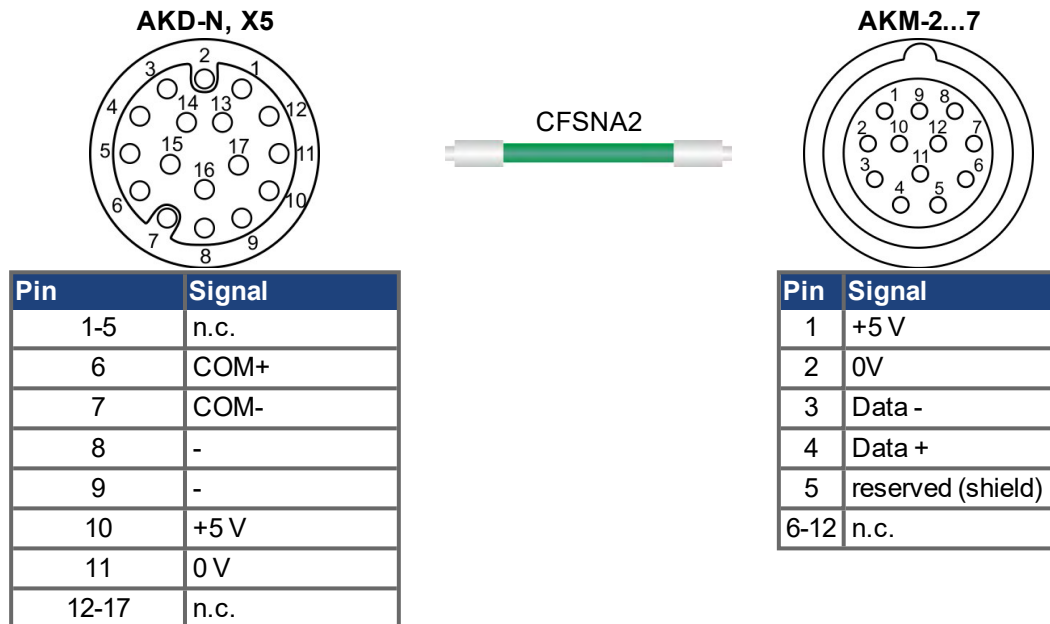

Maximum cable length 5 m. Length definition: xx=meters, yy=centimeters

0.2, 0.3, ... , 1.0 (steps 0.1m up to 1m)

1.25, 1.5, ... , 2.0 (steps 0.25m up to 2m)

2.5, 3.0, ... , 5.0 (steps 0.5m up to 5m)

Usable for AKM-2 to AKM-7 (connector option 1, 7, B, C, G)

Article	Order code
SFD Cable (2x(2x0.25))	CFSNA2-002-xxmyy-00

11.11.3.2 Encoder/ComCoder feedback cables AKD-N-DF/DS to AKM Motors

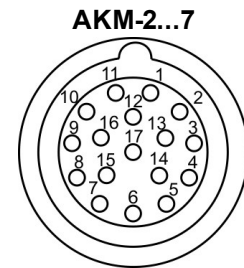
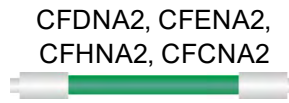
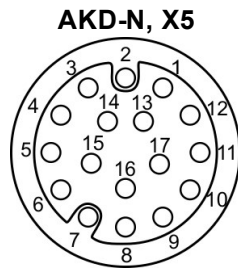

Pin	Signal	Pin	Signal
1	Hall U	10	+5 V
2	Hall V	11	0 V
3	Hall W	12	A+
4	-	13	A-
5	-	14	B+
6	Z +	15	B-
7	Z -	16	-
8	Th+	17	-
9	Th-		

Pin	Signal	Pin	Signal
1	B +	10	+5 V
2	B -	11	n.c.
3	A +	12	n.c.
4	A -	13	n.c.
5	Z +	14	n.c.
6	Z -	15	Hall U
7	0V	16	Hall V
8	TH +	17	Hall W
9	TH -		

Maximum cable length 5m. Length definition: xx=meters, yy=centimeters.

0.2, 0.3, ... , 1.0 (steps 0.1m up to 1m)

1.25, 1.5, ... , 2.0 (steps 0.25m up to 2m)

2.5, 3.0, ... , 5.0 (steps 0.5m up to 5m)

Usable for AKM-2 to AKM-7 (connector option 1, 7, B, C, G)

Encoder

Article	Order codes		
	EnDat 2.2, BiSS C	EnDat 2.1, BiSS B	Hiperface
Encoder Cable (7x(2x0.25))	CFDNA2-002- xxmyy-00	CFENA2-002- xxmyy-00	CFHNA2-002- xxmyy-00

ComCoder

Article	Order code, ComCoder
Comcoder Cable (8x(2x0.25))	CFCNA2-002-xxmyy-00

11.11.4 AKD-B/P/T/M to AKM single (hybrid) motor cables

NOTE

The motor power&feedback should be connected with pre-assembled Kollmorgen single cables. The cable shield is connected to the motor via the connector housing and to the drive with the attached shield clamp.

11.11.4.1 AKD-B/P/T/M to AKM-1 Motor

NOTE

For SFD3 connection to AKD-B/P/T/M, the feedback connector on the drive end contains electronics.

Usable for AKM-1 (connector option D, feedback options C- and CA). A shield clamp is delivered with the cable. Maximum cable length 25 m (steps of 1 m).

**AKD-B/P/T/M,
X2**



**AKD-B/P/T/M,
X10**



CCS1A3, CCJ1A3

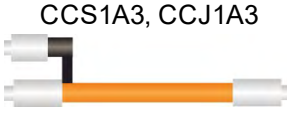

AKM-1

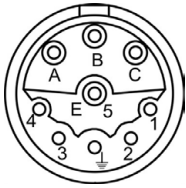

Pin	Signal
1	-BR
2	+BR
3	PE
4	U
5	V
6	W

Pin	Signal
1-5	n.c.
6	COM+
7	COM-
8	-
9	-
10	8 to 9 V
11	0 V
12-15	n.c.

Pin	Signal
1	BR+
2	BR-
3	COM-
4	COM+
5	n.c.
A	U
B	W
C	V
PE	
E	n.c.

(4x1+(2x0.34)+(2x0.75))	Usable to connect	Order code
SFD	AKD-x00306 & x00606* and AKM-1 (connector D, feedback C-)	CCS1A3-010-vvv-00
SFD3 & Brake	AKD-x00306 & x00606* and AKM-1 (connector D, feedback CA)	CCJ1A3-010-vvv-00

*= x means variants B, P, T, or M

11.11.4.2 AKD-B/P/T/M to AKM-2...6

AKD-B/P/T/M series drives have a 15 pole high density SubD female connector to connect the feedback and a terminal connector for power wiring. The hybrid cable is split to power and feedback cables on the drive end.

NOTE

For DSL and SFD3 connection to AKD-B/P/T/M, the feedback connector on the drive end contains electronics.

With shield clamp

Usable for AKM-2 to AKM-6 (connector option D, feedback options CA, GE and GF). A shield clamp is delivered with the cable. Maximum cable length 25 m (steps of 1m).

**AKD-B/P/T/M,
X2**



**AKD-B/P/T/M,
X10**

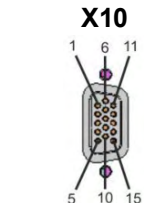

CCJ1A2

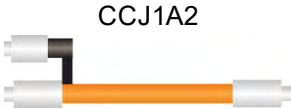

AKM-2...6

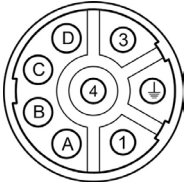

Pin	Signal
1	-BR
2	+BR
3	PE
4	U
5	V
6	W

Pin	Signal
1-5	n.c.
6	COM+
7	COM-
8	-
9	-
10	8 to 9 V
11	0 V
12-15	n.c.

Pin	Signal
A	BR+
B	BR-
C	COM-
D	COM+
1	U
⊕	PE
3	W
4	V

(4x1.5+(2x0.34)+(2x0.75))	Usable to connect	Motor end	Order code
SFD3/DSL & Brake	AKD-x00306 & x00606* and AKM-2...6 (connector D, feedback CA, GE, GF)	SpeedTec	CCJ1A2-015-vvv-00

*= x means variants B, P, T, or M

With shield plate

Usable for AKM-2 to AKM-6 (connector option D, feedback options CA, GE and GF). Drive connector with mounted shield plate. Maximum cable length 25 m (steps of 1 m).

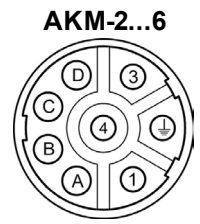
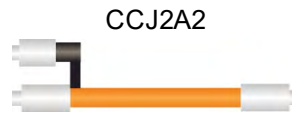
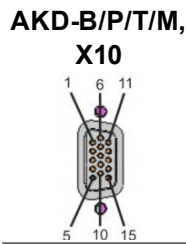
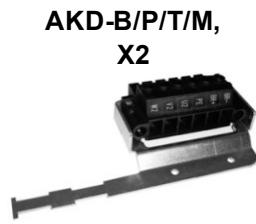

Pin	Signal
1	-BR
2	+BR
3	PE
4	U
5	V
6	W

Pin	Signal
1-5	n.c.
6	COM+
7	COM-
8	-
9	-
10	8 to 9 V
11	0 V
12-15	n.c.

Pin	Signal
A	BR+
B	BR-
C	COM-
D	COM+
1	U
	PE
3	W
4	V

(4xq+(2x0.34)+(2x0.75))	Usable to connect	Motor end	Order code
SFD3/DSL & Brake	AKD-x01206 & x02406 & x00307...x01207* and AKM-2...6 (connector D, feedback CA, GE/GF)	SpeedTec	CCJ2A2-q-vvv-00

*= x means variants B, P, T, or M,

Cross section: (4xq+(2x0.34)+(2x0.75)) with q= 015 for 1.5 mm²; 025 for 2.5 mm²; 040 for 4 mm²

Length vvv= 001 for 1 m ... 025 for 25 m

11.11.5 AKD-B/P/T/M to AKM motor power cables

11.11.5.1 AKD-B/P/T/M (shield clamp) to AKM-1

Connects AKD-x00306* and AKM-1 (connector options 1, Y).

Length definition vvv=meters (steps of 1m). Maximum cable length 50 m, in case of cable length ≥ 25 m a motor choke (\rightarrow # 40)) should be used.

A shield clamp is delivered with the cable.

AKD-B/P/T/M, X2



CM01A3, CM11A3



AKM-1

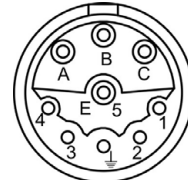

Pin	Signal
1	-BR
2	+BR
3	PE
4	U
5	V
6	W

Pin	Signal
1	BR+
2	BR-
3	n.c.
4	n.c.
5	n.c.
A	U
B	W
C	V
	PE
E	n.c.

Article	Order code
Motor cable (4x1)	CM01A3-010-vvv-00
Motor cable (4x1+(2x1))	CM11A3-010-vvv-00
Motor cable (4x1.5)	CM01A3-015-vvv-00
Motor cable (4x1.5+(2x1))	CM11A3-015-vvv-00

*= x means variants B, P, T, or M

11.11.5.2 AKD-B/P/T/M (shield clamp) to AKM-1...7, up to 22A

Connects AKD-x00306* & AKD-x00606* and AKM-1 to AKM-7 (connector options 1, 7, B, C, G).

Length definition vvv=meters (steps of 1m). Maximum cable length 50 m, in case of cable length ≥ 25 m a motor choke (\rightarrow # 40) should be used.

A shield clamp is delivered with the cable.

AKD-B/P/T/M, X2



AKM-1...7

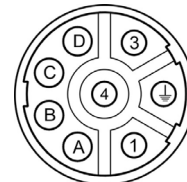

Pin	Signal
1	-BR
2	+BR
3	PE
4	U
5	V
6	W

Pin	Signal
A	BR+
B	BR-
C	n.c.
D	n.c.
1	U
	PE
3	W
4	V

Article	Order code
Motor cable (4x1.5)	CM01A2-015-vvv-00
Motor cable (4x1.5+(2x1))	CM11A2-015-vvv-00

*= x means variants B, P, T, or M

11.11.5.3 AKD-B/P/T/M (shield plate) to AKM-1...7, up to 22A

Connects AKD-x01206* & 02406*, AKD-x00307...x02407* and AKM-1 to AKM-7 (connector options 1, 7, B, C, G).

Length definition vvv=meters (steps of 1m). Maximum cable length 50 m, in case of cable length ≥ 25 m a motor choke (\rightarrow # 40) should be used.

AKD-B/P/T/M, X2



CM02A2, CM12A2



AKM-1...7

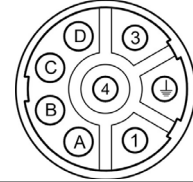

Pin	Signal
1	-BR
2	+BR
3	PE
4	U
5	V
6	W

Pin	Signal
A	BR+
B	BR-
C	n.c.
D	n.c.
1	U
	PE
3	W
4	V

Article	Order code
Motor cable (4x1.5)	CM02A2-015-vvv-00
Motor cable (4x1.5+(2x1))	CM12A2-015-vvv-00
Motor cable (4x2.5)	CM02A2-025-vvv-00
Motor cable (4x2.5+(2x1))	CM12A2-025-vvv-00
Motor cable (4x4)	CM02A2-040-vvv-00
Motor cable (4x4+(2x1))	CM12A2-040-vvv-00

*= x means variants B, P, T, or M

11.11.5.4 AKD-B/P/T/M-024 (shield plate) to AKM-7...8, more than 22A

Connects AKD-x02406* & x02407* and AKM-7xQ / AKM-82T (connector options 1, H). Length definition vvv=meters (steps of 1m). Maximum cable length 50 m, in case of cable length ≥ 25 m a motor choke (\rightarrow #40)) should be used.

AKD-B/P/T/M, X2



CM02A4, CM12A4



AKM-7...8

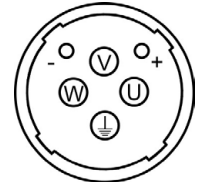

Pin	Signal
1	-BR
2	+BR
3	PE
4	U
5	V
6	W

Pin	Signal
+	BR+
-	BR-
U	U
V	V
W	W
	PE

Article	Order code
Motor cable (4x6)	CM02A4-060-vvv-00
Motor cable (4x6+(2x1.5))	CM12A4-060-vvv-00

*= x means variants B, P, T, or M

11.11.5.5 AKD-B/P/T/M-048 (shield plate) to AKM-7...8, more than 22A

Connects AKD-x04807S* and AKM-7xQ / AKM-82T (connector options 1, H). Length definition vvv=meters (steps of 1m). Maximum cable length 25 m.

AKD-B/P/T/M, X2



AKD-B/P/T/M, X16



CM13A4



AKM-7...8

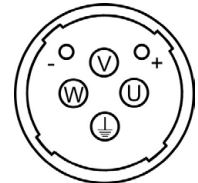

Pin	Signal
1	U
2	V
3	W
4	PE

Pin	Signal
1	+BR
2	-BR

Pin	Signal
+	BR+
-	BR-
U	U
V	V
W	W
	PE

Article	Order code
Motor cable (4x10+(2x1.5))	CM13A4-100-vvv-00
Motor cable (4x16+(2x1.5))	CM13A4-160-vvv-00

*= x means variants B, P, T, or M

11.11.6 AKD-B/P/T/M to AKM motor feedback cables

11.11.6.1 Resolver feedback cables

All our AKM motors feature a 12-pin connector (SpeedTec) for the resolver connection. The AKM-1 motor optionally supports a y-tec connector.

Maximum cable length: 100 m. Length definition: vvv=meters (steps of 1m)

AKD-B/P/T/M, X10



AKD-B/P/T/M, X10



CFR0A2



AKM-1...8

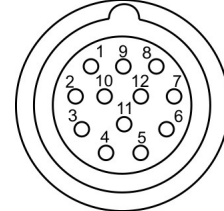

AKM-1

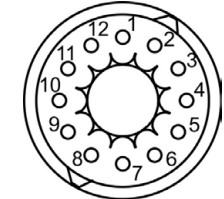

CFR0A3



Pin	Signal
1	-
2	-
3	-
4	-
5	-
6	R1 Ref+
7	R2 Ref-
8	TH+
9	TH-
10	-
11	-
12	S1 SIN+
13	S3 SIN-
14	S2 COS+
15	S4 COS-

Pin	Signal
1	n.c.
2	TH+
3	S4, cos-
4	S3, sin-
5	R2, ref-
6	TH-
7	S2, cos+
8	S1, sin+
9	R1, ref+
10	n.c.
11	n.c.
12	n.c.

Order codes for resolver cables, pre-assembled

(4x(2x0.25))	Order code
Resolver Cable SpeedTec	CFR0A2-002-vvv-00
Resolver Cable y-tec	CFR0A3-002-vvv-00

11.11.6.2 SFD feedback cables

All our AKM motors feature a 12-pin connector (SpeedTec) for the SFD connection. The AKM-1 motor optionally supports a y-tec connector.

Maximum cable length 50 m. Length definition: vvv=meters (steps of 1m)

AKD-B/P/T/M, X10



AKD-B/P/T/M, X10



AKM-1...8

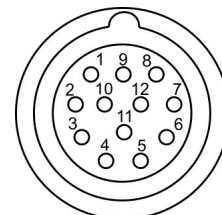

AKM-1

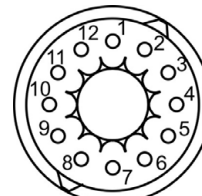

CFS0A2



CFS0A3



Pin	Signal
1	n.c.
2	n.c.
3	n.c.
4	SEN+
5	SEN-
6	COM+
7	COM-
8	n.c.
9	n.c.
10	+5 V
11	0 V
12	n.c.
13	n.c.
14	n.c.
15	n.c.

Pin	Signal
1	Up
2	0V
3	Data-
4	Data+
5	n.c.
6	n.c.
7	n.c.
8	n.c.
9	n.c.
10	n.c.
11	n.c.
12	n.c.

Order codes for SFD cables, pre-assembled

(2x(2x0.25))	Order code
SFD Cable SpeedTec	CFS0A2-002- <i>vvv</i> -00
SFD Cable y-tec	CFS0A3-002- <i>vvv</i> -00

11.11.6.3 Encoder/ComCoder feedback cables

All our AKM motors feature a 17-pin connector (SpeedTec) for the encoder connection (EnDat, HIPERFACE, BiSS etc.). The AKM-1 motor optionally supports a 15-pin y-tec connector. Length definition: vvv=meters (steps of 1m)
 Maximum cable length EnDat 2.1, BiSS B, Hiperface: 50 m
 Maximum cable length EnDat 2.2, BiSS C, ComCoder: 25 m.

AKD-B/P/T/M, X10



CFD0A2, CFE0A2, CFH0A2, CFC0A2



AKD-B/P/T/M, X10



CFH0A3, CFC0A3



AKM-1...8

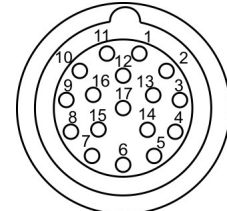

AKM-1

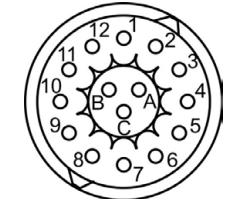

Pin	Signal
1...15	Pinout depends on feedback type. Refer to AKD Installation Manual for details.

Pin	Signal
1..12	Pinout depends on feedback type. Refer to AKM Instructions Manual for details.

The AKD-B/P/T/M series drives offer a second feedback interface with a 9 pole Sub-D male connector (X9) for the connection of EnDAT 2.2 encoders as primary feedback. Thermal protection must be connected to analog I/Os input located on connector X8.
 Maximum cable length: 50 m. Length definition: vvv=meters

AKD-B/P/T/M, X9/X8

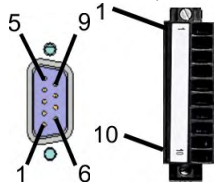

CFD5A2



AKM-1...8

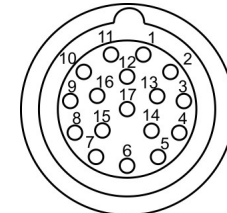

Order Codes Encoder cables, configured

(7x(2x0.25))	EnDat 2.2, BiSS C	EnDat 2.1, BiSS B	Hiperface
Encoder cable SpeedTec (X10)	CFD0A2-002- vvv-00	CFE0A2-002- vvv-00	CFH0A2-002- vvv-00
Encoder cable SpeedTec (X9, X8)	CFD5A2-002- vvv-00	-	-
Encoder cable y-tec (X10)	-	-	CFH0A3-002- vvv-00

Order Codes ComCoder cables, configured

(8x(2x0.25))	Order code
Comcoder cable SpeedTec	CFC0A2-002- vvv-00
Comcoder cable y-tec	CFC0A3-002- vvv-00

11.12 AKM[®]2G Cables

For connection of second generation products AKM[®]2G and AKD[®]2G with AKM or AKD, refer to the *Kollmorgen 2G Cable Guide*:



The guide is available from the Kollmorgen Website.

-- / --

12 Record of Document Revisions

Edition	Comments
09/2015	Motor cables for AKD-x04807 added, mating connector X5-JUMP for AKD-N new, cabinet connector coupling for decentral drive system removed, notes for slip rings and IP67 grommets, revision history restructured, CFD5A1 cable added. Sxyz contents removed. First AKD-only revision.
12/2015	Cable section restructured, Order code Heat conducting film AKD-N updated, KCM 24A limitation
09/2016	AKD-N012 accessories added, warning notes format updated, SpeedTec cables added
10/2017	AKD-N cables: references to AKM1 removed, recommended cable types (AC, RBext, DC-Bus) corrected, reference to safe Stemmman slip rings added
02/2018	AKD-N heat sink 40 mm removed, Trademark list added, SpeedTec spelling corrected
11/2019	Warning notes layout updated, user expertise updated, new readers note cover page, cable section updated, AKD2G accessories added, AKM2G cables added, AKD-N connector tool, new section mating connectors / adapters

Service

We are committed to quality customer service. In order to serve in the most effective way, please contact your local sales representative for assistance.

If you are unaware of your local sales representative, please contact the Customer Support.



Join the [Kollmorgen Developer Network](#) for product support. Ask the community questions, search the knowledge base for answers, get downloads, and suggest improvements.

Europe

KOLLMORGEN

Internet: www.kollmorgen.com/en-us

E-Mail: technik@kollmorgen.com

Tel.: +49 - 2102 - 9394 - 0

Fax: +49 - 2102 - 9394 - 3155



North America

KOLLMORGEN

Internet: www.kollmorgen.com/en-us

E-Mail: support@kollmorgen.com

Tel.: +1 - 540 - 633 - 3545

Fax: +1 - 540 - 639 - 4162



South America

KOLLMORGEN

Internet: www.kollmorgen.com/pt-br

E-Mail: contato@kollmorgen.com

Tel.: +55 - 11 - 4615-6300



Asia

KOLLMORGEN

Internet: www.kollmorgen.cn

E-Mail: sales.china@kollmorgen.com

Tel: +86 - 400 668 2802

Fax: +86 - 21 6248 5367

