

Model 6445 Stepper Drive Packages Microstepping Indexer Drive Package

FEATURES

- Powered off-line 120/240 Vac 60/50 Hz
- Patented 4-phase Bipolar Chopper Drive for superior current regulation and low ripple current
- Output current adjustable from 0.625 A to 5 A rms with 3 position DIP switch
- Patented Digital Electronic Damping™ reduces instability at mid-speed ranges
- Adjustable Idle current reduction reduces motor heating in many applications
- Power Supply Fault Production
 - Over temperature
 - Short circuit
 - Under voltage
- Drive Fault Protection
 - Line to line
 - Line to neutral
 - Microprocessor
- 66 Vdc output supply to power additional axis
- Internal fan cooling
- Microstepping up to 51,200 steps/revolution
- Master/slave, two axis control
- Easy programming using Pacific Scientific's Stepper BASIC™
- Dedicated and user configurable I/O
- Encoder interface for position verification
- Single and Multi-drop serial communication
- 16 user configurable inputs
- 12 user configurable outputs
- UL and CSA recognition pending
- CE conformance pending

APPLICATIONS

- Clutch Brake Replacement
- Master/Slave Shaft Following
- Labeling Machines
- Feed to Length
- Menu Prompt (Simple MMI)

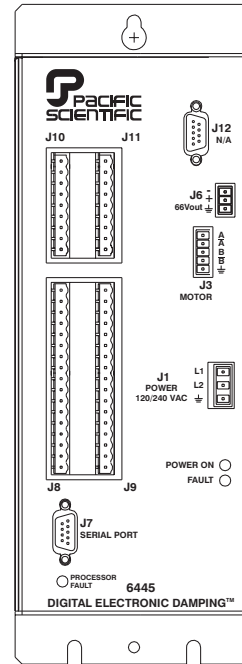

Photo not available at time of printing

PRODUCT DESCRIPTION

The Pacific Scientific 6445 is an economical high performance microstepping drive combined with a programmable indexer. The package uses an RS232/485 port to allow single or multi-axis communication at 9600 baud. 16 programmable inputs and 12 programmable outputs are compatible with standard 5 to 30 Vdc I/O. The 6445 features a 12K battery backed RAM for storage of parameters and move profiles. Motion control programming is simplified with PacSci Stepper BASIC™, an easy to learn extension of the BASIC™ protocol.

Resolution with 1.8° motors range from 200 to 51,200 steps per revolution. Step sizes in decimal increments. Higher resolution (microstepping) provides smoother operation through low speed resonance regions.

A patented Digital Electronic Damping™ circuit ensures the availability of full motor torque at all speed ranges. This compensation damps motor oscillations common with stepper systems. Whether in the full step or microstepping mode, full motor torque is achieved throughout the speed range.

Adjustable Idle Current Reduction permits an automatic 50% reduction in motor winding current during motor idle conditions to minimize heating during dwell periods. If no step commands have been received for 0.1 seconds, the current is automatically reduced.

Current is restored to full amplitude upon arrival of a step command. The 6445 accepts quadrature encoder inputs to perform position verification and correction, stall detection and electronic gearing functions. A quadrature encoder with line driven outputs is required.

A 66 Vdc output voltage is provided to power an additional axis.

SPECIFICATIONS

INPUT POWER

Voltage	120/240 Vac (+ 10%, -15%) 60-50 Hz (switch selectable)
Line Current	At full (300W) load 240 Vac, 3.7 A rms 120 Vac, 4.7 A rms
Output Motor Phase Current	5 A rms max., 5 A peak full step (square wave) 7.1 A peak microstepping (sine wave). Adjustable from 0.625 to 5 A rms in 0.625 A rms increments
66 Vdc Output For 2nd Axis (J6)	66 ±3 volts. Total power (internal + external) = 300W ±10%
Discrete Inputs	5 Vdc pull up. See figure on following page for discrete wiring.
Discrete Outputs	50 mA sink max. @ 0.5 Vdc Vce 40 Vdc max. See figure on following page for discrete wiring

ENVIRONMENTAL REQUIREMENTS

Storage temperature	-40° C to +70° C
Operating temperature	0° C to 50° C ambient (with internal fan)
Altitude	5000 ft (1500m) by design
Humidity	10% to 90%, non-condensing by design
Vibration	IEC Standard 68-2-6 Pending

MECHANICAL

Dimensions	6.30" x 4.25" x 12.50"
Weight	10 lbs. nominal

CONNECTORS

66 Vdc output	PCD ELVHØ31Ø. Mating connector: PCD ELVPØ31ØØ
Motor	PCD ELVHØ51Ø. Mating connector: PCD ELVPØ51ØØ
AC Input	PCD ELFHØ311Ø. Mating connector: PCD ELFPØ311Ø
Serial	9 contact female D connector, Mating connector: ITT Cannon DE-9P with ITT Cannon DE110963 Hood and D20419 Clamp Kit. Power supply
I/O	Double height 17 position, pluggable screw terminal Phoenix connector: MSTB2,5/17-ST(x2)
Encoder Input and Step/Direction	Double height 9 position, pluggable screw terminal Phoenix connector: MSTB2,5/9-ST(x2)

CONNECTION DIAGRAM

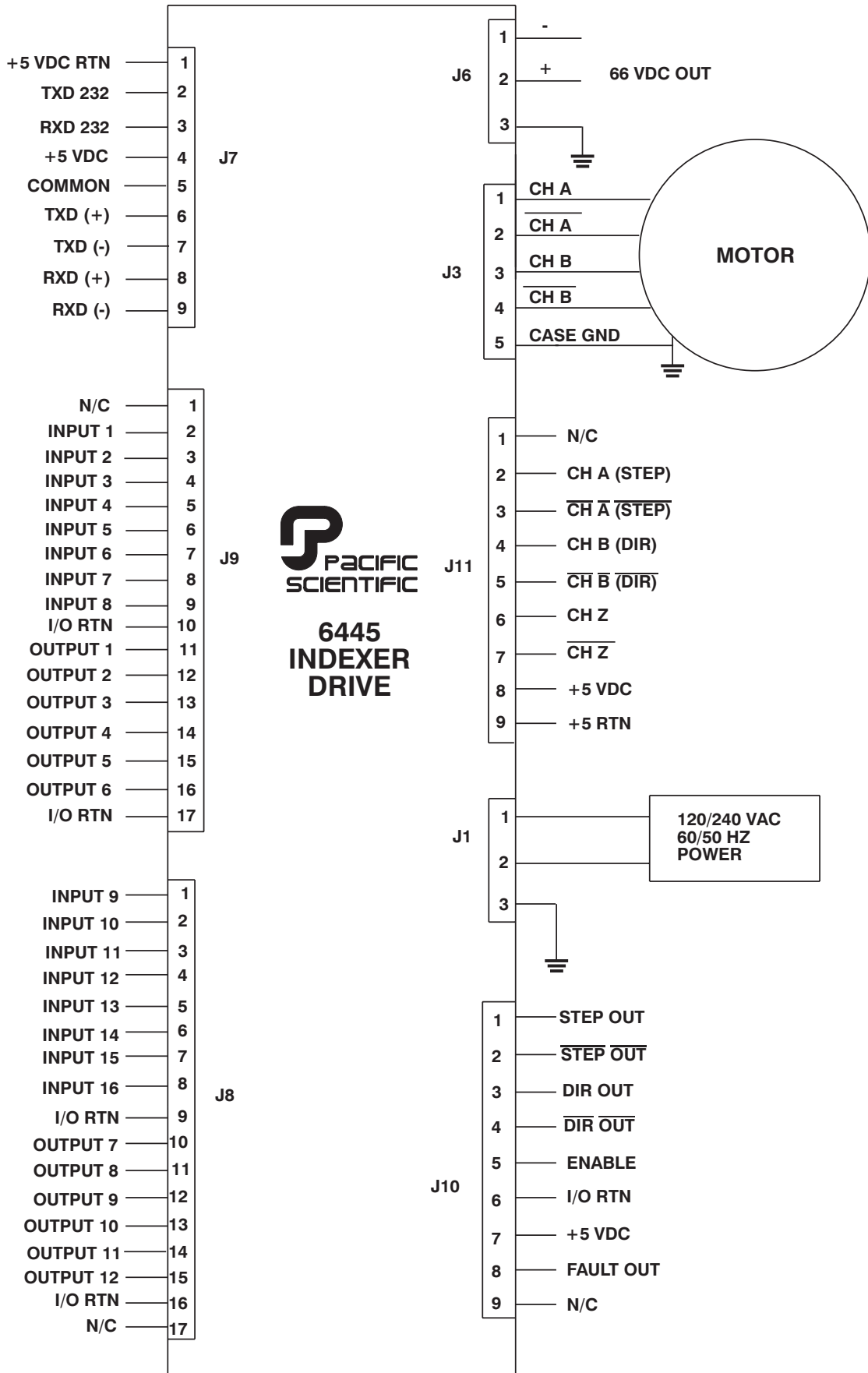

OUTPUT DIFFERENTIAL WIRING

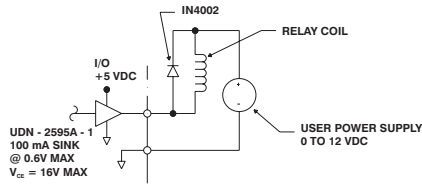

RELAY LOAD

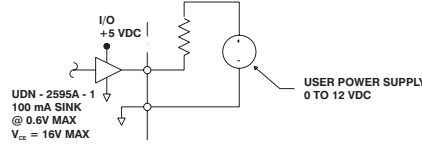

RESISTIVE LOAD

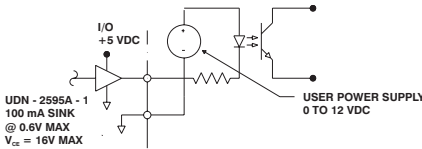

OPTO-ISOLATOR LOAD

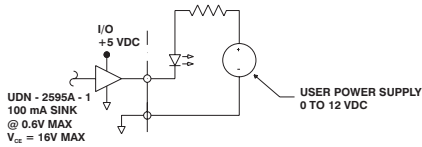

LED INDICATOR LOAD

DISCRETE INPUT CONFIGURATION

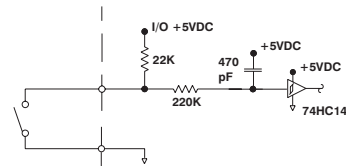

SWITCH RELAY CONTACT

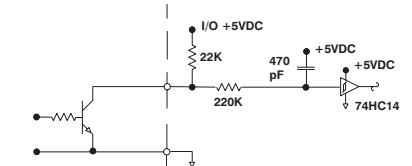

OPEN COLLECTOR

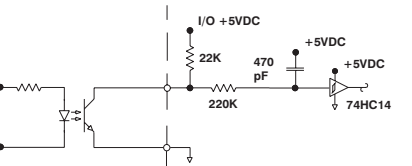

OPTO-ISOLATOR

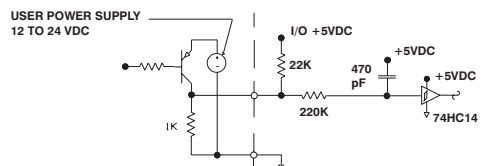

SOURCING TRANSISTOR

DIP SWITCH (S1) SETTINGS

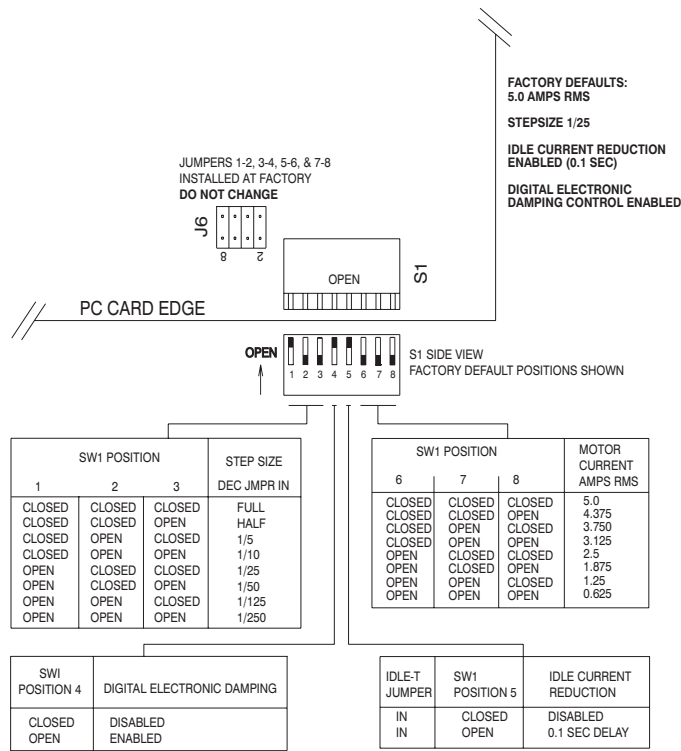

SERIAL ADDRESS (S2)

Address	1	2	3	4	5	Address	1	2	3	4	5
0	On	On	On	On	On	16	On	On	On	On	Off
1	Off	On	On	On	On	17	Off	On	On	On	Off
2	On	Off	On	On	On	18	On	Off	On	On	Off
3	Off	Off	On	On	On	19	Off	Off	On	On	Off
4	On	On	Off	On	On	20	On	On	Off	On	Off
5	Off	On	Off	On	On	21	Off	On	Off	On	Off
6	On	Off	Off	On	On	22	On	Off	Off	On	Off
7	Off	Off	Off	On	On	23	Off	Off	Off	On	Off
8	On	On	On	Off	On	24	On	On	On	Off	Off
9	Off	On	On	Off	On	25	Off	On	On	Off	Off
10	On	Off	On	Off	On	26	On	Off	On	Off	Off
11	Off	Off	On	Off	On	27	Off	Off	On	Off	Off
12	On	On	Off	Off	On	28	On	On	Off	Off	Off
13	Off	On	Off	Off	On	29	Off	On	Off	Off	Off
14	On	Off	Off	Off	On	30	On	Off	Off	Off	Off
15	Off	Off	Off	Off	On	31*	Off	Off	Off	Off	Off

S2 SWITCH SETTINGS

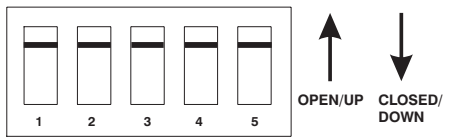

ON = Closed/Down Position
OFF = Open/Up Position

Note: Switches S1 and S2 are easily accessed without removing the cover.

1. Switch settings must be made when the unit is unpowered.
2. Address 31 is for RS-232 operation, all others are for RS-422/485.

Note: RS-232 operation factory default

MOUNTING DIMENSIONS

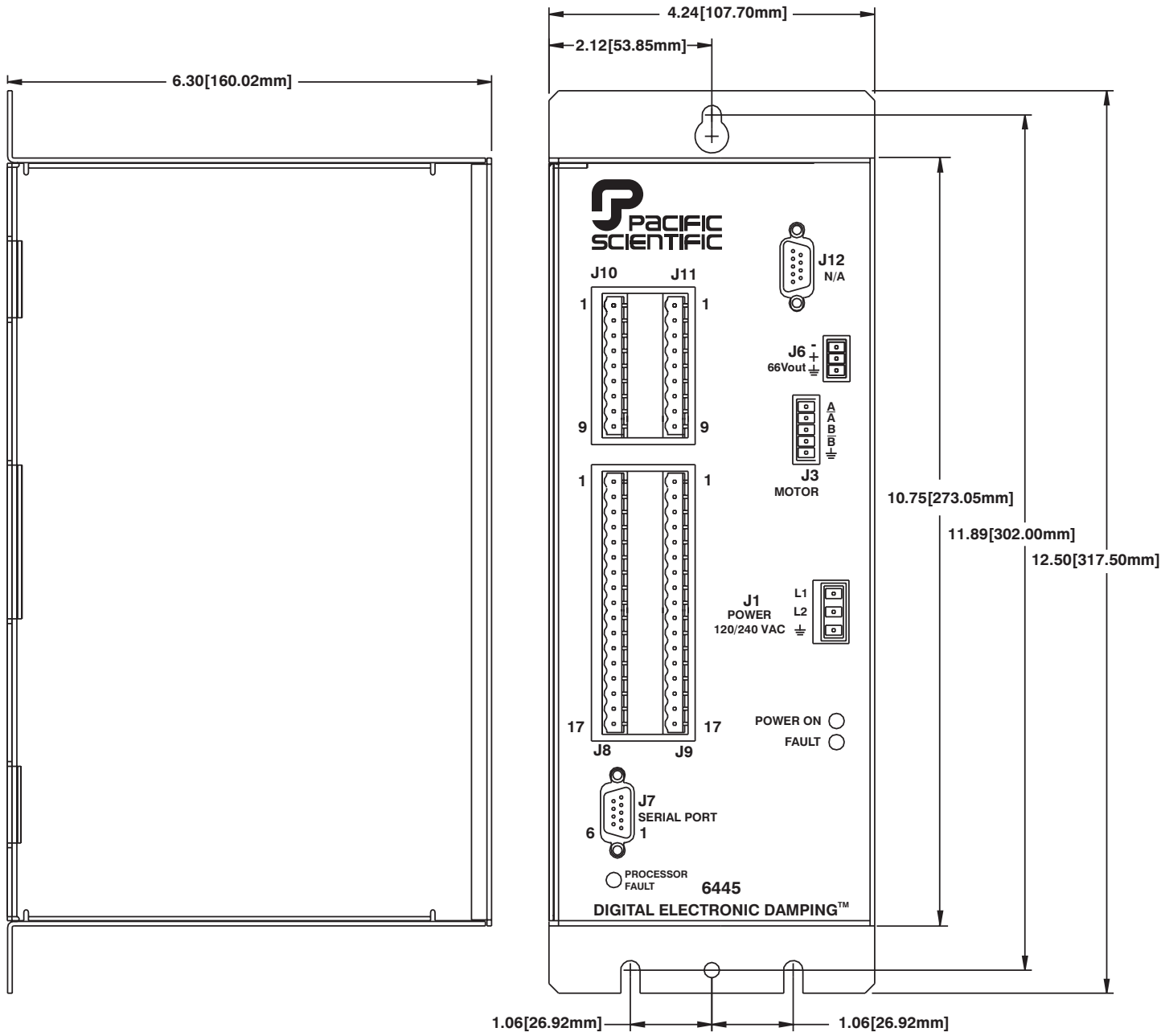

AC SWITCH SETTINGS

The AC switch is preset at the factory in the 230 Vac position. The AC switch settings are accessible by opening the cover. First, **make certain the power connections have been removed.** Rest the unit on its side as shown. Unscrew four screws and two jack screws as shown in diagram to remove cover. **Cautiously remove cover, being careful not to put a strain on the ribbon cable or power supply cable.** Select appropriate setting. Replace cover and mounting screws. **DO NOT** over tighten mounting screws. (5.0 in-lbs max).

Note: Connecting 240 (230) Vac with switch in 120 (115) Vac position will permanently damage the drive.

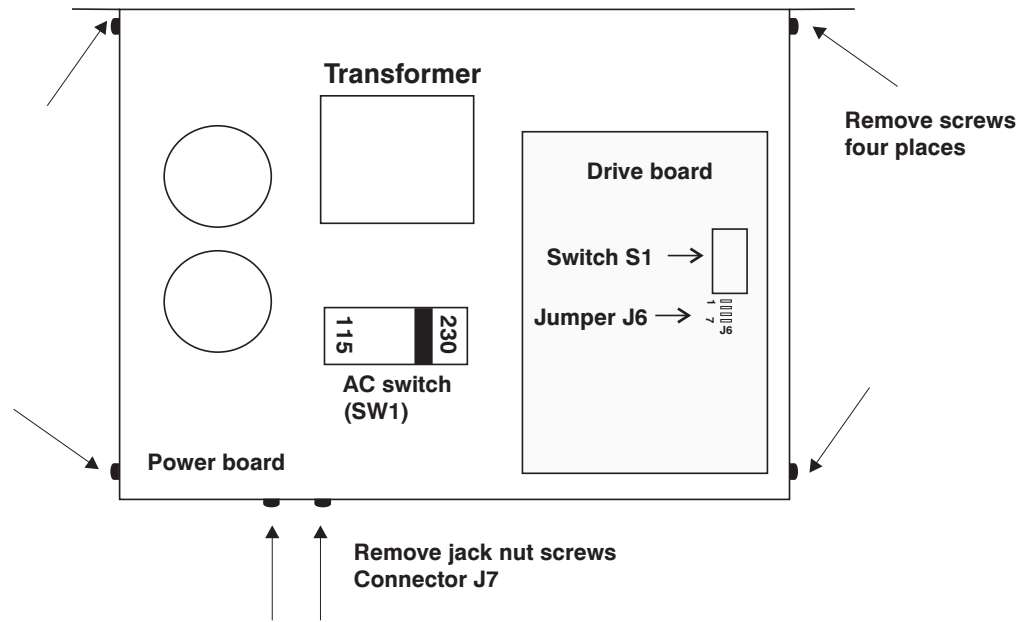

66 VDC OUTPUT CONNECTOR J6

The 6445 package has a connector J6, 66 Vdc, designed to power an additional drive. The total power available for both the internal and external drives is 66 Vdc @ 4.6 Amps or approximately 300 Watts. If the two drives are running simultaneously and require more than 4.6 Amps, the voltage will begin to cut back. The power supply has a low voltage protection circuit that will fault the drive if the voltage is less than 55 Vdc.

A twisted pair plus ground cable utilizing 16, 18, or 20 gauge wire, is recommended to connect the remote connector to the external drive. A maximum of 1000 μ F, 100 Vdc aluminum electrolytic capacitor, rated for 2A ripple current or greater, must be installed at the additional drive if the cable length is over 3 feet.

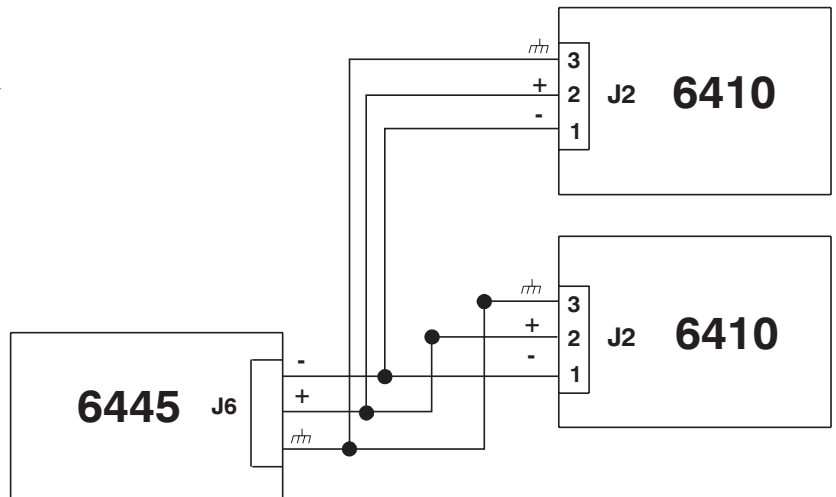

TROUBLESHOOTING

Fault LED ON - 6445 Disable Fault

SYMPTOM	POSSIBLE CAUSE	ACTION
Motor does not turn, LEDs ON (green and/or red)	120/240 Vac switch in 240 position, input from 120 Vac	Turn power off, correct switch position.
	AC Input line low	Increase Input AC to spec.
	Dead short or overload across external 66 Vdc output connector (J6).	Remove short or reduce load.
	Over temperature	Check ambient temperature or internal fan malfunction/blockage.
	Bad load connection	Check load connection. Check J6 Vdc output with a voltmeter and ensure output voltage is 66V \pm 3V. 1. If output voltage > 70 Vdc and < 78 Vdc add a load and ensure Vdc is \approx 66Vdc. 2. If output voltage > 78 Vdc, return 6445 to factory for service.
	Internal failure.	Return to factory for service.
Motor does not turn, LEDs OFF	Check AC input	Use proper input.
	240 Vac applied and switch in 120 Vac position.	Return to factory for service.
Motor runs for a while and stops, both LEDs come on	Over temperature.	Reduce load. Check for excessive ambient temperature. Check for internal fan malfunction/blockage.
Motor turns on and off on its own (although no such commands are given) and red LED keeps flashing	120 Vac applied and switch in 240 Vac position	Correct switch position.
	Over load.	Reduce load.
	AC input line low.	Check input AC line voltage for low line.
Red LED turns ON when motor tries to accelerate, motor does not turn	Load is too high, AND/OR Accel/decel are too high, AND/OR Run speed is too high.	Reduce the load, accel/decel and/or run speed.

Red LED Flashing, but NO FAULT **Note:** *If the power supply is on the verge of an under-voltage fault, you will notice the following during normal operation.*

SYMPTOM	POSSIBLE CAUSE
Motor runs fine, red LED flashes	Load is too high, AND/OR Accel/decel are too high, AND/OR Run speed is too high.

Although no action is required, the above symptoms may be eliminated by reducing the load, accel/decel and/or run speed.

Processor Fault LED ON

SYMPTOM	POSSIBLE CAUSE	CORRECTIVE ACTION
Drive faults when enabled.	Motor output overcurrent.	Disconnect the AC power. Disconnect motor cable and cycle the J1 120/240 Vac 60/50 Hz power Off and On. If the PROCESSOR FAULT LED is OFF, check motor cable and motor for shorts across the windings or between the windings and the motor case.
Drive faults while decelerating.	Drive internal bus over voltage.	Measure drive internal bus voltage at J6-1 and J6-2 (66 Vdc Out) with a storage oscilloscope during deceleration. If regeneration causes the bus voltage to exceed 84 V, verify the system load inertia to insure that the 66 Vdc out limit is never exceeded.
PROCESSOR FAULT LED on when power is applied.	Indexer external +5V logic supply out of tolerance	Measure the +5 V Logic Supply at J7-4 to J7-1 and J10-7 to J10-6 within +5V ($\pm 5\%$). Note: <i>The total 5 Vdc current from pins J7-4, J11-8 and J10-7 must be less than 450 mA.</i>
	Indexer processor watchdog timer failed.	Internal Failure. Return to factory for service.

Communications Interface Fault

SYMPTOM	CORRECTIVE ACTION
6445 will not respond to commands over serial link	Verify that baud rate and COM port are set correctly in PacCom.
	Check that terminal transmit and receive lines from computer go to receive and transmit lines on the 6445.
	Verify that serial cable is functioning properly. 1. Disconnect serial cable. 2. Short pins 2 & 3. 3. Type a character on keyboard. 4. Verify that character entered echoes back to screen.
	Verify that serial cable is connected to J7. Note: <i>J12 is not used on the 6445.</i>
	Internal Failure. Return to factory for service.
6445 will not respond during RS-422/ RS-485 operation	Verify that each unit has a unique serial address using switch S2.

PERFORMANCE - 6400 SERIES CONTROLS

Motors will perform as shown without the winding temperature exceeding a rise of 90°C. When the motor is operated unmounted (without heat sink) in an ambient temperature of up to 40°C. The curves do not reflect systems resonance points, which will vary with motor coupling and systems parameters.

In addition to those shown below, Pacific Scientific offers a wide range of other motor windings to meet specific performance requirements.

Torque/Speed Curves - Recommended Motors for 5.0 A operation

(3" MOTOR-ONE ROTOR STACK)

E31NX-HTLNN-NS50
5.0A/65V PER PHASE

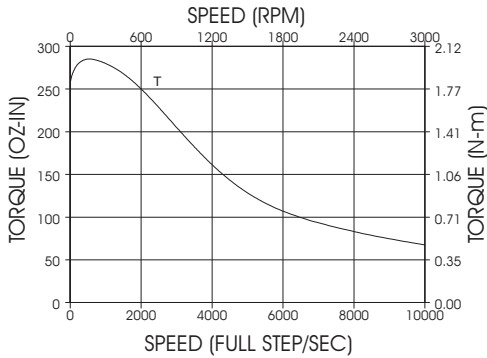

(3" MOTOR-TWO ROTOR STACK)

E32NX-HTLNN-NS50
E32NX-HPLNN-NS50
5.0A/65V PER PHASE

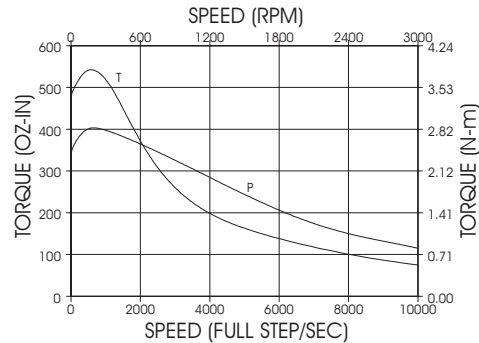

(3" MOTOR-THREE ROTOR STACKS)

E33NX-HTLNN-NS50
E33NX-HPLNN-NS50
5.0A/65V PER PHASE

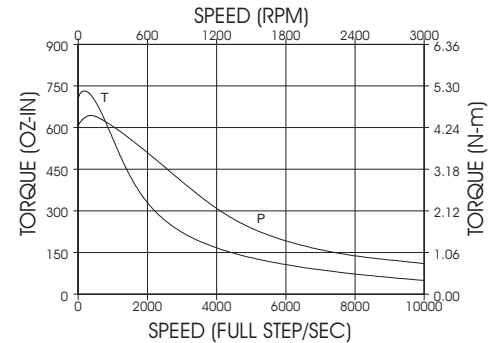

(3" MOTOR-FOUR ROTOR STACKS)

E34HX-HTLNN-NS50
E32HX-HPLNN-NS50
5.0A/65V PER PHASE

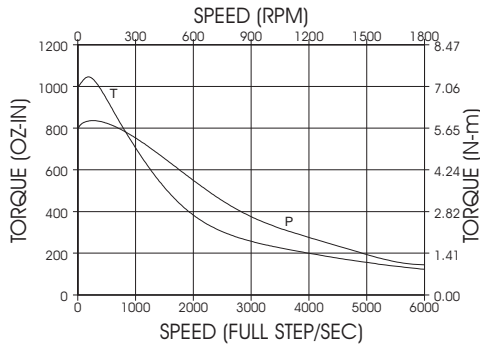

(4" MOTOR-ONE ROTOR STACK)

E41HX-HTLNN-NS50
5.0A/65V PER PHASE

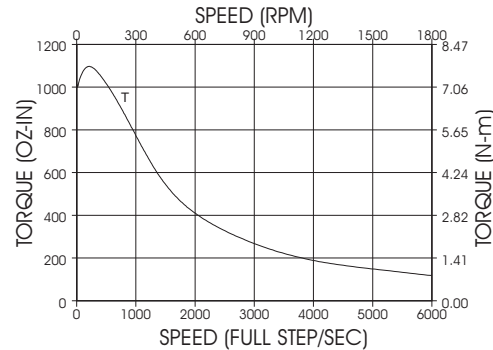

Torque/Speed Curves - Recommended Motors for 2.5 A operation

(3" MOTOR-ONE ROTOR STACK)

E31NX-LTLNN-NS50
E31NX-LPLNN-NS50
2.5A/65V PER PHASE

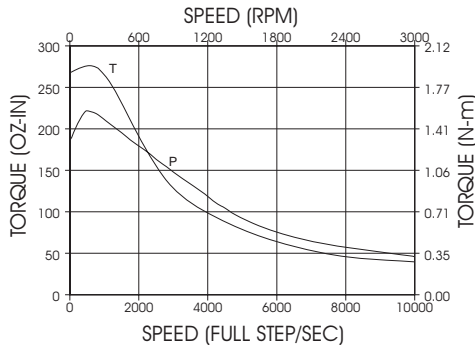

(3" MOTOR-TWO ROTOR STACK)

E32NX-LTLNN-NS50
E32NX-LPLNN-NS50
2.5A/65V PER PHASE

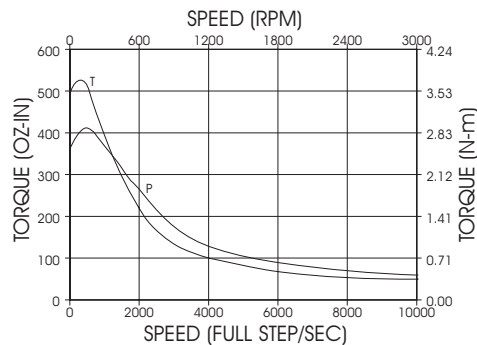

(2" MOTOR-TWO ROTOR STACKS)

E22NX-LTLNN-NS50
E22NX-LPLNN-NS50
2.5A/65V PER PHASE

