

TBM2G

Frameless Motors

Exceptional performance. No customization required. Robot ready.

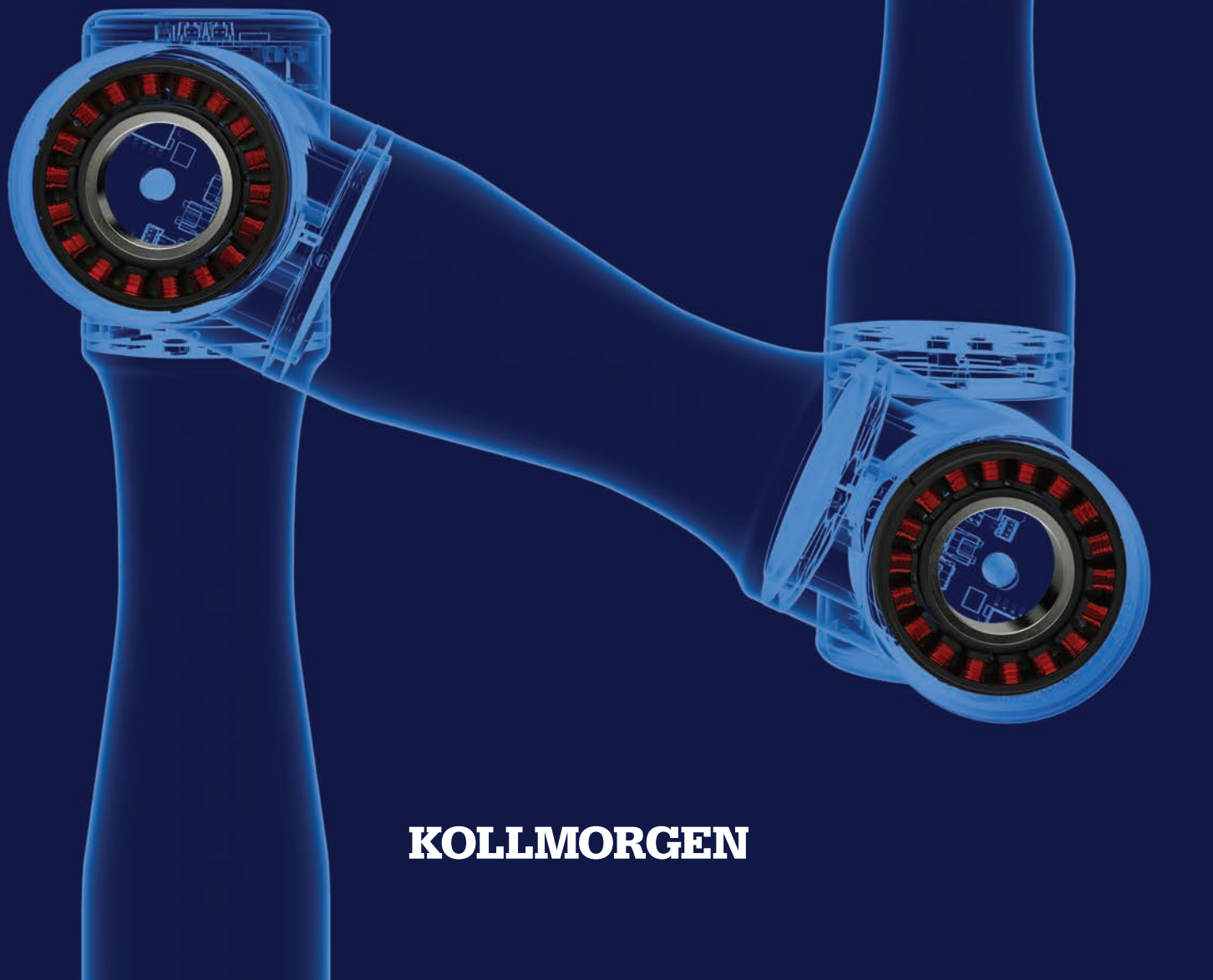

KOLLMORGEN

Simply Better Design

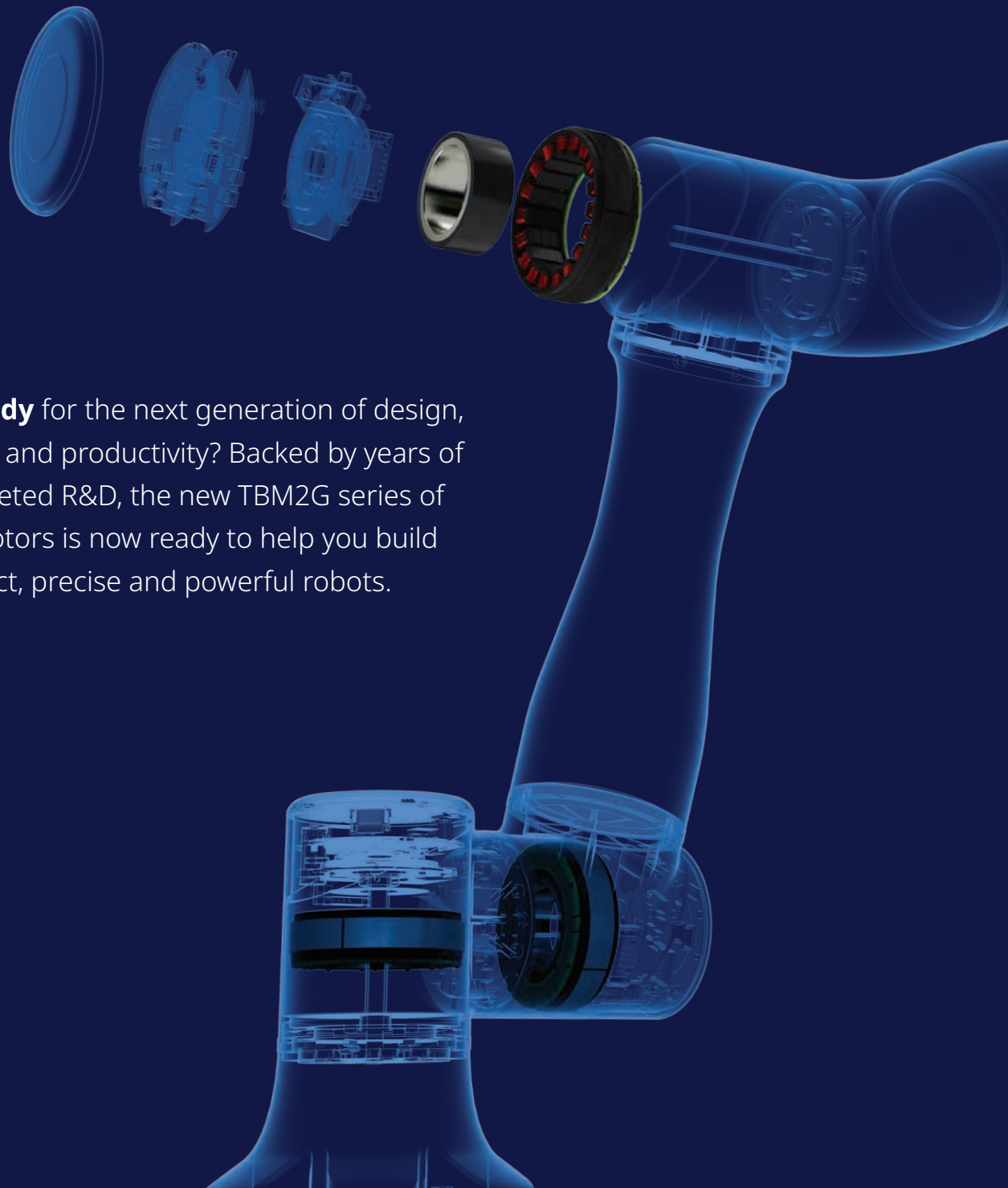

Are You Ready for the next generation of design, performance and productivity? Backed by years of robotics-targeted R&D, the new TBM2G series of frameless motors is now ready to help you build more compact, precise and powerful robots.

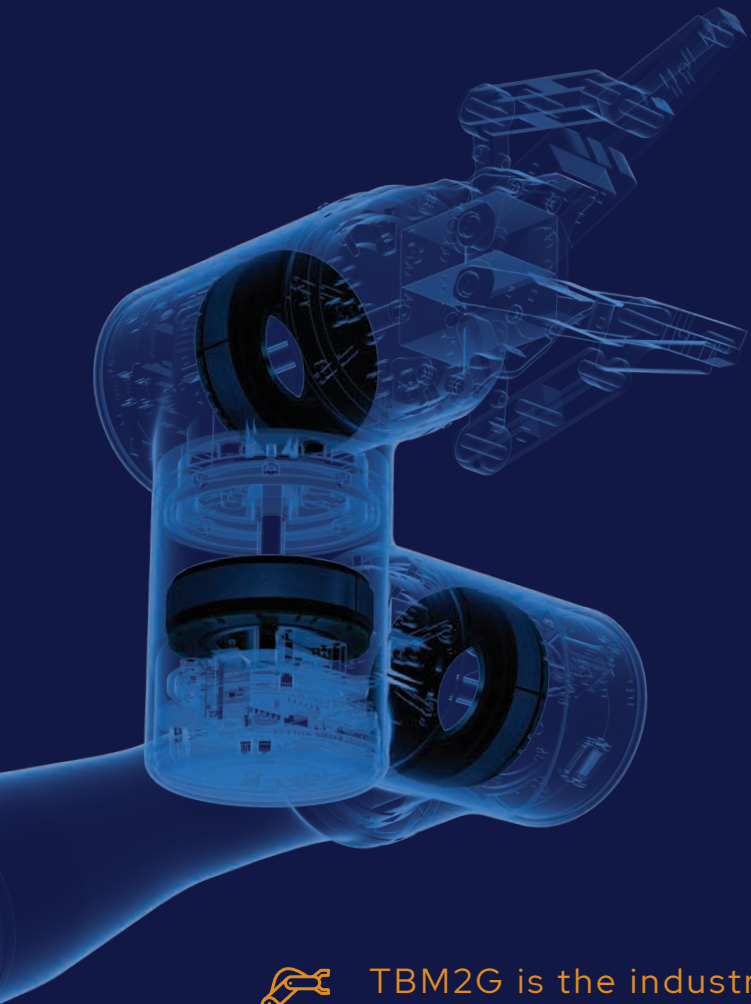

TBM2G is the industry's first line of motors created to be fully **Robot Ready**.

These frameless servo motors are purpose-built to address the unique design challenges, performance demands and scalability requirements of advanced robotics.

Ready to fit your design, with standard sizing optimized to pair with off-the-shelf harmonic gearing designs without modification.

Ready to perform, with high torque in a compact package, delivered smoothly and consistently across all speeds and performance demands.

Ready to scale, with highly automated manufacturing in place to ensure reliable quality and delivery at any volume, globally, so you can succeed in every market.

Kollmorgen Is Ready to partner with you. With more than a century of leadership in motion control, we are an indispensable partner for today's most innovative robotics projects. We work directly with design teams to bring high-performance motion to collaborative robots, industrial articulated robots, surgical robots and more. TBM2G joins our complete offering of motion solutions and expertise to solve your most demanding robotic motion challenges. So let's get started.

TBM2G Frameless Motors

Fit the Motor to Your Design

There is no need to compromise your design to accommodate the motor. TBM2G motors are designed to fit off-the-shelf harmonic gearing. They feature an exceptionally short total height and large thru-bore. And they are optimized to meet the typical size, weight, speed, torque and temperature requirements of high-performance, high-precision applications such as collaborative robots in the 15 kg and under class.

Kollmorgen offers the standard options you need to achieve your design requirements and technical specifications with confidence. So you can accelerate the design process to create light, compact robotic joints that meet your performance standards without compromise.

Expect Unprecedented Performance

TBM2G motors deliver significantly higher torque density in a more compact form factor compared to other frameless motors. And they incorporate advanced materials, windings and options to deliver more consistent performance for your application, across a wide range of speeds and torque requirements.

By meeting your performance goals with the shortest and lightest electromagnetics package, you can achieve faster, smoother robotic movements with lower joint weight, higher load capacity, greater energy efficiency and lower thermal rise.





TBM2G: Ready to Deliver More

- Optimized to pair with off-the-shelf harmonic (strain wave) gearing designs.
- Large inner diameter thru-bore to accommodate encoders, cables, hoses, shafts, tools, etc.
- Seven most popular frame sizes used in collaborative robots and embedded equipment.
- Designed for operation at 48 VDC and below, ideal for mobile applications.
- Optional integrated Hall sensors that don't increase motor length.
- Multiple standard thermal sensor options to match the most popular drives in the robotics market.
- Windings optimized for speed and torque requirements of 3.5 to 15 kg collaborative robots.
- Optimized to deliver full performance with less heat, extending the life of lubricants, electronics and other robotic joint components.

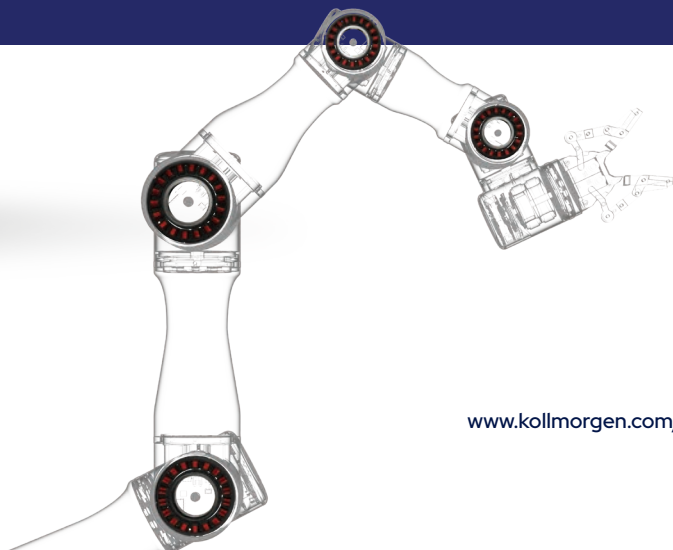

TBM2G Frameless Motors

Go to Market with Confidence

As a standard Kollmorgen series of motors, including standard modifications to meet your exacting requirements, TBM2G motors are available for prototyping with short lead times, supported by local experts in every region of the world.

When you are ready to go to market, Kollmorgen's advanced manufacturing allows you to ramp up production quickly. You can count on having the motors you need, with full assurance of quality and consistency, wherever you manufacture your robots.

Count on Kollmorgen Partnership

Kollmorgen is the market leader, defining the standard of excellence for robotic motion. Our senior engineers have decades of robotics motion experience, providing you with direct collaborative expertise to help bring more sophisticated and capable robots to market faster.

With our global footprint of manufacturing, design, application and service centers, you always have access to dependable supply, co-engineering expertise, and personalized support that no other partner can provide—throughout the design phase and full lifecycle of your robot. We'll help you engineer the exceptional.

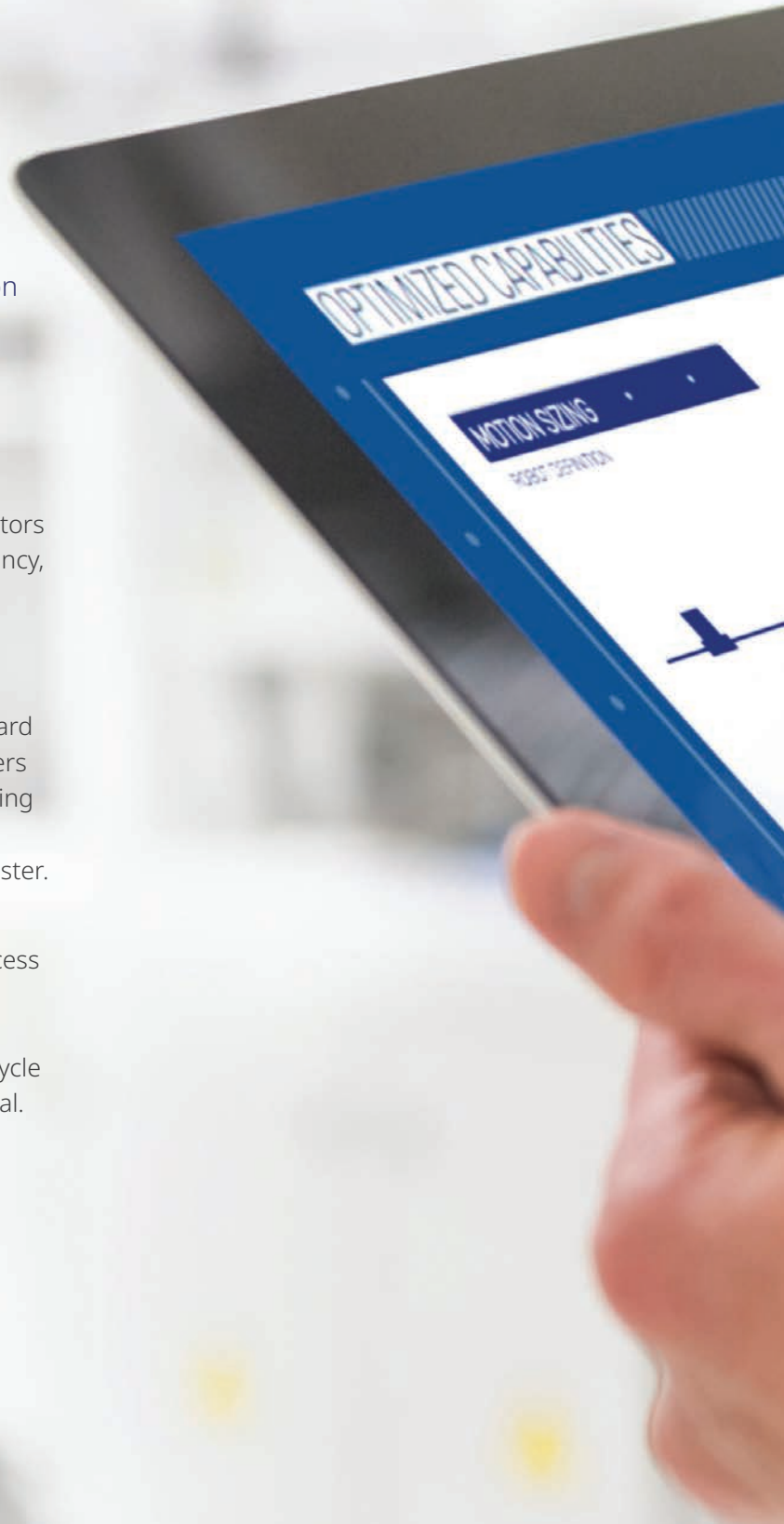

Kollmorgen: Ready to Partner for Your Success

- Automated processes to rapidly scale from prototype to mass production.
- Highly precise manufacturing for consistent performance.
- Co-engineering expertise to help you achieve ideal specifications and fit.
- Global manufacturing and distribution.
- Local application support and service.
- The resources and commitment to ensure consistent supply for years to come.
- More than a century of leadership in motion control.



TBM2G Frameless Motors

Performance Data

			Frame											
			TBM2G-050xx			TBM2G-060xx			TBM2G-068xx			TBM2G-076xx		
Parameters	Sym	Units	08	13	26	08	13	26	08	13	26	08	13	26
Continuous Torque at Stall	T_c	Nm	0.27	0.38	0.64	0.45	0.6	0.96	0.63	0.86	1.54	0.89	1.13	2.06
		lb-in	2.39	3.36	5.66	3.98	5.31	8.5	5.58	7.61	13.6	7.88	10	18.2
Rated Speed	N_{rtd}	rpm	8000	8000	6700	8000	8000	4200	8000	6600	3300	8000	6600	2900
Motor Constant	K_m	Nm/ \sqrt{W}	0.061	0.083	0.128	0.087	0.114	0.176	0.119	0.157	0.251	0.157	0.193	0.324
		lb-in/ \sqrt{W}	0.54	0.74	1.13	0.77	1.01	1.56	1.05	1.39	2.22	1.39	1.71	2.87
Rated Power	P_{rtd}	kW	0.204	0.271	0.368	0.329	0.415	0.366	0.467	0.538	0.506	0.588	0.605	0.56
		Hp	0.274	0.364	0.493	0.442	0.556	0.491	0.627	0.721	0.678	0.789	0.812	0.751

			Frame								
			TBM2G-085xx			TBM2G-094xx			TBM2G-115xx		
Parameters	Sym	Units	08	13	25	08	13	26	08	13	26
Continuous Torque at Stall	T_c	Nm	1.21	1.65	2.69	1.58	2.05	3.67	1.9	3.04	6.03
		lb-in	10.7	14.6	23.8	14	18.1	32.5	16.8	26.9	53.4
Rated Speed	N_{rtd}	rpm	8000	5200	2700	8000	5800	2900	5800	4900	3300
Motor Constant	K_m	Nm/ \sqrt{W}	0.203	0.271	0.419	0.263	0.331	0.528	0.31	0.464	0.802
		lb-in/ \sqrt{W}	1.79	2.4	3.7	2.33	2.93	4.67	2.74	4.1	7.09
Rated Power	P_{rtd}	kW	0.741	0.725	0.67	0.86	0.87	0.945	0.711	0.969	1.463
		Hp	0.994	0.972	0.899	1.153	1.167	1.267	0.954	1.3	1.962



TBM2G Nomenclature **TBM2G** - 060 13 A - A N A A - 00

1
2
3
4
5
6
7
8
9

		Available Motor						
Motor Series		TBM2G						
1	Frame	050	060	068	076	085	094	115
2	Size in mm	50	60	60	76	85	94	115
3	Lamination Stack Length							
	08 = 8.2 mm stack	•	•	•	•	•	•	•
	13 = 12.7 mm stack	•	•	•	•	•	•	•
	26 = 26.3 mm stack	•	•	•	•	•	•	•
4	Motor Winding							
	A = Wye Connected	•	•	•	•	•	•	•
	C = Parallel Wye Connected	•	•	•	•	•	•	•
	D = Parallel Delta Connected	•	•	•	•	•	•	•

		Available Options						
Motor Series		TBM2G						
	Frame	050	060	068	076	085	094	115
5	Thermal Device							
	N = None	•	•	•	•	•	•	•
	A = PT1000	•	•	•	•	•	•	•
	B = 3 PTC's	•	•	•	•	•	•	•
6	Sensor Option							
	N = None	•	•	•	•	•	•	•
	H = Hall Sensors	•	•	•	•	•	•	•
	A = Hall Sensors (Alternate Location)	•	•	•	•	•	•	•
7	Lead Options							
	N = None	•	•	•	•	•	•	•
	A = 0.5 m Flying Leads	•	•	•	•	•	•	•
8	Field Options							
	A = Standard	•	•	•	•	•	•	•
9	Custom Options							
	00 = Standard	•	•	•	•	•	•	•

TBM2G Frameless Motors

Dimensional Overview

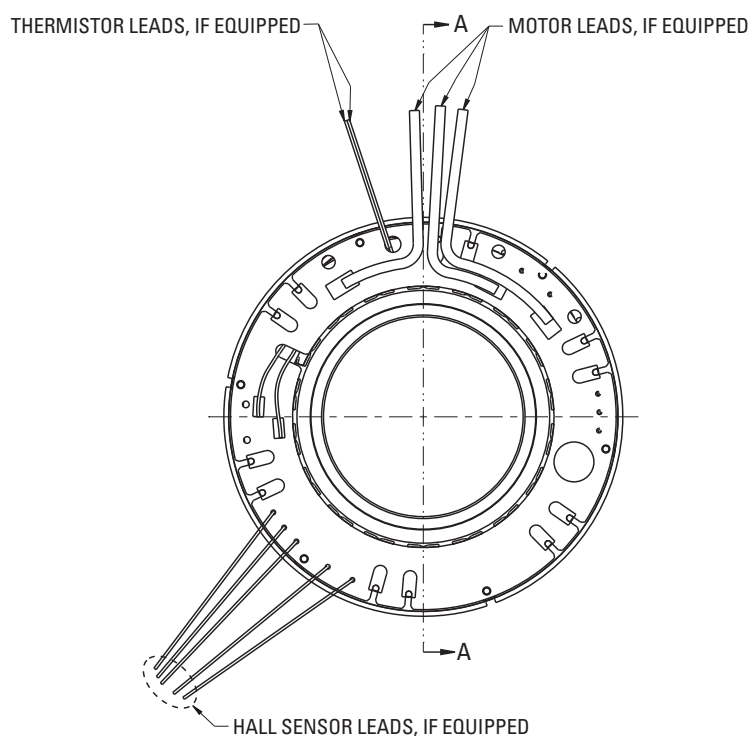
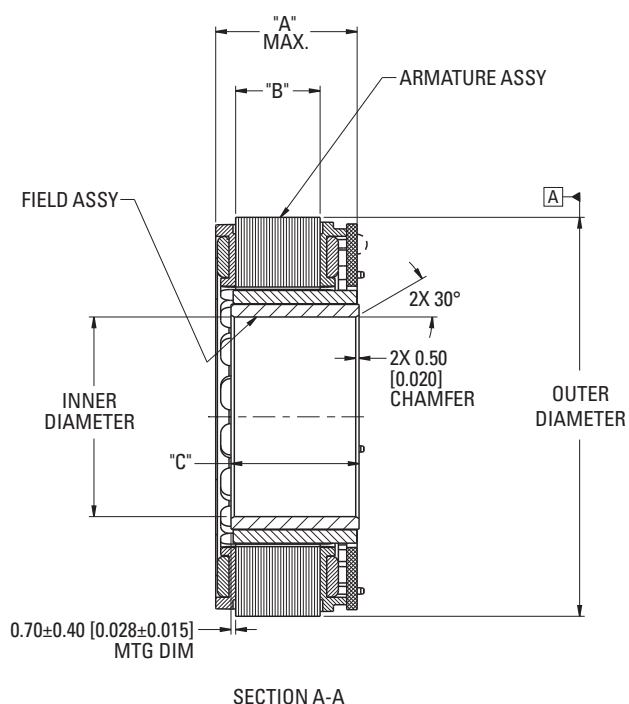

TBM2G Series	Frame	Outer Diameter	Inner Diameter	"A" Max			"B" REF +/- 0.35			"C" +/- 0.075		
				08	13	26	08	013	26	08	13	26
	050	50	24.75	20.64	25.14	38.74	8.2	12.7	26.3	14.76	19.26	32.86
	060	60	30	17.58	22.08	35.68	8.2	12.7	26.3	14.76	19.26	32.86
	068	68	34	18.58	23.08	36.68	8.2	12.7	26.3	14.76	19.26	32.86
	076	76	38	18.51	23.01	36.61	8.2	12.7	26.3	14.76	19.26	32.86
	085	85	42.5	19.58	24.08	37.68	8.2	12.7	26.3	14.76	19.26	32.86
	094	94	47	19.93	24.43	38.03	8.2	12.7	26.3	14.76	19.26	32.86
	115	115	57.5	26.2	30.7	44.3	8.2	12.7	26.3	14.76	19.26	32.86

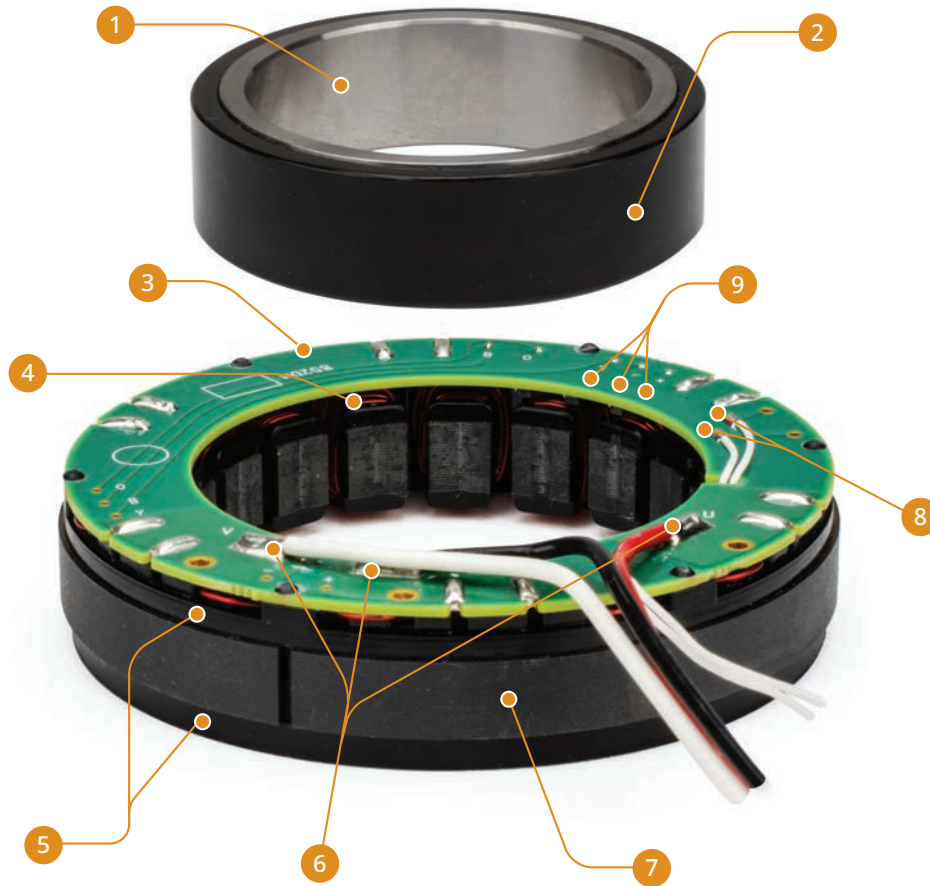

- | | | |
|---|--|---|
| <p>1 Yoke
 • Material: SS400 Series</p> <p>2 Ring Magnet
 • Material: NdFeB (Neodymium)
 • Coating: Epoxy</p> <p>3 Printed Circuit Board (PCB)</p> | <p>4 Coil
 • Material: Copper
 • Coating: Varnish</p> <p>5 End Insulators
 • Material: Polymer Resin</p> <p>6 Power Leads</p> | <p>7 Lamination Stack
 • Material: Electric Steel</p> <p>8 Optional Thermal Devices (mounted underneath PCB)
 • PT1000
 • PTC Avalanche (3 in series)</p> <p>9 Optional Hall Sensors (mounted underneath PCB)
 • Allegro A1260</p> |
|---|--|---|

TBM2G Product Features

- 7 frame sizes with 3 stack lengths each
- Integrated Hall sensor option
- PT1000 and PTC thermal sensor options
- Available with or without flying leads
- Low cogging design
- Optimized for high efficiency across a wide speed range
- Three standard winding options per frame/stack
- Stainless steel yoke rings for corrosion protection

About Kollmorgen

Kollmorgen has more than 100 years of motion experience, proven in the industry's highest-performing, most reliable motors, drives, linear actuators, gearheads, AGV control solutions and automation platforms. We deliver breakthrough solutions that are unmatched in performance, reliability and ease of use, giving machine builders an irrefutable marketplace advantage.

Kollmorgen is a brand of Altra Industrial Motion Corp. (NASDAQ: AIMC), a premier global designer and producer of a wide range of motion control and power transmission solutions. With engineered components and systems that provide the essential control of equipment speed, torque, positioning and other functions, Altra products can be used in nearly any machine, process or application involving motion.

KOLLMORGEN

www.kollmorgen.com

Specifications are subject to change without notice. It is the responsibility of the product user to determine the suitability of this product for a specific application. All trademarks are the property of their respective owners.

© 2022 Kollmorgen Corporation. All rights reserved.