

LA11 absolute magnetic encoder system



LA11 is an absolute magnetic linear encoder system designed for motion control applications as a position and velocity control loop feedback element.

The encoder system is highly reliable due to contactless absolute measuring principle, built-in safety algorithms and high quality materials/components used.

The measuring standard is a magnetic scale which consists of a stainless steel substrate with an elasto-ferrite layer. The elasto-ferrite layer is magnetised with two tracks. The incremental track is magnetised with 2 mm long (alternating south and north) poles and the absolute track is magnetised with a pseudo random binary sequence (PRBS) absolute code with 13 bit length. The elasto-ferrite layer is immune to chemicals commonly found in industry.

The readhead includes Hall sensor arrays for PRBS track reading, an AMR sensor for incremental track reading, interpolation electronics and custom logic circuitry. The data from the Hall arrays and interpolator are processed in the internal MCU using special algorithms to determine the absolute position.

The electronics design provides short response and recovery times.

Diagnostic information is available through a serial communication channel and status LED.

- True absolute system
- Suitable for highly dynamic control loops
- Small footprint
- High accuracy
- Resolutions up to 0.244 μm
- Axis lengths up to 16.3 m
- Speeds up to 7 m/s at 0.977 μm resolution
- Integral status LED
- Synchronous (SSI, SPI, BiSS) communication protocols available
- Parallel incremental output (analogue \sim or digital \square)
- Double shielded, drag-chain compatible cable
- Simple and fast installation
- Robust measuring principle
- Excellent degree of protection to IP68

Storage and handling

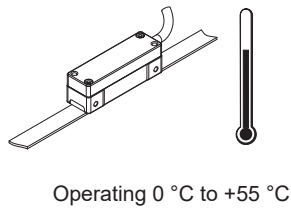
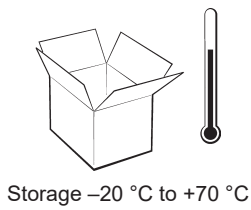
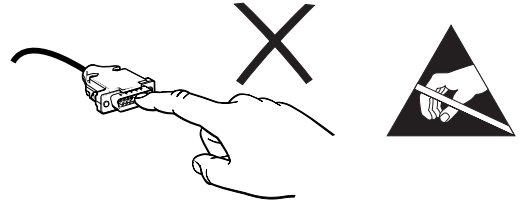
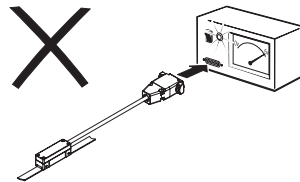
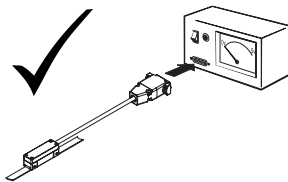
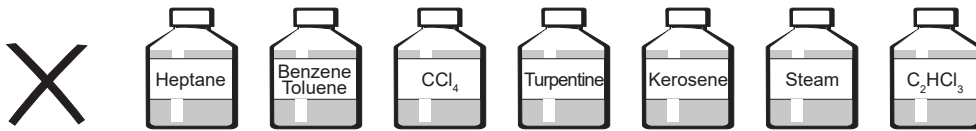
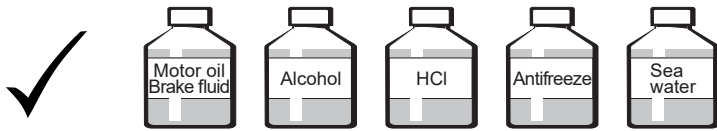
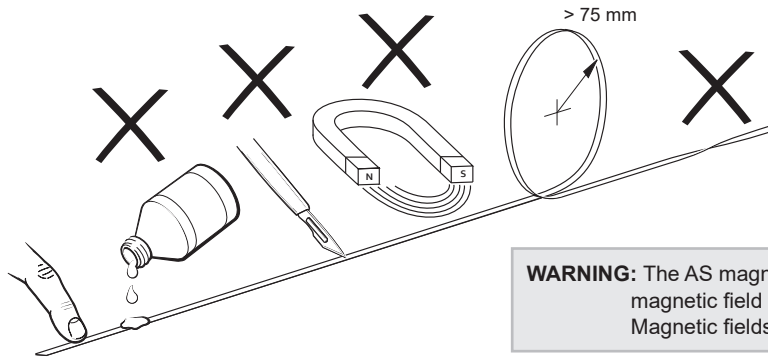

Shield connection

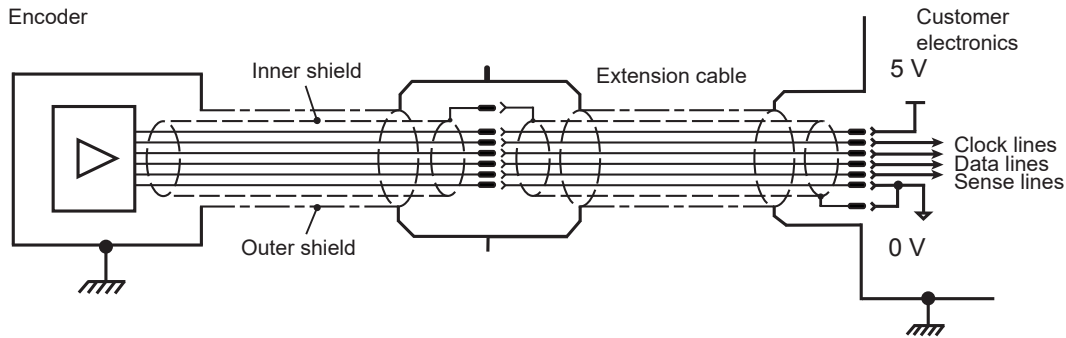

Dimensions

Dimensions and tolerance in mm.

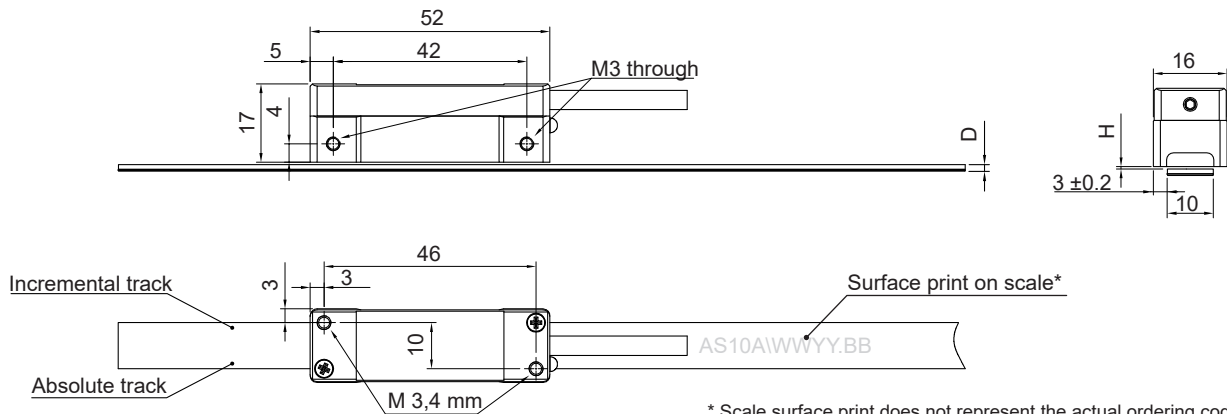

* Scale surface print does not represent the actual ordering code. For orientation purpose only.

	Magnetic scale thickness (D)		Ride height (H)
	Options 00 and 03	Option 01**	
With back-adhesion tape	1.5 ± 0.15	1.7 ± 0.15	0.1 – 0.6
With back-adhesion tape, with cover foil	1.6 ± 0.15	1.8 ± 0.15	0.1 – 0.5
No back-adhesion tape	1.3 ± 0.15	1.5 ± 0.15	0.1 – 0.6
No back-adhesion tape, with cover foil	1.4 ± 0.15	1.6 ± 0.15	0.1 – 0.5
No back-adhesion tape, sides prepared for track system	1.3 ± 0.15	1.5 ± 0.15	0.1 – 0.4
No back-adhesion tape, sides prepared for track system, with cover foil	1.4 ± 0.15	1.6 ± 0.15	0.1 – 0.3

** Check part numbering on page 22 for more information.

Readhead orientation

Orientation of the readhead relative to AS10 magnetic scale should be according to the dimensions drawing on page 3. For reference use the surface print on AS scale or magnet viewer (see right image).

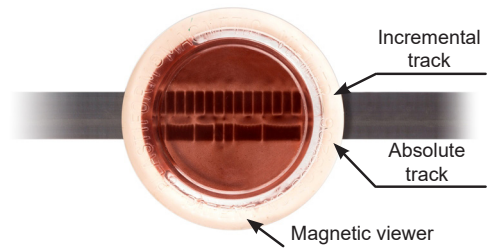

Installation tolerances

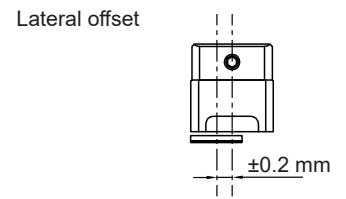
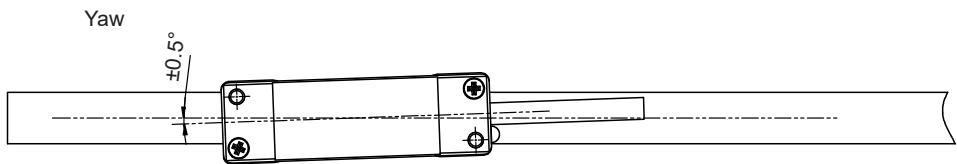
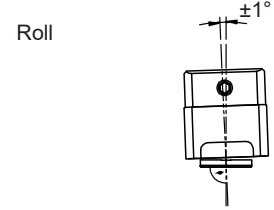
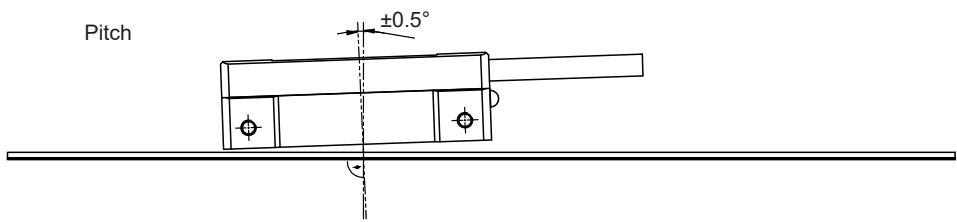

Status LEDs

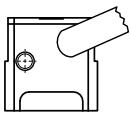

LED	Communication	Status
Green	Yes	Valid position data
Green flashing	No	Valid position data
Orange	Yes	Valid position data, > 80 % of max. temperature
Orange flashing	No	Valid position data, > 80 % of max. temperature
Red	Yes	Invalid position data
Red flashing	No	Invalid position data

By special request the status LEDs can be turned off. Please contact sales@rls.si.

For readheads with BiSS communication interface:

When there is no communication between controller and encoder the alarm status on LED is not updated, with the exception of temperature alarm. LED shows the alarm status of the last communication request.

Technical specifications

System data											
Maximum length for AS scale		16.3 m									
Incremental pole length		2 mm									
Maximum speed for parallel incremental signals 											
Ordering code	Resolution (µm)	Interpolation factor	Maximum speed (m/s)								
13B	~0.244	8,192	1.82	0.91	0.23	0.11	0.06	0.03	0.02	0.01	0.01
12B	~0.488	4,096	3.65	1.82	0.46	0.23	0.12	0.06	0.05	0.02	0.01
11B	~0.976	2,048	7	3.65	0.91	0.46	0.24	0.12	0.10	0.05	0.02
2D0	1	2,000	7	3.73	0.93	0.47	0.24	0.12	0.10	0.05	0.02
10B	~1.953	1,024	7	7	1.82	0.91	0.48	0.24	0.19	0.10	0.05
09B	~3.906	512	7	7	3.65	1.82	0.95	0.49	0.38	0.19	0.10
08B	~7.812	256	7	7	7	3.65	1.90	0.97	0.77	0.39	0.19
07B	15.625	128	7	7	7	7	3.81	1.94	1.53	0.77	0.39
06B	31.25	64	7	7	7	7	7	3.89	3.07	1.55	0.78
05B	62.5	32	7	7	7	7	7	7	6.14	3.10	1.56
04B	125	16	7	7	7	7	7	7	7	6.19	3.11
Edge separation (µs)			0.07	0.12	0.50	1	2	4	5	10	20
Maximum count frequency (MHz)			15	8	2	1	0.50	0.25	0.20	0.10	0.05
Ordering code			K	A	B	C	D	E	F	G	H
System accuracy		±40 µm/m									
Short range accuracy		< ±10 µm/10 mm (see diagram 9)									
Coefficient of thermal expansion (CTE)		11 ±1 µm/m/K									
Repeatability		Unit of resolution									
Hysteresis		< 2 µm at 0.1 mm ride height (see diagram 1)									
Electrical data											
Power supply		Option A: From 4.75 V to 5.75 V - Voltage on readhead, consider voltage drop over cable (see diagrams 3, 4, 5, 6) Option B: From 8 V to 30 V (see diagram 7)									
Reverse polarity protection		For option A only									
Set-up time after switch-on		< 350 ms									
Power consumption (without load)		Option A: < 150 mA at 5 V power supply Option B: see diagram 7									
Voltage drop over cable		~ 80 mV/m - without load									
Mechanical data											
Mass		Readhead (with 1 m cable, no connector) 41 g, magnetic scale 60 g/m									
Environmental data											
Temperature		Operating 0 °C to +55 °C Storage -20 °C to +70 °C									
Vibrations (55 Hz to 2000 Hz)		300 m/s ² (IEC 60068-2-6)									
Shocks (11 ms)		300 m/s ² (IEC 60068-2-27)									
Humidity		100 % (condensation permitted)									
EMC Immunity		IEC 61000-6-2 (particularly: ESD: IEC 61000-4-2; EM fields: IEC 61000-4-3; Burst: IEC 61000-4-4; Surge: IEC 61000-4-5; Conducted disturbances: IEC 61000-4-6; Power frequency magnetic fields: IEC 61000-4-8; Pulse magnetic fields: IEC 61000-4-9)									
EMC Emission		IEC 61000-6-4 (for industrial, scientific and medical equipment: IEC 55011)									
Environmental sealing		Readhead only: IP68 (according to IEC 60529)									

Diagram 1: Hysteresis vs. ride height

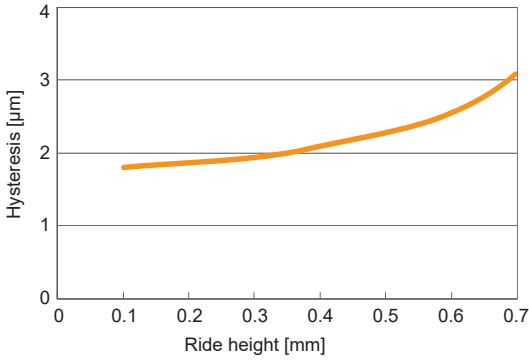
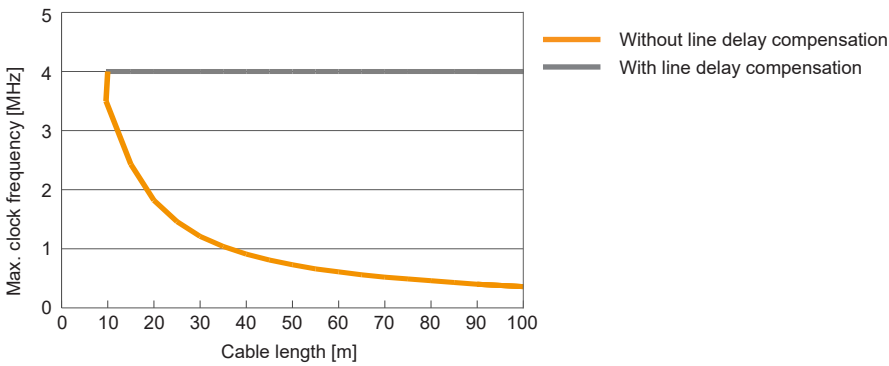

Diagram 2: Maximum clock frequency vs. cable length



Required power supply voltage on cable end vs. overall cable length

Diagram 3: for DC, SC, SP (with 150 Ω termination)

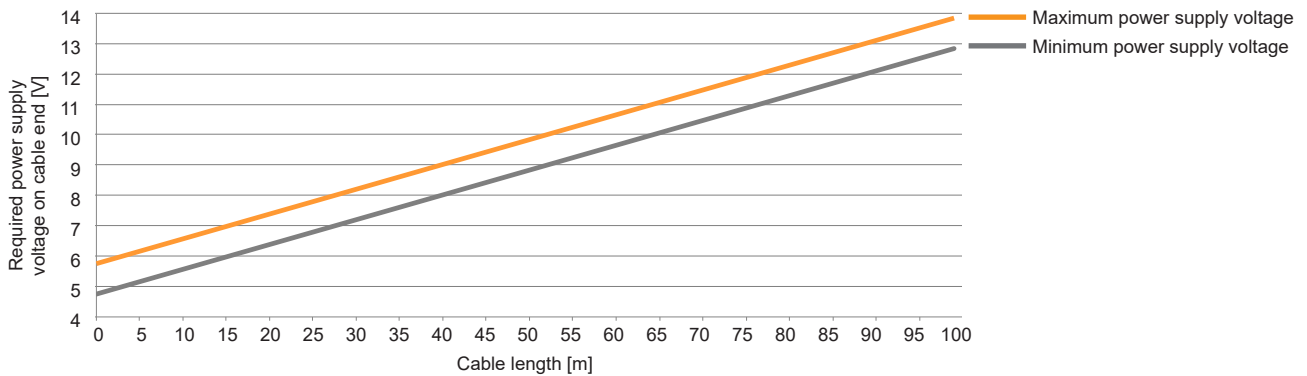

Diagram 4: for DC, SC, SP (with 150 Ω termination) with sense lines connected parallel to power supply lines

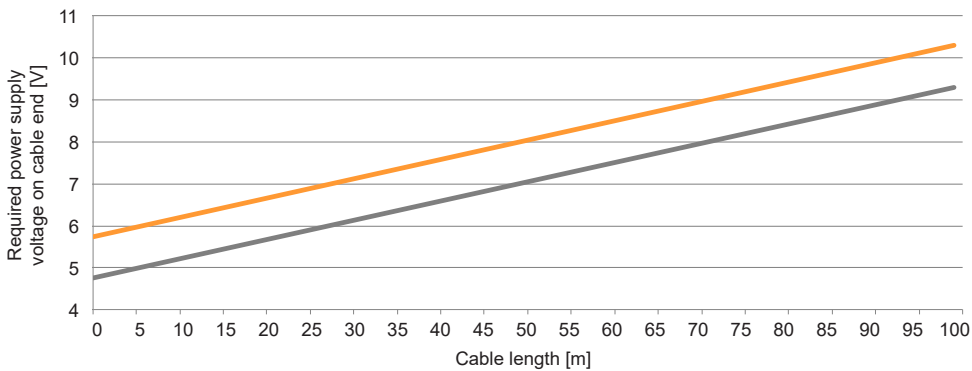

Diagram 5: for DA, DI, SB, SI, SQ, SR (with 150 Ω termination)

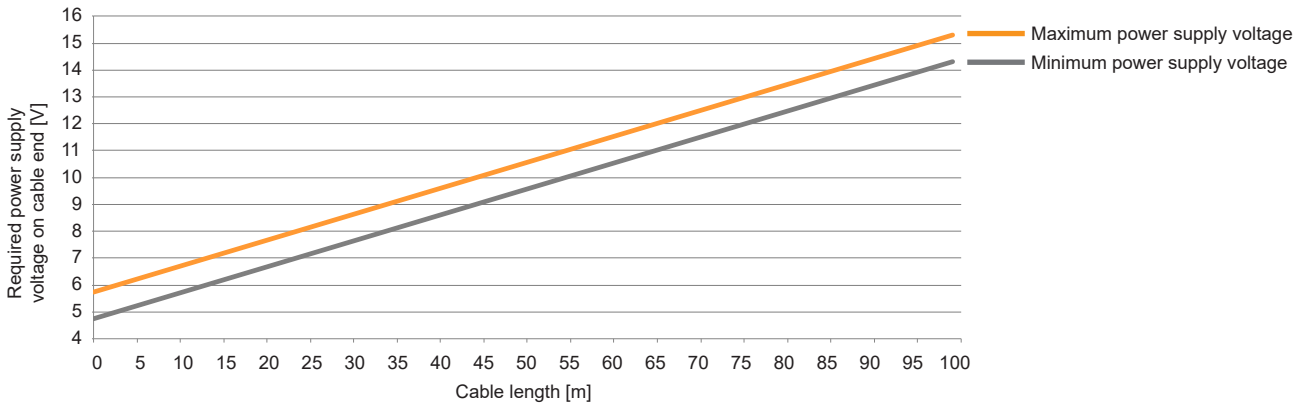
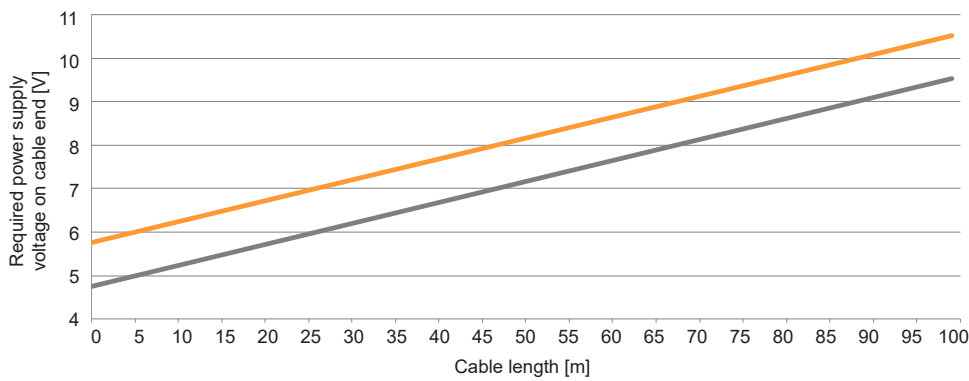

Diagram 6: for DA, DI, SB, SI, SQ, SR (with 150 Ω termination) with sense lines connected parallel to power supply lines



Current consumption vs. voltage on cable end

Diagram 7: Current consumption vs. voltage on cable end (power supply 8 V to 30 V, option B)

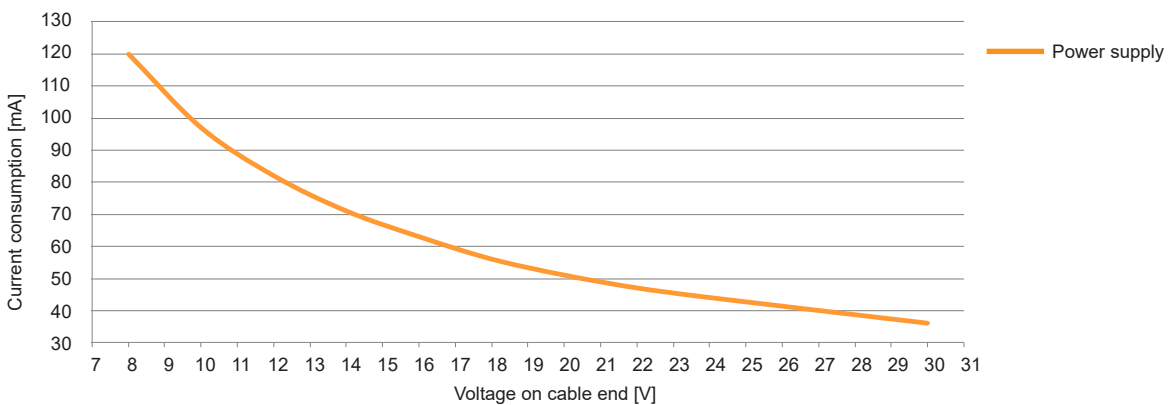

Diagram 8: Short range accuracy vs. ride height-lateral offset (LO) as a parameter - typical

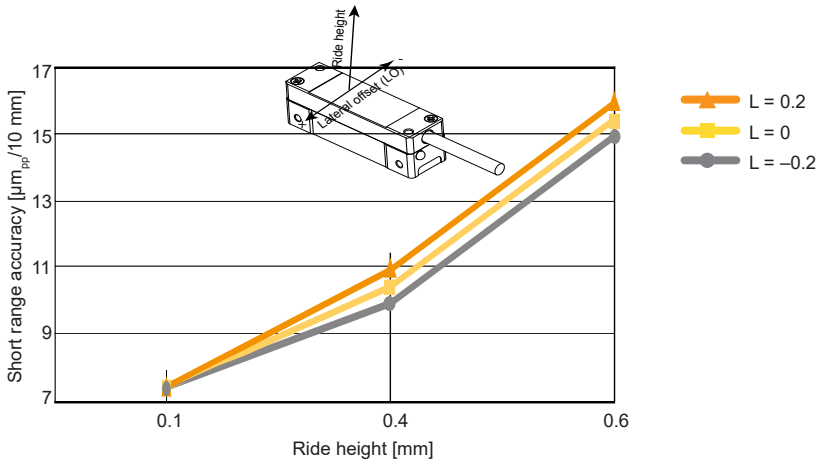
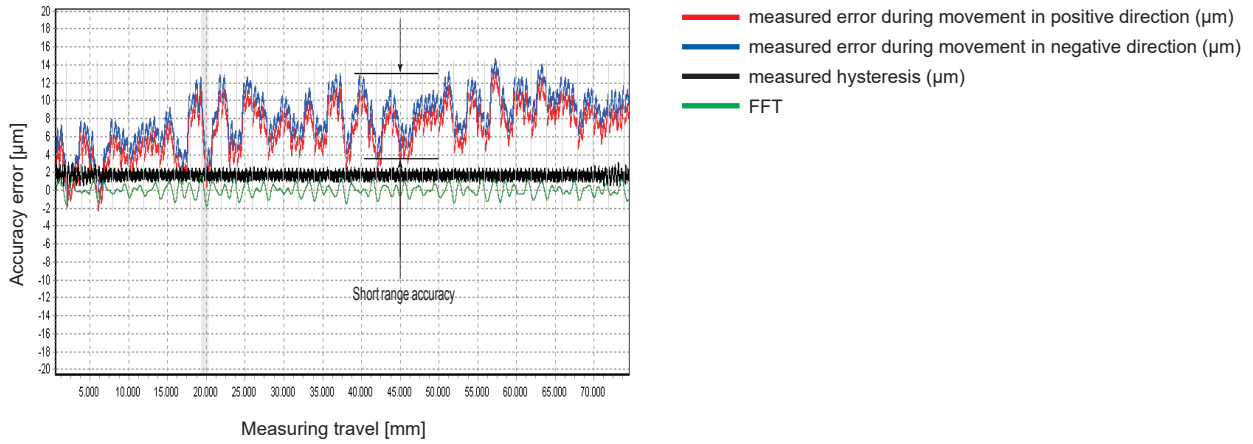

Diagram 9: Definition of short range accuracy



Electrical connections

Cable specifications

Cable type	PUR high flexible cable, drag-chain compatible, double-shielded	
Number of wires	8	12
Communication interface	DC, SC, SP	DA, DI, SB, SI, SQ, SR
Outer diameter	4.2 mm ±0.2 mm	4.5 mm ±0.2 mm
Jacket material	Extruded polyurethane (PUR)	
White wire	0.14 mm ² , 26 AWG, 0.13 Ω/m	0.08 mm ² , 28 AWG, 0.23 Ω/m
Other wires	0.05 mm ² , 30 AWG, 0.35 Ω/m	
Durability	20 million cycles at 25 mm bend radius	20 million cycles at 50 mm bend radius
Weight	34 g/m nominal	38 g/m nominal
Bend (internal) radius	Dynamic 25 mm, static 10 mm	Dynamic 50 mm, static 10 mm

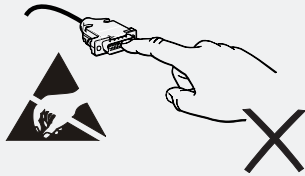

WARNING!

ESD protection

Readhead is ESD sensitive - handle with care. Do not touch wires or connector pins without proper ESD protection or outside of ESD controlled environment.

15 pin D type plug

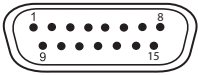

Pin	Wire colour (for SC, DC, SP)	Wire colour	BiSS	SSI	SPI
Case	Outer shield	Outer shield	Encoder/machine case (Earth connection)	Encoder/machine case (Earth connection)	Encoder/machine case (Earth connection)
1	Inner shield				
2	White	White	0 V (GND) supply		
3	Green	Green	MA+	Clock+	Clock
4	Yellow	Yellow	MA-	Clock-	CS (chip select)
5	-	Purple	Sin+ / A+		
6	-	Grey	Cos+ / B+		
7	Brown	Brown	+Vin supply		
8	Grey	Orange	+Vin sense		
9	-	-	-	-	-
10	-	Black	Sin- / A-		
11	-	Pink	Cos- / B-		
12	-	-	-	-	-
13	Blue	Blue	SLO+	Data+	MISO (data)
14	Red	Red	SLO-	Data-	-
15	Pink	Transparent	0 V (GND) sense		

Data sheet
LA11D01_07

9 pin D type plug

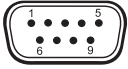

Pin	Wire colour	BiSS	SSI	SPI
Case	Outer shield	Encoder/machine case (Earth connection)	Encoder/machine case (Earth connection)	Encoder/machine case (Earth connection)
1	Inner shield			
2	Green	MA+	Clock+	Clock
3	Yellow	MA-	Clock-	CS (chip select)
4	Grey	+Vin sense		
5	Brown	+Vin supply		
6	Blue	SLO+	DATA +	MISO
7	Red	SLO-	DATA -	-
8	Pink	0 V (GND) sense		
9	White	0 V (GND) supply		

Siemens 6FX2003-0SA17

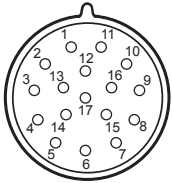

Pin	Wire colour	SSI + analogue sinusoidal
1	Brown	+Vin supply
2	-	-
3	-	-
4	White	0 V (GND) supply
5	-	-
6	-	-
7	-	-
8	Green	Clock+
9	Yellow	Clock-
10	-	-
11	Outer shield	Encoder/machine case (Earth connection)
12	Grey	B (Cos+)
13	Pink	B* (Cos-)
14	Blue	Data+
15	Purple	A (Sin+)
16	Black	A* (Sin-)
17	Red	Data-

Phoenix contact M12 8 pole

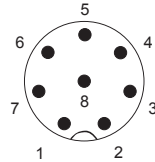

Pin	Wire colour	BiSS	SSI
Case	Outer shield	Encoder/machine case (Earth connection)	Encoder/machine case (Earth connection)
1	White	0 V (GND) supply	0 V (GND) supply
2	Brown	+Vin supply	+Vin supply
3	Blue	SLO+	Data+
4	Red	SLO-	Data -
5	-	-	-
6	Yellow	MA-	Clock -
7	Green	MA+	Clock+
8	-	-	-

NOTE: If controller does not support voltage sense functionality, we recommend connecting sense lines parallel to power supply lines in order to decrease voltage drop over cable. If sense lines are not used and/or connected, they should be isolated in order to prevent possible shorts between power supply lines.

Siemens SMC20

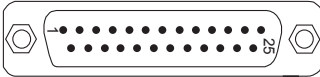

Pin	Wire colour	SSI +
Case	Outer shield	Outer shield
1	Brown	P encoder
2	White	M encoder
3	Purple	A (Sin+)
4	Black	A- (Sin-)
5	Inner shield	Ground
6	Grey	B (Cos+)
7	Pink	B- (Cos-)
8	-	-
9	-	-
10	Green	Clock
11	-	-
12	Yellow	Clock-
13	-	-
14	Orange	P Sense
15	Blue	Data
16	Transparent	M sense
17	-	-
18	-	-
19	-	-
20	-	-
21	-	-
22	-	-
23	Red	Data-
23	-	-
25	-	-

Siemens SMC30

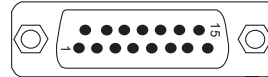

Pin	Wire colour	SSI + analogue sinusoidal
Case	Outer shield	Outer shield
1	-	-
2	Green	Clock
3	Yellow	Clock-
4	Brown	P encoder 5 V / 24 V
5	-	-
6	Grey	P sense
7	White	M encoder
8	-	-
9	Pink	M sense
10	-	-
11	-	-
12	-	-
13	-	-
14	Red	Data-
15	Blue	Data

Communication interfaces

SSI	
Maximum clock frequency	0.8 MHz standard 2.5 MHz with Delay First Clock option on the controller
Read repetition rate	15 kHz 30 kHz with Delay First Clock option on the controller
Resolution	See table below
Refresh rate*	100 kHz
Timeout (monoflop time)	10 µs
BiSS	
Maximum clock frequency	3.5 MHz or 5 MHz
Read repetition rate	30 kHz
Resolution	See table below
Latency	5 µs
Timeout (monoflop time)	20 µs
SPI slave	
Maximum clock frequency	4 MHz
Read repetition rate	90 kHz
Resolution	See table below
Refresh rate*	100 kHz
Timeout (monoflop time)	10 µs

* The position is captured internally every 10 µs (for SSI and SPI only).

Available resolutions

Resolution
13B - $2/2^{13}$ mm (0.244140625 µm)
12B - $2/2^{12}$ mm (0.48828125 µm)
11B - $2/2^{11}$ mm (0.9765625 µm)
2D0 - $2/2000$ mm (1 µm)
10B - $2/2^{10}$ mm (1.953125 µm)
09B - $2/2^9$ mm (3.90625 µm)
08B - $2/2^8$ mm (7.812 µm)
07B - $2/2^7$ mm (15.625 µm)
06B - $2/2^6$ mm (31.25 µm)
05B - $2/2^5$ mm (62.5 µm)
04B - $2/2^4$ mm (125 µm)

LA11 always reports the position data in 26 bit binary format. Table below shows the bit values in position data for different resolutions:

Resolution	Bits reported position in LA11 output message																									Weight of LSB (µm)	Weight of "last active" bit (µm)	
	25	24	23	22	21	20	19	18	17	16	15	14	13	12	11	10	9	8	7	6	5	4	3	2	1			0
13B	0/1	0/1	0/1	0/1	0/1	0/1	0/1	0/1	0/1	0/1	0/1	0/1	0/1	0/1	0/1	0/1	0/1	0/1	0/1	0/1	0/1	0/1	0/1	0/1	0/1	0/1	0.244140625	0.244140625
12B	0/1	0/1	0/1	0/1	0/1	0/1	0/1	0/1	0/1	0/1	0/1	0/1	0/1	0/1	0/1	0/1	0/1	0/1	0/1	0/1	0/1	0/1	0/1	0/1	0/1	0	0.244140625	0.48828125
11B	0/1	0/1	0/1	0/1	0/1	0/1	0/1	0/1	0/1	0/1	0/1	0/1	0/1	0/1	0/1	0/1	0/1	0/1	0/1	0/1	0/1	0/1	0/1	0/1	0	0	0.244140625	0.9765625
2D0	0/1	0/1	0/1	0/1	0/1	0/1	0/1	0/1	0/1	0/1	0/1	0/1	0/1	0/1	0/1	0/1	0/1	0/1	0/1	0/1	0/1	0/1	0/1	0/1	0	0	0.250	1
10B	0/1	0/1	0/1	0/1	0/1	0/1	0/1	0/1	0/1	0/1	0/1	0/1	0/1	0/1	0/1	0/1	0/1	0/1	0/1	0/1	0/1	0/1	0/1	0/1	0	0	0.244140625	1.953125
09B	0/1	0/1	0/1	0/1	0/1	0/1	0/1	0/1	0/1	0/1	0/1	0/1	0/1	0/1	0/1	0/1	0/1	0/1	0/1	0/1	0/1	0/1	0/1	0/1	0	0	0.244140625	3.90625
08B	0/1	0/1	0/1	0/1	0/1	0/1	0/1	0/1	0/1	0/1	0/1	0/1	0/1	0/1	0/1	0/1	0/1	0/1	0/1	0/1	0/1	0/1	0/1	0/1	0	0	0.244140625	7.8125
07B	0/1	0/1	0/1	0/1	0/1	0/1	0/1	0/1	0/1	0/1	0/1	0/1	0/1	0/1	0/1	0/1	0/1	0/1	0/1	0/1	0/1	0/1	0/1	0/1	0	0	0.244140625	15.625
06B	0/1	0/1	0/1	0/1	0/1	0/1	0/1	0/1	0/1	0/1	0/1	0/1	0/1	0/1	0/1	0/1	0/1	0/1	0/1	0/1	0/1	0/1	0/1	0/1	0	0	0.244140625	31.25
05B	0/1	0/1	0/1	0/1	0/1	0/1	0/1	0/1	0/1	0/1	0/1	0/1	0/1	0/1	0/1	0/1	0/1	0/1	0/1	0/1	0/1	0/1	0/1	0/1	0	0	0.244140625	62.5
04B	0/1	0/1	0/1	0/1	0/1	0/1	0/1	0/1	0/1	0/1	0/1	0/1	0/1	0/1	0/1	0/1	0/1	0/1	0/1	0/1	0/1	0/1	0/1	0/1	0	0	0.244140625	125

Position data on serial interfaces has fixed length of 26 bits. If selected resolution is less than 13 bits, then unused lower bits are set to 0.

SSI - Synchronous serial interface

The encoder position, in up to 26 bit natural binary code, and the encoder status are available through the SSI protocol. The position is captured internally every 10 μs (refresh rate 100 kHz). Output position data is the last captured data before position request trigger. Request trigger is a falling edge of clock signal. The position data is left aligned, MSB first. After the position data there are two general status bits (active status low) followed by the detailed status information.

Electrical connection

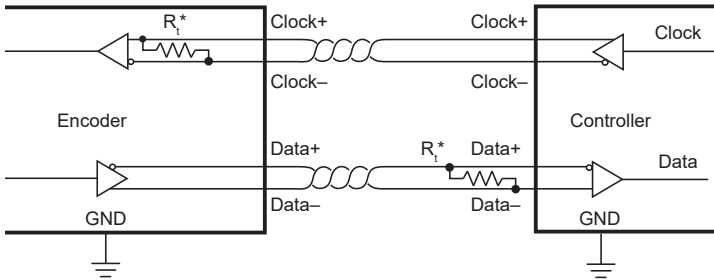

Line signals	
Clock+	Receiver, + input
Clock-	Receiver, - input
Data+	Transmitter, + output
Data-	Transmitter, - output

* The Clock and Data lines are 5 V RS422 compatible differential pairs. The termination resistor on the Clock line is integrated inside the encoder. If the total cable length is longer than 5 m, termination on the end of the Data line at the controller end is required. The nominal impedance of cable is 120 Ω .

SSI timing diagram

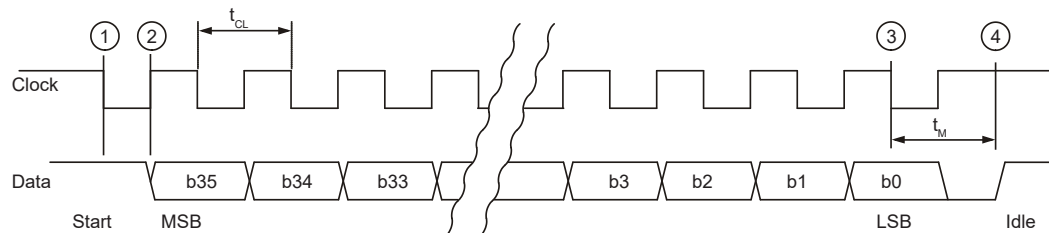

The controller interrogates the readhead for its position and status data by sending a pulse train to the Clock input. The Clock signal always starts from high. The first falling edge ① latches the last position data available and on the first rising edge ② the most significant bit (MSB) of the position is transmitted to the Data output. The Data output should then be latched on the following falling edge. On subsequent rising edges of the Clock signal the next bits are transmitted. If time between ① and ② is extended for additional 1 μs then maximum clock frequency limit is 2.5 MHz instead of 0.8 MHz. This function is called "Delay First Clock" and must be supported by the controller the encoder is connected to.

After the transmission of the last bit ③ the Data output goes to low. When the t_M time expires, the Data output is logical "H" ④. The Clock signal must remain high for at least t_M before the next reading can take place.

While reading the data, the period t_{CL} must always be less than t_M . However, reading the encoder position can be terminated at any time by setting the Clock signal to high for the duration of t_M .

Maximum reading rate is defined by time t_b . If the reading request arrives earlier than t_b , the encoder position will not be updated.

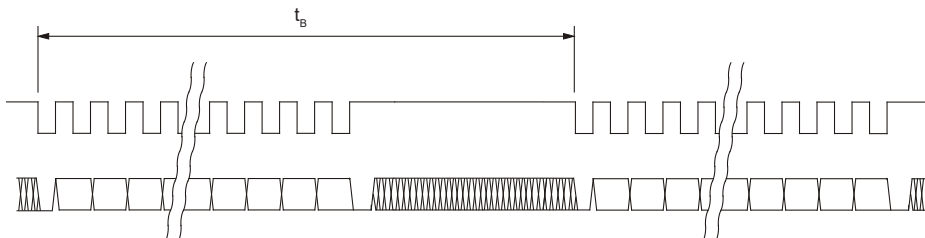

Communication parameters

Parameter	Symbol	Min	Typ	Max
Clock period	t_{CL}	1.25 μ s (400 ns*)		10 μ s
Clock frequency	f_{CL}	100 kHz		0.8 MHz (2.5 MHz*)
Monoflop time	t_M	10 μ s		
Update time	t_B	65 μ s (34.4 μ s*)		

* With Delay First Clock function on the controller.

Type	Value 0	Value 1	Possible reason for failure
Error	Position data is invalid.	OK	Error bit is active low. If low, the position is not valid. Possible reasons: - The readhead is out of alignment with the magnetic scale. - The magnetic scale is demagnetised. - Incorrect orientation of readhead and magnetic scale. - Distance between the readhead and the magnetic scale is too large. - Speed of movement too high.
Warning	Position data is valid.	OK	Warning bit is active low. If low, the encoder operation is close to its limits (> 80% of maximum temperature). The position is still valid.

SSI - position with two general and detailed status bits

Structure of data packet

Bit	b35 : b10	b9 : b8	b7 : b0
Data length	26 bits	2 bits	8 bits
Meaning	Encoder position	General status	Detailed status

Encoder position	
b35 : b10	Encoder position, left aligned, MSB first. Unused lower bits are set to 0. LSB bit = 2000 μ m / 2 ¹³
General status	
b9	Error. If bit is "L", position is not valid.
b8	Warning. If bit is "L", encoder is near operational limits. Position is valid.
Error and Warning bits can be set at the same time; in this case Error bit has priority. The color of the LED on the readhead housing indicates the value of the General status bits: Red = Error, Orange = Warning, Green = Normal operation. Red or Orange or Green indicator flashing = no communication running between controller and encoder. No light = no power supply or general failure. The warning or error status is more closely defined by the Detailed status bits.	
Detailed status	
b7	Not used - always 0.
b6	Error - The distance between the readhead and the magnetic scale is too large.
b5	Error - Signal lost. The readhead is out of alignment with the magnetic scale or the magnetic scale is demagnetised. Incorrect orientation of readhead and magnetic scale.
b4	Warning - Temperature. The readhead temperature is close to operational limits [> 80% of maximum temperature].
b3	Not used - always 0.
b2	Not used - always 0.
b1	Not used - always 0.
b0	Error - Frequency. Speed of movement too high.

SSI - position with two general status bits

Data packet is 28 bits long, MSB first, left aligned. It provides position and two general error warning status bits. All resolutions are available.

Structure of data packet

Bit	b27 : b2	b1 : b0
Data length	26 bits	2 bits
Meaning	Encoder position	General status

Encoder position	
b27 : b2	Encoder position, left aligned, MSB first. Unused lower bits are set to 0. LSB bit = $2000 \mu\text{m} / 2^{13}$
General status	
b1	Error. If bit is "L", position is not valid.
b0	Warning. If bit is "L", encoder is near operational limits. Position is valid.
Error and Warning bits can be set at the same time; in this case Error bit has priority. The color of the LED on the readhead housing indicates the value of the General status bits: Red = Error, Orange = Warning, Green = Normal operation. Red or Orange or Green indicator flashing = no communication running between controller and encoder. No light = no power supply or general failure.	

SSI - position only mode

Data packet is 26 bits long, MSB first, left aligned. It provides position only without status bits. All resolutions are available.

Structure of data packet

Bit	b25 : b0
Data length	26 bits
Meaning	Encoder position

Encoder position	
b25 : b0	Encoder position, left aligned, MSB first. Unused lower bits are set to 0. LSB bit = $2000 \mu\text{m} / 2^{13}$

SSI output »position only« with $1 \mu\text{m}$ resolution has 24 bit long position data word.

SSI - position only in Gray code

This mode provides position only in the reflected binary code, also known as Gray code.

BiSS-C interface

The encoder position, in up to 26 bit natural binary code, and the encoder status are available through the BiSS-C protocol. The position data is left aligned, MSB first. After the position data there are two status bits (active low) followed by CRC (inverted).

BiSS is implemented for point-to-point operation; multiple slaves are not supported. Repetition of reading is maximum 30,000 times per second. If higher, the same position data will be reported. Note that 30 kHz is not achievable for all MA clock frequencies (because data transmission takes too long).

Electrical connection

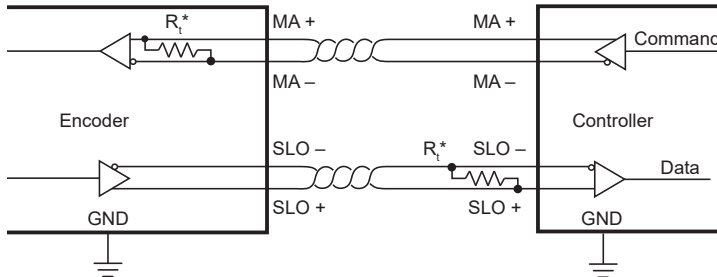

Signals	
MA	Master clock.
SLO	Slave out. Data is output on rising edge on SCK. Data is valid on the falling edge of SCK signal.

*The MA and SLO lines are 5 V RS422 compatible differential pairs. The termination resistor on the MA line is integrated inside the readhead. If the total cable length is longer than 5 m, termination on the end of the SLO line at the controller side is recommended and is required. The nominal impedance of the cable is 120 Ω.

BiSS-C timing diagram

Encoder latches position value 500 ns after first falling edge

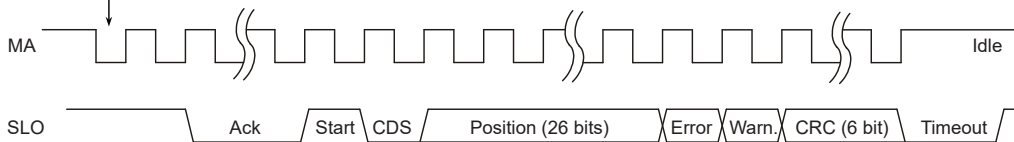

Encoder responds to the controller commands by saving the position value 500 ns after the falling edge of the MA signal. MA is idle high. Communication is initiated with first falling edge.

The encoder responds by setting SLO low on the second rising edge on MA.

Ack is the period during which the readhead calculates the absolute position and it is described in ordering code on page 19.

When the encoder is ready for the next request cycle it indicates this to the master by setting SLO high.

The CRC is in binary format and sent MSB first. The absolute position is in binary format and sent MSB first, left aligned, unused lower bits are set to zero. CDS bit is always zero.

Communication parameters

Parameter	Min	Typ	Max	Description
Clock frequency	50 kHz	-	A / B *	Master clock frequency
Timeout	-	-	20 μs	Communication timeout

*Please see ordering code on page 19.

Status bits

Type	Value 0	Value 1	Possible reason for failure
Error	Position data is invalid.	OK	Error bit is active low. If low, the position is not valid. Possible reasons: - The readhead is out of alignment with the magnetic scale. - The magnetic scale is demagnetised. - Incorrect orientation of readhead and magnetic scale. - Distance between the readhead and the magnetic scale is too large. - Speed of movement too high.
Warning	Position data is valid.	OK	Warning bit is active low. If low, the encoder operation is close to its limits (> 80% of maximum temperature). The position is still valid.

Data packet description

Position data on serial interfaces has fixed length of 26 bits. If selected resolution is less than 13 bits, then unused lower bits are set to 0. See chapter "Available resolutions" on page 9.

Polynomial for CRC calculation of position, error and warning data is: $x^6 + x^1 + 1$. Represented also as 0x43. The start bit and CDS bit are omitted from the CRC calculation. It is inverted and transmitted MSB first.

Example of calculation routine for 6-bit CRC can be found in [application note CRCD01](#).

For more information regarding BiSS protocol see www.biss-interface.com.

SPI - Serial peripheral interface (slave mode)

The SPI interface is designed for communication with nearby devices. The position is internally captured every 10 μs (refresh rate 100 kHz). Output position data is the last valid captured data before position request trigger. Request trigger is a high to low transition of the CS signal.

Electrical connection

Possible data signals are 3.3 V LVTTTL or 5 V TTL (see part numbering).

Signal	Description
$\overline{\text{CS}}$	Active low. $\overline{\text{CS}}$ line is used for synchronisation between master and slave devices. During communication it must be held low. Idle is high. Rising edge on $\overline{\text{CS}}$ signal resets the SPI interface.
SCK	Clocks out the data on rising edge. Max frequency 4 MHz.
MISO	Data is output on rising edge on SCK after $\overline{\text{CS}}$ low. Data is valid on the falling edge of SCK signal. During $\overline{\text{CS}}=1$ MISO line is in high-Z mode.

Communication parameters

Parameter	Symbol	Min	Typ	Max	Note
Clock frequency	f_{CLK}	1 Hz		4 MHz	
Time after $\overline{\text{CS}}$ low to first CLK rising edge	t_{S}	1 μs			
Time after last CLK falling edge to $\overline{\text{CS}}$ high	t_{H}	1 μs			
$\overline{\text{CS}}$ high time	t_{R}	1 μs			Time to complete SPI reset
Read repetition rate*	Simple mode	f_{REP}		90 kHz	
	Advance mode			60 kHz	

*Note that maximum read repetition rate is not achievable for all clock frequencies (because data transmission takes too long).

Communication interface variant in the part numbering defines the SPI interface type and all dependent parameters.

Communication interface variant (part numbering)	Description	Parameter	Value
SP (variant A)	SPI slave - simple mode	Resolution	Selectable (see part numbering)
		Status	All status bits are available through the SPI
		Data length	28 bit data packet - position, status
SP (variant B)	SPI slave - advanced mode	Resolution	Selectable (see part numbering)
		Status	All status bits are available through the SPI
		Data length	44 bit data packet - position, status, detailed status, CRC

Status bits:

Type	Value 0	Value 1	Possible reason for failure
Error	Position data is invalid.	OK	Error bit is active low. If low, the position is not valid. Possible reasons: - The readhead is out of alignment with the magnetic scale. - The magnetic scale is demagnetised. - Incorrect orientation of readhead and magnetic scale. - Distance between the readhead and the magnetic scale is too large. - Speed of movement too high.
Warning	Position data is valid.	OK	Warning bit is active low. If low, the encoder operation is close to its limits (> 80% of maximum temperature). The position is still valid.

SPI slave - simple mode (variant A)

Structure of data packet

Position is 26 bits long - MSB first, left aligned. After the position data there are two general status bits (active "L"). Repetition of reading is maximum 90,000 times per second.

Bit	b27 : b2	b1 : b0
Data length	26 bits	2 bits
Meaning	Encoder position	General status

Encoder position

b27 : b2 Encoder position, left aligned, MSB first. Unused lower bits are set to 0.
LSB bit = $2000 \mu\text{m} / 2^{13}$

General status

b1 Error. If bit is "L", position is not valid.

b0 Warning. If bit is "L", encoder is near operational limits. Position is valid.

Error and Warning bits can be set at the same time; in this case Error bit has priority.

The color of the LED on the readhead housing indicates the value of the General status bits:

Red = Error, Orange = Warning, Green = Normal operation. Red or Orange or Green indicator flashing = no communication running between controller and encoder. No light = no power supply or general failure.

SPI slave timing diagram (variant A)

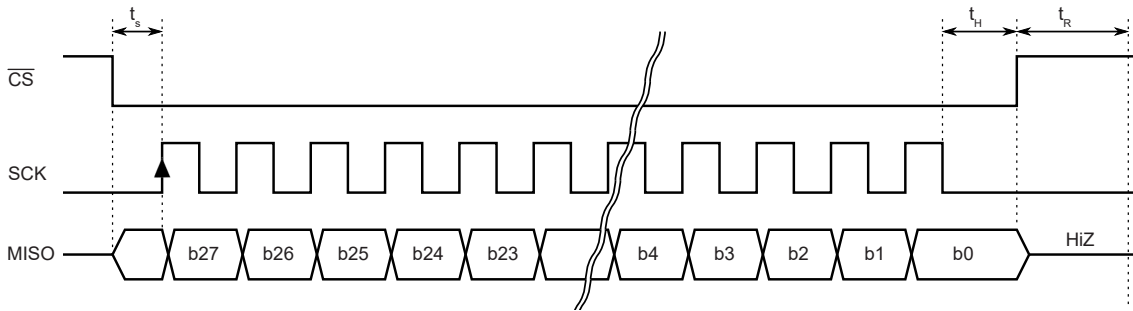

SPI slave - advanced mode (variant B)

Structure of data packet

Data packet is 44 bits long. In every particular word (position, CRC) MSB is first. Repetition of reading is maximum 60,000 times per second. Note that 60 kHz is not achievable for all clock frequencies (because data transmission takes too long).

Bit	b43 : b18	b17 : b16	b15 : b8	b7 : b0
Data length	26 bits	2 bits	8 bits	8 bits
Meaning	Encoder position	General status	Detailed status	CRC

Encoder position	
b43 : b18	Encoder position, left aligned, MSB first. Unused lower bits are set to 0. LSB bit = $2000 \mu\text{m} / 2^{13}$
General status	
b17	Error. If bit is "L", position is not valid.
b16	Warning. If bit is "L", encoder is near operational limits. Position is valid.
Error and Warning bits can be set at the same time; in this case Error bit has priority. The color of the LED on the readhead housing indicates the value of the General status bits: Red = Error, Orange = Warning, Green = Normal operation. Red or Orange or Green indicator flashing = no communication running between controller and encoder. The warning or error status is more closely defined by the Detailed status bits.	
Detailed status	
b15	Not used.
b14	Error - The distance between the readhead and the magnetic scale is too large.
b13	Error - Signal lost. The readhead is out of alignment with the magnetic scale or the magnetic scale is demagnetised. Incorrect orientation of readhead and magnetic scale.
b12	Warning - Temperature. The readhead temperature is close to operational limits (>80 % of maximum temperature).
b11	Not used - always 0.
b10	Not used - always 0.
b9	Not used - always 0.
b8	Error - Frequency. Speed of movement too high.
CRC	
b7 : b0	CRC check with polynomial 0x97

SPI slave timing diagram (variant B)

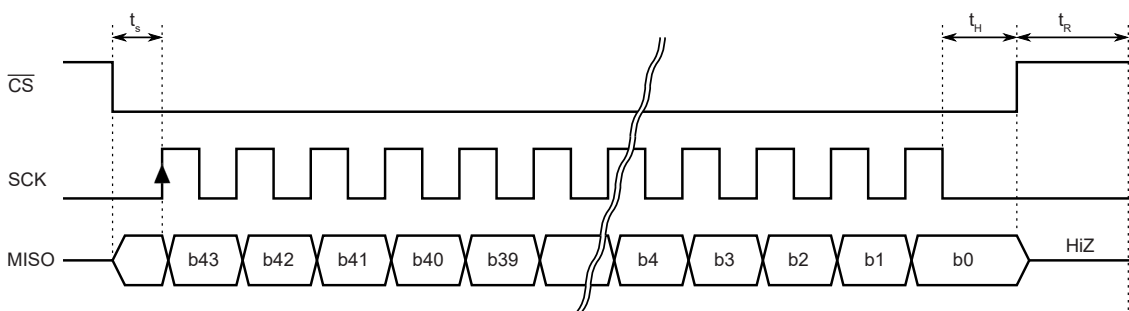

Incremental output signals, RS422

Square wave differential line driver to EIA RS422

Output signals	2 square-wave signals A, B and their inverted signals A-, B-
Signal level	Differential line driver to EIA standard RS422: $U_H \geq 2 \text{ V}$ at $-I_H = 50 \text{ mA}$ $U_L \leq 0.5 \text{ V}$ at $I_L = 50 \text{ mA}$
Permissible load	$Z_0 \geq 100 \ \Omega$ between associated outputs $I_L \leq 50 \text{ mA}$ max. load per output Capacitive load $\leq 1000 \text{ pF}$ Outputs are protected against short circuit to 0 V and to +5 V

Timing diagram

Complementary signals not shown

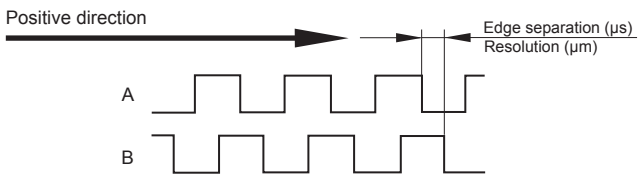

Recommended signal termination

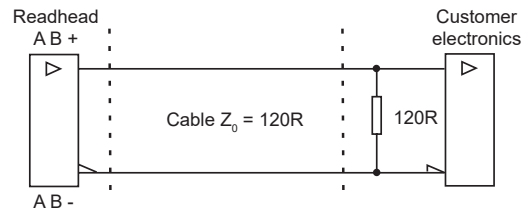

Analogue sinusoidal output signals (1 V_{pp})

The sinusoidal incremental signals A and B are phase-shifted by 90° elec. and have an amplitude of typically 1 V_{pp}.

Output signals	V_1, V_2
Sin/cos signals	Amplitude 0.8 V_{pp} to 1.2 V_{pp} (with 120 Ω termination)
Termination	$Z_0 = 120 \ \Omega$ between associated outputs

Timing diagram

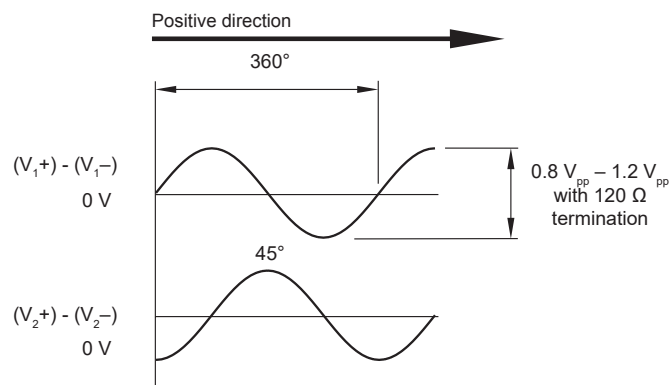

Readhead part numbering

LA11 SP A 13B K A 10C A 00

Communication interface

DA - BISS-C, RS422 + Analogue sinusoidal
DC - BISS-C, RS422
DI - BISS-C + Incremental (both RS422)
SB - Synchronous serial interface (SSI), RS422 + Analogue sinusoidal
SC - Synchronous serial interface (SSI), RS422
SI - Synchronous serial interface (SSI) + Incremental (both RS422)
SP - SPI slave
SQ - SPI slave + Incremental, RS422
SR - SPI slave + Analogue sinusoidal

Communication interface variant

For **SB**, **SC** and **SI**:

A - Position with general and detailed status
B - Position with general status
C - Position only
D - Position only - Gray code (not available with 2D0 resolution)

For **DA**, **DC** and **DI**:

A - up to 3.5 MHz CLK (ACK = 12 clock periods)
B - up to 5 MHz CLK (ACK = 20 clock periods)

For **SP**, **SQ** and **SR** (not available with 2D0):

A - Simple mode 3.3 V LVTTTL
B - Advanced mode 3.3 V LVTTTL
C - Simple mode 5 V TTL
D - Advanced mode 5 V TTL

Resolution

13B - $2/2^{13}$ mm (0.244140625 μ m)
12B - $2/2^{12}$ mm (0.48828125 μ m)
11B - $2/2^{11}$ mm (0.9765625 μ m)
2D0 - $2/2000$ mm (1 μ m) **
10B - $2/2^{10}$ mm (1.953125 μ m)
09B - $2/2^9$ mm (3.90625 μ m)
08B - $2/2^8$ mm (7.812 μ m)
07B - $2/2^7$ mm (15.625 μ m)
06B - $2/2^6$ mm (31.25 μ m)
05B - $2/2^5$ mm (62.5 μ m)
04B - $2/2^4$ mm (125 μ m)

Special requirements

00 - No special requirements (standard)
02 - DB15 connector for SIEMENS SMC30 module (for connector option **D**)

Connector option

A - 9 pin D type plug (for **DC**, **SC** and **SP** only)
D - 15 pin D type plug
F - Flying lead (no connector)
G - DB-25 for SIEMENS SMC20 module (for **SB** only)
K - Siemens 6FX2003-0SA17
P - Phoenix contact M12 8 pole (for **DC**, **SC** and **SP** only)

Cable length*

xxC - Any cable length from 10 cm to 99 cm
xxD - Any cable length from 10 dm to 99 dm
xxM - Any cable length from 10 m to 99 m

Power supply

A - 5 V
B - From 8 to 30 V (for **DA**, **DC**, **DI**, **SB**, **SC** and **SI** only)

Minimum edge separation

For **DA**, **DC**, **SB**, **SC**, **SP** and **SR**:

K - 0.07 μ s (15 MHz)

For **DI**, **SI** and **SQ**:

K - 0.07 μ s (15 MHz)

A - 0.12 μ s (8 MHz)

B - 0.5 μ s (2 MHz)

C - 1 μ s (1 MHz)

D - 2 μ s (0.5 MHz)

E - 4 μ s (0.25 MHz)

F - 5 μ s (0.2 MHz)

G - 10 μ s (0.1 MHz)

H - 20 μ s (0.05 MHz)

* xx stands for any number between 10 to 99.

** Available only for SSI and BiSS.

Not available for Gray protocol and SPI.

Series	Communication interface	Communication interface variant	Resolution	Minimum edge separation	Power supply	Cable length	Connector options	Special requirements
LA11	DA	A/B	13B / 12B / 11B / 2D0 / 10B / 9B / 08B / 07B / 06B / 05B / 04B	K	A/B	xxC / xxD / xxM	D / F / K	00
	DC			A / D / F / K / P				
	DI	K / A / B / C / D / E / F / G / H		D / F / K				
	SB	K		D / F / G / K				
	SC	A/B/C/D	K / A / B / C / D / E / F / G / H	A / D / F / K / P				
	SI		K	D / F / K				
	SP		K	A / D / F / K / P				
	SQ		K / A / B / C / D / E / F / G / H	D / F / K				
SR		13B / 12B / 11B / 10B / 9B / 08B / 07B / 06B / 05B / 04B	K	A				

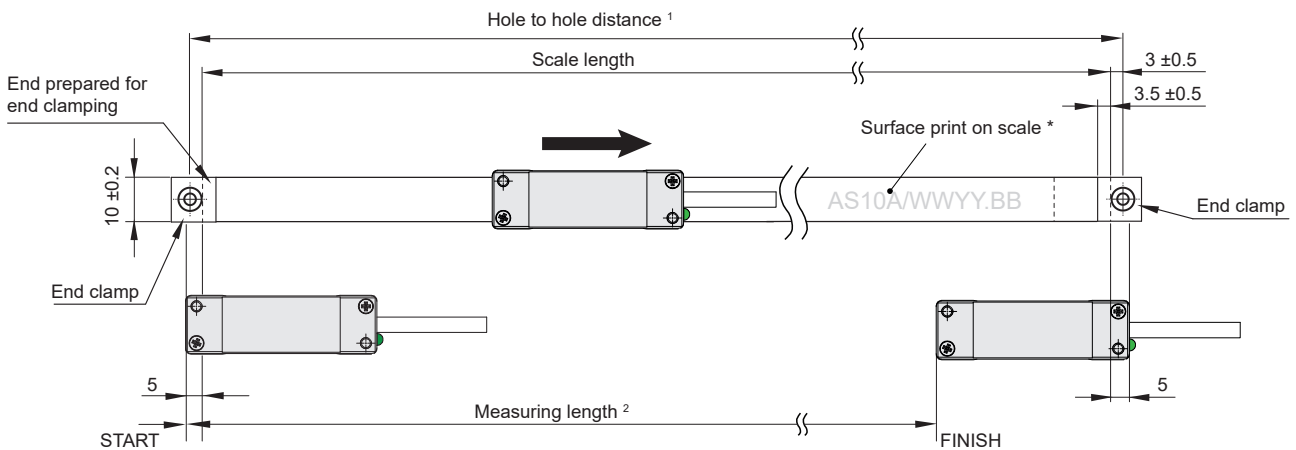

¹ Hole to hole distance (for end clamp mounting) = Scale length + (6 mm ±1 mm)
² Measuring length = Scale length - 42 mm

* Scale surface print does not represent the actual ordering code. For orientation purpose only.

AS10 magnetic scale part numbering

AS 10 A 01000 A 00

Precision class
A - ±20 µm/m

Scale length
xxxxx - Where xxxxx equals scale length in mm

Special requirements

- 00** - No special requirements (standard). Available up to 4 m**
- 01** - Thickness of scale 1.7 mm. Available from 4 m to 16.3 m
- 03** - Absolute code begins with 0. Available up to 16.3 m

Options

- A** - Back-adhesion tape (standard)
- B** - Back-adhesion tape, with CF10 cover foil*
- C** - Back-adhesion tape, ends prepared for end clamping²
- G** - No back-adhesion tape, sides prepared for insertion into track system¹
- H** - No back-adhesion tape, sides prepared for insertion into track system with CF08 cover foil*¹
- I** - No back-adhesion tape
- N** - No back-adhesion tape, with CF10 cover foil*
- P** - No back-adhesion tape, ends prepared for end clamping²

* Cover foil supplied separately.

** Not available for options G and H.

Cover foil part numbering

CF 10 1000

Width of cover foil
08 - 08 mm width (for track system option only)²
10 - 10 mm width

Foil length
xxxx - Where xxxx equals foil length in cm

¹ For details on TRS system please refer to data sheet LM10D18 on www.rls.si/lm10.

² For details on end clamp installation please refer to data sheet LM10D14 on www.rls.si/lm10.

Accessories part numbering

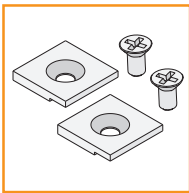

End clamp kit
(2 clamps + 2 screws)
LM10ECL00



USB encoder interface
E201-9S or E201-9Q

For details on E201 interfaces
please refer to data sheet E201 on
www.rls.si/e201.



Applicator tool for magnetic scale
LMA10ASC00



Magnet viewer
MM0001

Accessories for MS Track System



Track section, 1.00 m
TRS100A00



Track section, 2.00 m
TRS200A00



Scale clamp, 0.04 m
TRE004A00



Joining element, 0.04 m
TRE004A01



Screw and washer
TRC00

Head office

RLS merilna tehnika d.o.o.

Poslovna cona Žeje pri Komendi
Pod vrbami 2
SI-1218 Komenda
Slovenia

T +386 1 5272100

F +386 1 5272129

E mail@rls.si

www.rls.si

Document issues

Issue	Date	Page	Corrections made
6	13. 12. 2017	2	Storage and handling amended
		5	Technical specifications amended
		6, 7, 8	Graphs added and amended
		9	Cable specifications amended, 15-pin amended
		11	Available resolution amended
		21	AS part numbering amended
7	28. 5. 2018	5	Technical specifications amended
		11	New electrical connections added
		22	AS magnetic scale part numbering amended
		23	Accessories part numbering amended

This product is not designed or intended for use outside the environmental limitations and operating parameters expressly stated on the product's datasheet. Products are not designed or intended for use in medical, military, aerospace, automotive or oil & gas applications or any safety-critical applications where a failure of the product could cause severe environmental or property damage, personal injury or death. Any use in such applications must be specifically agreed to by seller in writing, and is subject to such additional terms as the seller may impose in its sole discretion. Use of products in such applications is at buyer's own risk, and buyer will indemnify and hold harmless seller and its affiliates against any liability, loss, damage or expense arising from such use. Information contained in this datasheet was derived from product testing under controlled laboratory conditions and data reported thereon is subject to the stated tolerances and variations, or if none are stated, then to tolerances and variations consistent with usual trade practices and testing methods. The product's performance outside of laboratory conditions, including when one or more operating parameters is at its maximum range, may not conform to the product's datasheet. Further, information in the product's datasheet does not reflect the performance of the product in any application, end-use or operating environment buyer or its customer may put the product to. Seller and its affiliates make no recommendation, warranty or representation as to the suitability of the product for buyer's application, use, end-product, process or combination with any other product or as to any results buyer or its customer might obtain in their use of the product. Buyer should use its own knowledge, judgment, expertise and testing in selecting the product for buyer's application, end-use and/or operating environment, and should not rely on any oral or written statement, representation, or samples made by seller or its affiliates for any purpose. EXCEPT FOR THE WARRANTIES EXPRESSLY SET FORTH IN THE SELLER'S TERMS AND CONDITIONS OF SALE, SELLER MAKES NO WARRANTY EXPRESS OR IMPLIED WITH RESPECT TO THE PRODUCT, INCLUDING ANY WARRANTY OF MERCHANTABILITY OR FITNESS FOR ANY PARTICULAR PURPOSE, WHICH ARE DISCLAIMED AND EXCLUDED. All sales are subject to seller's exclusive terms and conditions of sale which, where the seller is (a) RLS merilna tehnika d.o.o., are available at <https://www.rls.si/customer-service>, (b) Renishaw, Inc., are available at <http://www.renishaw.com/Shop/legal/en/-42186>, or (c) another person, are available on request, and in each case, are incorporated herein by reference, and are the exclusive terms of sale. No other terms and conditions apply. Buyer is not authorized to make any statements or representations that expand upon or extend the environmental limitations and operating parameters of the products, or which imply permitted usage outside of that expressly stated on the datasheet or agreed to in writing by seller.

RLS merilna tehnika d.o.o. has made considerable effort to ensure the content of this document is correct at the date of publication but makes no warranties or representations regarding the content. RLS merilna tehnika d.o.o. excludes liability, howsoever arising, for any inaccuracies in this document. © 2018 RLS d.o.o.