

Built to Perform

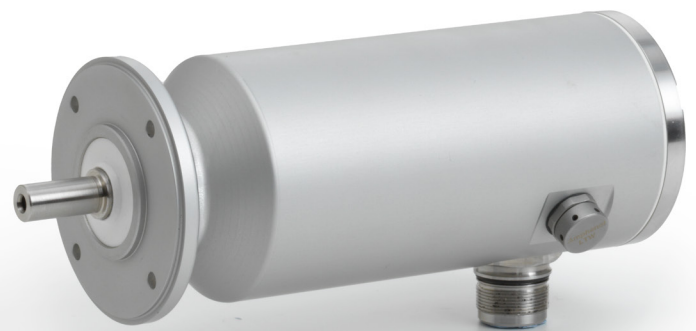

AKMA Servo Motors

Durability, cleanability and versatility for medium to heavy washdown applications



KOLLMORGEN

A REGAL REXNORD BRAND

Bringing Together Value and Performance

AKMA servo motors from Kollmorgen are designed for critical medium to heavy washdown environments and variable weather applications.

These lightweight, workhorse motors incorporate a hardened anodized aluminum coating, a versatile form factor and strong chemical resistance. See how the AKMA motors meet your motion needs in a wide range of harsh environments with reliability and outstanding value.



DURABLE

Kollmorgen motors feature an anodized aluminum coating and vented design to deliver dependable operation in tough washdown environments.

CLEANABLE

Whether in food and beverage contact zones or dry clean environments, AKMA motors deliver the high cleanability you demand.

VERSATILE

Wherever high-torque, lightweight motors are critical, and space is limited, the AKMA motor fits your specific design requirements.

AFFORDABLE

When paired with SFD-M feedback, AKMA motors are a cost-effective solution.

SAFE

Functional safety encoder options allow AKMA motors to integrate easily into machines that require certified safety performance.



Purpose-Built Performance Where You Need It

Every Kollmorgen product is engineered and manufactured to play a vital role in your machine design. The AKMA motor is no exception, offering a lightweight design and high reliability in harsh environments where caustic chemical washdowns are not applied.

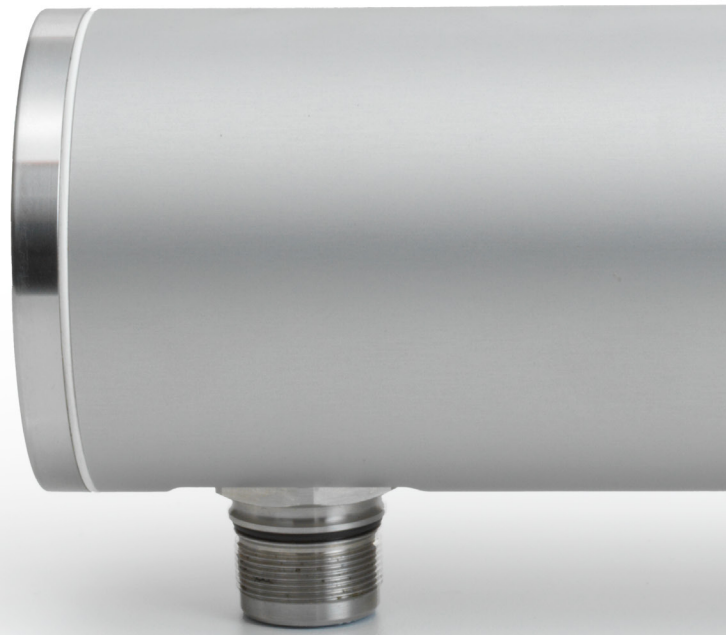

BUILT FOR DURABILITY

- Hard anodized aluminum coating provides strong chemical resistance in a wide pH range to withstand common cleaning agents and enhance durability in washdown
- Coating is less vulnerable to scrapes, dents, and paint flaking than conventional epoxy
- Highly durable stainless-steel shaft meets functional safety requirements
- Chromium oxide shaft inlay increases shaft hardness to reduce shaft seal wear and maximize operational life
- “One-piece” housing structure eliminates the O-ring and helps to prevent water ingress
- Vented design equalizes pressure inside and outside the motor for enhanced durability and reduced ingress through seals and O-rings

BUILT FOR AFFORDABILITY

- SFD-M battery-free, multi-turn absolute feedback provides performance comparable to HIPERFACE® or EnDat feedback devices without the added cost

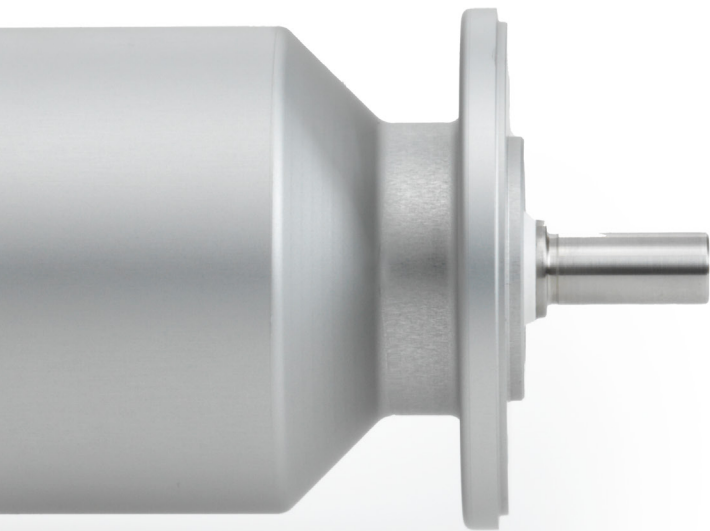

BUILT FOR CLEANABILITY

- Smooth surface design for cleanability in food and beverage contact zones
- Round housing eliminates flat surfaces where contamination droplets can pool
- IP69K rated sealing allows higher pressure exposure for food-grade environments

BUILT FOR VERSATILITY

- Lightweight design makes the AKMA motor easy to install and maintain
- High torque density in a smaller-size motor delivers critical performance improvement across demanding environments

BUILT FOR SAFETY

- Available with HIPERFACE DSL® and EnDat 2.2 safe encoders, enabling integration into applications that require functional safety compliance

The versatile and lightweight AKMA motor is designed for the demanding washdown environments found in food and beverage processing. It is also ideally suited for precision motion in pharmaceutical production and packaging as well as harsh outdoor environments.

AKMA Servo Motors





Parameters	Sym	Units	AKMA2x				AKMA3x		
			1	2	3	4	1	2	3
Continuous Torque	T_c	Nm	0.45	0.82	1.13	1.36	1.18	2.05	2.84
Rated Speed	N_{rtd}	rpm	8000	8000	8000	8000	6000	6000	5500
Rotor Inertia	J_r	kg·cm ²	0.11	0.16	0.22	0.27	0.33	0.59	0.85

Parameters	Sym	Units	AKMA4x				AKMA5x			
			1	2	3	4	1	2	3	4
Continuous Torque	T_c	Nm	1.89	3.39	4.63	5.63	4.62	8.20	10.9	13.4
Rated Speed	N_{rtd}	rpm	6000	6000	6000	6000	6000	6000	6000	6000
Rotor Inertia	J_r	kg·cm ²	0.81	1.5	2.1	2.7	3.4	6.2	9.1	12.0

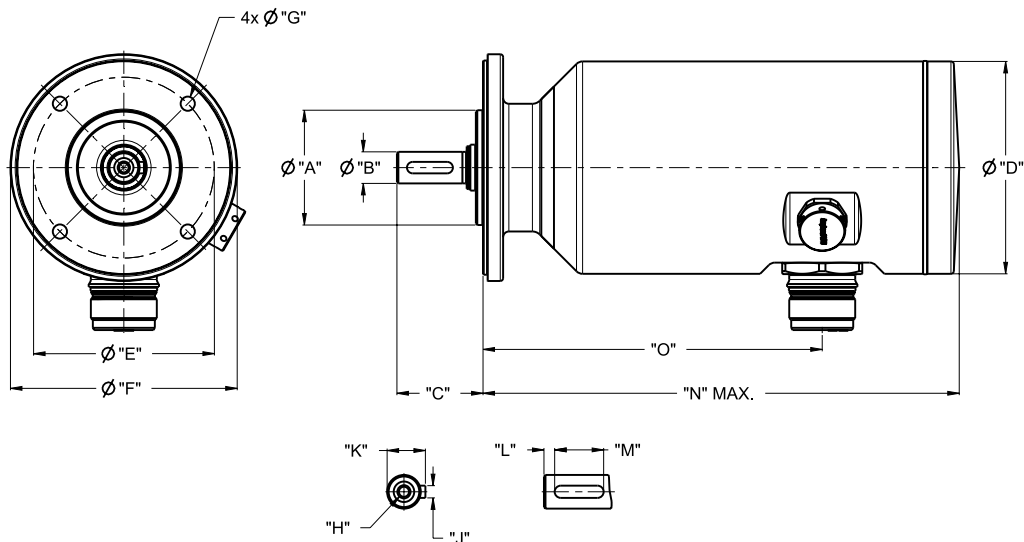
Values shown are representative of each model. For exact information refer to the selection guide, installation manual, Motioneering and design tools.

AKMA Series	A	B	C	D	E	F	G	H	J	K	L	M	N; by stack length				O; by stack length			
													1	2	3	4	1	2	3	4
AKMA2x-AN	40	11	30	74	63	79	4.8	M4	--	--	--	--	166	185	204	223	118	137	156	175
AKMA2x-AC									12.5	4.0	3.5	16								
AKMA3x-AN	60	14	30	85	75	89	5.8	M5	--	--	--	--	166	197	228	--	118	149	180	--
AKMA3x-AC									16.0	5.0	21.5	27								
AKMA4x-AN	80	19	40	113	100	117	7.0	M6	--	--	--	--	171	200	229	258	123	152	181	210
AKMA4x-AC									21.5	6.0	4.0	25								
AKMA5x-GN	95	24	50	132	115	137	9.0	M8	--	--	--	--	186	217	248	279	138	169	200	231
AKMA5x-GC									27.0	8.0	4.0	36								



	AKM	AKM Washdown	AKM Food Grade	AKMA	AKMH
					
Housing Material & Coating	Square-frame A380 Aluminum polyester powder coating; matte black	Square-frame A380 Aluminum 2K epoxy paint; gray	Square-frame A380 Aluminum 2K epoxy FDA-compliant paint; white	Round-frame 6082 Aluminum Anodized; satin gray	Round-frame 1.4404/316 Stainless steel; Surface roughness < 0.8 µm per EHEDG requirement
Mounting Style	Flange	Flange	Flange	Flange	Flange or Face
Ingress Protection (IP)	IP65 (static); w/shaft seal	IP67 (static)	IP67 (static)	IP69K (static)	IP69K (static)
IP Rating Definition	6 = Dust-tight				
	5 = Water jets (7 is possible w/ straight conn.)	7 = Immersion up to 1m, for 30 min.		9K = High-pressure/High-temp	
Shaft Seal	1 = Teflon shaft seal	OW = includes Teflon shaft seal	OF = includes IP67 Food-Grade PTFE shaft seal	IP69K Food-Grade PTFE shaft seal	IP69K Food-Grade PTFE shaft seal
Typical Connectors	Nickel-plated TE/ Interconnect Connectors	SS Hummel Connectors (unpainted)	SS Hummel Connectors (unpainted)	IP69K SS Motor-mounted Hummel Connectors	IP69K integrated motor cable; optional IP69K SS Motor-mounted Hummel Connectors
Application Examples	<ul style="list-style-type: none"> General factory automation where exposure to contaminants (i.e. fluids, oil, dust) is possible 	<ul style="list-style-type: none"> Food and beverage Packaging (i.e. transport axes with no direct contact to food) General factory automation (i.e. similar applications to AKM with added protection and longevity) 	<ul style="list-style-type: none"> Food and beverage Packaging Cutting Packing and filling where direct contact to food is possible (motor positioned laterally or below food) 	<ul style="list-style-type: none"> Food and beverage (i.e. meat slicing, proportioning, dispensing applications where direct contact to food is likely) Pharmaceutical production Medical laboratories Radar stations Harsh outdoor applications 	<ul style="list-style-type: none"> Food and beverage (including food contact and splash zones) Packaging Machine applications requiring heavy sanitization or exclusive use of stainless components (i.e. use of highly acidic, caustic chemicals) Pharmaceutical production Medical laboratories
Relative Price	\$	\$+	\$++	\$	\$\$\$

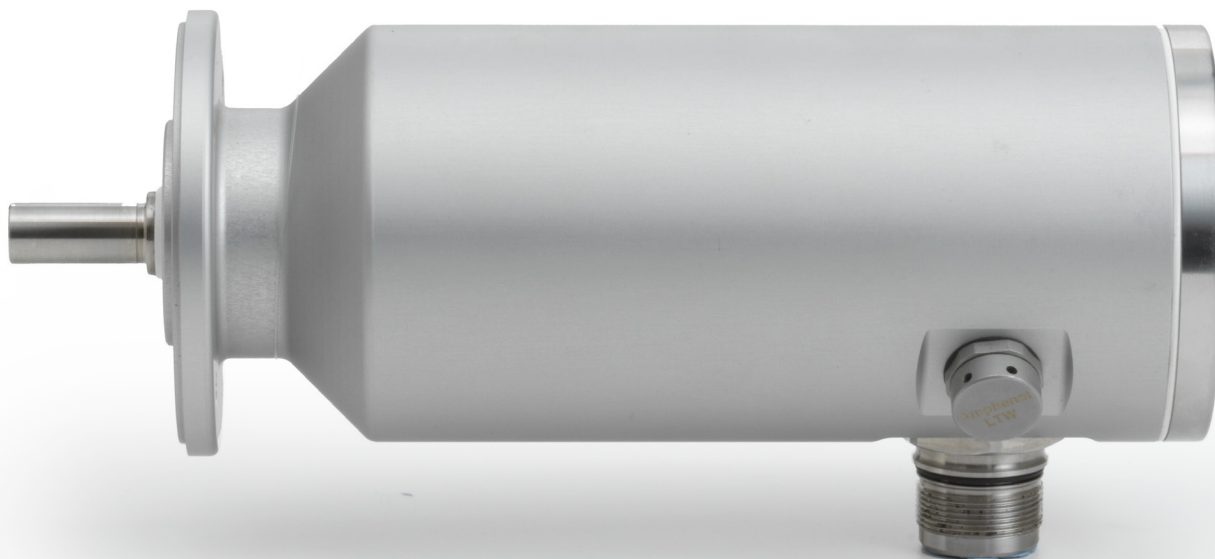

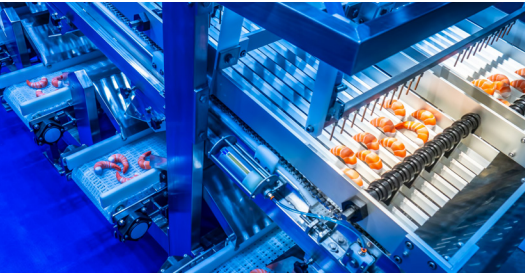

About Kollmorgen

Kollmorgen has more than 100 years of motion experience, proven in the industry's highest-performing, most reliable motors, drives, linear actuators, AGV control solutions and automation platforms. We deliver breakthrough solutions that are unmatched in performance, reliability and ease of use, giving machine builders an irrefutable marketplace advantage.

www.kollmorgen.com

KOLLMORGEN

A REGAL REXNORD BRAND