

**SLO-SYN<sup>®</sup>**  
**230-T, 430-T, 230-TH, and 430-TH**



**INSTRUCTION MANUAL**  
**Part Number 213710-016 Rev. I**

## Record of Manual Revisions

Revision	Date	Description of Revision
G	Dec 2003	Updated corporate information
I	Feb 2004	Updated corporate information

DANAHER MOTION is a registered trademark of Danaher Corporation. Danaher Motion makes every attempt to ensure accuracy and reliability of the specifications in this publication. Specifications are subject to change without notice. Danaher Motion provides this information "AS IS" and disclaims all warranties, express or implied, including, but not limited to, implied warranties of merchantability and fitness for a particular purpose. It is the responsibility of the product user to determine the suitability of this product for a specific application.

©2004 Danaher Motion.

Safety-alert symbols used in this document are:



***Warning Alerts users to potential physical danger or harm. Failure to follow warning notices could result in personal injury or death.***



***Caution Directs attention to general precautions, which if not followed, could result in personal injury and/or equipment damage.***



***Note Highlights information critical to your understanding or use of the product.***

# Table of Contents

<b>1</b>	<b>EXPRESS START-UP</b> .....	<b>1</b>
<b>2</b>	<b>INSTALLATION</b> .....	<b>5</b>
2. 1	NOISE SOURCES .....	5
2. 2	MOUNTING .....	6
2. 3	WIRING PRACTICES .....	6
2. 4	INTERFERENCE TROUBLESHOOTING .....	9
<b>3</b>	<b>INTRODUCTION</b> .....	<b>11</b>
3. 1	INSPECTIONS PARTS LIST .....	12
3.1.1.	<i>LOGIC AND VOLTAGE CONVENTIONS</i> .....	12
<b>4</b>	<b>MOUNTING AND PIN ASSIGNMENTS</b> .....	<b>13</b>
4. 1	MOUNTING .....	13
4. 2	MOTOR CONNECTIONS .....	17
4. 3	CONTROL INTERFACE .....	18
<b>5</b>	<b>SPECIFICATIONS</b> .....	<b>19</b>
5. 1	PERFORMANCE SPECIFICATIONS .....	19
5.1.1.	<i>MOTOR FAMILIES</i> .....	19
5. 2	MOTOR COMPATIBILITY .....	20
5. 3	MECHANICAL SPECIFICATIONS .....	21
5. 4	ELECTRICAL SPECIFICATIONS .....	21
5.4.1.	<i>INPUT POWER SUPPLY</i> .....	21
5.4.2.	<i>OUTPUT TO MOTOR</i> .....	22
5. 5	CONTROL INTERFACE REQUIREMENTS .....	23
5. 6	OPTO-ISOLATION .....	23
5. 7	ENVIRONMENTAL REQUIREMENTS .....	23
5. 8	FUNCTIONAL DESCRIPTION .....	23
5. 9	SIGNAL DESCRIPTION .....	24

<b>6</b>	<b>PIN CONFIGURATION AND OPERATIONS.....</b>	<b>25</b>
6. 1	PU (PULSE IN).....	25
6. 2	CW / CCW (DIRECTION).....	25
6. 3	H/F (HALF / FULL).....	25
6. 4	AWO (ALL WINDINGS OFF).....	25
6. 5	REDUCED CURRENT .....	26
6. 6	LOGIC COMMON .....	26
6. 7	OPTO SUPPLY OUT .....	26
6. 8	OPTO SUPPLY IN.....	27
6. 9	$V_M$ .....	28
6. 10	$V_{OM}$ .....	28
6. 11	MOTOR PHASE A ( $\emptyset A$ ) .....	28
6. 12	MOTOR PHASE B ( $\emptyset B$ ) .....	28
<b>7</b>	<b>SPEED / TORQUE CURVES .....</b>	<b>29</b>
7. 1	230 SERIES MOTION CONTROLS.....	29
7. 2	430 SERIES MOTION CONTROLS.....	33
7. 3	MOTOR PERFORMANCE .....	41
7. 4	SUPPORT INFORMATION.....	42

# 1 EXPRESS START-UP

This supplementary instruction outlines the minimum steps necessary for the Translator Drive to become operational. **FAILURE TO PERFORM THESE STEPS MAY RESULT IN DAMAGE TO THE DRIVE.**



**Never connect or disconnect anything from the module with power on.**

1. Connect the plus of a 28 VDC power supply to  $V_M$  and the minus to  $V_{OM}$ . The supply must be capable of supplying 2.5 A for a 230-T or 230-TH and 4.0 A for a 430-T or 430-TH.

*RECOMMENDED 28 VDC POWER SUPPLY (Single Drive Applications)* shows a recommended power supply for applications using one Translator Drive. Recommended power supply configurations for applications where multiple drives are to be operated from a single supply are shown in *RECOMMENDED 28 VDC POWER SUPPLY (Multiple Drives on One Supply)*.

2. The power supply output filter capacitor must be a 4700  $\mu\text{f}$  minimum. If this capacitor is more than 6 inches (152 mm) from the drive module, and additional 250  $\mu\text{f}$ , 50 V capacitor must be installed between  $V_M$  and  $V_{OM}$  at the drive module.
3. The power supply peak ripple values must not go higher than 32 V or lower than 26 V.
4. Make sure the motor to be used is compatible with the drive. Refer to the manual for a list of compatible motors.
5. Use the motor connection diagrams shown in the manual for 4, 6, or 8-lead motors. When using a 6-lead motor, be sure to insulate an isolate the unused wires. Be sure to insulate all motor leads to prevent inadvertent shorts to ground or to each other.
6. If it is desired to operate in the reduced-current mode, install a resistor of the appropriate value between the REDUCE CURRENT pin and the LOGIC COMMON pin. Refer to the speed/torque data and the resistor versus current table included in the drive manual.
7. To connect the logic controls, refer to *Functional Description*, for connectors.



**The module case is tied to the  $V_{OM}$  and LOGIC COMMON pins internally. Do not tie your power supply to ground at another location.**



**Operation at speeds less than 350 full steps per second may be erratic due to motor resonance. Avoid this speed range if a problem exists.**

RECOMMENDED 28 VDC POWER SUPPLY  
230-T / 430-T DRIVES  
SINGLE DRIVE APPLICATIONS

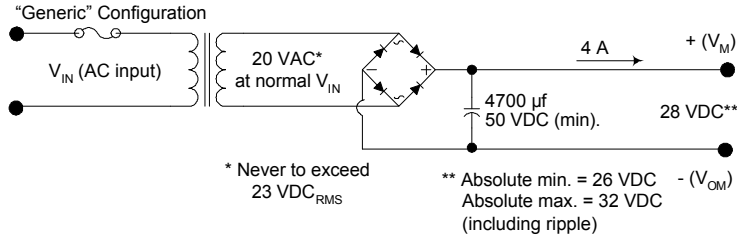

Actual Configuration for 115 VAC Operation

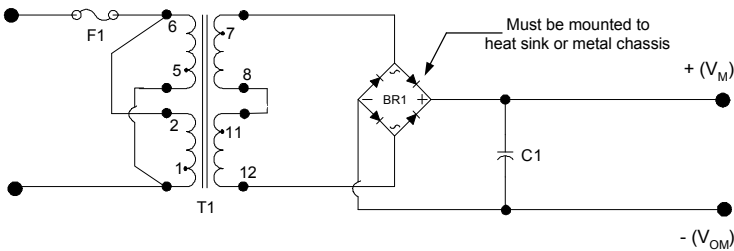

PARTS LIST

ITEM	TYPE	RATINGS	TYPICAL MFGR. & PART NO.
F1	FUSE	3 A, 250 V, SLOW-BLOW	BUSSMAN MDA-3
T1	TRANSFORMER	130 VA, 115/230 V PRIM. 20 V CT. SECONDARY	SIGNAL A41 -130-20
BR1	RECTIFIER, BRIDGE	30 A, 200 V	VARO VK248
C1	ELECTROLYTIC CAPACITOR	4700 $\mu$ f, 63 VDC 3.33 A <sub>RMS</sub>	SPRAGUE 530D472G063JP6

For 230 VAC, 50 Hz operation, connect T1 primary windings in series (Rest of circuit remains the same)

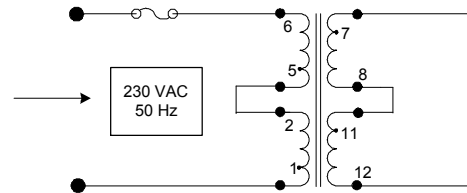

RECOMMENDED 28 VDC POWER SUPPLY  
 230-T / 430-T DRIVES  
 MULTIPLE DRIVES ON ONE SUPPLY

1) Using Diode Isolation

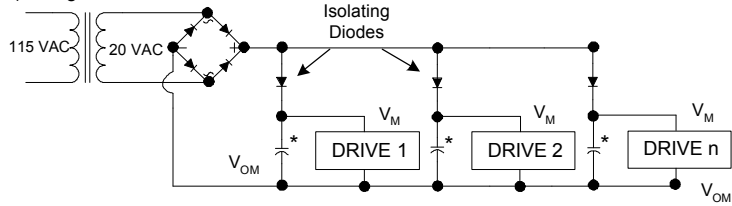

2) Using separate Transformer Windings

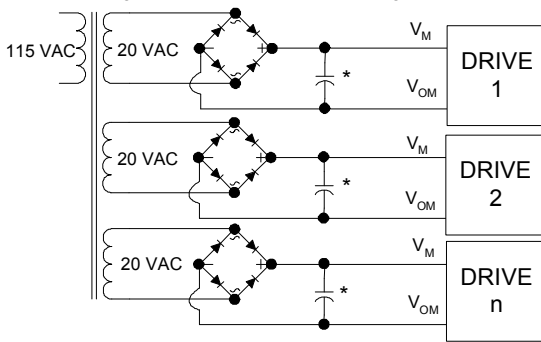

3) Using separate Bridge Rectifiers

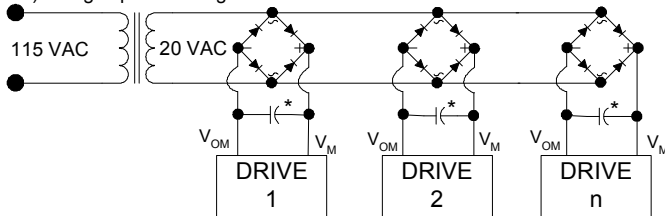

\*All filter capacitors are 4700  $\mu$ f, 50 VDC (min.)

## TYPICAL REDUCED CURRENT INTERFACE

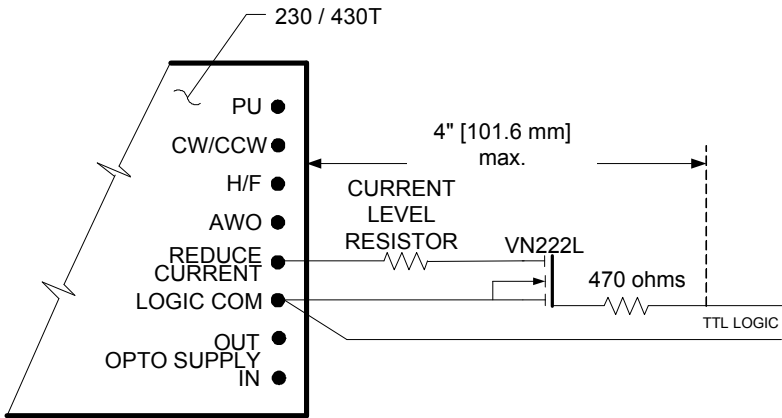

1. - A "HIGH" level TTL signal on the input activates REDUCE CURRENT
2. - Keep the FET and current level resistor within four inches of the module.
3. - Refer to the manual for current level resistor values.

## 2 INSTALLATION

SLO-SYN Micro Series drives use modern solid-state electronics such as microprocessors to provide the features needed for advanced motion control applications. In some cases, these applications produce electromagnetic interference (EMI or electrical “noise”) that may cause inappropriate operation of the microprocessor logic used in the Micro Series product, or in any other computer-type equipment in the user’s system.

This guide is aimed toward helping users avoid such problems at the start by applying “good engineering practices” when designing their systems. Following these guidelines will usually prevent EMI noise from interfering with drive operation.

### 2.1 NOISE SOURCES

What causes electrical noise? In general, any equipment that causes arcs or sparks or that switches voltage or current at high frequencies can cause interference. In addition, AC utility lines are often “polluted” with electrical noise from outside a users control (such as equipment in the factory next door).

The following are some of the more common causes of electrical interference:

- Power from the utility AC line
- Relays, contactors and solenoids
- Light dimmers
- arc welders
- motors and motor starters
- induction heaters
- radio controls or transmitters
- switch-mode power supplies
- computer based equipment
- high frequency lighting equipment
- CD servo stepper motors and drives

## 2.2 MOUNTING

When selecting a mounting location, it is preferable to keep the drive away from obvious noise sources, such as those listed above. If possible, locate the drive in its own metal enclosure to shield it and its wiring from noise sources. If this cannot be done, keep the drive at least three feet away from any noise sources.

## 2.3 WIRING PRACTICES

**Do** the following when installing or wiring your drive or indexer:

- **Do** keep the drive and its wiring as far away from noise sources as possible.
- **Do** provide a good, solid ground connection to the AC system earth ground conductor. Bond the drive case to the system enclosure.
- **Do** use a single-point grounding scheme for all related components of a system (this looks like a “hub and spokes” arrangement).
- **Do** keep the ground connection short and direct.
- **Do** use a line filter on the AC input (Corcom type 10B1, 10S1, or 10K1 or equivalent) for noisy AC lines. Particularly bad AC lines may need to be conditioned with a ferroresonant type isolation transformer to provide “clean” power to the drive or indexer.
- **Do** keep signal and driver wiring well separated. If these wires must cross they should do so at right angles to minimize coupling. Power wiring includes AC wiring, motor wiring, etc. and signal wiring includes inputs and outputs (I/O), serial communications (RS-232 lines), etc.
- **Do** use separate conduits or ducts for signal and I/O wiring. Keep all power wiring out of these signal line conduits.
- **Do** use shielded, twisted-pair cables for indexer I/O lines.
- **Do** ground shield only at **one end**, the indexer/drive end.
- **Do** use twisted-pair, shielded cable for motor wiring.

- **Do** use solid-state relays instead of electromechanical contact types wherever possible to minimize noise generation.
- **Do** suppress all relays to prevent noise generation. Typical suppressors are capacitors or MOV's. See manufacturer's literature for complete information.
- **Do** use shielded, twisted-pair cables for connections to RS-232 serial port.

**Do not** do the following when installing your drive or indexer:

- **Do not** install sensitive computer based equipment (such as indexer/drive) near a source of electromagnetic noise.
- **Do not** bundle power and signal lines together.
- **Do not** bundle motor cables and signal lines together.
- **Do not** fail to use shielded, twisted-pair cables for signals.
- **Do not** fail to properly connect the system grounds.
- **Do not** use "daisy-chained" grounds.
- **Do not** fail to ground signal cable shields at only one end.
- **Do not** assume that power from the AC line is adequately "clean".

### RECOMMENDED WIRING PRACTICE

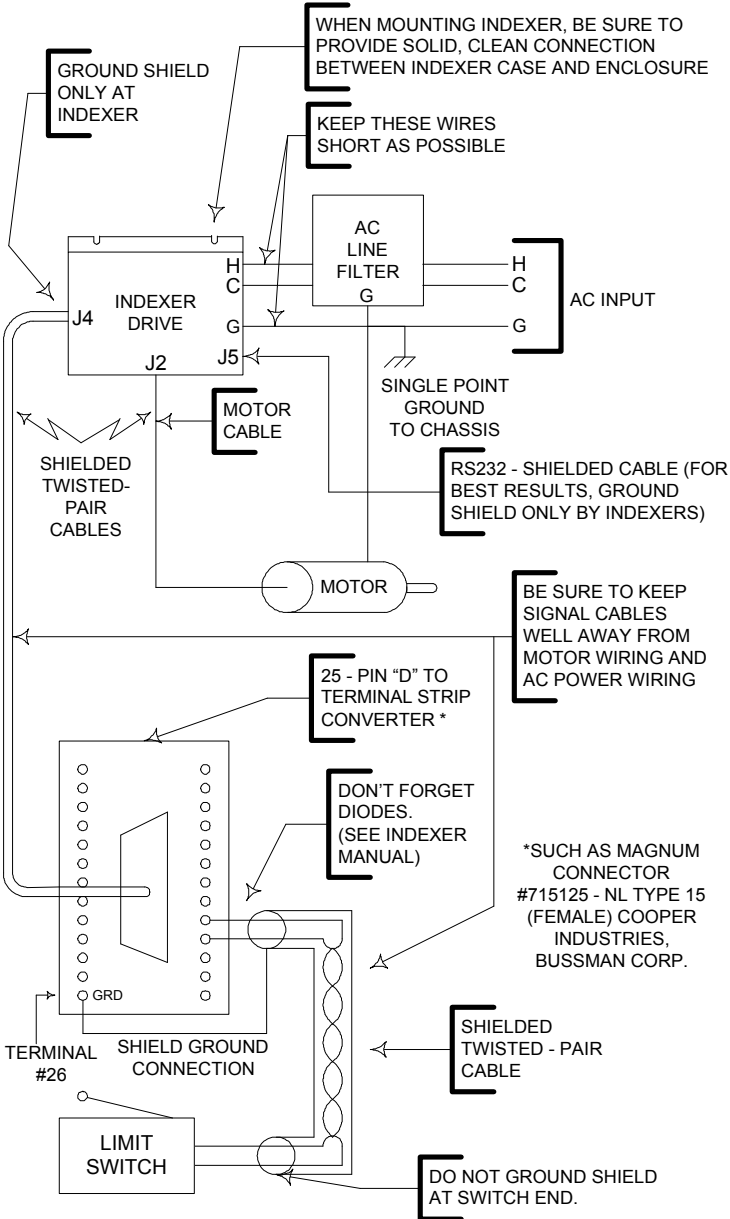

## **2.4 INTERFERENCE TROUBLESHOOTING**

Electrical interference problems are common with today's computer-based controls, and such problems are often difficult to diagnose and cure. If such a problem occurs with your system, it is recommended that the following checks be made to locate the cause of the problem.

1. Check the quality of the AC line voltage using an oscilloscope and a line monitor, such as Danaher Motion's VMS series. If line voltage problem exist, use appropriate line conditioning, such as line filters or isolation transformers.
2. Be certain all of the Do's and Don'ts are followed for location, grounding, wiring, and relay suppression.
3. Double check the grounding connections to be sure they are good electrical connections and are as short and direct as possible.
4. Try operating the drive with all suspected noise sources switched off. If the drive functions properly, switch the noise sources on again, one at a time, and try to isolate which ones that are causing the interference problems. When a noise source is located, try rerouting wiring, suppressing relays or other measures to eliminate the problem.

***Voltage is present on unprotected pins when unit is operational.***



***No short circuit protection for motor inputs is provided in this unit.***

***Before making changes to the motor or control wiring, turn off all power to the unit.***

**Assure motor compatibility before using the unit.**

**Observe all cooling and temperature limitations. Module case temperature must be maintained between 0 and 75° C (32 and 167° F).**

**Do not operate the unit without the proper filter capacitor as specified in 5.4.1.2 Filter Capacitor Requirements**



**All Windings Off should be used with caution, as all holding torque is lost.**

**Do not connect or disconnect motor or signal cables while power is supplied.**

**Do not apply power until all connections have been made correctly.**

**Do not exceed specified input voltages.**

**Reconfiguration of the circuit in any fashion not shown in this manual will void the warranty.**

**Clockwise and counterclockwise directions are properly oriented when viewing the motor from the label end.**



**The motor connector consists of 7 pins, and is symmetrical around the center pin. If connections are inadvertently rotated 180 degrees, motor direction (CW, CCW) will be reversed. Motor direction can also be reversed by swapping the two motor connections of the same phase (for example, swapping M1 and M3).**

**Erratic motion may be caused by a low filter capacitor, input pulses not of proper level or width, or supply voltage out of tolerance**

**Motors connected to this drive can develop high torque and large amounts of mechanical energy.**



**Keep clear of the motor shaft, and all parts mechanically lined to the motor shaft.**

**Turn off the power to the drive before performing work on parts mechanically coupled to the motor.**

### 3 INTRODUCTION

This manual is an installation and operating guide to the 230-T(H) and 430-T(H) motor drive modules. All the information provided is necessary for using these modules successfully.

This manual is organized for the convenience of the operator. *MOUNTING AND PIN ASSIGNMENTS*, provides the diagrams and reminders necessary for the experienced user and installer.

*SPECIFICATIONS*, will provide easily referenced information concerning all aspects of installation, power and interface requirements, as well as performance specifications.

*Functional Description* provides operational information useful in design diagnostic, and troubleshooting situations.

*PIN CONFIGURATION AND OPERATIONS*, provides detailed information for use of the equipment.

The 230 and 430 drive modules are differentiated as follows:

	<b>CURRENT PER PHASE</b>	<b>VA PER PHASE</b>
230-T or TH	2 A peak	56 VA nominal
430-T or TH	3.5 A peak	96 VA nominal

“T” designates the translator module.

“TH” designates the translator module equipped with the heat sink.

The 230 –T(H) and the 430 – T(H) are high efficiency bipolar chopper type translator modules, designed in small, easily mounted packages. They can be used with a wide range of Danaher Motion SLO-SYN 2-phase stepping motors, 4, 6, or 8 lead types.

The 230 –T(H) and the 430 – T(H) use resistive current sensing and provide for full and half-step operation. Inputs are optically isolated, with choice of using internal or external opto power supplies. All units feature reduced current and all windings off capabilities.

### 3.1 INSPECTIONS PARTS LIST

Translator Module	230-T(H) or 430-T(H)
7 – Pin Connector	B215744-007
8 – Pin Connector	B215744-008

#### 3.1.1. LOGIC AND VOLTAGE CONVENTIONS

Throughout this manual the following conventions are followed:

- The designation “ $V_O$ ” signifies the logic signal common terminal. “ $V_{OM}$ ” signifies the motor supply voltage common terminal. Both  $V_O$  and  $V_{OM}$  are internally connected to the module’s aluminum case.
- All logic functions are *low true logic*. A logic low or logic 0 will activate a function and a logic high, or logic 1 will deactivate a function. Thus,
 

**IN THIS MANUAL THE TERMS ACTIVE OR ACTIVATE WILL IMPLY A LOGIC LOW CONDITION AND THE TERMS INACTIVE OR DEACTIVATE WILL IMPLY A LOGIC HIGH CONDITION.**

In cases where the function changes with a change in logic state, the low true (active) will be indicated with a bar. For example, in the case of CW / CCW, CW is active with no connection.

- All logic control pins are optically isolated internally. When a pin is left *open*, it is clamped in a *logic high* (inactivated) state by the optical isolator.
- The motor drive changes state and advances the motor one step (or one-half step in the half-step mode) on a positive going (low to high) pulse edge.
- Clockwise (CW) and counterclockwise (CCW) are oriented correctly when viewing the motor from the nameplate (Label) end.

## 4 MOUNTING AND PIN ASSIGNMENTS

### 4.1 MOUNTING

The 230-T and 430-T modules are epoxy encapsulated with an aluminum frame. The back surface of this frame has flanges and mounting holes. *Mounting Diagram – Module part 1 and 2* provide the mounting hole diameters and locations.

It is recommended that 6-32 or 8-32 screws be used for mounting.

The major mounting consideration is that the case temperature be maintained below 167° F (75° C). For operation at or near full load, or at a higher temperature than 75° F (25° C) mounting to a heat sink is required.

A correctly configured heat sink is supplied by Danaher Motion: Part # C215737-001-DB.

Also, the motor drive module can be ordered with the heat sink attached by specifying model # 230-TH or 430-TH.

If no heat sink or an alternate heat sink is used, silicone heat sink compound (such as Dow-Corning number 340) must be used on the mounting surface.



***A very thin coating is sufficient. Too much coating is worse than none at all.***

When a heat sink is used, the heat sink fins should be mounted in a **vertical position**, unless forced-air cooling is used.

*Mounting Diagram – Heat Sink* shows the mounting hole locations and diameters for the Danaher Motion supplied heat sink.

Mounting Diagram – Module part 1

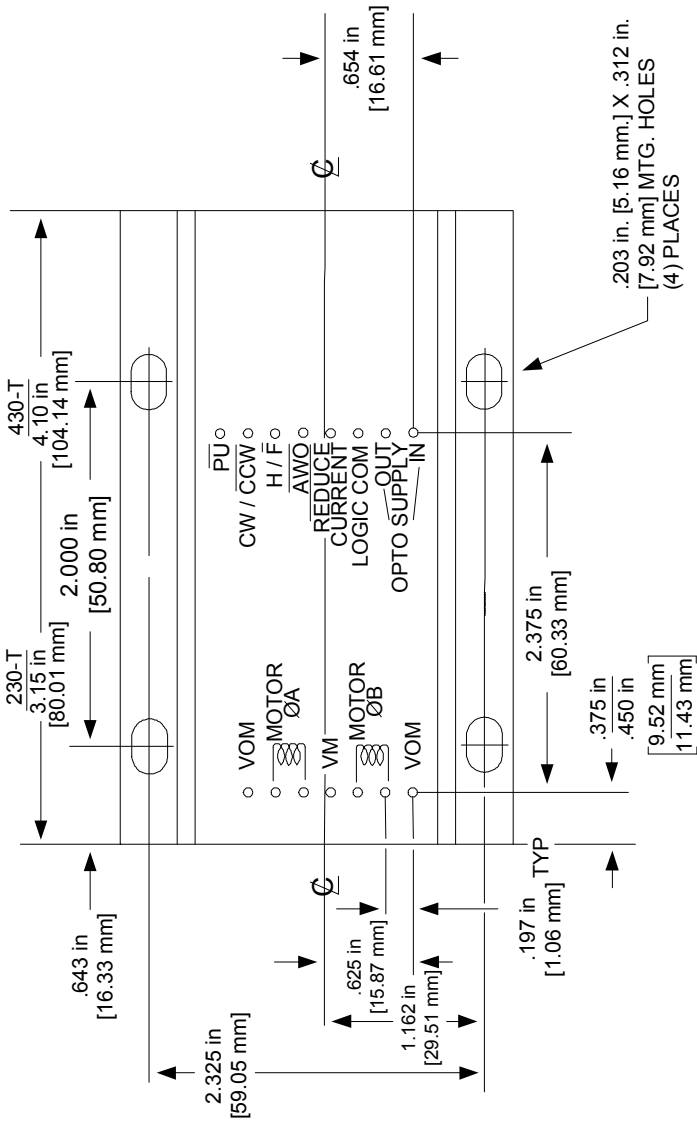

### Mounting Diagram – Module part 2

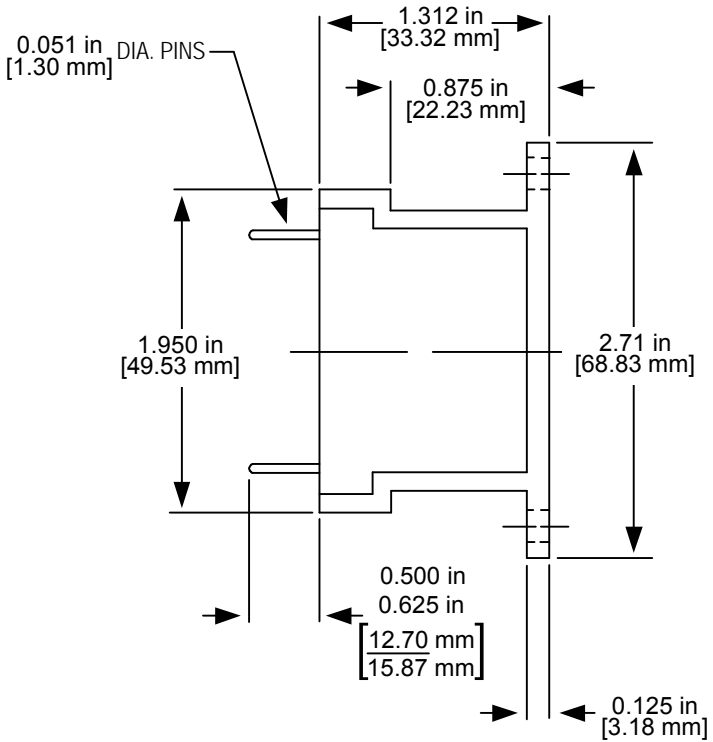

Mounting Diagram – Heat Sink

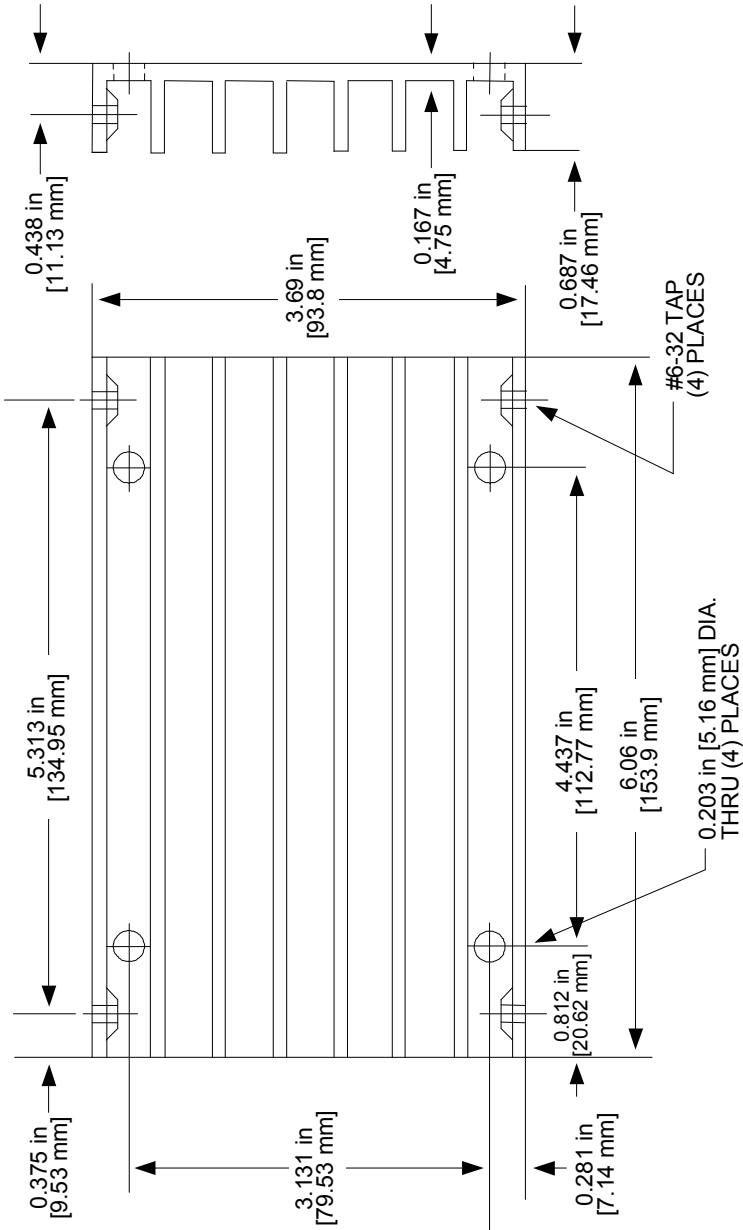

## 4.2 MOTOR CONNECTIONS

All motor connections are made via the 7 pins or a 7 pin connector (Danaher Motion part number B215744-007) on the motor drives. *Output Pin Assignments*, below, shows the location and function of the motor drive pins. Sections 5.4.2.1 and 6. 9-6. 12 give details of how to make the motor connections.

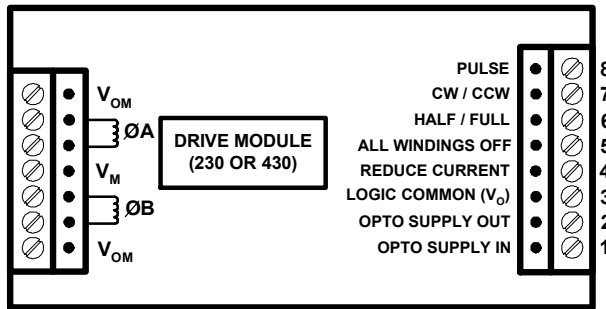

Output Pin Assignments

It is suggested that a Danaher Motion motor cable be used. They are available as follows:

CABLE CONFIGURATION		CABLE PART NUMBER		
DRIVE END	MOTOR END	10 FEET LONG	25 FEET LONG	50 FEET LONG
UNTERMINATED LEADS	PLUG*	B216067-001	B216067-002	B216067-003
CABLE ONLY WITHOUT CONNECTORS		B216022-001	B216022-002	B216022-003

\* Mates with receptacle on M061, M062, and M063 motors that have receptacles (M061-CS08, etc.)



**The motor drive pins are arranged symmetrically about the center  $V_M$  pin. If the motor connector is inadvertently rotated 180° when connecting the motor, then the CW and CCW directions will be reversed.**

The 230 and 430 Series Translator Modules can be used with 6-lead and 8-lead SLO-SYN<sup>®</sup> motors. *Motor Connections* shows the correct connections for each possible motor configuration.

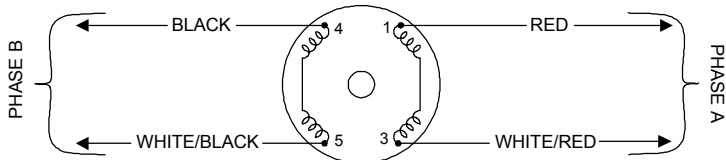

**4-LEAD MOTORS, SERIES CONNECTION**

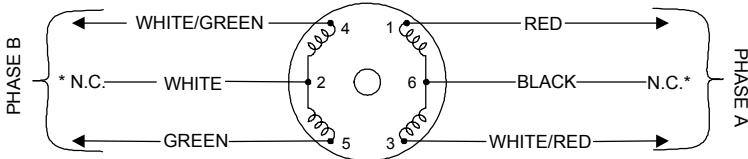

**6-LEAD MOTORS, SERIES CONNECTION**

**NOTE: NC = NO CONNECTION**

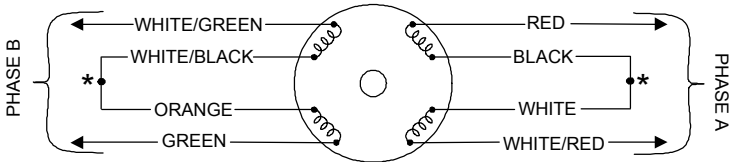

**8-LEAD MOTORS, SERIES CONNECTIONS**

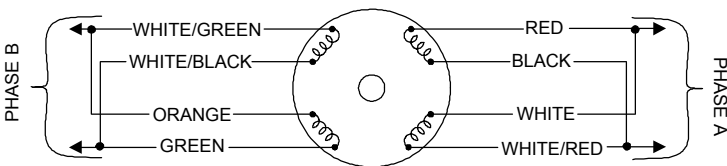

**8-LEAD MOTORS, PARALLEL CONNECTIONS**

Motor Connections

**4.3 CONTROL INTERFACE**

All connections are made via 8 pins or terminal strip, Danaher Motion part number B215744-008.

## 5 SPECIFICATIONS

- Bipolar, 2-phase stepping motor drive with translator.
- Power semiconductor type: H-bridge power IC
- Translator: internal IC
- Control signals optically isolated from the motor drive module (except for Reduce Current)

### 5.1 PERFORMANCE SPECIFICATIONS

Resolution	Half –step or full-step
Step Rate	0 to 10,000 full-steps/sec. 0 to 10,000 half-steps/sec.
Chopping Freq.	20 kHz nominal
Speed/torque	All specifications use typical data

#### 5.1.1. MOTOR FAMILIES

##### 5.1.1.1. MOTORS FOR USE WITH 230-T(H)

###### WITH CONNECTORS

M061-CS08	M063-CS06
M061-CE08	M063-CS09
M062-CS09	M063-CE09
M062-CE09	

###### WITH LEADS

M061-LS08	M063-LE09	M092-FD09
M061-LE08	M091-FC09	M092-FD310
M062-LS09	M091-FD09	M092-FD8009
M062-LE09	M091-FD8009	M092-FD8109
M063-LS06	M091-FD8109	M092-FD8814
M063-LS09	M092-FC09	

## 5.1.1.2. MOTORS FOR USE WITH 430-T(H)

### WITH CONNECTORS

M061-CS08	M063-CS06
M061-CE08	M063-CE06
M062-CS09	M063-CS09
M062-CE09	M063-CE09

### WITH LEADS

M061-LS08	M091-FD06	M093-FD8011
M061-LE08	M091-FD8106	M093-FD8014
M062-LS09	M092-FC09	M111-FD12
M062-LE09	M092-FD09	M111-FD16
M063-LS06	M092-FD310	M111-FD8012
M063-LE06	M092-FD8009	M112-FD327
M063-LS09	M092-FD8109	M112-FD8012
M063-LE09	M093-FC14	M112-FJ8012
M091-FC06	M093-FD14	M112-FJ8030

Power Supply required (See *Input Power Supply*)

Drive power dissipation (worst case)

230-T(H)	25 watts
430-T(H)	40 watts

## 5.2 MOTOR COMPATIBILITY

	230-T(H)	430-T(H)
Frame Sizes	M061 to M092	M061 to M112
No. of leads		4, 6, 8
Min. inductance		0.55 mH
Max. resistance	3.5 ? including drive to motor cable	



***Do not use larger frame size motor than those listed, or the drive may be damaged.***

### 5.3 MECHANICAL SPECIFICATIONS

	<b>230-T(H)</b>	<b>430-T(H)</b>
Type	Potted module Aluminum case	Potted module Aluminum case
"H" unit supplied with Al. heat sink (see <i>Mounting Diagram – Heat Sink</i> )		
Size (inches)	3.15" (80 mm) L 2.70" (68.6 mm) W 1.31" (33.3 mm) H (add approx. 0.500" (12.7 mm) to height for pins)	4.05" (103 mm) L 2.70 (68.6 mm) W 1.31" (33.3 mm) H
Weight (lbs.)	1 (0.45 kg) (add approx. 0.5 lb (0.23 kg) for "H" unit)	1.5 (0.7 kg)

### 5.4 ELECTRICAL SPECIFICATIONS

#### 5.4.1. INPUT POWER SUPPLY

	<b>230-T(H)</b>	<b>430-T(H)</b>
Supply Voltages:	28 VDC, nominal; 24 min. to 36 max. including ripple	28 VDC, nominal; 24 min. to 36 max. including ripple
Supply Current:	2.5 A	4.0 A



***Operation from a 28 – 30 VDC supply gives the best overall performance, considering tradeoffs of motor and drive heating, power supply current and torque vs. speed.***

#### 5.4.1.1. Connections

Method:	Pins or terminal block (Part #B215744-007)
Assignment:	$V_M = +$ $V_{OM} = \text{Common}$ $V_{OM}$ and $V_O$ are internally connected to the module's aluminum case
Cable size:	14 gauge max., when using a terminal block.

*Danaher Motion cables are recommended; see Motor Connections for part numbers.*

### 5.4.1.2. Filter Capacitor Requirements



***DO NOT OPERATE THIS UNIT WITHOUT EXTERNAL FILTER CAPACITOR!!!!***

**Minimum of 250  $\mu$ f. 50 VDC needed across  $V_M - V_{OM}$  at drive terminals, or within 6 inches (150 mm) of them.**

Total filter capacitance on the motor power supply must be greater than or equal to 4700  $\mu$ f; a 50 V (or higher) working voltage, and a 3.3 A ripple current rating are required. If the power supply does not contain sufficient filtering, then additional filtering must be added between the  $V_M$  and the  $V_{OM}$  terminals. For example, Sprague 53D472G063JP6 capacitor is a suitable 4700  $\mu$ f, 63 V capacitor.

### 5.4.2. OUTPUT TO MOTOR

	<b>230-T(H)</b>	<b>430 – T(H)</b>
<b>Output Voltage to motor</b>	24-36 V nominal; depending on power supply voltage.	
	36 V max.	36 V max.
<b>Motor Current per phase</b>	2 A peak	3.5 A peak
	1 A peak in reduced current mode	1.5 A peak in reduced current mode
<b>Motor VA per phase</b>	56 VA nominal (at 28 VDC, 2 A)	98 VA nominal (at 28 VDC, 2 A)

#### 5.4.2.1. Connections

<b>Terminals: At drive</b>	Phase A and Phase B pairs
<b>Max. / min. cable length</b>	Total maximum resistance of motor and cable 3.5 $\Omega$
<b>Cable size, type</b>	14 gauge maximum when using terminal block part # B215744-007
<b>Special requirements</b>	Twist motor phase pairs: 6 twists / ft. to minimize radiated EMI / RFI and help provide maximum motor performance

## 5.5 CONTROL INTERFACE REQUIREMENTS

All connections via 8 pins or terminal block part # B215744-008

Min. pulse width low:	15 microseconds
Min. pulse width high:	50 microseconds
Rise and fall time:	less than 2 microseconds

## 5.6 OPTO-ISOLATION

Power required for opto-isolators: 4.5 – 7 VDC, 14 mA minimum. 20 mA maximum per input.

To use internal opto-isolator power supply: connect OPTO OUT and OPTO IN pins together.

Logic “sinking” is required to activate optically-isolated signals (see 6.7 *Opto Supply Out* and 6.8 *Opto Supply In*)

## 5.7 ENVIRONMENTAL REQUIREMENTS

<b>Storage Temp.</b>	-40° F to +185° F (-40° C to +85° C)
<b>Operating Temp.(case)</b>	+32° F to + 167° F (0° C to +75° C)
<b>Humidity</b>	95% max. non-condensing
<b>Altitude</b>	10,000 feet (3048 meters) max.
<b>Heat sinking</b>	Maintain case temperature below 167° F (75° C)

No heat sink needed for Reduced Current operation at 77° F (25° C) ambient temperatures (1 A for 230-T; 1.5 A for 430-T).

Use heat sink part #C215737-001-DB for operation at higher currents or higher ambient temperatures.

## 5.8 FUNCTIONAL DESCRIPTION

In general, the 230-T(H) and 430-T(H) electronically convert pulses into drive signals of the power sequence and power required to operate a step motor; one input pulse being “translated” into one motor step.

To drive the motor, a technique called “chopping” is used. Compared to older drive techniques, chopping gives improved motor performance while allowing the drive circuitry to dissipate less power. The voltage applied to the motor windings is turned on and off very rapidly, or **chopped**. The voltage level and chopping frequency are precisely controlled so that the desired current is produced.

The instantaneous current in the drive circuit is sensed and is used to control the current to the motor.

The translator circuitry accepts a single pulse at a time as an input and determines which windings (phases) of the motor must be turned on and off in order to advance the motor shaft one step. The translator circuit is fully self-contained and is not accessible through any of the function pins.

## **5.9 SIGNAL DESCRIPTION**

The 230-T(H) and 430-T(H) are configured for operation by the means of the pin assignments. How these functions are treated by the motor drive module is explained in *PIN CONFIGURATION AND OPERATIONS*.

Input pulses, one for each desired motor step, are received by the translator circuit on the PULSE IN (PU) pin.

The CW / CCW pin controls which direction the motor moves and the HALF / FULL pin determines whether a half or full step is taken.

Even when the motor is stationary, current is flowing through one or two of the windings. The magnetic field produced by this current holds the shaft firmly with a force specified as the “holding torque”. The input control signal, ALL WINDINGS OF (AWO), turns off all current to the motor, thus allowing the shaft to be turned manually.

## 6 PIN CONFIGURATION AND OPERATIONS



*The following discussion assumes the internal opto power supply is being used when describing signal functions.*

### 6.1 PU (PULSE IN)

A low to high (positive going edge) transition on this pin causes the motor to take one step. Maximum frequency is 15 kHz.

### 6.2 CW / CCW (DIRECTION)

A logical high or an open connection causes the motor shaft to step in the clockwise direction as viewed from the *label* end of the motor. A logical low, or connection to LOGIC COMMON results in counterclockwise rotation.

### 6.3 H/F (HALF / FULL)

A logical low or connection to LOGIC COMMON, causes the motor to step the full step angle indicated in its specifications. A logic high (open) causes the motor to take a “half-step” equal to half of its specified step angle. When operated in half-step mode the motor provides smoother operation with finer resolution but an approximately 30% less torque.



*If the H/F input is switched low with the  $V_M$  power on, it is possible to get a full step, one winding on (“wave mode”) condition that results in reduced motor torque. To avoid this, power to the unit must be turned off (remove  $V_M$ ) whenever this input is switched low.*

### 6.4 AWO (ALL WINDINGS OFF)

A logical low or connection to LOGIC COMMON turns off all power to the motor windings.



*Holding torque is eliminated when this signal is active. Insure that the motor load, when released by this command, will not injure property or personnel.*

## 6.5 REDUCED CURRENT

There are two ways to use this pin:

1. Connect it directly to LOGIC COMMON (Pin #3). This reduces motor current to 1.0 A for the 230-T(H) and to 1.5 for the 430-T(H).
2. Connect it through a resistor (see Table below) to LOGIC COMMON (Pin #3) for the other values of reduced current.

For the 230-T(H), typical values for resistors and the associated current are:

CURRENT (amps)	RESISTOR (ohms)
1.00	0 (jumper)
1.25	2.49 k $\Omega$ , 1/4 watt, 1%
1.50	7.50 k $\Omega$ , 1/4 watt, 1%
1.75	23.7 k $\Omega$ , 1/4 watt, 1%
2.00	open

For the 430-T(H), typical values for resistors and the associated current are:

CURRENT (amps)	RESISTOR (ohms)
1.5	0 (jumper)
2.0	1.78 k $\Omega$ , 1/4 watt, 1%
2.5	5.62 k $\Omega$ , 1/4 watt, 1%
3.0	16.2 k $\Omega$ , 1/4 watt, 1%
3.5	open

## 6.6 LOGIC COMMON

Reference points for inputs and outputs, connected internally to  $V_{OM}$  and to the module's aluminum case.

## 6.7 OPTO SUPPLY OUT

Supplies proper voltage for opto inputs from an internal source. By connecting OPTO SUPPLY OUT to OPTO SUPPLY IN, the user can use 230-T(H) and 430-T(H) internal power supply. This allows logic functions to be activated by "sinking" (pulling them low i.e. connecting them to LOGIC COMMON via an external switch or logic gate).

In this case, the user's circuitry is not isolated from the translator.

## 6.8 OPTO SUPPLY IN

Connection for opto-isolator power supply.

May be connected as described in Section 6.7, or user may provide a separate source for opto-isolators and “sink” to activate, as shown in *OPTO CONNECTIONS (EXTERNAL SUPPLY)* and *OPTO CONNECTIONS (INTERNAL SUPPLY)*. This method may provide the best noise immunity since the user’s circuitry is optically isolated from the translator.

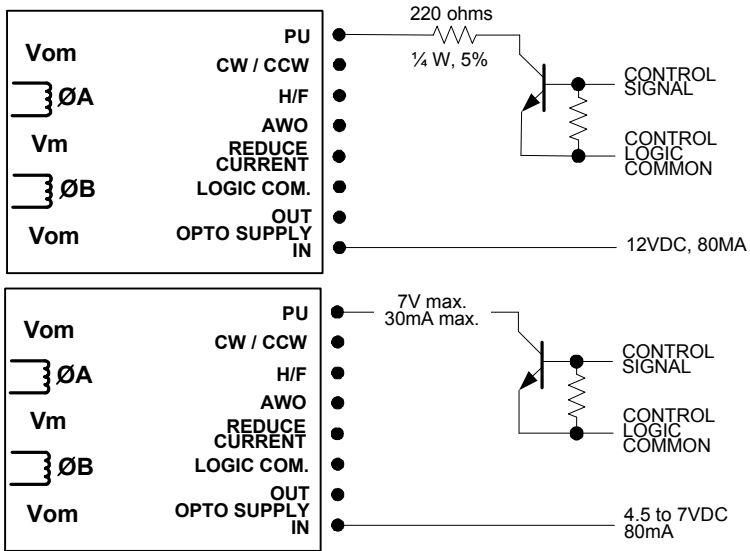

TWO SUGGESTED METHODS USING EXTERNAL POWER SUPPLY

### OPTO CONNECTIONS (EXTERNAL SUPPLY)

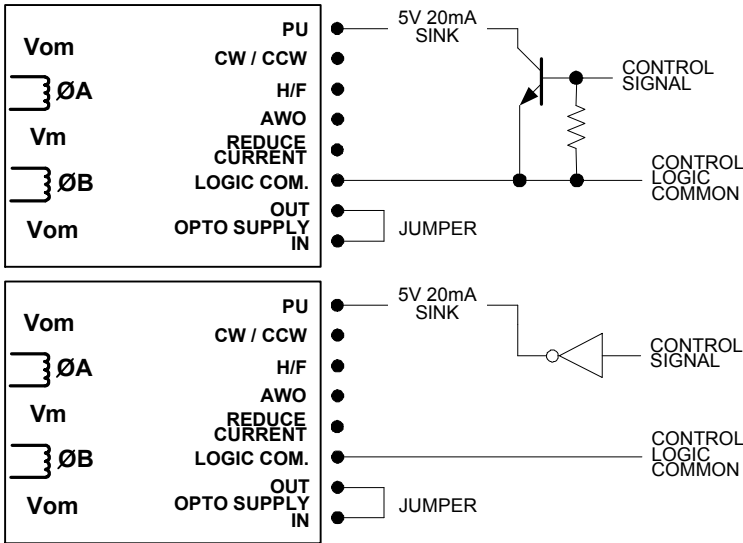

TWO SUGGESTED METHODS USING INTERNAL POWER SUPPLY OPTO CONNECTIONS (INTERNAL SUPPLY)

### 6.9 $V_M$

Motor power supply input.

### 6.10 $V_{OM}$

Common for motor supply; connected internally to  $V_O$  and to the module's aluminum case.

### 6.11 MOTOR PHASE A ( $\emptyset A$ )

Connect the pair of wires for one motor phase here. For example, M1, M3 on Danaher Motion motors.

### 6.12 MOTOR PHASE B ( $\emptyset B$ )

Connect the pair of wires for the other motor phase here. For example, M4, M5 on Danaher Motion motors.

# 7 SPEED / TORQUE CURVES

## 7.1 230 SERIES MOTION CONTROLS

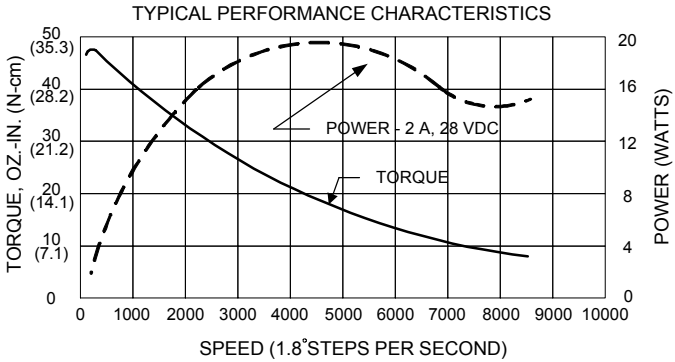

**SERIES CONNECTION**  
**M061-CS08 AND M061-LS08 MOTORS**

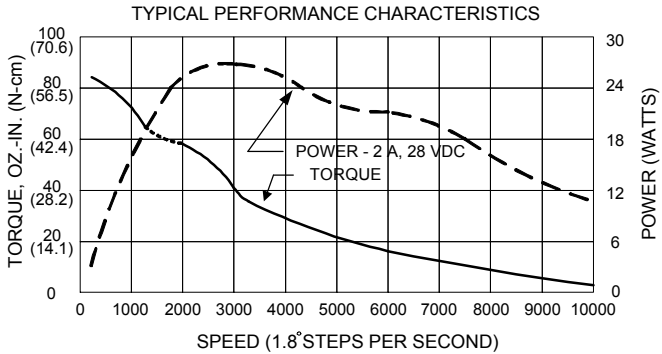

**SERIES CONNECTION**  
**M062-CS09 AND M062-LS09 MOTORS**

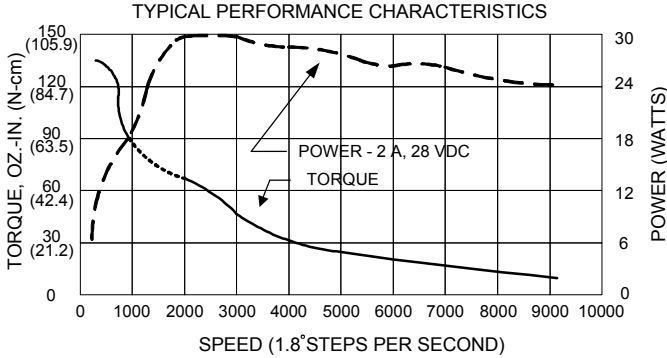

**SERIES CONNECTION  
M063-CS09 AND M063-LS09 MOTORS**

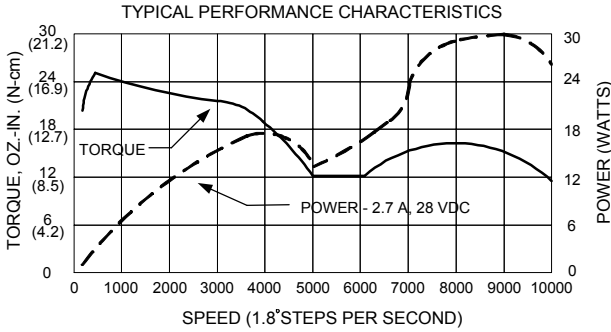

**PARALLEL CONNECTION  
M061-CE08 AND M061-LE08 MOTORS**

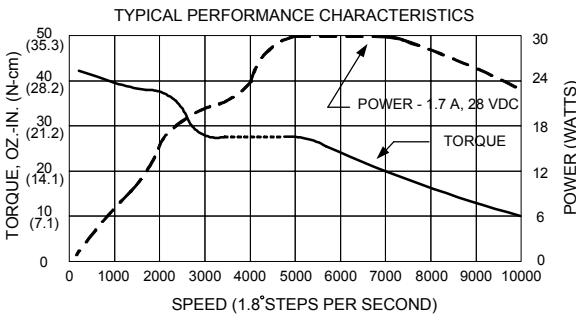

**SERIES CONNECTION  
M061-CS08 AND M061-LS08 MOTORS**

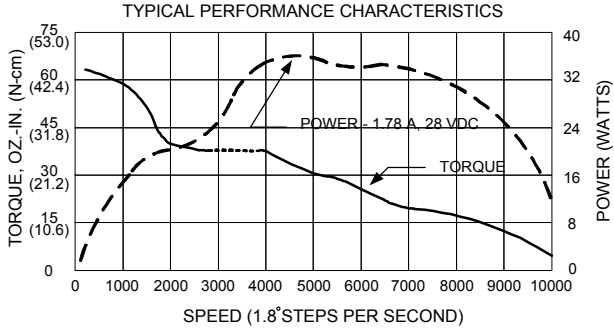

**PARALLEL CONNECTION  
M063-CE09 AND M063-LE09 MOTORS**

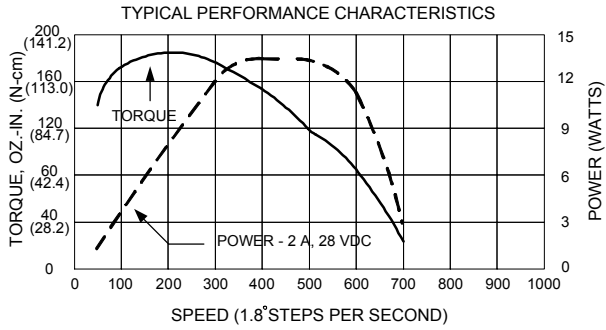

**SERIES CONNECTION  
M063-CS06 AND M063-LS06 MOTORS**

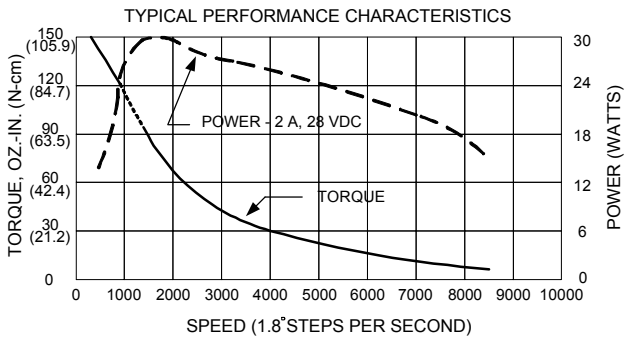

**SERIES CONNECTION  
M091-FC09 AND M091-FD09 MOTORS**

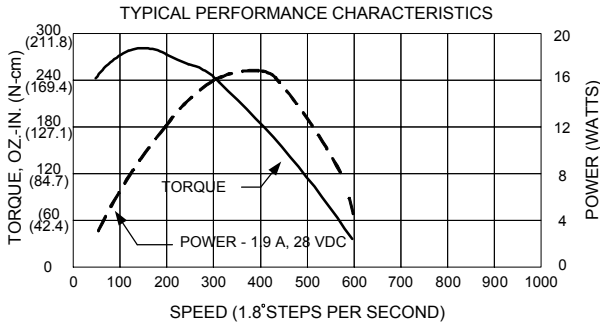

**SERIES CONNECTION  
 M092-FC09 AND M092-FD09 MOTORS**

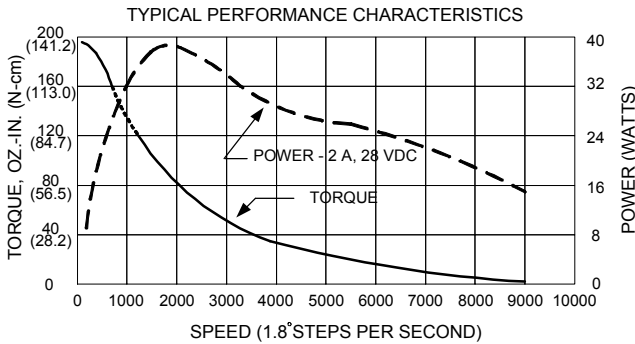

**SERIES CONNECTION  
 M092-FD310 MOTOR**

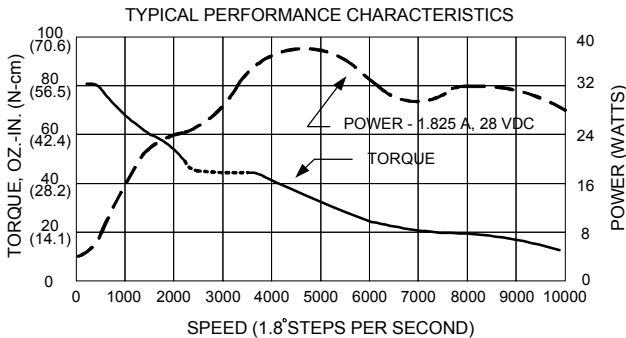

**PARALLEL CONNECTION  
 M091-FD8009 AND M091-FD8109 MOTORS**

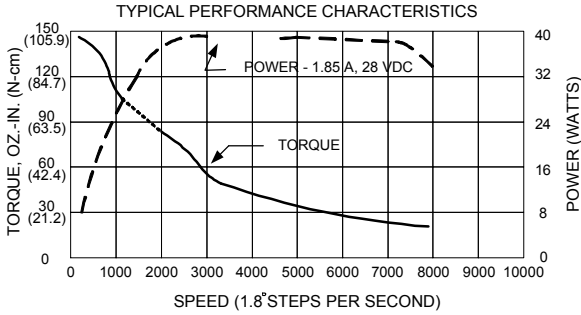

**SERIES CONNECTION**  
**M092-FD8109 AND M092-FD8009 MOTORS**

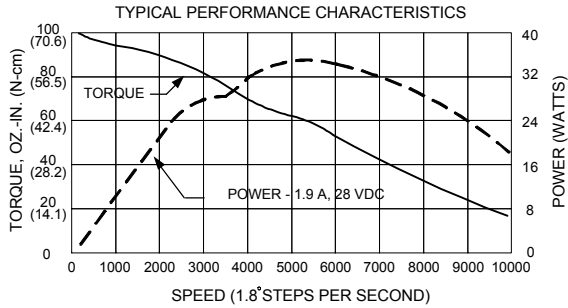

**PARALLEL CONNECTION**  
**M092-FD8814 MOTOR**

## 7.2 430 SERIES MOTION CONTROLS

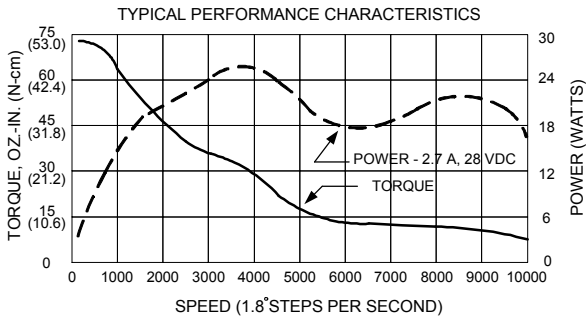

**SERIES CONNECTION**  
**M061-CS08 AND M061-LS08 MOTORS**

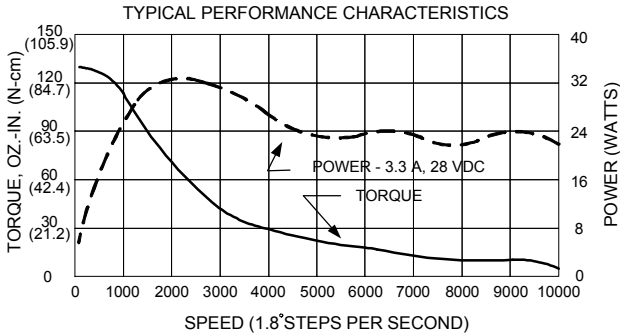

**SERIES CONNECTION  
 M062-CS09 AND M062-LS09 MOTORS**

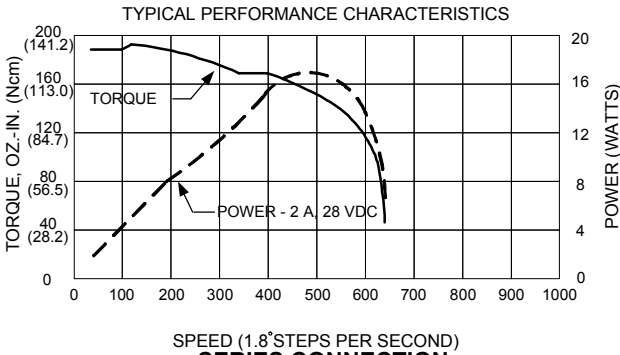

**SERIES CONNECTION  
 M063-CS06 AND M063-LS06 MOTORS**

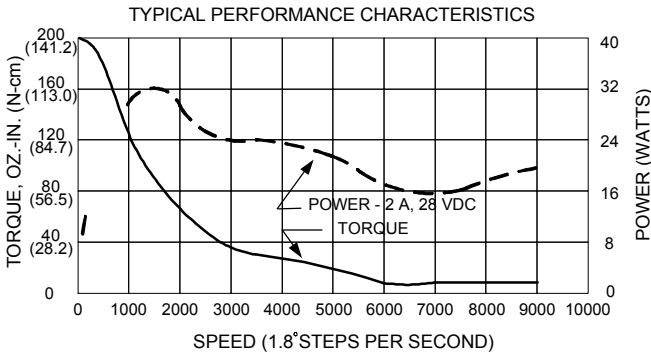

**SERIES CONNECTION  
 M063-CS09 AND M063-LS09 MOTORS**

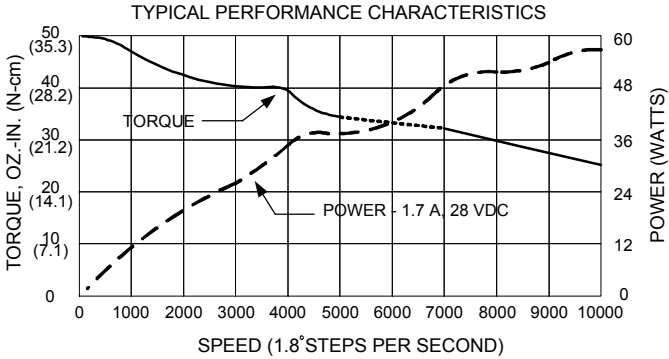

**SERIES CONNECTION  
M061-CE08 AND M061-LE08 MOTORS**

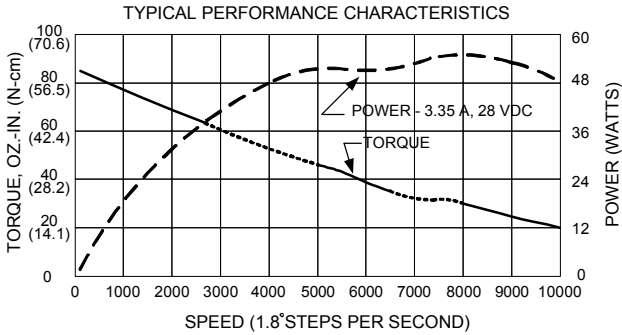

**PARALLEL CONNECTION  
M062-CE09 AND M062-LE09 MOTORS**

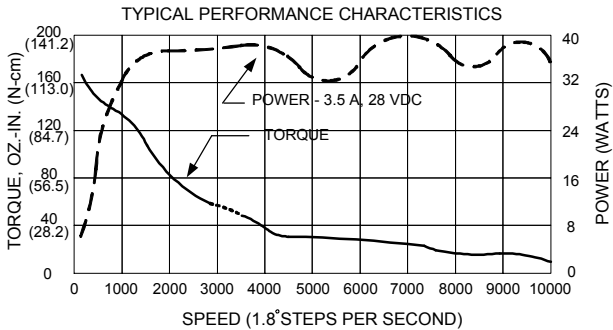

**SERIES CONNECTION  
M063-CE06 AND M063-LE06 MOTORS**

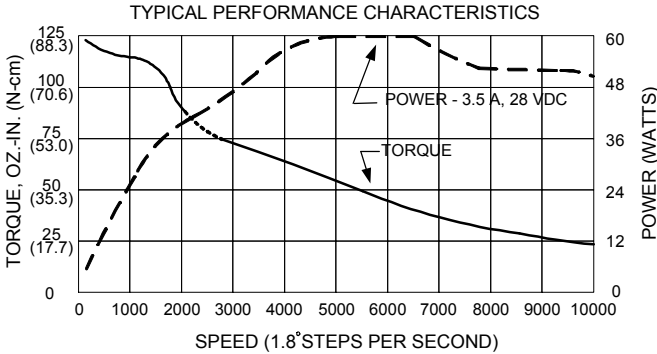

**PARALLEL CONNECTION  
M063-CE09 AND M063-LE09 MOTORS**

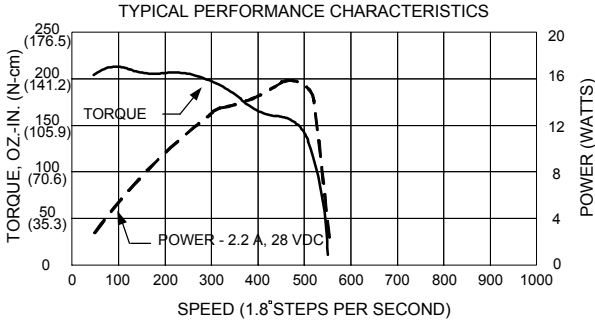

**SERIES CONNECTION  
M091-FC06 AND M091-FD06 MOTORS**

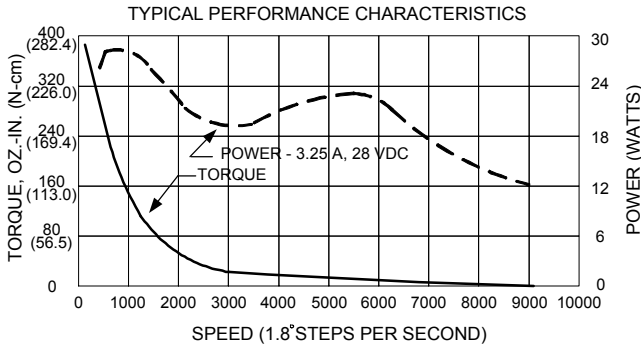

**SERIES CONNECTION  
M092-FC09 AND M092-FD09 MOTORS**

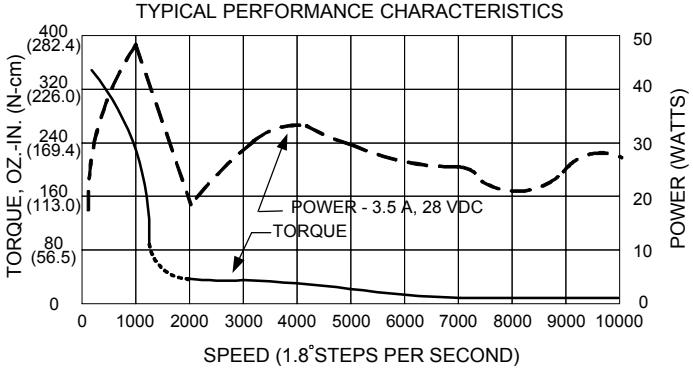

**SERIES CONNECTION  
M092-FD310 MOTOR**

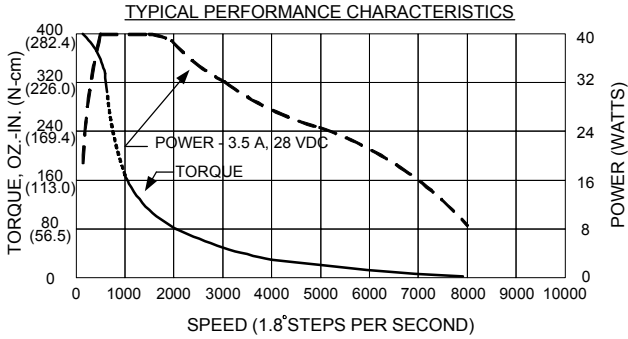

**SERIES CONNECTION  
M093 - FC14 AND M093 - FD14 MOTORS**

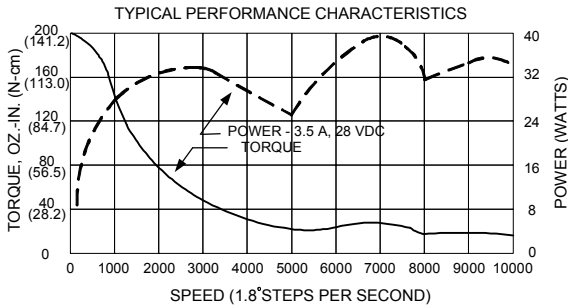

**PARALLEL CONNECTION  
M091-FD8106 MOTOR**

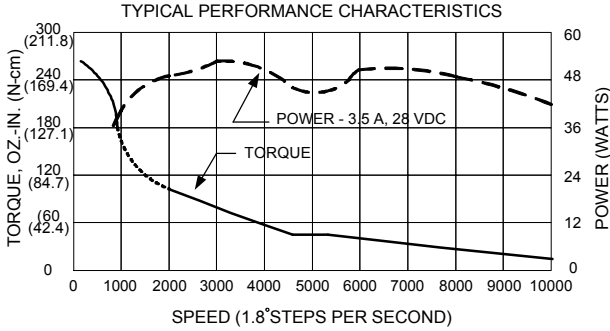

**PARALLEL CONNECTION  
M092-FD8109 AND M092-FD8009 MOTORS**

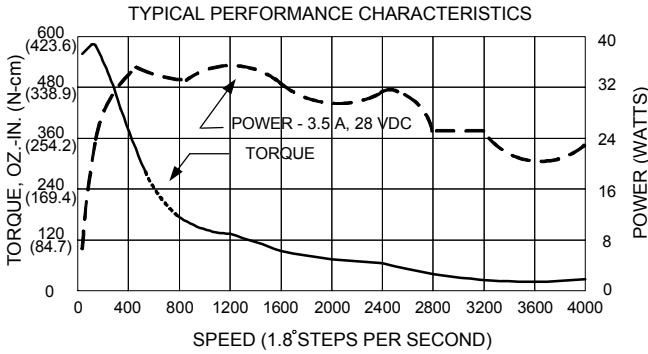

**SERIES CONNECTION  
M093-FD8011 MOTOR**

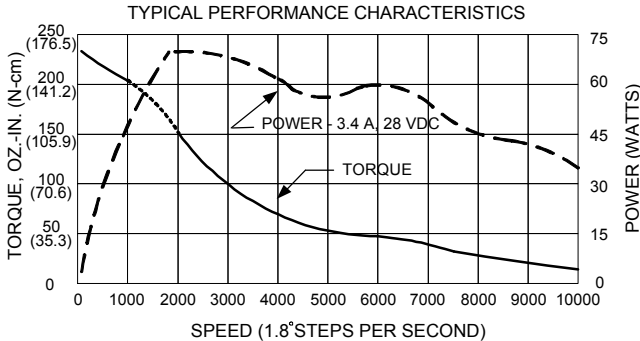

**PARALLEL CONNECTION  
M093-FD8014 MOTOR**

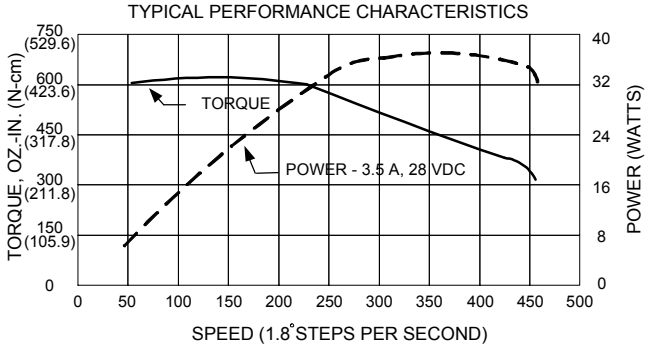

**SERIES CONNECTION  
M111-FD12 MOTOR**

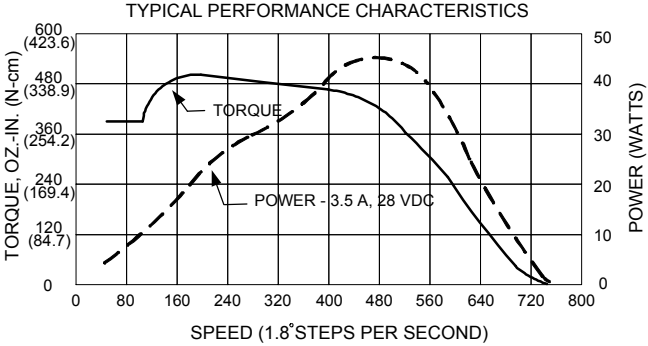

**SERIES CONNECTION  
M111-FD16 MOTOR**

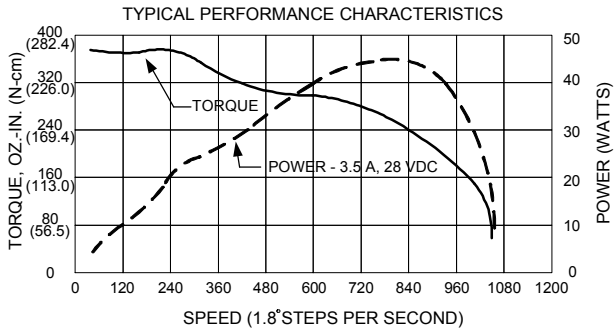

**PARALLEL CONNECTION  
M111-FD8012 MOTOR**

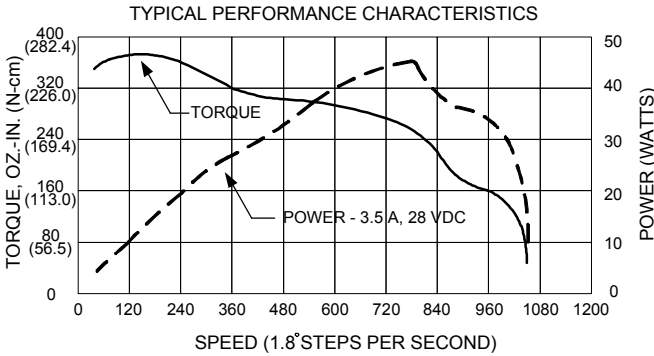

**PARALLEL CONNECTION  
MD112-FD8012 AND M112-FJ8012 MOTORS**

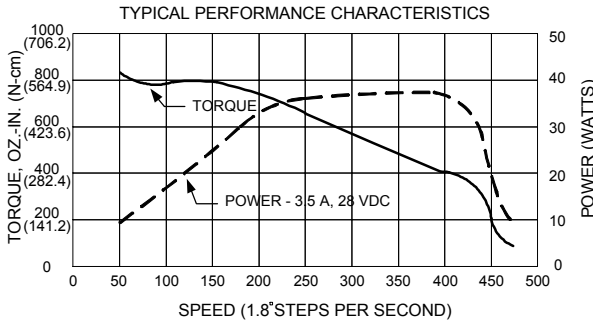

**SERIES CONNECTION  
M112-FJ327 MOTOR**

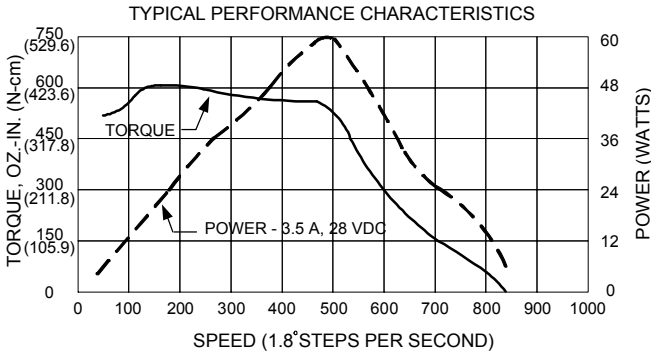

**SERIES CONNECTION  
M112-FJ8030 MOTOR**

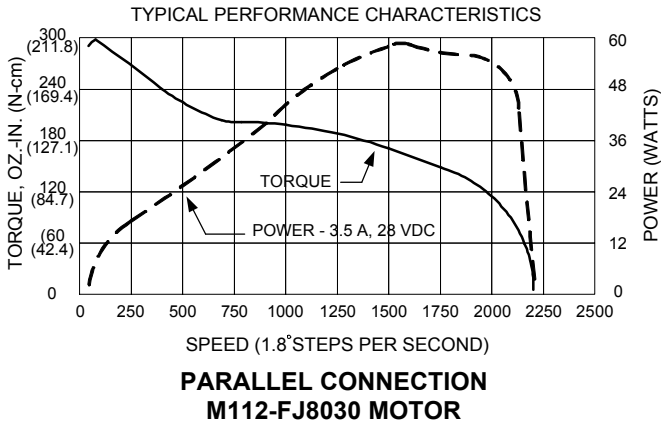

## 7.3 MOTOR PERFORMANCE

All stepping motors exhibit instability at their natural frequency and harmonics of that frequency. Typically, this instability will occur at speeds between 50 and 500 full steps per second and, depending on the dynamic motor load parameters, can cause excessive velocity modulation or improper positioning.

There are also other instabilities which may cause a loss of torque at stepping rates outside the range of natural resonance frequencies. One such instability is broadly identified as mid-range instability. This is identified by the dotted area(...) on the speed torque curves.

Usually, the dampening of the system and acceleration / deceleration through the resonance areas aids in reducing instability to a level that provides smooth shaft velocity and accurate positioning. If instability does cause unacceptable performance under actual operating conditions, the following techniques can be used to reduce velocity modulation.

1. Avoid constant speed operation at the motor's unstable frequencies. Select a base speed that is above the motor's resonant frequencies and adjust acceleration and deceleration to move the motor through unstable regions quickly.
2. The motor winding current can be reduced. Lowering the current will reduce torque proportionally. The reduced energy delivered to the motor can decrease velocity modulation.

## **7.4 DANAHER MOTION SUPPORT**

Danaher Motion products are available world-wide through an extensive authorized distributor network. These distributors offer literature, technical assistance and a wide range of models off the shelf for fastest possible delivery.

Danaher Motion sales engineers are conveniently located to provide prompt attention to customers' needs. Call the nearest office listed for ordering and application information or for the address of the closest authorized distributor.

Danaher Motion Customer Support

**Phone:** (815) 226-2222

**Email:** [customer.support@DanaherMotion.com](mailto:customer.support@DanaherMotion.com)

**Web:** [www.DanaherMotion.com](http://www.DanaherMotion.com)